



*Please Check for  
CHANGE INFORMATION  
at the Rear of this Manual*

**PLOT 10**  
4010A01, A10, A11, A12  
**TERMINAL CONTROL  
SYSTEM**  
USER'S MANUAL

Tektronix, Inc.  
P.O. Box 500  
Beaverton, Oregon 97077

MANUAL PART NO.  
070-2241-00

First Printing FEB 1977  
Revised NOV 1981

## **SUPPORT POLICY**

This software product is designated Support Category B, as shown on the applicable software data sheet existing at the time of order. Tektronix' sole obligation shall be to correct defects (non-conformance of the software to the data sheet) as described below, without additional charge.\*

During the one (1) year period following delivery, if the customer encounters a problem with the software which his diagnosis indicates is caused by a software defect, the customer may submit a Software Performance Report (SPR) to Tektronix. Tektronix will respond to problems reported in SPRs which are caused by defects in the current unaltered release of the software via the Maintenance Periodical for the software, which reports code corrections, temporary corrections, generally useful emergency by-pass and/or notice of the availability of corrected code. Software updates, if any, released by Tektronix during the one (1) year period, will be provided to the customer on Tektronix' standard distribution media as specified in the applicable data sheet. The customer will be charged only for the media on which such updates are provided, unless otherwise stated in the applicable data sheet, at Tektronix' then current media prices.

\*In addition to the locations within the contiguous forty-eight (48) United States and the District of Columbia, this service is available in those areas where Tektronix has software support capability.

Copyright © 1977 Tektronix, Inc. All rights reserved.

All software products including this document, all associated tape cartridges and the programs they contain are the sole property of Tektronix, Inc., and may not be used outside the buyer's organization. The software products may not be copied or reproduced in any form without the express written permission of Tektronix, Inc. All copies and reproductions shall be the property of Tektronix and must bear this copyright notice and ownership statement in its entirety.

TEKTRONIX is a registered trademark of Tektronix, Inc.

## TABLE OF CONTENTS

1.	Introduction . . . . .	1-1
	1.1 Release 3.0 and Earlier Releases . . . . .	1-1
	1.2 The TEKTRONIX Terminals . . . . .	1-2
	1.3 A Terminal Control System Overview . . . . .	1-2
2.	Introductory Drawing . . . . .	2-1
	2.1 Initialization: Subroutine INITT . . . . .	2-1
	2.2 Termination: Subroutine FINITT . . . . .	2-2
	2.3 Absolute Line Drawing in Screen Coordinates . . . . .	2-2
	2.4 Subroutine MOVABS . . . . .	2-2
	2.5 Subroutine DRWABS . . . . .	2-3
	2.6 Subroutine PNTABS . . . . .	2-4
	2.7 Relative Line Drawing in Screen Coordinates . . . . .	2-4
3.	Virtual and Screen Graphics . . . . .	3-1
	3.1 The Virtual Window . . . . .	3-1
	3.2 A Viewable Area in User Units . . . . .	3-2
	3.3 Defining the Virtual Window: Subroutine VWINDO . . . . .	3-4
	3.4 Subroutine DWINDO . . . . .	3-4
	3.5 Line Drawing in User (Virtual) Units: Absolute Line Drawing . . . . .	3-5
	3.6 Relative Virtual Coordinate Subroutines . . . . .	3-7
	3.7 The Screen Window . . . . .	3-8
	3.7.1 Subroutine SWINDO . . . . .	3-8
	3.7.2 Subroutine TWINDO . . . . .	3-8
	3.8 Scaling and Stretching the Screen Windo . . . . .	3-8
	3.9 Clipping in Virtual Space . . . . .	3-10
	3.10 Interchangeability of Virtual and Screen Graphics. . . . .	3-11
	3.11 Dashed Line Drawing . . . . .	3-13
	3.12 Dashed Line Specification . . . . .	3-13
4.	Utility Routines . . . . .	4-1
	4.1 Alphanumeric Output . . . . .	4-1
	4.2 Entering A/N Mode: Subroutine ANMODE . . . . .	4-1
	4.3 A/N Character Output: Subroutine ANCHO . . . . .	4-1
	4.3.1 A/N String Output: Subroutine ANSTR . . . . .	4-2
	4.4 A/N Character Handling . . . . .	4-2
	4.5 Using the Screen Cursor: Subroutine SCURSR . . . . .	4-3
	4.5.1 Subroutine DCURSR . . . . .	4-3

4.6	Using the Virtual Cursor: Subroutine VCURSR . . .	4-5
4.7	Terminal Status Area . . . . .	4-7
	4.7.1 Subroutine SVSTAT . . . . .	4-7
	4.7.2 Subroutine RESTAT . . . . .	4-7
4.8	Rescaling a Graphic Output: Subroutine RSCALE .	4-9
4.9	Rotating a Graphic Output: Subroutine RROTAT . .	4-9
4.10	Subroutine RESET . . . . .	4-11
4.11	Subroutine RECOVR . . . . .	4-11
4.12	Miscellaneous Utility Routines . . . . .	4-11
4.13	Conversion of Inches to Screen Units: Function KIN . . . . .	4-13
4.14	Conversion of Centimeters to Screen Units: Function of KCM . . . . .	4-13
4.15	Measuring the Width of Characters: Function LINWDT . . . . .	4-14
4.16	Measuring the Height of Lines: Function LINHGT .	4-14
4.17	Tabs and Margins . . . . .	4-15
	4.17.1 Setting the Tab Table: Subroutine TTBSZ . . . . .	4-15
	4.17.2 Tab Setting: Subroutine SETTAB . . . . .	4-15
	4.17.3 Removing a Tab: Subroutine RSTTAB . . . .	4-16
	4.17.4 The Horizontal Tab: Subroutine TABHOR . .	4-16
	4.17.5 The Vertical Tab: Subroutine TABVER . . .	4-17
	4.17.6 Setting the Margins: Subroutine SETMRG . . . . .	4-19
4.18	Level Checking: Subroutine TCSLEV . . . . .	4-19
5.	Routines Which Support the 4014 or 4015 Terminal . . . .	5-1
	5.1 Identifying the 4014/15 Terminal: Subroutine TERM . . . . .	5-1
	5.2 Modifying the Z-axis of the 4014/15 Terminal: Subroutine CZAXIS . . . . .	5-2
	5.3 Changing the Character Size on the 4014/15 Term- inal: Subroutine CHRISZ . . . . .	5-3
	5.4 Measuring the Size of a Character: Subroutine CSIZE . . . . .	5-3
	5.5 Incremental Plotting: Subroutine INCPLT . . . .	5-6
	5.6 Check Terminal Modes: Subroutine SEEMOD . . . .	5-7
	5.7 Check Terminal: Subroutine SEETRM . . . . .	5-7
6.	Transformations . . . . .	6-1
	6.1 The Linear Transformation . . . . .	6-4
	6.2 The Logarithmic Transformation Subroutine LOGTRN . . . . .	6-4
	6.3 The Polar Transformation . . . . .	6-4
	6.4 Drawing Segments Using the Polar Transformation: Subroutine DRAWSA: Subroutine DRAWSR . . . . .	6-5

6.5	Drawing Dashed Line Segments Using Polar Transformation: Subroutine DASHSA; Subroutine DASHSR . . . . .	6-6
6.6	Using the Polar Transformation . . . . .	6-7
7.	Input/Output Routines . . . . .	7-1
7.1	Output: Subroutine TOUTST . . . . .	7-2
7.2	Subroutine TOUTPT . . . . .	7-2
7.3	Subroutine ANCHO . . . . .	7-2
7.4	Subroutine ANSTR . . . . .	7-3
7.5	Subroutine ALOUT . . . . .	7-3
7.6	Subroutine AOUTST . . . . .	7-3
7.7	Input: Subroutine TINSTR . . . . .	7-4
7.8	Subroutine TINPUT . . . . .	7-4
7.9	Subroutine AIN . . . . .	7-5
7.10	Subroutine AINST . . . . .	7-5
7.11	Utility I/O Routines . . . . .	7-6
	7.11.1 Setting the Output Buffer Format: Subroutine SETBUF . . . . .	7-6
	7.11.2 Examine the Output Format: Subroutine SEEBUF . . . . .	7-10
	7.11.3 Examining the Useable Space in the Output or Input Buffer Function: LEFTIO . . . . .	7-10
	7.11.4 Locating the Position of the Graphic Beam: Subroutine SEELOC . . . . .	7-11
7.12	Dumping the Output Buffer: Subroutine TSEND . . . . .	7-11
APPENDIX A	I. An Advanced Use of the Terminal Control System: Circuit Drawing . . . . .	A-2
	II. Terminal Control System Common Variables . . . . .	A-6
	II. GLOSSARY . . . . .	A-8
APPENDIX B	OPTION 22 Users' Instructions . . . . .	B-1
INDEX	I. Subroutine and Function Index	
	II. Subject Index	

ASCII CODE CHARTS



## 1. INTRODUCTION

The LEVEL 1 version of the 4010A01 PLOT 10 Terminal Control System is the equivalent of Release 3.3 of the previous PLOT 10 Software with minor updates.

In order to allow the user to deal with many computer environments both for timesharing and minicomputers, TEKTRONIX has developed the Terminal Control System software package. The package is a comprehensive set of subroutines which allows terminal-independent graphic programming; the user needs only to select the proper subroutines at load time. The design is basically system and computer independent and enables the experienced programmer to work at the terminal level and also provides the facilities for the occasional user to operate easily at the conceptual level. The Terminal Control System consists of those subroutines which support the TEKTRONIX 4006-1, 4010, 4012/13\* and 4014/15\* Computer Display Terminals.

Those who wish to enhance PLOT 10 Terminal Control System with 4662A01 PLOT 10 Utility Routine may then route output of TCS to the TEKTRONIX 4662 Inter-active Digital Plotter.

### RELEASE 3 AND EARLIER RELEASES

1.1 THIS MANUAL IS DESIGNED FOR ALL USERS OF RELEASES 3.0 THROUGH 3.3 AND LEVEL 1 OF THE TERMINAL CONTROL SYSTEM. ANY USER WHO OBTAINS THE PACKAGE AFTER THE DATE OF THIS MANUAL CAN PRESUME THAT HE HAS LEVEL 1.

---

\* The notation 4014/15 refers to either the 4014 or the 4015 terminals, the notation 4012/13 refers to either the 4012 or the 4013 terminal. The 4015 and 4013 terminals are in all ways the same as their counterparts, but offer in addition an APL character set.

*THE TEKTRONIX  
TERMINALS*

1.2 The 4006, 4010, 4012/13, and 4014/15 Computer Display Terminals are capable of displaying both alphanumeric characters and graphic data. Once written, the display remains visible until it is erased, and it is not necessary to continually refresh the information put up on the screen. The 4012 is an upper and lower case ASCII Terminal. The 4013 is an APL Terminal which also has the ASCII character set of the 4012. The 4014 and 4015 Terminals offer upper and lower case ASCII, with the 4015 also having APL capabilities.

The 4014/15\* Terminals offer in addition a write-through capability, in which both stored and refreshed information may be displayed. The 4014/15 Terminals have a display area of 14.5 inches by 10.9 inches, and the user has the option of four character sizes. The 4014/15 Terminals with Enhanced Graphics Module\*\* offer hardware dashed lines and point plotting as well as incremental point plotting. The user may also address a grid of 1024 by 1024 points or a grid of 4096 by 4096 points.

*A TERMINAL CONTROL  
SYSTEM OVERVIEW*

1.3 The ideal that the Terminal Control System strives for is to make the Terminal as easy to use as a pencil and a piece of paper. The detailed programming and general I/O handling are contained within the system; as a result the basic Terminal capabilities are made available to the user in a natural and practical manner.

The Terminal Control System subroutines communicate with each other primarily through the Terminal Status Area, a set of common variables which continuously represent the current state of the Terminal and maintain the data and flags necessary to generate output according to the user's level of need. Terminal status cannot accurately be kept when output to the Terminal is generated by other means than through the appropriate Terminal Control System routine or whenever the user changes status locally (e.g., uses the PAGE or RESET key).

The package gives many graphing conveniences to the user. Bright and dark vectors (line segments) as well as points may be displayed on the Terminal screen. A bright vector which can be seen on the screen, is caused by one of the

---

\* The notation 4014/15 refers to the 4014 or the 4015 Terminal. The notation 4012/13 refers to either the 4012 or the 4013 Terminal.

\*\* The Terminal Control System does not support special point plotting for the Enhanced Graphics Module.



"draw" routines. A "move" routine will cause a dark vector, the invisible equivalent of a bright vector; a "point" routine causes the display of a bright spot or point. Also included in the package are a choice of linear, logarithmic, or polar coordinate systems, automatic scaling of graphic data, and buffered input and output for faster, more efficient character handling.

The following section deals with some of the subroutines which output bright and dark vectors (draws and moves, respectively) and points using Terminal screen coordinates. The values of these coordinates should be from 0 to 1023 unless a 4014/15 Terminal with the Enhanced Graphic Module is used (in which case addressing from 0 through 4095 points is available). The Y-axis coordinates should not exceed 780 (or 3120 for the Enhanced Graphics Module) to remain visible on the screen.

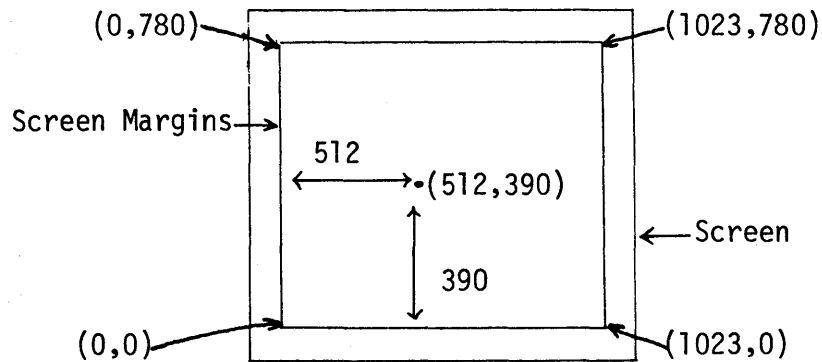

Screen Coordinates\*

Figure 1.3

\* The Screen Margins indicate the initial settings for alphanumeric line limits on the Terminal Screen.



## 2. INTRODUCTORY DRAWING

*INITIALIZATION:*  
*Subroutine INITT*

2.1 Initialization of the Terminal and the Terminal Status Area must be accomplished as the first step in the use of Terminal Control System routines. This may be done by calling the initializing routine, INITT. When INITT is called the following events occur:

- (a) The screen is erased and the cursor (the small floating square which indicates the position where writing will occur) moves to the HOME position in the upper left hand corner of the screen.
- (b) The Terminal is set to alphanumeric mode.
- (c) The margin values are set to the left and right screen extremes.
- (d) The window is defined so that the portion of virtual space will be displayed which is equivalent in coordinates with the screen [i.e., (275, 763) in user coordinates is equivalent to (275, 763) in screen coordinates]. See sections 3.0 through 3.2 for a description of virtual graphics.

INITT requires the rate of character transmission from the computer to the Terminal as an input parameter in order that appropriate delays may be produced during screen erasure and hardcopy generation. This will prevent loss of data on remotely connected Terminals while they are not ready.

### CALLING SEQUENCE:

CALL INITT (IBAUD)

### Parameter Entered:

IBAUD - the transmission (baud) rate in characters per second.

*TERMINATION:*  
*Subroutine FINITT*

2.2 When terminating a program which uses the Terminal Control System, it may be desirable to return the Terminal to alphanumeric mode and move the cursor to a point that will not interfere with any previous output. All output to the Terminal is buffered, or stored, until the user calls a routine that dumps the buffer, or until the buffer is full.

FINITT automatically performs these functions. It terminates the program and outputs the contents of the buffer. Its arguments designate the position of the alphanumeric cursor upon program termination. FINITT should be used, depending on the computer system, either in conjunction with or in place of a FORTRAN STOP statement.

CALLING SEQUENCE:

CALL FINITT (IX, IY)

Parameters Entered:

IX - the screen x-coordinate of the position to which the beam is moved before program termination.

IY - the screen y-coordinate of the beam termination position.

*ABSOLUTE LINE  
DRAWING IN  
SCREEN COORDINATES*

2.3 The three functions which do line drawing by referring to screen coordinate locations are MOVABS, DRWABS, and PNTABS. "ABS" stands for absolute; the drawing is called absolute because it is measured from a fixed point, the origin (0,0). The arguments of these routines are always in integer format.

*Subroutine MOVABS*

2.4 The argument of MOVABS is the pair of coordinates of the point to which a move is desired. Output starts at the stored current beam position. This position is updated after every line draw or other output command. In addition, all drawings are buffered.

CALLING SEQUENCE:

CALL MOVABS (IX, IY)

Example:

CALL MOVABS (100, 150)

This call generates a move to (100, 150) so that that drawing can proceed from there.

*Subroutine DRWABS*

2.5 DRWABS generates a bright vector from the current beam position to the coordinates given and updates the appropriate variables in the Terminal Status Area.

CALLING SEQUENCE:

```
CALL DRWABS (IX, IY)
```

Example:

```
CALL MOVABS (100, 50)  
CALL DRWABS (300, 50)
```

These calls cause a move to (100, 50) and a subsequent line to be drawn from (100, 50) to (300, 50).

Example:

PROGRAM TO DRAW A TRIANGLE

```
CALL INITT(30)  
CALL MOVABS(100,100)  
CALL DRWABS(300,100)  
CALL DRWABS(200,187)  
CALL DRWABS(100,100)  
CALL FINITT(0.767)
```



Figure 2.5

*Subroutine PNTABS*

2.6 PNTABS similarly moves to the coordinates given as arguments and displays a point there.

CALLING SEQUENCE:

CALL PNTABS (IX, IY)

Example:

```
CALL INITT(30)
CALL MOVABS(300,200)
CALL DRWABS(500,200)
CALL DRWABS(500,400)
CALL DRWABS(300,400)
CALL DRWABS(300,200)
CALL PNTABS(400,300)
CALL FINITT(0,767)
```

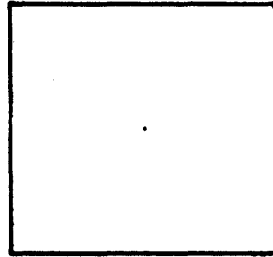

Figure 2.6

*RELATIVE LINE  
DRAWING IN SCREEN  
COORDINATES*

2.7 It is often easier to draw lines by indicating how many horizontal and vertical screen units to move relative to the last beam position. Negative relative movement is to the left or down. DRWREL, MOVREL, and PNTREL perform relative drawing in screen units. They have the same syntax as DRWABS, MOVABS, and PNTABS.

Example:

Draw the same box as in figure 2.6 with relative vectors.

```
CALL INITT(30)
CALL MOVABS(300,200)
CALL DRWREL(200,0)
CALL DRWREL(0,200)
CALL DRWREL(-200,0)
CALL DRWREL(0,-200)
CALL PNTREL(100,100)
CALL FINITT(0,767)
```

*SCREEN GRAPHICS*

*(Integer Arguments)*

<i>ACTION</i>	<i>ABSOLUTE</i>	<i>RELATIVE</i>
<i>MOVE</i>	<i>MOVABS</i>	<i>MOVREL</i>
<i>DRAW</i>	<i>DRWABS</i>	<i>DRWREL</i>
<i>POINT</i>	<i>PNTABS</i>	<i>PNTREL</i>

Figure 2.7





### 3. VIRTUAL AND SCREEN GRAPHICS

This part deals with the most important relationships in the Terminal Control System, the translation of the User's data to a physical location on the screen. With an understanding of this relationship between the data area and the Terminal screen the User can freely manipulate the display on the screen to reflect his need. For example, he can plot three different sets of data in the same screen display.

The first group of sections in this part (1 through 6) discusses the display of the User's data area. This area may be conceived of as existing virtually within the computer, and is analogous to the sheet of paper on which graphic data is usually drawn. The data area is called virtual space. The unit of measurement in virtual space is arbitrary and representative of any unit the User wishes, from milligrams to light years.

The second group of sections in this part (7 and 8) discusses how virtual data may be displayed by screen graphics in designated portions of the Terminal screen (the screen window). Sections 9 and 10 deal specifically with the inter-dependence of virtual space graphics and screen graphics. Sections 11 and 12 discuss the drawing of dashed lines with both virtual space graphics and screen space graphics.

#### *THE VIRTUAL WINDOW:*

3.1 All or any portion of virtual space may be viewed at any time through the technique of windowing. The User defines in user units a rectangle, the virtual window, which utilizes that part of virtual space he wishes to view. Graphic lines (vectors) and portions of lines which lie outside the virtual window are automatically eliminated or clipped by the graphic routines, while those which lie within or pass through the window are scaled and fitted into the appropriate portion of the screen.

A VIEWABLE AREA IN  
USER UNITS:  
(THE VIRTUAL WINDOW)

3.2 Examine a graph as conceived in days and dollars and the method that will be used to display it on the screen. Suppose the following raw data is to be plotted:

DAY	PROFIT
1	\$ 30
2	26
3	42
4	38
5	40
6	50
7	54
8	48
9	40
10	52

A virtual window is defined in virtual space with the lower lefthand corner at (0 days, 20 dollars). It is to extend horizontally on the x-axis for 10 days and vertically on the Y-axis for 40 dollars. One way of defining a rectangular window is to specify the lower lefthand corner and the horizontal and vertical dimensions.

When the data is displayed on the screen, it is scaled in proportion to distances in the virtual window. Since the screen is 1024 units wide, it will be displayed  $(1/10) \times 1024 = 102$  units from left to right on the screen. The point (1,30) is  $1/4$  of the distance, bottom to top, on the virtual window. The screen is 781 units high, so the point is displayed  $(1/4) \times 781 = 195$  units from the bottom of the screen (Figure 3.2). Every point on the virtual window is similarly translated to a point on the screen.

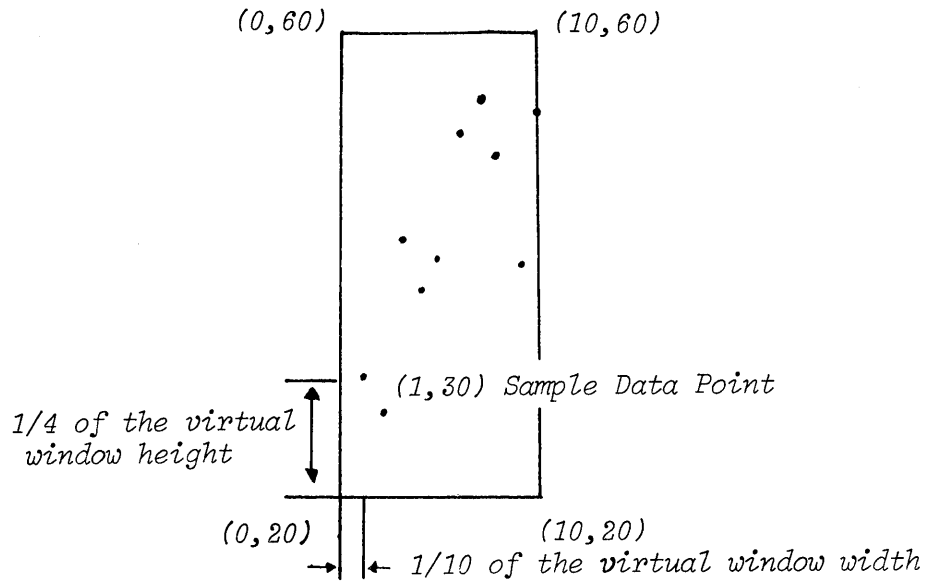

THE VIRTUAL WINDOW  
Figure 3.2

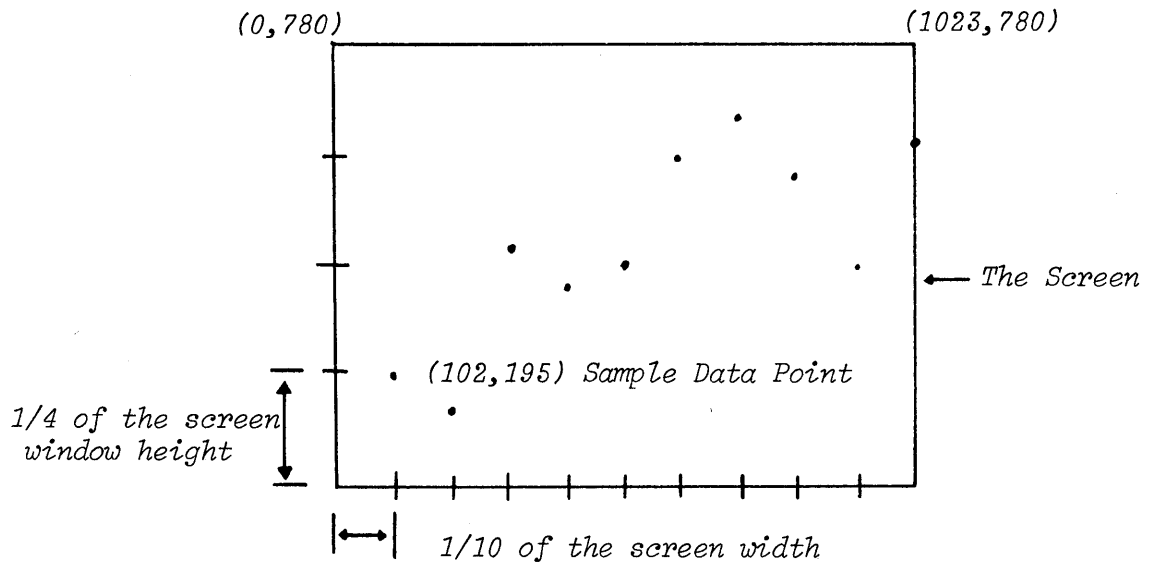

The Data of Figure 3.2 as Displayed on the Screen\*

\*The code used to display Figure 3.2 may be seen on page 3-5.

*DEFINING THE  
VIRTUAL WINDOW:  
Subroutine VWINDO*

3.3 The Terminal Control System uses one of two subroutines to define the virtual window. The first is VWINDO.

CALLING SEQUENCE:

CALL VWINDO (XMIN, XRANGE, YMIN, YRANGE)

Parameters Entered:

XMIN - the minimum horizontal user coordinate.

XRANGE - the horizontal extent of the rectangle.

YMIN - the minimum vertical user coordinate.

YRANGE - the vertical extent of the rectangle.

In the example of Figure 3.2, the calling sequence would be:

CALL VWINDO (0.,10.,20.,40.)

*Subroutine DWINDO*

3.4 A second method of defining a virtual window may be employed by using the subroutine DWINDO. DWINDO uses a calling sequence similar to that of VWINDO.

CALLING SEQUENCE:

CALL DWINDO (XMIN, XMAX, YMIN, YMAX)

Parameters Entered:

XMIN - the minimum horizontal user coordinate.

XMAX - the maximum horizontal user coordinate.

YMIN - the minimum vertical user coordinate.

YMAX - the maximum vertical user coordinate.

In the example of Figure 3.2, the calling sequence would be:

CALL DWINDO (0.,10.,20.,60.)

LINE DRAWING IN  
USER (VIRTUAL)  
UNITS:  
*Absolute Line  
Drawing*

3.5 MOVEA, DRAWA, and POINTA are analogous to MOVABS, DRWABS, and PNTABS, but they allow points outside the virtual window to be referenced. Only those points or portions of bright vectors (line segments) which fall within the window boundaries, however, will be displayed; this is known as "clipping".

CALLING SEQUENCE:

```
CALL MOVEA (X, Y)
CALL DRAWA (X, Y)
CALL POINTA (X, Y)
```

Parameters Entered:

X - the horizontal virtual (real) coordinate to which a bright or dark vector is drawn or at which a point is displayed.

Y - the vertical virtual (real) coordinate to which a bright or dark vector is drawn or at which a point is displayed.

Using subroutine POINTA, we will display the data of Figure 3.2:

```

DIMENSION X(10),Y(10)
CALL INITT(30)
CALL UWINDO(0,10,20,40)
DATA X/1,2,3,4,5,6,7,8,9,10/
DATA Y/30,26,42,38,40,50,54,48,40,52/
DO 100 I=1,10
100 CALL POINTA(X(I),Y(I))
CALL FINITT(0.767)
```

To work in user units on the screen, one could set up a virtual window that measures eight by six units. The following code will draw a three by three unit rectangle with the lefthand corner at (1.,1.) and a point in the middle.

```
CALL INITT(30)
CALL UWINDO(0,8,0,6)
CALL MOVEA(1,1)
CALL DRAWA(1,4)
CALL DRAWA(4,4)
CALL DRAWA(4,1)
CALL DRAWA(1,1)
CALL POINTA(2.5,2.5)
CALL FINITT(0,767)
```

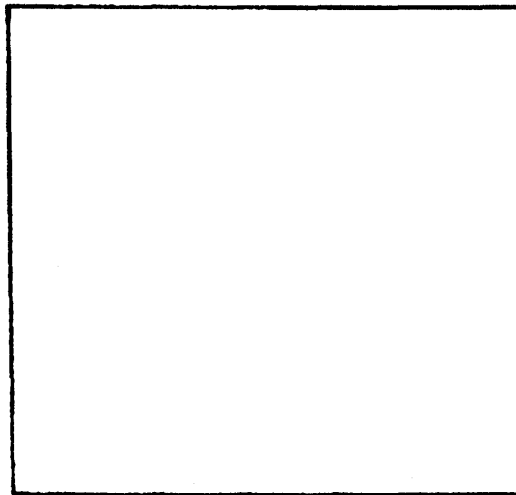

Figure 3.5

*RELATIVE VIRTUAL  
COORDINATE  
SUBROUTINES*

3.6 *MOVER*, *DRAWR*, and *POINTR* draw straight lines, move, and display points respectively, relative to the current beam position. They are analogous to *MOVREL*, *DRWREL*, and *PNTREL*, (Section 2.7) except that they deal with user rather than screen units and clipping, as described above, may occur.

The following code will produce the same rectangle as that of Figure 3.5.

```
CALL INITT(30)
CALL UWINDO(0,8,0,6)
CALL MOVEA(1,1)
CALL DRAWR(0,3)
CALL DRAWR(3,0)
CALL DRAWR(0,-3)
CALL DRAWR(-3,0)
CALL POINTR(1.5,1.5)
CALL FINITT(0,767)
```

*SCREEN GRAPHICS*

*(Integer Arguments)*

*VIRTUAL GRAPHICS*

*(Real Arguments)*

<i>ACTION</i>	<i>ABSOLUTE</i>	<i>RELATIVE</i>	<i>ABSOLUTE</i>	<i>RELATIVE</i>
<i>MOVE</i>	<i>MOVABS</i>	<i>MOVREL</i>	<i>MOVEA</i>	<i>MOVER</i>
<i>DRAW</i>	<i>DRWABS</i>	<i>DRWREL</i>	<i>DRAWA</i>	<i>DRAWR</i>
<i>POINT</i>	<i>PNTABS</i>	<i>PNTREL</i>	<i>POINTA</i>	<i>POINTR</i>

Figure 3.6

*THE SCREEN WINDOW*

3.7 So far, to display a drawing in virtual space the entire screen has been used. But any rectangular portion of the screen can be used as a display area. This display area is called the screen window, and it is defined by the subroutines SWINDO and TWINDO. The two subroutines stand in the same relation to each other as do VWINDO and DWINDO (see Sections 3.3 and 3.4); like all arguments in screen terms, the arguments of SWINDO and TWINDO are in integer format.

*Subroutine SWINDO*

3.7.1 CALLING SEQUENCE:

CALL SWINDO (MINX, LENX, MINY, LENY)

Parameters Entered:

MINX - the minimum horizontal screen coordinate.

LENX - the horizontal extent of the rectangle.

MINY - the minimum vertical screen coordinate.

LENY - the vertical extent of the rectangle.

*Subroutine TWINDO*

3.7.2 CALLING SEQUENCE:

CALL TWINDO (MINX, MAXX, MINY, MAXY)

Parameters Entered:

MINX - the minimum horizontal screen coordinate.

MAXX - the maximum horizontal screen coordinate.

MINY - the minimum vertical screen coordinate.

MAXY - the maximum vertical screen coordinate.

*SCALING AND  
STRETCHING THE  
SCREEN WINDOW*

3.8 The points of the virtual window are scaled to fit into the screen window in the same manner as they previously fitted into the entire screen. Consider again the data of Figure 3.2.

The following program illustrates how the size and shape of the screen window can be manipulated by changing the dimensions of TWINDO. Note that all of the virtual data is displayed in each case.



```

C * DEMONSTRATION OF SCALING AND STRETCHING
  CALL INITT (30)
  CALL DWINDO (0 ,10 ,20 ,60.)
C * DRAW THE SAME GRAPH IN FOUR TERMINAL WINDOWS
  CALL TWINDO (0,200,550,700)
  CALL GRAFIT
  CALL TWINDO (300,900,550,700)
  CALL GRAFIT
  CALL TWINDO (0,200,0,450)
  CALL GRAFIT
  CALL TWINDO (300,900,0,450)
  CALL GRAFIT
C * MAKE HARDCOPY
  CALL HDCOPY
  CALL FINITT(0,760)
  END

C * SUBROUTINE TO DRAW GRAPH WHICH FILLS TERMINAL WINDOW
  SUBROUTINE GRAFIT
  DIMENSION X(10),Y(10)
  DATA X/1 ,2 ,3 ,4 ,5 ,6 ,7 ,8 ,9 ,10 /
  DATA Y/30 ,26 ,42 ,38 ,40 ,50 ,54 ,48 ,40 ,52 /
  CALL MOVEA(X(1),Y(1))
  DO 100 I=1,10
100  CALL DRAWA(X(I),Y(I))
  CALL MOVEA(0 ,20 )
  CALL DRAWA(10 ,20.)
  CALL DRAWA(10 ,60.)
  CALL DRAWA(0 ,60.)
  CALL DRAWA(0 ,20.)
  RETURN
  END

```

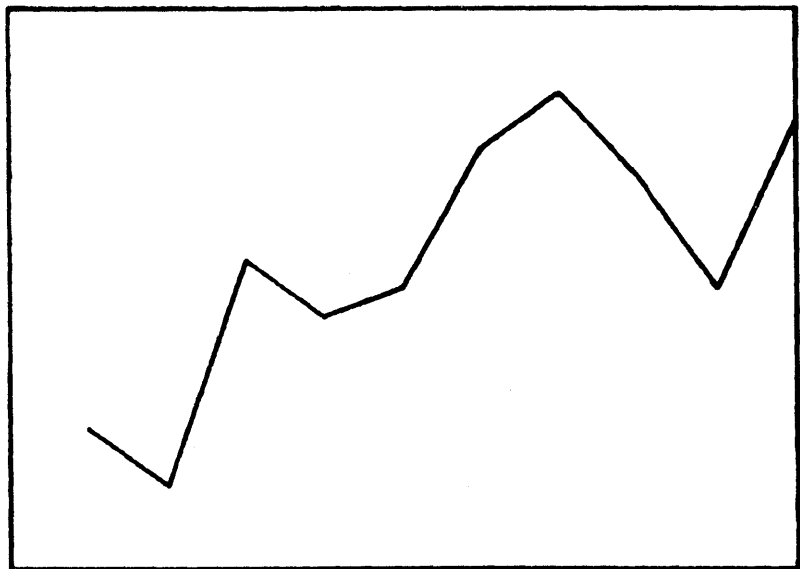
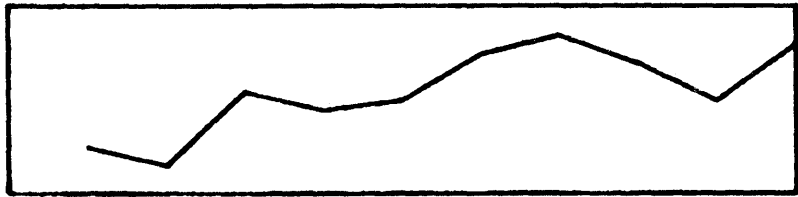

Figure 3.8

CLIPPING IN  
VIRTUAL SPACE:

3.9 To see only a portion of the data, the user can change VWINDO/DWINDO to include only the desired section. When drawing is done in user (virtual) units, that portion of the drawing is clipped which occurs outside the present virtual window. Clipping occurs in all virtual graphics:

```
100 DIMENSION X(10),Y(10)
    DATA X/1.,2.,3.,4.,5.,6.,7.,8.,9.,10./
    DATA Y/30.,26.,42.,38.,40.,50.,54.,48.,40.,52./
    CALL INITT(30)
    CALL SWINDO(400,300,200,400)
    CALL UWINDO(3.,5.,40.,15.)
    CALL MOVEA(X(1),Y(1))
    DO 100 I=1,10
    CALL DRAWA(X(I),Y(I))
    CALL MOVABS(400,200)
    CALL DRWABS(700,200)
    CALL DRWABS(700,600)
    CALL DRWABS(400,600)
    CALL DRWABS(400,200)
    CALL FINITT(0.767)
    STOP
    END
```

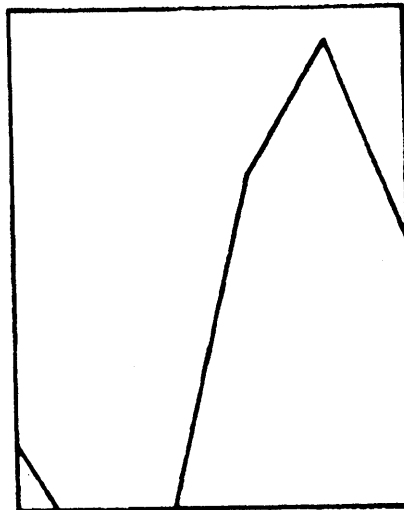

Figure 3.9

*INTERCHANGEABILITY  
OF VIRTUAL AND SCREEN  
GRAPHICS:*

3.10 The user may locate a point in virtual space which is not within the limits of the virtual window. He may draw to and from this point with no difficulty since the drawing will automatically be scaled and clipped by the window definition. The same is not true of screen space, which is defined entirely by the limits of the screen.

Therefore, a transition from screen to virtual space can always be accomplished, but the reverse is not true. If a point in virtual space is designated which does not appear on the screen window, a draw using screen coordinates will originate at the beam's last visible position within the screen window and not at the expected virtual point. In addition the user must be aware of wrap-around if he addresses a point which is off the screen.

Example:

The screen coordinates (1500,0) will cause wrap-around (e.g., A relative draw to the above coordinates will result in a vector on the X-axis drawn (1500-1024) raster units from the current beam position.)

See Figure 3.10

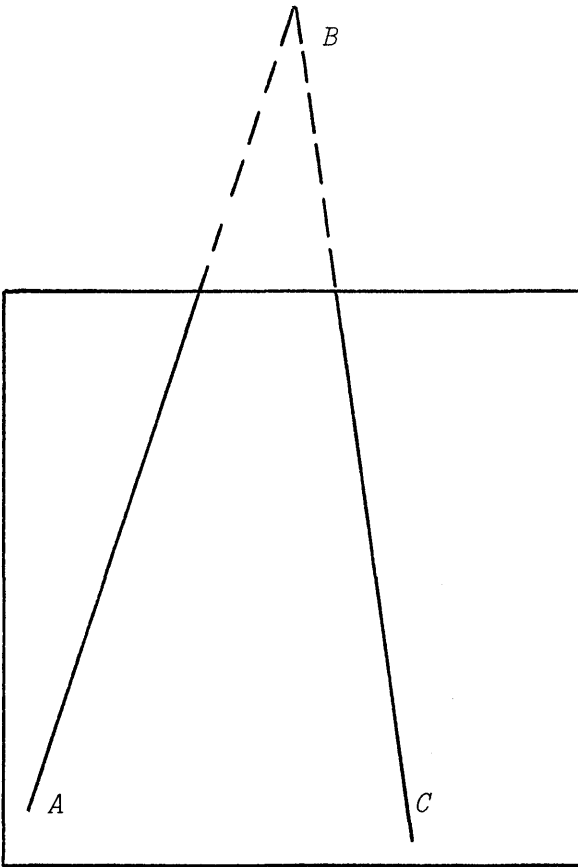

*Screen Window*

*A line drawn in user (virtual) coordinates from point A to point B and back to point C*

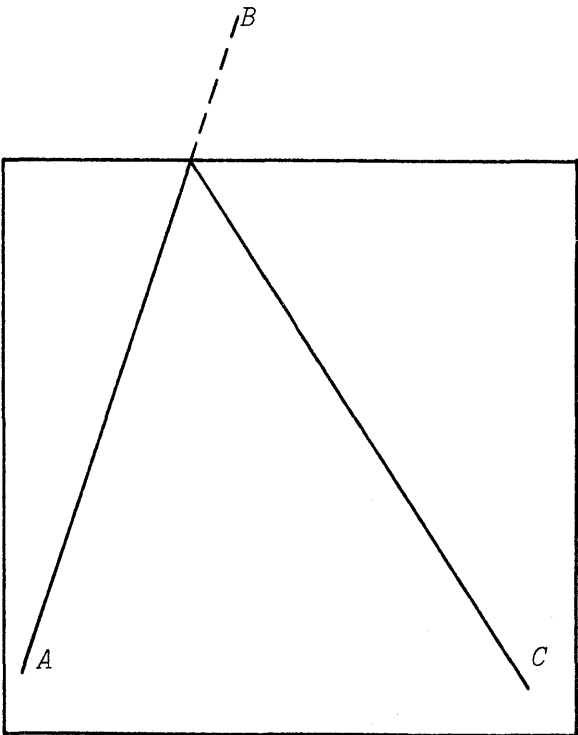

*A line drawn in virtual coordinates from A to B and in screen coordinates back to C. B is a point outside the screen window, but within the screen limits.*

*This draw reflects a user error*

Figure 3.10

*DASHED LINE  
DRAWING*

3.11 Dashed lines of nearly infinite variety may be drawn through the use of the Terminal Control System in both virtual and screen space. The four basic dashed line subroutines are DSHABS, DSHREL, DASHA, and DASHR. These routines are analogous to DRWABS, DRWREL (Sections 2.5 and 2.7), DRAWA, and DRAWR (Sections 3.5 and 3.6); each dashed line subroutine, however, has a third, integer-format argument. This third argument controls the type of dashed line displayed, and it can take any integer value from -1 to the largest integer, less than or equal to 999999999, which your computer can accept.

CALLING SEQUENCES:

```
CALL DSHABS (IX, IY, L)
CALL DSHREL (IX, IY, L)
CALL DASHA (X, Y, L)
CALL DASHR (X, Y, L)
```

IX, IY (integer) and X, Y (real) are the coordinates the dashed line is drawn to and L is the dash type specification.

*DASHED LINE  
SPECIFICATIONS:  
Parameter L*

3.12 Software dashed lines may be specified on any TEKTRONIX graphics display terminal with a concatenation of the following code numbers:

```
1 - 5 raster units, visible
2 - 5 raster units, invisible
3 - 10 raster units, visible
4 - 10 raster units, invisible
5 - 25 raster units, visible
6 - 25 raster units, invisible
7 - 50 raster units, visible
8 - 50 raster units, invisible
```

Example:

```
CALL DSHABS (200, 700, 3454)
```

The software also uses single digits to specify (L):

-1 causes a move

0 causes a draw

9 alternate visible and invisible segments between data points.

Example:

```
CALL DSHABS (200, 700, -1)
```

Four types of hardware dashed lines are available on the 4014/15 Terminal with Enhanced Graphic Module (see TERM, Section 5.1). The hardware dashed line specifications are fast and efficient and may be used by any TEKTRONIX Graphic Display Terminal. If the terminal hardware is not capable of generating the hardware dash, then the software will approximate the type according to the following key:

- 1 - a dotted line
- 2 - a dash-dot line
- 3 - a short-dashed line
- 4 - a long-dashed line

Example:

```
CALL DSHABS (2000, 7000, 2)
```

The following example illustrates two software-simulated, hardware dash types (2 and 3). Function KIN (Section 4.13), here to make relative draws:

```

C * SAMPLE DRAWING OF A FLANGE
  CALL INITT(30)
  CALL MOVABS(100,50)
  CALL DRWREL(0,KIN(5.))
  CALL DRWREL(KIN(0.5),0)
  CALL DRWREL(0,-KIN(5.))
  CALL DRWREL(-KIN(0.5),0)
  CALL MOUREL(KIN(0.5),KIN(1.5))
  CALL DRWREL(KIN(2.0),0)
  CALL DRWREL(0,KIN(2.0))
  CALL DRWREL(-KIN(2.0),0)
  CALL MOUREL(KIN(2.0),-KIN(0.25))
C * DRAW DASHED 'HIDDEN' LINES
  CALL DSHREL(-KIN(2.5),0,3)
  CALL MOUREL(KIN(2.5),-KIN(1.5))
  CALL DSHREL(-KIN(2.5),0,3)
  CALL MOUREL(KIN(3.0),KIN(0.75))
C * DRAW DASHED 'CENTER LINE'
  CALL DSHREL(-KIN(3.5),0,2)
  CALL FINITT(0,0)
  END

```

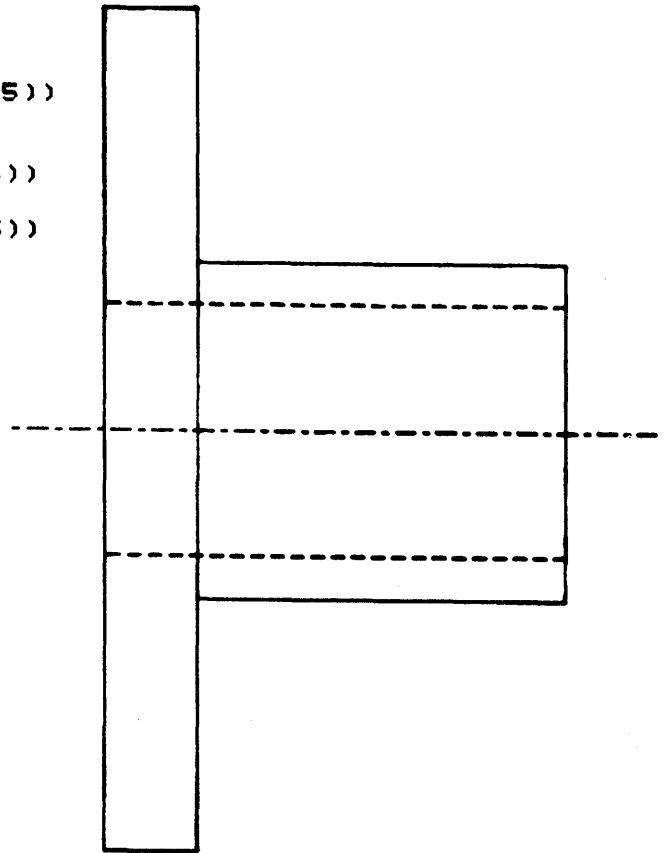

*SCREEN GRAPHICS*  
*(Integer Arguments)*

*VIRTUAL GRAPHICS*  
*(Real Arguments)*

<i>ACTION</i>	<i>ABSOLUTE</i>	<i>RELATIVE</i>	<i>ABSOLUTE</i>	<i>RELATIVE</i>
<i>MOVE</i>	<i>MOVABS</i>	<i>MOVREL</i>	<i>MOVEA</i>	<i>MOVER</i>
<i>DRAW</i>	<i>DRWABS</i>	<i>DRWREL</i>	<i>DRAWA</i>	<i>DRAWR</i>
<i>POINT</i>	<i>PNTABS</i>	<i>PNTREL</i>	<i>POINTA</i>	<i>POINTR</i>
<i>DASH</i>	<i>DSHABS</i>	<i>DSHREL</i>	<i>DASHA</i>	<i>DASHR</i>

Figure 3.12



#### 4. UTILITY ROUTINES

*ALPHANUMERIC  
OUTPUT*

4.1 By allowing the Terminal Control System to monitor alphanumeric (A/N) output rather than using FORTRAN READ and WRITE statements, it is possible to maintain Terminal status, especially the tracking of the beam position. This tracking is required for tab and margin control as well as for facilitating the mixture of A/N and graphic output. As with graphic output, alphanumeric output is buffered, or stored, until a routine is called to dump the buffer, or until the buffer is full.

*ENTERING A/N  
MODE:  
Subroutine ANMODE*

4.2 At times the user may wish to output A/N data other than through the Terminal Control System. In such cases it is the user's responsibility to insure that the Terminal is in A/N mode. This can be done by using ANMODE. It is not necessary to call ANMODE when using the Terminal Control System routines as they will automatically call it whenever necessary. ANMODE can be used to dump the output buffer.\*

#### CALLING SEQUENCE:

CALL ANMODE

*A/N CHARACTER  
OUTPUT:  
Subroutine ANCHO\*\**

4.3 Non-control alphanumeric characters are monitored when output through ANCHO. A/N mode will be entered if necessary and the Terminal Status Area representation of the screen beam position is updated as characters are output. If the outputting of the character advances the beam beyond the right margin setting, a new line is automatically generated.

The input argument is assumed to be a 7-bit ASCII, non-control character which is right-adjusted within an integer word. ANCHO does not check this input variable. Any but the expected input will result in erroneous beam status information.

---

\* The positioning on the Terminal screen of non-Terminal Control System output (such as a FORTRAN WRITE) is dependent upon the way in which the software package is implemented on your computer. See Section 7.11.1 for details. If all output is through the Terminal Control System, no such implementation dependencies exist.

\*\* This routine is also discussed in Section 7.3.

ANCHO updates the beam according to the character size set. All character sizes are correctly updated in 4096 grid space. In 1024 space, however, only the large size characters are correctly updated; the other sizes are fractional screen units in width, forcing the beam update to be an approximation to within 1/2 a screen unit of the true beam position.

CALLING SEQUENCE:

CALL ANCHO (ICHAR)

Parameter Entered:

ICHAR - An integer which represents a 7-bit ASCII character, right-adjusted. NOT a control character.

For an example of ANCHO, see Section 5.4.

*A/N STRING OUTPUT*  
*Subroutine ANSTR\**

4.3.1 ANSTR functions in all respects like ANCHO above, except that it allows the user to output an alphanumeric string instead of a single character. The arguments of ANSTR are NCHAR, the number of characters to be output, and NADE, the array of ASCII decimal equivalent integers which represents the string to be output.

CALLING SEQUENCE:

CALL ANSTR (NCHAR, NADE)

Parameters Entered:

NCHAR     the number of characters to be output.

NADE     An array containing the ASCII decimal integer equivalents for the characters to be output.

4.4     A/N CHARACTER HANDLING

*Subroutine NEWLIN*

Generates a line feed and carriage return.

CALL NEWLIN

*Subroutine LINEF*

Generates a line feed.

CALL LINEF

---

\*This routine is also discussed in Section 7.4.

*Subroutine CARTN* Generates a carriage return  
CALL CARTN

*Subroutine HOME* Moves the alphanumeric cursor to the upper left corner of the screen.  
CALL HOME

*Subroutine BAKSP\** Generates a backspace.  
CALL BAKSP

*Subroutine NEWPAG* Erases the Terminal screen and returns the alphanumeric cursor to the HOME position.  
CALL NEWPAG

*USING THE SCREEN  
CURSOR:*

*Subroutine SCURSR\*\**

4.5 The graphic cursor may be used to specify screen coordinates directly. Calling SCURSR will activate the graphic cursor, allowing the user to position it. The cursor position is transmitted to the computer when a keyboard character is struck. This character along with the input position is returned as arguments by SCURSR. The Terminal Control System compensates for effects on the beam position caused by the graphic cursor.

CALLING SEQUENCE:

CALL SCURSR (ICHAR, IX, IY)

Parameters Returned:

- ICHAR - a keyboard character, 7-bit ASCII right-adjusted.
- IX - the screen x-coordinate of the graphic cursor.
- IY - the screen y-coordinate of the graphic cursor.

The following example (Figure 4.5) demonstrates a use of the screen cursor. ANMODE (Section 4.2) is called to print out the coordinates of the screen cursor.

*Subroutine DCURSR\*\**

4.5.1 DCURSR accomplishes the same function as SCURSR above. It's calling sequence and arguments are also the same.

---

\* Not supported on the 4006-1 Terminal. To achieve a backspace, substitute the following:  
CALL MOVREL (-LINWDT(1),Ø) This is done automatically for Terminal type Ø (See subroutine TERM)

\*\* Not supported on the 4006-1 Terminal.

```

CALL INITT (30)
10 CALL SCURSR (ICHR,IX,IY)
   CALL PNTABS (IX,IY)
   CALL ANMODE
   WRITE (5,20) IX,IY
20  FORMAT (1H+,$,I5,I4)*
   IF (ICHR NE 83) GO TO 10
   CALL FINITT (0,0)
   END

```

SAMPLE CURSOR SELECTION:

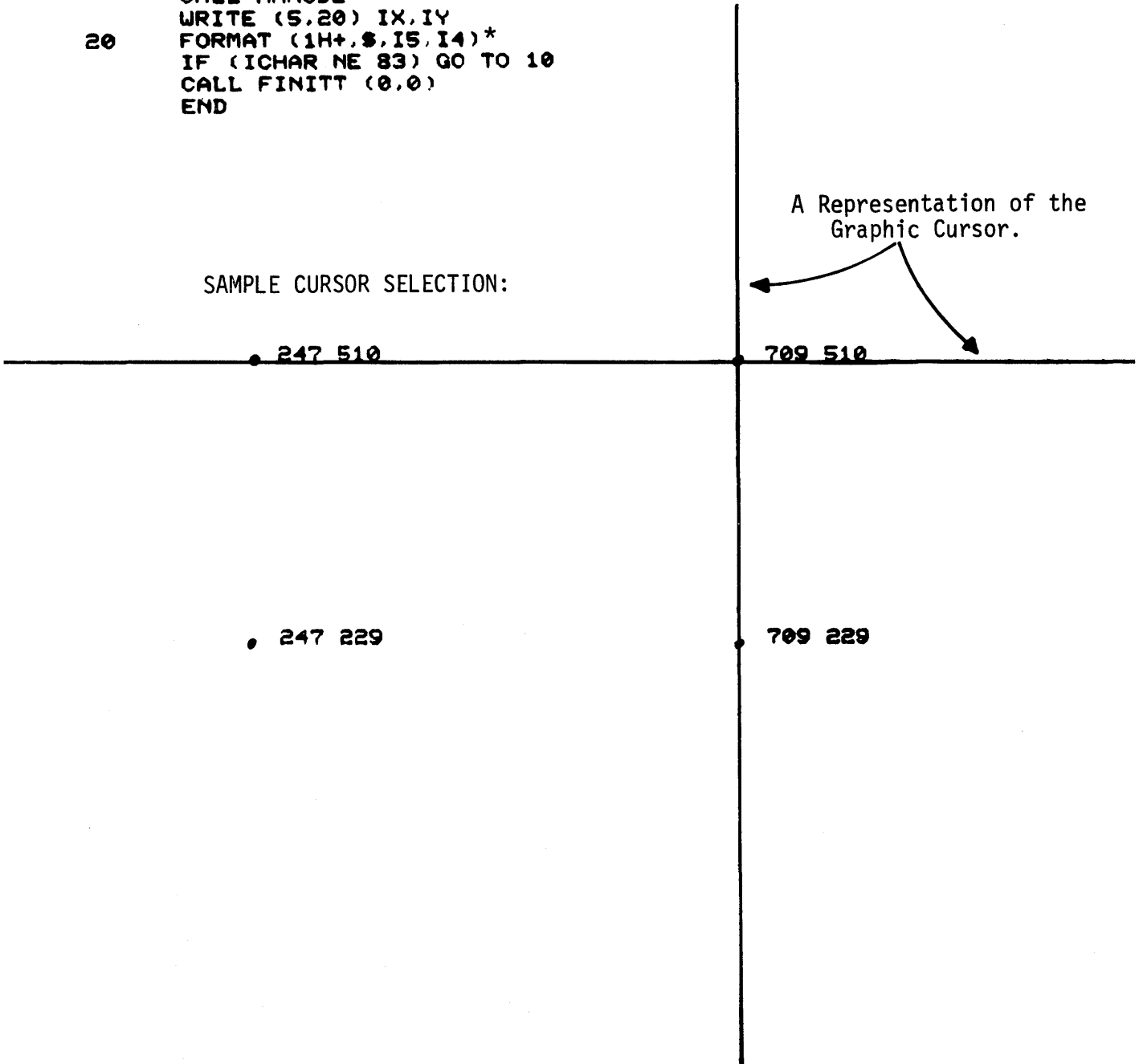

Figure 4.5

\* 1H+, \$ is the PDP-10 processor's carriage-return suppression format.  
(See Implementation Notes)

*USING THE VIRTUAL  
CURSOR:  
Subroutine VCURSR\**

4.6 It is often useful to be able to retrieve virtual rather than screen coordinates with the graphic cursor. The routine VCURSR allows the user to enable the graphic cursor. After the cursor has been positioned, its screen coordinates may be transmitted to the computer by striking a keyboard character. VCURSR transforms the input data into virtual coordinates according to the current window definition. The virtual cursor does not affect the beam position.

The transformation which VCURSR effects assumes that all of the screen is a continuation of virtual space with the scale implied by the current window.

CALLING SEQUENCE:

CALL VCURSR (ICHR, X, Y)

Parameters Returned:

- ICHR - a keyboard character, 7-bit ASCII, right-adjusted.
- X - the virtual x-coordinate of the graphic cursor.
- Y - the virtual y-coordinate of the graphic cursor.

The following example of VCURSR allows the user the capability of interactive line drawing. When a character is struck, a line segment is drawn or a move is made from the current beam position to the coordinates specified by the graphic cursor.

---

\* Not supported on the 4006-1 Terminal.

```

        DIMENSION FRAME(8)
        DATA FRAME/1.,0.,1.,1.,0.,1.,0.,0./
        CALL INITT(120)
C *   SPECIFY MINIMUMS AND EXTENTS OF WINDOWS
        CALL SWINDO(250,500,150,500)
        CALL UWINDO(0.,1.,0.,1.)
C *   FRAME THE SCREEN WINDOW
        CALL MOVEA(0.,0.)
        DO 100 I=1,8,2
100    CALL DRAWA(FRAME(I),FRAME(I+1))
C *   SAMPLE THE CURSOR REPEATEDLY
150    CALL ANMODE
        CALL UCURSR(IBR,X,Y)
C *   A "P" IS STRUCK
        IF(IBR.EQ.80)GO TO 200
C *   A "D" IS STRUCK
        IF(IBR.EQ.68)GO TO 300
C *   AN "M" IS STRUCK
        IF(IBR.EQ.77)GO TO 400
C *   AN "S" IS STRUCK
        IF(IBR.EQ.83)GO TO 500
        GO TO 150
200    CALL POINTA(X,Y)
        GO TO 150
300    CALL DRAWA(X,Y)
        GO TO 150
400    CALL MOVEA(X,Y)
        GO TO 150
500    CALL ANMODE
        CALL FINITT(0,767)
        END

```

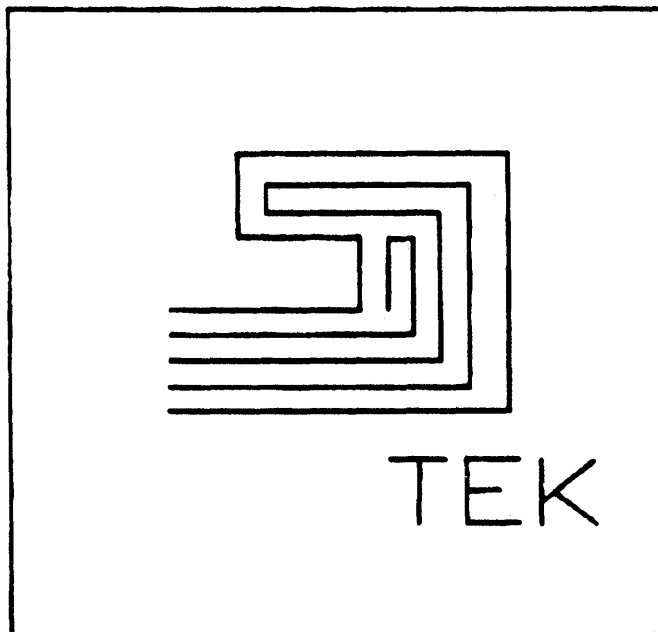

Figure 4.6

*TERMINAL STATUS  
AREA:*

4.7 The Terminal Status Area is a set of variables which are kept in a common block and represent the current state of the Terminal. The Terminal Control System allows the user to save the current Terminal status and return to it at a later time.

Although it does not save the displayed data, this facility does allow the user to interrupt his processing, move to another location, do other processing there or interact with the user, and then return to his original processing.

Since the user allocates the save areas, he may easily save more than one level of status and may restore any of his saved states at any time.

*Subroutine SVSTAT*

4.7.1 The current status of the Terminal may be saved by providing the status saving routine with a 60-word real array in which the Terminal Status Area may be stored.

WARNING: The status of dashed lines cannot be saved and used again reliably.

CALLING SEQUENCE:

CALL SVSTAT (RARRAY)

Parameter Entered:

RARRAY - a 60-word real array.

*Subroutine RESTAT*

4.7.2 The Terminal may be restored to any previously saved state at any time by providing the status restoring routine with the 60-word real array in which the previous Terminal Status Area was stored.

CALLING SEQUENCE:

CALL RESTAT (RARRAY)

Parameter Entered:

RARRAY - the 60-word array containing  
previously stored terminal state.

```

CALL INITT(30)
DIMENSION IBOX(8),ITIME(8),B(60),T(60)
DATA IBOX/200,0,0,200,-200,0,0,-200/
DATA ITIME/80,0,-80,120,80,0,-80,-120/
CALL MOVABS(400,300)
C   SAVE CURRENT TERMINAL STATUS
CALL SUSTAT(B)
CALL MOVABS(460,340)
CALL SUSTAT(T)
DO 100 N=1,7,2
CALL DRWREL(ITIME(N),ITIME(N+1))
CALL SUSTAT(T)
C   RESTORE STATUS
CALL RESTAT(B)
CALL DRWREL(IBOX(N),IBOX(N+1))
CALL SUSTAT(B)
100 CALL RESTAT(T)
C   OPTIONAL HARDCOPY
CALL HDCOPY
CALL FINITT(0,767)
STOP
END

```

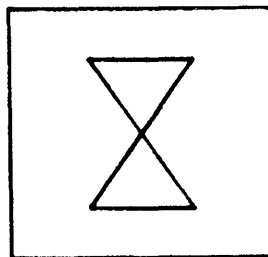

Figure 4.7



RESCALING A  
GRAPHIC OUTPUT:

Subroutine RSCALE\*

4.8 A graphic figure drawn with relative coordinates may be rescaled by any virtual, relative factor which is compatible with the virtual window definition; that is, a figure will be clipped if its dimensions exceed the limits of the virtual window.

CALLING SEQUENCE:

CALL RSCALE (FACTOR)

Parameter Entered:

FACTOR - the rescaling factor relative to the original size of the display.

ROTATING GRAPHIC  
OUTPUT:

Subroutine RROTAT\*

4.9 A graphic figure drawn with relative coordinates may be rotated at any angle relative to its original display position.

CALLING SEQUENCE:

CALL RROTAT (DEG)

Parameter Entered:

DEG - the angle of rotation relative to the position of the original display.

The following example draws a triangle, then rescales it by a factor of 2 and rotates it by  $90^\circ$  to obtain the second triangle.

---

\* Those user's who have an old version of the TEKTRONIX Character Generation system (Part No. 062-1494-00) should delete the above routines from their Character Generation System software and use these subroutines in their place. The current version of the 4010A05 Plot 10 Character Generation System does not contain RSCALE or RROTAT.

```

CALL INITT(30)
CALL TRIANG(200 ,200 .)
C DOUBLE SCALE SIZE
CALL RSCALE(2 )
CALL RROTAT(90 )
C ROTATED 90 DEGREES AND REDRAW
CALL TRIANG(700 ,400 )
CALL TINPUT(K)
CALL FINITT(10,10)
STOP
END

```

```

SUBROUTINE TRIANG(X,Y)
CALL MOVEA(X,Y)
CALL MOVER(-100 , -100 .)
CALL DRAWR(200 .,0 .)
CALL DRAWR(-100 .,200 .)
CALL DRAWR(-100 ., -200 .)
CALL POINTR(100 .,100 .)
RETURN
END

```

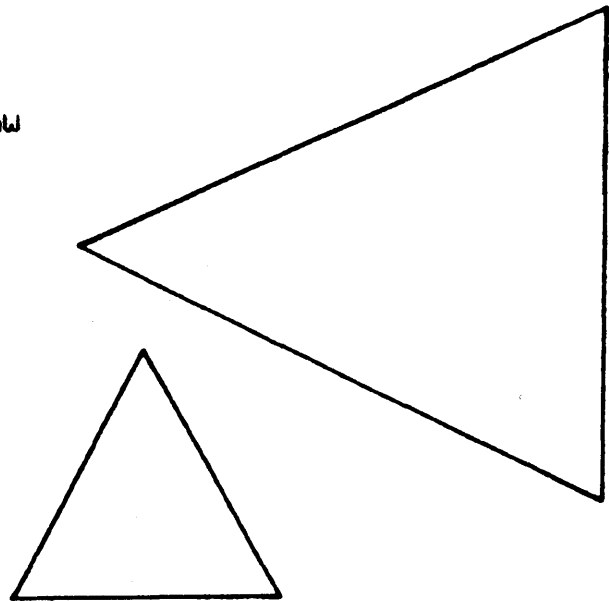

Figure 4.9

*Subroutine RESET*

4.10 This routine accomplishes the same function as INITT (see Section 2.1), but it does not call for a new page.

CALLING SEQUENCE:

CALL RESET

*Subroutine RECOVER*

4.11 RECOVER updates the Terminal hardware to match the Terminal Status Area variables. It is useful following output to the Terminal which is outside the realm of the Terminal Control System (e.g., a FORTRAN WRITE).

CALLING SEQUENCE:

CALL RECOVER

*MISCELLANEOUS  
UTILITY ROUTINES:*

*Subroutine HDCOPY*

4.12 The user who is equipped with the TEKTRONIX hardcopy unit appropriate to his terminal may have the computer generate a hardcopy of the screen contents at any time. This may be accomplished while in any mode and does not affect the Terminal Control System status. The system will prevent generation of additional output until the hardcopy is completed.

CALLING SEQUENCE:

CALL HDCOPY

*Subroutine ERASE*

The Terminal screen may be erased without changing the mode or beam position. The Terminal Control System will prevent generation of additional output until the erase is completed.

CALLING SEQUENCE:

CALL ERASE

*Subroutine BELL*

An audible tone may be output at any time to call the user's attention to a particular event. Often a sustained audible output, which may be generated by a series of calls to the bell routine is used for an alarm. The "bell" may be sounded while in any mode except GIN (Graphic Input) mode and has no affect on Terminal Status.

CALLING SEQUENCE:

CALL BELL

*Subroutine SEETW*

Returns the current values of the screen window.

CALLING SEQUENCE:

CALL SEETW (MINX, MAXX, MINY, MAXY)

Parameters Returned:

MINX - the minimum horizontal screen coordinate.  
MAXX - the maximum horizontal screen coordinate.  
MINY - the minimum vertical screen coordinate.  
MAXY - the maximum vertical screen coordinate.

*Subroutine SEEDW*

Returns the current values of the virtual window limits.

CALLING SEQUENCE:

CALL SEEDW (XMIN, XMAX, YMIN, YMAX)

Parameters Returned:

XMIN - the minimum horizontal user coordinate.  
XMAX - the maximum horizontal user coordinate.  
YMIN - the minimum vertical user coordinate.  
YMAX - the maximum vertical user coordinate.

*Subroutine SEEREL*

Returns the values of the common variables used by the relative virtual routines to scale and rotate vectors.

CALLING SEQUENCE:

CALL SEEREL (RSCOS, RSIN, SCALE)

Parameters Returned:

RCOS - the cosine of the rotation angle.  
RSIN - the sine of the rotation angle.  
SCALE - the multiplier used for scaling.

*Subroutine SEETRN*

Returns the value of the common variables set by the window and transformation routines.

CALLING SEQUENCE:

CALL SEETRN (XFAC, YFAC, KEY)

Parameters Returned:

XFAC - the x scale factor  
YFAC - the y scale factor  
KEY - the transformation key  
1 = linear  
2 = log  
3 = polar

*CONVERSION OF  
INCHES TO SCREEN  
UNITS:*

*Function KIN*

4.13 The function routine KIN transforms inches to screen units. It provides the number of raster units in (RI) inches.

CALLING SEQUENCE:

Variable = KIN (RI)

Parameter Entered:

RI - the number of inches.

Parameter Returned:

KIN - the number of raster units in (RI) inches.

Example:

KIN is a means of determining a screen position when the user wishes to work with virtual units.

IX = KIN (1.4)

CALL DRWREL (IX, 0)

*CONVERSION OF  
CENTIMETERS TO  
SCREEN UNITS:*

*Function KCM*

4.14 The function routine KCM transforms centimeters to screen units. It provides the number of raster units in (RC) centimeters.

CALLING SEQUENCE:

Variable = KCM (RC)

Parameter Entered:

RC - the number of centimeters.

Parameter Returned:

KCM - the number of raster units in (RC) centimeters.

Example:

KCM is a means of determining a screen position when the user wishes to work with virtual units.

IX = KCM (3.5)

CALL DRWREL (IX, 0)

*MEASURING THE  
WIDTH OF  
CHARACTERS:*

*Function LINWDT*

4.15 LINWDT provides the width in raster units as an accurate measure of the horizontal size of a given number of adjacent characters. The context is the current screen coordinate system (1024 addressable points vs. 4096 addressable points).

CALLING SEQUENCE:

Variable = LINWDT (NUMCHR)

Parameter Entered:

NUMCHR - the number of adjacent characters for which the width in raster units is desired.

Parameter Returned:

LINWDT - the width in raster units of NUMCHR characters in the current character size.

*MEASURING THE  
HEIGHT OF LINES:*

*Function LINHGT*

4.16 LINHGT provides in raster units the accurate measure of the height of a given number of lines.

CALLING SEQUENCE:

Variable = LINHGT (NUMLIN)

Parameter Entered:

NUMLIN - the integer number of lines for which the height in raster units is desired.

Parameter Returned:

LINHGT - the height in raster units of NUMLIN lines in the current character size (see CHR Siz, Figure 5.3).

*TABS AND MARGINS*

4.17 The Terminal Control System allows the user to set and reset tabs and margins to facilitate format layout. The tab and margin settings are software generated and as such are useful only for A/N output through Terminal Control System routines. All tab and margin values are in screen coordinates. Both horizontal and vertical tabs and left and right margins are available; both horizontal and vertical tabs are limited to ten positions each.

*SETTING THE TAB  
TABLE:*

*Subroutine TTBSZ*

4.17.1 Tab settings for both horizontal and vertical tabs are kept in two ten-word integer arrays. The settings are ordered with ascending screen coordinates, the first zero value indicating the end of the settings. TTBSZ sets up the size of the integer array. The horizontal and vertical arrays must be equal in size.

CALLING SEQUENCE:

CALL TTBSZ (ITBSZ)

Parameter Entered:

ITBSZ - the size of the tab table  
(horizontal and vertical)  
expressed as an integer  
from 1 to 10.

*TAB SETTING:*

*Subroutine SETTAB*

4.17.2 The routine SETTAB takes a given tab setting in screen coordinates and inserts it into the given tab table. If the tab is full, the maximum setting will be lost in order that a lessor tab setting may be inserted. Although duplicate tab settings are not inserted, SETTAB does not generally check the tab setting for validity nor does it know whether the given tab table is horizontal or vertical.\*

CALLING SEQUENCE:

CALL SETTAB (ITAB, ITBTBL)

Parameters Entered:

ITAB - tab setting in either X or Y  
coordinates.

ITBTBL - the horizontal or vertical tab  
table (Array Name).

---

\* SETTAB expects ITBTBL to be initialized to zero. If the system does not do this automatically, the user should do it with a DATA statement.

*REMOVING A TAB:*  
*Subroutine RSTTAB*

4.17.3 To remove a tab selectively, its position in screen coordinates (ITAB) must be entered along with the proper tab table. Non-zero values which do not correspond to a current tab setting are ignored. If the value of the tab position is  $\emptyset$ , the entire tab table will be removed.

CALLING SEQUENCE:

CALL RSTTAB (ITAB, ITBTBL)

Parameters Entered:

ITAB - the X or Y screen coordinate of the tab to be removed. If the number is  $\emptyset$ , all tabs in the tab table designated will be removed.

ITBTBL - the horizontal or vertical tab table (Array Name).

*THE HORIZONTAL TAB:*  
*Subroutine TABHOR*

4.17.4 Calling the horizontal tab routine will cause the alphanumeric cursor to be moved with a constant Y-value to the position specified by the first non-zero entry in the horizontal tab table, IHORZ, which is greater than the current screen X-coordinate of the cursor or beam position. If the horizontal tab table is empty, no action will occur. If the tab table is not empty and no entry exists which is greater than the current screen X-coordinate of the cursor or beam position, or if the first non-zero entry greater than the screen X-coordinate is also greater than the right margin setting, a new line will be generated.

CALLING SEQUENCE:

CALL TABHOR (ITBTBL)

Parameter Entered:

ITBTBL - the name of the horizontal table.



*THE VERTICAL TAB:*

*Subroutine TABVER*

4.17.5 Vertical tabbing will cause the alphanumeric cursor to be moved with a constant X-value to the position specified by the last non-zero entry in the vertical tab table which is less than the current Y-coordinate of the cursor on beam position. If no such entry exists, then no action is taken.

CALLING SEQUENCE:

CALL TABVER (ITBTBL)

Parameter Entered:

ITBTBL - the name of the vertical tab table  
(see SETTAB, Section 4.17.2).

The following example sets the tabs and resets them, putting our characters with the help of subroutine ANCHO (Section 4.3).

```

DIMENSION IHORZ(4), IVERT(4)
CALL INITT (30)
CALL TTBSZ (4)
CALL SETTAB (20, IHORZ)
CALL SETTAB (50, IHORZ)
CALL SETTAB (250, IHORZ)
CALL SETTAB (400, IHORZ)
CALL SETTAB (750, IVERT)
CALL SETTAB (600, IVERT)
CALL SETTAB (500, IVERT)
CALL SETTAB (233, IVERT)
DO 100 IUTAB=1,4
IF (IUTAB.EQ.3) CALL RSTTAB (250, IHORZ)
IF (IUTAB.EQ.3) CALL SETTAB (150, IHORZ)
CALL TABVER (IVERT)
DO 50 IHTAB=1,4
CALL TABHOR (IHORZ)
LTR=64+IHTAB+4*(IUTAB-1)
CALL ANCHO (LTR)
50 CONTINUE
CALL NEWLINE
100 CONTINUE
CALL FINITT (0,0)
END

```

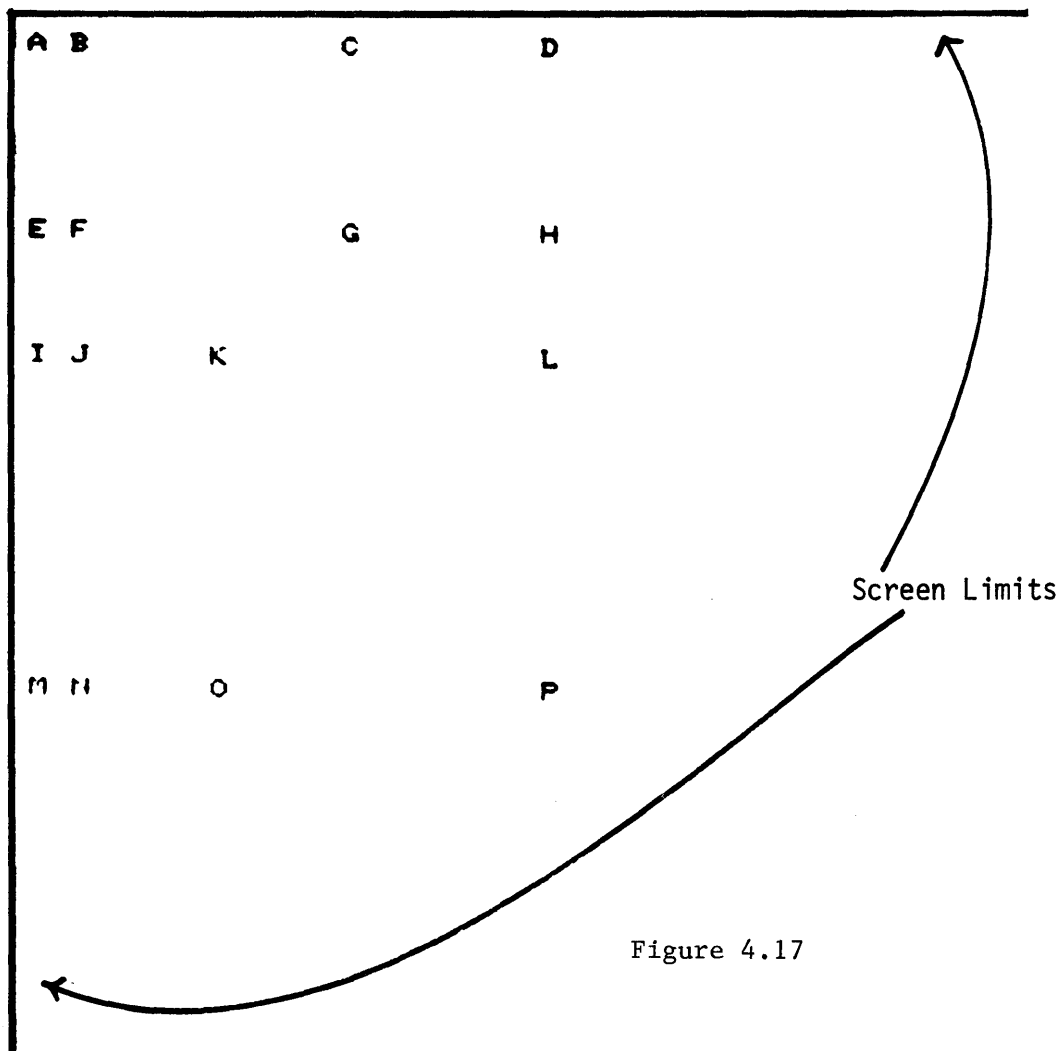

Figure 4.17

*SETTING THE  
MARGINS:*

*Subroutine SETMRG*

4.17.6 This routine sets the left and right margins to be used by Carriage Return (CARTN), HOME, and NEWPAG (see Section 4.4).

CALLING SEQUENCE:

CALL SETMRG (MLEFT, MRIGHT)

Parameters Entered:

MLEFT - the screen coordinate at which a line of alphanumeric output starts. Its value should always be greater than 0 and less than the maximum screen coordinate (1023 or 4095) or the right margin value.

MRIGHT - the screen coordinate at which a line of A/N output ends. Its value should always be greater than MLEFT and less than the maximum screen coordinate (1023 or 4095).

*LEVEL CHECKING:*

*Subroutine TCSLEV*

4.18 This routine returns the last date of modification for the Terminal Control System as well as the level number.

CALLING SEQUENCE:

CALL TCSLEV (LEVEL)

Parameter Returned:

LEVEL - a three element integer array where:

Level 1 = the year of modification.

Level 2 = the julian day.

Level 3 = the level number.



## 5. ROUTINES WHICH SUPPORT THE 4014 or 4015 \* TERMINAL

The following routines specifically support the 4014 Display Terminal and the 4014/15 with the Enhanced Graphics Module.\*\* The Terminal Control System is compatible in its entirety with the 4015/15 Terminal, but the special routines allow the Terminal to utilize its extra capabilities.

The 4014/15 Enhanced Terminals have an addressable range of points from 0 through 4095 on each axis, although its normal range is from 0 through 1023 points. The address character sequences used by both address ranges are compatible with all TEKTRONIX Graphic Display Terminals; however, when using the 4096 range of addressable points on the 4006, 4010, 4012, or 4013 Terminals, the resolution is only to every fourth address point.

That a 4014 or a 4015 is being used, with or without the Enhanced Graphics Module, is specified by the first parameter of Subroutine TERM (Section 5.1).

### *IDENTIFYING THE 4014/15 TERMINAL:*

#### *Subroutine TERM*

5.1 In order to take advantage of the extra features of the TEKTRONIX 4014/15 Terminal, the user must inform the Terminal Control System that he has the capability. He does this by specifying his Terminal with Subroutine TERM. If he does not use TERM before calling 4014/15 routines, the Terminal Control System will treat his Terminal as a 4010 or a 4012/13 Terminal. TERM needs to be called only once, however, after each initialization (i.e., call to INITT).

#### CALLING SEQUENCE:

CALL TERM (ITERM, ISCAL)

#### Parameters Entered:

ITERM - an integer from 0 to 3 where:

0 - indicates 4006-1\*\*\*

1 - indicates 4010, 4012/13

2 - indicates 4014/15

3 - indicates 4014/15 with  
Enhanced Graphics Module

ISCAL - either 1024 (addressable points)  
or 4096 (addressable points)

---

\* The 4015 Terminal and 4013 Terminal offer an APL character set as well as the ASCII character set available on the 4014 and 4012 Terminals. The notation 4014/15 refers to either the 4014 or the 4015 Terminal; the notation 4012/13 refers to either the 4012 or 4013 Terminal.

\*\* The Terminal Control System does not support Special Point Plotting for the Enhanced Graphics Module.

\*\*\* Releases 3.0 to 3.3 of Terminal Control System may require modifications to BAKSP for 4006-1 operation.

MODIFYING THE  
Z-AXIS OF THE  
4014/15 TERMINAL:  
Subroutine CZAXIS

5.2 Vectors on the 4014 or 4015 Terminal cannot only vary in X and Y position; they also vary in brightness and storage properties. This type of variation is called the Z-axis capability. The 4014/15 Terminal has three Z-axis capabilities

Normal Z-Axis - This is the same storage tube mode which is available on the 4010 Terminal. The display is bright and sharp. It is also stored on the screen until it is erased by a call to NEWPAG or ERASE (Sections 4.4 and 4.12). Normal Z-axis is the default mode and is used at all times unless a call to CZAXIS is made.

Defocused Z-Axis - This mode is in all respects similar to normal mode, except that the display is results in broader lines and is slightly brighter.

Enabled Write Through Mode - This mode allows a stored display and refreshed information to coexist on the Terminal screen. For example, the user may wish to display a graph, yet add moving vectors to the original graph. These vectors must be refreshed.

CALLING SEQUENCE:

CALL CZAXIS (ICODE)

Parameter Entered:

ICODE - an integer from 0 through 3 calls the Z-axis mode.

- 0 - normal Z-axis
- 1 - defocused Z-axis
- 2 - enabled write-through mode

*CHANGING THE  
CHARACTER SIZE  
ON THE 4014/15  
TERMINAL:*

*Subroutine CHRISZ*

5.3 The 4014/15 Terminal has four different available character sizes which range from a very small 133 characters per line size to a very large 74 characters per line size. CHRISZ changes both the current character size and the variables associated with the change. The default size is size 1 (see below).

CALLING SEQUENCE:

CALL CHRISZ (ICHAR)

Parameter Entered:

ICHAR - an integer which has one of the following values representing the size of the characters.

<u>CHARACTER SIZE</u>	<u>CHARACTERS/LINE</u>	<u>LINES/PAGE</u>
1	74	35
2	81	38
3	121	58
4	133	64

*MEASURING THE SIZE  
OF A CHARACTER:*

*Subroutine CSIZE*

5.4 CSIZE provides the current character height and width in raster units. The characters are measured in the screen coordinate system in use, either 1024 or 4096. This subroutine is useful for imposing alphanumeric characters on graphic displays, primarily in the case of labeling. It allows the user to see where his label ought to be placed to coincide with grid lines and tic marks. When dealing with the multiple character sizes available on the 4014 Terminal, this routine is especially helpful.

CALLING SEQUENCE:

CALL CSIZE (IHORZ, IVERT)

Parameters Returned:

IHORZ - the horizontal character dimension, including inter-character space; the horizontal distance between two periods.

IVERT - the vertical distance, as above, including interline spacing.

The following example demonstrates a use of CSIZE and CHRISZ. Subroutine ANCHO (Section 4.3) is used to output the alphanumeric character.

```

C * DEMONSTRATION OF CHRSZ AND CSIZE
  CALL INITT (30)
C * USE A SUBROUTINE TO DO THE WORK
  CALL TERM (3,1024)
  CALL SUB1 (0,400,1)
  CALL SUB1 (500,400,2)
  CALL SUB1 (0,0,3)
  CALL SUB1 (500,0,4)
  CALL FINITT (0,0)
  ENL

C * SUBROUTINE TO CHANGE AND MEASURE CHARACTER SIZE
C * AND POSITION OUTPUT
  SUBROUTINE SUB1 (IX,IY,ICHRSZ)
C * SET UP THE MESSAGE ARRAY
  DIMENSION MSG (55)
  DATA MSG /67,72,65,82,65,67,84,69,82,32,83,73,90,69,
&          32,73,83,32,0,0,32,88,32,0,0,32,84,69,75,80,79,73,
&          78,84,83,44,0,0,32,88,32,0,0,32,77,73,78,73,80,79,
&          73,78,84,83,46/
C * DRAW A BOX FOR OUTPUT
  CALL MOVABS (IX,IY)
  CALL DRWRBL (310,0)
  CALL DRWRBL (0,310)
  CALL DRWRBL (-310,0)
  CALL DRWRBL (0,-310)
C * SET AND MEASURE CHARACTER SIZE IN 4096 SPACE
  CALL TERM (3,4096)
  CALL CHRSZ (ICHRSZ)
  CALL CSIZE (IHORZ,IVERT)
  MSG(37)=IHORZ/10+48
  MSG(38)=IHORZ-IHORZ/10*10+48
  MSG(42)=IVERT/10+48
  MSG(43)=IVERT-IVERT/10*10+48
C * SET AND MEASURE CHARACTER SIZE IN 1024 SPACE
  CALL TERM (3,1024)
  CALL CHRSZ (ICHRSZ)
  CALL CSIZE (IHORZ,IVERT)
  MSG(19)=IHORZ/10+48
  MSG(20)=IHORZ-IHORZ/10*10+48
  MSG(24)=IVERT/10+48
  MSG(25)=IVERT-IVERT/10*10+48
C * POSITION AND PUT OUT MESSAGE
  CALL MOVABS (IX,IY)
  CALL MOVREL (20,200)
  DO 100 I=1,15
100  CALL ANCHO (MSG(I))
  CALL ANCHO (ICHRSZ+48)
  I2LNLN=-2*IVERT
  CALL MOVREL (-16*IHORZ,I2LNLN)
  DO 200 I=16,30
200  CALL ANCHO (MSG(I))
  CALL MOVREL (-21*IHORZ,I2LNLN)
  DO 310 I=37,55
310  CALL ANCHO (MSG(I))
  RETURN
  ENL

```



CHARACTER SIZE 1  
IS 14 X 22 TEKPOINTS\*  
56 X 88 MINIPOINTS\*

CHARACTER SIZE 2  
IS 13 X 21 TEKPOINTS  
51 X 83 MINIPOINTS

CHARACTER SIZE 3  
IS 19 X 13 TEKPOINTS  
34 X 53 MINIPOINTS

CHARACTER SIZE 4  
IS 18 X 12 TEKPOINTS.  
31 X 48 MINIPOINTS

Figure 5.4

\* TEKPOINTS means addressable points in 1024 x 1024 space;

\* MINIPOINTS means addressable points in 4096 x 4096 space.

*INCREMENTAL  
PLOTTING:*

*Subroutine INCPLT*

5.5 INCPLT is used to perform incremental plotting. Each incremental plot character will move the beam one raster unit in the given direction. The user specified the direction, whether it is to be visible or invisible and whether he wishes this plot character to be output. The user must have a 4014 or 4015 with the Enhanced Graphics Module and have specified a 4096 grid in his call to TERM (Section 5.1).

CALLING SEQUENCE:

CALL INCPLT (IONOFF, IDIR, NO)

Parameters Entered:

IONOFF      0 = Beam off (invisible)  
             1 = Beam on (visible)

IDIR        Direction Code

NO          the number of times the plot  
             character is to be repeated.

Direction Code:

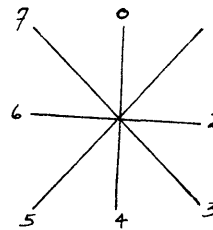
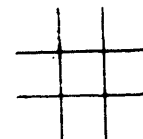

Figure 5.5

Example:

```
CALL INITT (30)
CALL TERM (3,4096)
CALL MOUABS (200,200)
CALL INCPLT (1,0,300)
CALL INCPLT (0,2,100)
CALL INCPLT (1,4,300)
CALL INCPLT (0,1,100)
CALL INCPLT (1,6,300)
CALL INCPLT (0,0,100)
CALL INCPLT (1,2,300)
CALL FINITT (0,0)
END
```



*CHECK TERMINAL*  
*MODES:*  
*Subroutine SEEMOD*

5.6 SEEMOD returns the value of common variables indicating the status of the hardware dashed line type, Z-axis mode, and Terminal mode. (See Sections 3.12 and 5.2).

CALLING SEQUENCE:

CALL SEEMOD (LINE, IZAXIS, MODE)

Parameters Returned:

LINE - the hardware line type in effect

IZAXIS- the hardware Z-axis mode

MODE - the software mode:

Ø = alphanumeric

1 = vector

2 = point plot

3 = incremental plot

4 = dash

*CHECK TERMINAL:*  
*Subroutine SEETRM*

5.7 SEETRM returns the common variables which identify terminal speed, type, character size, and the maximum range of addressable points (4096 or 1024).

CALLING SEQUENCE:

CALL SEETRM (ISPEED, ITERM, ISIZE, MAXSR)

Parameters Returned:

ISPEED - the baud rate in characters per second which has been set in INITT (Section 2.1).

ITERM - the terminal type set in TERM (Section 5.1).

ICSIZE - the character size set in CHRISZ (Section 5.3).

MAXSR - the maximum screen address set in TERM (Section 5.1).



## 6. TRANSFORMATIONS\*

The transformation routines in the Terminal Control System allow the user to define any of three coordinate systems; linear, logarithmic, or polar. The default transformation (LINTRN) is linear, and it remains in effect until one of the transformations is called. LINTRN returns the user to a linear window.

The logarithmic transformation, LOGTRN, allows the user to express data as logarithms with reference to either the X or Y-axis or both.

The polar transformation, POLTRN, allows the user to define his coordinates as radius and degrees.

Each transformation occurs automatically before the drawing of a vector; each remains in effect until another transformation routine is called or until the system is re-initialized.

TRANSFORM: Alter the coordinate system in which data is specified.

Example:

POLTRN	radius, angle	$10,0^\circ$	$10,90^\circ$	$10,180^\circ$
LINTRN	X, Y	$10,0$	$0,10$	$-10,0$

Figure 6, produced by the following codes, draws a grid by means of a user-written subroutine, GRID\*\*; this gridwork is displayed in five different coordinate systems. Grid (a) is linear. Grids (b), (c) and (d) demonstrate the three different types of logarithmic transformations; respectively, they are (log-x, linear-y), linear-x, log-y) and (log-x, log-y). Grid (e) demonstrates a call to the polar transformation, POLTRN. All five grids use the same virtual data. The difference between them is the result of the transformation through which they are viewed.

---

\* The 4010A01 PLOT 10 Terminal Control System, System Manual explains how the user may write his own transformation routines by means of user hooks provided in internal routines of the package.

\*\* See page 55 for the coding of GRID.

```

      CALL INITT(30)
C * DEFINE THE DATA WINDOW
      CALL DWINDO(10.,100.,10.,100.)
C * DEFINE SCREEN WINDOW (A)
      CALL TWINDO(0,250,500,750)
C * DRAW A GRID SHOWING A LINEAR TRANSFORMATION
      CALL GRID
C * DEFINE SCREEN WINDOW (B)
      CALL TWINDO(0,250,0,250)
      CALL LOGTRN(1)
C * DRAW A GRID SHOWING A LOG-X, LINEAR-Y TRANSFORMATION
      CALL GRID
C * DEFINE SCREEN WINDOW (C)
      CALL TWINDO(750,1000,500,750)
      CALL LOGTRN(2)
C * DRAW A GRID SHOWING A LINEAR-X, LOG-Y TRANSFORMATION
      CALL GRID
C * DEFINE SCREEN WINDOW (D)
      CALL TWINDO(750,1000,0,250)
      CALL LOGTRN(3)
C * DRAW A GRID SHOWING A LOG-X, LOG-Y TRANSFORMATION
      CALL GRID
C * DEFINE SCREEN WINDOW (E)
      CALL TWINDO(375,625,250,500)
      CALL POLTEN(10.,100.,0.)
C * DRAW A GRID SHOWING A FOLAR TRANSFORMATION
      CALL GRID
      CALL FINITT (0,0)
      ENL

```

\*

```

C * DRAW A GRID WITH LINES FROM 10 TO 100 AT INTERVALS OF 10
  SUBROUTINE GRID
    LMIN=10.
    DMAX=100.
    X=LMIN
C * DRAW GRID LINES ALONG X-AXIS
    DO 100 I=1,10
      CALL MOVEA(X,LMIN)
      CALL DRAWSA(X,DMAX)
100   X=X+10.
      Y=10.
C * DRAW GRID LINES ALONG Y-AXIS
    DO 200 J=1,10
      CALL MOVEA(DMIN,Y)
      CALL DRAWSA(DMAX,Y)
200   Y=Y+10.
    RETURN
  ENL

```

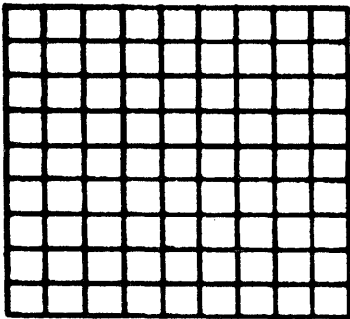

(a)

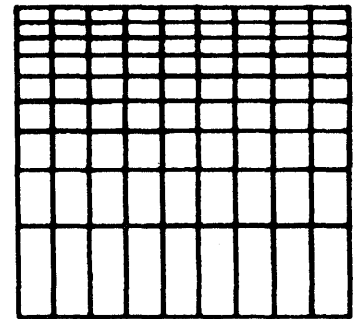

(c)

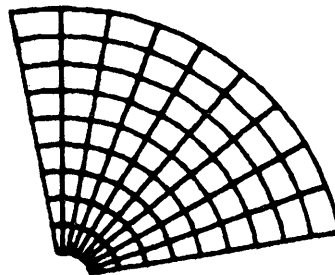

(e)

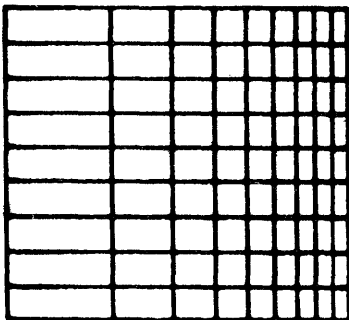

(b)

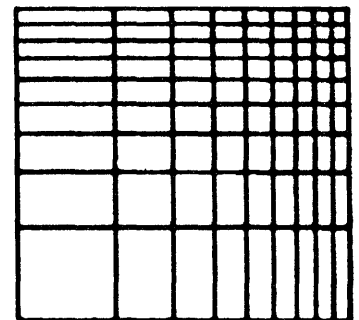

(d)

Figure 6

*THE LINEAR  
TRANSFORMATION:*

*Subroutine LINTRN*

6.1 LINTRN returns a user from either a logarithmic or a polar window and establishes linear scaling. A linear window is assumed for all Terminal Control System routines until log or polar definitions are requested; it is, therefore, not necessary to call LINTRN upon initializing a program.

CALLING SEQUENCE:

CALL LINTRN

*THE LOGARITHMIC  
TRANSFORMATION:*

*Subroutine LOGTRN*

6.2 LOGTRN defines either the X or Y axis or both as logarithmically scaled to fit the user's screen window. The extent of the logarithmic definition is determined by the parameter KEY.

*NOTE*

*If the current data window limits are not positive for an axis defined as logarithmic, that axis will be reset to linear to avoid an invalid transformation.*

CALLING SEQUENCE:

CALL LOGTRN (KEY)

Parameter Entered:

KEY - 1 - x-axis logarithmic  
y-axis linear

2 - x-axis linear  
y-axis logarithmic

3 - x-axis logarithmic  
y-axis logarithmic

*THE POLAR  
TRANSFORMATION:*

*Subroutine POLTRN*

6.3 POLTRN allows the user to define his virtual graphic data to the Terminal Control System in polar coordinates. Polar coordinates are specified by radius and angle. The angle is represented in degrees, counter-clockwise from a horizontal line to the right of the origin. The arguments of POLTRN control the shape of the screen window in which the virtual data is displayed. The virtual window is scaled and transformed to fit into the screen area between



arguments ANGMIN and ANGMAX. The third argument, RSUPRS, is subtracted from the virtual radius. If ANGMIN and ANGMAX do not equal the data window (DWINDOO minimum and maximum (YMIN and YMAX), or if RSUPRS is not equal to zero, a distortion of the virtual polar data will occur (see Figures 6.7 and 6.8). The user can adapt this distortion to emphasize any features he wishes. The polar origin is automatically located to obtain the largest possible display area within the user's screen window.

CALLING SEQUENCE:

CALL POLTRN (ANGMIN, ANGMAX, RSUPRS)

Parameters Entered:

ANGMIN - the minimum angle relative to the horizontal from which the display will appear on the screen.

ANGMAX - the maximum angle relative to the horizontal from which the display will appear on the screen.

RSUPRS - the radius suppression factor.

*DRAWING SEGMENTS  
USING THE POLAR  
TRANSFORMATION:*

*Subroutine DRAWSA*

*Subroutine DRAWSR*

6.4 In order to draw the grid used in (e) of Figure 6, a call to Subroutine DRAWSA was used in the construction of GRID. This call was substituted for a call to DRAWA (Section 3.5). DRAWSA is analogous to DRAWA, except that it enables **the user** to draw the curved line segments that are necessary when a polar transformation is in effect. Subroutine DRAWSR is analogous to DRAWR (Section 3.6), but again it is used for a polar transformation.

CALLING SEQUENCE:

CALL DRAWSA (X, Y)

Where X and Y are the virtual coordinates to which the line segments are drawn.

CALL DRAWSR (X, Y)

Where X and Y are the virtual coordinates relative to the current beam position.

*DRAWING DASHED  
LINE SEGMENTS  
USING THE POLAR  
TRANSFORMATION:*

*Subroutine DASHSA  
Subroutine DASHSR*

6.5 DASHSA and DASHSR are analogous to Subroutines DASHA and DASHR (Section 3.11), respectively. They too are used for a polar transformation.

CALLING SEQUENCES:

CALL DASHSA (X, Y, L)

Where X and Y are the virtual coordinates to which the dashed line segment is to be drawn. L is the dashed line type (see Section 3.12).

CALL DASHSR (X, Y, L)

Where X and Y are the virtual coordinates to which the dashed line is drawn relative to the current beam position. L is the dashed line type. (See Section 3.12).

*SCREEN GRAPHICS  
(Integer Arguments)*

*VIRTUAL GRAPHICS  
(Real Arguments)*

<i>ACTION</i>	<i>ABSOLUTE</i>	<i>RELATIVE</i>	<i>ABSOLUTE</i>	<i>RELATIVE</i>
<i>MOVE</i>	<i>MOVABS</i>	<i>MOVREL</i>	<i>MOVEA</i>	<i>MOVER</i>
<i>DRAW</i>	<i>DRWABS</i>	<i>DRWREL</i>	<i>DRAWA</i>	<i>DRAWR</i>
<i>POINT</i>	<i>PNTABS</i>	<i>PNTREL</i>	<i>POINTA</i>	<i>POINTR</i>
<i>DASH</i>	<i>DSHABS</i>	<i>DSHREL</i>	<i>DASHA</i>	<i>DASHR</i>
<i>SEGMENTED DRAW</i>	<i>none</i>	<i>none</i>	<i>DRAWSA</i>	<i>DRAWSR</i>
<i>SEGMENTED DASH</i>	<i>none</i>	<i>none</i>	<i>DASHSA</i>	<i>DASHSR</i>

TERMINAL CONTROL SYSTEM

DRAWING ROUTINES

Figure 6.5

USING THE POLAR  
TRANSFORMATION:

6.6 Given the polar grid\* (e) of Figure 6, examine the capabilities of Subroutine POLTRN; the first example demonstrates a dashed line segment which connects thirty different radii, with lengths between 90. and 100., at increments of three degrees; they are displayed between an ANGMIN of  $10^\circ$  and an ANGMAX of  $100^\circ$ . Radius suppression is 0.

```

DIMENSION RDATA(30)
DATA RDATA /90.3,92.4,94.5,95.2,96.1,96.9,98.2,98.7,99.1,99.4,
& 99.7,100.0,99.5,99.0,98.5,98.0,97.5,97.0,96.5,96.0,95.5,95.0,
& 94.0,93.0,92.0,93.0,97.0,94.3,91.0,92.8/
CALL INITI (30)
C * DEFINE THE TERMINAL WINDOW
CALL TWINDO(100,900,100,600)
C * DEFINE THE DATA WINDOW WITH RADIUS FROM 10 TO 100
CALL DWINDO(10.,100.,10.,100.)
C * SPECIFY A POLAR WINDOW DISPLAYED BETWEEN 10 AND 100 DEGREES
C * WITH RADIUS SUPPRESSION OF ZERO
CALL POLTRN(10.,100.,0.)
C * DRAW A GRID SHOWING THE WINDOW
CALL GRID
C * PLOT THE DATA STEPPING THE ANGLE FROM 10 TO 100 DEGREES
C * WITH INCREMENT OF 3
CALL MOVEA(RDATA(1),10.)
DO 10 I=1,30
DEGREE=10+I*3
10 CALL DASHSA(RDATA(I),DEGREE,12)
CALL FINITI(0,0)
STOP
END

```

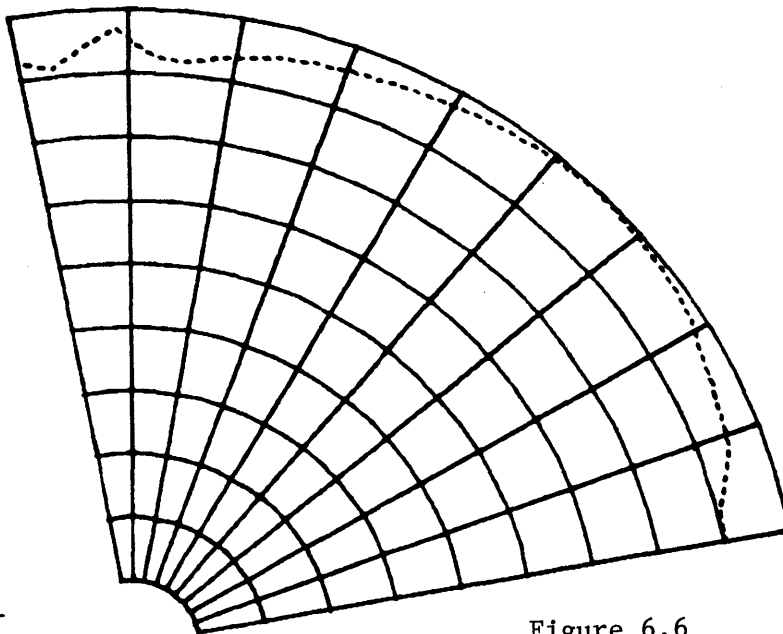

Figure 6.6

\* See page 6-3 for the coding of  
Subroutine GRID.

The second example demonstrates how the same plot would look if it were displayed with a virtual (data) window with a radius between 90. and 100. Again the radius suppression is 0. Notice that all grid lines specified below 90. are clipped.

```

CALL INITT (30) *
C * DEFINE THE TERMINAL WINDOW
  CALL TWINDO(100,900,100,600)
C * DEFINE THE DATA WINDOW WITH RADIUS FROM 90 TO 100
  CALL DWINDO(90.,100.,10.,100.)
C * SPECIFY A POLAR WINDOW DISPLAYED BETWEEN 10 AND 100 DEGREES
C * WITH RADIUS SUPPRESSION OF ZERO
  CALL POLTRN(10.,100.,0.)
C * DRAW A GRID SHOWING THE WINDOW
  CALL GRID
C * PLOT THE DATA STEPPING THE ANGLE FROM 10 TO 100 DEGREES
C * WITH INCREMENT OF 3
  CALL MOVEA(RDATA(1),10.)
  DO 10 I=1,30
    DEGREE=10+I*3
10  CALL DASHSA(RDATA(I),DEGREE,12)
    CALL FINITI(0,0)
  STOP
  END

```

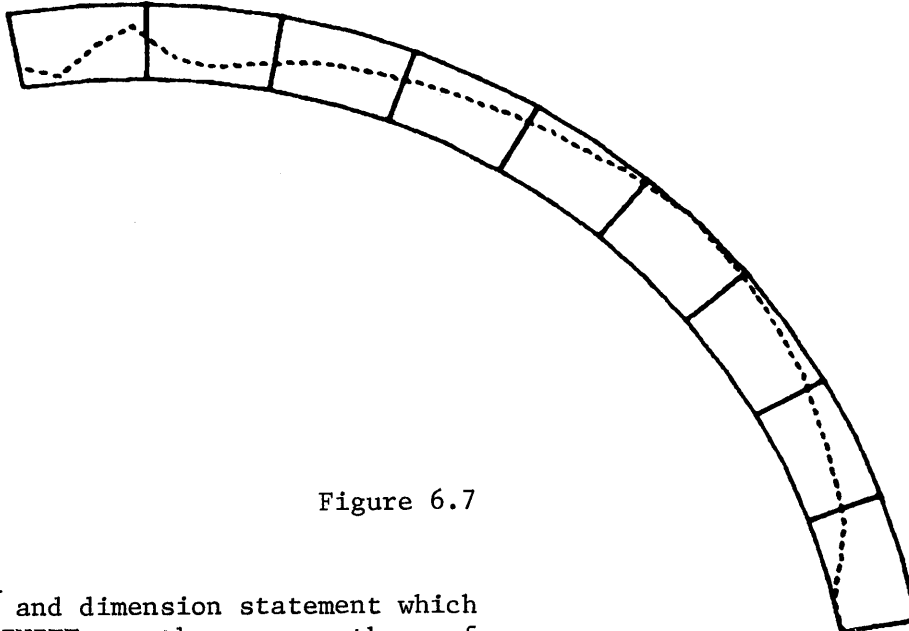

Figure 6.7

\* The data and dimension statement which precede INITT are the same as those of Figure 6.6.

The third example, using the same data points and the same virtual (data) window as those of example 2 (Figure 6.7), demonstrates how the graph is displayed with a radius suppression factor of 90. from each of the thirty radii, causing the data to be displayed between an ANGMIN of  $10^\circ$  and an ANGMAX of  $100^\circ$  and between a radius minimum of 0 and maximum of 10.

```

CALL INITT (30) *
C * DEFINE THE TERMINAL WINDOW
  CALL TWINDO(100,900,100,600)
C * DEFINE THE DATA WINDOW WITH RADIUS FROM 90 TO 100
  CALL DWINDO(90.,100.,10.,100.)
C * SPECIFY A POLAR WINDOW DISPLAYED BETWEEN 10 AND 100 DEGREES
C * WITH RADIUS SUPPRESSION OF 90
  CALL POLTRN(10.,100.,90.)
C * DRAW A GRID SHOWING THE WINDOW
  CALL GRID
C * PLOT THE DATA STEPPING THE ANGLE FROM 10 TO 100 DEGREES
C * WITH INCREMENT OF 3
  CALL MOVEA(RDATA(1),10.)
  DO 10 I=1,30
    DEGREE=10+I*3
10  CALL DASHSA(RDATA(I),DEGREE,12)
    CALL FINITT(0,0)
  STOP
  END

```

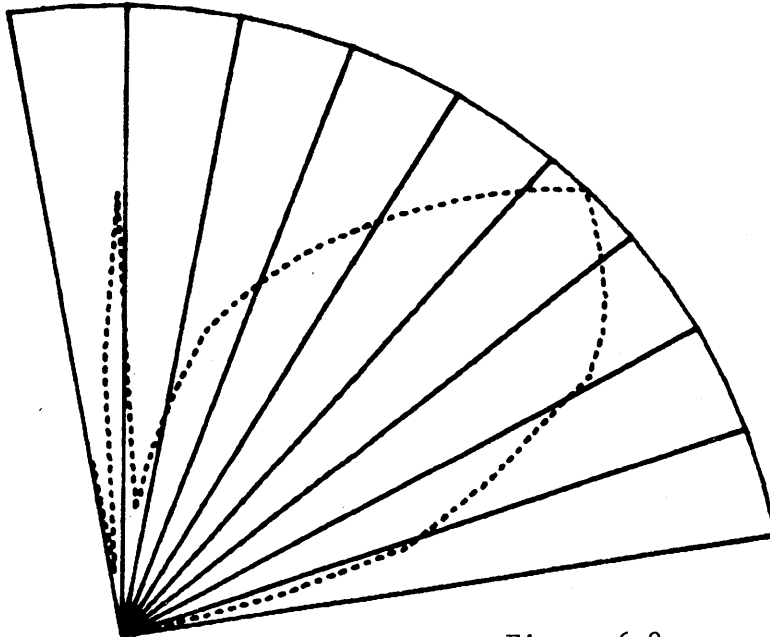

Figure 6.8

\* See note, page 6-8.

The fourth example uses the same information as example 3. In this case, however, the polar window is displayed between an ANGMIN of  $0^\circ$  and an ANGMAX of  $180^\circ$ . Radius suppression is again 90.

```

CALL INITT (30)*
C * DEFINE THE TERMINAL WINDOW
  CALL TWINDO(100,900,100,600)
C * DEFINE THE DATA WINDOW WITH RADIUS FROM 90 TO 100
  CALL LWINDO(90.,100.,10.,100.)
C * SPECIFY A POLAR WINDOW DISPLAYED BETWEEN ZERO AND 180 DEGREES
C * WITH RADIUS SUPPRESSION OF 90
  CALL POLTRN(0.,180.,90.)
C * DRAW A GRID SHOWING THE WINDOW
  CALL GRID
C * PLOT THE DATA STEPPING THE ANGLE FROM 10 TO 100 DEGREES
C * WITH INCREMENT OF 3
  CALL MOVEA(RDATA(1),10.)
  DO 10 I=1,30
    DEGREE=10+I*3
10  CALL DASHSA(RDATA(1),DEGREE,12)
  CALL FINITT(0,0)
  STOP
  END

```

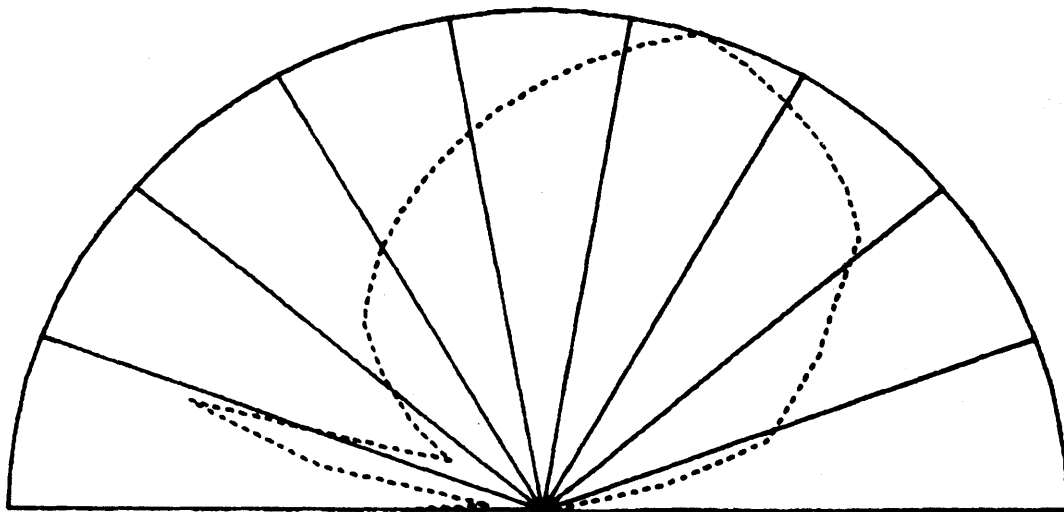

Figure 6.9

\* See note, page 6-8.

## 7. INPUT/OUTPUT ROUTINES

The user's program may perform three types of Input/Output with Terminal Control System subroutines: graphic, alphanumeric, and Terminal/peripheral control. All the output from the package routines is funnelled through the basic subroutine, TOUTST, while all input comes in through subroutine TINSTR. The graphic and control I/O use these two subroutines directly as well as their single character counterparts, TOUPT and TINPUT. Alphanumeric I/O can be accomplished through the more versatile set of routines described below. The user should be aware that some of the following routines may be implementation dependent (see Implementation Notes).

For output the Terminal Control System translates all characters to be sent to the Terminal into ASCII decimal equivalent (ADE)\* form and packs them into an output buffer. When the buffer is full or the system or user calls subroutine TSEND, this buffer is dumped, translated into system dependent code, and sent to the Terminal.

For input the Terminal Control System accepts system dependent code received from the Terminal, translates it into ADE\* (see above) form, and distributes it to the subroutine which called for it, if necessary translating it again into alphanumeric format.

From the point of view of the user's program, alphanumeric I/O may be accomplished more efficiently using direct methods, such as FORTRAN READ and WRITE statements. However, output through the Terminal Control System updates the graphic beam position, except where noted, and allows control over the exact positioning of characters anywhere on the Terminal screen, while input through the Terminal Control System provides correct formatting of data for later output or internal processing. It is the user's responsibility to call ANMODE to dump the output buffer before doing FORTRAN I/O. (See RECOVER, Section 4.11). Positioning of mixed FORTRAN and Terminal Control System output is implementation dependent. See Section 7.11.1 for details.

---

\* ADE code is simply the integer representation of the ASCII character set. The ADE characters are the numbers from 0 to 127, with 48 representing 0, 65 "A", 90 "Z", etc.

Three formats are allowed for both input and output:

1. ADE (ASCII decimal equivalents)\*\*
2. A1 (where A1 represents one word with one alphanumeric character in it)
3. Am (where Am represents one word with m alphanumeric characters in it. M is usually the number of alphanumeric characters that one word can contain)

*OUTPUT:*

*Subroutine TOUTST*

7.1 TOUTST outputs an array of ADE\* characters. This routine does not update the graphic beam position within the Terminal Control System, nor does it put the Terminal in alphanumeric mode. TOUTST should be used only when outputting control characters which are not otherwise handled by the Terminal Control System.

CALLING SEQUENCE:

CALL TOUTST (NCHAR, IARRAY)

Parameters Entered:

NCHAR      the length of IARRAY, i.e., the number of characters to be output.

IARRAY     the array containing ADE characters to be output.

*Subroutine TOUTPT*

7.2 TOUTPT outputs a single ADE\* character. This routine does not update the graphic beam position within the Terminal Control System, nor does it put the Terminal into alphanumeric mode. TOUTPT should be used only when outputting a control character which is not otherwise handled by the Terminal Control System.

CALLING SEQUENCE:

CALL TOUTPT (ICHR)

Parameter Entered:

ICHR        an ADE\* character to be output.

*Subroutine ANCHO*

7.3 ANCHO outputs a single ADE\* character. This routine places the Terminal in alphanumeric mode, outputs the character, and then updates the position of the beam. For a complete description of ANCHO see Section 4.3.

---

\* ADE code is simply the integer representation of the ASCII character set. The ADE characters are the numbers from 0 to 127, with 48 representing 0, 65 "A", 90 "Z", etc.

\*\* An ASCII decimal equivalent chart may be found at the end of this manual.



CALLING SEQUENCE:

CALL ANCHO (ICCHAR)

Parameter Entered:

ICCHAR      the non-control ADE character  
to be output.

*Subroutine*  
*ANSTR*

7.4 ANSTR accomplishes the same function as ANCHO, except that it outputs an array of non-control ADE characters. ANSTR also places the Terminal in alphanumeric mode and updates the graphic beam position within the Terminal Control System. For complete description of ANSTR see Sections 4.3 and 4.3.1.

CALLING SEQUENCE:

CALL ANSTR (NCHAR, IARRAY)

Parameters entered:

NCHAR      the number of characters to  
be output.

IARRAY      the array containing the ASCII  
decimal integer equivalents  
for the characters to be output

*Subroutine*  
*ALOUT*

7.5 ALOUT outputs an array of A1 FORTRAN format characters. This routine puts the Terminal in alphanumeric mode and updates the graphic beam position in the Terminal Control System.

CALLING SEQUENCE:

CALL ALOUT (NCHAR, IARRAY)

Parameters Entered:

NCHAR      the length of IARRAY; the  
number of characters to be  
output.

IARRAY      the array of A1 FORTRAN format  
characters to be output.

*Subroutine*  
*AOUTST*

7.6 AOUTST outputs an array of Am format characters. In this format m represents the number of alphanumeric characters in one word. This routine also updates the graphic beam position in the Terminal Control System.

CALLING SEQUENCE:

CALL AOUTST (NCHAR, IARRAY)

Parameters Entered:

NCHAR            the number of characters to  
                 be output, m times the length  
                 (number of words) of IARRAY.

IARRAY           the array of Am format characters  
                 to be output. If IARRAY is  
                 shorter than NCHAR, it is padded  
                 with blanks.

*INPUT:*

*Subroutine TINSTR*

7.7 TINSTR accepts input from the Terminal and puts it into an ADE array. These character- are in a form ready to be output by ANCHO (Sections 4.3) or ANSTR (Section 4.3.1).

CALLING SEQUENCE:

CALL TINSTR (LEN, IARRAY)

Parameter Entered:

LEN              the number of characters  
                 expected. If fewer than LEN  
                 are received, IARRAY is padded  
                 with blanks, and if more than  
                 LEN are received, the next  
                 call to TINSTR will input the  
                 excess characters.

Parameter Returned:

IARRAY           the ADE array into which the  
                 input characters are placed.

*Subroutine TINPUT*

7.8 TINPUT accepts one ADE character from the Terminal.

CALLING SEQUENCE:

CALL TINPUT (ICHAR)

Parameter Returned:

ICHAR            the ADE character received from  
                 the Terminal. Since TINPUT  
                 calls TINSTR, a null record  
                 (entering only a carriage return  
                 at the Terminal) becomes a  
                 blank, while more than one  
                 character entered is stored for  
                 later access by any call to  
                 TINSTR.

*Subroutine A1IN*

7.9 A1IN accepts an array of characters from the Terminal in integer A1 FORTRAN format. The array is in the correct format to be output by subroutine A1OUT (Section 7.5)

CALLING SEQUENCE:

CALL A1IN (NCHAR, IARRAY)

Parameter Entered:

NCHAR        the number of characters expected from the Terminal. Since A1IN calls TINSTR (Section 7.7) if fewer than NCHAR characters are received, IARRAY is padded with blanks; if more characters than NCHAR are received, they are stored for later access by any call to TINSTR.

Parameter Returned:

IARRAY       the array in which the A1 format characters are placed.

*Subroutine AINST*

7.10 AINST accepts an array of characters from the Terminal in Am format. This array can then be output by subroutine AOUTST (Section 7.6).

CALLING SEQUENCE:

CALL AINST (NCHAR, IARRAY)

Parameter Entered:

NCHAR        the number of characters expected from the Terminal. Since AINST calls TINSTR (Section 7.7), if fewer than NCHAR characters are received, IARRAY is padded with blanks; if more than NCHAR are received, they are stored for later access by any call to TINSTR.

Parameters Received:

IARRAY       the array in which the Am format characters are placed.

*Utility I/O  
Routines*

*Setting the  
Output Buffer  
Format:*

*Subroutine SETBUF*

7.11 The following routines aid the user of the Terminal Control System in outputting or inputting data. These routines, however, should be used carefully and in most cases will not need to be called.

7.11.1 The user will find it necessary to control his output format after implementation of the package only when changing to a different Terminal type (e.g., from a 4010 to a 4014) or when transferring to a different computer system. The output format must be changed in these cases in order to avoid interline character problems (see the Implementation Notes). Interline characters, particularly carriage return (CR), line feed (LF), and timing characters (NUL or SYN), need to be suppressed to make graphic input possible. If the user's implementation doesn't suppress interline characters, the user will need to call SETBUF as well as TERM when changing from a 4010 or 4012 Terminal to a 4014 Terminal.

CALLING SEQUENCE:

CALL SETBUF (KFORM)

Parameter Entered:

KFORM the format of the output buffer, after the following code:\*

- 1 - For 4010 and 4012 Terminals. This format is for systems on which interline characters cannot be suppressed. Characters necessary to generate a move back to the current beam position are stored at the beginning of each buffer. Graphic cursor input is not possible. With buffer Type 1, the move back to the current stored beam position happens before every Terminal Control System buffer output. For example, CALL CHRSTZ (2). CALL ANMODE moves the alphanumeric cursor to the location at which it was after the previous buffer was transmitted. The subsequent system-supplied interline characters may move the cursor to the left and down one line, so any non-Terminal Control System output that follows will begin there.

---

\* The following discussion is important for users who:

- (a) Wish to mix Terminal Control System output with other types of output (e.g., FORTRAN).
- (b) Wish to run programs on different computer systems, or
- (c) Wish to change Terminal types (e.g., from a 4012 to a 4014 Terminal).

- 2 - For 4014 Terminals. This format is for systems on which interline characters cannot be suppressed. Thus interline characters follow each output buffer transmission to the Terminal. However, a flag character (ESC) is sent where necessary, and the 4014 hardware ignores the interline characters. Graphic cursor input is possible. In all other respects Buffer Types 1 and 2 are identical, including their behavior when non-Terminal Control System output is mixed with Terminal Control System output.
- 3 - Used for all Terminals on systems where interline characters may be suppressed. Graphic cursor input is possible. With Buffer Type 3, no carriage returns or other interline characters are appended to Terminal Control System output by the computer. All output begins at the position of the alphanumeric or graphic cursor on the Terminal screen. This position agrees with the stored beam position even after ANMODE or TSEND is called. However, non-Terminal Control System output causes a discrepancy between the stored and the actual beam position.
- 4 - Like Buffer Type 3, except that output is unbuffered; i.e., each call to TOUTST results in direct output.

Example:

A program follows to illustrate the Buffer Type dependent results that occur when FORTRAN and Terminal Control System output are mixed.

*NOTE*

*Buffer types 1 and 2 are not available in the TSO version of the Terminal Control System.*

```

        DIMENSION ITHE(1)
        DATA ITHE/5HTHE /
        CALL INITT(30)
        CALL SETBUF(2)
        CALL TERM(3,1024)
        CALL CHRISZ(1)
        CALL MOVABS(0,450)
        CALL DRWABS(100,450)
        CALL ANMODE
        WRITE(5,100)
100    FORMAT(1X,9HTEKTRONIX)
        CALL CHRISZ(2)
        CALL ANMODE
        WRITE(5,200)
200    FORMAT(1X,15H          4014)
        CALL CHRISZ(3)
        CALL AOUTST(5,ITHE)
        CALL FINITT(0,200)
        END

```

Results with Buffer Types 1 and 2:

```

_____THE
TEKTRONIX 4014

```

Results with Buffer Types 3 and 4:

```

_____TEKTRONIX
THE      4014

```

On this computer system, the FORTRAN WRITE carriage control character "space" (1X) results in a line feed (LF) before FORTRAN output and a carriage return (CR) after output. A carriage return and a line feed follow each Terminal Control System output. On your computer system results of this program may differ from those shown due to different carriage control characters.

Detailed Explanation of the Example:

PROGRAM STEP	PLACEMENT OF OUTPUT	
	Buffer Type 1 and 2	Buffer Type 3 and 4
MOVABS (0,450) DRWABS (100,450) ANMODE WRITE "TEKTRONIX"	Interline characters following ANMODE and the LF preceding "TEKTRONIX" place "TEKTRONIX" two lines below (100,450).	The line feed preceding "TEKTRONIX" places it one line below (100,450).
CHRSIZ (2) ANMODE WRITE "4014"	The software MOVE to (100,450) and similar carriage control characters to the above place "TEKTRONIX" and "4014" on the same line.	The CR following "TEKTRONIX" and the LF preceding "4014" place "4014" beginning at the left margin two lines below (100,450).
CHRSIZ (3) AOUTST (5,ITHE) FINITT	The software MOVE to (100,450 places "THE" there.	The CR following "4014" places "THE" on the same line as "4014" but at the left margin. NOTE: The software assumes the cursor position to agree with the stored beam position. No MOVE to the stored beam position occurs.

*Examine the  
Output Format:*

*Subroutine SEEBUF*

7.11.2 SEEBUF allows the user to examine the format of his output buffer (see SETBUF, Section 7.11.1).

CALLING SEQUENCE:

CALL SEEBUF (JFORM)

Parameter Returned:

JFORM      the output buffer format presently in use. For a 4010 or 4012 Terminal JFORM should return either 1 (for systems which do not allow interline characters to be suppressed) 3, or 4 (for systems where interline characters may be suppressed). For a 4014 Terminal JFORM should return 2, 3 or 4.

*Examining the  
Useable Space  
in the Input  
or Output Buffer:*

*Function LEFTIO*

7.11.3 LEFTIO returns the number of characters remaining in the Input buffer on the amount of space (in characters) remaining in the Output buffer. In cases where the amount of input is variable, for example, the user may wish to see how many characters need to be processed before a given input.

CALLING SEQUENCE:

K=LEFTIO (IBUFF)

Parameter Entered:

IBUFF      indicates which buffer is to be examined.

1    Input buffer

0    Output buffer

Parameter Returned:

K          the number of characters left in the buffer indicated by IBUFF.



*Locating the  
Position of the  
Graphic Beam:  
Subroutine SEELOC*

7.11.4 SEELOC allows the user to locate on the screen the last position of the graphic beam if he has generated output outside the Terminal Control System (e.g., a FORTRAN READ or WRITE or a call to TOUTST or TOUTPT (Sections 7.1 and 7.2, respectively). Thus, he may update the beam position himself.

CALLING SEQUENCE:

CALL SEELOC (IX, IY)

Parameters Returned:

IX            the screen X-coordinate of the beam.

IY            the screen Y-coordinate of the beam.

*Dumping the  
Output Buffer:  
Subroutine TSEND*

7.12 TSEND dumps the output buffer constructed by the Terminal Control System output routines. Whenever the output buffer becomes full, it is transmitted; but TSEND may be called any time the user wishes to have all stored output displayed. (It is customary to call ANMODE, as TSEND may leave the Terminal in graphics mode.)

The positioning on the Terminal screen of non-Terminal Control System output (such as a FORTRAN WRITE) is dependent upon the way in which the software package is implemented on your computer. See Section 7.11.1 for details. If all output is through the Terminal Control System, no such implementation dependencies exist.

CALLING SEQUENCE:

CALL TSEND



APPENDIX A

I. An Advanced Use of the Terminal Control System:  
    Circuit Drawing . . . . . A2

II. Terminal Control System  
    Common Variables . . . . . A7

III. Glossary . . . . . A9

The combination of simple Terminal Control System routines can result in sophisticated usages. The following example demonstrates how the graphic cursor can be used in combination with simple moves and draws to create electrical circuit drawings interactively.

The main program calls the virtual cursor. The user can position it anywhere on the screen and, by punch different Terminal keys, move and draw or call subroutines which draw symbols at that position.

```

C * PROGRAM TO DRAW CIRCUITS INTERACTIVELY
  DATA IDRAW/68/,IMOVE/77/,IERASE/69/,IQUIT/81/,IHCOPY/72/
  DATA IRESIS/82/,ICAP/67/,ITRANS/84/,IGRND/71/
  CALL INITT(30)
C * SET TERMINAL SCREEN WINDOW
  CALL TWINDO(0,1000,0,750)
C * SET VIRTUAL SPACE DATA WINDOW
  CALL DWINDO(0,500,0,375)
  CALL MOUEA(0,0)
C * CALL FOR THE GRAPHIC CURSOR
100  XFROM=XTO
     YFROM=YTO
105  CALL UCURSR(KEY,XTO,YTO)
     IF(KEY NE IDRAW)GO TO 110
     CALL DRAWA(XTO,YTO)
     GO TO 100
110  IF(KEY NE IMOVE)GO TO 120
     CALL MOUEA(XTO,YTO)
     GO TO 100
120  IF(KEY NE IERASE)GO TO 130
     CALL ERASE
     GO TO 105
130  IF(KEY NE IQUIT)GO TO 140
     CALL FINITT(0,0)
140  IF(KEY NE IHCOPY)GO TO 150
     CALL HDCOPY
     GO TO 105
C * DETERMINE ROTATION OF SYMBOL
150  RANGLE=ATAN2(YTO-YFROM,XTO-XFROM)*57.2957795131
     CALL RROTAT(RANGLE)
     IF(KEY NE IRESIS)GO TO 160
     CALL RESIST
     CALL DRAWA(XTO,YTO)
     GO TO 100
160  IF(KEY NE ICAP)GO TO 170
     CALL CAP
     CALL DRAWA(XTO,YTO)
     GO TO 100
170  IF(KEY NE ITRANS)GO TO 180
     CALL TRANS
     CALL MOUEA(XFROM,YFROM)
C * BEAM LEFT AT START POINT FOR TRANSISTOR
     GO TO 105
180  IF(KEY NE IGRND)GO TO 100
     CALL GROUND
     CALL MOUEA(XFROM,YFROM)
C * BEAM LEFT AT START POINT FOR GROUND SYMBOL
     GO TO 105
     END

```

The subprograms draw four different symbols:

<u>Symbol</u>	<u>Keyboard Character</u>
resistor	R
capacitor	C
transistor	T
ground	G

C \* ROUTINE TO DRAW A RESISTOR

```

SUBROUTINE RESIST
CALL DRAWR(10.,0.)
CALL DRAWR(3.,10.)
CALL DRAWR(6.,-20.)
CALL DRAWR(6.,20.)
CALL DRAWR(6.,-20.)
CALL DRAWR(6.,20.)
CALL DRAWR(6.,-20.)
CALL DRAWR(3.,10.)
RETURN
END

```



C \* SUBROUTINE TO DRAW A CAPACITOR

```

SUBROUTINE CAP
CALL DRAWR(10.,0.)
CALL MOVER(0.,20.)
CALL DRAWR(0.,-40.)
CALL MOVER(10.,40.)
CALL DRAWR(0.,-40.)
CALL MOVER(0.,20.)
RETURN
END

```

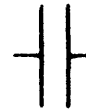

C \* ROUTINE TO DRAW A TRANSISTOR

```

SUBROUTINE TRANS
CALL DRAWR(20.,0.)
CALL DRAWR(0.,20.)
CALL DRAWR(2.,0.)
CALL DRAWR(0.,-40.)
CALL DRAWR(-2.,0.)
CALL DRAWR(0.,20.)
CALL MOVER(2.,10.)
CALL DRAWR(20.,20.)
CALL MOVER(-20.,-40.)
CALL DRAWR(15.,-15.)
CALL DRAWR(2.,2.)
CALL DRAWR(3.,-7.)
CALL DRAWR(-7.,3.)
CALL DRAWR(2.,2.)
CALL MOVER(5.,-5.)
RETURN
END

```

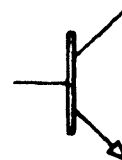

```

C * ROUTINE TO DRAW A GROUND SYMBOL
  SUBROUTINE GROUND
  CALL DRAW(10.,0.)
  CALL MOVER(0.,-16.)
  CALL DRAW(0.,32.)
  CALL MOVER(5.,-27.)
  CALL DRAW(0.,22.)
  CALL MOVER(5.,-17.)
  CALL DRAW(0.,12.)
  CALL MOVER(5.,-7.)
  CALL DRAW(0.,2.)
  RETURN
  END

```



Examples of circuits which can be drawn using the above program:

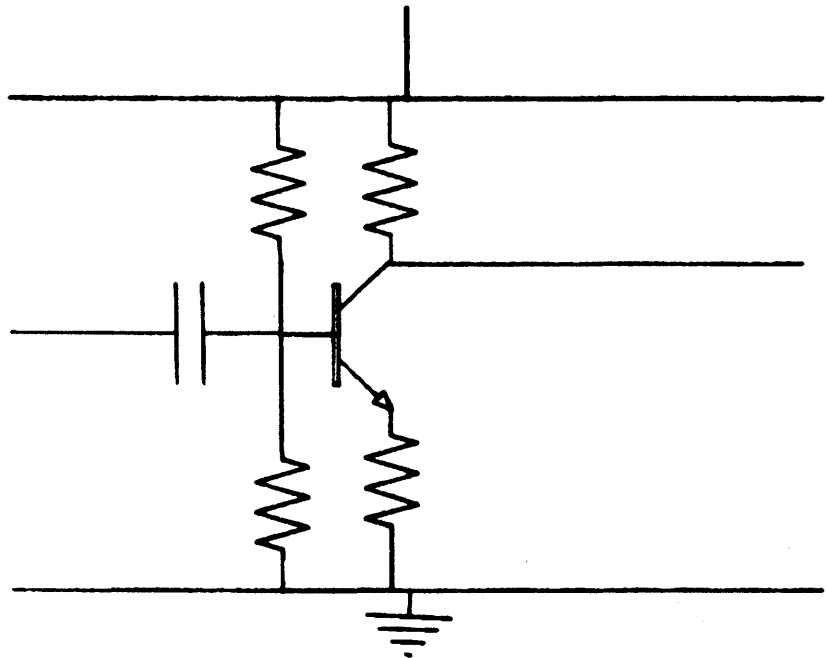

A transistor amplifier

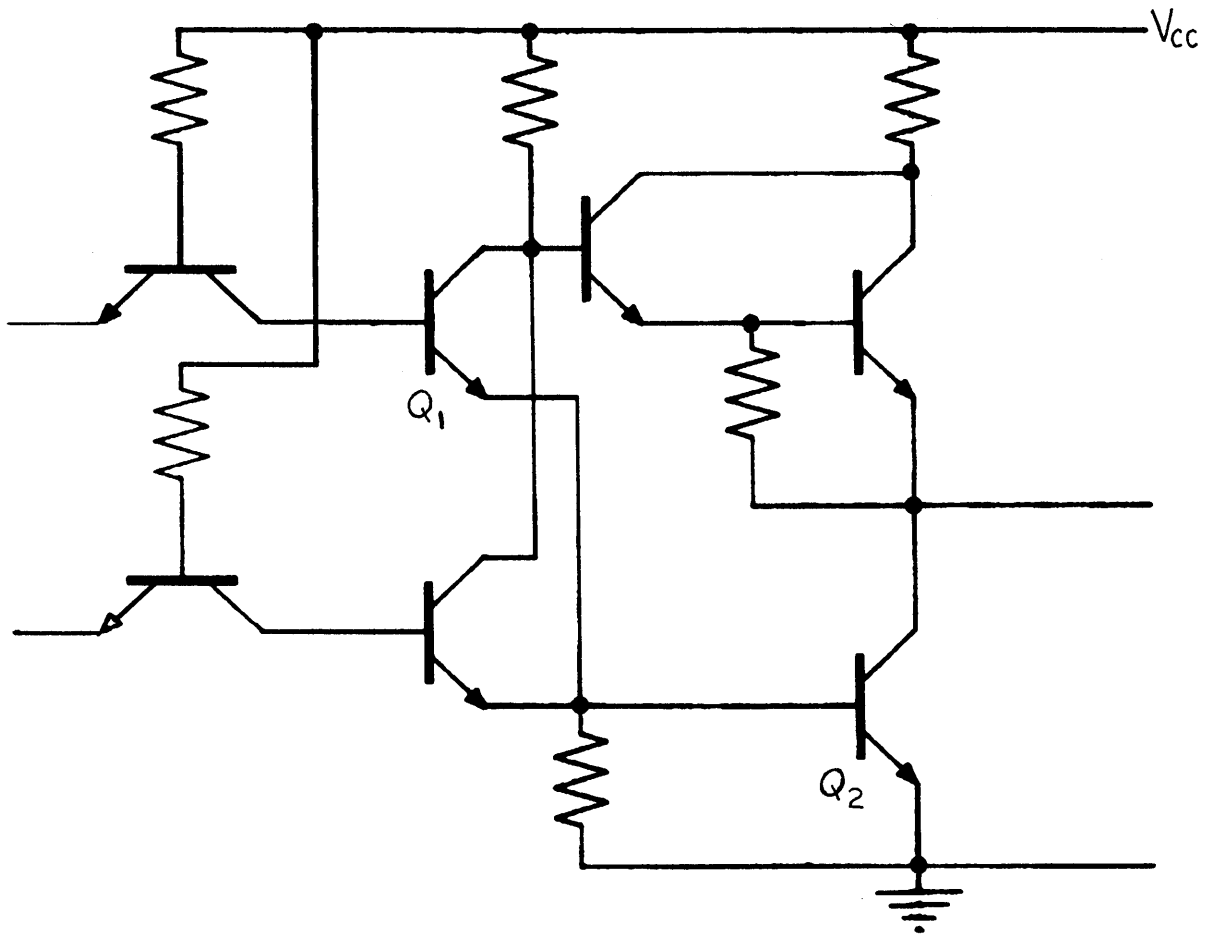

A logic gate

## II. TERMINAL CONTROL SYSTEM COMMON VARIABLES

All functions and subroutines which required users of earliest releases (Release 2.0 and 2.1) of the Terminal Control System to access the /TKTRNX/ common area are now supported by routines; therefore, conversion of programs which used earliest releases TCS is fairly simple. The conversion consists of deleting the /TKTRNX/ common area from these programs and changing the code lines which set the common variables, so that the appropriate subroutines are called, as follows:

<u>Variables in /TKTRNX/ common</u>	<u>Subroutines in Release 3 or Level 1</u>
TRSINF, TRCOSF	RROTAT
TRSCAL	RSCALE
KLMRGN, KRMRGN	SETMRG

The tab routines are now somewhat different than in earliest versions (Release 2.0 or 2.1) in that no tab tables are provided in the common area. The user must insert a dimension statement for KHORZT and KVERTT in his older programs using the tab routines.

A list of TCS common variables follows.



VARIABLE NAMES IN ALPHABETICAL ORDER

<u>Name</u>	<u>Use</u>	<u>Description</u>
KBAUDR	General	Characters per Second
KBEAMX	Screen Graphics	Beam X-coordinate
KBEAMY	Screen Graphics	Beam Y-coordinate
KDASHT	Virtual Graphics	Dash Specification
KEYCON	Virtual Graphics	Transformation Key
KFACTR	Screen Graphics	Addressing Factor
KGNFLG	General	General Error Flag
KGRAFL	General	Graphic Level Flag
KHOMY	General	Home Y-Value
KHORSZ	A/N	Character Horizontal Size
KINLFT	I/O	Characters Left in Input Buffer
KKMODE	General	Mode
KLINE	Graphics	Vector Type
KLMRGN	A/N	Left Margin
KMAXSX	Virtual Graphics	Screen Window Maximum X
KMAXSY	Virtual Graphics	Screen Window Maximum Y
KMINSX	Virtual Graphics	Screen Window Minimum X
KMINSY	Virtual Graphics	Screen Window Minimum Y
KMOFLG	Unused	Future Expansion
KMOVEF	Screen Graphics	Move Flag
KOTLFT	I/O	Characters Left in Output Buffer
KPAD2	General	Padding Size
KPCHAR	Screen Graphics	Previous Plot Characters
KRMRGN	A/N	Right Margin
KSIZEF	A/N	Character Size
KTBLSZ	A/N	Tab Table Size
KTERM	General	Type of Terminal
KUNIT	I/O	Output Buffer Format
KVERSZ	A/N	Character Vertical Size
KZAXIS	General	Vector Intensity
TIMAGX	Virtual Graphics	Imaginary Beam X
TIMAGY	Virtual Graphics	Imaginary Beam Y
TMAXVX	Virtual Graphics	Virtual Window Maximum X
TMAXVY	Virtual Graphics	Virtual Window Maximum Y
TMINVX	Virtual Graphics	Virtual Window Minimum X
TMINVY	Virtual Graphics	Virtual Window Minimum Y
TRCOSF	Virtual Graphics	Relative Vector Cosine Factor
TREALX	Virtual Graphics	Real Beam X
TREALY	Virtual Graphics	Real Beam Y
TRFACX	Virtual Graphics	Transformation Parameter
TRFACY	Virtual Graphics	Transformation Parameter
TRPAR1	Virtual Graphics	Transformation Parameter
⋮	⋮	⋮
TRPAR6	Virtual Graphics	Transformation Parameter
TRSCAL	Virtual Graphics	Relative Vector Scale Factor
TRSINF	Virtual Graphics	Relative Vector Sine Factor

### III. TERMINAL CONTROL SYSTEM

#### Glossary

<i>ABSOLUTE VECTOR</i>	A directed line segment from a given starting point to a given end point. In screen graphics, the start point is defined by the beam position, and the end point is an absolute screen coordinate. In virtual graphics the start point is the virtual beam position and the end point is an absolute virtual coordinate.
<i>ADE</i>	ASCII decimal equivalent. The integer representation of the ASCII character set. (See ASCII Code Chart.)
<i>ALPHANUMERIC CURSOR</i>	A rectangular, non-stored, moveable marker which indicates the next position at which a character will be displayed.
<i>ALPHANUMERIC MODE</i>	The Terminal mode in which ASCII output will be interpreted as characters to be displayed.
<i>A/N</i>	Abbreviation for "alphanumeric."
<i>ASCII</i>	American Standard Code for Information Interchange: A standard code consisting of 7-bit elements for information interchange among data processing communications systems.
<i>BUFFERING</i>	Storing input or output in an array (in the Terminal Control System an array of 72 characters) which is transmitted or dumped when it is full or when a command to dump is given.
<i>CLIPPING</i>	The modification of virtual graphics vectors so that the portion of those vectors which lies outside of the virtual window will not be displayed on the screen.
<i>COORDINATE</i>	An ordered pair (X, Y) of numbers uniquely represent a point either on the screen or in virtual space. The ordered pair of numbers used in the normal coordinate system (Cartesian coordinates) represent the point according to its distance from the origin (0,0) along the X and Y-axis respectively.
<i>CURSOR</i>	A moveable marker used as a reference.

*DEFOCUS MODE* Causes broader lines in the screen display; for the 4014/15 Terminal.

*DRAW* The display command which causes a bright vector to appear.

*ERASE* The procedure of clearing the Terminal screen.

*GRAPHIC CURSOR* A cross-hair cursor used to specify positional input. Not available on the 4006-1.

*HARDCOPY* A permanent copy of a display on the Terminal screen which is made by a remote hardcopy unit.

*HOME POSITION* The upper-left corner screen location at which the first character of a page is normally printed.

*INPUT* Data sent from the Terminal to the computer. Also, data provided to a subroutine.

*KEYBOARD* The portion of the Terminal which allows the user to enter A/N data into the computer.

*LEFT MARGIN* The screen X-coordinate which represents the starting position of a line of alphanumeric output.

*LEVEL, RELEASE* TCS was available in Releases 2.0 and 2.1, 3.0 to 3.3 and Level 1 at the date of this printing.

*MOVE* The display command which causes a dark vector to be drawn.

*NEW LINE* The operation which causes the alphanumeric cursor to go to the left margin and down one line.

*NEW PAGE* The operation which erases the screen and moves the alphanumeric cursor to the HOME position.

*ORIGIN* The coordinate represented by  $(\emptyset, \emptyset)$ . The origin of the screen is located at the lower-left corner. Virtual space, by definition, has its origin at its center.

*POINT* The display command which causes a point to be drawn.

*RASTER UNIT* The distance between two adjacent points on the screen; the basic resolution element of the Terminal.

*REFRESH* To renew a display. If a Terminal (i.e., a 4014/15 Terminal) is in non-store mode, this display must be refreshed by the user's program to remain visible.

*RELATIVE VECTOR* A means of describing an absolute vector which is drawn relative to the current beam position.

*RIGHT MARGIN* The screen X-coordinate which represents the rightmost limit of alphanumeric output. Any attempt to write to the screen beyond the right margin using an A/N output routine will cause a NEW LINE to be generated.

*SCREEN* The portion of the Terminal on which output from the computer is displayed.

*SCREEN COORDINATES* The set of points which constitutes the screen. These points form a discrete two-dimensional space and range from (0,0) to (1023, 1023) inclusive; the 4014/15 Terminal with Enhanced Graphic Module offers in addition a range from (0,0) to (4095 to 4095) inclusive. SCREEN COORDINATES MUST ALWAYS BE INTEGERS.

*SCREEN WINDOW* The section of the screen into which the virtual window is scaled and translated.

*SOFTWARE* The programs and routines used to operate a computer.

*STORAGE BEAM* The electron beam which is directed by the output to draw characters and vectors on the Terminal Screen

*STORAGE TUBE* A cathode ray tube (CRT) which will maintain a display, once written, for an indefinite period until an erasure is made.

*TERMINAL* A console which accepts data from or sends data to a computer. The term is used here with reference to a TEKTRONIX 4006-1, 4010, 4012/13 or 4014/15 Display Terminal.

<i>TERMINAL STATUS</i>	The current state of the Terminal.
<i>TERMINAL STATUS AREA</i>	The set of common variables which represent the current Terminal status.
<i>TIMESHARING</i>	The use of a computer to serve a number of individuals in an essentially simultaneous fashion. Communication with a timesharing computer is usually through an interactive terminal.
<i>TRANSFORMATION</i>	The relationship between the virtual and screen windows. It may include a scaling, a translation, and/or a change of coordinate systems.
<i>USER COORDINATES</i>	A coordinate system in which the units of measurement are defined by the user. See virtual Coordinates.
<i>VECTOR</i>	A line segment. A vector may be either bright (visible) or dark (invisible). The former is generated by a DRAW routine, the latter by a MOVE routine.
<i>VIRTUAL COORDINATES</i>	The set of points which constitute virtual space.
<i>VIRTUAL CURSOR</i>	Allows the user to locate coordinates in virtual space with the graphic cursor.
<i>VIRTUAL SPACE</i>	A user-defined, data-structured display area which is Terminal independent.
<i>VIRTUAL WINDOW</i>	The portion of virtual space which is displayed in the Terminal area defined by the screen window. Only that portion of virtual space which is contained in the virtual window will be displayed.
<i>WRITE-THROUGH MODE</i>	Allows refreshed information to be displayed along with stored information on the 4014/15 Terminal.
<i>Z-AXIS</i>	Allows variations in the storage and brightness capabilities on the 4014/15 Terminal.



APPENDIX B

OPTION 22 USERS' INSTRUCTIONS

Option 22 (supported in TCS only with implementation for IBM 360/370) is the Tektronix 2741 Correspondence Code Interface. Its purpose is to allow communication between Tektronix 4010 family computer display terminals and IBM computer systems or other systems with 2741 ports. 4010 family terminals with Option 22 provide extended capabilities of graphics and faster alphanumerics through 2741 ports.

There are two important points to be aware of when operating with an Option 22 interface.

#### SET I/O BUFFER SIZE

In order for the FORTRAN routines ADEIN and ADEOUT to transmit data through an Option 22 interface, an encoding and decoding process is necessary. The TCS user need not be concerned with this encoding and decoding process except for its effect on the buffer size.

TCS for IBM 360/370 has been changed to accommodate a buffer size of 89 characters. This change was made because the encoding scheme for Option 22 results in some message overhead, decreasing the effective buffer size from 132 characters to 89. Or, to put it the other way, an 89 character data message when encoded becomes a 132 character message.

Because of this characteristic, the user must specifically set the input buffer size to 132 characters at the beginning of each session. The following TSO CLIST is an example:

```
FREE ATTR(IN) FILE(FT05F001,FT06F001)
ATTRIBUTE IN BLKSIZE(132) LRECL(132) RECFM(F)
ALLOCATE DATASET(*) FILE(FT06F001) USING(IN)
ALLOCATE DATASET(*) FILE(FT05F001) USING(IN)
```

When the encoding process occurs, an 89 character message will be expanded to 132 characters and the buffer will work properly.

#### NON-ENCODED COMMUNICATION

It will also be important to know how to communicate through the interface in non-encoded mode. Upon power up the terminal communicates in straight 2741 correspondence, without encoding.

However TCS output and input received from the Option 22 interface will default to the encoded message mode. The user may exit from the encoded message input mode with a call to ANMODE, and the Option 22 will respond in non-encoded mode until a TCS input routine is called. The user's call to FINITT at the close of a session also returns the system to non-encoded mode. The ability of Option 22 to respond in either mode is important when mixing your own FORTRAN with TCS I/O.



## I. SUBROUTINE AND FUNCTION INDEX

	<u>PAGE</u>
ANCHO (ICHAR)	4-1
ANMODE	4-1
BAKSP	4-3
BELL	4-11
CARTN	4-3
Csize (IHORZ, IVERT)	5-3
DASHA (X, Y, L)	3-13
DASHR (X, Y, L)	3-13
DCURSR (ICHAR, IX, IY)	4-3
DRAWA (X, Y)	3-5
DRAWR (X, Y)	3-7
DRWABS (IX, IY)	2-3
DRWREL (IX, IY)	2-4
DSHABS (IX, IY, L)	3-13
DSHREL (IX, IY, L)	3-13
ERASE	4-11
FINITT (IX, IY)	2-2
HDCOPY	4-11
HOME	4-3
INITT (IBAUD)	2-1
KCM (RCM)	4-13
KIN (RI)	4-13
LINEF	4-2
MOVABS (IX, IY)	2-2
MOVEA (X, Y)	3-5
MOVER (X, Y)	3-7
MOVREL (IX, IY)	2-4
NEWLIN	4-2
NEWPAG	4-3
PNTABS (IX, IY)	2-4
PNTREL (IX, IY)	2-4
POINTA (X, Y)	3-5
POINTR (X, Y)	3-7
RESTAT (RARRAY)	4-7
SVSTAT (RARRAY)	4-7
SWINDO (MINX, LENX, MINY, LENY)	3-8
TINPUT (ICHAR)	7-4
TOUTPT (ICHAR)	7-2
VCURSR (ICHAR, X, Y)	4-5
VWINDO (XMIN, XRANGE, YMIN, YRANGE)	3-4
ALIN (NCHAR, IARRAY)	7-5
ALOUT (NCHAR, IARRAY)	7-3
AINST (NCHAR, IARRAY)	7-5
ANSTR (NCHAR, IARRAY)	7-3
AOUTST (NCHAR, IARRAY)	7-3
CHRSIZ (ICHAR)	5-3
CZAXIS (CODE)	5-2
DASHSA (X, Y, L)	6-6

DASHSR (X, Y, L)	6-6
DRAWSA (X, Y)	6-5
DRAWSR (X, Y)	6-5
DWINDO (XMIN, XMAX, YMIN, YMAX)	3-4
INCPLT (IONOFF, IDIR, NO)	5-6
LEFTIO (IBUFF)	7-10
LINHGT (NUMLIN)	4-14
LINTRN	6-4
LINWDT (NUMCHR)	4-14
LOGTRN (KEY)	6-4
POLTRN (ANGMIN, ANGMAX, RSPRS)	6-4
RECOVR	4-11
RESET	4-11
RROTAT (DEG)	4-9
RSCALE (FACTOR)	4-9
RSTTAB (ITAB, ITBTBL)	4-16
SCURSR (ICHAR, IX, IY)	4-3
SEEBUF (KFORM)	7-10
SEEDW (XMIN, XMAX, YMIN, YMAX)	4-12
SEELOC (IX, IY)	7-11
SEEMOD (LINE, IZAXIS, MODE)	5-7
SEEREL (RCOS, RSIN, SCALE)	4-12
SEETRM (ISPEED, ITERM, ISIZE, MAXSR)	5-7
SEETRN (XFAC, YFAC, KEY)	4-12
SEETW (MINX, MAXX, MINY, MAXY)	4-12
SETBUF (KFORM)	7-6
SETMRG (MLEFT, MRIGHT)	4-19
SETTAB (ITAB, ITBTBL)	4-15
TABHOR (ITBTBL)	4-16
TABVER (ITBTBL)	4-17
TCSLEV (LEVEL)	4-19
TERM (ITERM, ISCAL)	5-1
TINSTR (LEN, IARRAY)	7-4
TOUTST (NCHAR, IARRAY)	7-2
TTBLSZ (ITBLSZ)	4-15
TWINDO (MINX, MAXX, MINY, MAXY)	3-8

## II. SUBJECT INDEX

Al Output . . . . .	7-3
Al Input . . . . .	7-5
AM Output . . . . .	7-3
Absolute Line Drawing . . . . .	2-2, 3-5
Alphanumeric Output . . . . .	4-1, 7-2
A/N Character Handling . . . . .	4-2, 7-2
A/N Character Output . . . . .	4-1, 7-2
A/N Mode . . . . .	4-1, 7-2
A/N String Output . . . . .	4-2, 7-3
ASCII Input . . . . .	7-4
Bell . . . . .	4-11
Buffer Types . . . . .	7-6, 7-10
Changing Character Size . . . . .	5-3
Check the Terminal Mode . . . . .	5-7
Check the Terminal Status . . . . .	5-7
Circuit Drawing . . . . .	7-7
Clipping in Virtual Space . . . . .	3-10
Conversion of Centimeters to Screen Units . . . . .	4-13
Conversion of Inches to Screen Units . . . . .	4-13
Cursor . . . . .	4-3, 4-5
Dashed Lines . . . . .	3-13, 6-6
Dashed Line Specifications . . . . .	3-13
Drawing:	
Absolute . . . . .	2-2, 3-5
Relative . . . . .	2-4, 3-7
Dashed Lines . . . . .	3-13
Segmented Lines (Polar) . . . . .	6-5
Segmented Dashed Lines . . . . .	6-6
Hardcopying . . . . .	4-11
Horizontal Tab . . . . .	4-16
Identifying the Terminal . . . . .	5-1
Incremental Plotting . . . . .	5-6
Initialization . . . . .	2-1
Input . . . . .	7-4
Interchangeability of Virtual and Screen Graphics . . . . .	3-11
Line Drawing . . . . .	2-4
Line Height . . . . .	4-14, 3-5
Line Width . . . . .	4-14
Linear Transformation . . . . .	6-4
Logarithmic Transformation . . . . .	6-4

Margins . . . . .	4-19
Measuring the Height of Lines . . . . .	4-14
Measuring the Size of Characters . . . . .	5-3
Measuring the Width of Lines . . . . .	4-14
Miscellaneous Utility Routines . . . . .	4-11
Modifying the Z-axis . . . . .	5-2
Output . . . . .	7-1, 2, 3
Polar Transformation . . . . .	6-4, 6-10
Relative Drawing . . . . .	2-4, 3-7
Removing a Tab . . . . .	4-16
Rescaling a Graphic Output . . . . .	4-9
Rotating a Graphic Output . . . . .	4-9
Scaling . . . . .	3-8
Screen Cursor . . . . .	4-3
Screen Graphics . . . . .	3-1, 3-8, 3-11
Screen Window . . . . .	3-8
Setting the Tab . . . . .	4-15
Tabs . . . . .	4-15, 4-17
Tab Setting . . . . .	4-15
TEKTRONIX Terminals . . . . .	1-2
Terminal Control System Overview . . . . .	1-2
Terminal Status Area . . . . .	4-7
Transformations . . . . .	Sec. 6
Utility Routines . . . . .	4-11
Utility I/O Routines . . . . .	7-6, 7-7
Virtual Cursor . . . . .	4-5
Virtual Graphics . . . . .	3-1, 3-7
Virtual Window . . . . .	3-4

# ASCII CODE CHART

CONTROL				HIGH X & Y GRAPHIC INPUT		LOW X		LOW Y							
NUL	∅	DLE	16	SP	32	∅	48	Ⓐ	64	P	8∅	\	96	p	112
SOH	1	DC1	17	!	33	1	49	A	65	Q	81	a	97	q	113
STX	2	DC2	18	"	34	2	5∅	B	66	R	82	b	98	r	114
ETX	3	DC3	19	#	35	3	51	C	67	S	83	c	99	s	115
EOT	4	DC4	2∅	\$	36	4	52	D	68	T	84	d	1∅∅	t	116
ENQ	5	NAK	21	%	37	5	53	E	69	U	85	e	1∅1	u	117
ACK	6	SYN	22	&	38	6	54	F	7∅	V	86	f	1∅2	v	118
BEL	7	ETB	23	'	39	7	55	G	71	W	87	g	1∅3	w	119
BELL				(	4∅	8	56	H	72	X	88	h	1∅4	x	12∅
BS	8	CAN	24	BACK SPACE											
HT	9	EM	25	)	41	9	57	I	73	Y	89	i	1∅5	y	121
LF	1∅	SUB	26	*	42	:	58	J	74	Z	9∅	j	1∅6	z	122
LINE FEED															
VT	11	ESC	27	+	43	;	59	K	75	[	91	k	1∅7	{	123
FF	12	FS	28	,	44	<	6∅	L	76	\	92	l	1∅8	;	124
CR	13	GS	29	-	45	=	61	M	77	]	93	m	1∅9	}	125
RETURN															
SO	14	RS	3∅	•	46	>	62	N	78	^	94	n	11∅	~	126
SI	15	US	31	/	47	?	63	O	79	_	95	o	111		127
															RUBOUT (DEL)