

LAP-30

ROYAL PRECISION ELECTRONIC DIGITAL COMPUTER

OPERATIONS MANUAL

ROYAL MCBEE CORPORATION • *data processing division*

PURPOSE:

This manual describes the operation of the LGP-30 Digital Computer. It is intended for the reader who has some knowledge of computer techniques but wishes to know just how the LGP-30 operates.

The success of the desk-size digital computer is attributed to its wide range of applications. It makes it possible for small business operation to use automatic data processing techniques economically; to operate as larger computing installations with less "waiting time" and consequently quicker evaluation. It can be used in conjunction with large scale installations or in place of large scale installations where the latter are not economically justified.

When used with large scale computers, it serves to eliminate the bottleneck by decentralizing operation. The LGP-30 makes it possible to quickly evaluate trial ideas associated with more complex engineering designs, before putting the over-all problem on the larger computer.

When used alone, it permits the smaller company to obtain realistic answers to problems quickly and reduces the lengthy manual calculations from man-weeks to a few man-hours.

For the first time small business can justify the cost of the computer since it may be operated with no additional electrical service, ventilation, or cooling and requires a minimum of floor space.

TABLE OF CONTENTS

	PAGE NO.
I General Characteristics	
Components	3
Input-Output Device	3
Word Structure	3
II Addressing System	
Track and sector	3
Homogeneous Memory	4
III Computing Unit	
Registers	4
Flow of Information	4
IV Control Panel	
Oscilloscope	4
Control Buttons	5
Power	5
Operate	5
Mode	5
Operation Buttons	5
Breakpoint Switches	5
6-Bit Input	5
V Operation Codes	
Arithmetic	
Bring, Add, Subtract, Hold, Clear	6
Extract, Divide	6
Multiply	6
Note: Debugging Program	6
Logic	
Store Address	6
Return Address	6
Unconditional Transfer	6
Test	7
Stop	7
Input — Output	7
Print	7
Input	7
VI Input — Output Components	
Tape Typewriter	8
Controls	8
Operation	8
Output	8
Input	9
Photoelectric Reader & Punch	9
Manual Controls	9
Operation of Reader	10
Operation of Tape Punch	10
Operation with Computer	10
VII Timing and Optimizing	
LGP-30 Design	11
Timing on Input	11
Timing on Output	12
Appendix A	
Computer Codes on Tape Typewriter	13
Appendix B	
Scaling	14
Powers of 2 Table	15

LGP-30
THE ROYAL PRECISION
DIGITAL
COMPUTER



General Characteristics

THE LGP-30 is a desk-size, stored program computer. It has a medium-scale capacity and uses a single address system. The LGP-30 has all the advantage of high component reliability, automatic operation, compact design,

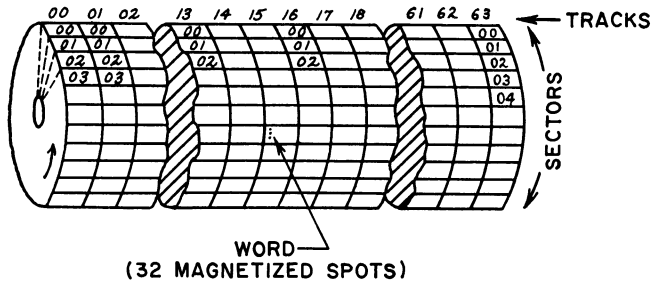

FIGURE 1. Magnetic Drum; 4096 Word Memory

and ease of programming. Because of its great flexibility, the LGP-30 serves the needs of accounting, engineering, and scientific computing fields in a most efficient manner.

Components

The three basic components of a computer memory unit, arithmetic unit, and control unit are assembled in one desk-size housing in the LGP-30. The main memory of 4096 words is a magnetic drum, see figure 1, which rotates at 4000 revolutions per minute, thus making possible a maximum access time of 15 milliseconds. The memory is arranged on the drum on 64 tracks, each

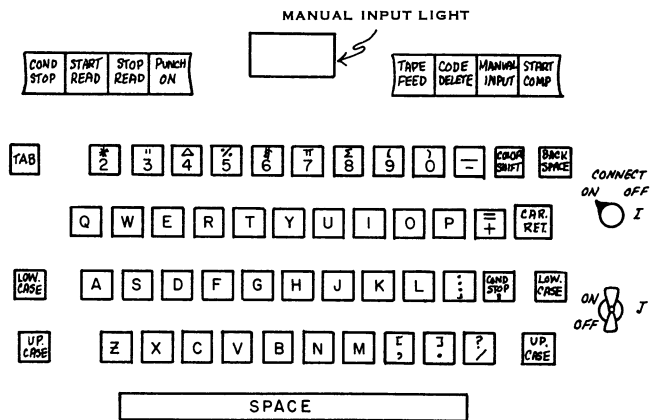

FIGURE 2. Standard Keyboard of Tape Typewriter

track containing 64 sectors. Punched paper tape is the permanent file of information for the LGP-30. The interlace pattern of sectors on each track of the drum makes for shorter access time. The drum will retain its memory when power has been turned off.

Input-Output Device

The primary input-output device to the LGP-30 is a Tape Typewriter. It has a standard typewriter keyboard and control switches, as shown in Figure 2, and a paper tape reader and punch which are integral parts of the input-output unit.

Input information to the LGP-30 is transmitted from the Tape Typewriter or from the paper tape reader on the typewriter.

Output information from the LGP-30 is recorded on the typewriter or the typewriter and paper tape punch simultaneously. Maximum typewriter speed for input and output is 10 characters per second. Higher speed input and output devices are available, such as a photoelectric reader which reads input at 200 characters per second and an output device which punches 20 characters per second.

One of the primary considerations in designing the LGP-30 was to minimize the number of components, thus increasing its reliability and limiting its size and cost. The computer is internally binary. Many components in the LGP-30 are used on a time-sharing basis. Input-Output is normally decimal with the LGP-30 doing the binary conversion during input and output time.

Programs are usually punched on a tape by means of the Tape Typewriter and then read into the computer. However, the LGP-30 may be stopped at any time, to enter information manually from the Tape Typewriter.

Word Structure

The basic unit of information is defined as a word. The LGP-30 word contains 30 binary bits plus a sign bit and spacer bit. The 30 binary bits and sign position may be recorded as "0" or "1" on the magnetic drum. The spacer bit is used to separate adjacent words on the drum and is always recorded as "0." As many as 9 decimal digits may be represented in one data word.

A word may be used to store data or an instruction as shown in Figure 3. Negative numbers are represented as a two's complement.

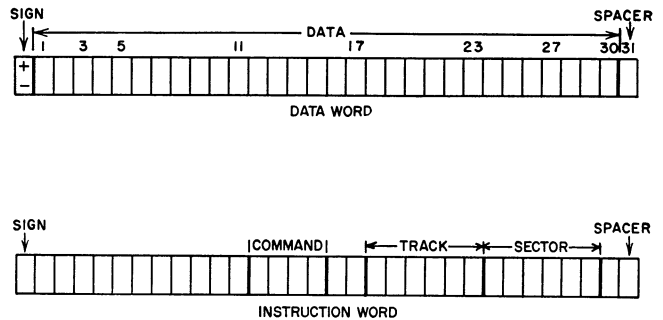

FIGURE 3. Word Structure

Addressing Systems

THE 4096 WORDS of the LGP-30 are addressed in terms of track and sector. This convention has been adopted to facilitate optimum programming which will be described later. Other addressing methods could be adopted and are perfectly feasible, such as addressing memory 0000 through 4095; however, in this manual, locations will be identified in terms of track and sector. Each track is addressed 00 through 63 and each sector is addressed 00 through 63. There is no break in continuity of addresses from one sector to the next or from one track to the next; 1723 represents the word whose address is track 17, sector 23. Consecutive addresses are then labeled 0000, 0001, 0002, . . . 0063, 0100,

0101 6363. Figure 3 shows that part of the word is reserved for the track and sector, namely 6 bits each. The homogeneous memory of the LGP-30 makes possible random access to any one of 4096 word locations. When an instruction located in memory is executed, the result may be stored in any one of the 4096 locations on the drum.

All instructions, except the P, I and Z orders, contain addresses which refer to the location of a word in memory. The commands P, I, and Z will be defined in the section on Operations.

Computing Unit

INTERNAL CALCULATION is accomplished by directing information to the computing section from memory, processing it, and directing it back to memory. The computing section consists of three working registers: the counter register (C), the instruction register (R), and the accumulator register (A). The three registers are located on three separate recirculating tracks on the LGP-30 drum, in addition to the 64 tracks of memory.

The accumulator, A, is the working register. It contains the results of addition, subtraction, multiplication, etc., as these operations occur. It also contains one of the operands, prior to execution of an arithmetic instruction; the second operand is in memory at the word location specified by the address part of the instruction.

The instruction register, R, contains the instruction being executed. Both the operation and the address of the instruction are located in this register. Words are transmitted from memory to this register. Generally, these words are instructions of a program stored in memory. The instruction register may be interrogated to determine the operation to be performed.

The counter register, C, contains the location of the next instruction to be executed, i.e., if the counter register reads 2438, the next instruction to be executed is stored at 2438 or track 24, sector 38. This register contains only the address part of a word. The address part of the instruction register may be transferred to the counter register. The address part of the counter register may be transferred through a plus 1 adder to memory by use of the R command. During the execution of every operation, 1 is added to the counter register automatically, so it will be ready to search for the next instruction, after it finishes the one being executed.

The flow of information between the registers and memory is shown in Figure 4. The solid line indicates

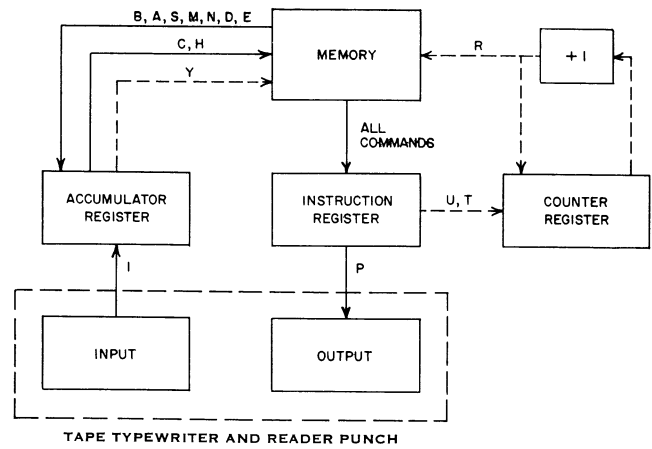

FIGURE 4. Flow of Information Through Registers and Memory

information being passed as a whole word. The dotted line indicates information affecting the address portion only. A typical instruction affects the registers as follows:

1. The word, whose address is in the counter register, is placed in the instruction register.
2. The word in the instruction register is then executed and information flows along one of the lines represented in the diagram depending on the instruction. During this time, the counter register is increased by 1. This completes an instruction cycle and the Computer starts to look again for the word whose address is now in the counter register.

Control Panel

THE LGP-30 control panel was designed for simplicity of operation. It displays, see Figure 5, the Oscilloscope recessed in the upper right hand corner of the panel and the translucent control buttons. These buttons, when lighted, indicate the operating status of the computer. The patterns on the Oscilloscope indicate the contents of the three working registers.

OSCILLOSCOPE

The scope furnishes the operator with a visual representation of the three registers as a means of checking or debugging his program. Three windows, one below

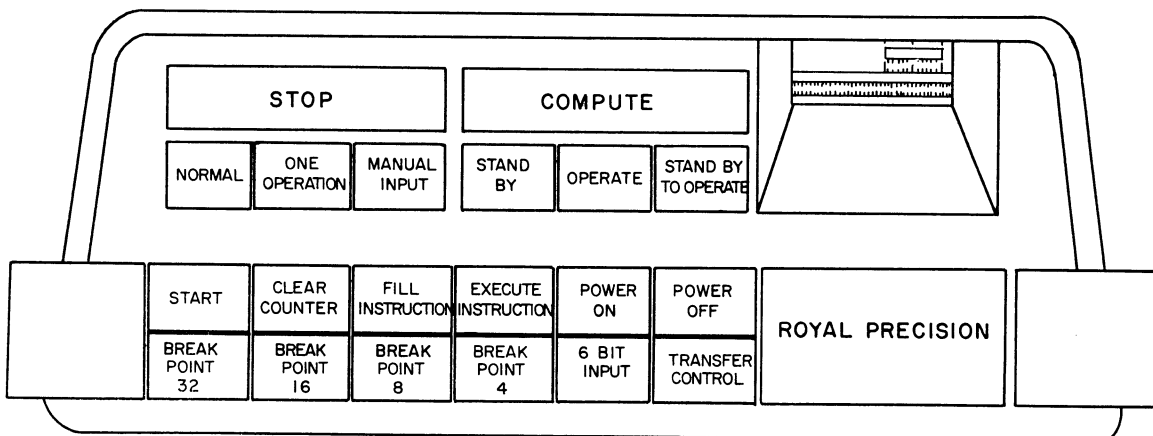

FIGURE 5. LGP-30 Control Panel

the other, display in binary the Counter Register, C, the Instruction Register, R, and the Accumulator Register, A, from top to bottom, as shown in Fig. 6.

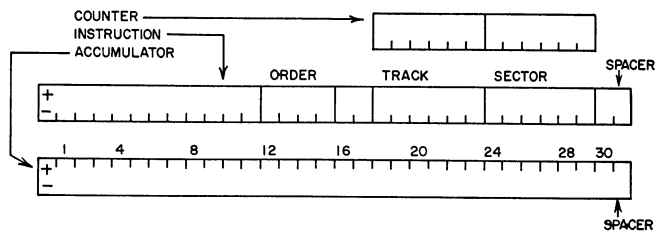

FIGURE 6. Oscilloscope Showing Three Registers

The Counter Register, C, contains the address, or location (track and sector) of the next instruction to be executed.

The Instruction Register, R, contains the last instruction executed and during multiplication or division, holds the second operand.

The Accumulator Register, A, contains the results of the execution of the last instruction.

CONTROL BUTTONS

Power On And Off Buttons

The “Power On” and “Power Off” switches are the main power switches.

It is good practice to be sure that the “Manual Input” button is depressed before depressing the “Power Off” switch. If it is not depressed when the computer is turned on, the computer will remain in “Stand By” state. If it is not depressed when the power is turned off, some of memory may be erased.

Stand By

When the “Stand By” button is depressed, after the “Power On” button is depressed, a red light behind it lights up. This turns off the high voltage.

Operate

Depress this button to prepare the computer for operation.

Stand By To Operate

This is an indicator, not a button and cannot be depressed. It indicates that the Computer is in one phase of its warmup cycle.

Mode Buttons

The following buttons select one of the three modes of operation but do not cause the machine to operate.

- **Manual Input**—(This is not the same as the Manual Input button on the Tape Typewriter.) Depressing this button connects the computer to the keyboard of the Tape Typewriter. All data typed on the keyboard appears in the accumulator register. If the “start” button is depressed, the contents of the word whose address is in the counter register is displayed in the instruction register and the counter register is increased by one. The accumulator register is unchanged since *no instruction is executed*. This enables the operator to “step through” a section of memory and examine the contents of each word as it appears in the Instruction Register.
- **One Operation**—Depressing this button prepares

the computer for executing one instruction at a time and halt. Depressing the “start” button executes only the instruction whose address is in the counter register and stops the computer. The counter register is then increased by one, unless a transfer instruction, T or U is executed. In this case, the counter register contains the address of transfer instruction, the instruction register contains the instruction just executed (except for multiply and divide instructions).

- **Normal**—Depressing this button sets the computing mode to execute the stored program automatically.

Operation Buttons

The Start, Clear Counter, Fill Instruction, and Execute Instruction buttons interlock with the Mode selection buttons. To simplify computer operation, a light under each button indicates when that button is operable; the lights are not lit when buttons are inoperable. For example, the execute instruction light is lighted only when the *One Operation* button is depressed, depressing this button in any other mode does not activate the computer.

- **Start**—This button must be depressed to execute stored instructions. It is used with *One Operation* and *Manual Input* as explained previously.
- **Clear Counter**—Depress this button to reset the counter register to zero to restart a program. This switch is used only in the *Manual Input* and *One Operation* modes.
- **Fill Instruction**—Depress this button to transfer the contents of the accumulator to the instruction register after it has been typed into the accumulator from the keyboard. This button is used only in *Manual Input* and *One Operation* modes of operation.
- **Execute Instruction**—Depress this button to execute the instruction in the instruction register. This button is used only in the *One Operation* mode.
- **Stop**—The “Stop” light panel will light red to indicate when computer has stopped.
- **Compute**—The “Compute” light panel will light green when computer is computing.

The bottom row of buttons on the console panel displays:

- **Break Point Switches**—The 4 breakpoint switches BP-32, BP-16, BP-8, and BP-4 are used with the track portion of the address of a stop order, Z. When the breakpoint switch is depressed, the computer ignores the “stop” instruction in the program and executes the following instruction. One depression latches the breakpoint in the down position, a second depression releases the latch. Lights under the breakpoint buttons are lit when switch is down, in latched position. The Z command will be explained later.
- **6-bit Input**—This button, when depressed during Input, permits all six channel bits of each typewriter character to enter the accumulator—instead of the usual 4 channels when button is up.
- **Transfer Control**—This button provides the operator another means of manually controlling the machine. It is used with a Test Instruction (T) to

determine which of two paths to follow in a program. One depression latches the button in down position (depressed), a second depression releases the latch. The T command will be explained later.

Operation Codes

THE OPERATIONS of the LGP-30 are grouped under arithmetic, logical, and input-output. In general, arithmetic operations are those that operate on a full 30-bit plus sign word; logical are those that affect only the address portion of the word.

ARITHMETIC OPERATIONS

Bring	B m Replace the contents of the accumulator with the contents of the memory location specified by the address, m.
Add*	A m Add the contents of m to the contents of the accumulator and retain the sum in the accumulator.
Subtract*	S m Subtract the contents of m from the contents of the accumulator and retain the difference in the accumulator.
Hold	H m Store the contents of the accumulator in m, retaining the contents of the accumulator in the accumulator.
Clear	C m Store the contents of the accumulator in memory location, m, clearing the accumulator to zero.
Extract	E m The Extract order or "logical product" is a bit by bit product of the contents of the accumulator by the contents of m. The extract order may also be explained in this way: if there is a "1" in a bit position of the accumulator and a "1" in the corresponding bit position of the m word, the E order places a "1" in the corresponding position of the accumulator; otherwise it places a zero in the accumulator. This order makes it possible to "mask out" parts of a word,

when two or more quantities are stored in one memory location.

Divide‡ D m
Divide the number in the accumulator by the number in the memory location, m, retaining the quotient (rounded to 30 bits) in the accumulator. The absolute value of the contents of m must be greater than the absolute value of the contents of A or overflow will occur and the computer will stop.

Multiply‡§ M m
Multiply the number in the accumulator by the number in memory location, m, retaining the most significant half of the product (30 binary places) in the accumulator.

Multiply‡§ N m
Multiply the number on the accumulator by the number in memory location, m, retaining the least significant half of the product (30 binary places) in the accumulator.

LOGICAL OPERATIONS

Store Address Y m
Store only the address portion of the word in the accumulator in memory location, m, leaving the rest of the word in m undisturbed.

Return Address R m
Add "one" to the address held in the counter register, C, and record it in the address portion of the word in memory location, m. The counter register, C, normally contains the address of the next instruction to be executed. This command is used in setting a subroutine exit.

Unconditional Transfer U m
Transfer control to m unconditionally, i.e., get the next instruction from memory location, m.

* If an ADD or SUBTRACT order results in a number which is too large for the 30-bit accumulator, overflow will occur and the computer will stop.

‡ In the multiply and divide orders, the contents of (m) are used for repetitive additions or subtractions and must be available many times. Since the instruction register is not needed at the time of execution of these orders, it is replaced by the contents of (m). The result of this may be seen if a multiply or divide command is executed during "One Operation" mode. The Instruction Register, R, will contain the multiplier or divisor of the respective instruction rather than the instruction itself.

Caution: When debugging a program. If overflow results during division, the counter register indicates where, in

the program, the computer has stopped. The instruction register will not contain the actual instruction being executed.

§ When two 30-bit binary words plus sign are multiplied the result is a 60-bit product plus sign. In the M multiply product, only the sign and the most significant 30 bits appear in the accumulator. In the N multiply product the least significant 30 bits of the product appear in the sign position through bit 29 of the accumulator, leaving bit 30 generally 0. It will not be zero only when the spacer bit in the accumulator is not zero prior to the multiplication. This may occur only after an Input order. The spacer bit is always zero in memory. There is no corresponding algebraic sign in the N multiply product; the result is shifted one position to the left.

Test**T m**

Conditional transfer. Transfer control to memory location m only if the number in the accumulator is negative. Otherwise, the test command is ignored.

-T m

Same as the test instruction with the addition that if the Transfer control button on the LGP-30 console is depressed or the accumulator is negative, the transfer will take place.

Stop**Z n**

The stop command can be made unconditional or contingent on 4 break point switches depressed on the LGP-30 console. This command enables the operator to stop the program at selected points when desired. The n address does not refer to one of the 4096 locations but instead to one of the 4 break point switches on the control panel. If n is 0000, the "stop" will be unconditional; if n is 0800, the "stop" is ignored, when BP-8 switch is depressed.

NOTE: The track portion of the operation refers to the break point switch number. If the switch is not depressed, the computer will stop. The sector portion of the address is irrelevant with respect to the function of the operation, except for optimizing which is explained later.

INPUT-OUTPUT OPERATIONS**Print****P n**

Print a Tape Typewriter symbol. The n address does not refer to one of the 4096 addresses, instead the track portion is a code to print or punch a character on the Tape Typewriter. The sector part of the address is irrelevant with respect to the function of the operation, but it does affect the timing and will be further explained in timing and optimizing. A further detailed discussion of the print P order will be found in the Input-Output components section.

Input**I n**

This command enters information from the Tape Typewriter into the accumulator. An Input order is always preceded by a print order, but not necessarily immediately. The n address does not refer to one of the 4096 addresses and will normally be zero. The sector part of the address is irrelevant with respect to the function of the command, and does not affect the timing of the instruction. The track portion of the address indicates the first four bits to enter the accumulator. If the 6-bit switch is depressed, all six bits enter the accumulator.

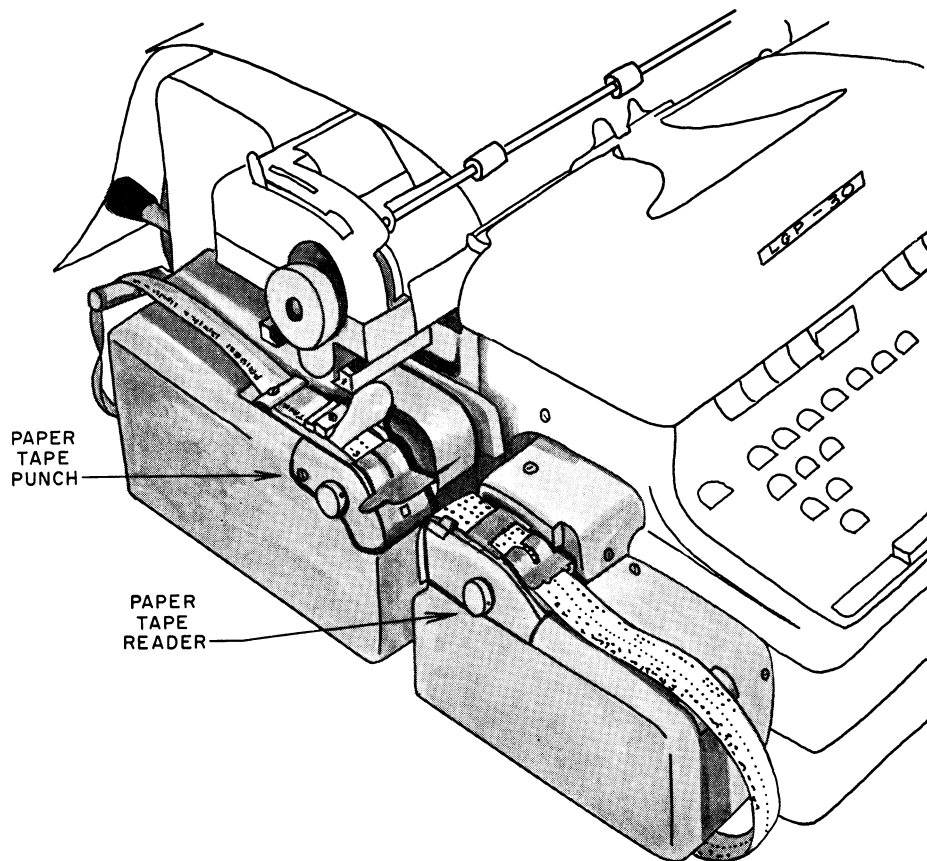

FIGURE 7. Paper Tape Reader and Punch on Tape Typewriter

Input-Output Components for the LGP-30

THE TAPE TYPEWRITER, Photoelectric Paper Tape Reader and high-speed Paper Tape Punch are the Input-Output devices for the LGP-30. All of these are controlled directly by the program stored in the computer.

TAPE TYPEWRITER

The Tape Typewriter is a typewriter with the Paper Tape Reader and Paper Tape Punch attached as integral parts of the unit, see Fig. 7. It may be operated independently of the Computer as a reading and punching device. Information is fed to the Computer via the typewriter keyboard or via punched tape in the Paper Tape Reader attached to the Tape Typewriter.

Information passing through the Paper Tape Reader or Paper Tape Punch will also create a typewritten copy. These units may not be operated independently of the typewriter.

Typewriter Controls Switches, Lights and Manual Controls

The Tape Typewriter has a standard typewriter keyboard, see Fig. 2, modified to use the LGP-30 codes shown in Appendix A. The keys that represent the commands are a different color from those on the rest of the keyboard. One extra code key, Conditional Stop, is added to the typewriter keyboard.

- *Conditional Stop Code* (1)

This key is used to punch a code in paper tape. When this code is read, it has two functions:

1. to stop the paper tape reader
2. to send the "start signal" to the computer

- *Power On—Power Off Switch*

This switch, in the lower right hand corner of the Tape Typewriter, adjacent to the keyboard, turns the power to the typewriter "on" or "off." It is independent from the LGP-30 Computer power switch and must be turned on when punching tape or printing typewritten copy.

- *Connect Switch*

This switch allows start signals to pass from the Tape Typewriter. If the switch is in the "On" position, the "start" signal, originating from the Start button on the Tape Typewriter or from reading a conditional stop on the paper tape, will pass to the LGP-30. If the switch is "Off," all start signals originating from the Tape Typewriter are blocked.

- *Start Compute*

The "Start Compute" lever on the Tape Typewriter, when depressed, sends a start signal to the LGP-30, to start computing. It duplicates the function of the "Start" switch on the computer, and duplicates the reading of the "start" function of a Conditional Stop code (1) on tape. It also turns out the manual input light on the Tape Typewriter.

- *Manual Input* (no connection with the Manual Input on Computer Console)

The Manual Input lever on the Tape Typewriter determines whether information from the Tape Type-

writer to the Computer is transmitted from the keyboard or from the Paper Tape Reader. If the switch is down, the information is received from the keyboard. If the switch is up, the information is received from the Paper Tape Reader.

- *Code Delete*

This lever is operative only when the "Punch On" switch is depressed. It is used to delete an error punched in the paper tape by punching holes in all channels 1 through 6 after tape has been rolled back to the error position. Then the correct code may be punched.

- *Tape Feed*

The Tape Feed lever, when depressed, feeds tape into the Paper Tape Punch. It punches the sprocket feed holes only. It is operative only when the "Punch On" Switch has been depressed previously. The "Tape Feed" lever springs up into place, when released. This lever is used to obtain a leader at the beginning and a trailer at the end of the tape.

- *Punch On*

The "Punch On" Switch turns the Paper Tape Punch "on" so that any characters being typed from the keyboard or read from the Paper Tape Reader, will be reproduced on the Paper Tape.

- *Stop Read*

Depressing this lever will stop the Paper Tape Reader on the Tape Typewriter from reading any more characters. It also extinguishes the Manual Input light on the Tape Typewriter.

- *Start Read*

Depressing this lever will start the Paper Tape Reader, reading information. When a Conditional Stop code appears on the Paper Tape or when the Stop Read lever is depressed, the reading is stopped.

- *Conditional Stop* [not the same as Conditional Stop Code (1) key]

This lever (on the upper frame of the typewriter), when depressed, will cause the Paper Tape Reader to ignore a Conditional Stop Code (1).

- *Guides and Interlocks*

Guides and interlocks on both the Paper Tape Reader and the Paper Tape Punch feed the paper tape to the Tape Typewriter. If the tape breaks, the interlock is tripped and the Tape Typewriter automatically stops.

- *Tabs and Carriage Returns*

Facilities for manually setting tabs and carriage returns are located on the rear of the carriage.

Operation of the Tape Typewriter

OUTPUT

Output information is transmitted from the Computer to the Tape Typewriter by a "P" instruction with a specific binary code for the track portion of the address. The codes used to activate the characters on the Tape Typewriter are given in Table I, Appendix A.

For example, if the instruction "P 1300" is given, the Tape Typewriter types the letter "R." Track 13, in binary, is written 001101, the code for the letter "R."

To print any of the alpha-numeric characters or controls in Table I, the same technique is used. While there is a possibility of the LGP-30 sending 64 distinct codes to the Tape Typewriter, the Tape Typewriter is limited in its operation codes, as shown in Table I. If any of the remaining 13 codes are given, the Tape Typewriter will ignore them.

After the print command, P, is given, the LGP-30 does not stop but may continue computing.

The Tape Typewriter can accept only 10 characters per second. If two print commands are given in succession, the second one will not be executed because the Tape Typewriter has not completed executing the first.

Consequently, the problem of timing output on the LGP-30 must be considered.

Two solutions are suggested:

1. Expand the computing time between the two print orders so that one order has finished its print cycle before the second order is given. The minimum time between print instructions should be 0.1 seconds or $5\frac{1}{2}$ drum revolutions. (This will be discussed further under Timing and Optimizing).
2. The Tape Typewriter always sends a start signal to the computer after it finishes printing a character. Place a Stop instruction after each Print Instruction. This stops the computer after the character has been printed, and prohibits computing between print instructions. A start signal from the Tape Typewriter initiates computing again.

Many output programs use the combination of the two suggestions executing instructions and following them with a stop order. However, care must be taken not to execute too many instructions before a stop order. If this occurs, the Tape Typewriter sends a "start" signal back to the computer before the "stop" instruction is given. Then, when the computer stops there is no start signal transmitted to get it started again.

INPUT

Information is transmitted to the Computer from the Tape Typewriter in one of two methods, either by reading the information from punched paper tape by means of the reader unit, or by accepting information directly from the keyboard.

1. From Punch Tape

To transmit information from the punch tape, the reader on the Tape Typewriter or the keyboard is actuated by a Print Instruction P0000 from the Computer. However, when the keyboard is used to transmit information, the Manual Input switch must be depressed. A light in the "Manual Input" panel on the Tape Typewriter indicates transmission of information from the Keyboard. The input order, I0000 follows but not necessarily immediately, the print order, P. However, it must be given before the information on the tape appears under the reading head of the Paper Tape Reader, otherwise the information is lost.

The combination of a P0000 and I0000 order stops the Computer and starts the Reader. Characters read from the tape are then filled into the accumulator register 4 bits or 6 bits at a time, depending on the position of the 6-bit Input switch on the computer console.

When the character is punched on paper tape the channels on the tape are numbered.

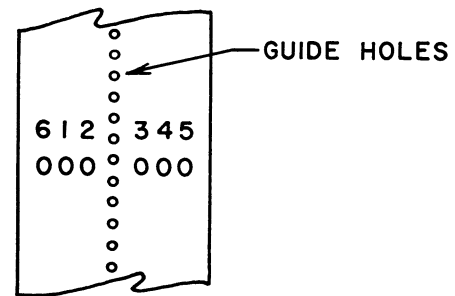

The characters punched on the tape are in channels 6, 1, 2, 3, 4, 5, from left to right, however, the computer enters characters into the accumulator in the order of 1, 2, 3, 4, 5, 6.

If the 6-bit Input switch is not depressed, only channels 1 through 4 on the tape are transferred to positions 28 through 31 in the right hand end of the accumulator. If the 6-bit switch is depressed, all 6 channels of each character code are filled, 6 bits at a time, into positions 26 through 31 of the accumulator. The accumulator is shifted 4 or 6 positions before each character is entered.

Since the accumulator holds 32 bits, including the sign and spacer bit, 8 characters are sufficient to fill the accumulator, 4 bits at a time. If the 9th character is read, the first character is lost. Therefore, a conditional stop code (') is necessary after 8 characters.

When a conditional stop code (') is read on the tape, a start signal is given to the computer. The computer then operates on the next instruction.

2. From the Keyboard

When information to the Computer is transmitted via the keyboard, a start signal is supplied to the computer by depressing the "Start Compute" lever on the Tape Typewriter, or the computer console.

PHOTOELECTRIC READER AND PAPER TAPE PUNCH

A high speed Photoelectric Reader and high speed Paper Tape Punch may be attached to the LGP-30 as auxiliary Input-Output equipment. The Photoelectric Reader shown in Fig. 8 is capable of reading 200 characters per second. The Paper Tape Punch operates at a speed of 20 characters per second. The combination of Reader and Punch as a unit is identified as Model No. 342, the Reader alone is Model No. 341. Using the Photoelectric Reader and the Paper Tape Punch, there is no typewritten copy as a by-product of the Input or Output.

Manual Controls

When switches are operated, a light behind them lights up, see Fig. 8.

• Reader Power Switch

This switch on the console of the Photoelectric Reader turns the power on. The power required to operate the

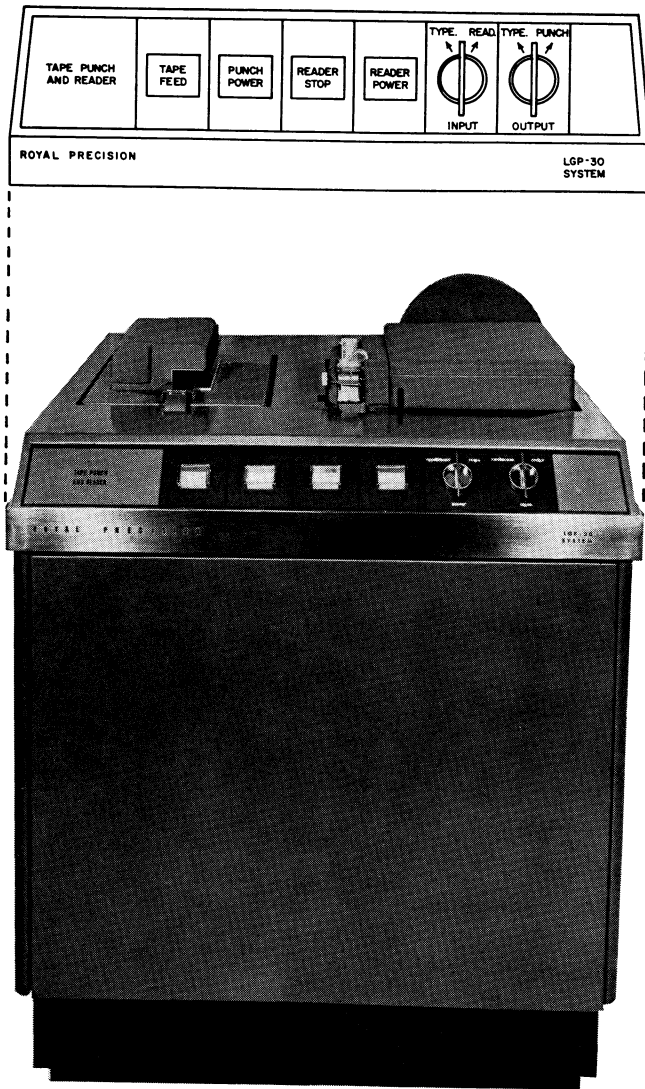

FIGURE 8. Photo-Electric Reader Model 342

Photoelectric Reader is not available until the LGP-30 power is turned on. The power for the Photoelectric Reader should not be turned on until the LGP-30 is in operate status.

- *Reader Stop*

This button is used to stop the transport of paper tape through the Photoelectric Reader. There is no manual "start read" switch on the Photoelectric Reader.

- *Punch Power*

This switch turns the power on in the Paper Tape Punch. The Punch may be operated without the reader power switch on. This switch should not be turned on until the LGP-30 is in operate status.

- *Tape Feed Switch*

This switch feeds the tape to the punch unit. Only the sprocket holes are punched.

- *Input*

This switch selects the Tape Typewriter or the Photoelectric Reader as the Input device for the LGP-30.

- *Output*

This switch selects the Tape Typewriter or the Photoelectric Reader as the Output device for the LGP-30.

Operation of Photoelectric Reader

To operate reader :

1. Turn Computer on and make ready to operate by warming up.
2. Depress Reader Power switch.
3. Place tape face down in Reader starting with 6 in. leader.
4. Locate tape inside guide pins under reader head and snap clamps on tape.
5. Set Input switch to Reader.

The Computer is now ready to accept information from the Photoelectric Reader.

Operation of Computer and Reader

A P0000 instruction is ignored by the Reader, when the Computer is connected, but a P0000 instruction activates Input when the Tape Typewriter is used.

An I0000 instruction starts the Reader, reading all characters into the Computer. A Conditional Stop code (1) stops the Reader.

Only those characters read into the Computer by the Tape Typewriter may be read in by the Reader. A stop code generates a "Start Compute" signal to the Computer and stops the tape.

Operation of Tape Punch

To operate the Tape Punch :

1. Turn Computer "on" and make it ready to operate by warming up.
2. Depress "Punch Power" switch once. (It lights up).
3. Set Output switch to "Punch."
4. Depress "Tape Feed" switch and hold depressed long enough to obtain at least a 6 inch leader.
5. Tape starts punching.
6. Direct long tapes into chute, through slot in Punch Reader console to bin inside cabinet.

Operation of Punch with the Computer

A P0000 code starts the Tape Typewriter. Any one of the other 63 codes (01 through 63) are possible.

A Pnn00 instruction from the computer punches the character represented in binary in the track portion of the instruction.

At the end of each punching cycle, a "Start Compute" signal is generated similar to the punching operation of the Tape Typewriter.

Since the punch operates approximately twice as fast as the Tape Typewriter, there is consequently less time for calculation between punch cycles. The timing using the punch will be further discussed in timing and optimizing.

The description of the Photoelectric Reader and the Paper Tape Punch only describes the difference between programming with these units and with the Tape Typewriter. For more information, see Programming Input and Output of the Tape Typewriter.

Timing and Optimizing

OPTIMUM programming is the technique by which data and instructions are located on the drum of the computer so as to minimize non-productive searching time. Before describing the optimizing technique used in the LGP-30, it should be emphasized that the savings in machine time should be compared with the cost of the programmer's time before deciding to optimize a program.

LGP-30 Design

An interlace pattern of sectors around the drum has been provided on the LGP-30. The track portion of all locations and addresses has no effect on optimizing; only the sector portion determines whether an order is optimum or non-optimum. Fig. 9 shows a cross-section of one track on the drum, divided into 64 sectors or words. Since a word time is the time it takes for one

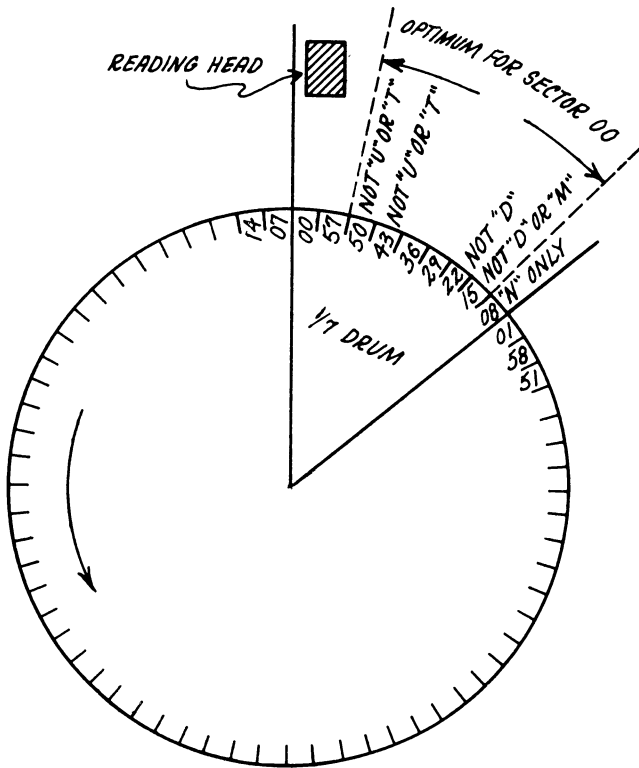

FIGURE 9. Cross Section of Drum at any Track

word or sector to pass under the read head and the drum revolves at 4000 revolutions per minute, one word time is 0.23 milliseconds

Table I shows the complete sequence of sectors around the drum for one track. Consider the following program.

Location	Op.	Address
0000	B	1943
0001	A	2151
0002	C	1943

The instructions, B 1943, A 2151, C 1943, must be brought into the instruction register before they can be executed and this can only happen when locations

0000 0001 0002 respectively are under the read head. Assume the read head is over sector 00 and is placing the instruction B 1943 in the instruction register. If this instruction, B 1943, can be executed before the drum turns around to sector 01 it will be an optimum instruction. Figure 9 shows sector 43 is between sector 00 and sector 01 and is within the portion which is optimum for sector 00. The same logic applies to the next instruction A 2151 at location 0001. Sector 51 lies between sector 01 and sector 02 and lies within the portion that is optimum for sector 01. Both of the preceding instructions are optimum. The next instruction C 1943 at location 0002 will not be optimum because sector 43 does not lie between sector 02 and sector 03.

TABLE I

Sequence of sectors around the Drum for one Track

00	01	02	03	04	05	06	07
57	58	59	60	61	62	63	
50	51	52	53	54	55	56	
43	44	45	46	47	48	49	
36	37	38	39	40	41	42	
29	30	31	32	33	34	35	
22	23	24	25	26	27	28	
15	16	17	18	19	20	21	
08	09	10	11	12	13	14	

Table II shows the 16 commands the LGP-30 performs and the number of word times after the location of the instruction, the address of the operand must be in order for the instruction to be optimum.

For example Table II shows that for a divide instruction, if the address of the operand is 2-5 word times after the location, the instruction will be optimum. If the divide instruction were placed at sector 51, Table I will give the sector addresses of the 2 through 5 word times following sector 51. (37,30,23,16).

TABLE II

Order	No. of Word Times
Bring, Add, Subtract	2 to 7
Hold, Clear, Store,	
Return Address, Extract,	
Print, Input, Stop	
N multiply	2 to 8
M multiply	2 to 6
Divide	2 to 5
Unconditional transfer and transfer	4 or more

Timing on Input

The only timing problems that occur in Input are with the Tape Typewriter. If a P0000 instruction is initiated, an I0000 instruction must follow before any information reaches the read portion of the Tape Typewriter.

Timing on Output

When the Tape Typewriter is used as the Output device of the LGP-30 it is very desirable to run the Tape Typewriter at top speed, approximately ten characters per second. This means that there are approximately $5\frac{1}{2}$ drum revolutions of useful calculation between printing each character on the Tape Typewriter. This

time is normally spent converting the next character to be printed on the Tape Typewriter. This is especially true if a binary to decimal conversion is required.

After the "P" instruction supplies the typewriter unit with the required information to execute a print or a control function, control is transferred to the instruction following the "P" instruction. The programmer may use any instruction except another "P."

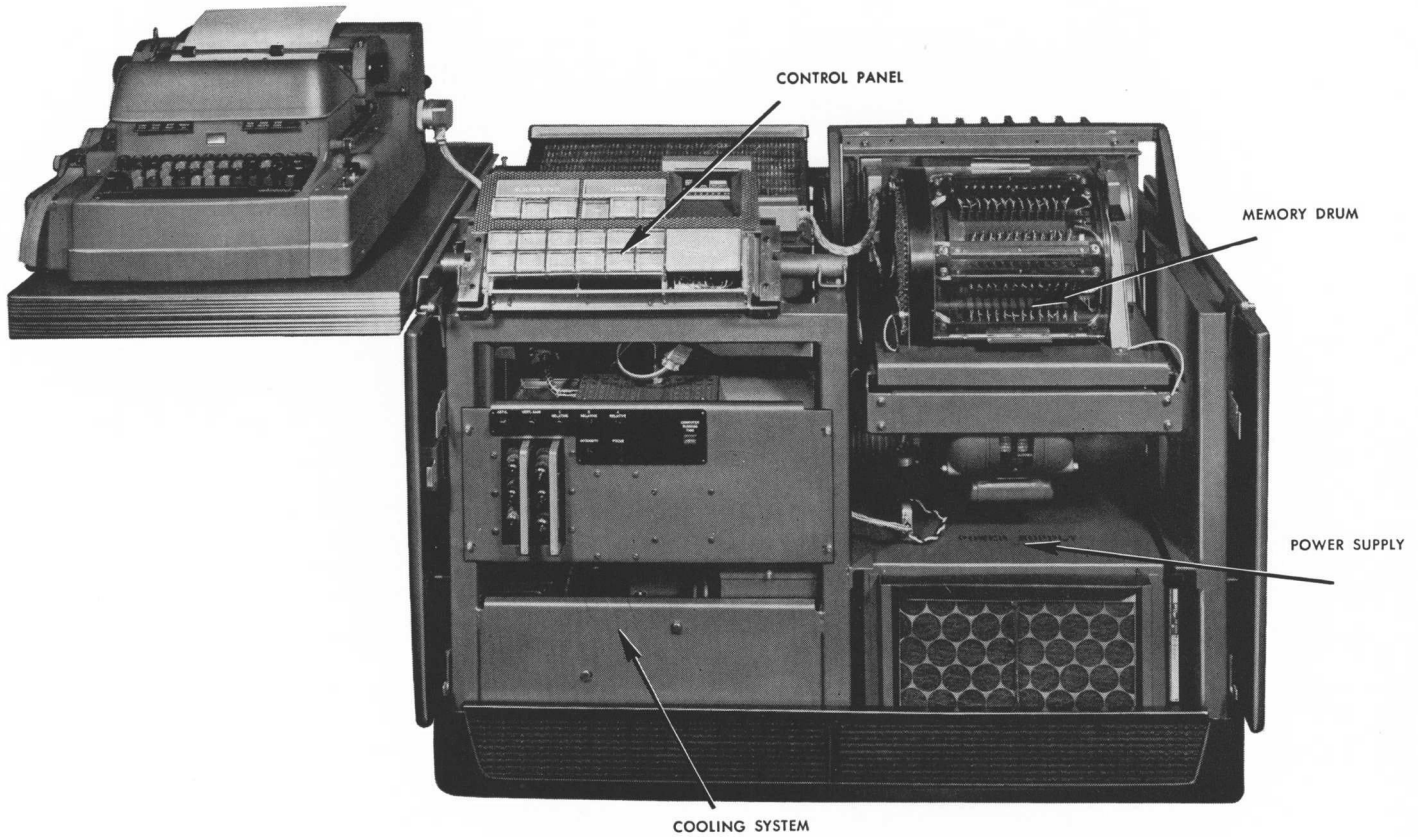

LGP-30 COMPUTER WITH FRONT COVER REMOVED

APPENDIX A

TABLE I

COMPUTER CODES ON TAPE TYPEWRITER KEYBOARD

ALPHA-NUMERIC KEYS		"P" INSTRUCTION DECIMAL	OUTPUT CODE	INPUT CODE
Upper Case	Lower Case		6-BIT BINARY (TRACK PORTION)	4-BIT, 6-BIT BINARY
			123456	123456
)	0	P 0200	000010	0000 10
L	1	P 0600	000110	0001 10
*	2	P 1000	001010	0010 10
"	3	P 1400	001110	0011 10
Δ	4	P 1800	010010	0100 10
%	5	P 2200	010110	0101 10
\$	6	P 2600	011010	0110 10
π	7	P 3000	011110	0111 10
Σ	8	P 3400	100010	1000 10
(9	P 3800	100110	1001 10
A	a	P 5700	111001	1110 01
B	b	P 0500	000101	0001 01
C	c	P 5300	110101	1101 01
D	d	P 2100	010101	0101 01
E	e	P 3700	100101	1001 01
F	f	P 4200	101010	1010 10
G	g	P 4600	101110	1011 10
H	h	P 4900	110001	1100 01
I	i	P 1700	010001	0100 01
J	j	P 5000	110010	1100 10
K	k	P 5400	110110	1101 10
M	m	P 2900	011101	0111 01
N	n	P 2500	011001	0110 01
O	o	P 3500	100011	1000 11
P	p	P 3300	100001	1000 01
Q	q	P 5800	111010	1110 10
R	r	P 1300	001101	0011 01
S	s	P 6100	111101	1111 01
T	t	P 4500	101101	1011 01
U	u	P 4100	101001	1010 01
V	v	P 3100	011111	0111 11
W	w	P 6200	111110	1111 10
X	x	P 3900	100111	1001 11
Y	y	P 0900	001001	0010 01
Z	z	P 0100	000001	0000 01
:	;	P 1500	001111	0011 11
?	/	P 1900	010011	0100 11
]	.	P 2300	010111	0101 11
[,	P 2700	011011	0110 11
=	+	P 1100	001011	0010 11
—	-	P 0700	000111	0001 11
CONTROLS				
Lower Case†		P 0400	000100	
Upper Case†		P 0800	001000	
Color Shift†		P 1200	001100	
Car Ret†		P 1600	010000	
Back Space†		P 2000	010100	
Tab		P 2400	011000	Tab 0000 00
Cond Stop (')†		P 3200	100000	
Start Read†		P 0000	000000	
Space		P 0300	000011	Space 0000 11
Delete†		P 6300	111111	

†Not used in Input Code

SCALING

The operation of scaling is performed by the programmer to eliminate overflowing the accumulator or loss of precision.

Before programming a problem on a computer, a technique for scaling the data must be employed. Various techniques may be used depending on the number system. In the decimal system 10 is the basic number. However, the LGP-30 is designed about the binary system, using a base of 2. In scaling data, the binary point, "q", represents the number of places from the extreme left of the data word, where the radix point is located. (The radix point indicates the separation between the integral and fractional portions of a data word.) Given a data word, its "q" is determined from the table of Powers of Two, Table I, for example number 200 must be held at least a "q" of 8. In representing a word of 30 bits, excluding the sign bit to the left, See Figure A below, q_0 is considered to be at the extreme left.

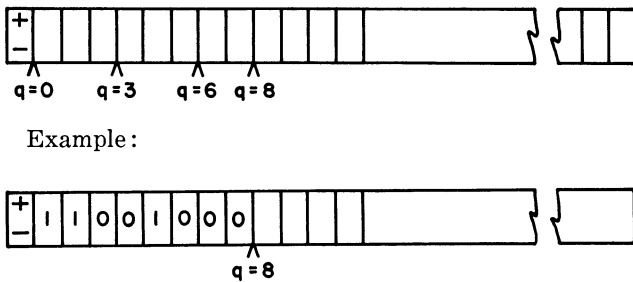

FIGURE A

The rules for scaling in arithmetic operations of the LGP-30 are the same as those in other computing devices. To add or subtract two numbers, they must be held at the same "q's." (In a desk calculator, this is equivalent to lining up the decimal points.) The result of such addition or subtraction is a number at the same "q."

In multiplication, the "q's" of the two numbers need not be the same. The product of two such numbers is a number at $q_m = q_1 + q_2$ where q_1 is the binary point of the multiplier and q_2 is the binary point of the multipli-

cand. In division, the quotient of two numbers has a $q_d = q_1 - q_2$ where q_1 is the binary point of the dividend, q_2 is the binary point of the divisor. In multiplication, q's are added, in division, the q's are subtracted.

Since the purpose of scaling is to shift data into such favorable locations to eliminate loss of precision, it is important to determine how shifts are made without altering the value of the data. Any number multiplied by the integer, 1, results in the same number. But any number multiplied by the integer 1 at $q = n$ shifts the number in the accumulator by n places to the right. This will place the number in the required location. For example, to add 5 at a $q = 10$ to 10 at a $q = 12$, the 5 at $q = 10$ must be multiplied by 1 at $q = 2$ to obtain 5 at 12, or shift 5 to location $q = 12$ in accumulator. Then, we can add the result in the accumulator. Thus, we shift the contents of the accumulator to the right so that the radix point is located at the required $q = 12$.

It is sometimes required to shift left to scale a number to a q smaller than that given. In this case, divide the number to be scaled by the integer, 1 at $q = n$, and thus shift it in the accumulator by n places to the left. For example, 7 at $q = 4$, divided by 1 at $q = 2$ equals 7 at $q = 2$. However, it must be noted that 7 cannot be located at a $q = 2$ since the last remaining digit to the left will overflow and stop the computer. A mental check is necessary to determine the "fit" of the quotient in the accumulator before dividing. In this case, it is possible only to divide 7 at $q = 4$, by 1 at $q = 1$ to obtain 7 at $q = 3$, which will "fit" into the accumulator.

Another method of shifting left utilizes the "N" multiply instruction. This instruction retains the least significant half of the product in the accumulator. To shift a number left n places, "N" multiply the number by 1 at $q = (31-n)$. For example, given 7 at $q = 6$, we want 7 at $q = 4$, therefore, shift left by 2 places. To do this, "N multiply" 7 at $q = 6$, by 1 at $q = (31-2)$ to obtain 7 at $q = 35$. This is equivalent to 7 at $q = 4$ as can be illustrated below.

From the following illustration, we note that the 31st bit of the total product is in the sign bit of the accumulator.

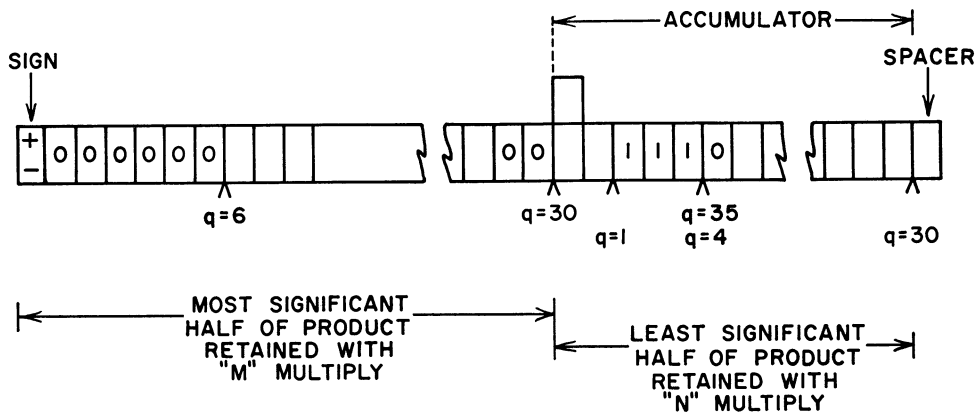
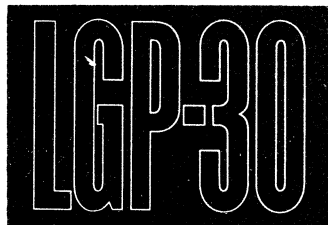

TABLE I
POWERS OF TWO

Positive Power— 2^N			N	Negative Power— 2^{-N}					
			Power						
1			0	1.0					
2			1	0.5					
4			2	0.25					
8			3	0.125					
16			4	0.0625	5				
32			5	0.03125	25				
64			6	0.015625	625				
128			7	0.0078125	8125	5			
256			8	0.00390625	90625	25			
512			9	0.001953125	953125	125			
1024			10	0.0009765625	5625	5			
2048			11	0.00048828125	28125	25			
4096			12	0.000244140625	140625	625			
8192			13	0.0001220703125	703125	5			
16384			14	0.00006103515625	3515625	25			
32768			15	0.000030517578125	17578125	125			
65536			16	0.0000152587890625	87890625	5			
131072			17	0.00000762939453125	439453125	25			
262144			18	0.000003814697265625	2197265625	625			
524288			19	0.0000019073486328125	10986328125	5			
1048576			20	0.00000095367431640625	54931640625	25			
2097152			21	0.000000476837158203125	274658203125	125			
4194304			22	0.0000002384185791015625	1373291015625	5			
8388608			23	0.00000011920928955078125	6866455078125	25			
16777216			24	0.000000059604644775390625	34332275390625	625			
33554432			25	0.0000000298023223876953125	171661376953125	5			
67108864			26	0.00000001490116119384765625	858306884765625	25			
134217728			27	0.000000007450580596923828125	4291534423828125	125			
268435456			28	0.0000000037252902984619140625	21457672119140625	5			
536870912			29	0.00000000186264514923095703125	107288360595703125	25			
1073741824			30	0.000000000931322574615478515625	536441802978515625	625			
2147483648			31	0.0000000004656612873077392578125	2682209014892578125	5			



ROYAL McBEE • *data processing division*

Westchester Avenue, Port Chester, N. Y. In Canada: 179 Bartley Drive, Toronto 16