

MR6313

**SPERRY UNIVAC
REMOTE DEVICE
ADAPTER TYPE 8598**

**INSTALLATION
PROCEDURES**

FEBRUARY 1981

COMPANY CONFIDENTIAL INFORMATION

THIS DOCUMENT CONTAINS CONFIDENTIAL INFORMATION OF THE SPERRY CORPORATION. IN CONSIDERATION OF THE RECEIPT OF THIS DOCUMENT, THE RECIPIENT AGREES NOT TO REPRODUCE, COPY, USE OR TRANSMIT THIS DOCUMENT AND/OR THE INFORMATION THEREIN CONTAINED, IN WHOLE OR IN PART, OR TO SUFFER SUCH ACTION BY OTHERS, FOR ANY PURPOSE, EXCEPT WITH THE WRITTEN PERMISSION, FIRST OBTAINED, OF SPERRY UNIVAC DIVISION OF SPERRY CORPORATION, AND FURTHER AGREES TO SURRENDER SAME TO SPERRY UNIVAC WHEN THE REASON FOR ITS RECEIPT HAS TERMINATED.

SPERRY  UNIVAC

FASTRAND, SPERRY UNIVAC, UNISCOPE, UNISERVO, and UNIVAC are registered trademarks of the Sperry Corporation. ESCORT, PAGEWRITER, PIXIE, and UNIS are additional trademarks of the Sperry Corporation.

HANDBOOK APPLICATION

SPERRY UNIVAC 1900 CADE,
1900/10

HB2367 SPERRY UNIVAC
Remote Keystation/Device Adapter
Type 8598 Servicing

BRANCH LIBRARY

HB1731 Miscellaneous
Installation Procedures

REVISION STATUS

EFFECTIVE PAGES	REVISION HCB
iii and iv	-
1-1 thru 1-6	-
2-1 thru 2-7	-
3-1 thru 3-6	-
4-1 thru 4-3	-
5-1 and 5-2	-

CONTENTS

Heading	Title	Page
SECTION 1. INTRODUCTION		
1-1.	Scope	1-1
1-2.	Reference Material	1-1
1-3.	System Description	1-2
1-4.	Remote Device Adapter	1-2
1-5.	Modem	1-6
SECTION 2. INSTALLATION PROCEDURES		
2-1.	General	2-1
2-2.	Equipment Placement	2-1
2-3.	Unpacking Procedure	2-2
2-4.	Installation Procedure	2-2
SECTION 3. STRAPPING		
3-1.	General	3-1
3-2.	Power Supply Voltage Range Selection	3-1
3-3.	Local/Remote RDA Address Strapping	3-3
3-4.	Local/Remote Strapping	3-4
3-5.	Remote Device Address Strapping	3-6
SECTION 4. SPECIAL INFORMATION		
4-1.	General	4-1
4-2.	Special Test Mode	4-1
4-3.	Special Operational Procedures	4-2
4-4.	RDA/RKA Comparisons	4-2
SECTION 5. DEINSTALLATION		
5-1.	General	5-1
5-2.	Deinstallation	5-1

ILLUSTRATIONS

Heading	Title	Page
1-1.	Remote Device Adapter System in SPERRY UNIVAC 1900 CADE System	1-3
1-2.	Remote Device Adapter System in SPERRY UNIVAC 1900/10 System	1-4
1-3.	Remote Device Adapter	1-5
2-1.	RDA Internal Cabling	2-5
2-2.	Typical RDS Cabling	2-7
3-1.	Power Supply Voltage Range Selection	3-2
3-2.	Remote Device Adapter Strapping	3-3
3-3.	Processor PCA Device and Mode Selection Switch Block Locations	3-5

TABLES

Table	Title	Page
1-1.	RDA Types	1-5
1-2.	Allowable Distance Between DCMs	1-6
2-1.	RDA Unpacking Procedures	2-2
2-2.	Installation Procedures for Local Site	2-3
2-3.	Installation Procedures for Remote Site	2-4
3-1.	Power Supply Voltage Range Selection	3-3
3-2.	RDA Device Selection	3-4
3-3.	Remote Device Address Requirements	3-6
4-1.	Special Test Mode	4-2
4-2.	RDA/RKA Comparisons	4-3
5-1.	Cleaning Materials and Equipment	5-1
5-2.	Deinstallation	5-2

SECTION 1
INTRODUCTION

1-1. SCOPE

This book contains system installation procedures and supplementary information for the SPERRY UNIVAC Remote Device Adapter System (RDS). The contents are arranged as follows:

Section 1 contains reference material, a description of the system, and a detailed description of the SPERRY UNIVAC Remote Device Adapter Type 8598-04, -05 (RDA).

Section 2 provides the system installation procedures, including the system interface cabling.

Section 3 contains strapping requirements for the system.

Section 4 provides confidence test information.

Section 5 provides deinstallation procedures.

1-2. REFERENCE MATERIAL

The following handbooks provide installation and servicing information associated with equipment in the system:

<u>Handbook/Manual</u>	<u>Title</u>
HB2375	SPERRY UNIVAC Printer 0798 Servicing
HB2358	SPERRY UNIVAC Keystation Type 3541-00 through -02 Servicing
HB2359	SPERRY UNIVAC Keystation Type 3555 Servicing
MR6314	SPERRY UNIVAC Remote Device Adapter Type 8598 Functional Analysis and Servicing

1-3. SYSTEM DESCRIPTION

The RDS provides the capability of controlling remote devices over telephone lines. The RDS consists of two RDAs, two modems, and associated cables (see Figures 1-1 and 1-2). The RDS interface to a central control unit (CCU) is the same as the interface to a standard keystation. The RDA (Figure 1-3) appears as a coaxial device to the CCU when in local mode and as a CCU to a coaxial device when in remote mode. Remote and local modes are determined by strapping within the RDA.

The RDA interfaces up to four devices on the remote end. The only limitation on the number of remote device adapter systems interfaced to a CCU is the normal coaxial-unit limitation (up to 32 keystations and station printers, combined). The RDA is considered as one to four of the total number of devices.

1-4. REMOTE DEVICE ADAPTER

The RDA consists of a cabinet, a backplane, two printed circuit assemblies (PCAs), a power supply, and associated switches, indicators, and cabling. The cabinet, card rack, and power supply are the same as used in the SPERRY UNIVAC Universal Terminal System 400 Controller Terminal Type 8594. The logic for the RDA is contained on two PCAs, the processor, and the coaxial interface.

The processor PCA (part number 2818795) uses a microprocessor integrated circuit for control of the remaining logic. The processor PCA also contains read-only memory (ROM), random-access memory (RAM), the logic for the RS-232 communications interfaces to the modem, and related timing and control circuitry. The coaxial interface PCA (part number 2818796) contains the logic to interface with the local or remote coaxial link.

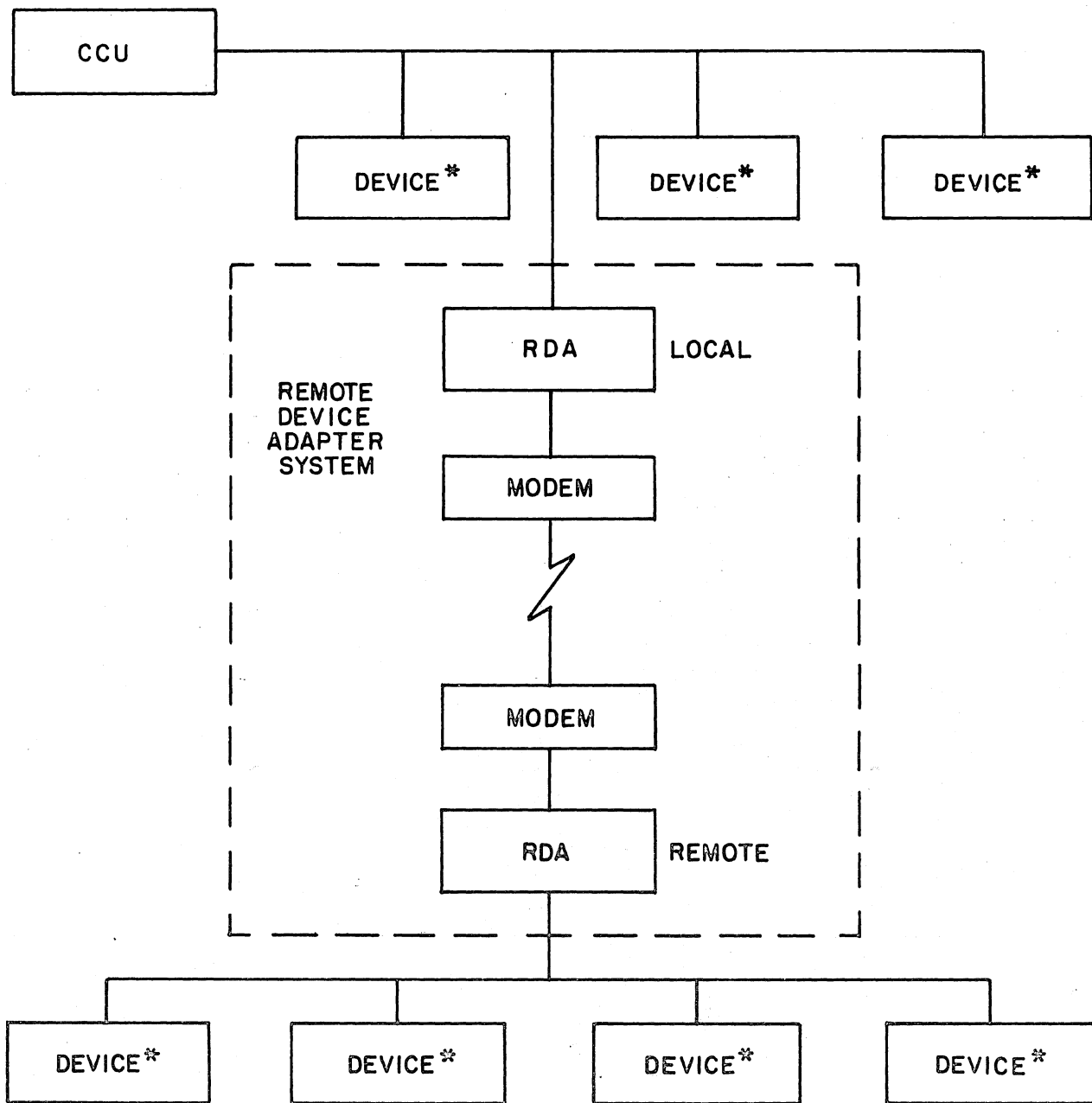

* ONLY DEVICE USED IS 480-CHARACTER SCREEN KEYSTATION.

58402

Figure 1-1. Remote Device Adapter System in SPERRY UNIVAC 1900 CADE System

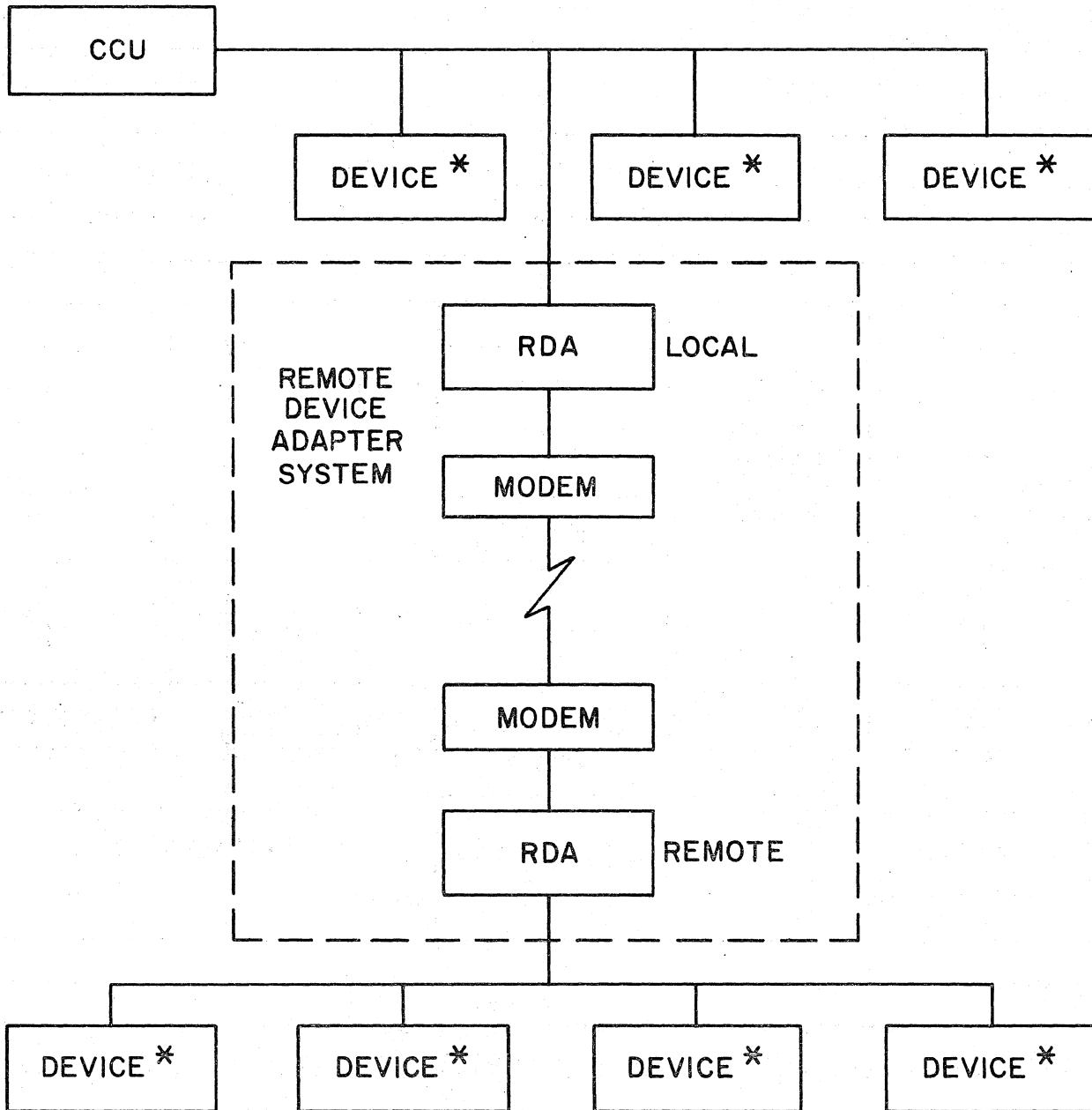

* DEVICE CAN BE EITHER 480 CHARACTER OR 2000 CHARACTER SCREEN KEYSTATION OR STATION PRINTER.

58395

Figure 1-2. Remote Device Adapter System in SPERRY UNIVAC 1900/10 System

The remote RDA appears as a CCU to interface with the remote device, and the local RDA appears as a device to interface with the CCU. The hardware and firmware are identical for the remote and local interfaces. The difference is in the strapping. The coaxial interface PCA uses a four-bit microprocessor (nanoprocessor) and a ROM to control the remote and local interfaces. Data is transferred between PCAs and between logic circuits within the PCAs on a tri-state bus.

There are two types of RDAs. The type numbers vary according to input voltages as described in Table 1-1. The RDA unit is shown in Figure 1-3.

Table 1-1. RDA Types

Type	
Local/Remote	Volts AC
8598-04	100 to 120V, 50 or 60 Hz
8598-05	200 to 240V, 50 to 60 Hz

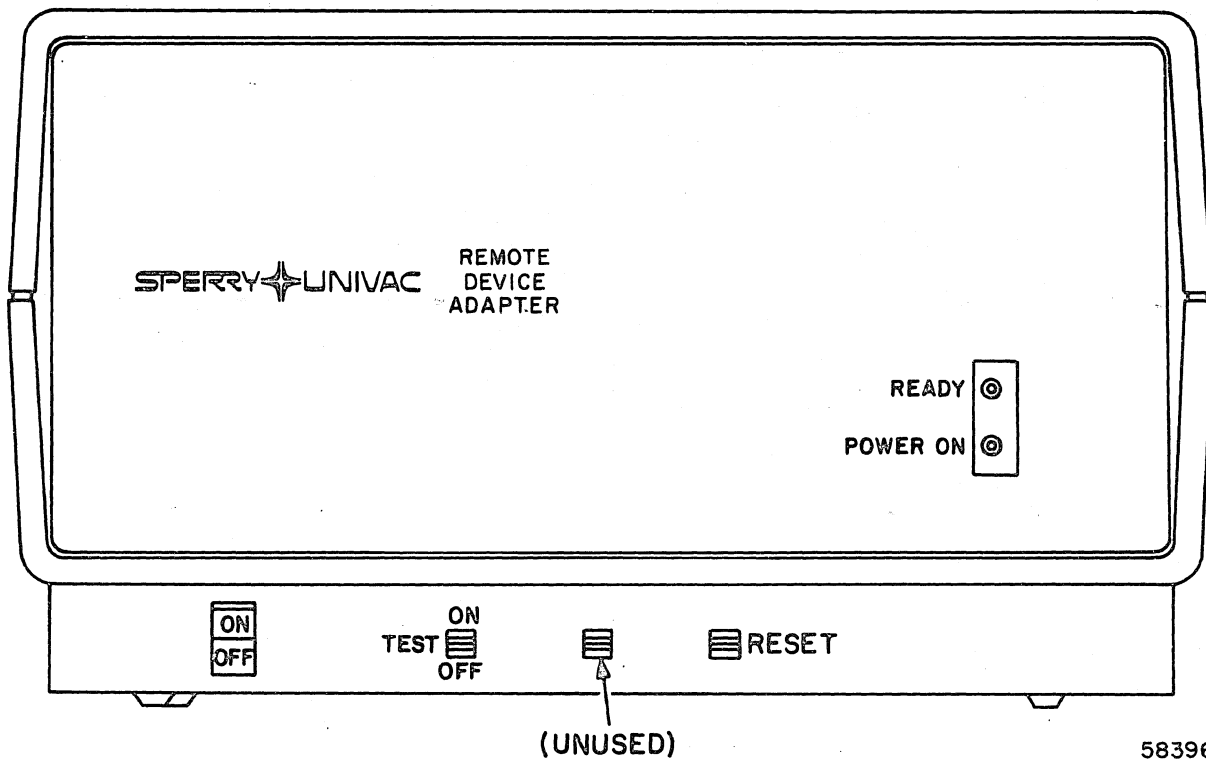

Figure 1-3. Remote Device Adapter

1-5. MODEM

The RDS uses a synchronous full-duplex modem with an RS-232 interface at line speeds of up to 9600 baud. Either switched or dedicated lines may be used. A SPERRY UNIVAC Direct Connection Module (DCM) Type 8543 may be used at sites where remote RDA and CCU are located within the same building and within minimal distance from one another (see Table 1-2).

Table 1-2. Allowable Distance Between DCMs

Transmission Rate (bps)	Distance (feet)	Distance (meters)
Up to 2400	15,000	4572
2400 to 3600	10,000	3048
3600 to 9600	5,000	1524

SECTION 2
INSTALLATION PROCEDURES

2-1. GENERAL

This section contains information for unpacking and installing the SPERRY UNIVAC Remote Device Adapter Type 8598-04, -05 (RDA).

2-2. EQUIPMENT PLACEMENT

The carrier is responsible for moving the equipment to its approximate location in the prescribed area. The customer should be present while the carrier is unloading the equipment to ensure that it is not handled roughly and that improper lifting devices are not used.

CAUTION

Do not use a forklift to move equipment containers. The equipment is packed in a polystyrene container which should be handled with care. The container can be easily penetrated by forklift prongs, and the equipment severely damaged.

The customer should instruct the carrier as to initial unit placement at the operating location. Correct placement at this time will avoid problems in unpacking later. After the system is unloaded and placed in the approximate operating location, inspect the container or containers for signs of damage that may have occurred during shipment.

Installation Procedures

If damage is found or if a portion of the shipment is missing, the customer must note this damage on the bill of lading. Also, any equipment which was handled roughly or dropped during unloading or placement should be so noted on the bill of lading, even though no damage may be apparent. This aids in filing a claim if damage is discovered during unpacking.

2-3. UNPACKING PROCEDURE

The procedures for unpacking the RDA are contained in Table 2-1.

Table 2-1. RDA Unpacking Procedures

Step	Procedure
1	Place container on floor near area where RDA will be used.
2	Cut bands holding container sections together and remove container top.
3	Remove bagged communication cable (if present) from the package.
4	Remove RDA from container bottom. Remove RDA top cover as follows: a. Loosen the two retaining screws on the rear of cabinet and back them out 8 to 10 turns (about 1/4-inch). b. Tip cover and front panel toward front and lift off.
5	With cover removed, ensure that all light emitting diode (LED) indicators are securely in place in their sockets.
6	Remove any internal packing material from module card racks.
7	Inventory the units and fill in appropriate sections of the inventory and inspection report shipped with each unit. Notify branch office of any damage or shortage.
8	If installation is to be completed at this time, proceed to Table 2-2; if not, continue to step 9.
9	Replace exterior casework and place unit in a suitable place.

2-4. INSTALLATION PROCEDURE

The procedure for installing a remote device adapter system is contained in Tables 2-2 and 2-3. Table 2-2 contains procedures for local site installation and Table 2-3 contains procedures for remote site installation.

Table 2-2. Installation Procedures for Local Site

Step	Procedure	Reference
1	Unpack the devices as described in appropriate servicing manuals and position in applicable installation locations.	HB2358, HB2359, HB2375
2	Unpack peripheral devices (if applicable) as described in the related servicing manuals and position at the proper installation locations.	Para. 1-2
3	Ensure that the RDA is unpacked as described in Table 2-1.	Table 2-1
4	If not already accomplished, remove RDA top cover. (Loosen two retaining screws at rear of cabinet and back them out about 1/4-inch. Tip cover and front panel toward front and lift off).	
5	Check RDA for broken or cracked connectors on terminal boards, and bent or shorted connector pins. Inspect for foreign material.	
6	Ensure that all push-on terminals within the RDA are securely attached to their respective switches, indicators, and potentiometers.	Figure 2-1
7	Ensure that all RDA internal cables are properly routed and plugged into the appropriate connectors.	Figure 2-1
8	Ensure that PCAs that are part of RDA are in adjacent slots of a single section of card rack.	Section 3
9	Determine the nominal primary ac voltage of the operating location. If necessary, remove cover from power supply module and strap power supply as described in Section 3.	Section 3
10	Replace RDA power supply module cover, if removed.	
11	Check all RDA modules for proper strapping. Strap modules, as necessary, according to the information in Section 3.	Section 3
12	Replace top cover on RDA.	
13	Position RDA at appropriate installation location.	

Table 2-2. Installation Procedures for Local Site (Cont)

Step	Procedure	Reference
14	<p>Configure system at each site as determined by site system analyst. Cabling for a typical site is shown in Figure 2-2.</p> <p style="text-align: center;">NOTE</p> <p style="text-align: center;">The RDA is cabled the same as a keystation or device (see Figure 2-1).</p>	Figure 2-2
15	<p>Connect RDA from J1 to modem with cable part number 2805096-XX or 2808043-XX as shown in Figure 2-2.</p>	Figure 2-2

Table 2-3. Installation Procedure for Remote Site

Step	Procedure	Reference
1	<p>Unpack devices as described in appropriate servicing manuals and position in applicable installation locations.</p>	HB2358, HB2359, HB2375
2	<p>Strap device address as described in Section 3.</p> <p style="text-align: center;">NOTE</p> <p style="text-align: center;">Up to four devices may be cabled to each remote RDA.</p>	Section 3
3	<p>Ensure that RDA is unpacked as described in Table 2-1.</p>	Table 2-1
4	<p>If not already accomplished, remove RDA top cover. (Loosen two retaining screws at rear of cabinet and back them out 1/4-inch. Tip cover and front panel toward front and lift off.)</p>	
5	<p>Check RDA for broken or cracked connectors on terminal boards, and bent or shorted connector pins. Inspect for foreign material.</p>	
6	<p>Ensure that all push-on terminals within RDA are securely attached to their respective switches, indicators, and potentiometers.</p>	Figure 2-1

Table 2-3. Installation Procedures for Remote Site (Cont)

Step	Procedure	Reference
7	Ensure that all RDA internal cables are properly routed and plugged into appropriate connectors.	Figure 2-1
8	Determine nominal primary ac voltage of the operating location. If necessary, remove cover from RDA power supply module and strap the power supply as described in Section 3.	Section 3
9	Replace RDA power supply module cover, if removed.	
10	Check all RDA modules for proper strapping. Strap modules according to information in Section 3.	Section 3
11	Replace top cover on RDA.	
12	Position RDA at appropriate installation location.	
13	Cable device(s) to RDA J3 as shown in Figure 2-2, ensuring that a terminator (part number 2892077-000) is installed at end of serial connected equipment.	Figure 2-2 Section 3
	<p style="text-align: center;">NOTE</p> <p style="text-align: center;">From one to four devices may be installed at each remote site, depending on system configuration. The local RDA must be strapped for one to four devices, as described in Section 3. The local and remote device strapping must be identical.</p>	
14	Connect RDA from J1 to modem with cable part number 2805096-XX or 2808043-XX.	Figure 2-2

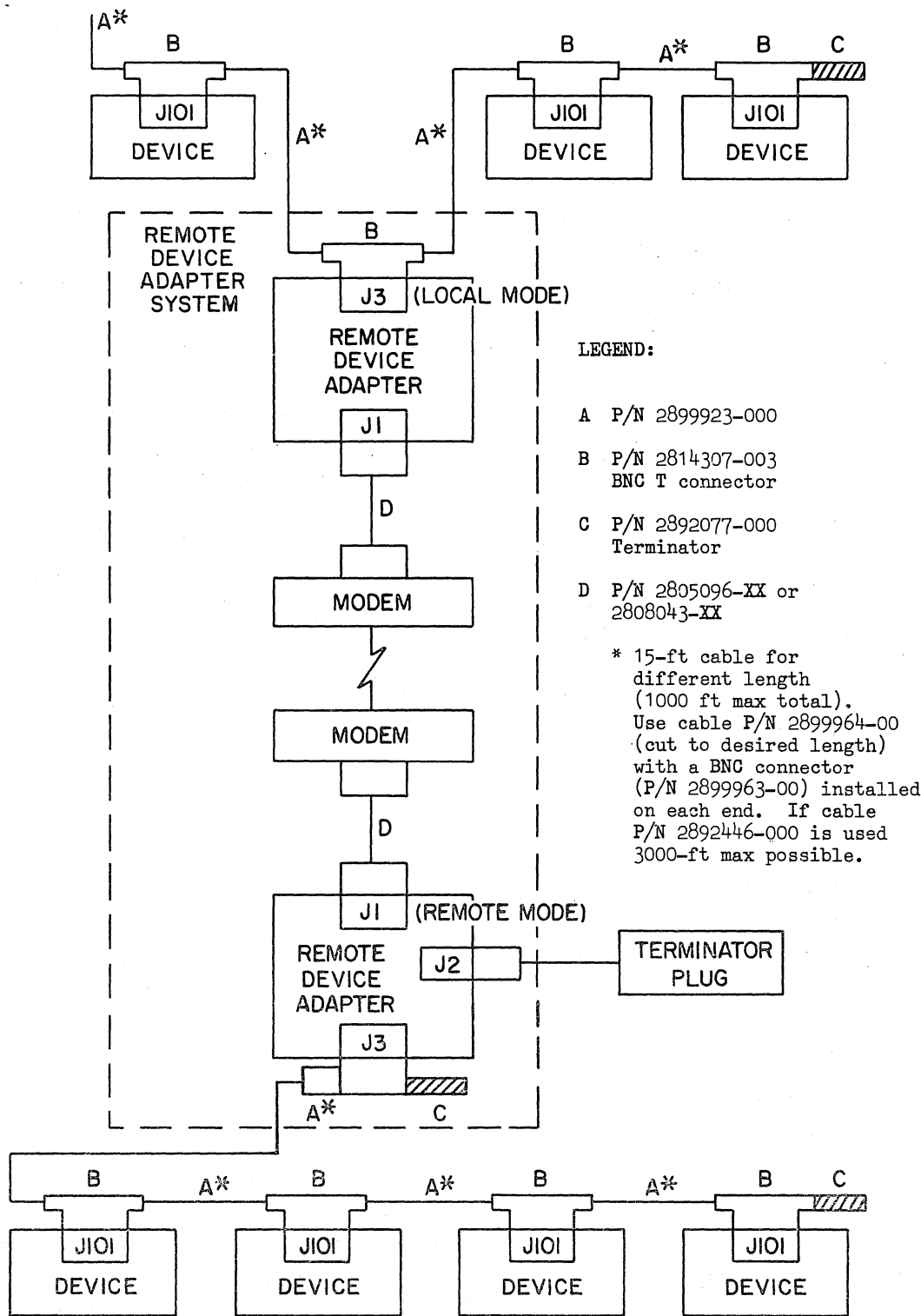

58398

Figure 2-2. Typical RDS Cabling

SECTION 3

STRAPPING

3-1. GENERAL

This section provides the required strapping information for the SPERRY UNIVAC Remote Device Adapter 8598-04, -05 (RDA). Strapping procedures are provided for the power (primary ac voltage input), RDA device addressing strapping, and local/remote programmable read-only memory (PROM) complement. Also included are the modem and remote RDA device address strapping requirements. The strapping procedures are provided in the following paragraphs:

Paragraph 3-2. Power Supply Voltage Range Selection

Paragraph 3-3. Local/Remote RDA Address Strapping

Paragraph 3-4. Local/Remote Strapping

Paragraph 3-5. Remote Device Address Strapping

When any PCAs are removed from the card rack of the RDA for strapping, the PCAs must be replaced in the contiguous block of five card slots in the card rack that the PCAs were removed from. This action is necessary because the backplane of the card rack has been split into four groups of five card slots each to provide for future expansion of the RDA into multiple sets of PCAs.

3-2. POWER SUPPLY VOLTAGE RANGE SELECTION

The only strapping option on the power supply (part number 2036465) is the power line voltage. The voltage range is selected by circuit board A1, which is plugged into connector J03 in one of two ways (see Table 3-1 and Figure 3-1), providing a means to condition the power supply for a line voltage of either 85 to 125 volts ac or 185 to 255 volts ac in the frequency range of 48 to 62 Hz.

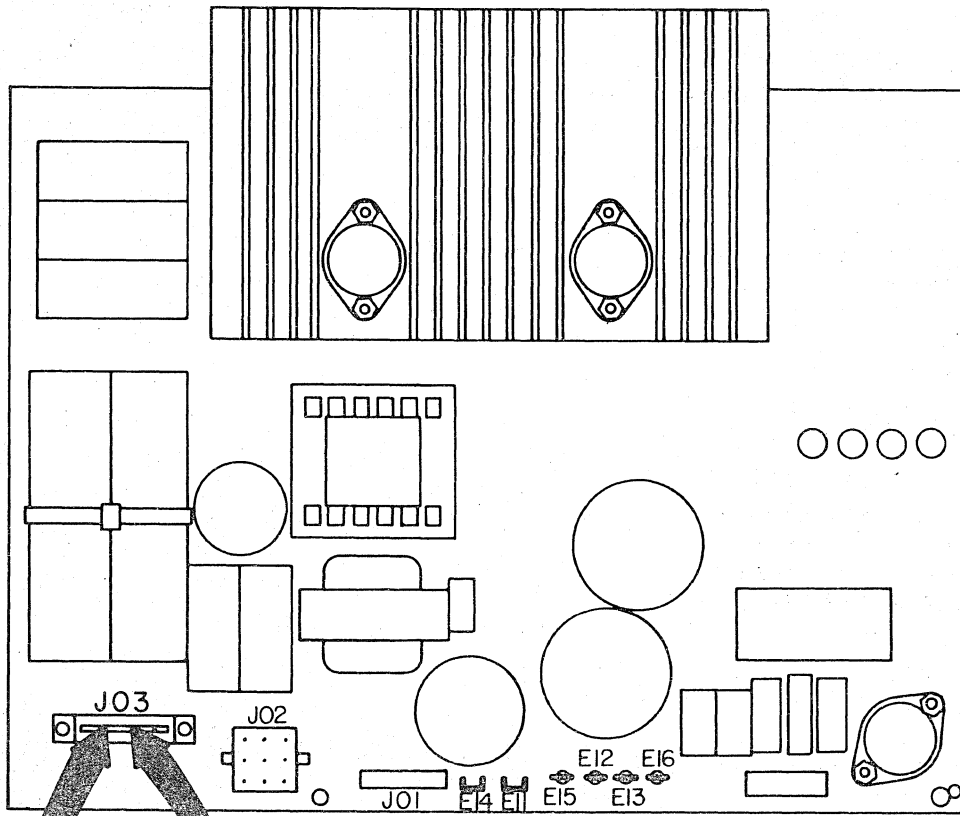

PLUG IN
THIS END
FOR 230 VAC
OPERATION

PLUG IN
THIS END
FOR 115 VAC
OPERATION

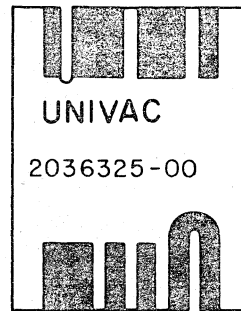
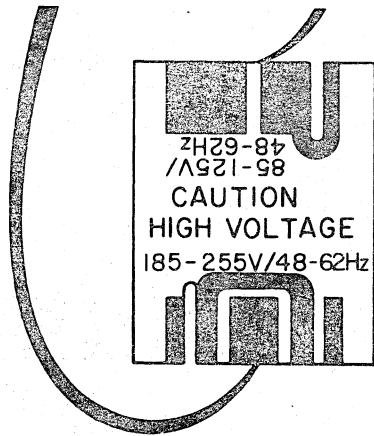

OPPOSITE
SIDE

58399

Figure 3-1. Power Supply Voltage Range Selection

Table 3-1. Power Supply Voltage Range Selection

Voltage Selection	Procedure
85 to 125 volts ac (50/60, 0.5Hz)	Plug the "85 - 125V/48 - 62Hz" end of A1 into J3 (see Figure 3-1).
185 to 255 volts ac (50/60, 0.5Hz)	Plug the "185 - 255V/48 - 62Hz" end of A1 into J3 (see Figure 3-1).

3-3. LOCAL/REMOTE RDA ADDRESS STRAPPING

The local and remote RDAs must be strapped identically to select from one to four remote devices, and to generate the specified device address. An inline switch block is provided on the coaxial interface printed circuit assembly (PCA) (part number 2818796) to accomplish this address strapping (see Figure 3-2).

Remote device address strapping is set by switches 1, 2, 5, and 6 of the switch block (see Figure 3-2) in the local RDA. These switches have the following values when closed:

<u>Switch</u>	<u>Binary Value</u>
Switch 5	32
Switch 6	16
Switch 1	8
Switch 2	4

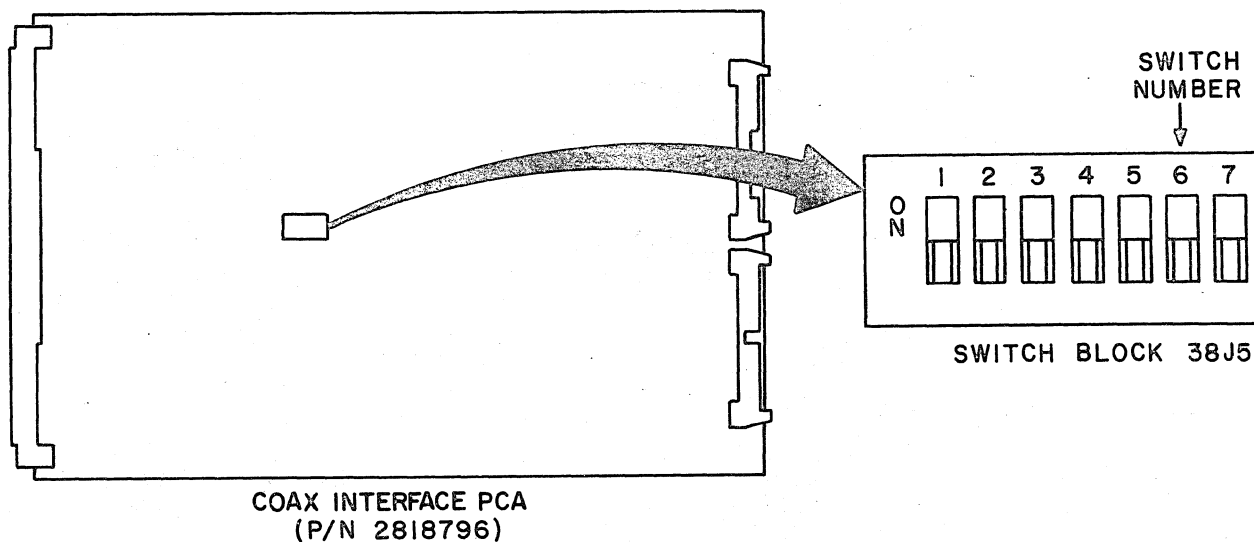

NOTE:

ALL SWITCHES ON SWITCH BLOCK 38J5 ARE SHOWN IN THE OFF POSITION.

58400

Figure 3-2. Remote Device Adapter Strapping

The position of the switches on switch block 38J5 (coaxial interface PCA) designates the address of the first device on the remote RDA. The remaining device(s) are addressed sequentially from this value. For example, if the local RDA is strapped for an address of 52, and strapped for four remote keystations, the keystation addresses are 52, 53, 54, and 55. The strapped RDA address must always be in increments of 4 (4, 8, 12, ... 64).

The selection of from one to four remote devices is accomplished with the device strapping switches on processor PCA (part number 2818795) with switch block 62C2. Figure 3-3 shows the position of this switch block.

The local and remote device selections are accomplished by device strapping switches located on switch block 62C2 on the processor PCA (see Figure 3-3). The local and remote device strapping switches must be identically strapped. Table 3-2 indicates device selection.

Table 3-2. RDA Device Selection (Switch Block 62C2)

Device Type	Selection							
	Device 0		Device 1		Device 2		Device 3	
	SW1	SW3	SW5	SW7	SW8	SW6	SW4	SW2
Device not present	Off	Off	Off	Off	Off	Off	Off	Off
Small 480 char keystation	Off	On	Off	On	Off	On	Off	On
Large 2000 char keystation	On	Off	On	Off	On	Off	On	Off
Station Printer	On	On	On	On	On	On	On	On

The address of Device 0 would correspond to the address selected by the coaxial strapping switches and Device 1 would correspond to that address plus 1, etc. Device addresses that are not selected may be used for local devices.

3-4. LOCAL/REMOTE STRAPPING

The PROM complement of the local and remote processor PCAs are identical. The identity of a local or remote device is provided by switch 1 of the mode selection switch block (38N2) of the processor PCA (see Figure 3-3). Switch 1 must be set to the off position for a local device and to the ON position for a remote device. In addition to switch 1, switch 8 of switch block 38N2 must be set to ON for local/remote and all remaining switches set to off. The switches set to off are reserved for future expansion.

5911-06 } LOCAL RDA PROM Set.
 5911-07 }
 5911-08 } And Remote

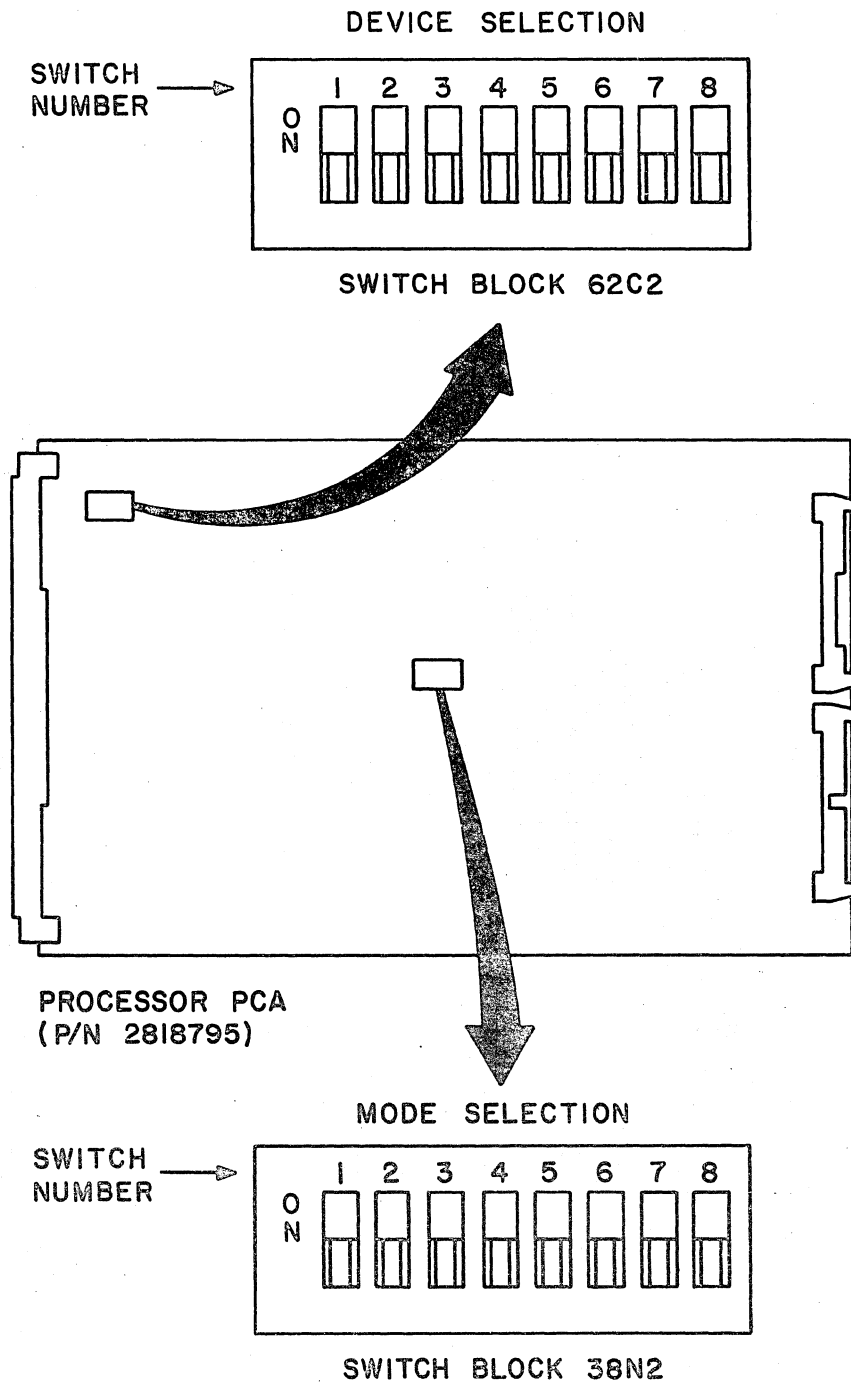

NOTE :

ALL SWITCHES ON SWITCH BLOCKS 38N2 AND 62C2 ARE SHOWN IN THE OFF POSITION.

58401

Figure 3-3. Processor PCA Device and Mode Selection Switch Block Locations

3-5. REMOTE DEVICE ADDRESS STRAPPING

Devices attached to a remote RDA must be addressed as shown in Table 3-3.

Table 3-3. Remote Device Address Requirements

Device (Refer to Table 3-2)	Sample Address
0	52
1	53
2	54
3	55

The device address is the same as the address strapped on the local/remote RDA. For example, if the local/remote RDA is strapped with an address of 52, the first device on the remote RDA would appear to the system to have an address of 52, the second remote device as 53, etc.

SECTION 4

SPECIAL INFORMATION

4-1. GENERAL

This section provides step-by-step test procedures for performing the power-on confidence (POC) tests on the SPERRY UNIVAC Remote Device Adapter Type 8598-04, -05 (RDA). The POC test includes the local and remote tests. This section also provides a special test mode for associated modems and cables.

The local and remote POC tests include self-tests of coaxial interface and processor PCAs using internal self-test firmware. If the test is successful on both PCAs, the READY light on the RDA front panel will light. If the READY light does not light, internal light emitting diode (LED) indicators indicate the successful completion of the POC test by each internal PCA. If the respective PCA passes its POC test, the PCA LED lights.

In addition to the POC hardware integrity testing, the integrity of the communications channel between the local and remote RDA is checked by sending special characters down the line and checking for a response from the opposite end of the communications link. The system will not respond to further tests unless this test is passed.

If the system does not respond to the communications line integrity test, the modem or direct-connection module (DCM) must be switched to test for loopback mode and the special tests described in 4-2 should be conducted.

4-2. SPECIAL TEST MODE

If the communications line integrity test fails, the working status of the local or remote RDA and associated modem or DCM can be verified.

Perform the test to verify the working status of the equipment in doubt as provided in Table 4-1.

Table 4-1. Special Test Mode

Step	Procedure	Reference
1	Set the modem or DCM into its loopback test mode.	
2	Set the switches on the local or remote RDA as follows:	
	a. TEST ON/OFF switch to ON.	Figure 1-3
	b. Press and release RESET switch.	Figure 1-3
	When the READY indicator lights, the test is successful.	Figure 1-3

4-3. SPECIAL OPERATIONAL PROCEDURES

It has been a goal to design the RDA to make the operational use of the remote devices as much like the use of the local devices as possible.

However, there are some procedures for operating remote RDA peripheral devices that are different from local devices. These differences result from the longer propagation times through the communications lines between the remote and local RDAs than through the 1 megaHertz coaxial bus.

All remote coaxial bus devices should be turned on and be online when initiating communication between the remote and local RDAs. In addition, these devices should remain in this state until the 1900 CADE or 1900/10 processor accesses these devices, after which time these devices may be turned off.

When any of the attached remote devices is a 2000-character screen keystation (Type 3555), allow time for the font to be loaded. Do this as follows. After turning on the Type 3555 keystation, wait 1 minute, then press the CONTROL and then the COMMAND keys. The message "READY DEPRESS KEY TO START WORK" should appear on the screen. If this message does not appear on the screen, turn off the keystation, wait for 1 minute, then repeat the process again.

4-4. RDA/RKA COMPARISONS

Although the function of the RDA and the remote keystation adapter (RKA) are similar, there are unique differences to make the reading of this manual necessary to avoid misunderstandings. The basic differences between the RDA and RKA are in the following areas:

- (1) Backplane
- (2) Strapping
- (3) POC tests
- (4) Device support
- (5) Different local/remote firmware

For details of these basic differences, refer to Table 4-2.

Table 4-2. RDA/RKA Comparisons

Function	RDA	RKA
Backplane	Split backplane of four groups of five slots each. Printed circuit assemblies (PCAs) must be plugged into a contiguous group of five slots.	On continuous backplane, PCAs may be plugged in anywhere.
Strapping	<ol style="list-style-type: none"> 1. Device type strapping 2. Local/remote selection 3. Device address 	<ol style="list-style-type: none"> 1. Two or four keystations 2. Device address
POC tests	POC tests test both processor and coaxial PCAs. POC lights on both PCAs. Communications line integrity test not included in POC tests. Remote POC test sends audible alarm signal to each device.	POC tests test only processor PCA. Communications line integrity test included. POC test complete message displayed on screen.
Device support	Supports Type 3541 and 3555 keystations and Type 0798 printer.	Support only Type 3541 keystation.
Local/remote firmware	One set of firmware for local and remote RDA strapping selections.	Different firmware for local and remote RKAs.

SECTION 5
DEINSTALLATION

5-1. GENERAL

This section contains general instructions for disconnecting and packing the SPERRY UNIVAC Remote Device Adapter Type 8598-04, -05 (RDA) in preparation for shipment. Table 5-1 lists the cleaning material and equipment required to prepare RDA for shipment. Table 5-2 contains instructions for disconnecting and packing the RDA.

Table 5-1. Cleaning Materials and Equipment

Quantity	Description
1 pint	Mild household detergent
1	Vacuum cleaner
As required	Clean, dry, lint-free cloth

NOTE

If the original packing materials were saved, order new binding straps to replace the original straps. If the original packing materials were not saved, order a new shipping container.

5-2. DEINSTALLATION

Deinstall and prepare the RDA for shipment as described in Table 5-2.

Table 5-2. DeInstallation

Step	Procedure
1	Ensure that power is turned off at RDA to be deinstalled.
2	Disconnect ac power cables at user's receptacle.
3	Disconnect all interface cables at rear of terminal.
4	Remove casework.
5	Vacuum all accessible parts of terminal.
6	Replace casework and ensure that fasteners are secure.
7	Clean casework.
8	Pack unit in polystyrene container.
9	Bind sections of container together.
10	Carefully place polystyrene container in cardboard container and seal container.
11	Stencil or mark cardboard container for shipment as required.