

68HC705RC16

General Release Specification

December 13, 1996

CSIC MCU Design Center
Austin, Texas

List of Sections

Section 1. General Description 15

Section 2. Memory 25

Section 3. Central Processor Unit 31

Section 4. Interrupts 35

Section 5. Resets 43

Section 6. Low-Power Modes 51

Section 7. Parallel Input/Output (I/O) 55

Section 8. Core Timer 59

Section 9. Carrier Modulator Transmitter (CMT) 65

Section 10. EPROM 83

Section 11. Instruction Set 89

Section 12. Electrical Specifications 107

Section 13. Mechanical Specifications 113

Section 14. Ordering Information 117

Table of Contents

Section 1. General Description

1.1	Contents	15
1.2	Introduction	16
1.3	Features	16
1.4	Mask Options	17
1.5	Signal Description	19
1.5.1	V_{DD} and V_{SS}	20
1.5.2	\overline{IRQ}/V_{PP} (Maskable Interrupt Request)	20
1.5.3	OSC1 and OSC2	21
1.5.4	\overline{RESET}	22
1.5.5	\overline{LPRST}	22
1.5.6	IRO	22
1.5.7	PA0—PA7	22
1.5.8	PB0—PB7	22
1.5.9	PC0—PC3 (PC4—PC7)	23

Section 2. Memory

2.1	Contents	25
2.2	Introduction	25
2.3	Memory Map	25
2.3.1	EPROM	28
2.3.2	EPROM Security	28
2.3.3	RAM	29
2.3.4	Bootloader ROM	29
2.4	Input/Output Programming	29

Section 3. Central Processor Unit

3.1 Contents31
3.2 Introduction31
3.3 Accumulator32
3.4 Index Register.32
3.5 Condition Code Register.33
3.6 Stack Pointer34
3.7 Program Counter34

Section 4. Interrupts

4.1 Contents35
4.2 Introduction35
4.3 CPU Interrupt Processor.36
4.4 Reset Interrupt Sequence.37
4.5 Software Interrupt (SWI)37
4.6 Hardware Interrupts39
4.7 External Interrupt (IRQ/Port B Pullup)39
4.8 External Interrupt Timing40
4.9 Carrier Modulator Transmitter Interrupt (CMT)40
4.10 Core Timer Interrupt41

Section 5. Resets

5.1 Contents43
5.2 Introduction43
5.3 External Reset ($\overline{\text{RESET}}$)44
5.4 Low-Power External Reset (LPRST)46

5.5	Internal Resets	46
5.5.1	Power-On Reset (POR).	46
5.5.2	Computer Operating Properly Reset (COPR)	47
5.5.2.1	Resetting the COP	47
5.5.2.2	COP During Wait Mode	47
5.5.2.3	COP During Stop Mode	47
5.5.2.4	COP Watchdog Timer Considerations	48
5.5.2.5	COP Register	49
5.5.3	Illegal Address	49

Section 6. Low-Power Modes

6.1	Contents	51
6.2	Introduction	51
6.3	Stop Mode	51
6.4	Stop Recovery	52
6.5	Wait Mode	52
6.6	Low-Power Reset	53

Section 7. Parallel Input/Output (I/O)

7.1	Contents	55
7.2	Introduction	55
7.3	Port A	55
7.4	Port B	56
7.5	Port C	56
7.6	Input/Output Programming	57

Section 8. Core Timer

8.1	Contents	59
8.2	Introduction	59
8.3	Core Timer Control and Status Register	61

8.4 Core Timer Counter Register63
 8.5 Computer Operating Properly (COP) Reset64
 8.6 Timer During Wait Mode64

Section 9. Carrier Modulator Transmitter (CMT)

9.1 Contents65
 9.2 Introduction65
 9.3 Overview66
 9.4 Carrier Generator68
 9.4.1 Time Counter69
 9.4.2 Carrier Generator Data Registers
 (CHR1, CLR1, CHR2, and CLR2)70
 9.5 Modulator72
 9.5.1 Time Mode74
 9.5.2 FSK Mode75
 9.5.3 Extended Space Operation76
 9.5.3.1 End Of Cycle (EOC) Interrupt77
 9.5.3.2 Modulator Control and Status Register78
 9.5.4 Modulator Period Data Registers
 (MDR1, MDR2, and MDR3)81

Section 10. EPROM

10.1 Contents83
 10.2 Introduction83
 10.3 EPROM83
 10.4 Bootloader84
 10.4.1 Bootloader Functions84
 10.4.2 Programming Register86
 10.4.3 Mask Option Registers (MOR1 and MOR2)87

Section 11. Instruction Set

11.1 Contents89

11.2 Introduction90

11.3 Addressing Modes90

11.3.1 Inherent91

11.3.2 Immediate91

11.3.3 Direct91

11.3.4 Extended91

11.3.5 Indexed, No Offset92

11.3.6 Indexed, 8-Bit Offset92

11.3.7 Indexed,16-Bit Offset.92

11.3.8 Relative93

11.4 Instruction Types93

11.4.1 Register/Memory Instructions94

11.4.2 Read-Modify-Write Instructions95

11.4.3 Jump/Branch Instructions96

11.4.4 Bit Manipulation Instructions98

11.4.5 Control Instructions99

11.5 Instruction Set Summary100

Section 12. Electrical Specifications

12.1 Contents107

12.2 Introduction107

12.3 Maximum Ratings108

12.4 Operating Temperature Range109

12.5 Thermal Characteristics109

12.6 DC Electrical Characteristics (5.0 Vdc).110

12.7 DC Electrical Characteristics (3.3 Vdc).111

12.8 Control Timing (5.0 Vdc and 3.3 Vdc).112

Section 13. Mechanical Specifications

13.1 Contents113

13.2 Introduction113

13.3 28-Pin Plastic Dual In-Line Package
(Case 710-02)114

13.4 28-Pin Small Outline Integrated Circuit Package
(Case 751F-04)114

13.5 44-Pin Plastic Leaded Chip Carrier
Package (Case 777-02)115

Section 14. Ordering Information

14.1 Contents117

14.2 Introduction117

14.3 Ordering Information117

List of Figures

Figure	Title	Page
1-1	MC68HC705RC16 Block Diagram	18
1-2	28-Pin DIP Pinout	19
1-3	28-Pin SOIC Assignments	19
1-4	44-Pin PLCC Pinout	20
1-5	Oscillator Connections	22
2-1	16-KByte Memory Map	26
2-2	I/O Registers	27
3-1	Programming Model	31
3-2	Stacking Order	32
4-1	Interrupt Processing Flowchart	38
4-2	IRQ Function Block Diagram	39
5-1	Reset Block Diagram	44
5-2	Reset and POR Timing Diagram	45
5-3	COP Watchdog Timer Location	49
6-1	Stop Recovery Timing Diagram	52
6-2	Stop/Wait Flowchart	54
7-1	Port B Pullup Option	56
7-2	I/O Circuitry	58
8-1	Core Timer Block Diagram	60
8-2	Core Timer Control and Status Register (CTCSR)	61
8-3	Core Timer Counter Register (CTCR)	63

Figure	Title	Page
9-1	Carrier Modulator Transmitter Module Block Diagram	67
9-2	Carrier Generator Block Diagram	68
9-3	Carrier Generator Data Register CHR1	70
9-4	Carrier Generator Data Register CLR1	70
9-5	Carrier Generator Data Register CHR2	70
9-6	Carrier Generator Data Register CLR2	71
9-7	Modulator Block Diagram	73
9-8	CMT Operation in Time Mode	75
9-9	Extended Space Operation	77
9-10	Modulator Control and Status Register (MCSR)	78
9-11	Modulator Period Data Register MDR1	81
9-12	Modulator Period Data Register MDR2	81
9-13	Modulator Period Data Register MDR3	81
10-1	Programmer Interface to Host	84
10-2	MC68HC705RC16 Programming Circuit	85
10-3	Programming Register (PROG)	86
10-4	Mask Option Register 1 (MOR1)	87
10-5	Mask Option Register 2 (MOR2)	87

List of Tables

Table	Title	Page
4-1	Vector Address for Interrupts and Reset	36
5-1	COP Watchdog Timer Recommendations	48
7-1	I/O Pin Functions	57
8-1	RTI and COP Rates at 4.096 MHz Oscillator	62
10-1	Bootloader Functions	84
11-1	Register/Memory Instructions	94
11-2	Read-Modify-Write Instructions	95
11-3	Jump and Branch Instructions	97
11-4	Bit Manipulation Instructions	98
11-5	Control Instructions	99
11-6	Instruction Set Summary	100
11-7	Opcode Map	106
14-1	MC Order Numbers	117

Section 1. General Description

1.1 Contents

1.2	Introduction	16
1.3	Features	16
1.4	Mask Options	17
1.5	Signal Description	19
1.5.1	V_{DD} and V_{SS}	20
1.5.2	\overline{IRQ}/V_{PP} (Maskable Interrupt Request)	20
1.5.3	$\overline{OSC1}$ and $\overline{OSC2}$	21
1.5.4	\overline{RESET}	22
1.5.5	\overline{LPRST}	22
1.5.6	IRO	22
1.5.7	PA0–PA7	22
1.5.8	PB0–PB7	22
1.5.9	PC0–PC3 (PC4–PC7)	23

1.2 Introduction

The MC68HC705RC16 is a low-cost addition to the M68HC05 Family of microcontrollers (MCUs) and is suitable for remote control applications. It contains the HC05 CPU core, including the 14-stage core timer with RTI and COP watchdog systems. On-chip peripherals include a carrier modulator transmitter. The 16-Kbyte memory map has 15,936 bytes of user EPROM, 340 bytes of boot ROM, and 352 bytes of RAM. There are 20 input/output (I/O) lines (eight having keyscan pullups/interrupts) and a low-power reset pin.

The MC68HC705RC16 is available in 28-pin small outline integrated circuit (SOIC), dual in-line (DIP), or plastic leaded chip carrier (PLCC) packages. Four additional I/O lines are available for bond out in the 44-lead PLCC package.

1.3 Features

Features of the MC68HC705RC16 are:

- Low Cost
- HC05 Core
- 28-Pin Plastic Dual In-Line (PDIP), Small Outline Integrated Circuit (SOIC), or 44-Lead Plastic Leaded Chip Carrier (PLCC) Packages
- On-Chip Oscillator with Crystal/Ceramic Resonator
- 4-MHz Maximum Oscillator Frequency at 5 V and 3.3 V Supply
- Fully Static Operation
- 15,936 Bytes of User ROM
- 64 Bytes of Burn-In ROM
- 352 Bytes of On-Chip RAM
- 14-Stage Core Timer with Real-Time Interrupt (RTI) and Computer Operating Properly (COP) Watchdog Circuits

- Carrier Modulator Transmitter Supporting Baseband, Pulse Length Modulator (PLM), and Frequency Shift Keying (FSK) Protocols
- Low-Power Reset Pin
- 20 Bidirectional I/O Lines (Four Additional I/O Lines Available for Bond Out in 44-Lead PLCC Package)
- Mask Programmable Pullups and Interrupt on Eight Port Pins (PB0–PB7)
- High-Current Infrared (IR) Drive Pin
- High-Current Port Pin (PC0)
- Power-Saving Stop and Wait Modes
- Mask Selectable Options:
 - COP Watchdog Timer
 - STOP Instruction Disable
 - Edge-Sensitive or Edge- and Level-Sensitive Interrupt Trigger
 - Port B Pullups for Keyscan

1.4 Mask Options

The mask options on the MC68HC705RC16 are handled with 11 EPROM bits in two separate MOR registers, MOR1 and MOR2. These options are:

- Eight port B pullups
- IRQ sensitivity
- STOP enable/disable
- COP enable/disable

ROM versions of this device will have these options programmed by the factory.

NOTE: *A line over a signal name indicates an active low signal. For example, RESET is active low.*

General Description

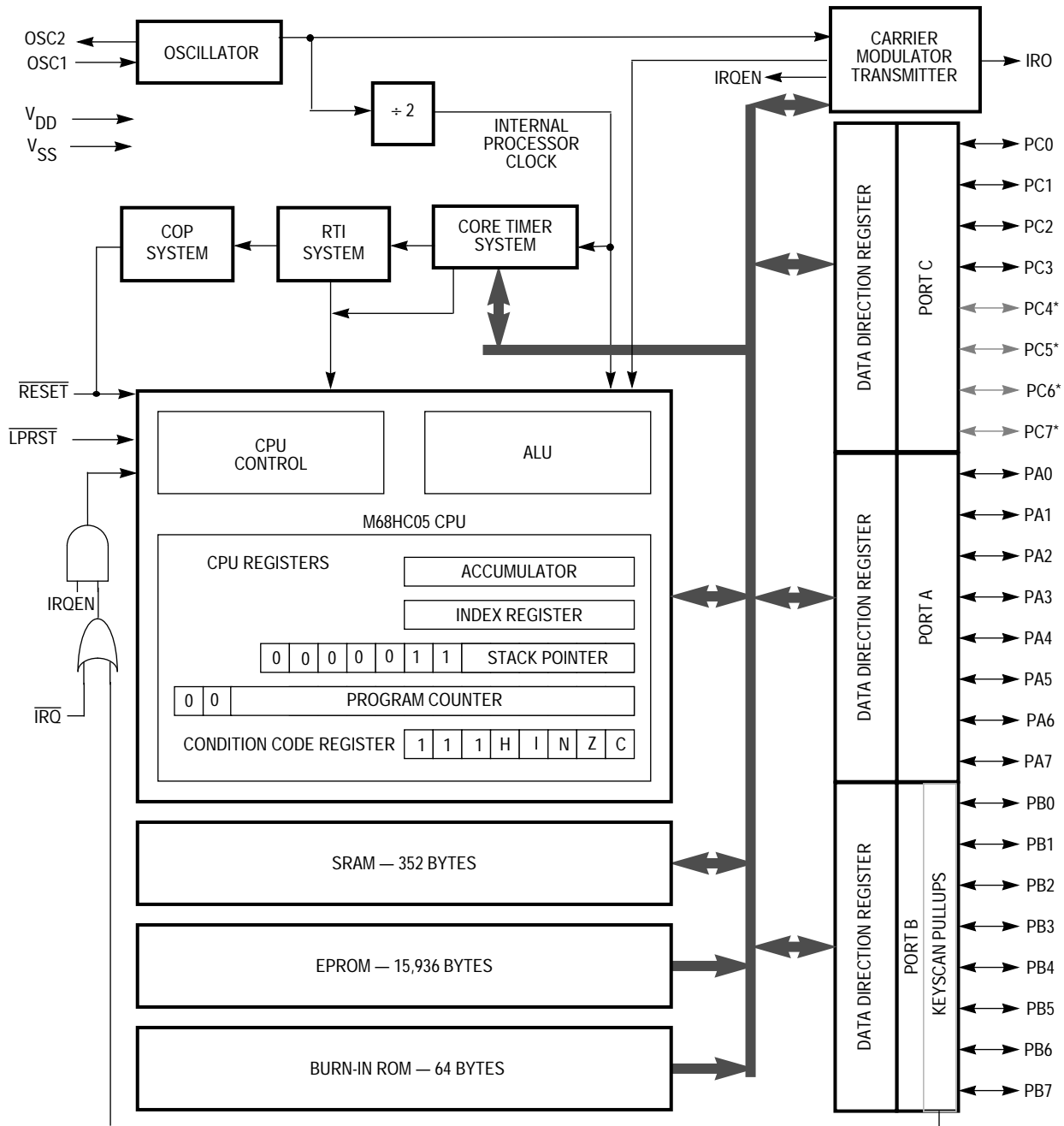

* Marked pins are available only in higher pin count (>28) packages.

Figure 1-1. MC68HC705RC16 Block Diagram

1.5 Signal Description

Pinout for the 28-pin dual in-line package (DIP) is shown in **Figure 1-2**. **Figure 1-3** provides the pinout for the 28-pin small outline integrated circuit (SOIC) package. **Figure 1-4** shows the pinout for the 44-lead plastic leaded chip carrier (PLCC). The signals are described in the following subsections.

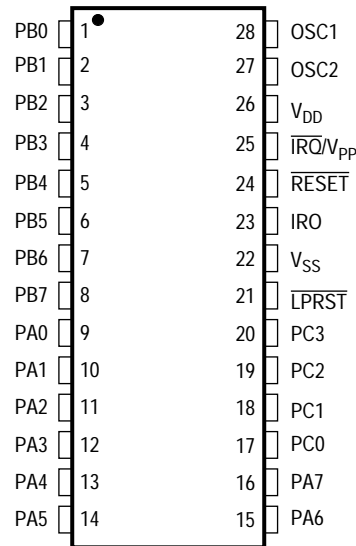

Figure 1-2. 28-Pin DIP Pinout

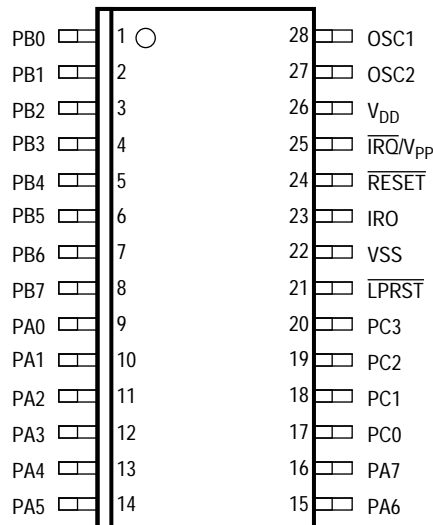
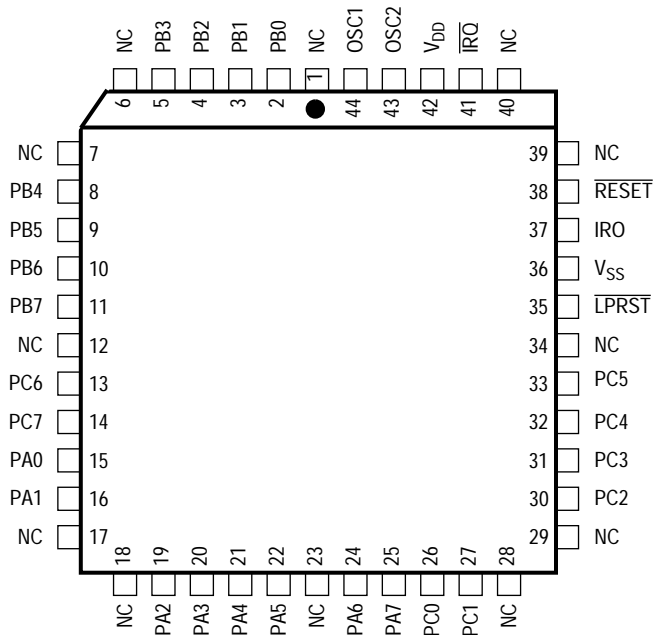

Figure 1-3. 28-Pin SOIC Assignments



NOTE: NC = No Connect
 All no connects should be tied to an appropriate logic level (either V_{DD} or V_{SS}).

Figure 1-4. 44-Pin PLCC Pinout

1.5.1 V_{DD} and V_{SS}

Power is supplied to the microcontroller’s digital circuits using these two pins. V_{DD} is the positive supply and V_{SS} is ground.

1.5.2 $\overline{\text{IRQ}}/V_{pp}$ (Maskable Interrupt Request)

In addition to supplying the EPROM with the required programming voltage, this pin has a mask option as specified by the user that provides one of two different choices of interrupt triggering sensitivity. The options are:

1. Negative edge-sensitive triggering only
2. Both negative edge-sensitive and level-sensitive triggering.

The MCU completes the current instruction before it responds to the interrupt request. When $\overline{\text{IRQ}}$ goes low for at least one t_{ILIH} (see [12.8 Control Timing \(5.0 Vdc and 3.3 Vdc\)](#)), a logic 1 is latched internally to signify that an interrupt has been requested. When the MCU completes its current instruction, the interrupt latch is tested. If the interrupt latch contains a logic 1 and the interrupt mask bit (I bit) in the condition code register is clear, the MCU then begins the interrupt sequence.

If the option is selected to include level-sensitive triggering, the $\overline{\text{IRQ}}$ input requires an external resistor to V_{DD} for wired-OR operation.

The $\overline{\text{IRQ}}$ pin contains an internal Schmitt trigger as part of its input to improve noise immunity.

Refer to [4.2 Introduction](#) for more detail.

1.5.3 OSC1 and OSC2

These pins provide control input for an on-chip clock oscillator circuit. A crystal, a ceramic resonator, or an external signal connects to these pins to provide a system clock. The oscillator frequency is two times the internal bus rate.

[Figure 1-5](#) shows the recommended circuit when using a crystal. The crystal and components should be mounted as close as possible to the input pins to minimize output distortion and startup stabilization time.

A ceramic resonator may be used in place of the crystal in cost-sensitive applications. [Figure 1-5](#) (a) shows the recommended circuit for using a ceramic resonator. The manufacturer of the particular ceramic resonator being considered should be consulted for specific information.

An external clock should be applied to the OSC1 input with the OSC2 pin not connected (see [Figure 1-5](#) (b)). This setup can be used if the user does not want to run the CPU with a crystal.

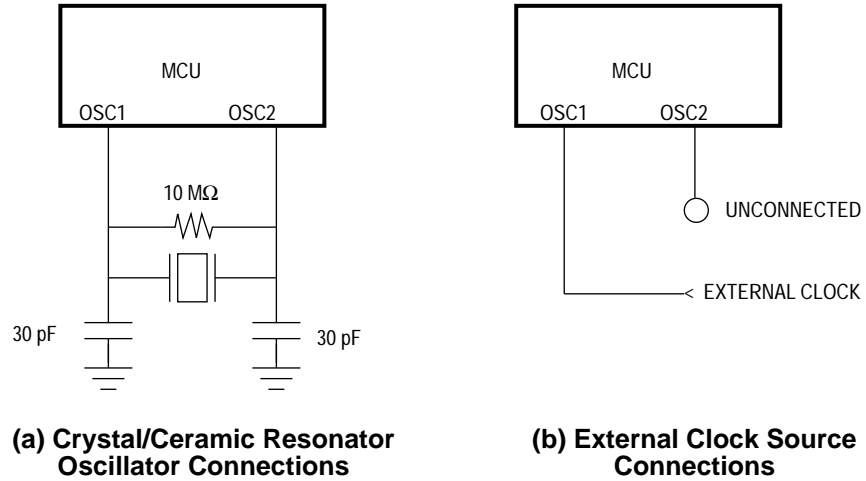

Figure 1-5. Oscillator Connections

1.5.4 $\overline{\text{RESET}}$

This active-low pin is used to reset the MCU to a known start-up state by pulling $\overline{\text{RESET}}$ low. The $\overline{\text{RESET}}$ pin contains an internal Schmitt trigger as part of its input to improve noise immunity. See [Section 5. Resets](#).

1.5.5 LPRST

The $\overline{\text{LPRST}}$ pin is an active-low pin and is used to put the MCU into low-power reset mode. In low-power reset mode the MCU is held in reset with all processor clocks halted. See [Section 5. Resets](#).

1.5.6 IRO

The IRO pin is the high-current source and sink output of the carrier modulator transmitter subsystem which is suitable for driving infrared (IR) LED biasing logic. See [Section 9. Carrier Modulator Transmitter \(CMT\)](#).

1.5.7 PA0–PA7

These eight I/O lines comprise port A. The state of any pin is software programmable and all port A lines are configured as inputs during power-on or reset. For detailed information on I/O programming, see [2.4 Input/Output Programming](#).

1.5.8 PB0–PB7

These eight I/O lines comprise port B. The state of any pin is software programmable and all port B lines are configured as inputs during power-on or reset. Each port B I/O line has a mask optionable pullup/interrupt for keyscan. For detailed information on I/O programming, see [2.4 Input/Output Programming](#).

1.5.9 PC0–PC3 (PC4–PC7)

These eight I/O lines comprise port C. PC0 is a high-current pin. PC4–PC7 are available only in the 44-lead PLCC package. The state of any pin is software programmable and all port C lines are configured as input during power-on or reset. For detailed information on I/O programming, see [2.4 Input/Output Programming](#).

NOTE: *Only four bits of port C are bonded out in 28-pin packages for the MC68HC705RC16, although port C is truly an 8-bit port. Since pins PC4–PC7 are unbonded, software should include the code to set their respective data direction register locations to outputs to avoid floating inputs.*

NOTE: *Any unused inputs, I/O ports, and no connects should be tied to an appropriate logic level (either V_{DD} or V_{SS}). Although the I/O ports of the MC68HC705RC16 do not require termination, termination is recommended to reduce the possibility of static damage.*

Section 2. Memory

2.1 Contents

2.2	Introduction	25
2.3	Memory Map	25
2.3.1	EPROM	28
2.3.2	EPROM Security	28
2.3.3	RAM	29
2.3.4	Bootloader ROM	29
2.4	Input/Output Programming	29

2.2 Introduction

This section describes the organization of the on-chip memory.

2.3 Memory Map

The MC68HC705RC16 has a 16-Kbyte memory map consisting of user EPROM, RAM, burn-in ROM, and input/output (I/O).

Figure 2-1 shows the MC68HC705RC16 memory map in user mode.

Memory

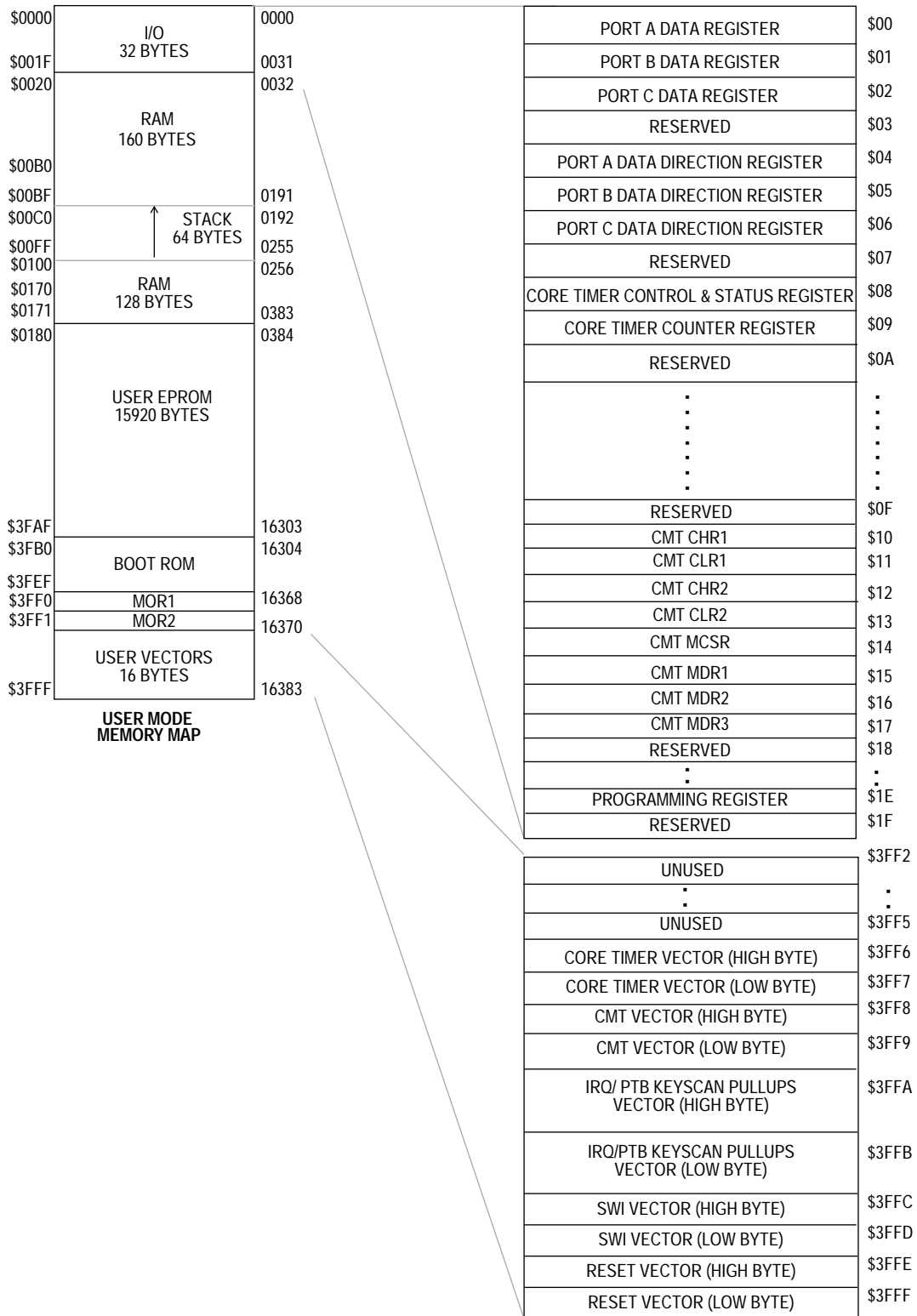

Figure 2-1. 16-KByte Memory Map

Addr.	Register	Bit 7	6	5	4	3	2	1	Bit 0
\$0000	Port A Data Register								
\$0001	Port B Data Register								
\$0002	Port C Data Register								
\$0003	Reserved	R	R	R	R	R	R	R	R
\$0004	Port A Data Direction Register								
\$0005	Port B Data Direction Register								
\$0006	Port C Data Direction Register								
\$0007	Reserved	R	R	R	R	R	R	R	R
\$0008	Timer Control and Status Reg.	CTOF	RTIF	TOFE	RTIE	TOFC	RTFC	RT1	RT0
\$0009	Timer Counter Register								
\$000A	Reserved	R	R	R	R	R	R	R	R
\$000B	Reserved	R	R	R	R	R	R	R	R
\$000C	Reserved	R	R	R	R	R	R	R	R
\$000D	Reserved	R	R	R	R	R	R	R	R
\$000E	Reserved	R	R	R	R	R	R	R	R
\$000F	Reserved	R	R	R	R	R	R	R	R
\$0010	IR Timer CHR1	IROLN	0	PH5	PH4	PH3	PH2	PH1	PH0
\$0011	IR Timer CLR1	IROLP	0	PL5	PL4	PL3	PL2	PL1	PL0
\$0012	IR Timer CHR2	0	0	SH5	SH4	SH3	SH2	SH1	SH0
\$0013	IR Timer CLR2	0	0	SL5	SL4	SL3	SL2	SL1	SL0
\$0014	IR Timer MCSR	EOC	0	EIMSK	EXMRK	BASE	MODE	EOCIE	MCGEN
\$0015	IR Timer MDR1	MB11	MB10	MB9	MB8	SB11	SB10	SB9	SB8
\$0016	IR Timer MDR2	MB7	MB6	MB5	MB4	MB3	MB2	MB1	MB0
\$0017	IR Timer MDR3	SB7	SB6	SB5	SB4	SB3	SB2	SB1	SB0
\$0018	Reserved	R	R	R	R	R	R	R	R
\$0019	Reserved	R	R	R	R	R	R	R	R

R

 = Reserved

Figure 2-2. I/O Registers

Memory

Addr.	Register	Bit 7	6	5	4	3	2	1	Bit 0
\$001A	Reserved	R	R	R	R	R	R	R	R
\$001B	Reserved	R	R	R	R	R	R	R	R
\$001C	Reserved	R	R	R	R	R	R	R	R
\$001D	Reserved	R	R	R	R	R	R	R	R
\$001E	Reserved	R	R	R	R	R	R	R	R
\$001F	Reserved	R	R	R	R	R	R	R	R

R = Reserved

Figure 2-2. I/O Registers (Continued)

2.3.1 EPROM

The user EPROM consists of 15,936 bytes of EPROM from \$0180 to \$3FAF and 14 bytes of user vectors from \$3FF2 to \$3FFF.

The bootloader ROM and vectors are located from \$3FB0 to \$3FEF.

Ten of the user vectors, \$3FF6 through \$3FFF, are dedicated to reset and interrupt vectors. The four remaining locations, \$3FF2–\$3FF5 are general-purpose user EPROM locations. The mask option registers (MOR1 and MOR2) are located at \$3FF0 and \$3FF1.

2.3.2 EPROM Security

The MC68HC705RC16 contains special circuitry to prevent accessing the EPROM in nonuser mode. Emulation is not affected by security.

Security is controlled by a security bit in the MOR1 register. The security bit is intended to be programmed while the code is being programmed.. When set, this will inhibit reading of the EPROM in all modes other than user mode.¹

1. No security feature is absolutely secure. However, Motorola's strategy is to make reading or copying the ROM difficult for unauthorized users.

2.3.3 RAM

The user RAM consists of 352 bytes of a shared stack area. The RAM starts at address \$0020 and ends at address \$017F. The stack begins at address \$00FF. The stack pointer can access 64 bytes of RAM in the range \$00FF to \$00C0.

NOTE: *Using the stack area for data storage or temporary work locations requires care to prevent it from being overwritten due to stacking from an interrupt or subroutine call.*

2.3.4 Bootloader ROM

Addresses \$3FB0 to \$3FEF are reserved ROM addresses that contain the instructions for the bootloader functions. (See [Section 10. EPROM.](#))

2.4 Input/Output Programming

In user mode, 20 lines (28-pin PDIP or 28-pin SOIC) or 24 lines (44-lead PLCC) are arranged as three 8-bit I/O ports. These ports are programmable as either inputs or outputs under software control of the data direction registers. For detailed information, refer to [Section 7. Parallel Input/Output \(I/O\).](#)

Section 3. Central Processor Unit

3.1 Contents

3.2	Introduction	31
3.3	Accumulator	32
3.4	Index Register.	32
3.5	Condition Code Register.	33
3.6	Stack Pointer	34
3.7	Program Counter	34

3.2 Introduction

This section describes the registers of the MC68HC705RC16 central processor unit (CPU). The MCU contains five registers as shown in **Figure 3-1**. The interrupt stacking order is shown in **Figure 3-2**.

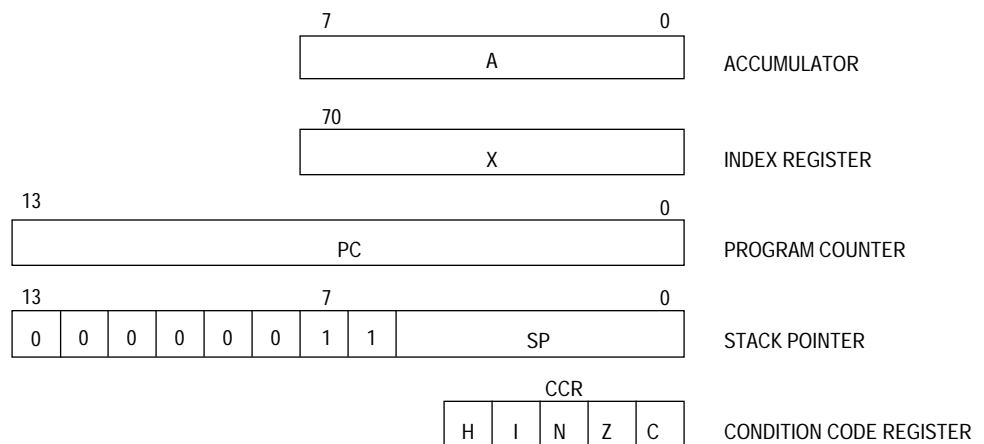
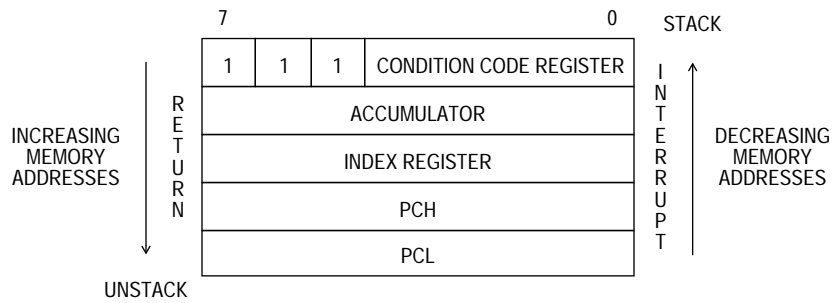

Figure 3-1. Programming Model



NOTE: Since the stack pointer decrements during pushes, the PCL is stacked first, followed by PCH, etc. Pulling from the stack is in the reverse order.

Figure 3-2. Stacking Order

3.3 Accumulator

The accumulator (A) is a general-purpose 8-bit register used to hold operands and results of arithmetic calculations or data manipulations.

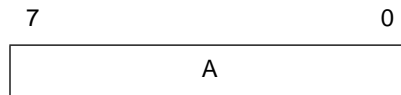

3.4 Index Register

The index register (X) is an 8-bit register used for the indexed addressing value to create an effective address. The index register also may be used as a temporary storage area.

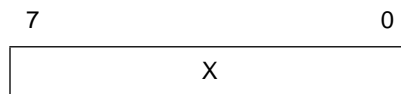

3.5 Condition Code Register

The condition code register (CCR) is a 5-bit register in which four bits are used to indicate the results of the instruction just executed, and the fifth bit indicates whether interrupts are masked. These bits can be tested individually by a program, and specific actions can be taken as a result of their state. Each bit is explained in the following paragraphs.

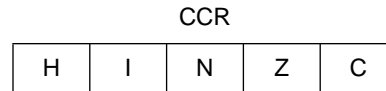

H — Half Carry

This bit is set during ADD and ADC operations to indicate that a carry occurred between bits 3 and 4.

I — Interrupt

When this bit is set, timer and external interrupts are masked (disabled). If an interrupt occurs while this bit is set, the interrupt is latched and processed as soon as the interrupt bit is cleared.

N — Negative

When set, this bit indicates that the result of the last arithmetic, logical, or data manipulation was negative.

Z — Zero

When set, this bit indicates that the result of the last arithmetic, logical, or data manipulation was zero.

C — Carry/Borrow

When set, this bit indicates that a carry or borrow out of the arithmetic logical unit (ALU) occurred during the last arithmetic operation. This bit is also affected during bit test and branch instructions and during shifts and rotates.

3.6 Stack Pointer

The stack pointer (SP) contains the address of the next free location on the stack. During an MCU reset or the reset stack pointer (RSP) instruction, the stack pointer is set to location \$00FF. The stack pointer is then decremented as data is pushed onto the stack and incremented as data is pulled from the stack.

When accessing memory, the seven most significant bits are permanently set to 0000011. These seven bits are appended to the six least significant register bits to produce an address within the range of \$00FF to \$00C0. Subroutines and interrupts may use up to 64 (decimal) locations. If 64 locations are exceeded, the stack pointer wraps around and loses the previously stored information. A subroutine call occupies two locations on the stack; an interrupt uses five locations.

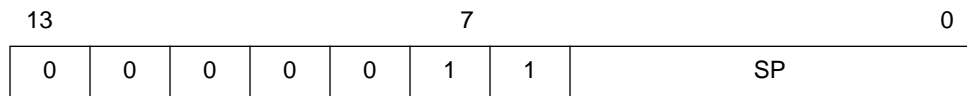

3.7 Program Counter

The program counter (PC) is a 13-bit register that contains the address of the next byte to be fetched.

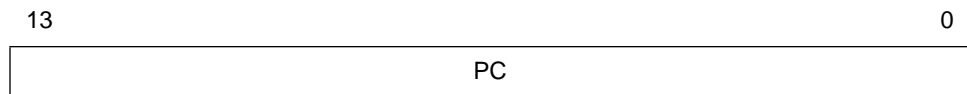

NOTE: *The HC05 CPU core is capable of addressing a 64-Kbyte memory map. For this implementation, however, the addressing registers are limited to an 16-Kbyte memory map.*

Section 4. Interrupts

4.1 Contents

4.2	Introduction	35
4.3	CPU Interrupt Processor	36
4.4	Reset Interrupt Sequence	37
4.5	Software Interrupt (SWI)	37
4.6	Hardware Interrupts	39
4.7	External Interrupt ($\overline{\text{IRQ}}$ /Port B Pullup)	39
4.8	External Interrupt Timing	40
4.9	Carrier Modulator Transmitter Interrupt (CMT)	40
4.10	Core Timer Interrupt	41

4.2 Introduction

The MCU can be interrupted four different ways:

1. Nonmaskable software interrupt instruction (SWI)
2. External asynchronous interrupt ($\overline{\text{IRQ}}$ /port B keyscan)
3. Internal carrier modulator transmitter interrupt
4. Internal core timer interrupt

4.3 CPU Interrupt Processor

Interrupts cause the processor to save register contents on the stack and to set the interrupt mask (I bit) to prevent additional interrupts. Unlike reset, hardware interrupts do not cause the current instruction execution to be halted, but are considered pending until the current instruction is complete.

If interrupts are not masked (I bit in the CCR is clear) and the corresponding interrupt enable bit is set, the processor will proceed with interrupt processing. Otherwise, the next instruction is fetched and executed. If an interrupt occurs, the processor completes the current instruction, stacks the current CPU register state, sets the I bit to inhibit further interrupts, and finally checks the pending hardware interrupts. If more than one interrupt is pending after the stacking operation, the interrupt with the highest vector location shown in [Table 4-1](#) will be serviced first. The SWI is executed the same as any other instruction, regardless of the I-bit state.

When an interrupt is to be processed, the CPU fetches the address of the appropriate interrupt software service routine from the vector table at locations \$3FF6–\$3FFF as defined in [Table 4-1](#).

Table 4-1. Vector Address for Interrupts and Reset

Register	Flag Name	Interrupt	CPU Interrupt	Vector Address
N/A	N/A	Reset	RESET	\$3FFE–\$3FFF
N/A	N/A	Software Interrupt	SWI	\$3FFC–\$3FFD
N/A	N/A	External Interrupts*	IRQ	\$3FFA–\$3FFB
MCSR	EOC	End of Cycle Interrupt	CMT	\$3FF8–\$3FF9
CTCSR	CTOF, RTIF	Real-Time Interrupt Core Timer Overflow	CORE TIMER	\$3FF6–\$3FF7

*External interrupts include $\overline{\text{IRQ}}$ and port B keyscan sources.

The M68HC05 CPU does not support interruptible instructions. The maximum latency to the first instruction of the interrupt service routine must include the longest instruction execution time plus stacking overhead.

$$\text{Latency} = (\text{Longest instruction execution time} + 10) \times t_{\text{cyc}} \text{ seconds}$$

An RTI instruction is used to signify when the interrupt software service routine is completed. The RTI instruction causes the register contents to be recovered from the stack and normal processing to resume at the next instruction that was to be executed when the interrupt took place. **Figure 4-1** shows the sequence of events that occurs during interrupt processing.

4.4 Reset Interrupt Sequence

The reset function is not in the strictest sense an interrupt; however, it is acted upon in a similar manner as shown in **Figure 4-1**. A low-level input on the RESET pin or an internally generated RST signal causes the program to vector to its starting address, which is specified by the contents of memory locations \$3FFE and \$3FFF. The I bit in the condition code register is also set. The MCU is configured to a known state during this type of reset.

4.5 Software Interrupt (SWI)

The SWI is an executable instruction and a nonmaskable interrupt since it is executed regardless of the state of the I bit in the CCR. If the I bit is zero (interrupts enabled), the SWI instruction executes after interrupts that were pending before the SWI was fetched or before interrupts generated after the SWI was fetched. The interrupt service routine address is specified by the contents of memory locations \$3FFC and \$3FFD.

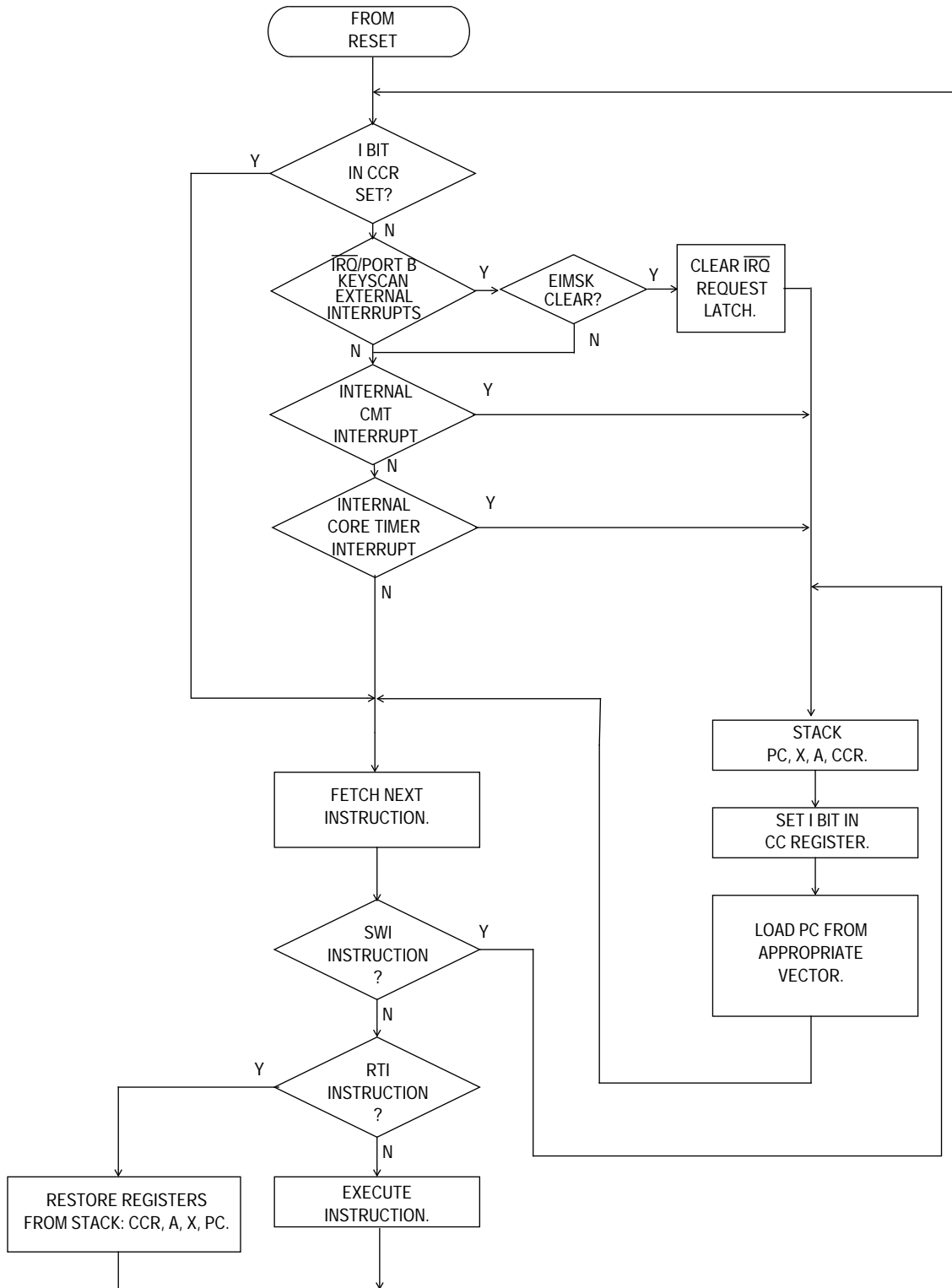

Figure 4-1. Interrupt Processing Flowchart

4.6 Hardware Interrupts

All hardware interrupts except $\overline{\text{RESET}}$ are maskable by the I bit in the CCR. If the I bit is set, all hardware interrupts (internal and external) are disabled. Clearing the I bit enables the hardware interrupts. The three types of hardware interrupts are explained in the following sections.

4.7 External Interrupt ($\overline{\text{IRQ}}$ /Port B Pullup)

The $\overline{\text{IRQ}}$ pin provides an asynchronous interrupt to the CPU. A block diagram of the IRQ function is shown in **Figure 4-2**.

NOTE: *The BIH and BIL instructions will apply to the level on the $\overline{\text{IRQ}}$ pin itself and to the output of the logic OR function with the port B IRQ interrupts. The states of the individual port B pins can be checked by reading the appropriate port B pins as inputs.*

The $\overline{\text{IRQ}}$ pin is one source of an external interrupt. All port B pins (PB0–PB7) act as other external interrupt sources if the pullup feature is enabled as specified by the user.

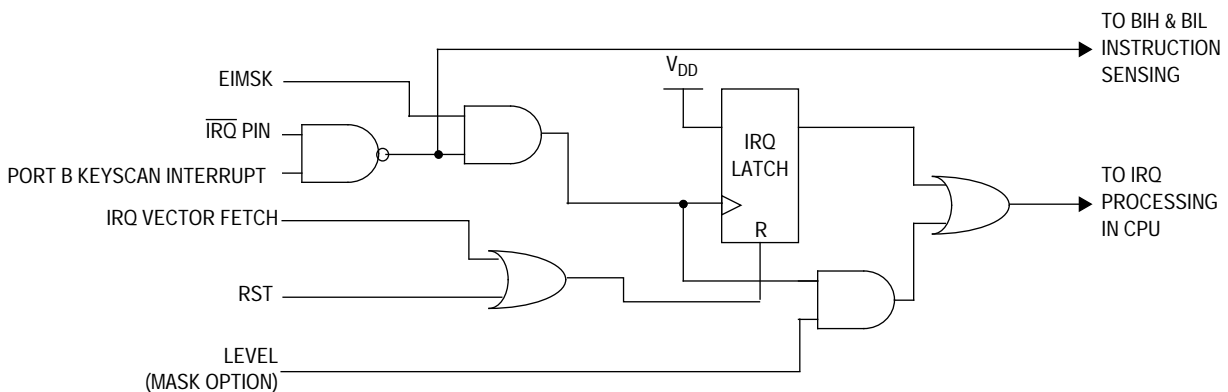

Figure 4-2. IRQ Function Block Diagram

When edge sensitivity is selected for the IRQ interrupt, it is sensitive to these cases:

1. Falling edge on the $\overline{\text{IRQ}}$ pin
2. Falling edge on any port B pin with pullup enabled

When edge and level sensitivity is selected for the IRQ interrupt, it is sensitive to these cases:

1. Low level on the $\overline{\text{IRQ}}$ pin
2. Falling edge on the $\overline{\text{IRQ}}$ pin
3. Falling edge or low level on any port B pin with pullup enabled

External interrupts also can be masked by setting the EIMSK bit in the MSCR register of the IR remote timer. See [9.5.4 Modulator Period Data Registers \(MDR1, MDR2, and MDR3\)](#) for details.

4.8 External Interrupt Timing

If the interrupt mask bit (I bit) of the CCR is set, all maskable interrupts (internal and external) are disabled. Clearing the I bit enables interrupts. The interrupt request is latched immediately following the falling edge of the $\overline{\text{IRQ}}$ source. It is then synchronized internally and serviced as specified by the contents of \$3FFA and \$3FFB.

Either a level-sensitive and edge-sensitive trigger or an edge-sensitive-only trigger is available via the MOR register for the $\overline{\text{IRQ}}$ pin.

4.9 Carrier Modulator Transmitter Interrupt (CMT)

A CMT interrupt occurs when the end of cycle flag (EOC) and the end of cycle interrupt enable (EOCIE) bits are set in the modulator control and status register (MCSR). This interrupt will vector to the interrupt service routine located at the address specified by the contents of memory locations \$3FF8 and \$3FF9.

4.10 Core Timer Interrupt

This timer can create two types of interrupts. A timer overflow interrupt occurs whenever the 8-bit timer rolls over from \$FF to \$00 and the enable bit TOFE is set. A real-time interrupt occurs whenever the programmed time elapses and the enable bit RTIE is set. Either of these interrupts vectors to the same interrupt service routine, located at the address specified by the contents of memory locations \$3FF6 and \$3FF7.

Section 5. Resets

5.1 Contents

5.2	Introduction	43
5.3	External Reset ($\overline{\text{RESET}}$)	44
5.4	Low-Power External Reset ($\overline{\text{LPRST}}$)	46
5.5	Internal Resets	46
5.5.1	Power-On Reset (POR)	46
5.5.2	Computer Operating Properly Reset (COPR)	47
5.5.2.1	Resetting the COP	47
5.5.2.2	COP During Wait Mode	47
5.5.2.3	COP During Stop Mode	47
5.5.2.4	COP Watchdog Timer Considerations	48
5.5.2.5	COP Register	49
5.5.3	Illegal Address	49

5.2 Introduction

The MCU can be reset from five sources: two external inputs and three internal restart conditions. The $\overline{\text{RESET}}$ and $\overline{\text{LPRST}}$ pins are inputs as shown in **Figure 5-1**. All the internal peripheral modules will be reset by the internal reset signal (RST). Refer to **Figure 5-2** for reset timing detail.

5.3 External Reset ($\overline{\text{RESET}}$)

The $\overline{\text{RESET}}$ pin is one of the two external sources of a reset. This pin is connected to a Schmitt trigger input gate to provide an upper and lower threshold voltage separated by a minimum amount of hysteresis. This external reset occurs whenever the $\overline{\text{RESET}}$ pin is pulled below the lower threshold and remains in reset until the $\overline{\text{RESET}}$ pin rises above the upper threshold. This active-low input will generate the RST signal and reset the CPU and peripherals. Termination of the external RESET input or the internal COP watchdog reset are the only reset sources that can alter the operating mode of the MCU.

NOTE: Activation of the RST signal is generally referred to as reset of the device, unless otherwise specified.

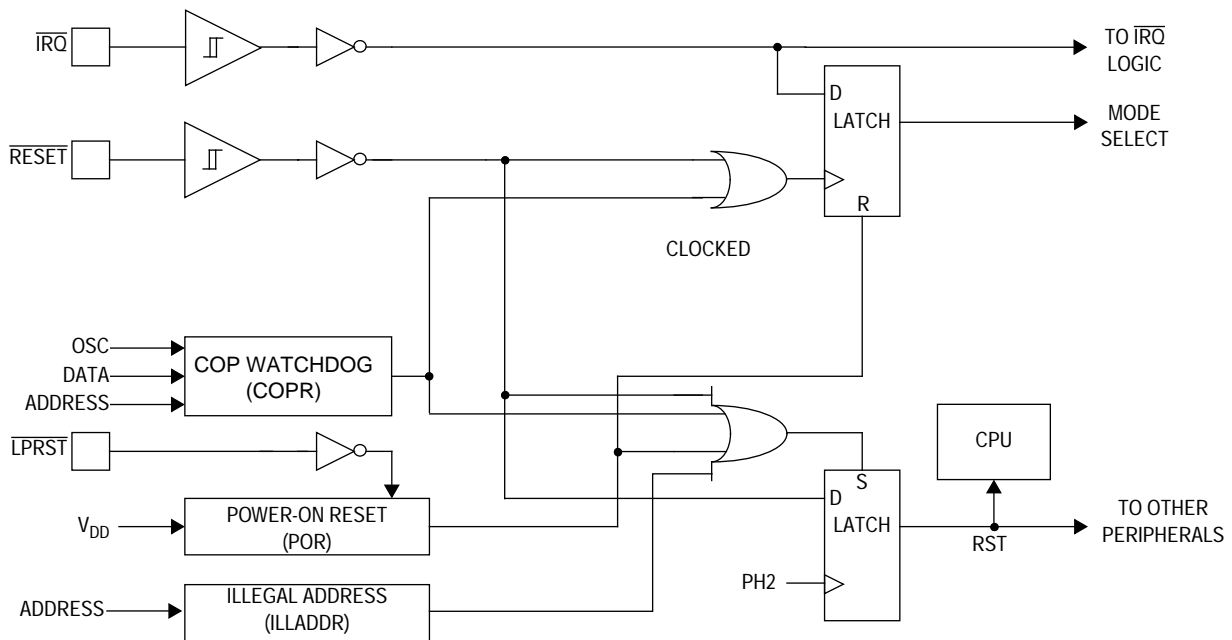
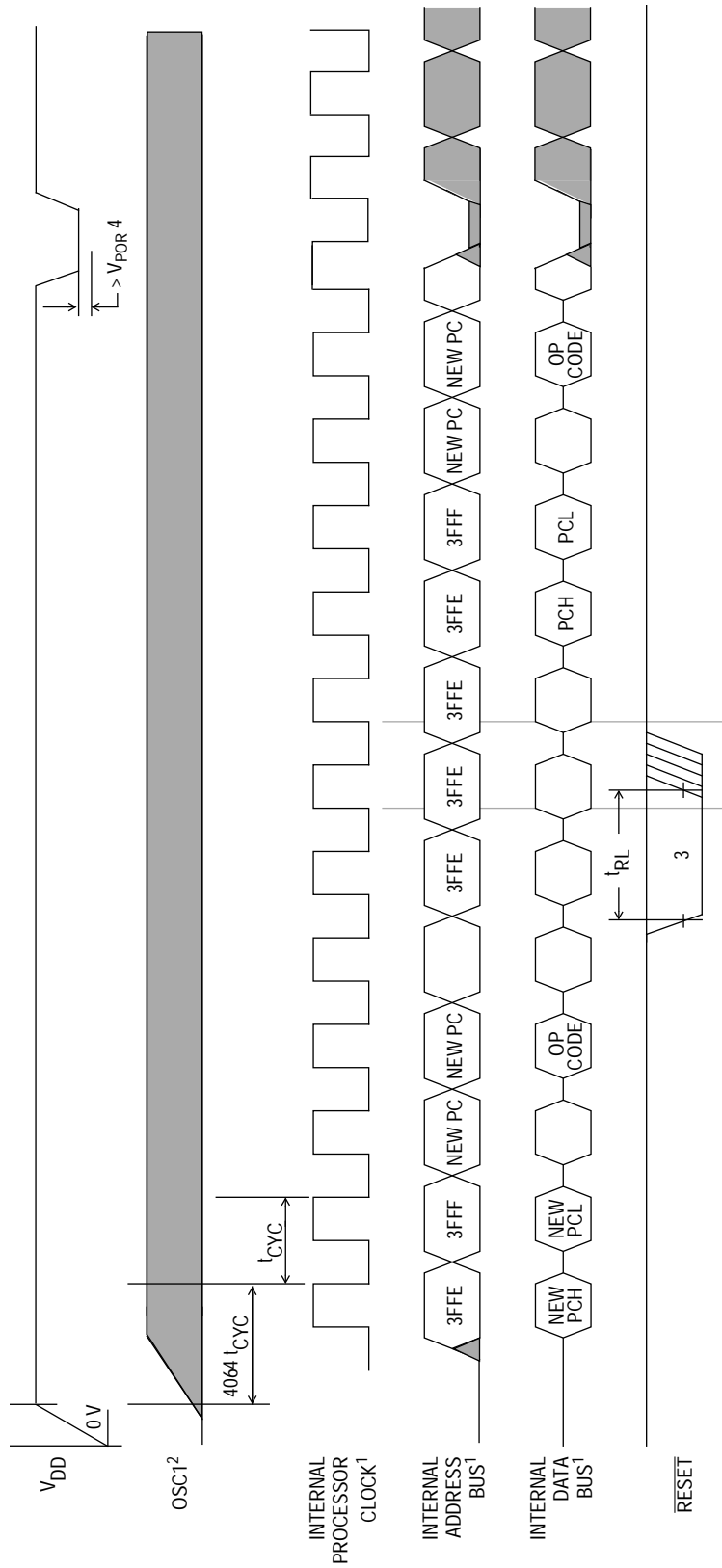

Figure 5-1. Reset Block Diagram



NOTES:

1. Internal timing signal and bus information are not available externally.
2. OSC1 line is not meant to represent frequency. It is only used to represent time.
3. The next rising edge of the internal processor clock following the rising edge of RESET initiates the reset sequence.
4. VDD must fall to a level lower than V_{POR} to be recognized as a power-on reset.
5. The LPRST pin resets the CPU like RESET. However, 4064 POR cycles are first, before the reset vector address appears on the internal address bus. (See 5.4 Low-Power External Reset (LPRST).)

Figure 5-2. Reset and POR Timing Diagram

5.4 Low-Power External Reset ($\overline{\text{LPRST}}$)

The $\overline{\text{LPRST}}$ pin is one of the two external sources of a reset. This external reset occurs whenever the $\overline{\text{LPRST}}$ pin is pulled below the lower threshold and remains in reset until the $\overline{\text{LPRST}}$ pin rises. This active low input will, in addition to generating the RST signal and resetting the CPU and peripherals, halt all internal processor clocks. The MCU will remain in this low-power reset condition as long as a logic 0 remains on LPRST. When a logic 1 is applied to LPRST, processor clocks will be re-enabled with the MCU remaining in reset until the 4064 internal processor clock cycle (t_{cyc}) oscillator stabilization delay is completed. If any other reset function is active at the end of this 4064-cycle delay, the RST signal remains in the reset condition until the other reset condition(s) end.

5.5 Internal Resets

The three internally generated resets are the initial power-on reset function, the COP watchdog timer reset, and the illegal address detector. Termination of the external reset input, external $\overline{\text{LPRST}}$ input, or the internal COP watchdog timer are the only reset sources that can alter the operating mode of the MCU. The other internal resets do not have any effect on the mode of operation when their reset state ends.

5.5.1 Power-On Reset (POR)

The internal POR is generated on power-up to allow the clock oscillator to stabilize. The POR is strictly for power turn-on conditions and is not able to detect a drop in the power supply voltage (brown-out). There is an oscillator stabilization delay of 4064 internal processor bus clock cycles (PH2) after the oscillator becomes active.

The POR generates the RST signal that resets the CPU. If any other reset function is active at the end of this 4064-cycle delay, the RST signal remains in the reset condition until the other reset condition(s) ends.

5.5.2 Computer Operating Properly Reset (COPR)

The MCU contains a watchdog timer that automatically times out if not reset (cleared) within a specific time by a program reset sequence. If the COP watchdog timer is allowed to time out, an internal reset is generated to reset the MCU.

The COP reset function is enabled or disabled by the mask option registers (MOR).

5.5.2.1 Resetting the COP

Writing a zero to the COPF bit prevents a COP reset. This action resets the counter and begins the time-out period again. The COPF bit is bit 0 of address \$3FF0. A read of address \$3FF0 returns user data programmed at that location.

5.5.2.2 COP During Wait Mode

The COP continues to operate normally during wait mode. The software should pull the device out of wait mode periodically and reset the COP by writing to the COPF bit to prevent a COP reset.

5.5.2.3 COP During Stop Mode

When the stop enable mask option is selected, stop mode disables the oscillator circuit and thereby turns the clock off for the entire device. When stop is executed, the COP counter will hold its current state. If a reset is used to exit stop mode, the COP counter is reset and held until 4064 POR cycles are completed. At this time, counting will begin. If an external IRQ is used to exit stop mode, the COP counter does not wait for the completion of the 4064 POR cycles but does count these cycles. It is, therefore, recommended that the COP is fed before executing the STOP instruction.

5.5.2.4 COP Watchdog Timer Considerations

The COP watchdog timer is active in all modes of operation if enabled by a mask option. If the COP watchdog timer is selected by a mask option, any execution of the STOP instruction (either intentionally or inadvertently due to the CPU being disturbed) causes the oscillator to halt and prevents the COP watchdog timer from timing out. If the COP watchdog timer is selected by a mask option, the COP resets the MCU when it times out. Therefore, it is recommended that the COP watchdog be **disabled** for a system that must have intentional uses of the wait mode for periods longer than the COP time-out period.

The recommended interactions and considerations for the COP watchdog timer, STOP instruction, and WAIT instruction are summarized in [Table 5-1](#).

Table 5-1. COP Watchdog Timer Recommendations

IF the Following Conditions Exist:	THEN the COP Watchdog Timer Should Be:
Wait Time	
Wait Time Less than COP Time-Out	Enable or Disable COP by MOR
Wait Time More than COP Time-Out	Disable COP by MOR
Any Length Wait Time	Disable COP by MOR

5.5.2.5 COP Register

The COP register is shared with the LSB of an unimplemented user interrupt vector as shown in **Figure 5-3**. Reading this location returns whatever user data has been programmed at this location. Writing a zero to the COPR bit in this location clears the COP watchdog timer.

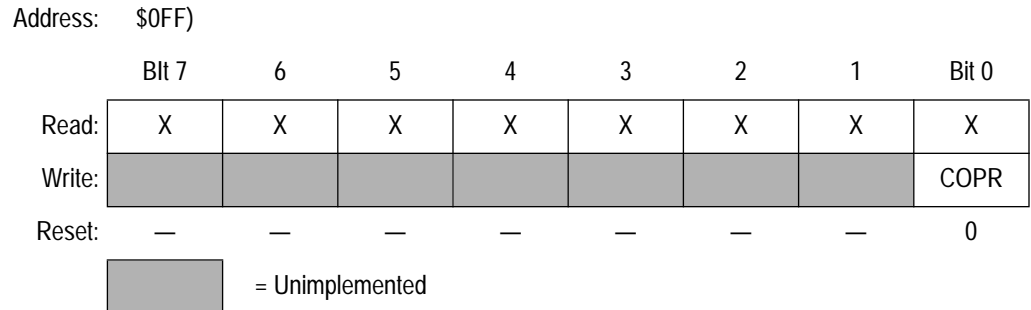

Figure 5-3. COP Watchdog Timer Location

5.5.3 Illegal Address

An illegal address reset is generated when the CPU attempts to fetch an instruction from I/O address space (\$0000 to \$001F).

Section 6. Low-Power Modes

6.1 Contents

6.2	Introduction	51
6.3	Stop Mode	51
6.4	Stop Recovery	52
6.5	Wait Mode	52
6.6	Low-Power Reset	53

6.2 Introduction

This section describes the low-power modes.

6.3 Stop Mode

The STOP instruction places the MCU in its lowest power-consumption mode. In stop mode, the internal oscillator is turned off, halting all internal processing, including timer operation.

During stop mode, the CTCSR (\$08) bits are altered to remove any pending timer interrupt request and to disable any further timer interrupts. The timer prescaler is cleared. The I bit in the CCR is cleared to enable external interrupts. All other registers and memory remain unaltered. All input/output lines remain unchanged.

NOTE: *The EIMSK bit is not cleared automatically by the execution of a STOP instruction. Care should be taken to clear this bit before entering stop mode.*

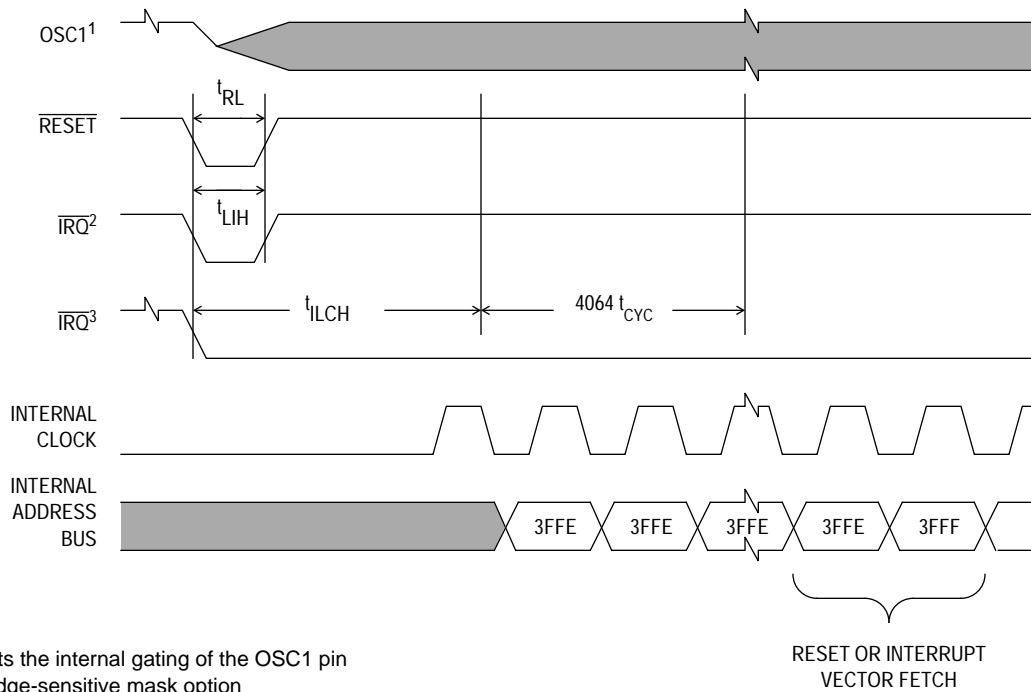

- NOTES:
1. Represents the internal gating of the OSC1 pin
 2. \overline{IRQ} pin edge-sensitive mask option
 3. \overline{IRQ} pin level and edge-sensitive mask option

Figure 6-1. Stop Recovery Timing Diagram

6.4 Stop Recovery

The processor can be brought out of stop mode only by an external interrupt, \overline{LPRST} , or \overline{RESET} . Refer to [Figure 6-1](#).

NOTE: *If an external interrupt is pending when stop mode is entered, then stop mode will be exited immediately.*

6.5 Wait Mode

The WAIT instruction places the MCU in a low power-consumption mode, but wait mode consumes more power than stop mode. All CPU action is suspended, but the core timer, the oscillator, and any enabled module remain active. Any interrupt or reset will cause the MCU to exit wait mode. The user must shut off subsystems to reduce power

consumption. Wait current specifications assume CPU operation only and do not include current consumption by any other subsystems.

During wait mode, the I bit in the CCR is cleared to enable interrupts. All other registers, memory, and input/output lines remain in their previous states. The timer may be enabled to allow a periodic exit from the wait mode.

6.6 Low-Power Reset

Low-power reset mode is entered when a logic 0 is detected on the $\overline{\text{LPRST}}$ pin. When in this mode (as long as $\overline{\text{LPRST}}$ is held low), the MCU is held in reset and all internal clocks are halted. Applying a logic 1 to $\overline{\text{LPRST}}$ will cause the part to exit low-power reset mode and begin counting out the 4064-cycle oscillator stabilization period. Once this time has elapsed, the MCU will begin operation from the reset vectors (\$3FFE–\$3FFF).

Low-Power Modes

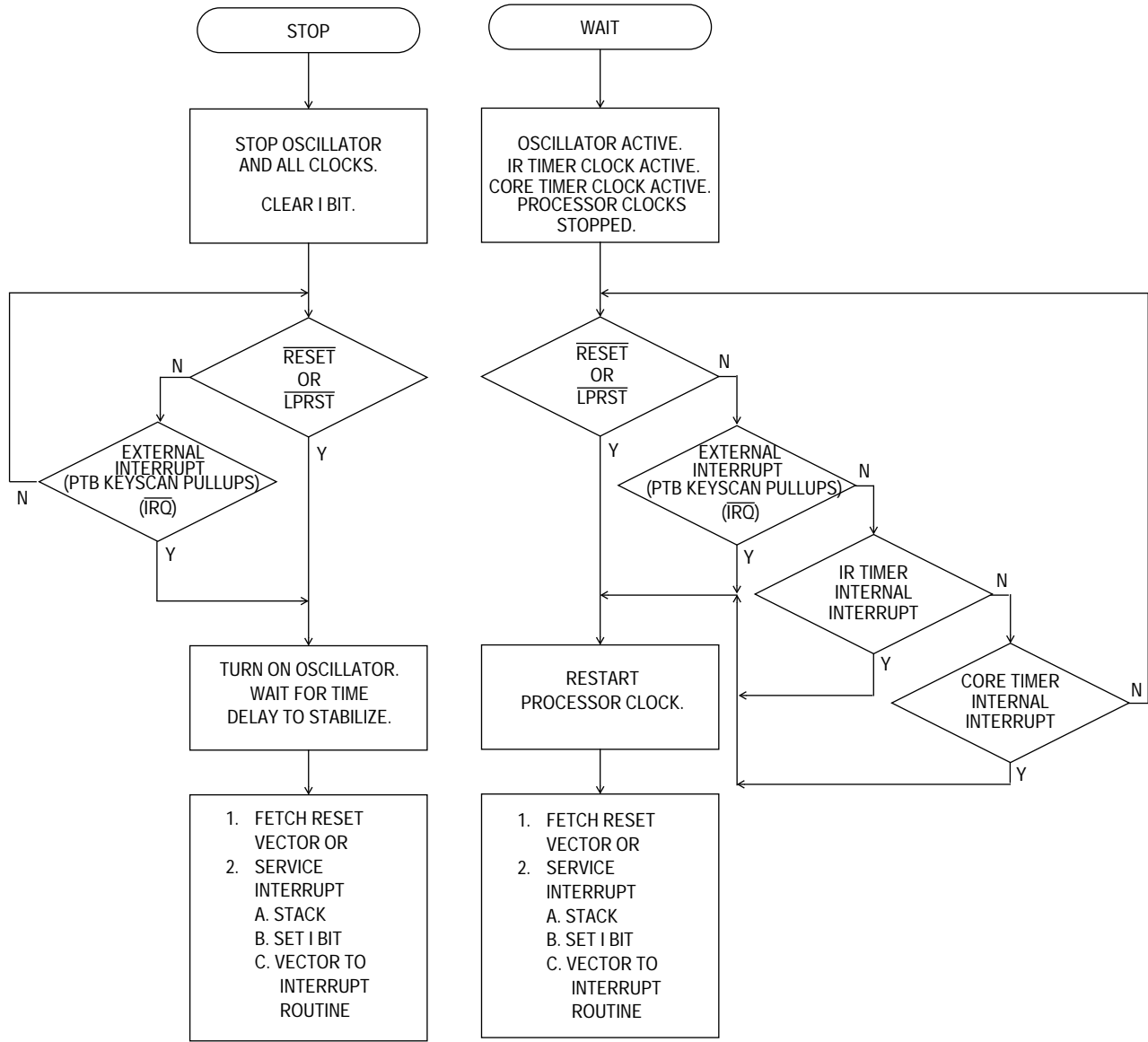

Figure 6-2. Stop/Wait Flowchart

Section 7. Parallel Input/Output (I/O)

7.1 Contents

7.2	Introduction	55
7.3	Port A	55
7.4	Port B	56
7.5	Port C	56
7.6	Input/Output Programming	57

7.2 Introduction

In user mode, 20 lines (28-pin PDIP or 28-pin SOIC) or 24 lines (44-lead PLCC) are arranged as three 8-bit I/O ports. These ports are programmable as either inputs or outputs under software control of the data direction registers.

NOTE: *To avoid a glitch on the output pins, write data to the I/O port data register before writing a one to the corresponding data direction register.*

7.3 Port A

Port A is an 8-bit bidirectional port which does not share any of its pins with other subsystems. The port A data register is at \$0000 and the data direction register (DDR) is at \$0004. Reset does not affect the data register, but clears the data direction register, thereby returning the ports to inputs. Writing a one to a DDR bit sets the corresponding port bit to output mode.

7.4 Port B

Port B is an 8-bit bidirectional port which does not share any of its pins with other subsystems. The address of the port B data register is \$0001 and the data direction register (DDR) is at address \$0005. Reset does not affect the data register, but clears the data direction register, thereby returning the ports to inputs. Writing a one to a DDR bit sets the corresponding port bit to output mode. Each of the port B pins has a mask programmable pullup device that can be enabled. When the pullup device is enabled, this pin will also become an interrupt pin. The edge or edge and level sensitivity of the \overline{IRQ} pin will also pertain to the enabled port B pins. Care needs to be taken when using port B pins that have the pullup enabled. Before switching from an output to an input, the data should be preconditioned to a logic one or the I bit should be set in the condition code register to prevent an interrupt from occurring. The EIMSK bit in the CMT MCSR register can be used to mask port B keyscan and external interrupts (IRQ).

NOTE: When a port B pin is configured as an output, it's corresponding keyscan interrupt is disabled, regardless of it's MOR register setting.

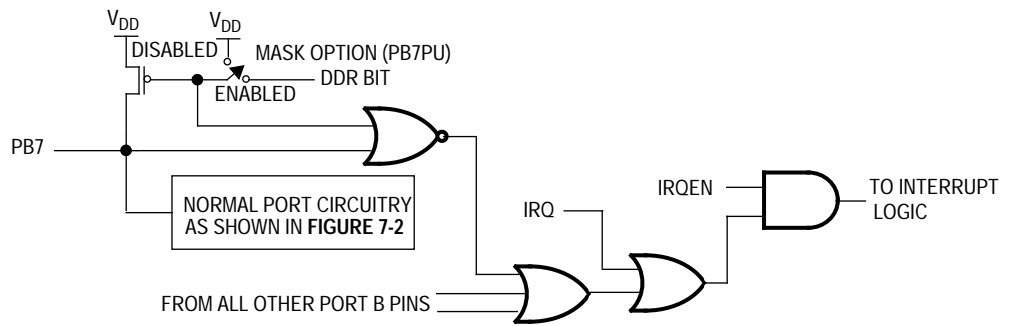

Figure 7-1. Port B Pullup Option

7.5 Port C

Port C is an 8-bit bidirectional port (PC0–PC7) which does not share any of its pins with other subsystems. The port C data register is at \$0003 and the data direction register (DDR) is at \$0006. Reset does not affect the data register, but clears the data direction register, thereby returning

the ports to inputs. Writing a one to a DDR bit sets the corresponding port bit to output mode. Port C pins PC4–PC7 are available only with the 44-lead PLCC package.

NOTE: *Only four bits of port C are bonded out in 28-pin packages for the MC68HC705RC16, although port C is truly an 8-bit port. Since pins PC4–PC7 are unbonded, software should include the code to set their respective data direction register locations to outputs to avoid floating inputs.*

7.6 Input/Output Programming

Port pins may be programmed as inputs or outputs under software control. The direction of the pins is determined by the state of the corresponding bit in the port data direction register (DDR). Each I/O port has an associated DDR. Any I/O port pin is configured as an output if its corresponding DDR bit is set to a logic 1. A pin is configured as an input if its corresponding DDR bit is cleared to a logic 0.

At power-on or reset, all DDRs are cleared, which configures all pins as inputs. The data direction registers are capable of being written to or read by the processor. During the programmed output state, a read of the data register actually reads the value of the output data latch and not the I/O pin.

Table 7-1. I/O Pin Functions

Access	DDR	I/O Pin Functions
Write	0	The I/O pin is in input mode. Data is written into the output data latch.
Write	1	Data is written into the output data latch and output to the I/O pin.
Read	0	The state of the I/O pin is read.
Read	1	The I/O pin is in an output mode. The output data latch is read.

Parallel Input/Output (I/O)

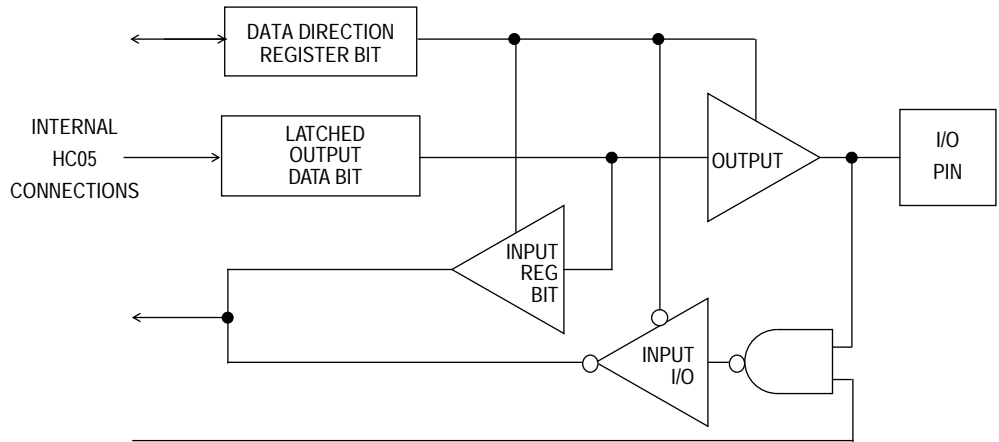

Figure 7-2. I/O Circuitry

Freescale Semiconductor, Inc.

Section 8. Core Timer

8.1 Contents

8.1	Contents	59
8.2	Introduction	59
8.3	Core Timer Control and Status Register	61
8.4	Core Timer Counter Register	63
8.5	Computer Operating Properly (COP) Reset	64
8.6	Timer During Wait Mode	64

8.2 Introduction

The core timer for this device is a 14-stage multifunctional ripple counter. Features include timer overflow, power-on reset (POR), real-time interrupt (RTI), and COP watchdog timer.

As seen in **Figure 8-1**, the internal peripheral clock is divided by four, and then drives an 8-bit ripple counter. The value of this 8-bit ripple counter can be read by the CPU at any time by accessing the core timer counter register (CTCR) at address \$09. A timer overflow function is implemented on the last stage of this counter, giving a possible interrupt rate of the internal peripheral clock (E)/1024. This point is then followed by three more stages, with the resulting clock (E/4096) driving the real-time interrupt circuit (RTI). The RTI circuit consists of three divider stages with a one-of-four selector. The output of the RTI circuit is further divided by eight to drive the mask optional COP watchdog timer circuit. The RTI rate selector bits and the RTI and CTOF enable bits and flags are located in the timer control and status register at location \$08.

Core Timer

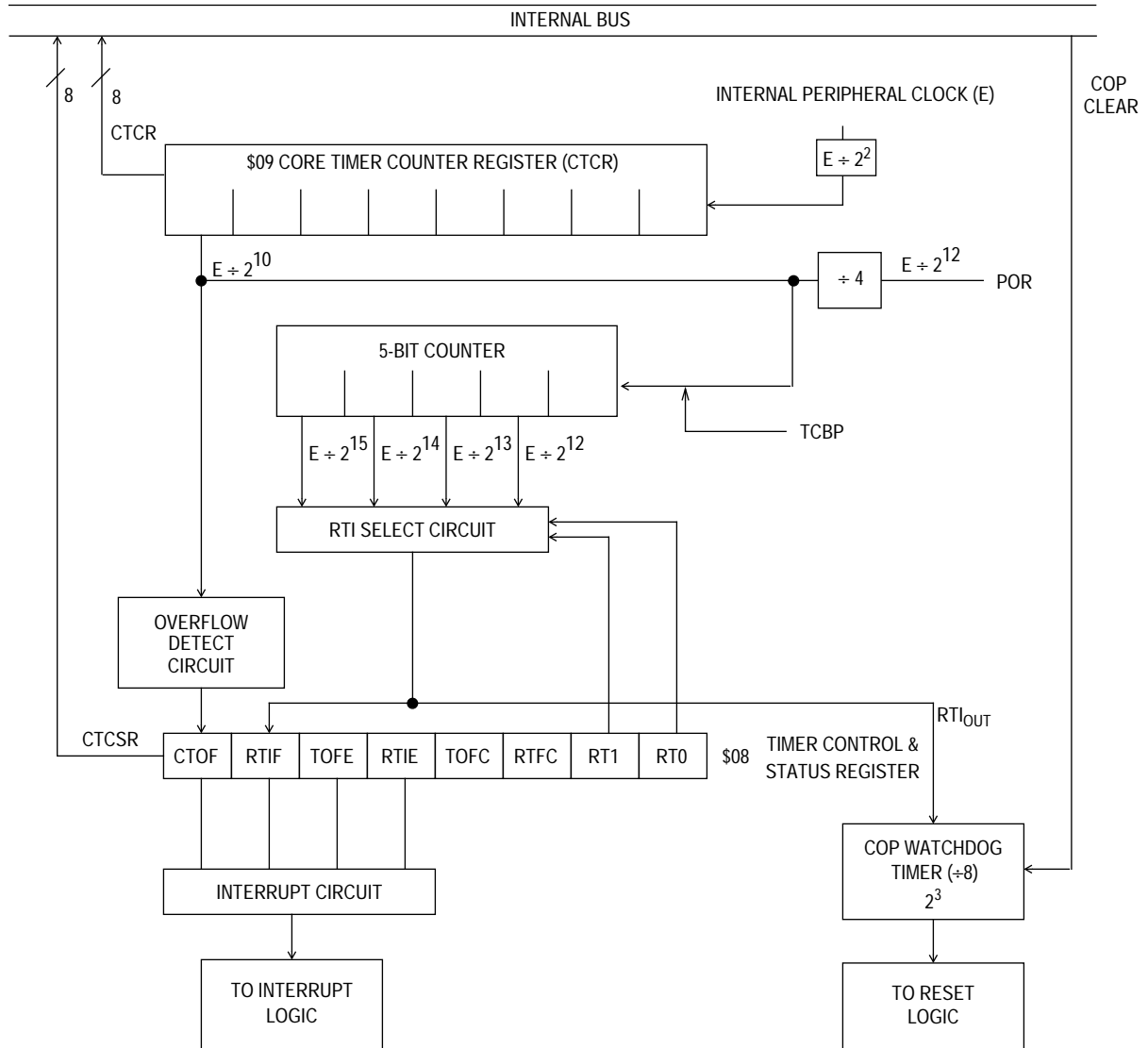

Figure 8-1. Core Timer Block Diagram

8.3 Core Timer Control and Status Register

The CTCSR contains the timer interrupt flag, the timer interrupt enable bits, and the real-time interrupt rate select bits. **Figure 8-2** shows the value of each bit in the CTCSR when coming out of reset.

Address: \$08

Read:	CTOF	RTIF	TOFE	RTIE	0	0	RT1	RT0
Write:					TOFC	RTFC		
Reset:	0	0	0	0	0	0	1	1

 = Unimplemented

Figure 8-2. Core Timer Control and Status Register (CTCSR)

CTOF — Core Timer Overflow

CTOF is a read-only status bit set when the 8-bit ripple counter rolls over from \$FF to \$00. Clearing the CTOF is done by writing a one to TOFC. Writing to this bit has no effect. Reset clears CTOF.

RTIF — Real-Time Interrupt Flag

The real-time interrupt circuit consists of a 3-stage divider and a one-of-four selector. The clock frequency that drives the RTI circuit is $E/2^{12}$ (or $E \div 4096$ with three additional divider stages, giving a maximum interrupt period of 16 milliseconds at a bus rate of 2.024 MHz. RTIF is a clearable, read-only status bit and is set when the output of the chosen (one-of-four selection) stage goes active. Clearing the RTIF is done by writing a one to RTFC. Writing has no effect on this bit. Reset clears RTIF.

TOFE — Timer Overflow Enable

When this bit is set, a CPU interrupt request is generated when the CTOF bit is set. Reset clears this bit.

RTIE — Real-Time Interrupt Enable

When this bit is set, a CPU interrupt request is generated when the RTIF bit is set. Reset clears this bit.

TOFC — Timer Overflow Flag Clear

When a one is written to this bit, CTOF is cleared. Writing a zero has no effect on the CTOF bit. This bit always reads as zero.

RTFC — Real-Time Interrupt Flag Clear

When a one is written to this bit, RTIF is cleared. Writing a zero has no effect on the RTIF bit. This bit always reads as zero.

RT1 and RT0 — Real-Time Interrupt Rate Select

These two bits select one of four taps from the real-time interrupt circuit. Refer to [Table 8-1](#). Reset sets these two bits which selects the lowest periodic rate and gives the maximum time in which to alter these bits if necessary. Care should be taken when altering RT0 and RT1 if the timeout period is imminent or uncertain. If the selected tap is modified during a cycle in which the counter is switching, an RTIF could be missed or an additional one could be generated. To avoid problems, the COP should be cleared before changing RTI taps.

Table 8-1. RTI and COP Rates at 4.096 MHz Oscillator

RTI RATE 2.048-MHz Bus		RT1:RT0	MINIMUM COP RATES 2.048-MHz Bus	
2 ms	$2^{12} \div E$	00	$(2^{15}-2^{12})/E$	14 ms
4 ms	$2^{13} \div E$	01	$(2^{16}-2^{13})/E$	28 ms
8 ms	$2^{14} \div E$	10	$(2^{17}-2^{14})/E$	56 ms
16 ms	$2^{15} \div E$	11	$(2^{18}-2^{15})/E$	112 ms

8.4 Core Timer Counter Register

The timer counter register is a read-only register that contains the current value of the 8-bit ripple counter at the beginning of the timer chain. This counter is clocked by the CPU clock (E/4) and can be used for various functions, including a software input capture. Extended time periods can be attained using the TOF function to increment a temporary RAM storage location, thereby simulating a 16-bit (or more) counter.

Address: \$09

Read:	D7	D6	D5	D4	D3	D2	D1	D0
Write:								
Reset:	0	0	0	0	0	0	1	1

 = Unimplemented

Figure 8-3. Core Timer Counter Register (CTCR)

The power-on cycle clears the entire counter chain and begins clocking the counter. After 4064 cycles, the power-on reset circuit is released, which again clears the counter chain and allows the device to come out of reset. At this point, if $\overline{\text{RESET}}$ is not asserted, the timer starts counting up from zero and normal device operation begins. When $\overline{\text{RESET}}$ is asserted any time during operation (other than POR and low-power reset), the counter chain is cleared.

8.5 Computer Operating Properly (COP) Reset

The COP watchdog timer function is implemented on this device by using the output of the RTI circuit and further dividing it by eight. The minimum COP reset rates are listed in [Table 8-1](#). If the COP circuit times out, an internal reset is generated and the normal reset vector is fetched. Preventing a COP timeout or clearing the COP is accomplished by writing a zero to bit 0 of address \$3FF0. When the COP is cleared, only the final divide-by-eight stage (output of the RTI) is cleared.

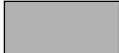
If the COP watchdog timer is allowed to time out, an internal reset is generated to reset the MCU.

The COP remains enabled after execution of the WAIT instruction and all associated operations apply. If the STOP instruction is disabled, execution of STOP instruction causes the CPU to execute a WAIT instruction. In addition, the COP is prohibited from being held in reset. This prevents a device lock-up condition.

This COP's objective is to make it impossible for this device to become stuck or locked-up and to be sure the COP is able to rescue the part from any situation where it might entrap itself in abnormal or unintended behavior. This function is a mask option.

8.6 Timer During Wait Mode

The CPU clock halts during wait mode, but the timer remains active. If interrupts are enabled, a timer interrupt will cause the processor to exit wait mode. The COP is always enabled while in user mode.

Section 9. Carrier Modulator Transmitter (CMT)

9.1 Contents

9.2	Introduction	65
9.3	Overview	66
9.4	Carrier Generator	68
9.4.1	Time Counter	69
9.4.2	Carrier Generator Data Registers (CHR1, CLR1, CHR2, and CLR2)	70
9.5	Modulator	72
9.5.1	Time Mode	74
9.5.2	FSK Mode	75
9.5.3	Extended Space Operation	76
9.5.3.1	End Of Cycle (EOC) Interrupt	77
9.5.3.2	Modulator Control and Status Register	78
9.5.4	Modulator Period Data Registers (MDR1, MDR2, and MDR3)	81

9.2 Introduction

The carrier modulator transmitter (CMT) module provides a means to generate the protocol timing and carrier signals for a wide variety of encoding schemes. It incorporates hardware to off-load the critical and/or lengthy timing requirements associated with code generation from the CPU, releasing much of its bandwidth to handle other tasks such as code data generation, data decompression, or keyboard scanning. The CMT does not include dedicated hardware configurations for specific protocols, but is intended to be sufficiently programmable in its function to handle the timing requirements of most protocols with minimal CPU intervention. When disabled, certain CMT registers can be

Carrier Modulator Transmitter (CMT)

used to change the state of the infrared out pin (IRO) directly. This feature allows for the generation of future protocols not readily producible by the current architecture.

9.3 Overview

The module consists of carrier generator, modulator, and transmitter output blocks. The block diagram is shown in [Figure 9-1](#).

The carrier generator has a resolution of 500 ns with a 2-MHz oscillator. The user may independently define the high and low times of the carrier signal to determine both period and duty cycle. The carrier generator can generate signals with periods between 1 μ s (1 MHz) and 64 μ s (15.6 kHz) in steps of 500 ns. The possible duty cycle options will depend upon the number of counts required to complete the carrier period. For example, a 400-kHz signal has a period of 2.5 μ s and will therefore require 5 x 500 ns counts to generate. These counts may be split between high and low times so the duty cycles available will be 20% (one high, four low), 40% (two high, three low), 60% (three high, two low) and 80% (four high, one low). For lower frequency signals with larger periods, higher resolution (as a percentage of the total period) duty cycles are possible. The carrier generator may select between two sets of high and low times. When operating in normal mode (subsequently referred to as time mode), just one set will be used. When operating in FSK (frequency shift key) mode, the generator will toggle between the two sets when instructed to do so by the modulator, allowing the user to dynamically switch between two carrier frequencies without CPU intervention. When the BASE bit in the modulator control and status register (MCSR) is set, the carrier output to the modulator is held high continuously to allow for the generation of baseband protocols. See [9.4 Carrier Generator](#).

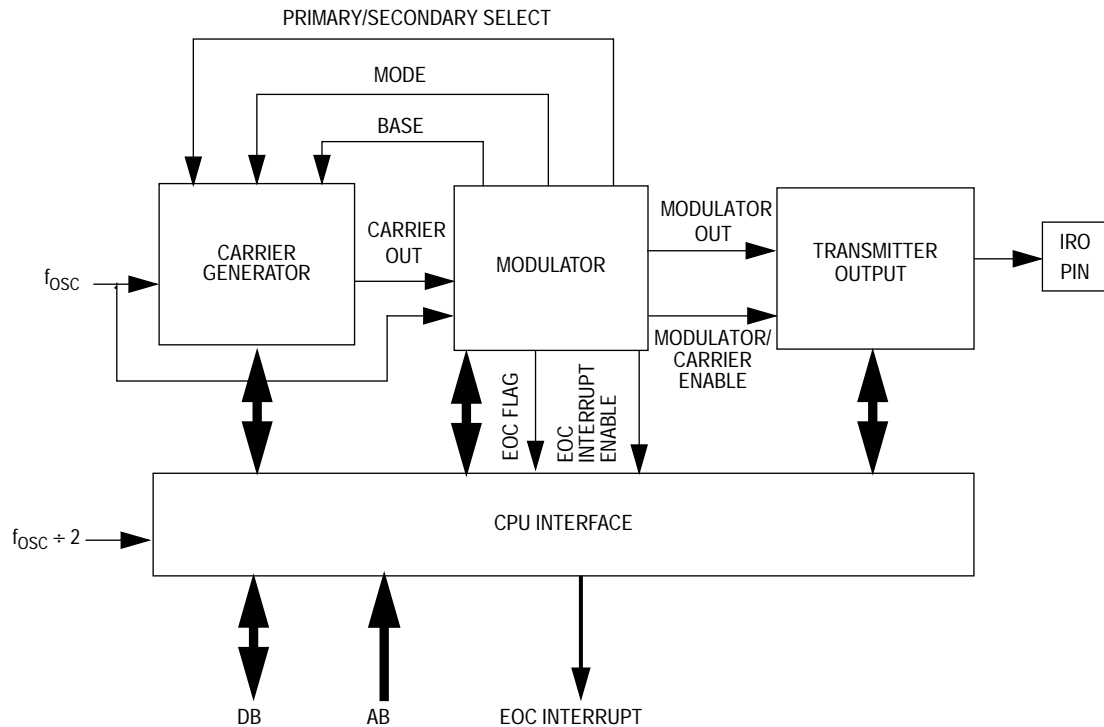

Figure 9-1. Carrier Modulator Transmitter Module Block Diagram

The modulator provides a simple method to control protocol timing. The modulator has a resolution of 4 μ s with a 2-MHz oscillator. It can count system clocks to provide real-time control or it can count carrier clocks for self-clocked protocols. It can either gate the carrier onto the modulator output (TIME), control the logic level of the modulator output (baseband) or directly route the carrier to the modulator output while providing a signal to switch the carrier generator between high/low time register buffers (FSK). See [9.5 Modulator](#).

The transmitter output block controls the state of the infrared out pin (IRO). The modulator output is gated on to the IRO pin when the modulator/carrier generator is enabled. Otherwise, the IRO pin is controlled by the state of the IRO latch, which is directly accessible to the CPU by means of bit 7 of the carrier generator data registers CHR1 and CLR1. The IRO latch can be written to on either edge of the internal bus clock ($f_{osc}/2$), allowing for IR waveforms which have a resolution of twice the bus clock frequency (f_{osc}). See [9.4.2 Carrier Generator Data Registers \(CHR1, CLR1, CHR2, and CLR2\)](#).

Carrier Modulator Transmitter (CMT)

9.4 Carrier Generator

The carrier signal is generated by counting a predetermined number of input clocks (500 ns for a 2-MHz oscillator) for both the carrier high time and the carrier low time. The period is determined by the total number of clocks counted. The duty cycle is determined by the ratio of high time clocks to total clocks counted. The high and low time values are user programmable and are held in two registers. An alternate set of high/low count values is held in another set of registers to allow the generation of dual frequency FSK (frequency shift keying) protocols without CPU intervention. The MCGEN bit in the MCSR must be set and the BASE bit in the MCSR must be cleared to enable carrier generator clocks. The block diagram is shown in **Figure 9-2**.

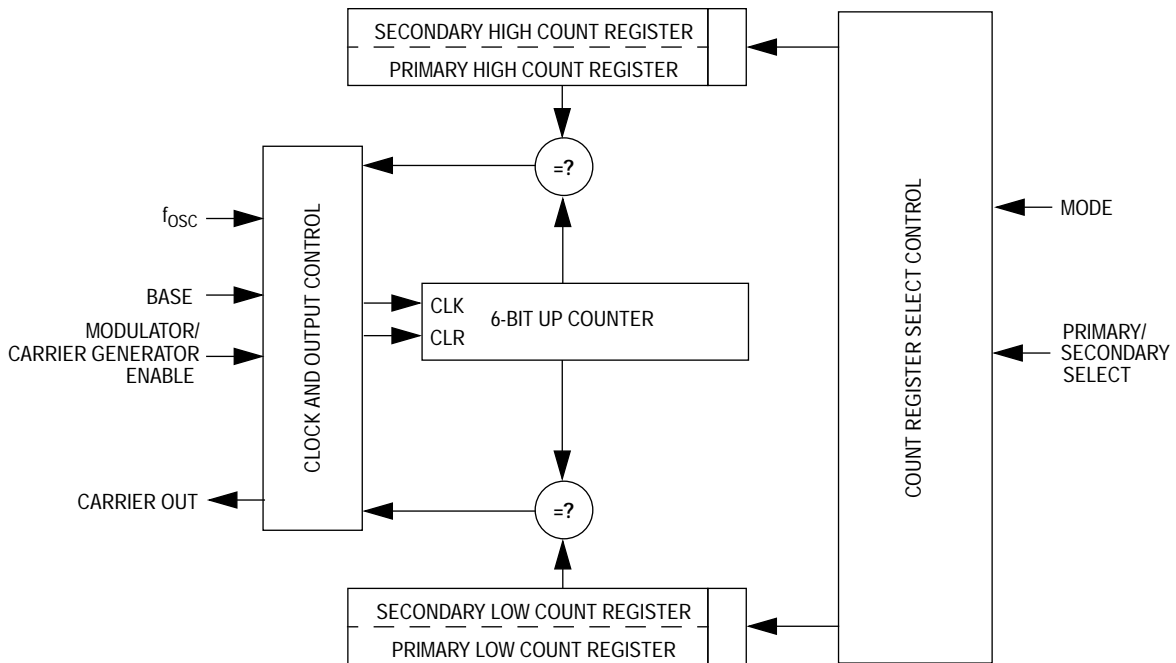

Figure 9-2. Carrier Generator Block Diagram

9.4.1 Time Counter

The high/low time counter is a 6-bit up counter. After each increment, the contents of the counter are compared with the appropriate high or low count value register. When this value is reached, the counter is reset and the compare is redirected to the other count value register. Assuming that the high time count compare register is currently active, a valid compare will cause the carrier output to be driven low. The counter will continue to increment and when reaching the value stored in the selected low count value register, it will be cleared and will cause the carrier output to be driven high. The cycle repeats, automatically generating a periodic signal which is directed to the modulator. The lowest frequency (maximum period) and highest frequency (minimum period) which can be generated are defined below.

$$f_{\min} = f_{\text{osc}} \div (2 \times (2^6 - 1)) \text{ Hz}$$

$$f_{\max} = f_{\text{osc}} \div (2 \times 1) \text{ Hz}$$

In the general case, the carrier generator output frequency is:

$$f_{\text{out}} = f_{\text{osc}} \div (\text{Highcount} + \text{Lowcount}) \text{ Hz}$$

Where:

$$0 < \text{Highcount} < 64 \text{ and}$$

$$0 < \text{Lowcount} < 64$$

NOTE: *These equations assume the DIV2 bit (bit 6) of the MCSR is clear. When the DIV2 bit is set, the carrier generator frequency will be half of what is shown in these equations.*

The duty cycle of the carrier signal is controlled by varying the ratio of high time to low + high time. As the input clock period is fixed, the duty cycle resolution will be proportional to the number of counts required to generate the desired carrier period.

$$\text{Duty Cycle} = \frac{\text{Highcount}}{\text{Highcount} + \text{Lowcount}}$$

Carrier Modulator Transmitter (CMT)

9.4.2 Carrier Generator Data Registers (CHR1, CLR1, CHR2, and CLR2)

The carrier generator contains two, 7-bit data registers: primary high time (CHR1), primary low time (CLR1); and two, 6-bit data registers: secondary high time (CHR2) and secondary low time (CLR2). Bit 7 of CHR1 and CHR2 is used to read and write the IRO latch.

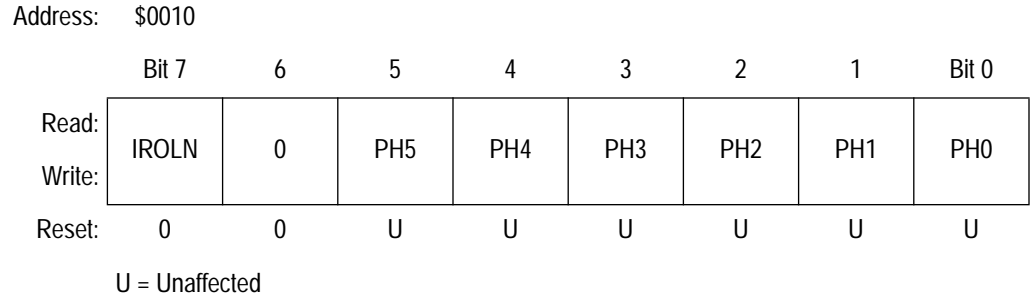

Figure 9-3. Carrier Generator Data Register CHR1

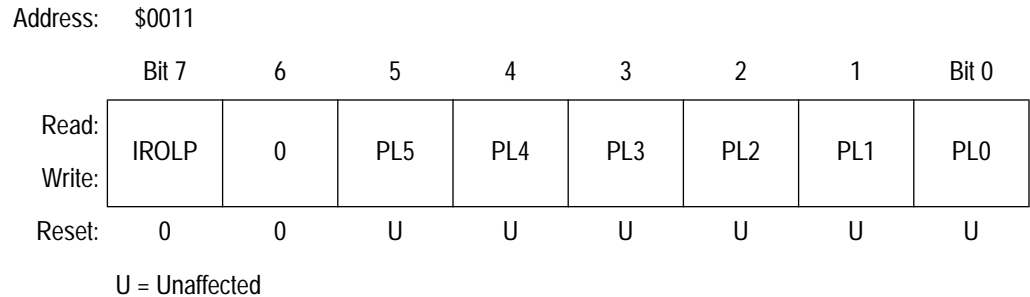

Figure 9-4. Carrier Generator Data Register CLR1

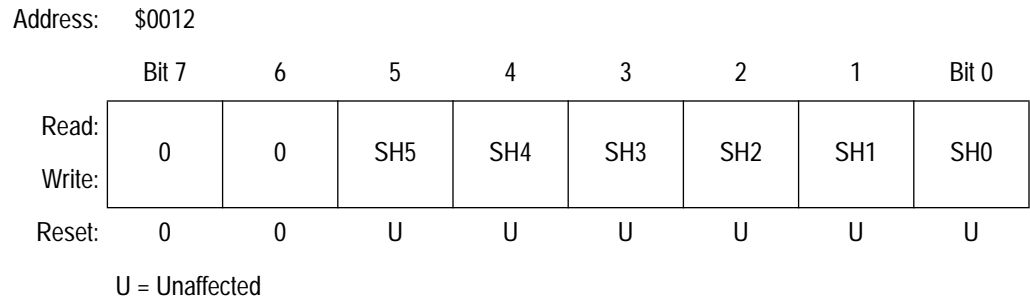

Figure 9-5. Carrier Generator Data Register CHR2

Address: \$0013

	Bit 7	6	5	4	3	2	1	Bit 0
Read:			SL5	SL4	SL3	SL2	SL1	SL0
Write:	0	0						
Reset:	0	0	U	U	U	U	U	U

U = Unaffected

Figure 9-6. Carrier Generator Data Register CLR2

PH0–PH5 and PL0–PL5 — Primary Carrier High and Low Time Data Values

When selected, these bits contain the number of input clocks required to generate the carrier high and low time periods. When operating in time mode (see **9.5.1 Time Mode**), this register pair is always selected. When operating in FSK mode (see **9.5.2 FSK Mode**), this register pair and the secondary register pair are alternately selected under control of the modulator. The primary carrier high and low time values are undefined out of reset. These bits must be written to non-zero values before the carrier generator is enabled to avoid spurious results.

NOTE: *Writing to CHR1 to update PH0–PH5 or to CLR1 to update PL0–PL5 will also update the IRO latch. When MCGEN (bit 0 in the MCSR) is clear, the IRO latch value appears on the IRO output pin. Care should be taken that bit 7 of the data to be written to CHR1 or CHL1 should contain the desired state of the IRO latch.*

SH0–SH5 and SL0–SL5 — Secondary Carrier High and Low Time Data Values

When selected, these bits contain the number of input clocks required to generate the carrier high and low time periods. When operating in time mode (see **9.5.1 Time Mode**), this register pair is never selected. When operating in FSK mode (see **9.5.2 FSK Mode**), this register pair and the secondary register pair are alternately selected under control

of the modulator. The secondary carrier high and low time values are undefined out of reset. These bits must be written to non-zero values before the carrier generator is enabled when operating in FSK mode.

IROLN and IROLP — IRO Latch Control

Reading IROLN or IROLP reads the state of the IRO latch. Writing IROLN updates the IRO latch with the data being written on the negative edge of the internal processor clock ($f_{osc}/2$). Writing IROLP updates the IRO latch on the positive edge of the internal processor clock; for example, one f_{osc} period later. The IRO latch is clear out of reset.

NOTE: *Writing to CHR1 to update IROLN or to CLR1 to update IROLP will also update the primary carrier high and low data values. Care should be taken that bits 5–0 of the data to be written to CHR1 or CHL1 should contain the desired values for the primary carrier high or low data.*

9.5 Modulator

The modulator consists of a 12-bit down counter with underflow detection which is loaded from the modulation mark period from the mark buffer register, MBUFF. When this counter underflows, the modulator gate is closed and a 12-bit comparator is enabled which continually compares the logical complement of the contents of the (still) decrementing counter with the contents of the modulation space period register, SREG. When a match is obtained, the modulator control gate is opened again. Should $SREG = 0$, the match will be immediate and no space period will be generated (for instance, for FSK protocols which require successive bursts of different frequencies). When the match occurs, the counter is reloaded with the contents of MBUFF, SREG is reloaded with the contents of its buffer, SBUFF, and the cycle repeats. The MCGEN bit in the MCSR must be set to enable the modulator timer. The 12-bit MBUFF and SBUFF registers are accessed through three 8-bit modulator period registers, MDR1, MDR2, and MDR3.

The modulator can operate in two modes, time or FSK. In time mode the modulator counts clocks derived from the system oscillator and modulates a single-carrier frequency or no carrier (baseband). In FSK mode, the modulator counts carrier periods and instructs the carrier generator to alternate between two carrier frequencies whenever a modulation period (mark + space counts) expires.

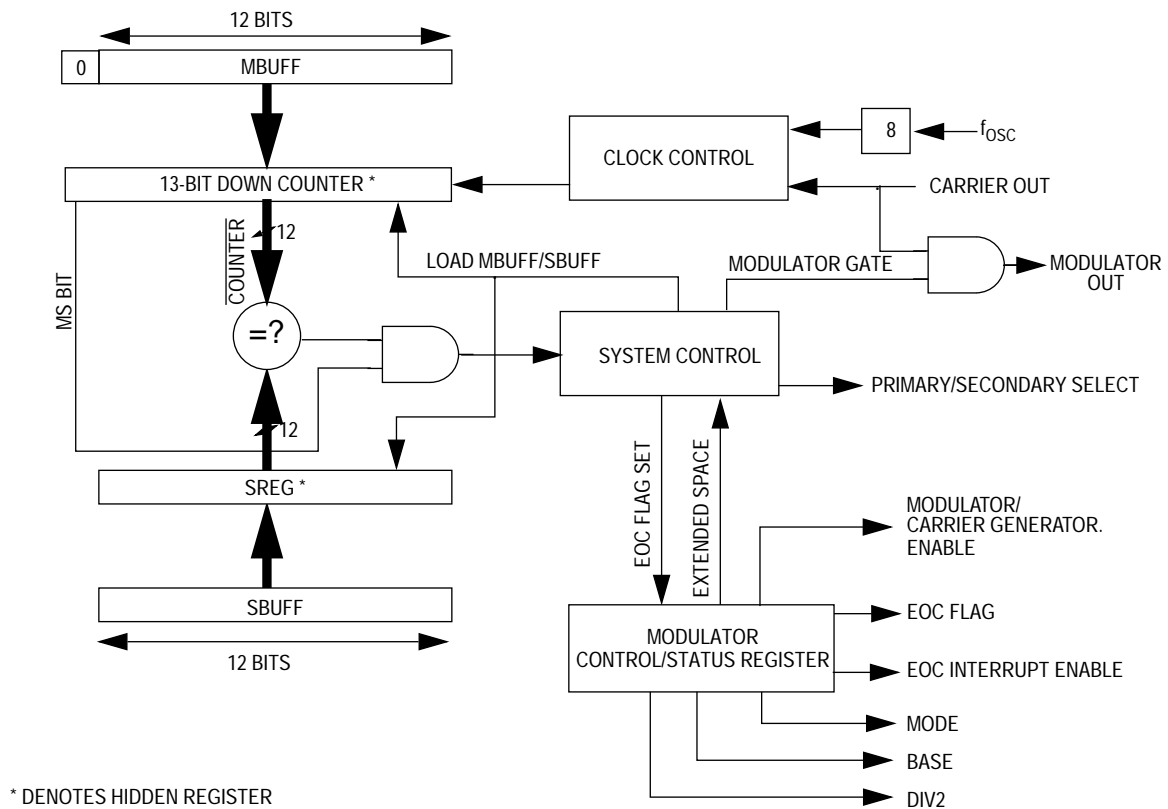

Figure 9-7. Modulator Block Diagram

Carrier Modulator Transmitter (CMT)

9.5.1 Time Mode

When the modulator operates in time mode, the modulation mark and space periods consist of zero or an integer number of $f_{osc} \div 8$ clocks (= 250 kHz @ 2 MHz osc). This provides a modulator resolution of 4 μ s and a maximum mark and space periods of about 16 ms (each). However, to prevent carrier glitches which could affect carrier spectral purity, the modulator control gate and carrier clock are synchronized. The carrier signal is activated when the modulator gate opens. The modulator gate can only close when the carrier signal is low (the output logic level during space periods is low). If the carrier generator is in baseband mode (BASE bit in MCSR is high), the modulator output will be at a logic 1 for the duration of the mark period and at a logic 0 for the duration of a space period. See [Figure 9-8](#).

The mark and space time equations are:

$$t_{\text{mark}} = \frac{(\text{MBUFF} + 1) \times 8}{f_{\text{osc}}} \text{secs}$$

$$t_{\text{space}} = \frac{\text{SBUFF} \times 8}{f_{\text{osc}}} \text{secs}$$

Setting the DIV2 bit in the MCSR will double mark and space times.

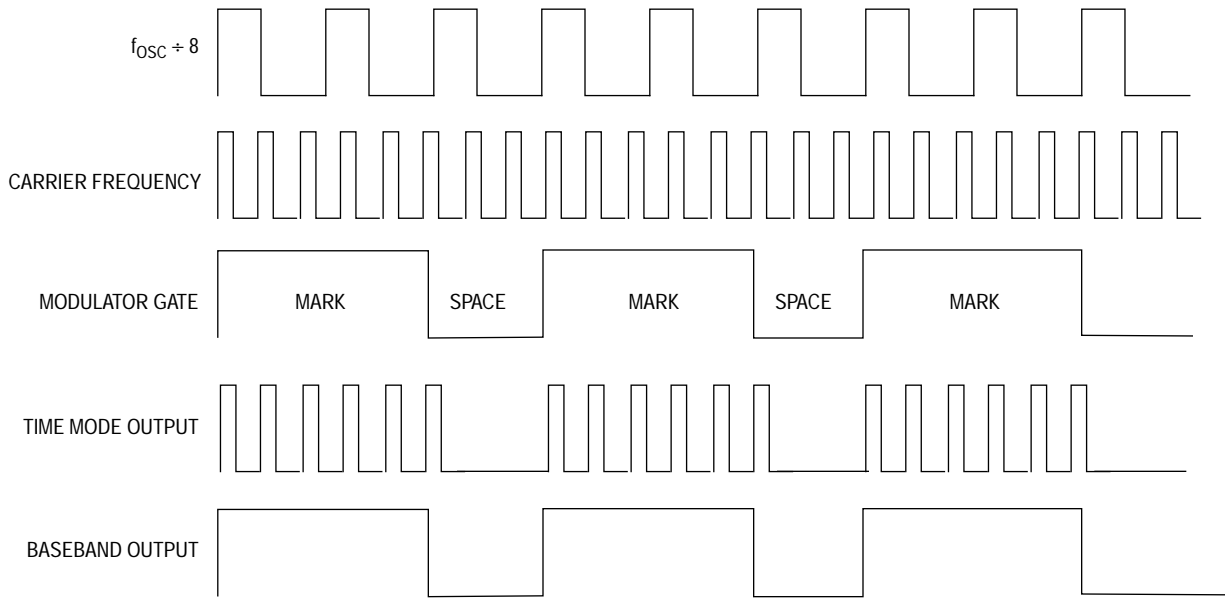

Figure 9-8. CMT Operation in Time Mode

9.5.2 FSK Mode

When the modulator operates in FSK mode, the modulation mark and space periods consist of an integer number of carrier clocks (space period can be zero). When the mark period expires, the space period is transparently started (as in time mode); however, in FSK mode the carrier switches between data registers in preparation for the next mark period. The carrier generator toggles between primary and secondary data register values whenever the modulator mark period expires. The space period provides an interpulse gap (no carrier), but if SBUFF = 0, then the modulator and carrier generator will switch between carrier frequencies without a gap or any carrier glitches (zero space).

Using timing data for carrier burst and interpulse gap length calculated by the CPU, FSK mode can automatically generate a phase-coherent, dual-frequency FSK signal with programmable burst and interburst gaps.

The mark and space time equations for FSK mode are:

$$t_{\text{mark}} = \frac{\text{MBUFF} + 1}{f_{\text{cg}}} \text{secs}$$

$$t_{\text{space}} = \frac{\text{SBUFF}}{f_{\text{cg}}} \text{secs}$$

Where f_{cg} is the frequency output from the carrier generator, setting the DIV2 bit in the MCSR will double mark and space times.

9.5.3 Extended Space Operation

In either time or FSK mode, the space period can be made longer than the maximum possible value of SBUFF. Setting the EXSPC bit in the MCSR will force the modulator to treat the next modulation period (beginning with the next load of MBUFF/SBUFF) as a space period equal in length to the mark and space counts combined. Subsequent modulation periods will consist entirely of these extended space periods with no mark periods. Clearing EXSPC will return the modulator to standard operation at the beginning of the next modulation period. To calculate the length of an extended space in time mode, use the equation:

$$t_{\text{exspace}} = \frac{((\text{SBUFF}_1) + (\text{MBUFF}_2 + 1 + \text{SBUFF}_2) + \dots + (\text{MBUFF}_n + 1 + \text{SBUFF}_n)) \times 8}{f_{\text{osc}}} \text{secs}$$

Where:

the subscripts 1, 2, ... n refer to the modulation periods that elapsed while the EXSPC bit was set.

Similarly, to calculate the length of an extended space in FSK mode, use the equation:

$$t_{\text{exspace}} = \frac{((\text{SBUFF}_1) + (\text{MBUFF}_2 + 1 + \text{SBUFF}_2) + \dots + (\text{MBUFF}_{n+1} + \text{SBUFF}_n))}{f_{\text{cg}}} \text{ secs}$$

Where:

f_{cg} is the frequency output from the carrier generator. For an example of extended space operation, see **Figure 9-9**.

NOTE: The EXSPC feature can be used to emulate a zero mark event.

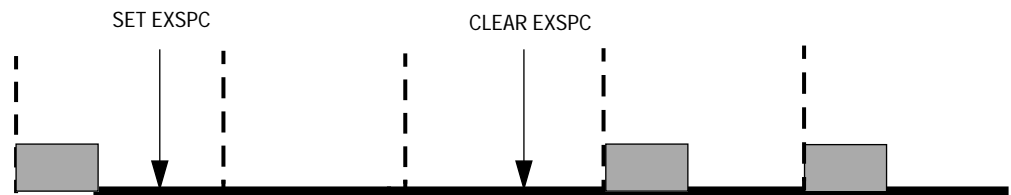

Figure 9-9. Extended Space Operation

9.5.3.1 End Of Cycle (EOC) Interrupt

At the end of each cycle (when the counter is reloaded from MBUFF), the end of cycle (EOC) flag is set. If the interrupt enable bit was previously set, an interrupt will also be issued to the CPU. The EOC interrupt provides a means for the user to reload new mark/space values into the MBUFF and SBUFF registers. As the EOC interrupt is coincident with reloading the counter, MBUFF does not require additional buffering and may be updated with a new value for the next period from within the EOC interrupt service routine (ISR). To allow both mark and space period values to be updated from within the same ISR, SREG is buffered by SBUFF. The contents written to SBUFF are transferred to the active register SREG at the end of every cycle regardless of the state of the EOC flag. The EOC flag is cleared by a read of the modulator control and status register (MCSR) followed by an access of MDR2 or MDR3. The EOC flag must be cleared within the ISR to prevent another interrupt being generated after exiting the ISR. If the EOC interrupt is not being used (IE = 0), the EOC flag need not be cleared.

Carrier Modulator Transmitter (CMT)

9.5.3.2 Modulator Control and Status Register

The modulator control and status register (MCSR) contains the modulator and carrier generator enable (MCGEN), interrupt enable (IE), mode select (MODE), baseband enable (BASE), extended space (EXSPC), and external interrupt mask (EIMSK) control bits, divide-by-two prescaler (DIV2) bit, and the end of cycle (EOC) status bit.

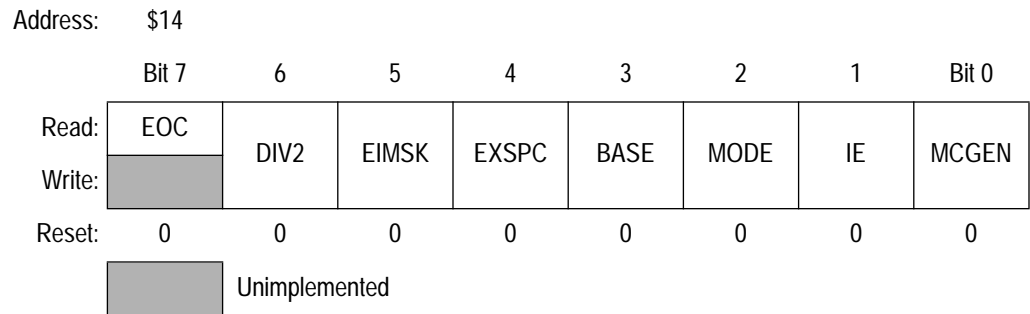

Figure 9-10. Modulator Control and Status Register (MCSR)

EOC — End Of Cycle Status Flag

EOC is set when a match occurs between the contents of the space period register, SREG, and the down counter. This is recognized as the end of the modulation cycle. At this time, the counter is initialized with the (possibly new) contents of the mark period buffer, MBUFF, and the space period register, SREG, is loaded with the (possibly new) contents of the space period buffer, SBUFF. This flag is cleared by a read of the MCSR followed by an access of MDR2 or MDR3. The EOC flag is cleared by reset.

- 1 = End of modulator cycle (counter = SBUFF) has occurred
- 0 = Current modulation cycle in progress

DIV2 — Divide-by-two prescaler

The divide-by-two prescaler causes the CMT to be clocked at the bus rate when enabled; 2 x the bus rate when disabled (f_{osc}). This bit is not double buffered and so should not be set during a transmission.

- 1 = Divide-by-two prescaler enabled
- 0 = Divide-by-two prescaler disabled

EIMSK — External Interrupt Mask

The external interrupt mask bit is used to mask IRQ and keyscan interrupts. This bit is cleared by reset.

1 = IRQ and keyscan interrupts masked

0 = IRQ and keyscan interrupts enabled

EXSPC — Extended Space Enable

For a description of the extended space enable bit, see [9.5.3 Extended Space Operation](#). This bit is cleared by reset.

1 = Extended space enabled

0 = Extended space disabled

BASE — Baseband Enable

When set, the BASE bit disables the carrier generator and forces the carrier output high for generation of baseband protocols. When BASE is clear, the carrier generator is enabled and the carrier output toggles at the frequency determined by values stored in the carrier data registers. See [9.5.1 Time Mode](#). This bit is cleared by reset. This bit is not double buffered and should not be written to during a transmission.

1 = Baseband enabled

0 = Baseband disabled

MODE — Mode Select

For a description of CMT operation in time mode, see [9.5.1 Time Mode](#). For a description of CMT operation in FSK mode, see [9.5.2 FSK Mode](#). This bit is cleared by reset. This bit is not double buffered and should not be written to during a transmission.

1 = CMT operates in FSK mode.

0 = CMT operates in time mode.

IE — Interrupt Enable

A CPU interrupt will be requested when EOC is set if IE was previously set. If IE is clear, EOC will not request a CPU interrupt.

1 = CPU interrupt enabled

0 = CPU interrupt disabled

MCGEN — Modulator and Carrier Generator Enable

Setting MCGEN will initialize the carrier generator and modulator and will enable all clocks. Once enabled, the carrier generator and modulator will function continuously. When MCGEN is cleared, the current modulator cycle will be allowed to expire before all carrier and modulator clocks are disabled (to save power) and the modulator output is forced low. The user should initialize all data and control registers before enabling the system to prevent spurious operation. This bit is cleared by reset.

1 = Modulator and carrier generator enabled

0 = Modulator and carrier generator disabled

9.5.4 Modulator Period Data Registers (MDR1, MDR2, and MDR3)

The 12-bit MBUFF and SBUFF registers are accessed through three 8-bit registers: MDR1, MDR2, and MDR3. MDR2 and MDR3 contain the least significant eight bits of MBUFF and SBUFF respectively. MDR1 contains the two most significant nibbles of MBUFF and SBUFF. In many applications, periods greater than those obtained by eight bits will not be required. Dividing the registers in this manner allows the user to clear MDR1 and generate 8-bit periods with just two data writes.

Address: \$0015

	Bit 7	6	5	4	3	2	1	Bit 0
Read:								
Write:	MB11	MB10	MB9	MB8	SB11	SB10	SB9	SB8
Reset:	Unaffected by Reset							

Figure 9-11. Modulator Period Data Register MDR1

Address: \$0016

	Bit 7	6	5	4	3	2	1	Bit 0
Read:								
Write:	MB7	MB6	MB5	MB4	MB3	MB2	MB1	MB0
Reset:	Unaffected by Reset							

Figure 9-12. Modulator Period Data Register MDR2

Address: \$0017

	Bit 7	6	5	4	3	2	1	Bit 0
Read:								
Write:	SB7	SB6	SB5	SB4	SB3	SB2	SB1	SB0
Reset:	Unaffected by Reset							

Figure 9-13. Modulator Period Data Register MDR3

Section 10. EPROM

10.1 Contents

10.2	Introduction	83
10.3	EPROM	83
10.4	Bootloader	84
10.4.1	Bootloader Functions	84
10.4.2	Programming Register	86
10.4.3	Mask Option Registers (MOR1 and MOR2)	87

10.2 Introduction

This section describes erasable programmable read-only memory (EPROM) programming.

10.3 EPROM

The user EPROM consists of 15,936 bytes of EPROM from \$0180 to \$3FAF and 14 bytes of user vectors from \$3FF2 to \$3FFF.

The bootloader ROM and vectors are located from \$3FB0 to \$3FEF.

Ten of the user vectors, \$3FF6–\$3FFF, are dedicated to reset and interrupt vectors. The four remaining locations, \$3FF2–\$3FF5, are general-purpose user EPROM locations. The mask option registers (MOR1 and MOR2) are located at \$3FF0 and \$3FF1.

10.4 Bootloader

This program (contained in an on-chip boot ROM) handles copying of user code from an external EPROM into the on-chip EPROM. The bootloader function does not have to be done from an external EPROM, but can be done from a host.

10.4.1 Bootloader Functions

Two pins are used to select the bootloader function. These pins are PC1 and PB5. PC1 is normally a SYNC pin, which is used to synchronize the MCU to an off-chip source that is driving EPROM data into the MCU. The programmer/host interface is shown in [Figure 10-1](#).

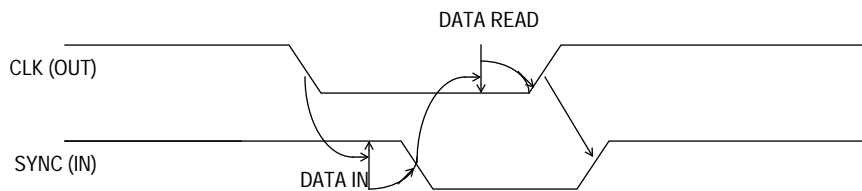

Figure 10-1. Programmer Interface to Host

If an external EPROM is used, this pin (PC1) must be connected to V_{SS} . PB5 is used to select between program/verify or verify-only modes. Two other pins, PB2 and IRO, are used to drive the VERF LED and the PROG LED respectively. The programming modes are shown in [Table 10-1](#).

Table 10-1. Bootloader Functions

PC1	PB5	Mode
SYNC	1	Program/Verify
SYNC	0	Verify Only

The bootloader programming board shown in [Figure 10-2](#) uses an external 12-bit counter to address the memory device containing the code to be copied. This counter requires a clock and a reset function. The 12-bit counter can address up to 4 Kbytes of memory, which means that two port pins have to be used to address the extra memory space.

NOTE: The user code must be a one-to-one correspondence with the internal EPROM addresses.

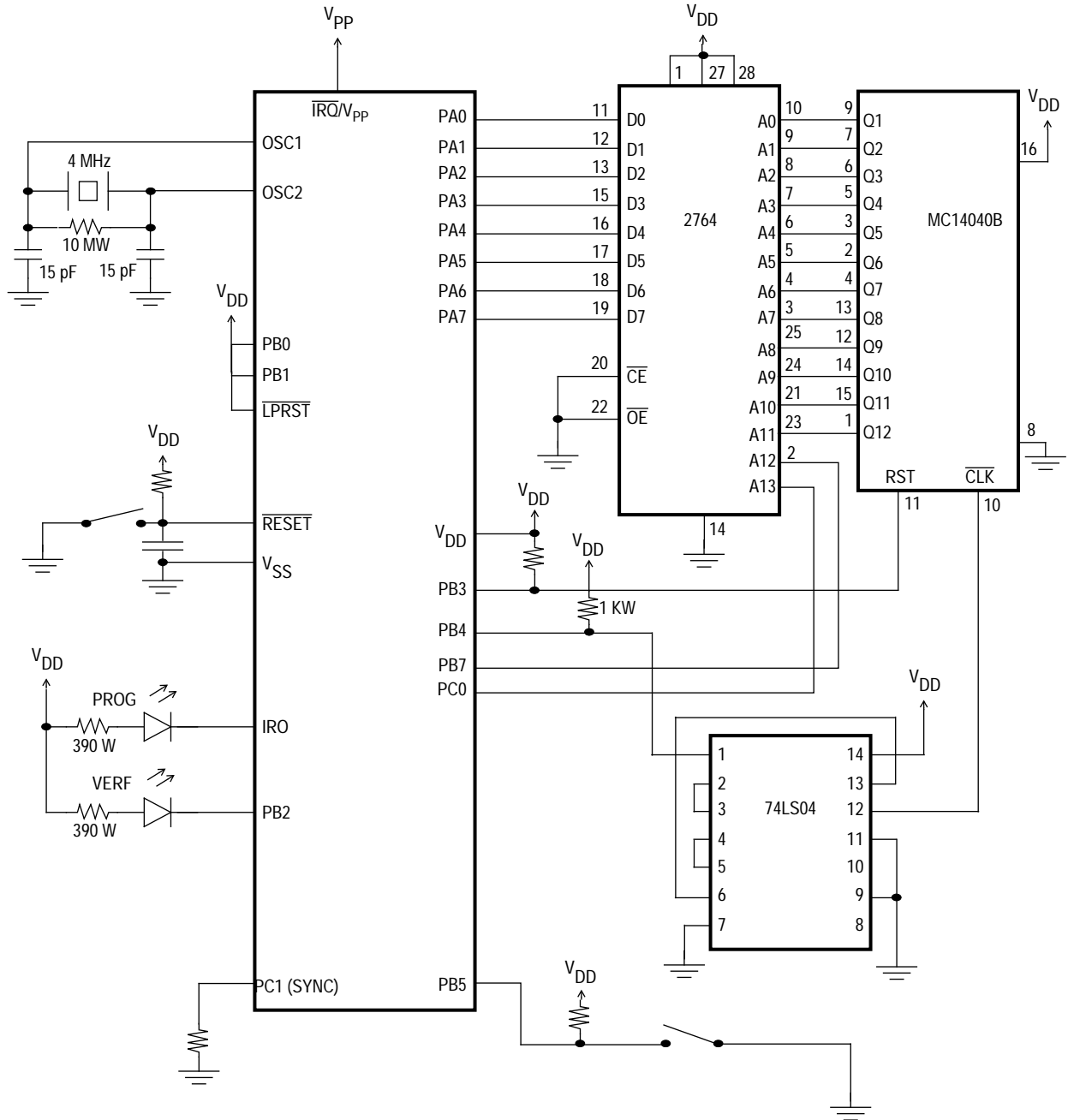

NOTE: All resistors are 10 kΩ unless specified otherwise.

Figure 10-2. MC68HC705RC16 Programming Circuit

10.4.2 Programming Register

This register is used to program the EPROM array. Only the LATCH and EPGM bits are available in user mode. To program a byte of EPROM, set LATCH, then write data to the desired address, then set EPGM for t_{EPGM} .

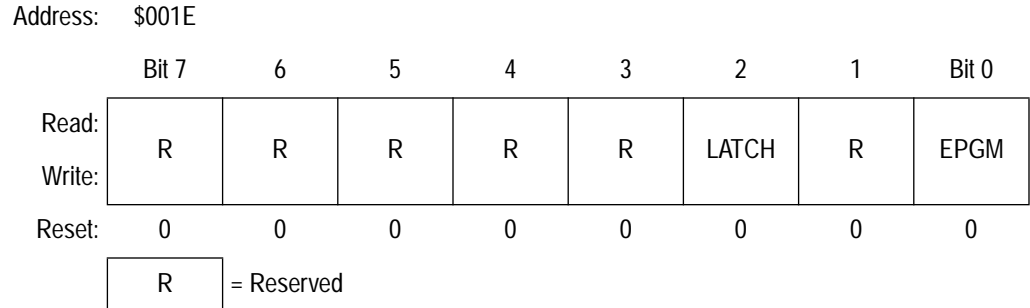

Figure 10-3. Programming Register (PROG)

LATCH — EPROM Latch Control

READ: Any time

WRITE: Any time

1 = EPROM address and data bus configured for programming.

Causes address and data bus to be latched when a write to EPROM is done. EPROM cannot be read if LATCH = 1.

0 = EPROM address and data bus configured for normal reads

EPGM — EPROM Program Control

READ: Any time

WRITE: Any time security is not set

1 = V_{PP} switched on to the EPROM array. If LATCH = 1, EPGM switches programming power to the EPROM array.

0 = Programming power switched off the EPROM array

10.4.3 Mask Option Registers (MOR1 and MOR2)

The mask option registers contain programmable EPROM bits to control mask options. The MOR register is latched at the end of reset and refreshed periodically depending on how often the EPROM is read.

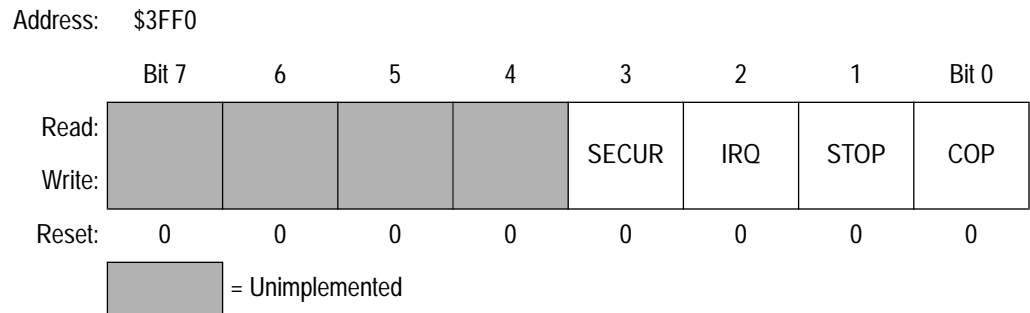

Figure 10-4. Mask Option Register 1 (MOR1)

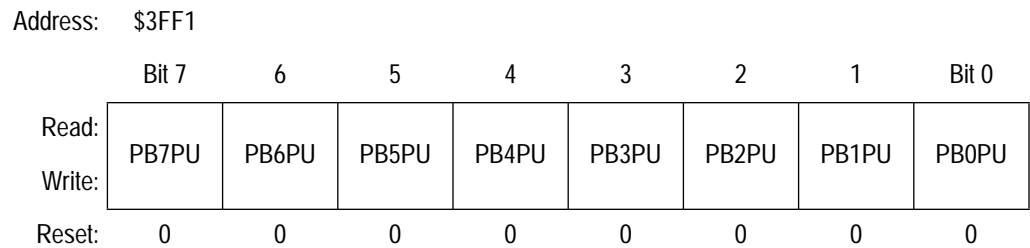

Figure 10-5. Mask Option Register 2 (MOR2)

PBXPU — Port B Pullup (X is 7–0)

When set, the PBPUP bit enables the pullup on the corresponding port B pin. If the PBPUP bit is cleared, the pullup devices are disabled. The erased state of the PBPUP bit is to be cleared, thereby disabling the pullup devices.

NOTE: *The MOR registers are reset to zero during reset. This causes the port B pullup devices to become inactive until reset is completed.*

SECUR — SECURITY Enable

- 1 = This bit secures the EPROM by disabling a read of the EPROM in all modes other than user. This bit also disables writes to the MOR registers and the programming register.
- 0 = The EPROM can be read in all modes.

STOP — STOP Enable

1 = This bit enables the STOP instruction.

0 = A STOP instruction is equivalent to a WAIT instruction.

COP — COP Enable

1 = This bit enables the COP watchdog timer.

0 = The COP is disabled.

IRQ — IRQ sensitivity

1 = This bit selects the edge- and level-sensitive IRQ.

0 = IRQ is edge-only sensitive.

NOTE: *The port B keyscan interrupt sensitivity will match that of the IRQ sensitivity. (See [4.7 External Interrupt \(IRQ/Port B Pullup\)](#) for more information.)*

Section 11. Instruction Set

11.1 Contents

11.2	Introduction	90
11.3	Addressing Modes	90
11.3.1	Inherent	91
11.3.2	Immediate	91
11.3.3	Direct	91
11.3.4	Extended	91
11.3.5	Indexed, No Offset	92
11.3.6	Indexed, 8-Bit Offset	92
11.3.7	Indexed, 16-Bit Offset	92
11.3.8	Relative	93
11.4	Instruction Types	93
11.4.1	Register/Memory Instructions	94
11.4.2	Read-Modify-Write Instructions	95
11.4.3	Jump/Branch Instructions	96
11.4.4	Bit Manipulation Instructions	98
11.4.5	Control Instructions	99
11.5	Instruction Set Summary	100

11.2 Introduction

The MCU instruction set has 62 instructions and uses eight addressing modes. The instructions include all those of the M146805 CMOS Family plus one more: the unsigned multiply (MUL) instruction. The MUL instruction allows unsigned multiplication of the contents of the accumulator (A) and the index register (X). The high-order product is stored in the index register, and the low-order product is stored in the accumulator.

11.3 Addressing Modes

The CPU uses eight addressing modes for flexibility in accessing data. The addressing modes provide eight different ways for the CPU to find the data required to execute an instruction. The eight addressing modes are:

- Inherent
- Immediate
- Direct
- Extended
- Indexed, no offset
- Indexed, 8-bit offset
- Indexed, 16-bit offset
- Relative

11.3.1 Inherent

Inherent instructions are those that have no operand, such as return from interrupt (RTI) and stop (STOP). Some of the inherent instructions act on data in the CPU registers, such as set carry flag (SEC) and increment accumulator (INCA). Inherent instructions require no operand address and are one byte long.

11.3.2 Immediate

Immediate instructions are those that contain a value to be used in an operation with the value in the accumulator or index register. Immediate instructions require no operand address and are two bytes long. The opcode is the first byte, and the immediate data value is the second byte.

11.3.3 Direct

Direct instructions can access any of the first 256 memory locations with two bytes. The first byte is the opcode, and the second is the low byte of the operand address. In direct addressing, the CPU automatically uses \$00 as the high byte of the operand address.

11.3.4 Extended

Extended instructions use three bytes and can access any address in memory. The first byte is the opcode; the second and third bytes are the high and low bytes of the operand address.

When using the Freescale assembler, the programmer does not need to specify whether an instruction is direct or extended. The assembler automatically selects the shortest form of the instruction.

11.3.5 Indexed, No Offset

Indexed instructions with no offset are 1-byte instructions that can access data with variable addresses within the first 256 memory locations. The index register contains the low byte of the effective address of the operand. The CPU automatically uses \$00 as the high byte, so these instructions can address locations \$0000–\$00FF.

Indexed, no offset instructions are often used to move a pointer through a table or to hold the address of a frequently used RAM or I/O location.

11.3.6 Indexed, 8-Bit Offset

Indexed, 8-bit offset instructions are 2-byte instructions that can access data with variable addresses within the first 511 memory locations. The CPU adds the unsigned byte in the index register to the unsigned byte following the opcode. The sum is the effective address of the operand. These instructions can access locations \$0000–\$01FE.

Indexed 8-bit offset instructions are useful for selecting the kth element in an n-element table. The table can begin anywhere within the first 256 memory locations and could extend as far as location 510 (\$01FE). The k value is typically in the index register, and the address of the beginning of the table is in the byte following the opcode.

11.3.7 Indexed, 16-Bit Offset

Indexed, 16-bit offset instructions are 3-byte instructions that can access data with variable addresses at any location in memory. The CPU adds the unsigned byte in the index register to the two unsigned bytes following the opcode. The sum is the effective address of the operand. The first byte after the opcode is the high byte of the 16-bit offset; the second byte is the low byte of the offset.

Indexed, 16-bit offset instructions are useful for selecting the kth element in an n-element table anywhere in memory.

As with direct and extended addressing, the Freescale assembler determines the shortest form of indexed addressing.

11.3.8 Relative

Relative addressing is only for branch instructions. If the branch condition is true, the CPU finds the effective branch destination by adding the signed byte following the opcode to the contents of the program counter. If the branch condition is not true, the CPU goes to the next instruction. The offset is a signed, two's complement byte that gives a branching range of -128 to $+127$ bytes from the address of the next location after the branch instruction.

When using the Freescale assembler, the programmer does not need to calculate the offset, because the assembler determines the proper offset and verifies that it is within the span of the branch.

11.4 Instruction Types

The MCU instructions fall into the following five categories:

- Register/Memory Instructions
- Read-Modify-Write Instructions
- Jump/Branch Instructions
- Bit Manipulation Instructions
- Control Instructions

11.4.1 Register/Memory Instructions

These instructions operate on CPU registers and memory locations. Most of them use two operands. One operand is in either the accumulator or the index register. The CPU finds the other operand in memory.

Table 11-1. Register/Memory Instructions

Instruction	Mnemonic
Add Memory Byte and Carry Bit to Accumulator	ADC
Add Memory Byte to Accumulator	ADD
AND Memory Byte with Accumulator	AND
Bit Test Accumulator	BIT
Compare Accumulator	CMP
Compare Index Register with Memory Byte	CPX
EXCLUSIVE OR Accumulator with Memory Byte	EOR
Load Accumulator with Memory Byte	LDA
Load Index Register with Memory Byte	LDX
Multiply	MUL
OR Accumulator with Memory Byte	ORA
Subtract Memory Byte and Carry Bit from Accumulator	SBC
Store Accumulator in Memory	STA
Store Index Register in Memory	STX
Subtract Memory Byte from Accumulator	SUB

11.4.2 Read-Modify-Write Instructions

These instructions read a memory location or a register, modify its contents, and write the modified value back to the memory location or to the register.

NOTE: *Do not use read-modify-write operations on write-only registers.*

Table 11-2. Read-Modify-Write Instructions

Instruction	Mnemonic
Arithmetic Shift Left (Same as LSL)	ASL
Arithmetic Shift Right	ASR
Bit Clear	BCLR ⁽¹⁾
Bit Set	BSET ⁽¹⁾
Clear Register	CLR
Complement (One's Complement)	COM
Decrement	DEC
Increment	INC
Logical Shift Left (Same as ASL)	LSL
Logical Shift Right	LSR
Negate (Two's Complement)	NEG
Rotate Left through Carry Bit	ROL
Rotate Right through Carry Bit	ROR
Test for Negative or Zero	TST ⁽²⁾

1. Unlike other read-modify-write instructions, BCLR and BSET use only direct addressing.
2. TST is an exception to the read-modify-write sequence because it does not write a replacement value.

11.4.3 Jump/Branch Instructions

Jump instructions allow the CPU to interrupt the normal sequence of the program counter. The unconditional jump instruction (JMP) and the jump-to-subroutine instruction (JSR) have no register operand. Branch instructions allow the CPU to interrupt the normal sequence of the program counter when a test condition is met. If the test condition is not met, the branch is not performed.

The BRCLR and BRSET instructions cause a branch based on the state of any readable bit in the first 256 memory locations. These 3-byte instructions use a combination of direct addressing and relative addressing. The direct address of the byte to be tested is in the byte following the opcode. The third byte is the signed offset byte. The CPU finds the effective branch destination by adding the third byte to the program counter if the specified bit tests true. The bit to be tested and its condition (set or clear) is part of the opcode. The span of branching is from -128 to $+127$ from the address of the next location after the branch instruction. The CPU also transfers the tested bit to the carry/borrow bit of the condition code register.

Table 11-3. Jump and Branch Instructions

Instruction	Mnemonic
Branch if Carry Bit Clear	BCC
Branch if Carry Bit Set	BCS
Branch if Equal	BEQ
Branch if Half-Carry Bit Clear	BHCC
Branch if Half-Carry Bit Set	BHCS
Branch if Higher	BHI
Branch if Higher or Same	BHS
Branch if $\overline{\text{IRQ}}$ Pin High	BIH
Branch if $\overline{\text{IRQ}}$ Pin Low	BIL
Branch if Lower	BLO
Branch if Lower or Same	BLS
Branch if Interrupt Mask Clear	BMC
Branch if Minus	BMI
Branch if Interrupt Mask Set	BMS
Branch if Not Equal	BNE
Branch if Plus	BPL
Branch Always	BRA
Branch if Bit Clear	BRCLR
Branch Never	BRN
Branch if Bit Set	BRSET
Branch to Subroutine	BSR
Unconditional Jump	JMP
Jump to Subroutine	JSR

11.4.4 Bit Manipulation Instructions

The CPU can set or clear any writable bit in the first 256 bytes of memory, which includes I/O registers and on-chip RAM locations. The CPU can also test and branch based on the state of any bit in any of the first 256 memory locations.

Table 11-4. Bit Manipulation Instructions

Instruction	Mnemonic
Bit Clear	BCLR
Branch if Bit Clear	BRCLR
Branch if Bit Set	BRSET
Bit Set	BSET

11.4.5 Control Instructions

These instructions act on CPU registers and control CPU operation during program execution.

Table 11-5. Control Instructions

Instruction	Mnemonic
Clear Carry Bit	CLC
Clear Interrupt Mask	CLI
No Operation	NOP
Reset Stack Pointer	RSP
Return from Interrupt	RTI
Return from Subroutine	RTS
Set Carry Bit	SEC
Set Interrupt Mask	SEI
Stop Oscillator and Enable $\overline{\text{IRQ}}$ Pin	STOP
Software Interrupt	SWI
Transfer Accumulator to Index Register	TAX
Transfer Index Register to Accumulator	TXA
Stop CPU Clock and Enable Interrupts	WAIT

11.5 Instruction Set Summary

Table 11-6. Instruction Set Summary

Source Form	Operation	Description	Effect on CCR					Address Mode	Opcode	Operand	Cycles
			H	I	N	Z	C				
ADC #opr ADC opr ADC opr ADC opr,X ADC opr,X ADC ,X	Add with Carry	$A \leftarrow (A) + (M) + (C)$	↕x	—	↕x	↕x	↕x	IMM DIR EXT IX2 IX1 IX	A9 B9 C9 D9 E9 F9	ii dd hh ll ee ff ff	2 3 4 5 4 3
ADD #opr ADD opr ADD opr ADD opr,X ADD opr,X ADD ,X	Add without Carry	$A \leftarrow (A) + (M)$	↕x	—	↕x	↕	↕	IMM DIR EXT IX2 IX1 IX	AB BB CB DB EB FB	ii dd hh ll ee ff ff	2 3 4 5 4 3
AND #opr AND opr AND opr AND opr,X AND opr,X AND ,X	Logical AND	$A \leftarrow (A) \wedge (M)$	—	—	↕x	↕	—	IMM DIR EXT IX2 IX1 IX	A4 B4 C4 D4 E4 F4	ii dd hh ll ee ff ff	2 3 4 5 4 3
ASL opr ASLA ASLX ASL opr,X ASL ,X	Arithmetic Shift Left (Same as LSL)		—	—	↕x	↕	↕	DIR INH INH IX1 IX	38 48 58 68 78	dd ff	5 3 3 6 5
ASR opr ASRA ASRX ASR opr,X ASR ,X	Arithmetic Shift Right		—	—	↕x	↕	↕	DIR INH INH IX1 IX	37 47 57 67 77	dd ff	5 3 3 6 5
BCC rel	Branch if Carry Bit Clear	$PC \leftarrow (PC) + 2 + rel ? C = 0$	—	—	—	—	—	REL	24	rr	3
BCLR n opr	Clear Bit n	$M_n \leftarrow 0$	—	—	—	—	—	DIR (b0) DIR (b1) DIR (b2) DIR (b3) DIR (b4) DIR (b5) DIR (b6) DIR (b7)	11 13 15 17 19 1B 1D 1F	dd dd dd dd dd dd dd dd	5 5 5 5 5 5 5 5
BCS rel	Branch if Carry Bit Set (Same as BLO)	$PC \leftarrow (PC) + 2 + rel ? C = 1$	—	—	—	—	—	REL	25	rr	3
BEQ rel	Branch if Equal	$PC \leftarrow (PC) + 2 + rel ? Z = 1$	—	—	—	—	—	REL	27	rr	3
BHCC rel	Branch if Half-Carry Bit Clear	$PC \leftarrow (PC) + 2 + rel ? H = 0$	—	—	—	—	—	REL	28	rr	3
BHCS rel	Branch if Half-Carry Bit Set	$PC \leftarrow (PC) + 2 + rel ? H = 1$	—	—	—	—	—	REL	29	rr	3
BHI rel	Branch if Higher	$PC \leftarrow (PC) + 2 + rel ? C \vee Z = 0$	—	—	—	—	—	REL	22	rr	3
BHS rel	Branch if Higher or Same	$PC \leftarrow (PC) + 2 + rel ? C = 0$	—	—	—	—	—	REL	24	rr	3

Table 11-6. Instruction Set Summary (Continued)

Source Form	Operation	Description	Effect on CCR					Address Mode	Opcode	Operand	Cycles
			H	I	N	Z	C				
BIH <i>rel</i>	Branch if IRQ Pin High	$PC \leftarrow (PC) + 2 + rel ? IRQ = 1$	—	—	—	—	—	REL	2F	rr	3
BIL <i>rel</i>	Branch if IRQ Pin Low	$PC \leftarrow (PC) + 2 + rel ? IRQ = 0$	—	—	—	—	—	REL	2E	rr	3
BIT # <i>opr</i> BIT <i>opr</i> BIT <i>opr</i> BIT <i>opr</i> ,X BIT <i>opr</i> ,X BIT ,X	Bit Test Accumulator with Memory Byte	(A) ^ (M)	—	—	↕x	↕	—	IMM DIR EXT IX2 IX1 IX	A5 B5 C5 D5 E5 F5	ii dd hh ll ee ff ff	2 3 4 5 4 3
BLO <i>rel</i>	Branch if Lower (Same as BCS)	$PC \leftarrow (PC) + 2 + rel ? C = 1$	—	—	—	—	—	REL	25	rr	3
BLS <i>rel</i>	Branch if Lower or Same	$PC \leftarrow (PC) + 2 + rel ? C \vee Z = 1$	—	—	—	—	—	REL	23	rr	3
BMC <i>rel</i>	Branch if Interrupt Mask Clear	$PC \leftarrow (PC) + 2 + rel ? I = 0$	—	—	—	—	—	REL	2C	rr	3
BMI <i>rel</i>	Branch if Minus	$PC \leftarrow (PC) + 2 + rel ? N = 1$	—	—	—	—	—	REL	2B	rr	3
BMS <i>rel</i>	Branch if Interrupt Mask Set	$PC \leftarrow (PC) + 2 + rel ? I = 1$	—	—	—	—	—	REL	2D	rr	3
BNE <i>rel</i>	Branch if Not Equal	$PC \leftarrow (PC) + 2 + rel ? Z = 0$	—	—	—	—	—	REL	26	rr	3
BPL <i>rel</i>	Branch if Plus	$PC \leftarrow (PC) + 2 + rel ? N = 0$	—	—	—	—	—	REL	2A	rr	3
BRA <i>rel</i>	Branch Always	$PC \leftarrow (PC) + 2 + rel ? 1 = 1$	—	—	—	—	—	REL	20	rr	3
BRCLR <i>n opr rel</i>	Branch if Bit n Clear	$PC \leftarrow (PC) + 2 + rel ? Mn = 0$	—	—	—	—	↕x	DIR (b0) DIR (b1) DIR (b2) DIR (b3) DIR (b4) DIR (b5) DIR (b6) DIR (b7)	01 03 05 07 09 0B 0D 0F	dd rr dd rr dd rr dd rr dd rr dd rr dd rr dd rr	5 5 5 5 5 5 5 5
BRN <i>rel</i>	Branch Never	$PC \leftarrow (PC) + 2 + rel ? 1 = 0$	—	—	—	—	—	REL	21	rr	3
BRSET <i>n opr rel</i>	Branch if Bit n Set	$PC \leftarrow (PC) + 2 + rel ? Mn = 1$	—	—	—	—	⊗	DIR (b0) DIR (b1) DIR (b2) DIR (b3) DIR (b4) DIR (b5) DIR (b6) DIR (b7)	00 02 04 06 08 0A 0C 0E	dd rr dd rr dd rr dd rr dd rr dd rr dd rr dd rr	5 5 5 5 5 5 5 5
BSET <i>n opr</i>	Set Bit n	$Mn \leftarrow 1$	—	—	—	—	—	DIR (b0) DIR (b1) DIR (b2) DIR (b3) DIR (b4) DIR (b5) DIR (b6) DIR (b7)	10 12 14 16 18 1A 1C 1E	dd dd dd dd dd dd dd dd	5 5 5 5 5 5 5 5
BSR <i>rel</i>	Branch to Subroutine	$PC \leftarrow (PC) + 2$; push (PCL) $SP \leftarrow (SP) - 1$; push (PCH) $SP \leftarrow (SP) - 1$ $PC \leftarrow (PC) + rel$	—	—	—	—	—	REL	AD	rr	6
CLC	Clear Carry Bit	$C \leftarrow 0$	—	—	—	—	0	INH	98		2
CLI	Clear Interrupt Mask	$I \leftarrow 0$	—	0	—	—	—	INH	9A		2

Table 11-6. Instruction Set Summary (Continued)

Source Form	Operation	Description	Effect on CCR					Address Mode	Opcode	Operand	Cycles
			H	I	N	Z	C				
CLR <i>opr</i> CLRA CLR X CLR <i>opr</i> ,X CLR ,X	Clear Byte	M ← \$00 A ← \$00 X ← \$00 M ← \$00 M ← \$00	—	—	0	1	—	DIR INH INH IX1 IX	3F 4F 5F 6F 7F	dd ff	5 3 3 6 5
CMP # <i>opr</i> CMP <i>opr</i> CMP <i>opr</i> CMP <i>opr</i> ,X CMP <i>opr</i> ,X CMP ,X	Compare Accumulator with Memory Byte	(A) – (M)	—	—	↑x	↑	↑	IMM DIR EXT IX2 IX1 IX	A1 B1 C1 D1 E1 F1	ii dd hh ll ee ff ff	2 3 4 5 4 3
COM <i>opr</i> COMA COM X COM <i>opr</i> ,X COM ,X	Complement Byte (One's Complement)	M ← (M) = \$FF – (M) A ← (A) = \$FF – (A) X ← (X) = \$FF – (X) M ← (M) = \$FF – (M) M ← (M) = \$FF – (M)	—	—	↑x	↑x	1	DIR INH INH IX1 IX	33 43 53 63 73	dd ff	5 3 3 6 5
CPX # <i>opr</i> CPX <i>opr</i> CPX <i>opr</i> CPX <i>opr</i> ,X CPX <i>opr</i> ,X CPX ,X	Compare Index Register with Memory Byte	(X) – (M)	—	—	↑x	⊗	⊗	IMM DIR EXT IX2 IX1 IX	A3 B3 C3 D3 E3 F3	ii dd hh ll ee ff ff	2 3 4 5 4 3
DEC <i>opr</i> DECA DEC X DEC <i>opr</i> ,X DEC ,X	Decrement Byte	M ← (M) – 1 A ← (A) – 1 X ← (X) – 1 M ← (M) – 1 M ← (M) – 1	—	—	↑x	↑x	—	DIR INH INH IX1 IX	3A 4A 5A 6A 7A	dd ff	5 3 3 6 5
EOR # <i>opr</i> EOR <i>opr</i> EOR <i>opr</i> EOR <i>opr</i> ,X EOR <i>opr</i> ,X EOR ,X	EXCLUSIVE OR Accumulator with Memory Byte	A ← (A) ⊕ (M)	—	—	↑x	↑	—	IMM DIR EXT IX2 IX1 IX	A8 B8 C8 D8 E8 F8	ii dd hh ll ee ff ff	2 3 4 5 4 3
INC <i>opr</i> INCA INC X INC <i>opr</i> ,X INC ,X	Increment Byte	M ← (M) + 1 A ← (A) + 1 X ← (X) + 1 M ← (M) + 1 M ← (M) + 1	—	—	↑x	↑x	—	DIR INH INH IX1 IX	3C 4C 5C 6C 7C	dd ff	5 3 3 6 5
JMP <i>opr</i> JMP <i>opr</i> JMP <i>opr</i> ,X JMP <i>opr</i> ,X JMP ,X	Unconditional Jump	PC ← Jump Address	—	—	—	—	—	DIR EXT IX2 IX1 IX	BC CC DC EC FC	dd hh ll ee ff ff	2 3 4 3 2

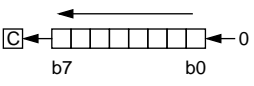
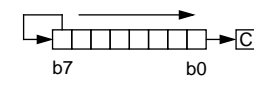
Table 11-6. Instruction Set Summary (Continued)

Source Form	Operation	Description	Effect on CCR					Address Mode	Opcode	Operand	Cycles
			H	I	N	Z	C				
JSR <i>opr</i> JSR <i>opr</i> JSR <i>opr,X</i> JSR <i>opr,X</i> JSR ,X	Jump to Subroutine	PC ← (PC) + n (n = 1, 2, or 3) Push (PCL); SP ← (SP) – 1 Push (PCH); SP ← (SP) – 1 PC ← Effective Address	—	—	—	—	—	DIR EXT IX2 IX1 IX	BD CD DD ED FD	dd hh ll ee ff ff	5 6 7 6 5
LDA # <i>opr</i> LDA <i>opr</i> LDA <i>opr</i> LDA <i>opr,X</i> LDA <i>opr,X</i> LDA ,X	Load Accumulator with Memory Byte	A ← (M)	—	—	↕x	↕	—	IMM DIR EXT IX2 IX1 IX	A6 B6 C6 D6 E6 F6	ii dd hh ll ee ff ff	2 3 4 5 4 3
LDX # <i>opr</i> LDX <i>opr</i> LDX <i>opr</i> LDX <i>opr,X</i> LDX <i>opr,X</i> LDX ,X	Load Index Register with Memory Byte	X ← (M)	—	—	↕x	↕x	—	IMM DIR EXT IX2 IX1 IX	AE BE CE DE EE FE	ii dd hh ll ee ff ff	2 3 4 5 4 3
LSL <i>opr</i> LSLA LSLX LSL <i>opr,X</i> LSL ,X	Logical Shift Left (Same as ASL)		—	—	↕x	↕	↕	DIR INH INH IX1 IX	38 48 58 68 78	dd ff	5 3 3 6 5
LSR <i>opr</i> LSRA LSRX LSR <i>opr,X</i> LSR ,X	Logical Shift Right		—	—	0	↕	↕	DIR INH INH IX1 IX	34 44 54 64 74	dd ff	5 3 3 6 5
MUL	Unsigned Multiply	X : A ← (X) × (A)	0	—	—	—	0	INH	42		11
NEG <i>opr</i> NEGA NEGX NEG <i>opr,X</i> NEG ,X	Negate Byte (Two's Complement)	M ← -(M) = \$00 - (M) A ← -(A) = \$00 - (A) X ← -(X) = \$00 - (X) M ← -(M) = \$00 - (M) M ← -(M) = \$00 - (M)	—	—	↕x	↕	↕	DIR INH INH IX1 IX	30 40 50 60 70	dd ff	5 3 3 6 5
NOP	No Operation		—	—	—	—	—	INH	9D		2
ORA # <i>opr</i> ORA <i>opr</i> ORA <i>opr</i> ORA <i>opr,X</i> ORA <i>opr,X</i> ORA ,X	Logical OR Accumulator with Memory	A ← (A) ∨ (M)	—	—	↕x	↕	—	IMM DIR EXT IX2 IX1 IX	AA BA CA DA EA FA	ii dd hh ll ee ff ff	2 3 4 5 4 3
ROL <i>opr</i> ROLA ROLX ROL <i>opr,X</i> ROL ,X	Rotate Byte Left through Carry Bit		—	—	↕x	↕	↕	DIR INH INH IX1 IX	39 49 59 69 79	dd ff	5 3 3 6 5

Table 11-6. Instruction Set Summary (Continued)

Source Form	Operation	Description	Effect on CCR					Address Mode	Opcode	Operand	Cycles
			H	I	N	Z	C				
ROR <i>opr</i> RORA RORX ROR <i>opr,X</i> ROR ,X	Rotate Byte Right through Carry Bit		—	—	↕x	↕	↕	DIR INH INH IX1 IX	36 46 56 66 76	dd ff	5 3 3 6 5
RSP	Reset Stack Pointer	SP ← \$00FF	—	—	—	—	—	INH	9C		2
RTI	Return from Interrupt	SP ← (SP) + 1; Pull (CCR) SP ← (SP) + 1; Pull (A) SP ← (SP) + 1; Pull (X) SP ← (SP) + 1; Pull (PCH) SP ← (SP) + 1; Pull (PCL)	↕x	↕	↕	↕	↕	INH	80		9
RTS	Return from Subroutine	SP ← (SP) + 1; Pull (PCH) SP ← (SP) + 1; Pull (PCL)	—	—	—	—	—	INH	81		6
SBC # <i>opr</i> SBC <i>opr</i> SBC <i>opr</i> SBC <i>opr,X</i> SBC <i>opr,X</i> SBC ,X	Subtract Memory Byte and Carry Bit from Accumulator	A ← (A) – (M) – (C)	—	—	↕x	↕	↕	IMM DIR EXT IX2 IX1 IX	A2 B2 C2 D2 E2 F2	ii dd hh ll ee ff ff	2 3 4 5 4 3
SEC	Set Carry Bit	C ← 1	—	—	—	—	1	INH	99		2
SEI	Set Interrupt Mask	I ← 1	—	1	—	—	—	INH	9B		2
STA <i>opr</i> STA <i>opr</i> STA <i>opr,X</i> STA <i>opr,X</i> STA ,X	Store Accumulator in Memory	M ← (A)	—	—	↕x	↕	—	DIR EXT IX2 IX1 IX	B7 C7 D7 E7 F7	dd hh ll ee ff ff	4 5 6 5 4
STOP	Stop Oscillator and Enable IRQ Pin		—	0	—	—	—	INH	8E		2
STX <i>opr</i> STX <i>opr</i> STX <i>opr,X</i> STX <i>opr,X</i> STX ,X	Store Index Register In Memory	M ← (X)	—	—	↕x	↕	—	DIR EXT IX2 IX1 IX	BF CF DF EF FF	dd hh ll ee ff ff	4 5 6 5 4
SUB # <i>opr</i> SUB <i>opr</i> SUB <i>opr</i> SUB <i>opr,X</i> SUB <i>opr,X</i> SUB ,X	Subtract Memory Byte from Accumulator	A ← (A) – (M)	—	—	↕	↕	↕	IMM DIR EXT IX2 IX1 IX	A0 B0 C0 D0 E0 F0	ii dd hh ll ee ff ff	2 3 4 5 4 3
SWI	Software Interrupt	PC ← (PC) + 1; Push (PCL) SP ← (SP) – 1; Push (PCH) SP ← (SP) – 1; Push (X) SP ← (SP) – 1; Push (A) SP ← (SP) – 1; Push (CCR) SP ← (SP) – 1; I ← 1 PCH ← Interrupt Vector High Byte PCL ← Interrupt Vector Low Byte	—	1	—	—	—	INH	83		10
TAX	Transfer Accumulator to Index Register	X ← (A)	—	—	—	—	—	INH	97		2

Table 11-6. Instruction Set Summary (Continued)

Source Form	Operation	Description	Effect on CCR					Address Mode	Opcode	Operand	Cycles
			H	I	N	Z	C				
TST <i>opr</i> TSTA TSTX TST <i>opr</i> ,X TST ,X	Test Memory Byte for Negative or Zero	(M) – \$00	—	—	↓	↓	—	DIR INH INH IX1 IX	3D 4D 5D 6D 7D	dd ff	4 3 3 5 4
TXA	Transfer Index Register to Accumulator	A ← (X)	—	—	—	—	—	INH	9F		2
WAIT	Stop CPU Clock and Enable Interrupts		—	0x	—	—	—	INH	8F		2

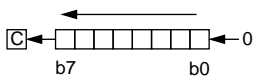
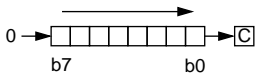
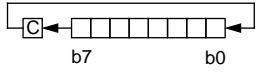
- | | | | |
|-------|---|------------|--------------------------------------|
| A | Accumulator | <i>opr</i> | Operand (one or two bytes) |
| C | Carry/borrow flag | PC | Program counter |
| CCR | Condition code register | PCH | Program counter high byte |
| dd | Direct address of operand | PCL | Program counter low byte |
| dd rr | Direct address of operand and relative offset of branch instruction | REL | Relative addressing mode |
| DIR | Direct addressing mode | <i>rel</i> | Relative program counter offset byte |
| ee ff | High and low bytes of offset in indexed, 16-bit offset addressing | rr | Relative program counter offset byte |
| EXT | Extended addressing mode | SP | Stack pointer |
| ff | Offset byte in indexed, 8-bit offset addressing | X | Index register |
| H | Half-carry flag | Z | Zero flag |
| hh ll | High and low bytes of operand address in extended addressing | # | Immediate value |
| I | Interrupt mask | ^ | Logical AND |
| ii | Immediate operand byte | ∨ | Logical OR |
| IMM | Immediate addressing mode | ⊕ | Logical EXCLUSIVE OR |
| INH | Inherent addressing mode | () | Contents of |
| IX | Indexed, no offset addressing mode | -() | Negation (two's complement) |
| IX1 | Indexed, 8-bit offset addressing mode | ← | Loaded with |
| IX2 | Indexed, 16-bit offset addressing mode | ? | If |
| M | Memory location | : | Concatenated with |
| N | Negative flag | ↓ | Set or cleared |
| n | Any bit | — | Not affected |

Instruction Set

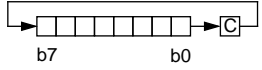
Table 11-7. Opcode Map

MSB LSB	Bit Manipulation		Read-Modify-Write				Control		Register/Memory				MSB LSB					
	DIR	REL	DIR	INH	INH	IX1	IX	INH	INH	IMM	DIR	EXT		IX2	IX1	IX		
0	5 3	BSET0 DIR2	5 3	NEG DIR1	3 1	NEGA INH1	3 1	NEG IX1	5 1	RTI INH	8	9	A	B	C	D	E	F
1	5 3	BCLR0 DIR2	5 3	BRN REL	5 3	MUL INH	11		6	RTS INH	6		2	3	4	5	4	3
2	5 3	BSET1 DIR2	5 3	BHI REL	5 3	1							2	3	4	5	4	3
3	5 3	BCLR1 DIR2	5 3	BLS REL2	5 3	5 3	COMA INH1	3 1	COM IX1	10	SWI INH		2	3	4	5	4	3
4	5 3	BSET2 DIR2	5 3	BCC REL2	5 3	5 3	LSRA INH1	3 1	LSR IX1	5			2	3	4	5	4	3
5	5 3	BCLR2 DIR2	5 3	BCS/BLO REL	5 3								2	3	4	5	4	3
6	5 3	BSET3 DIR2	5 3	BNE REL2	5 3	5 3	RORA INH1	3 1	ROR IX1	5			2	3	4	5	4	3
7	5 3	BCLR3 DIR2	5 3	BEQ REL2	5 3	5 3	ASRA INH1	3 1	ASR IX1	5	TAX INH		2	3	4	5	4	3
8	5 3	BSET4 DIR2	5 3	BHCC REL2	5 3	5 3	ASL/LSL INH1	3 1	ASL/LSL IX1	5			2	3	4	5	4	3
9	5 3	BCLR4 DIR2	5 3	BHCS REL2	5 3	5 3	ROLA INH1	3 1	ROL IX1	5			2	3	4	5	4	3
A	5 3	BSET5 DIR2	5 3	BPL REL2	5 3	5 3	DECA INH1	3 1	DEC IX1	5			2	3	4	5	4	3
B	5 3	BCLR5 DIR2	5 3	BMI REL	5 3								2	3	4	5	4	3
C	5 3	BSET6 DIR2	5 3	BMC REL2	5 3	5 3	INCA INH1	3 1	INC IX1	5			2	3	4	5	4	3
D	5 3	BCLR6 DIR2	5 3	BMS REL2	5 3	5 3	TSTA INH1	3 1	TST IX1	4			2	3	4	5	4	3
E	5 3	BSET7 DIR2	5 3	BIL REL	5 3								2	3	4	5	4	3
F	5 3	BCLR7 DIR2	5 3	BIH REL2	5 3	5 3	CLRA INH1	3 1	CLR IX1	5	TAX INH		2	3	4	5	4	3

MSB LSB		MSB of Opcode in Hexadecimal	
0	0	0	0
1	1	1	1
2	2	2	2
3	3	3	3
4	4	4	4
5	5	5	5
6	6	6	6
7	7	7	7
8	8	8	8
9	9	9	9
A	A	A	A
B	B	B	B
C	C	C	C
D	D	D	D
E	E	E	E
F	F	F	F

MSB LSB		MSB of Opcode in Hexadecimal	
0	0	0	0
1	1	1	1
2	2	2	2
3	3	3	3
4	4	4	4
5	5	5	5
6	6	6	6
7	7	7	7
8	8	8	8
9	9	9	9
A	A	A	A
B	B	B	B
C	C	C	C
D	D	D	D
E	E	E	E
F	F	F	F

INH = Inherent
 IMM = Immediate
 DIR = Direct
 EXT = Extended
 REL = Relative
 IX = Indexed, No Offset
 IX1 = Indexed, 8-Bit Offset
 IX2 = Indexed, 16-Bit Offset

Section 12. Electrical Specifications

12.1 Contents

12.2	Introduction	107
12.3	Maximum Ratings	108
12.4	Operating Temperature Range	109
12.5	Thermal Characteristics	109
12.6	DC Electrical Characteristics (5.0 Vdc)	110
12.7	DC Electrical Characteristics (3.3 Vdc)	111
12.8	Control Timing (5.0 Vdc and 3.3 Vdc)	112

12.2 Introduction

This section contains the electrical and timing specifications.

12.3 Maximum Ratings

Maximum ratings are the extreme limits to which the MCU can be exposed without permanently damaging it.

The MCU contains circuitry to protect the inputs against damage from high static voltages; however, do not apply voltages higher than those shown in the table below. Keep V_{IN} and V_{OUT} within the range $V_{SS} \leq (V_{IN} \text{ or } V_{OUT}) \leq V_{DD}$. Connect unused inputs to the appropriate voltage level, either V_{SS} or V_{DD} .

Rating	Symbol	Value	Unit
Supply Voltage	V_{DD}	-0.3 to +7.0	V
Bootloader Mode (\overline{IRQ}/V_{PP} Pin Only)	V_{IN}	$V_{SS} - 0.3$ to $2 \times V_{DD} + 0.3$	V
Current Drain Per Pin Excluding V_{DD} and V_{SS}	I	25	mA
Operating Junction Temperature	T_J	+150	°C
Storage Temperature Range	T_{stg}	-65 to +150	°C

NOTE: *This device is not guaranteed to operate properly at the maximum ratings. Refer to [12.6 DC Electrical Characteristics \(5.0 Vdc\)](#) and [12.7 DC Electrical Characteristics \(3.3 Vdc\)](#) for guaranteed operating conditions.*

12.4 Operating Temperature Range

Characteristic	Symbol	Value	Unit
Operating Temperature Range Standard	T_A	T_L to T_H 0 to +70	°C

12.5 Thermal Characteristics

Characteristic	Symbol	Value	Unit
Thermal Resistance Plastic Dual In-Line Package Small Outline Intergrated Circuit Package Plastic Leaded Chip Carrier Package	θ_{JA}	60 60 60	°C/W

Electrical Specifications

12.6 DC Electrical Characteristics (5.0 Vdc)

Characteristic	Symbol	Min	Typ	Max	Unit
Output Voltage $I_{LOAD} = 10.0 \mu A$ $I_{LOAD} = -10.0 \mu A$	V_{OL} V_{OH}	— $V_{DD} - 0.1$	— —	0.1 —	V
Output High Voltage ($I_{LOAD} = -2.0 \text{ mA}$) Port A, Port B, Port C (1–7) ($I_{LOAD} = -15 \text{ mA}$) IRO ($I_{LOAD} = -4.0 \text{ mA}$) Port C (Bit 0)	V_{OH}	$V_{DD} - 0.8$ $V_{DD} - 0.7$ $V_{DD} - 0.8$	$V_{DD} - 0.2$ $V_{DD} - 0.2$ $V_{DD} - 0.2$	— — —	V
Output Low Voltage ($I_{LOAD} = 3.0 \text{ mA}$) Port A, Port B, Port C (1–7) ($I_{LOAD} = 25.0 \text{ mA}$) IRO ($I_{LOAD} = 20.0 \text{ mA}$) Port C (Bit 0)	V_{OL}	— — —	0.2 0.2 0.2	0.4 0.8 0.4	V
Input High Voltage Port A, Port B, Port C, \overline{IRQ} , \overline{RESET} , \overline{LPRST} , OSC1	V_{IH}	$0.7 \times V_{DD}$	—	V_{DD}	V
Input Low Voltage Port A, Port B, Port C, \overline{IRQ} , \overline{RESET} , \overline{LPRST} , OSC1	V_{IL}	V_{SS}	—	$0.2 \times V_{DD}$	V
EPROM Programming Voltage	V	14.5	—	15.5	V
Supply Current (see Notes) Run Wait Stop 25 °C 0 to +70 °C	I_{DD}	— — — —	3.8 0.5 03 0.3	5.0 1.2 15 30	mA mA μA μA
I/O Ports Hi-Z Leakage Current Port A, Port B, Port C	I_{OZ}	-10	—	10	μA
Input Current \overline{RESET} , \overline{LPRST} , \overline{IRQ} , OSC1 PB0–PB7 with Pullups Enabled ($V_{IN} = 0.2 \times V_{DD}$) ⁸ PB0–PB7 with Pullups Enabled ($V_{IN} = 0.7 \times V_{DD}$)	I_{IN}	-1 -100 -50	— -330 -120	1 -700 -300	μA
Capacitance Ports (as Input or Output) \overline{RESET} , \overline{LPRST} , \overline{IRQ}	C_{OUT} C_{INT}	— —	— —	12 8	pF

NOTES:

- $V_{DD} = 5.0 \text{ Vdc} \pm 10\%$, $V_{SS} = 0 \text{ Vdc}$, $T_A = 0 \text{ }^\circ\text{C}$ to $+70 \text{ }^\circ\text{C}$, unless otherwise noted
- Typical values at midpoint of voltage range, 25 °C, only represent average measurements
- Wait I_{DD} : only core timer active
- Run (Operating) I_{DD} , wait I_{DD} : Measured using external square wave clock source ($f_{osc} = 4.2 \text{ MHz}$); all inputs 0.2 V from rail; no dc loads; less than 50 pF on all outputs; $C_L = 20 \text{ pF}$ on OSC2
- Wait, Stop I_{DD} : port A and port C configured as inputs, port B configured as outputs. $V_{IL} = 0.2 \text{ V}$, $V_{IH} = V_{DD} - 0.2 \text{ V}$
- Stop I_{DD} is measured with $OSC1 = V_{SS}$.
- Wait I_{DD} is affected linearly by the OSC2 capacitance.
- Pullups are designed to be capable of pulling to V_{IH} within 1 μs for a 100 pF, 4-k Ω load

12.7 DC Electrical Characteristics (3.3 Vdc)

Characteristic	Symbol	Min	Typ	Max	Unit
Output Voltage $I_{LOAD} = 10.0 \mu A$ $I_{LOAD} = -10.0 \mu A$	V_{OL} V_{OH}	— $V_{DD} - 0.1$	— —	0.1 —	V
Output High Voltage ($I_{LOAD} = -0.6 mA$) Port A, Port B, Port C (1–7) ($I_{LOAD} = -10.0 mA$) IRO ($I_{LOAD} = -1.2 mA$) Port C (Bit 0)	V_{OH}	$V_{DD} - 0.3$ $V_{DD} - 0.7$ $V_{DD} - 0.3$	$V_{DD} - 0.1$ $V_{DD} - 0.1$ $V_{DD} - 0.1$	— — —	V
Output Low Voltage ($I_{LOAD} = 1.0 mA$) Port A, Port B, Port C (1–7) ($I_{LOAD} = 8.0 mA$) IRO ($I_{LOAD} = 7.0 mA$) Port C (Bit 0)	V_{OL}	— — —	0.1 0.1 0.1	0.3 0.8 0.3	V
Input High Voltage Port A, Port B, Port C, \overline{IRQ} , \overline{RESET} , \overline{LPRST} , OSC1	V_{IH}	$0.7 \times V_{DD}$	—	V_{DD}	V
Input Low Voltage Port A, Port B, Port C, \overline{IRQ} , \overline{RESET} , \overline{LPRST} , OSC1	V_{IL}	V_{SS}	—	$0.4 \times V_{DD}$	V
EPROM Programming Voltage	V	14.5	—	15.5	V
Supply Current (see Notes) Run Wait Stop 25 °C 0 to +70 °C	I_{DD}	— — — —	1.8 0.33 0.1 0.1	3.0 0.8 4.0 8.0	mA mA μA μA
I/O Ports Hi-Z Leakage Current Port A, Port B, Port C	I_{OZ}	–4	—	4	μA
Input Current \overline{RESET} , \overline{LPRST} , \overline{IRQ} , OSC1 PB0-PB7 with pullups enabled ($V_{IN} = 0.4 \times V_{DD}$) ⁸ PB0-PB7 with pullups enabled ($V_{IN} = 0.7 \times V_{DD}$)	I_{IN}	–0.4 –25 –15	— –80 –50	0.4 –105 –65	μA
Capacitance Ports (as Input or Output) \overline{RESET} , \overline{LPRST} , \overline{IRQ}	C_{OUT} C_{INT}	— —	— —	12 8	pF

NOTES:

- $V_{DD} = 3.3 Vdc \pm 10\%$, $V_{SS} = 0 Vdc$, $T_L = 0 \text{ }^\circ C$ to $+70 \text{ }^\circ C$, unless otherwise noted
- Typical values at midpoint of voltage range, 25 °C, only represent average measurements.
- Wait I_{DD} : only core timer active
- Run (Operating) I_{DD} , wait I_{DD} : Measured using external square wave clock source ($f_{OSC} = 4.2 MHz$); all inputs 0.2 V from rail; no dc loads; less than 50 pF on all outputs; $C_L = 20 pF$ on OSC2
- Wait, Stop I_{DD} : port A and port C configured as inputs, port B configured as outputs. $V_{IL} = 0.2 V$, $V_{IH} = V_{DD} - 0.2 V$
- Stop I_{DD} is measured with $OSC1 = V_{SS}$.
- Wait I_{DD} is affected linearly by the OSC2 capacitance.
- Pullups are designed to be capable of pulling to V_{IH} within 25 μs for a 100 pF, 4-k Ω load

Electrical Specifications

12.8 Control Timing (5.0 Vdc and 3.3 Vdc)

Characteristic	Symbol	Min	Max	Unit
Frequency of Operation Crystal External Clock	f_{osc}	— dc	4.2 4.2	MHz
Internal Operating Frequency Crystal ($f_{osc} / 2$) External Clock ($f_{osc} / 2$)	f_{op}	— dc	2.1 2.1	MHz
Cycle Time	t_{cyc}	480	—	ns
Crystal Oscillator Startup Time	t_{OXOV}	—	100	ms
Stop Recovery Startup Time (Crystal Oscillator)	t_{ILCH}	—	100	ms
RESET Pulse Width	t_{RL}	1.5	—	t_{cyc}
Interrupt Pulse Width Low (Edge-Triggered)	t_{ILIH}	125	—	ns
Interrupt Pulse Period	t_{ILIL}	Note 2	—	t_{cyc}
OSC1 Pulse Width	t_{OH}, t_{OL}	90	—	ns
EPROM Byte Programming Time	t_{EPGM}	—	10.0	ms

NOTES:

- $V_{DD} = 3.0$ to 5.5 Vdc, $V_{SS} = 0$ Vdc, $T_A = 0$ °C to $+70$ °C, unless otherwise noted
- The minimum period, t_{ILIL} , should not be less than the number of cycle times it takes to execute the interrupt service routine plus $19 t_{cyc}$.

Section 13. Mechanical Specifications

13.1 Contents

13.2	Introduction	113
13.3	28-Pin Plastic Dual In-Line Package (Case 710-02)	114
13.4	28-Pin Small Outline Integrated Circuit Package (Case 751F-04)	114
13.5	44-Pin Plastic Leaded Chip Carrier Package (Case 777-02)	115

13.2 Introduction

This section describes the dimensions of the dual-in-line package (DIP), small outline integrated circuit (SOIC) MCU package, and the plastic leaded chip carrier (PLCC) package.

The following figures show the latest packages at the time of this publication. To make sure that you have the latest package specifications, contact one of the following:

- Local Freescale Sales Office

Mechanical Specifications

13.3 28-Pin Plastic Dual In-Line Package (Case 710-02)

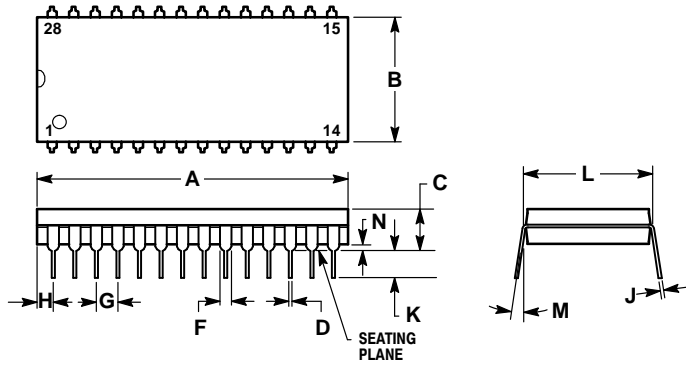

NOTES:

1. POSITIONAL TOLERANCE OF LEADS (D), SHALL BE WITHIN 0.25mm (0.010) AT MAXIMUM MATERIAL CONDITION, IN RELATION TO SEATING PLANE AND EACH OTHER.
2. DIMENSION L TO CENTER OF LEADS WHEN FORMED PARALLEL.
3. DIMENSION B DOES NOT INCLUDE MOLD FLASH.

DIM	MILLIMETERS		INCHES	
	MIN	MAX	MIN	MAX
A	36.45	37.21	1.435	1.465
B	13.72	14.22	0.540	0.560
C	3.94	5.08	0.155	0.200
D	0.36	0.56	0.014	0.022
F	1.02	1.52	0.040	0.060
G	2.54 BSC		0.100 BSC	
H	1.65	2.16	0.065	0.085
J	0.20	0.38	0.008	0.015
K	2.92	3.43	0.115	0.135
L	15.24 BSC		0.600 BSC	
M	0°	15°	0°	15°
N	0.51	1.02	0.020	0.040

13.4 28-Pin Small Outline Integrated Circuit Package (Case 751F-04)

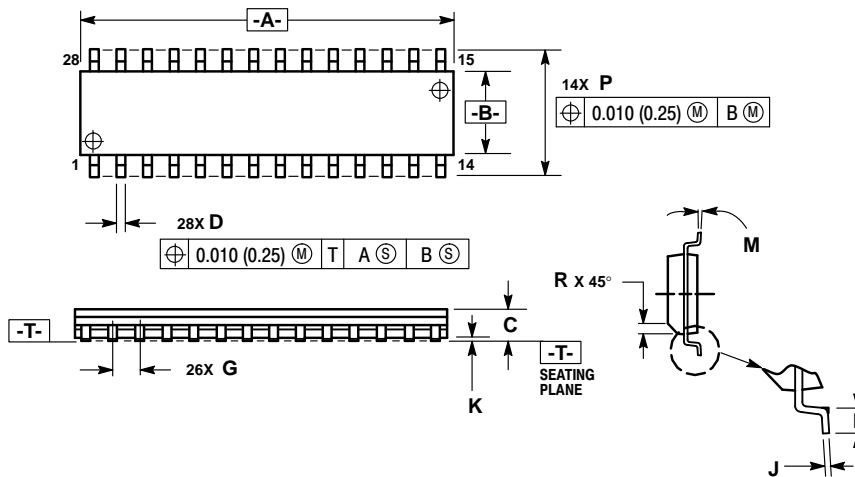

NOTES:

1. DIMENSIONING AND TOLERANCING PER ANSI Y14.5M, 1982.
2. CONTROLLING DIMENSION: MILLIMETER.
3. DIMENSION A AND B DO NOT INCLUDE MOLD PROTRUSION.
4. MAXIMUM MOLD PROTRUSION 0.15 (0.006) PER SIDE.
5. DIMENSION D DOES NOT INCLUDE DAMBAR PROTRUSION. ALLOWABLE DAMBAR PROTRUSION SHALL BE 0.13 (0.005) TOTAL IN EXCESS OF D DIMENSION AT MAXIMUM MATERIAL CONDITION.

DIM	MILLIMETERS		INCHES	
	MIN	MAX	MIN	MAX
A	17.80	18.05	0.701	0.711
B	7.40	7.60	0.292	0.299
C	2.35	2.65	0.093	0.104
D	0.35	0.49	0.014	0.019
F	0.41	0.90	0.016	0.035
G	1.27 BSC		0.050 BSC	
J	0.23	0.32	0.009	0.013
K	0.13	0.29	0.005	0.011
M	0°	8°	0°	8°
P	10.05	10.55	0.395	0.415
R	0.25	0.75	0.010	0.029

13.5 44-Pin Plastic Leaded Chip Carrier Package (Case 777-02)

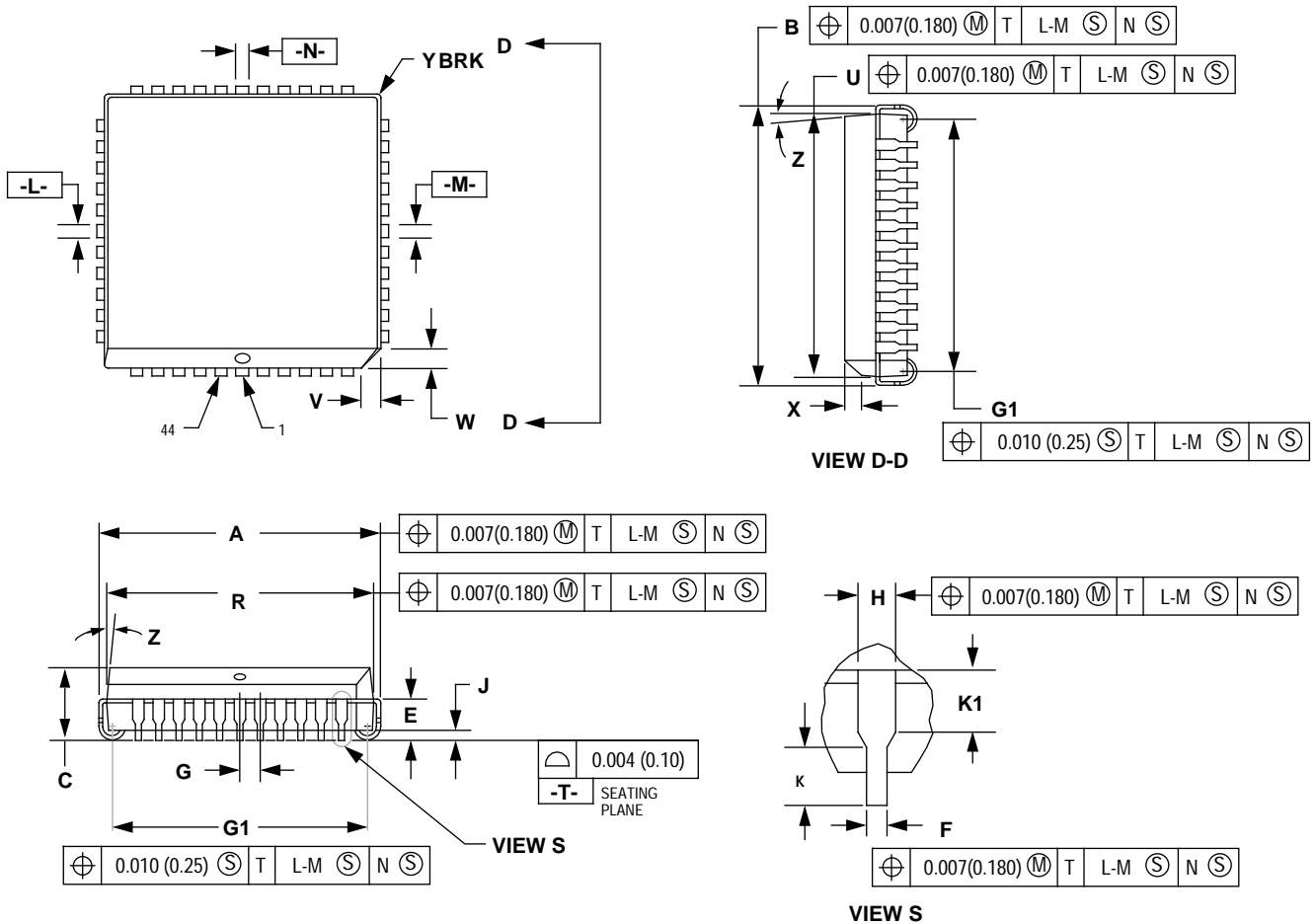

NOTES:

- DATUMS -L-, -M-, AND -N- ARE DETERMINED WHERE TOP OF LEAD SHOULDERS EXITS PLASTIC BODY AT MOLD PARTING LINE.
- DIMENSION G1, TRUE POSITION TO BE MEASURED AT DATUM -T-, SEATING PLANE.
- DIMENSION R AND U DO NOT INCLUDE MOLD FLASH. ALLOWABLE MOLD FLASH IS 0.010 (0.25) PER SIDE.
- DIMENSIONING AND TOLERANCING PER ANSI Y14.5M, 1982.
- CONTROLLING DIMENSION: INCH.
- THE PACKAGE TOP MAY BE SMALLER THAN THE PACKAGE BOTTOM BY UP TO 0.012 (0.300). DIMENSIONS R AND U ARE DETERMINED AT THE OUTERMOST EXTREMES OF THE PLASTIC BODY EXCLUSIVE OF THE MOLD FLASH, THE BAR BURRS, GATE BURRS AND INTERLEAD FLASH, BUT INCLUDING ANY MISMATCH BETWEEN THE TOP AND BOTTOM OF THE PLASTIC BODY.
- DIMENSION H DOES NOT INCLUDE DAMBAR PROTRUSION OR INTRUSION. THE DAMBAR PROTRUSION(S) SHALL NOT CAUSE THE H DIMENSION TO BE GREATER THAN 0.037 (0.940116). THE DAMBAR INTRUSION(S) SHALL NOT CAUSE THE H DIMENSION TO SMALLER THAN 0.025 (0.635).

DIM	INCHES		MILLIMETERS	
	MIN	MAX	MIN	MAX
A	0.685	0.695	17.40	17.65
B	0.685	0.695	17.40	17.65
C	0.165	0.180	4.20	4.57
E	0.090	0.110	2.29	2.79
F	0.013	0.019	0.33	0.48
G	0.050 BSC		1.27 BSC	
H	0.026	0.032	0.66	0.81
J	0.020	—	0.51	—
K	0.025	—	0.64	—
R	0.650	0.656	16.51	16.66
U	0.650	0.656	16.51	16.66
V	0.042	0.048	1.07	1.21
W	0.042	0.048	1.07	1.21
X	0.042	0.056	1.07	1.42
Y	—	0.020	—	0.50
Z	2° 10°		2° 10°	
G1	0.610	0.630	15.50	16.00
K1	0.040	—	1.02	—

Section 14. Ordering Information

14.1 Contents

14.2 Introduction117

14.3 Ordering Information117

14.2 Introduction

This section contains ordering instructions for the MC68HC705RC16.

14.3 Ordering Information

Table 14-1 provides information in determining order numbers.

Table 14-1. MC Order Numbers

Package Type	Operating Temperature Range	MC Order Number
28-Pin Plastic Dual In-Line Package (DIP)	0 to 70 °C	MC68HC705RC16P
28-Pin Small Outline Integrated Circuit Package (SOIC)	0 to 70 °C	MC68HC705RC16DW
44-Lead Plastic Leaded Chip Carrier Package (PLCC)	0 to 70 °C	MC68HC705RC16FN

Freescale Semiconductor, Inc.

Home Page:

www.freescale.com

email:

support@freescale.com

USA/Europe or Locations Not Listed:

Freescale Semiconductor
Technical Information Center, CH370
1300 N. Alma School Road
Chandler, Arizona 85224
(800) 521-6274
480-768-2130

support@freescale.com

Europe, Middle East, and Africa:

Freescale Halbleiter Deutschland GmbH
Technical Information Center
Schatzbogen 7
81829 Muenchen, Germany
+44 1296 380 456 (English)
+46 8 52200080 (English)
+49 89 92103 559 (German)
+33 1 69 35 48 48 (French)
support@freescale.com

Japan:

Freescale Semiconductor Japan Ltd.
Headquarters
ARCO Tower 15F
1-8-1, Shimo-Meguro, Meguro-ku
Tokyo 153-0064, Japan
0120 191014
+81 2666 8080

support.japan@freescale.com

Asia/Pacific:

Freescale Semiconductor Hong Kong Ltd.
Technical Information Center
2 Dai King Street
Tai Po Industrial Estate,
Tai Po, N.T., Hong Kong
+800 2666 8080

support.asia@freescale.com

For Literature Requests Only:

Freescale Semiconductor
Literature Distribution Center
P.O. Box 5405
Denver, Colorado 80217
(800) 441-2447
303-675-2140
Fax: 303-675-2150
LDCForFreescaleSemiconductor@hibbertgroup.com

RoHS-compliant and/or Pb- free versions of Freescale products have the functionality and electrical characteristics of their non-RoHS-compliant and/or non-Pb- free counterparts. For further information, see <http://www.freescale.com> or contact your Freescale sales representative.

For information on Freescale's Environmental Products program, go to <http://www.freescale.com/epp>.

Information in this document is provided solely to enable system and software implementers to use Freescale Semiconductor products. There are no express or implied copyright licenses granted hereunder to design or fabricate any integrated circuits or integrated circuits based on the information in this document. Freescale Semiconductor reserves the right to make changes without further notice to any products herein. Freescale Semiconductor makes no warranty, representation or guarantee regarding the suitability of its products for any particular purpose, nor does Freescale Semiconductor assume any liability arising out of the application or use of any product or circuit, and specifically disclaims any and all liability, including without limitation consequential or incidental damages. "Typical" parameters which may be provided in Freescale Semiconductor data sheets and/or specifications can and do vary in different applications and actual performance may vary over time. All operating parameters, including "Typicals" must be validated for each customer application by customer's technical experts. Freescale Semiconductor does not convey any license under its patent rights nor the rights of others. Freescale Semiconductor products are not designed, intended, or authorized for use as components in systems intended for surgical implant into the body, or other applications intended to support or sustain life, or for any other application in which the failure of the Freescale Semiconductor product could create a situation where personal injury or death may occur. Should Buyer purchase or use Freescale Semiconductor products for any such unintended or unauthorized application, Buyer shall indemnify and hold Freescale Semiconductor and its officers, employees, subsidiaries, affiliates, and distributors harmless against all claims, costs, damages, and expenses, and reasonable attorney fees arising out of, directly or indirectly, any claim of personal injury or death associated with such unintended or unauthorized use, even if such claim alleges that Freescale Semiconductor was negligent regarding the design or manufacture of the part.

