

AD-667-522

ESD-67-412
ESTI FILE COPY

ESD-TR-67-412

MTR-527

APPLICATION OF COST-EFFECTIVENESS ANALYSIS TO
EDP SYSTEM SELECTION

MARCH 1968

J. D. Porter
B. H. Rudwick

Prepared for

EDP EQUIPMENT OFFICE
ELECTRONIC SYSTEMS DIVISION
AIR FORCE SYSTEMS COMMAND
UNITED STATES AIR FORCE
L. G. Hanscom Field, Bedford, Massachusetts

ESD RECORD COPY
RETURN TO
SCIENTIFIC & TECHNICAL INFORMATION DIVISION
(ESTI), BUILDING 1211



ESD ACCESSION LIST

ESTI Call No. 59991
Copy No. 1 of 2 6/9:

This document has been approved for public release and sale; its distribution is unlimited.

Project 8510
Prepared by
THE MITRE CORPORATION
Bedford, Massachusetts
Contract AF19(628)-5165

AD 0667522

When U.S. Government drawings, specifications, or other data are used for any purpose other than a definitely related government procurement operation, the government thereby incurs no responsibility nor any obligation whatsoever; and the fact that the government may have formulated, furnished, or in any way supplied the said drawings, specifications, or other data is not to be regarded by implication or otherwise, as in any manner licensing the holder or any other person or corporation, or conveying any rights or permission to manufacture, use, or sell any patented invention that may in any way be related thereto.

Do not return this copy. Retain or destroy.

APPLICATION OF COST-EFFECTIVENESS ANALYSIS TO
EDP SYSTEM SELECTION

MARCH 1968

J. D. Porter

B. H. Rudwick

Prepared for

EDP EQUIPMENT OFFICE
ELECTRONIC SYSTEMS DIVISION
AIR FORCE SYSTEMS COMMAND
UNITED STATES AIR FORCE
L. G. Hanscom Field, Bedford, Massachusetts



This document has been approved for public
release and sale; its distribution is un-
limited.

Project 8510
Prepared by
THE MITRE CORPORATION
Bedford, Massachusetts
Contract AF19(628)-5165

FOREWORD

The work reported in this document was performed by The MITRE Corporation, Bedford, Massachusetts, for the **EDP Equipment Office**, Electronic Systems Division, of the Air Force **Systems Command** under Contract AF 19(628)-5165.

REVIEW AND APPROVAL

Publication of this technical report does not constitute Air Force approval of the report's findings or conclusions. It is **published only** for the exchange and stimulation of ideas.



S. P. STEFFES
Colonel, USAF
Chief, EDP Equipment Office

ABSTRACT

A conceptual approach for evaluating and selecting among alternative Electronic Data Processing (EDP) systems proposed to meet a set of EDP user needs has been developed by applying cost-effectiveness methods and techniques to the source selection problem. The report provides a framework that allows the EDP system evaluator to combine the selected relevant system performance measures and the related cost elements to arrive at a rational defensible selection decision.

TABLE OF CONTENTS

	<u>Page</u>
LIST OF ILLUSTRATIONS	vii
SECTION I INTRODUCTION	1
SECTION II OVERVIEW OF THE SELECTION PROCESS	3
USER NEEDS	3
PROPOSED SYSTEM	5
MEASUREMENT	5
SELECTION OBJECTIVE	6
UNCERTAINTIES	7
Vendor Uncertainties	7
Coping With Vendor Uncertainties	8
Job Uncertainties	11
Coping With Job Uncertainties	11
SECTION III COST-EFFECTIVENESS ANALYSIS APPROACH	13
DEFINITIONS	13
THE SELECTION PROBLEM	15
PROPOSED SELECTION PROCESS	17
Classification of User Needs	17
The Representative Workload	20
Mandatory Requirements	30
Desirable Features	31
SELECTION APPROACH	43
Determining the Worth of Desirable Features	43
Vendor Submits Proposed Costs	43
Calculating Cost of Representative Workload	45
Validation of Mandatory Requirements	45
Calculating Cost of Additional Job Benefits	45
Calculating Total Expected Cost	46
SECTION IV CONCLUSIONS	47
SYSTEM FEASIBILITY	47
USER IMPLICATIONS	47

TABLE OF CONTENTS (CONCLUDED)

	<u>Page</u>
VENDOR IMPLICATIONS	47
EVALUATION IMPLICATIONS	47
APPROVAL AUTHORITY IMPLICATIONS	48
ADDITIONAL REMARKS	48
APPLICABILITY TO OTHER SOURCE SELECTIONS	48
REFERENCES	50

LIST OF ILLUSTRATIONS

<u>Figure Number</u>		<u>Page</u>
1	Overview Of The Selection Process	4
2	Cost-Effectiveness Definitions	14
3	Cost-Effectiveness Analysis	16
4	Proposed Selection Process	19
5	Probabilistic Workload Description For A Given Time	22
6a	Probabilistic Workload Description Smoothed Over Time	24
6b	Probabilistic Workload Description Averaged Per Year	24
7	Vendor Response To Perform Representative Workload	26
8	Probabilistic Workload Showing Linear Interpolation	29
9	The Problem Of Evaluating Desirable Features	32
10	Desirable Features Alternatives	35
11	Selection Of Least Cost Alternative	36
12	Software Feature Evaluation Function	41
13	Evaluator's Worksheet	44

SECTION I

INTRODUCTION

The purpose of this technical report is to document a conceptual approach for evaluating and selecting among alternative, proposed Electronic Data Processing (EDP) systems designed to meet a set of EDP user needs. The proposed approach was developed by applying cost-effectiveness methods and techniques to the source selection problem. This work was accomplished under Project 8510.

The selection of EDP systems has presented a problem to the decision-maker for many years since competition became established in the production of computing equipment. The development of computers has been characterized by a diversity of approaches, designs, and configurations.

Solutions to this problem have been varied and cover a wide spectrum all the way from essentially ignoring the technical differences to the carrying out of detailed studies utilizing sophisticated tools.

This problem is not limited only to the EDP user. The manufacturers themselves must make design decisions involving a trade-off between the cost of the equipment and its performance. For a particular user the problem is basically simpler since he can confine his evaluation to how the EDP equipment proposed by the vendor satisfies his particular requirements.

A significant amount of attention has been devoted in the computer literature to the definition of measures of system performance and effectiveness. [1-16] These definitions have become further complicated with the availability of large-scale multiple-access computer systems. In this paper, it is sufficient for us to assume that the user has determined his system requirements together with the associated system constraints. It is hoped that this paper will provide a framework to allow the EDP system evaluator to combine the selected relevant system performance measures and the related cost elements to arrive at a rational defensible selection decision.

The approach adopted for selection itself must represent a trade-off between effort (time and resources) applied and credibility achieved. There are some analysts who feel that throwing a multi-sided die may be sufficient to select among qualified vendors. Such a process certainly reduces the expenditure of selection resources, but unfortunately it suffers in the areas of repeatability, defendability, credibility, and

acceptance by the competing vendors and the selection authority who is responsible for the final decision.

A number of EDP equipment selection procedures have been described in the literature [17-25] and a far greater number have undoubtedly been used but not formally reported. None of the reported procedures have, in the opinion of the authors of this report, satisfactorily handled the problem of combining performance and cost. In the last analysis, all methods must make use of an explicit determination of the worth* to the user of the variety of features proposed by the competing vendors. Such methods depend heavily upon intuitive judgment. It is the identification of these judgment areas and the degree to which they can be rendered explicit and defensible that contribute to the "success" of a particular selection process.

In this report we have attempted to apply cost-effectiveness analysis techniques to the problem of EDP equipment selection. The term cost-effectiveness has been much maligned in the literature and in certain political circles in the past few months. It is not our purpose to enter into the socio-political aspects of these techniques, but rather to apply, to the problem of EDP system selection, methods and techniques which have proven superior in the concept formulation and systems planning phase of the systems acquisition process.

It should also be pointed out that the cost-effectiveness analysis techniques developed in this report specifically for application to EDP system selection are also applicable to the source selection process in other system areas.

* A more detailed discussion of worth will be presented later in the report, in Section III.

SECTION II

OVERVIEW OF THE SELECTION PROCESS

In general, the evaluation and selection process involves three main components as indicated in Figure 1:

1. Statement of User Needs
2. Submission of Vendor Proposed System
3. Measurement or Comparison of the Proposal Against the Stated User Needs

Each of these parts will be discussed in more detail and various terms will be defined for later reference.

USER NEEDS

The first task to be performed is to determine and make explicit an approved set of user needs which will form the basis of the Request For Proposal (RFP) and the evaluation and selection procedure. For an EDP system, the user needs can be expressed mainly by the description of the future workload which the user feels he will have to process during the operational life of the EDP system. The main difficulty in expressing these needs is that while the user may be able to express accurately his current workload, he is never really sure about the future workload. It is very difficult for the user to predict what he may be asked to process as much as five or more years after the RFP has been issued.

While user needs are expressed mainly in terms of EDP jobs, there are other needs or constraints which relate to the EDP system's ability to perform these jobs. One such constraint is the maximum time allowed to perform any one job or a total set of jobs. For example, the user may feel that:

- (a) he needs a two-second response time for some task;
- (b) some set of jobs must be completed during an eight-hour first shift operation;
- (c) the monthly workload must be completed in less than, say, 600 hours;
- (d) the system must be delivered within 90 days after contract award.

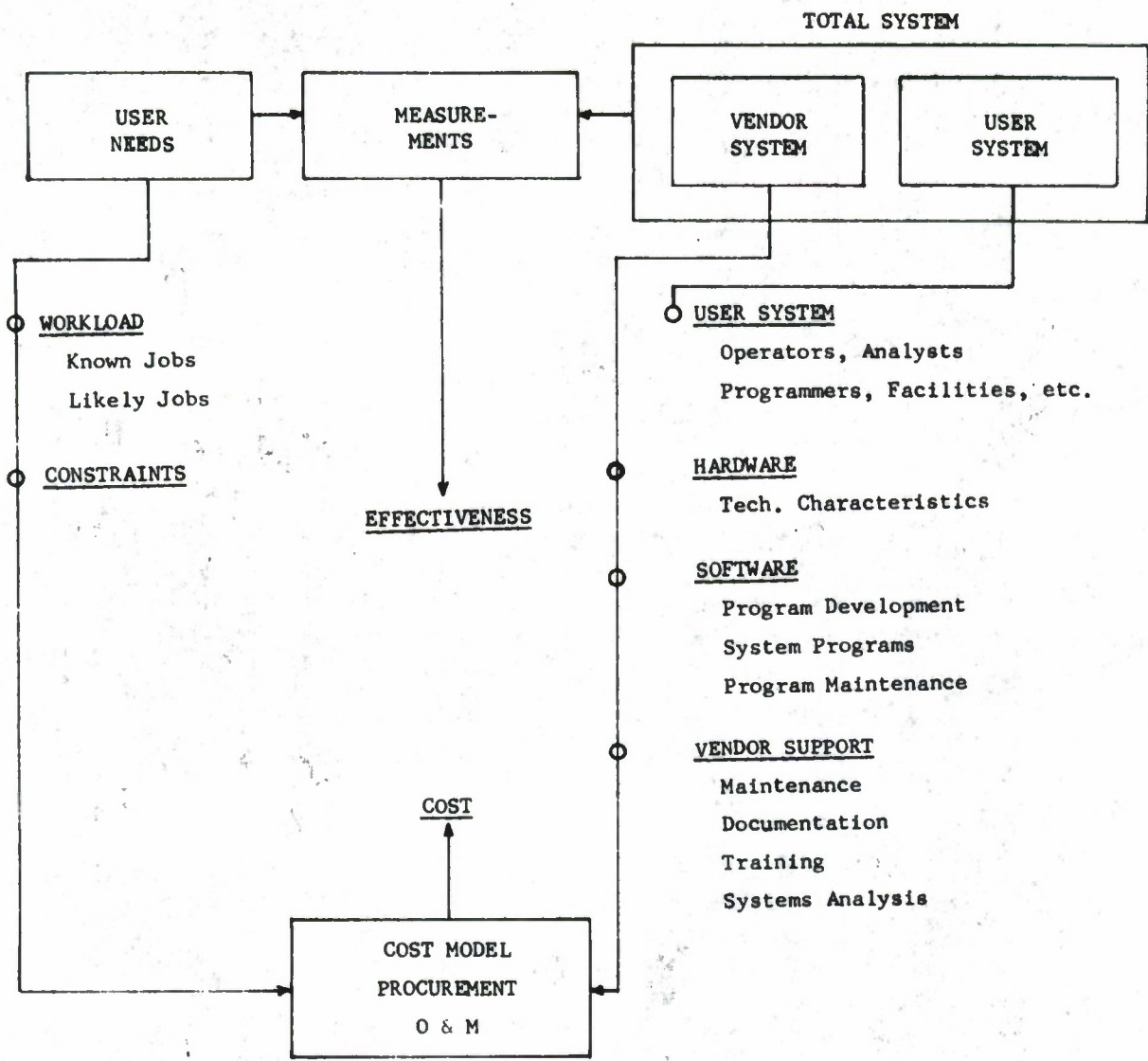

Figure 1. Overview Of The Selection Process

It is important to realize that some of these constraints may be quite firm to the user; others may be "open-ended", i.e. are really "desires". Several factors complicate the problem of clearly stating user needs. These factors are:

- (a) the uncertainty of the future workload;
- (b) the lack of a cost limitation recognized by the user (his main pressure may be to satisfy the future workload he feels he will be called upon to meet independently of cost);
- (c) the lack of cost-sensitivity information regarding what it costs to meet different combinations of user needs.

Because of these difficulties, some compromises must be made between the user and the external agencies in the procurement chain, such as AFADA and ESQ, to arrive at an approved set of user needs which will be used as the basis of the Source Selection Plan.

PROPOSED SYSTEM

Upon receipt of the RFP the vendor performs various cost-performance trade-offs to configure an EDP system which in the vendor's opinion will "best" meet the stated user needs.

This Vendor System consists of:

- (a) hardware having stated technical characteristics;
- (b) software including the various programs required to support operating systems, compilers, etc.; and
- (c) vendor support including required maintenance, documentation, training of user staff, and systems analysis.

However, there are other parts of the Total System which the user must provide to make the system function. This User System includes the user's operators, analysts, programmers and facilities.

MEASUREMENT

The Total System as proposed by each vendor must be compared against the stated user needs, and the winning vendor selected according to specified criteria. There are two parts to such an evaluation:

1. A system performance evaluation which determines the effectiveness of the system. Here effectiveness is defined* as the degree to which the system will meet the future workload and satisfy the constraints.
2. A cost evaluation which determines the total cost for procurement, operations and maintenance in performing the future workload over the total required operating life of the system.

Implicit in the evaluation is the need to validate the vendor's proposal. It should be stated that this requirement is common to all evaluation procedures and, from a technical point of view, may represent the most time-consuming part of the evaluation. This area will be discussed in more detail below under the subject of Vendor Uncertainties.

SELECTION OBJECTIVE

To compare alternative selection procedures, an explicit definition of the selection objective is required. The objective selected is as follows:

"To select a proposed EDP System which performs a set of future EDP jobs and meets the job constraints at the Lowest Total Cost to the Air Force, taking into account Job Uncertainties and Vendor Uncertainties."

This objective includes the following three major concepts:

1. All vendors must show that their proposed systems can perform the future EDP jobs and meet the job constraints.
2. Lowest total cost to the Air Force should be the selection criterion.
3. Vendor and job uncertainties are the key factors which make the evaluation selection process a difficult one. Hence let us now discuss the various aspects of these uncertainties.

* This term will be discussed in greater detail in Section III.

UNCERTAINTIES

As discussed above, the selection process is complicated by two classes of uncertainties - vendor uncertainties and job uncertainties. Each of these classes will now be discussed in greater detail.

Vendor Uncertainties

The proposal submitted by the vendor, in addition to cost and contractual-type information, will include the following technical information.

Technical Characteristics

These are the specifications of the components of the proposed computer configuration together with detailed information about the performance of each (e.g. speed, capacity, etc.). Assuming that the equipment will be delivered on time, one can question whether each component will perform at the levels claimed.

Software

In response to the RFP, the vendor will describe those software packages that he will make available with his equipment. Again, assuming that the packages will be available when needed, one can question what elements and functions are provided, how well each is implemented, and how well each may be used.

System Performance

Not only must the elements of hardware and software be considered individually, but their interrelationships must also be considered in determining their effects on system performance. For example, a card reader or a printer may not be able to run at rated speeds because of other system requirements, or a software package may degrade system performance because it produces inefficient code, because it may constrain an operating program by reducing the amount of storage space available, or because it is not suitably matched to the available hardware.

Support

As mentioned above, one must always be concerned with the ability of the vendor to deliver his equipment and associated software as scheduled. This is just one example of a number of vendor-dependent activities that can be grouped together under the

heading of vendor support. For example, the reliability of the vendor-supplied equipment and programs can very strongly affect estimates of system timing. Also, the user's ability to operate the vendor's equipment will depend on the documentation available and on the professional capability of the analysts and support personnel provided by the vendor. Finally, it must be realized that both equipment and software must be maintained. The vendor's ability to do this efficiently and systematically will also influence the user's ability to attain predicted system performance.

Coping With Vendor Uncertainties

A number of techniques have been developed for dealing with vendor uncertainties. Basically the requirement that the vendor supply off-the-shelf equipment and undergo a live-test demonstration removes a large part of the risk associated with making state-of-the-art systems operational. Of course, this procedure has a compensating drawback in that it may prevent the user from acquiring newly developed systems.

The available techniques may be categorized into three major areas:

Professional Personnel

The basic ingredient for any evaluation is the availability of competent professional personnel. Such personnel must be carefully trained to stay abreast with the state-of-the-art not just in the equipment alone, but also in the way this equipment may be used such as through time-sharing or in computer complexes. The ability of these people to interpret and assess vendor claims will be further enhanced through experience. In particular by working with vendors, a better understanding can be acquired of the features of the vendor's equipment and staff as well as of the marketing strategies employed by the various vendors. In addition, through contact with various Air Force user installations, a better understanding can be acquired of the user needs and problems against which the vendor proposals must be assessed.

Tools

The problem of validating vendor proposals can be greatly facilitated by having the proper set of tools. Within the inventory of applicable tools, one can identify the following categories:

(1) Simulation Programs.^[26,27] Basically it is desirable to have a program that can take as input a description of the job to be performed together with the specifications of the equipment proposed. The output of the program would be an analysis of system performance (e.g. overall problem timing, buffered times, component times, storage requirements, etc.). Such a program can serve as a check on the vendor's logic, analysis, and calculations. By incorporating into the program an independently derived data base for the equipment specifications, such a program provides a check on the vendor's data accuracy. Simulation techniques are being extended to evaluate some of the dynamic aspects of multiprogramming/multiprocessing systems.

(2) Benchmark Programs. The most satisfactory way to validate a vendor proposal is to run an actual live test. Because of the time and cost involved in testing the whole job, one is led to make use of a program or set of programs that are representative of the job to be performed and constitute a predetermined fraction of the total job. Such programs can be selected to test the performance of individual computer components as well as to measure, through suitable extension factors, the overall system performance. Even though it is difficult to design such benchmark programs to test all of the significant aspects of the vendor's proposal, nevertheless the use of such programs tends to restrain the vendor and to encourage his use of more defensible estimates. In general, the benchmark programs are selected as portions of the actual expected workload, but programs already developed for other jobs or artificially designed can be used provided they are suitably representative and can be extrapolated to give the information desired.

(3) Software Test Programs. An important class of benchmark programs is one especially designed for testing software. Here it is more efficient to design programs to test specific elements or combinations of elements of the software package. However, a job-oriented program may still be useful to test such features as compiler efficiency. There is a modest amount of cooperative effort being expended under the direction of USASI (U.S.A. Standards Institute) to develop such compliance test programs for COBOL.

(4) EDP Data Base. Information concerning the availability and performance of EDP equipment can be organized into a data base to facilitate the validation of vendor proposals. Not only does this provide a reservoir of information to check figures against, but it also serves as a repository for cataloguing acquired experience with vendor equipment and claims. As time allows, one can envisage a sort of "Good Housekeeping" approach to test the performance of

computer components and software packages with the test results being incorporated into the data base.

(5) Analysis/Synthesis. In support of any validation procedure, there must exist a basic understanding of the performance of the individual computer components and the interrelations that govern how these components work together as part of the overall computer system. For example, the performance of the CPU, storage devices, I/O devices, data channels, file structures, scheduling disciplines, etc., must be analyzed in order to predict the overall system performance or to determine those elements that may be critical to that performance. Such prediction and estimation must take into consideration dynamic conditions that characterize the on-line use of computers today.

Systematic Procedures

Because of the large number of parameters that contribute to the overall complexity of validating vendor proposals, systematic procedures must be established to provide an orderly context for assessing the vendor's proposal. Given a competent, professional staff with an appropriate set of tools, it is still necessary to establish an unambiguous set of procedures to assure that the vendor understands the user's requirements, and that the evaluators understand each vendor's proposal. The user's requirements can be formalized into a set of system specifications which can be translated with the cooperation of the evaluation team into the Request For Proposal (RFP) that is transmitted to the vendor. By carefully establishing the format and contents of the RFP, the vendor will know what to expect and what to look for in the RFP. By establishing lines of communication between the vendor and the user/evaluation team, the vendor can inform the team of critical areas in his proposal and can receive clarification of any questions on the RFP that may arise. By following systematic procedures, one can assure that relevant information is equitably disseminated to all competing vendors. Records can be maintained to determine what information was exchanged in case of misunderstandings that may later arise. By applying established validation procedures and evaluation techniques, one can increase the probability that the vendors will accept the results of the validation and evaluation exercises. In addition, as new techniques or improvements are developed, they can be more readily incorporated into the established procedures. Finally, by having an established chain of approvals for the selection plan and decisions, one has available a set of checks and balances that will assure the vendor of equitable treatment and avoid the aura of mistrust which might otherwise becloud the vendor/evaluator relationship.

Job Uncertainties

As was discussed above in Section II, a number of factors contribute to the difficulty of explicitly stating the user's needs. For example, given that the user will be asked to perform a certain job in the future, a number of aspects of that job may change in the future and be difficult to predict at the present time. The size of the job may vary due to changes in the lengths of the files to be processed (e.g. the number of fields in a record or the number of records might change). The frequency of running certain jobs may be difficult to predict and consequently the total time demanded for that job becomes uncertain. Complexity of jobs may increase through the incorporation of additional processing steps into the job as experience and requirements evolve, or through the introduction of more refined or sophisticated methodology. Finally, the set of jobs to be performed may change by the addition or substitution of new jobs that were not anticipated when the user originally specified his needs.

The level of credibility of the user's predictions of future workload can be raised by applying more time and resources to the analysis of the user's requirements. For example, if a particular selection involved a specified, approved workload to the exclusion of unanticipated future jobs, then through the use of detailed systems analysis and extensive system simulation, one could very accurately establish the characteristics of even a complex workload. However, in most cases there is insufficient time or manpower or budget to permit the extensive analysis required for accurate workload prediction. In addition, user jobs do change over time to a degree which may be difficult to predict.

Coping With Job Uncertainties

Recognizing that the future workload cannot be considered fixed and completely specified, evaluators have devised a number of techniques to cope with these uncertainties. The most commonly adopted method makes use of a "point-scoring" procedure that establishes a hierarchy of factors or criteria together with appropriate formulas and weights. [23,28] Points are then allocated in accordance with how well each vendor has scored on the various factors and upon the relative weights allocated by the evaluation team to these factors. The vendor with the largest total score is then adjudged to be the winner. A detailed presentation of such a procedure for selecting among alternatives has been carried out by Dr. James R. Miller. [29]

The remainder of this report will be concerned with the application of cost-effectiveness analysis techniques to the problem of EDP equipment selection. It is felt that the adoption of a cost-effectiveness approach provides a more rational and equitable basis for comparing competing vendor proposals and for coping with the uncertain workload. Further remarks on the advantages of the cost-effectiveness approach will be made in Section IV.

SECTION III

COST-EFFECTIVENESS ANALYSIS APPROACH

With the previous statement of the problem and the various evaluation difficulties as background, we shall now discuss the approach taken in applying conventional cost-effectiveness analysis to this problem of computer evaluation and selection.

DEFINITIONS

Let us start the discussion by defining various terms which will be applied in the analysis:*

1. Effectiveness: The degree to which a system will perform the future jobs and satisfy the constraints. Effectiveness is generally considered to consist of the following three main components as illustrated in Figure 2:

a. Capability: The degree to which a system will perform the future jobs and satisfy the constraints, assuming that the system is always available for operation and will never malfunction. Capability can be measured in various ways, but the two key measures of capability are:

- (1) Quality of the work output. This measure is in general multi-dimensional since it encompasses the many sub-measures used to measure the work output. For example, it might include the straightness of a line of print or the maximum number of copies of printout.
- (2) Time. Given that the quality of the work output can be measured, a second key measure of the EDP system capability is the time taken to perform the future workload, again assuming the system is available for operation and never malfunctions. For example, the measure could be the expected time to perform a given monthly workload.

* These concepts are an application of those used in the evaluation of weapon systems. Reference is made to such reports as "Weapon System Effectiveness Industry Advisory Committee (WSEIAC), Final Summary Report, AFSC-TR-65-6, January 1965.

EFFECTIVENESS

1. CAPABILITY TO PERFORM JOBS & SATISFY CONSTRAINTS } → { TIME
QUALITY

2. AVAILABILITY } → NON-PRODUCTIVE TIME
DOWN TIME (SCHEDULED/UNSCHEDULED)
3. DEPENDABILITY } → LOST TIME (DUE TO ERRORS)

COST

TOTAL DOLLARS REQUIRED TO PERFORM THE FUTURE SET OF EDP JOBS

Figure 2. Cost-Effectiveness Definitions

b. Availability may be defined as the probability that the system will be ready for operation when called upon.

c. Dependability may be defined as the probability of the system completing the job satisfactorily, given that it was available.

However, when evaluating EDP systems in which the primary measure of capability is the expected time to perform a given workload (given that the quality of the system meets a certain level of acceptability), both availability and dependability can correspondingly be measured in units of non-productive time expected during the performance of a given (monthly) workload. This non-productive time consists of two sources:

- (1) Down time: both scheduled maintenance to prevent malfunctions and unscheduled maintenance to detect and correct malfunction.
- (2) Lost time: non-productive run time requiring rerun because of suspected or detected errors.

Availability also includes how well the vendors can meet the desired delivery date, since this has an impact on the non-productive time of the system.

2. Cost: The total dollars required to procure, operate, and maintain the system to perform the future set of EDP jobs. As indicated previously in Figure 1, all costs are to be included in making this computation for both the vendor and the user.*

THE SELECTION PROBLEM

Given that the effectiveness and cost of a particular system can each be measured separately, the evaluation team will still be faced with the problem of how to combine these two factors to reach a final selection. For example, as illustrated in Figure 3, we might have a situation where System B provides a higher level of effectiveness than System A but costs more.** The source selection problem is, "Which is the better system to buy?" This could be restated as,

* In some cases certain non-differentiating costs may be omitted.

** Note that the decision is straightforward if we have a "dominant" case where one system provides more effectiveness at a lower cost.

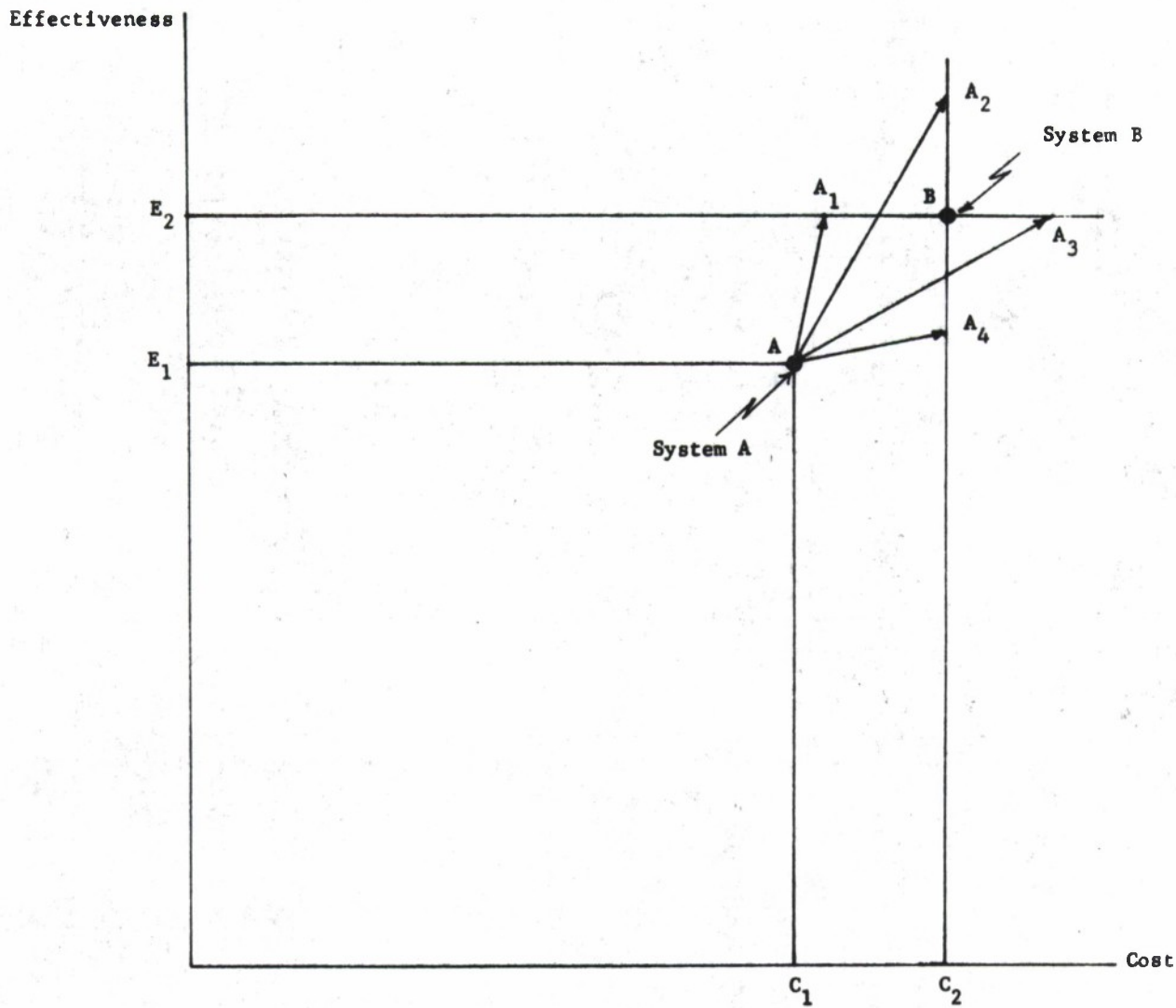

Figure 3. Cost-Effectiveness Analysis

"Is the additional amount of effectiveness worth the added amount of cost?" It is impossible to answer this question, except on a purely intuitive basis (which may be wrong or difficult to defend), without resorting to either of the two source selection criteria used in a cost-effectiveness analysis:[31]

1. Specify a level of effectiveness which all systems must meet, and select that system which meets this level at lowest total cost. This criterion is called "Pivoting on Constant Effectiveness". Thus, if E_2 is chosen as the comparison level of effectiveness and the effectiveness of System A is increased accordingly, its new "Operating Point" on Figure 3 might be either at A_1 (lower cost than B and hence selected), or A_3 (higher cost than B and hence rejected).
2. Specify a level of cost which all systems must not exceed, and select that system which provides the highest level of effectiveness. This is called "Pivoting on Constant Cost". Thus, if C_2 is chosen as the comparison level of cost, and the cost of System A is increased accordingly, its new "operating point" on Figure 3 might be either at A_2 (higher effectiveness than B and hence selected) or A_4 (lower effectiveness than B and hence rejected).

The first selection criterion will be used for illustration for the remainder of this report, since, in general, government procurement uses this criterion.

PROPOSED SELECTION PROCESS

We shall now discuss in greater detail the three categories which we have used to describe user needs, a method for quantitatively communicating these needs to the vendors, and a procedure for evaluating how well each vendor's proposed system meets each of these three categories of needs.

Classification of User Needs

Taking into account the many jobs which could make up a future workload and the various uncertainties associated with each job and with the vendors' proposals, efforts were made to apply cost-effectiveness analysis methods and techniques to the source selection process of Figure 1. The analytical approach used was

concentrated on making explicit all of the characteristics of the possible jobs and on quantifying the uncertainties associated with each job.

It soon became apparent that this might not be practical to do on every source selection since some might require an excessive expenditure of time and user/analyst manpower. Hence it was decided to restructure the user needs portion of the selection process as shown in Figure 4. User needs can be considered to be made up of three primary parts. The first part describes the representative workload. The second and third parts which were formerly encompassed by the term "Constraints" will be more explicitly defined as mandatory requirements and desirable features.

a. Representative Workload

Out of the many jobs which the user predicts may make up the future workload, only the most important or a selected subset would be used to represent this future workload by adjusting job types and their frequencies of operation. Jobs again consist of "Known Jobs", for which the user has a high degree of confidence in their occurring and in their characteristics, such as size and frequency of operation, and "Likely Jobs", for which the degree of confidence is lower. An analytical technique for expressing this uncertainty by making use of quantitative probabilistic estimates will be described in Section III.

b. Mandatory Requirements

These are absolute requirements which must be met if a system is to be considered for further evaluation. A system that does not satisfy one or more of these requirements is considered non-responsive and is essentially disqualified. Since this is such a strong constraint, every effort will be made to keep these requirements to a minimum.

c. Desirable Features

This third category is required to express user needs because of the following reasons:

(1) As indicated previously, the representative workload only approximates the actual expected workload. Since there may be other requirements of the workload that will not be measured in the system timing determination, inclusion of selected desirable features allows the user to account for the additional capability provided by these features to satisfy the above additional requirements. In a sense,

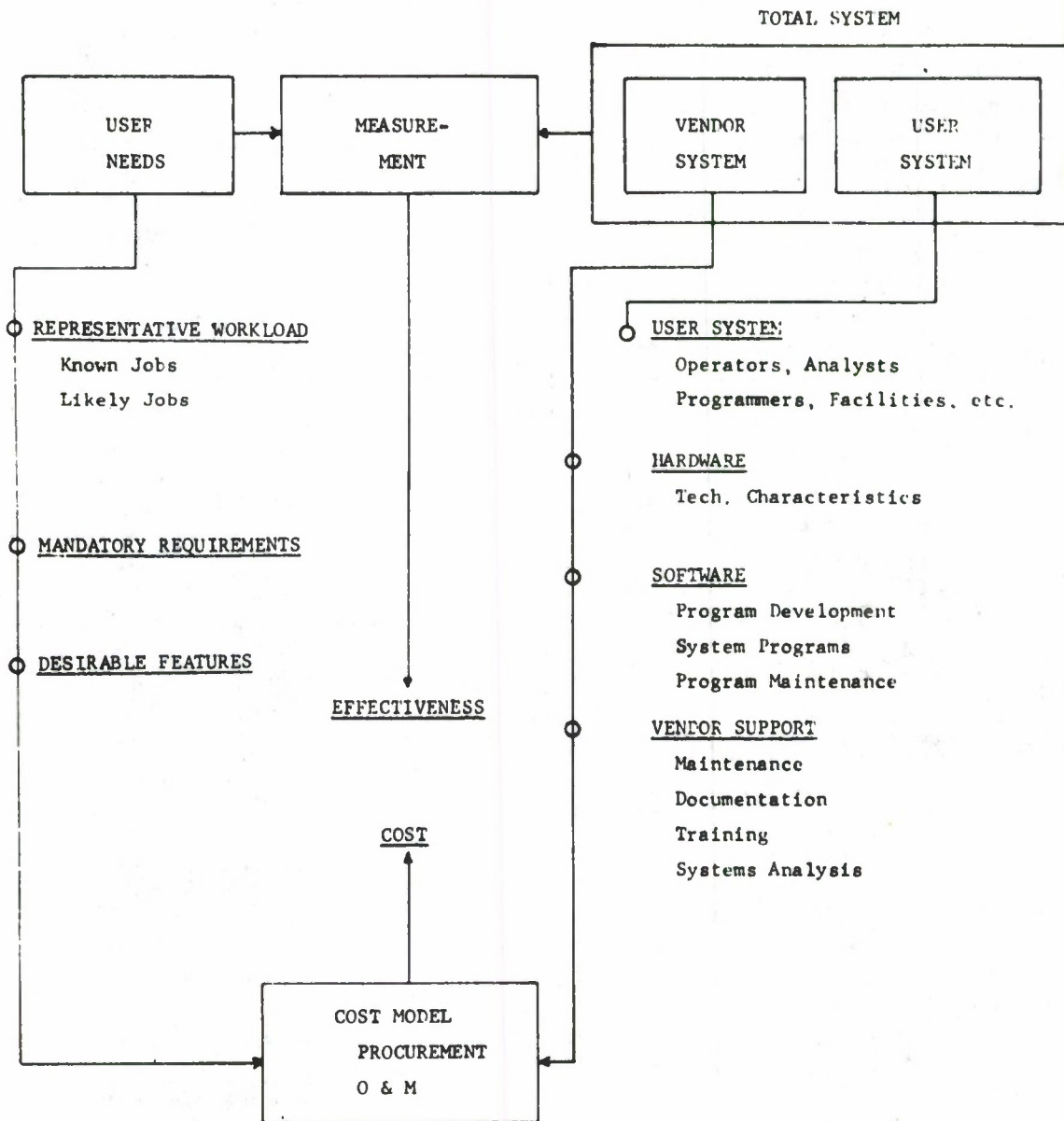

Figure 4. Proposed Selection Process

these features offer the user a "hedge" against uncertainty in his statement of the expected workload.

(2) Since all measurement techniques have some uncertainty connected with them, the inclusion of a list of desirable features also serves as a hedge against this uncertainty in measuring a vendor's ability to meet the future workload.

(3) Many times a user need which is called "mandatory" is really only a "desire". For example, is a two-second response time for a task absolutely mandatory, or would 2.1 seconds be permissible for a system which is 20% less expensive? It is better to list non-discriminatory "design goals" to the vendor in this category rather than in mandatory requirements, since elimination of a vendor for slight non-responsiveness (at large decreases in cost) may not really be defensible.

(4) As long as the production of computing equipment continues to be competitive with the introduction by different vendors of improved design features, the user is forced to consider the benefits to be obtained from these features. If the availability of these features will be of benefit to the user and if those benefits are not adequately incorporated in the system timing determination, some means should be provided in the selection process to account for them.

The Representative Workload

a. Description

We shall now discuss a method for explicitly describing the representative workload. This description will be used by the vendors in preparing their system proposals and will be used as a basis for evaluating the performance of each vendor.

In explicitly describing the representative workload, the analyst must deal with the uncertainties that may exist for each point of time in the future. This can be treated as two basic problems: first, there is the estimation of the user's workload for a particular future time including a quantification of the uncertainties in this workload expressed in probabilistic form; secondly, there is the estimation of how the workload may change with time in the future which may be based on extrapolations of current and past workload data.

(1) Probabilistic Workload Description. To express this uncertainty analytically, the user is asked to define for a given point in time a reference workload and to provide a quantitative estimate of

the probability P that the actual workload occurring at this time may exceed the specified reference. This can be expressed by selecting certain multiples of the reference workload and having the user specify the probability that the actual workload at the selected time will be equal to or exceed each multiple of the reference workload. For example, in Figure 5 the user has stated that for a particular time there is a probability P_1 equal to 1.0 that the future workload will exceed the reference workload, and a probability P_2 equal to 0.80 that it will exceed 1.1 times the reference workload, etc. Several comments can be made about such an estimate:

- (a) These are the user's subjective estimates and will have to be justified to higher level authorities such as AFADA and Hq. USAF.
- (b) While theoretically there may be some small probability that the actual workload will exceed the upper bound shown, e.g. 2.0 times the reference workload, the probability can be taken as zero if it can be mutually agreed that this will be taken as the practical upper design limit for the EDP system.
- (c) While we have described a situation where a workload may vary in size, it may also vary in complexity or in any fashion which the user chooses to make explicit and include in his estimate. The probabilistic description presented above can be used for each element of such a workload specification. The workload discussed below will consist, where appropriate, of combinations of such elements.
- (d) The units for expressing workload will depend upon the particular situation in question. In general, some common measure such as equivalent machine time will be used.
- (e) Since the user has provided the analyst in the example illustrated in Figure 5 with four estimates of workload levels, the entire workload range may be divided into four segments of interest (viz. S_1, S_2, S_3, S_4) as shown in the figure. To obtain estimates for intermediate workload levels, the original four estimates have been connected by straight lines. If greater estimation accuracy is desired, additional estimates would have to be provided by the user.

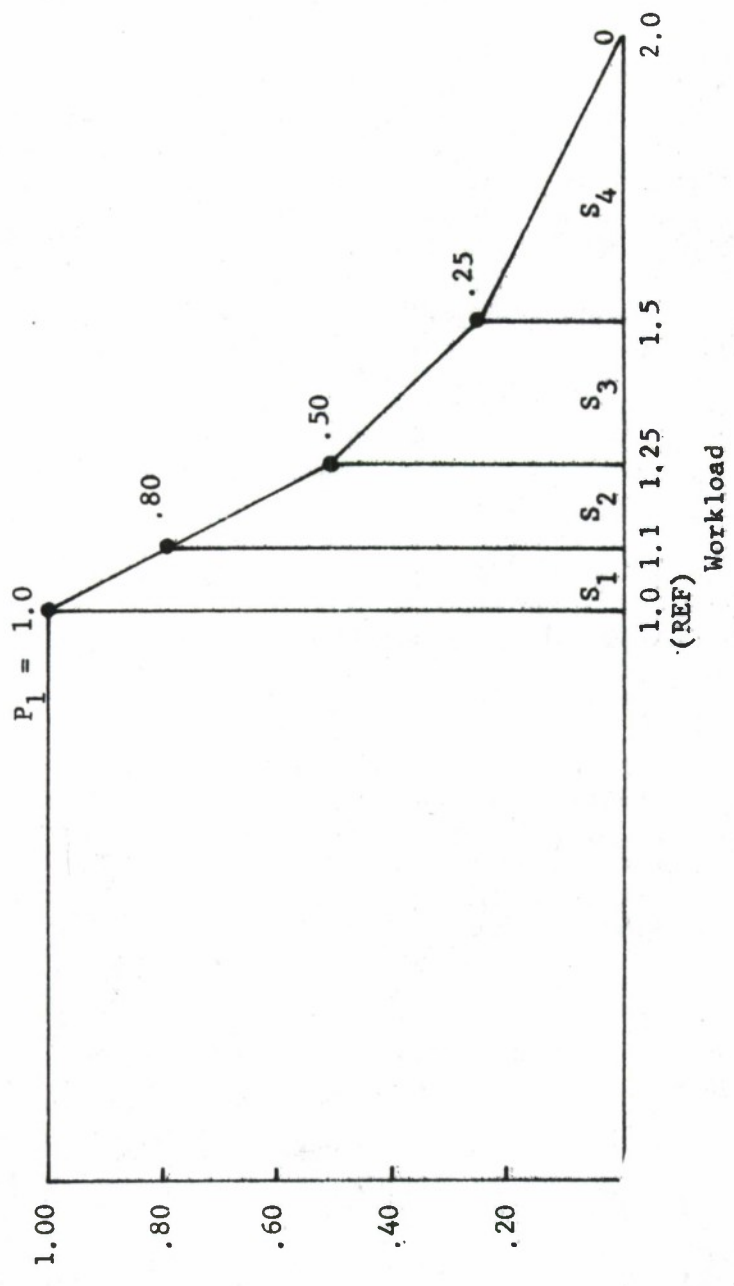

Figure 5. Probabilistic Workload Description For A Given Time

Probability
that
 $WL_F \geq WL$

(2) Workload Growth With Time. As indicated previously, workloads change and generally grow with time. Hence a probabilistic estimate of the representative workload is needed for various periods of time. The summation of this data may be structured as a function of operational year as shown in Figure 6a. In the example shown, a total operational life of five years and a linear growth of workload with time are assumed. Obviously, this linear workload over time is only an approximation to the real situation expected which may vary irregularly due to seasonal or irregular demands. However, even this approximation to the actual demand function can serve as a design guide and evaluation measure.

In Figure 6a, each workload line has been assigned a probability level corresponding to the levels selected in Figure 5. For example, the lowest line in Figure 6a represents a workload as a function of time which the user has indicated has a 100% probability of being experienced or exceeded. In other words, the user has specified that he is completely certain that his workload will be at least as great as the amount shown by this lowest line.

The lowest line in Figure 6a has also been labeled as the "Reference Workload". The specification by the user of his reference workload is independent of the probability level he attaches to that level. In other words, the user will first specify his reference workload by whatever predictive tools he has available. Then, through an independent operation, he will assign a probabilistic level to that workload.

An even coarser approximation to the actual workload is shown in probabilistic form in Figure 6b. Here the average workload for the year is used for each entire year, so that the workload increases in discrete amounts. As will be seen later, such an approximation simplifies the calculations.

b. Calculation of Total Expected System Cost

By constructing an explicit demand function, i.e. the probabilistic workload, the user has stated the range of possible workloads for which he is concerned. Every vendor must show, by various means open to him, that his EDP system can meet any workload up to the indicated maximum which the user may require. These means may include equipment expansion or replacement at a later time. It may also include the use of service bureau leasing or satellite operation if this is acceptable to the user.

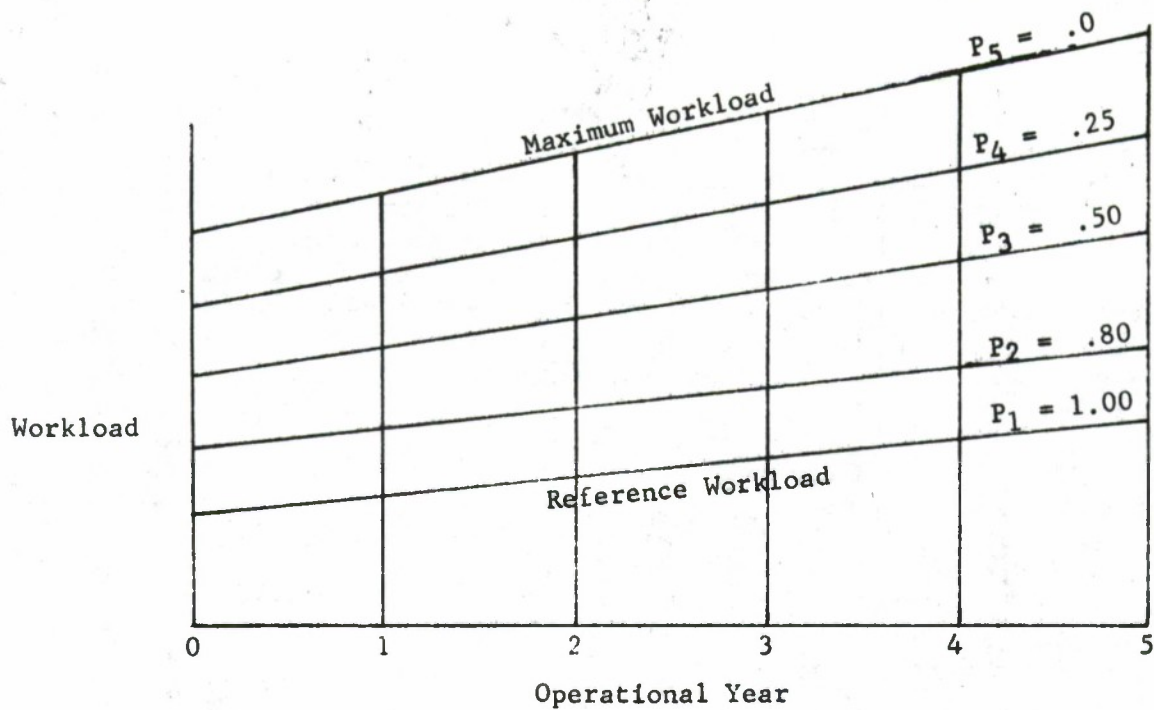

Figure 6a. Probabilistic Workload Description Smoothed Over Time

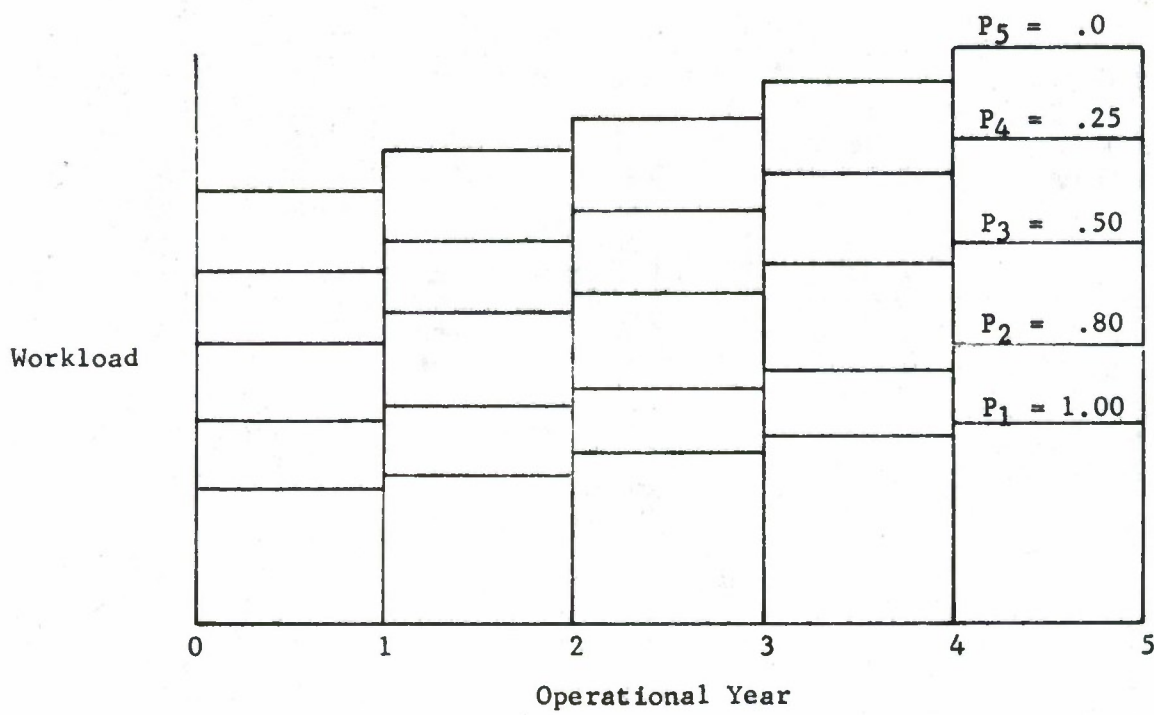

Figure 6b. Probabilistic Workload Description Averaged Per Year

Since the vendor will be provided with the user's estimates of the predicted workload, he may now perform various cost-performance trade-off analyses resulting in a proposal of an initial system installation together with system growth when and if the actual workload reaches certain levels. The vendor costs for the proposed initial system and its growth will also be provided in the proposal.

Based on this information, the expected total cost of meeting the probabilistic workload can be calculated. The example shown in Figure 7 illustrates the hypothetical response of Vendor A to the workload described in Figures 5 and 6. This vendor has proposed to install initially a system A_1 which can perform the workload for the first two years of operation within a stated mandatory requirement of less than 600 hours (allowing the remaining time for scheduled and unscheduled maintenance as well as any necessary reruns of errors). However, during subsequent years, the probable increase in workload may exceed the 600 hours available on system A_1 . In fact, based on the stated workload, there is a 100% chance that this will occur in year 5, if it did not occur sooner. To cope with this increase, the vendor has proposed that his initial system A_1 be altered through addition or replacement to a new system, called system A_2 , which can perform the increased workload within the 600 hour limitation and which will be available when the user so directs. The validated timings for each system to perform the different workload levels are shown in Figure 7. The vendor also provides cost information indicating his proposed costs for all elements of each system, i.e. A_1 and A_2 , as a function of system running time. Such cost information would include shift costs if relevant as well as lease vs. buy information.

To these costs which the vendor would provide, the cost analyst would add the costs which the user would incur in operating the system over the total operational life. Based on this total cost data, the total expected cost \bar{C} for operating each vendor's proposed system can be calculated for each year from the formula

$$\bar{C} = p_1 C_1 + p_2 C_2 + \dots + p_n C_n \quad (1)$$

where p_i is the probability that the actual workload will be contained in the segment S_i and incur a total cost C_i , and n is the total number of segments used to represent the workload range for that year. These segments can be determined by the analyst based on the user's description of his workload.

In the example we have selected, the probability that the actual workload will fall within any one segment S_i is found simply

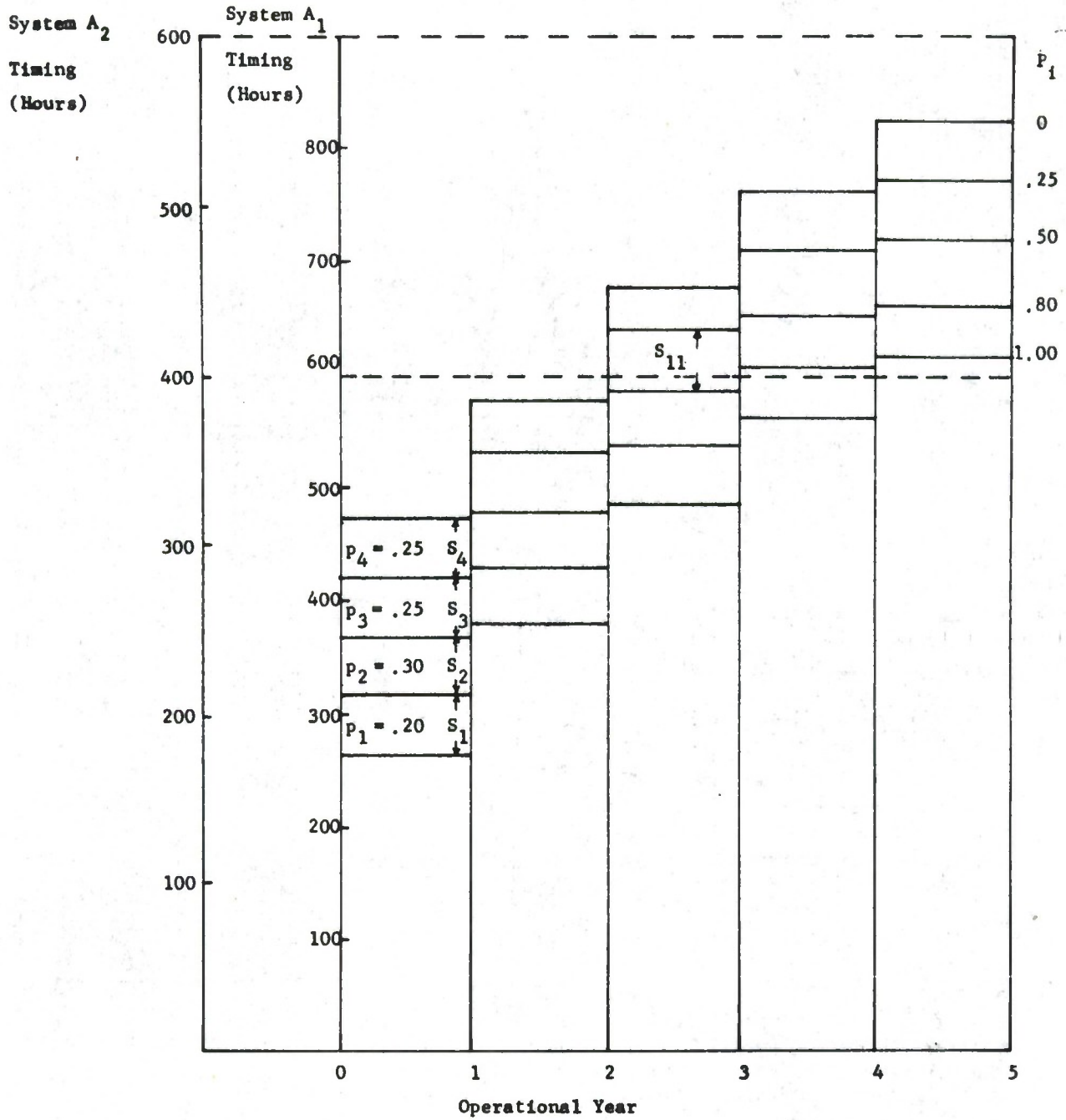

Figure 7. Vendor Response To Perform Representative Workload

by taking the difference between the two cumulative [32] probabilities that bound that segment. For example, the probability that the workload will fall within the segment S_1 is the difference between the probability that the workload will equal or exceed the reference workload (1.0) and the probability that the workload will equal or exceed 1.1 times the reference workload. Referring to Figure 5, the probability that the workload will fall within segment S_1 is $p_1 = 0.20$ (viz. $1.00 - 0.80$). Similarly, we could determine the probability p_i that the workload will fall within each of the other segments S_i .

These probabilities p_i ($i = 1, \dots, 4$ in this example) can then be used in equation (1) to determine the total expected cost for that operational year. The determination of the cost C_i to be applied to each segment will depend upon the amount of information available to the analyst and the accuracy that the analyst requires in his calculation. For example, referring to Figure 7 for vendor system A_1 , there is a probability of 0.20 that the actual workload will fall within segment S_1 ; i.e. between 260 hours and 320 hours. If we can assume that the probability is distributed uniformly within this range of workload and that the cost is proportional to the workload, then we can determine C_1 as the cost for system A_1 to perform an average workload of 290 hours.

Similarly, it can be seen from Figure 7 that there is a probability $p_2 = 0.30$ that the actual workload will fall within segment S_2 , between 320 hours and 370 hours, for vendor system A_1 . Again, assuming it is permissible to use the average workload, cost C_2 will be determined for vendor system A_1 to perform the average workload of 345 hours. In a similar fashion, probabilities p_3 and p_4 together with costs C_3 and C_4 can be determined. Equation (1) could now be used to determine the expected cost of operation for the first year, viz. $p_1C_1 + p_2C_2 + p_3C_3 + p_4C_4$. The same procedure could then be applied to each operational year to determine the expected cost for that year.

Several comments regarding this method should be made:

(1) System discontinuities may occur inside a segment. For example, the vendor may indicate a shift from system A_1 to A_2 in S_{11} , the third segment of the third operational year. Hence to calculate properly the expected cost of the third year's operation, a separate calculation for each of the two sub-segments must be made. In the above example, the probability that the workload will lie within each sub-segment would be determined from a further analysis of the cumulative distribution function of Figure 5 reproduced again

in Figure 8. If an assumption is made that the cumulative distribution function of Figure 8 consists of straight line segments which connect the estimates provided by the user, then linear interpolation may be employed. For example, the probability that the actual workload is between 1.0 and 1.05 times the representative workload is 0.10. A similar breakpoint or sub-segment would be used to represent other discontinuities that may occur in system costs such as might accompany shift changes. Again linear interpolation could be used to determine the probability associated with each of the resultant sub-segments.

(2) Non-productive time, previously discussed under system availability and dependability, can be handled in several ways. The method previously described assumed that the reliability of all vendor systems cannot be differentiated from one another, since they will all meet certain minimum standards. Hence an arbitrary maximum productive time, e.g. 600 hours, may be chosen for all vendors, and the vendor system expansions could all be based on this upper limit. On the other hand, the evaluators could permit each vendor to calculate his maximum productive time, and use this figure for expansion design purposes. Obviously, this method will require validation of vendor claims, but this could be done by using vendor-claimed reliability as part of the contract, if the vendor would agree to do so. The burden of proof for such validation is still on the vendor.

(3) Note that total system time was used to describe each workload for which the corresponding cost element C_1 was determined. In an actual case, the time corresponding to the utilization of each equipment component in the proposed configuration would be determined depending upon the vendor's cost elements. Again, depending upon the information available and the accuracy desired, the analyst could introduce simplifying assumptions to keep the calculations tractable and commensurate with the evaluation model selected.

(4) After the expected cost for performing each year's workload is calculated, we must still combine this "Cost Stream" over time into one total expected cost. This can be done using the standard approach of obtaining the total present worth by reflecting each of these costs back to time zero using an appropriate interest rate. In the same fashion, the lease vs. buy calculation may be performed to determine which present worth is the lower cost.

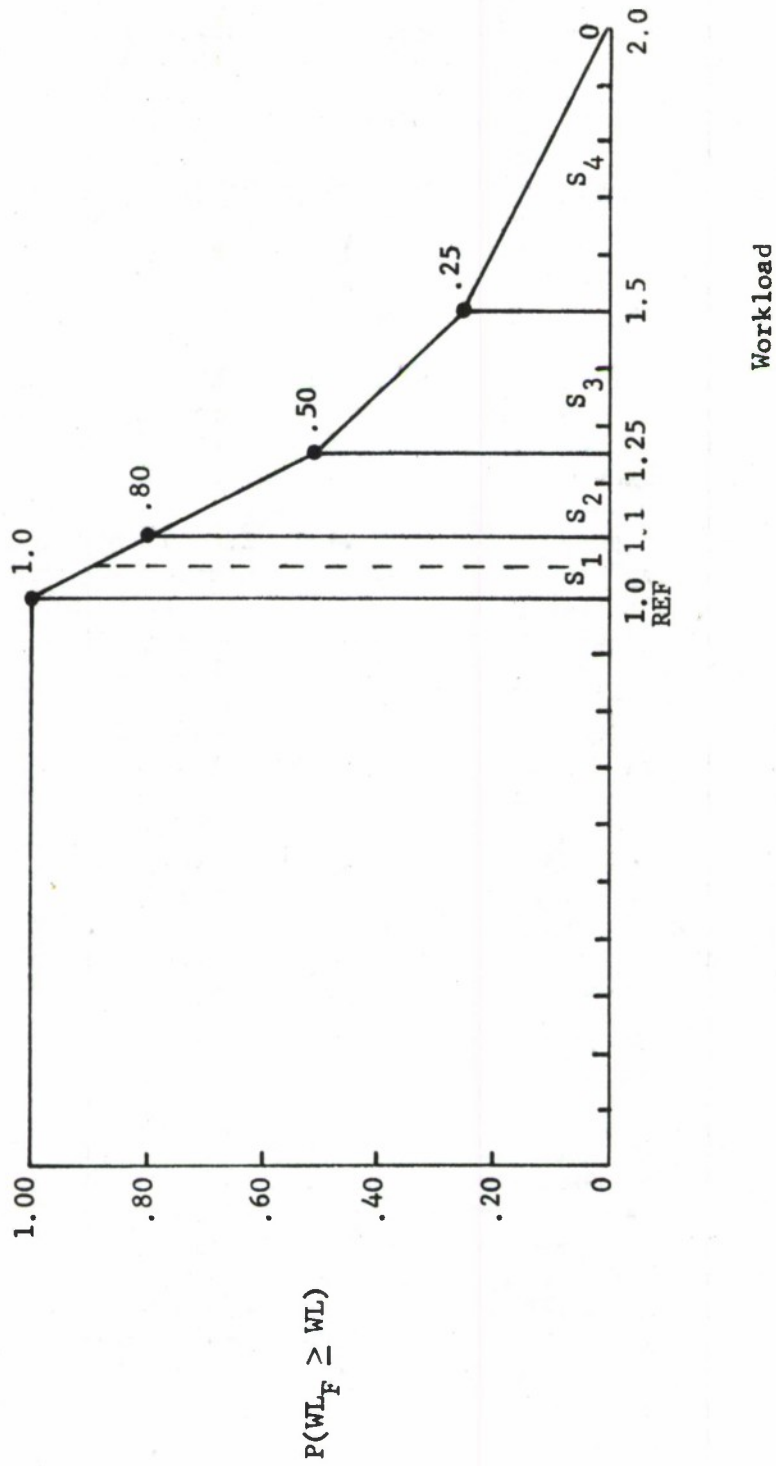

Figure 8. Probabilistic Workload Showing Linear Interpolation

c. Benefits

Let us now indicate some of the benefits of the proposed method of specifying the workload in probabilistic form as contrasted with a deterministic method of specifying workload. The deterministic procedure requires that the user provide one estimate of the representative workload for any given time rather than a "band" of estimates, as in the probabilistic approach. Thus the uncertainty is hidden rather than being made explicit. Under that procedure, a user is forced to insert some factor of safety in making his estimate which may be unduly high, since there are pressures on him to provide service to his users.

Providing only one estimate of workload to the vendor in the RFP does not permit him to perform suitable cost-performance trade-off analysis, since the vendor is not given any information indicating the worth of excess system capacity to the user. Providing the vendor with a range of values permits him to see the upper limit that has been set, as well as the estimated likelihood of reaching different workload levels. It thus permits the vendor to design a system capable of expanding to meet possible future growth requirements and to determine the worth of such an evolutionary system design in terms of the costs and expectation of using these growth increments. In this way the vendor can more effectively evaluate his alternative system configurations prior to submitting his proposal. This may reduce the number of alternative proposals which a vendor submits.

Using the proposed approach the source selection team can evaluate the vendor proposal in terms of its total expected cost. By including considerations of growth and determining their cost implications rather than asking the vendor if growth is available but not costing it, a more accurate estimate of the total cost of each vendor's proposed system can be obtained.

Mandatory Requirements

As discussed above in Section III. with reference to Figure 4, a second part of the selection process is the satisfying of the mandatory requirements. Each system can be readily evaluated against the mandatory requirements since, by definition, all systems must meet these or the vendor is considered non-responsive. For this reason, when the source selection plan is constructed, the list of mandatory requirements should be limited to those characteristics which can be firmly defended on a "go/no-go" basis. Any feature which the user desires, but cannot firmly defend, should be categorized as a desirable feature.

Desirable Features

As discussed previously, the evaluation team must also consider a set of desirable features as a hedge against uncertainty in the user's statement of his expected workload, as a hedge against the evaluator's uncertainty in measuring the vendor's capabilities, and as a source of additional vendor capability that was not adequately covered in the system timing.

a. Problem Statement

There are several reasons why the problem of evaluating desirable features is a much more difficult one than handling the first two elements of user needs, i.e., representative workload and mandatory requirements. First, it is almost certain that each of the vendors will submit a different "mix" of desirable features, ranging from none at all to all of the features requested. However, even though two vendors submit the same feature, each may have a different level associated with it, e.g., one billion versus two billion characters of IAS. Thus, the first problem is how to quantitatively measure the effectiveness of the combination of desirable features which each vendor offers. The evaluator can do this by attempting to determine the benefits to the user jobs which each feature contributes and then taking into account the interrelationship of several features as they contribute jointly to the accomplishment of user jobs. In developing a method for evaluating a particular feature, a way must be found to relate the characteristics of that feature to the jobs whose performance will be benefited by it. In general the direct effect of a system feature is felt in the time (system and/or staff) or quality of performing the jobs. If it can be determined that the effects of a feature have been adequately covered in the estimates of system timing previously calculated, then that feature need not be considered separately in the list of desirables. If this is not the case, then specific steps must be established for evaluating the feature.

Even if the evaluator could solve the first problem of evaluating the benefits contributed by each desirable feature, the evaluator still has the problem of determining if the difference in effectiveness among vendors is worth the difference in cost. Figure 9 illustrates in simplified form this problem of source selection with respect to desirable features. Consider two vendors each of whom performs the future workload at the same expected cost. However, assume that vendor A has proposed a minimal EDP system containing none of the desirable features listed in the RFP, but that vendor B has provided one of the desirable features as part of

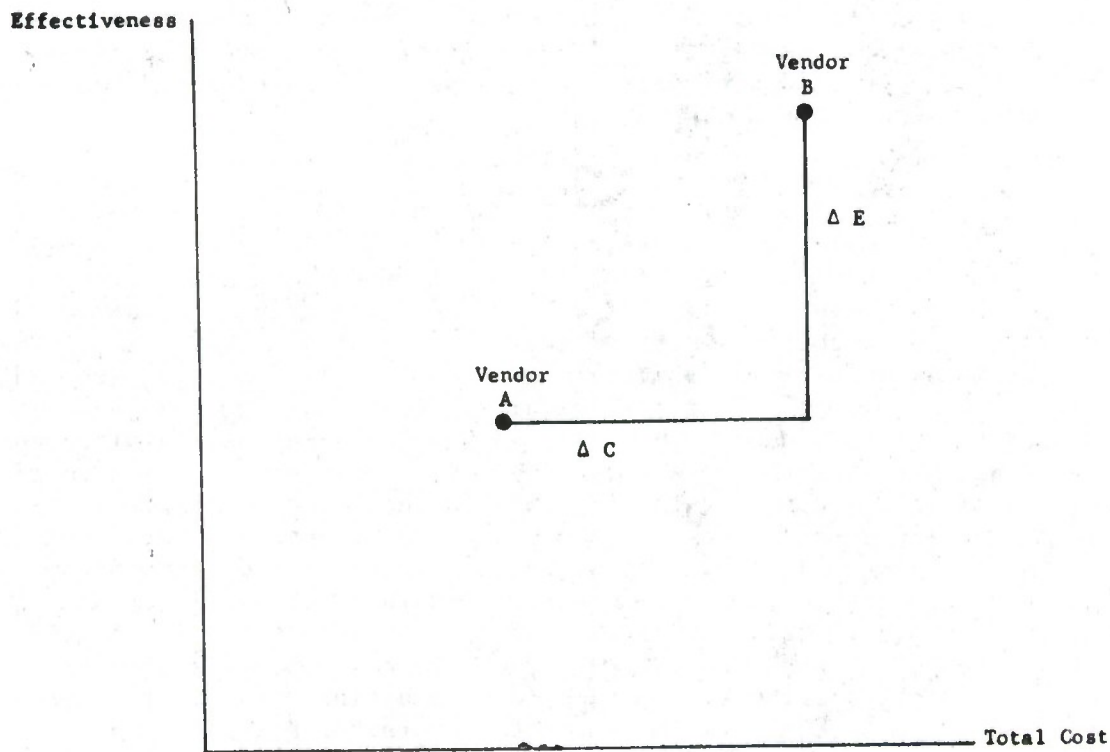

Figure 9. The Problem Of Evaluating Desirable Features

his proposal at a cost ΔC greater than vendor A's. Assuming that the performance of both machines is identical in all respects except for this desirable feature, we could state qualitatively that the effectiveness of vendor B's system is greater than vendor A's. However, is the increased effectiveness worth the additional cost of ΔC ?

As indicated previously, the fundamental principle being employed in the evaluation is to pivot on some constant level of effectiveness and to choose the vendor who provides this level of effectiveness at lowest cost. Unfortunately, the inclusion of desirable features makes it difficult to define a constant level of effectiveness. The user has stated that, in addition to accomplishing a certain workload, he desires that additional features also be provided. The solution to this problem can be found in the realization that if the user desires these features for meaningful reasons, then he must expect to have certain jobs which will benefit from these features. However, since the user has not made the provision of these features a mandatory requirement, he is implying that there must be alternative ways of accomplishing these jobs if the desirable feature is not available. This information enables the analyst to choose the proper level of effectiveness for selection purposes. This will be the level of satisfactorily performing the entire approved set of user jobs in accordance with approved standards of performance. Since each desirable feature contributes to some of these jobs, it now becomes a question of comparing the proposed cost of any desirable feature against the cost of other alternatives which can be used to do the same job(s). This approach to system selection translates the task of evaluating desirable features to one of cost analysis. It also leads to the concept of the "worth" of a desirable feature in doing a job.

The term "worth" has been subjected to diverse economic interpretation. For our purposes we will define the "worth" of a feature in doing a job as the lowest incremental cost to do the same job if the feature is not available. If the vendor's cost is less than the user's "worth", then that feature will be acquired from the vendor and the cost will be added to the total system cost. If the vendor's cost exceeds the user's "worth" or if the vendor does not provide the feature, then the user will make use of an alternative way and add the corresponding cost to the vendor's total system cost. If the vendor's cost for the feature is not separately identifiable, then there is no way to determine if his cost exceeds the user's "worth" and his proposed cost will not be changed.

This process for evaluating desirable features will be illustrated by an example in Section III. A key element in this process is the determination of the "worth" of a desirable feature.

b. Methods of Evaluating Worth

We can distinguish between two basic ways for determining the "worth" of the desirable feature. One method makes use of analysis; the other makes use of comparative ranking. Each of these methods will now be examined.

(1) Analytical Determination of Worth. Since the worth of a feature in doing a job has been defined as the lowest incremental cost to do the same job if the feature is not available, then to determine the "worth", one must first identify the alternative ways of doing the job if the feature were not available. As indicated diagrammatically in Figure 10, there may be several ways of doing the job without using the feature. The cost of each alternative way should be determined, and then, making use of the probability that the associated job will be performed, the total expected cost over the operational life of the system should be determined for each of these alternative ways. The worth of the feature will be the least of these costs.

In deciding on whether to utilize a particular desirable feature, the evaluator must also consider the cost of alternative ways of obtaining the feature and doing the job using the feature. For example, he might buy the feature directly from another source. Alternatively, as for example in the case of a software feature, the user might develop the feature using his own resources (in-house). If possible, then, the evaluator would make his decision based on doing the job(s) for which the desired feature is intended at lowest total cost. This might be called his "efficient" solution.

Thus the efficient solution may be chosen by determining the lowest cost method of obtaining the feature (and doing the job), comparing this cost against the worth, and choosing the lowest cost alternative. This process is illustrated in Figure 11. This figure indicates diagrammatically the cost-effectiveness of two proposals both of which perform the same basic workload and satisfy the mandatory requirements. These two proposals are assumed to be identical in all respects, differing only in that one provides a desirable feature F at a total system cost of C, whereas the other does not. It is immaterial to the present discussion whether these proposals come from the same or different vendors.

While the cost axis of Figure 11 can be quantified in a unidimensional scale, the effectiveness axis may involve a number of dimensions to represent the elements of effectiveness. However since we are pivoting on the constant level of effectiveness

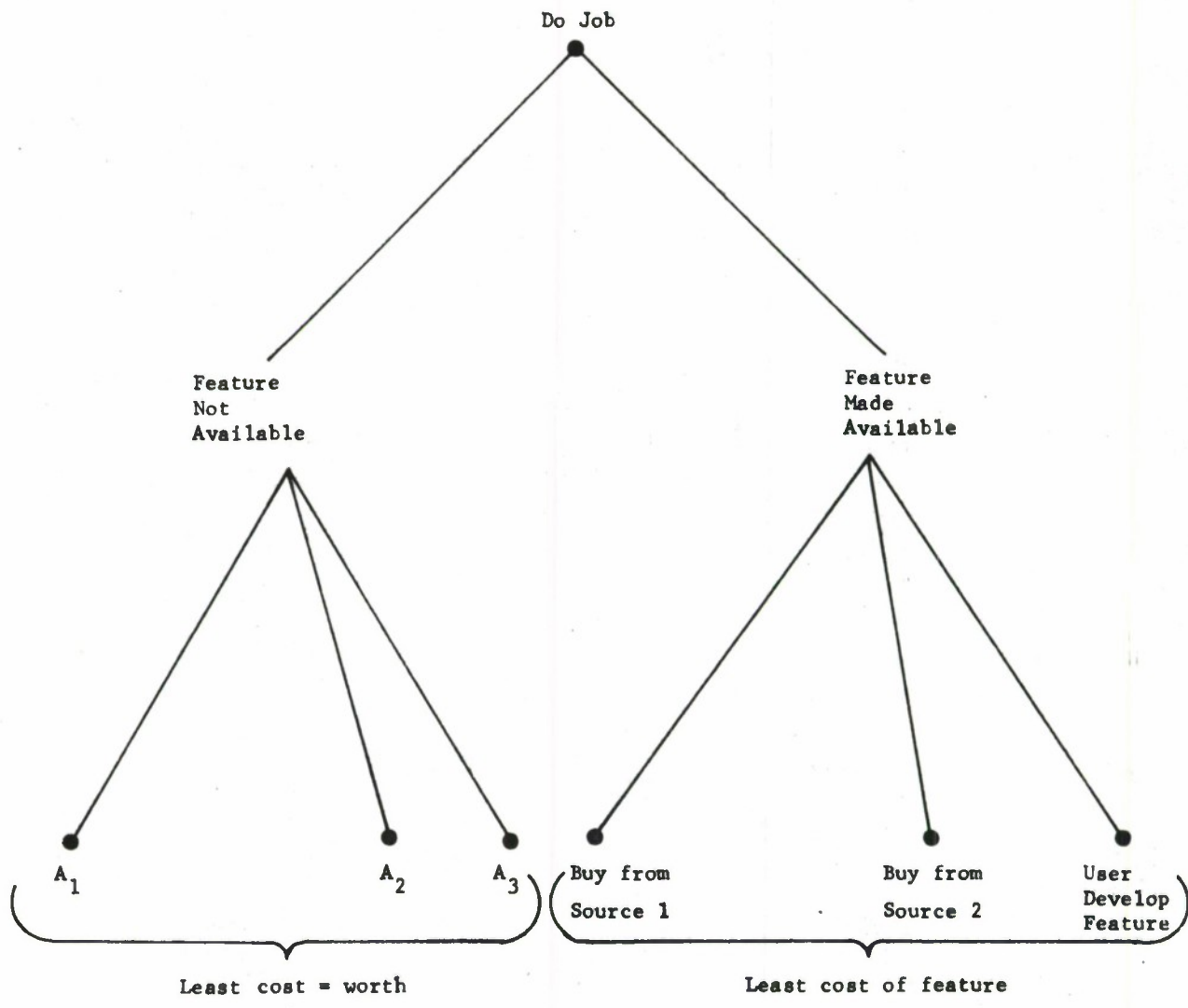

Figure 10. Desirable Features Alternatives

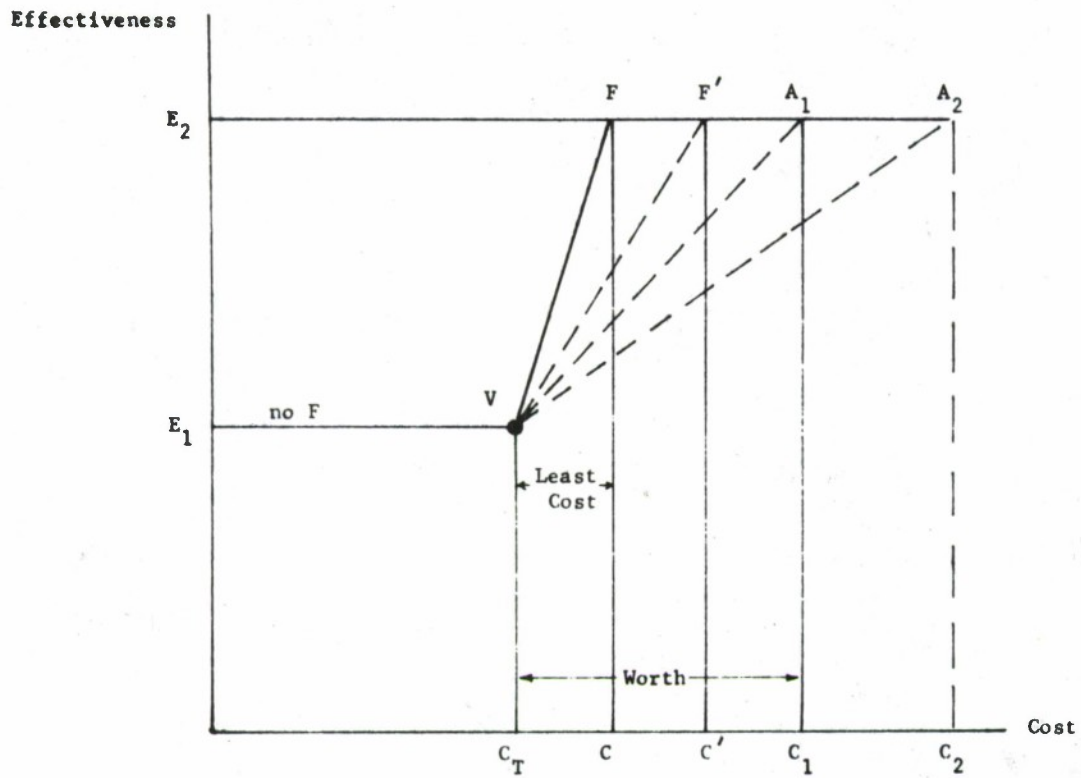

Figure 11. Selection Of Least Cost Alternative

specified by the analyst/user as previously discussed, we can represent this level diagrammatically as shown in Figure 11. This means that we are insisting that those user requirements, which would benefit from the availability of the feature, be satisfied by some other means if the vendor does not provide feature F. Analyzing the alternative ways available to the user results in alternatives A_1 and A_2 with their respective costs as shown. Thus, by our definition, the worth of the feature is the incremental cost of providing A_1 (that is $C_1 - C_T$).

However, it should be noted that once the worth of a feature is determined by analyzing the cost of a number of different ways of getting the job done if the feature is not used at all, this worth must be compared with the cost of all alternative ways of obtaining the feature and doing the job using this feature. Assume in the example that the same feature is available from one other source, labeled F' , and that the job could be done with this feature at a total system cost of C' , as shown in Figure 11. The proposed strategy is to choose the lowest cost method of getting the job done, whether by acquiring the feature or using a lower cost alternative. Hence in this case, feature F would be purchased.

(2) Determination of Worth by Comparative Ranking.

Sometimes, because of time and manpower limitations, it may not be possible to determine the worth of all desirable features by analysis and considered judgment. In such cases, intuitive judgment can be used as a part of the quantitative evaluation. Such an approach would be implemented as follows:

- (a) Rank all of the desirable features in order of importance. The ranking should be supported by deliberation utilizing whatever quantitative analysis and considered judgment may be available.
- (b) Allocate points to each feature, establishing its relative worth. Such relative worth will be based on the rationale developed.
- (c) Translate points to dollars of worth. This is accomplished by calibrating one or more of the features through determining its worth on some analytical basis as previously described.

- (d) Review the results obtained for intuitive soundness which is the only real test of this procedure. If the final results of dollar worth of each feature do not agree with the intuitive feelings of the evaluators or source selection plan reviewers, an iteration of the previous three steps should be performed, focusing on the following two potential sources of error: First, should the relative worth (i.e., points assigned) be changed? Second, are there ways of obtaining the features in question at a lower cost than the worth assigned to the feature? Obviously the more features that are calibrated by analysis, the more accurate will be this procedure.

c. Other Evaluation Alternatives

The most credible way to evaluate a desirable feature is to design a live-test demonstration that will include the effects of that feature. In this way, the results of the test will provide an explicit quantitative measure of the benefits of that feature. If these results can be incorporated into the overall system timing, then the particular feature need not be given any further separate consideration. If this is not the case, then the results of the test may be used in an evaluation by worth as described above.

However, one of the practical constraints in an actual source selection is the cost and effort expended in the live-test demonstrations. This means that the number of tests must be kept at a minimum with each test designed to serve as many testing functions as possible.

Under special circumstances, the following two evaluation alternatives may be justified:

(1) Establish Design Goals. The user may wish to establish a certain level of hardware or software performance that is characteristic of the present generation of equipment. If it is difficult to express the system requirements or to design the live-test demonstration in such a way as to rule out the proposal of equipment considered by the user to be substandard, then it may be desirable and justifiable to specify the feature as a non-discriminating standard or "design goal" which all qualified vendors can be expected to meet. For example, specifying the level of performance of a card reader, card punch, or printer might be justified in this way.

It should be noted that if this requirement is discriminatory among the competing vendors, it would be necessary to support this requirement more carefully in terms of system requirements.

(2) Qualitative Evaluation. If the worth of a desirable feature cannot be evaluated quantitatively by any of the above techniques, a qualitative evaluation should be made and documented for consideration by the Source Selection Authority. Such qualitative factors would only be considered and used as "tie-breakers" if several vendors were sufficiently close based on the quantitative evaluation.

d. Examples of Evaluating Desirable Features

The following examples are offered to illustrate how desirable features might be evaluated. It should be emphasized that these examples are only representative. Actually such features must be considered in the context of the user's system requirements.

(1) Example 1: Additional Core Storage. The user may feel that additional jobs not included in the representative workload may occur which will require additional core storage over and above that provided by the vendor in meeting the basic workload. While the best way of measuring this feature would be to include a job requiring large amounts of storage in one of the benchmark tests, it may not always be possible to do this. Hence, the evaluator must explore ways of performing the job if the additional core storage were not available. One way of doing this would be to segment the job into smaller parts. Now, what will this do to system costs? First, programmer time will increase due to the additional programming load. Second, the system running time will increase due to the lower efficiency of the operation. Both of these will lead to increased machine and staff time. The size of the increase will depend on the complexity of the job and the frequency of its operation. If no other alternatives were available, the cost of segmentation would be the worth of this desirable feature.

The evaluator must also consider alternative ways of obtaining the feature. For example, it may be possible to contract the jobs requiring additional core storage to a Service Bureau or some satellite operation equipped to handle it, if this is satisfactory to the user. In this case, the resulting costs would be estimated and the least cost of all alternative ways to obtain additional core storage would be determined.

(2) Example 2: Software Feature. If the job(s) needing the feature has been included in the live-test demonstrations, evaluation of the feature is implicitly included in the system timing obtained, and

another evaluation is not needed. If the feature is not included in the live-test, non-availability of the feature will most likely affect the programmer hours required to develop and maintain the system's programs. Programmer hours would be affected since the programmer would now have to do additional programming to make up for not having the software feature at all. One way to handle this would be for the analyst to determine the total number of programming hours which would be required to do the programming if the software feature were available at some standard reference level. Based on this reference level, one can define the term "programmer performance factor" in the following fashion:

$$\text{Programmer Performance Factor} = \frac{\text{Reference Time}}{\text{Proposed Time}}$$

where the Reference Time is the total estimated programmer time (in manhours) taken to program a particular job using this reference level of software capability for the feature in question, and Proposed Time is the total estimated programmer time taken using the vendor proposed level of that feature. Using either live-test demonstration results or the collective considered judgment of the evaluators in estimating the capability of a software feature to perform a certain class or classes of jobs, the evaluation function illustrated in Figure 12 can be constructed. Making use of this evaluation function and the total programmer hours estimated by the analyst to be required if the software feature were available at the reference level, the programmer hours required for the proposed level can be determined. For example, if the analyst estimates that for the reference level of the software feature, the programmer time would be 3000 hours, and if he determines that the proposed feature has an efficiency of 85%, then the estimated programmer hours required by the vendor's system is given by:

$$\begin{aligned} \text{Estimated Programmer Hours} &= \frac{\text{Reference Programmer Hours}}{\text{Programmer Performance Factor}} \\ &= \frac{3000 \text{ Hours}}{.85} = 3450 \text{ Hours} \end{aligned}$$

By subtracting the cost of the estimated programmer hours from the least costly method of programming the job(s) if the desirable feature were not available, the worth of the feature can be determined.

Alternative ways of obtaining the software feature must also be considered. For example, it may be possible for the user to develop the feature in-house, requiring additional programmer and

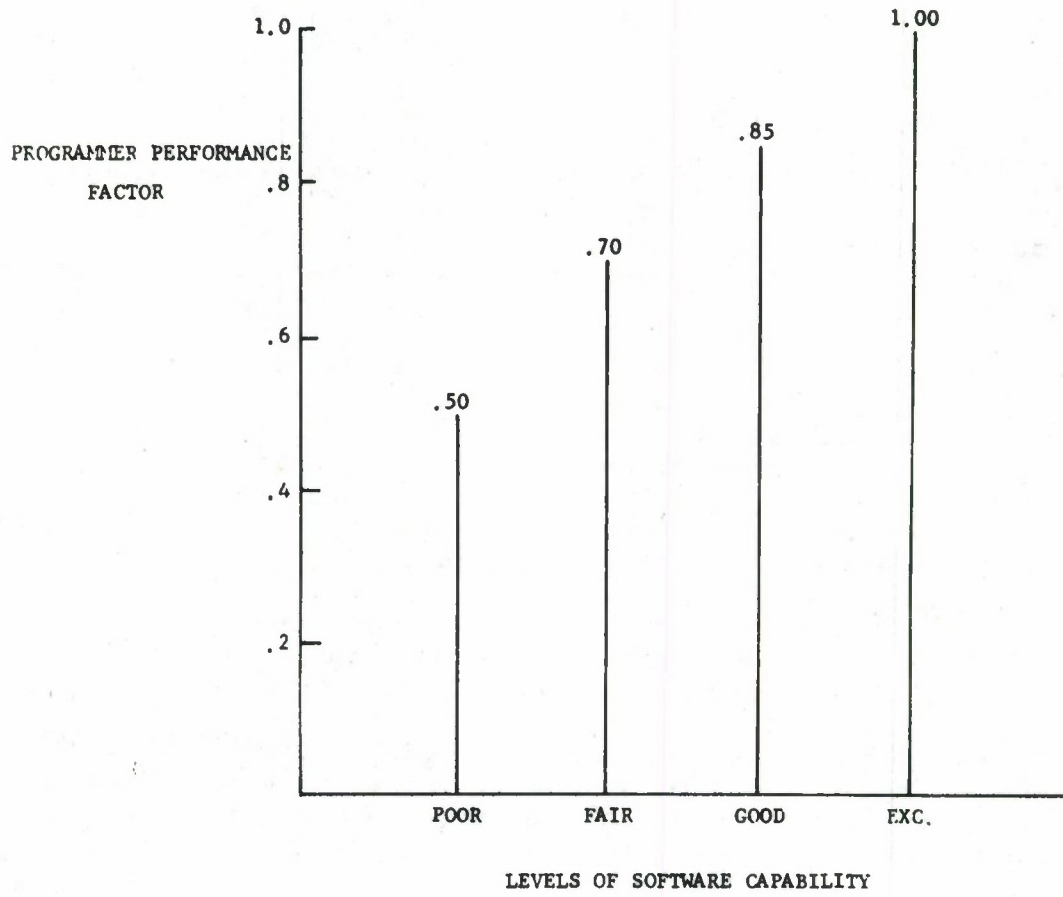

Figure 12. Software Feature Evaluation Function

machine time. Alternatively, he may turn to other software sources and purchase the feature as a package. The least cost of these alternatives would then be used along with the worth in the selection process.

(3) Example 3: Documentation. Again the question can be asked, "How much does it cost the user if the user is forced to use inadequate documentation as opposed to 'Excellent' documentation?" The added cost might be the extra time required for readers of the documentation as they struggle to understand what the author had in mind. Thus, documentation may be evaluated using the same concept of "efficiency", as described previously, and calculating the larger number of staff hours required, based on the lower efficiency factor due to the unavailability of excellent documentation. If possible, the analyst might include in this determination of worth some measure of the costs incurred due to system malfunction that might occur because of the inadequate documentation. As before, the analyst would also want to consider alternative ways of obtaining excellent documentation. The least cost of these alternatives would then be used along with the worth in the selection process.

Note that for this example, the analyst might prefer for various reasons (such as economy) to use an alternative evaluation procedure. He could handle documentation as a design goal by requiring in the RFP that certain standards of documentation be satisfied. In this way the feature becomes a mandatory requirement. Alternatively, the analyst might choose to process vendor differences in documentation qualitatively by noting the differences and including the relevant information for consideration only as part of a tie-breaking procedure.

e. Remarks

The determination of the worth of a desirable feature by constructing an evaluation function which relates the performance benefits of the feature with cost is the most satisfactory way of evaluating a desirable feature if its effects cannot be directly included in system timing. It should be emphasized that the judgment of experienced personnel will be required to construct the evaluation functions. In fact, the accuracy of the analysis is only as good as the experienced judgment and substantiating data available. Undoubtedly the most reliable substantiation would come from benchmark tests. While errors in judgment are never completely avoidable, there are two compensating features to the above approach:

(1) This type of analysis forces the user and evaluator to think through and develop the rationale for the need for desirable

features and, hence, is superior to a purely intuitive judgment approach, since it is more defensible.

(2) The rationale and evaluation functions developed are made explicit and, hence, subject to review by the Source Selection Authority. Thus they can be changed if additional information is available.

SELECTION APPROACH

Previous sections of this report have indicated how to evaluate vendor proposals with respect to workload, mandatory requirements, and desirable features. This section will expand upon the steps to be followed in evaluating the vendor proposals for their desirable features and in making a final selection using all of the data gathered. To illustrate the approach, a simplified example will be used.

Determining the Worth of Desirable Features

The Source Selection Plan approved by higher headquarters will include a list of all desirable features to be quantitatively evaluated, the dollar worth (or evaluation function which describes such worth) for each feature, as well as the lowest known cost of obtaining the feature separately. An example of the worksheet to be used in the evaluation (which can be constructed as an appendix to the Selection Plan) is shown in Figure 13. This figure corresponds to an example in which there are three desirable features to be considered, i.e., F_1 , F_2 , and F_3 , whose user worths and least costs are indicated. (In the example shown, each feature is either provided completely or not at all. If various levels of a feature could be provided, the evaluation function showing worth as a function of level provided would be used instead of the single number.)

Vendor Submits Proposed Costs

The proposal submitted by each vendor provides the following information to the evaluators:

- a. Total proposed cost for entire system.
- b. Cost of each system and expansion capability required to meet the probabilistic workload.
- c. Sufficient information to calculate the total expected cost of performing the probabilistic workload.
- d. Cost of each separate desirable feature not included as part of the basic system.

COST ELEMENTS						SYSTEM COST		
						C _A	C _B	C _C
1. TOTAL PROPOSED VENDOR COST						300K	310K	330K
2. EXPECTED COST TO DO REPRESENTATIVE WORKLOAD						300K	305K	310K
3. COST OF ADDITIONAL JOB BENEFITS:								
DESIRABLE FEATURE	USER WORTH	LEAST COST	VENDOR COST					
			C _A	C _B	C _C			
F ₁	10K	15K	—	incl.	15K.	10K	—	10K
F ₂	25K	20K	—	—	5K	20K	20K	5K
F ₃	10K	20K	—	5K	incl.	10K	5K	—
4. TOTAL EXPECTED COST TO DO USER JOBS						340K	330K	325K*

* Vendor C selected - lowest total cost

Figure 13. Evaluator's Worksheet

Calculating Cost of Representative Workload

Utilizing the vendor supplied information, the evaluator calculates the total expected cost of each vendor's system to perform the total representative workload as previously described in Section III. These results are then entered into the evaluator's worksheet as shown in Figure 13.

Validation of Mandatory Requirements

Based on the vendor supplied information, the evaluator must validate that the mandatory requirements have been satisfied.

Calculating Cost of Additional Job Benefits

The evaluator inserts into the Evaluator's Worksheet all of the desirable features which each vendor has proposed and the incremental costs associated with each of these options. Note that vendor A does not provide any of the three features, whereas the cost of F_1 and F_3 are included in the cost of vendor B and vendor C, respectively. Based on the cost information of Figure 13, the evaluator can determine for each vendor the least costly of the three alternative ways of receiving the benefits provided by each of the desirable features. These three alternatives are:

- a. Buying the desirable feature from the vendor (at the vendor's proposed cost).
- b. Obtaining the desirable feature from another source (at the least cost of feature if obtained separately).
- c. Not buying the feature, but using the least costly alternative way to provide the benefits (at a cost equal to user worth).

The lowest additional user cost for obtaining the desirable feature (or its equivalent) is shown in Figure 13 as System Cost. Note in the example that the user has stated that the worth of F_1 is \$10K, i.e., he can perform the jobs associated with F_1 at an expected cost of \$10K. Since vendor A does not provide this feature, the user will be forced to spend \$10K in addition to vendor A costs to meet those jobs associated with F_1 . Vendor B includes this feature as part of his basic system and has stated that it cannot be removed or priced separately. Hence, the user will not have to spend the \$10K when using vendor B's system. Vendor C can provide F_1 at a cost of \$15K. Hence, the evaluator decides to eliminate this optional feature from vendor C's proposal since its cost is higher than its worth to the user, i.e., the cost of an alternative method for the user to perform the related jobs.

This same approach is followed in determining which of the other desirable features are to be included in the evaluation.

Calculating Total Expected Cost

The total expected cost to the user is then calculated by adding the cost of each desirable feature (or user cost equivalent) to the expected cost of performing the probabilistic Representative Workload. This total cost, shown in Figure 13, completes the cost calculation.

Several interesting observations can be made from analyzing this illustration:

1. Vendor A had the lowest proposed cost (since he provided no desirable features) as well as the lowest cost of performing the representative workload. On the other hand, winning vendor C had the highest proposed cost (since he had proposed all three desirable features) and the highest cost of performing the representative workload. However, neither of these costs is the proper measure for selection. If one believes that the user really does have need for the additional capability represented by the list of desirable features, and that he will have to spend additional funds (i.e., the worth) if a desirable feature is not provided, the true criterion of choice must be based on the total system costs. There were two reasons why vendor C had the lowest total cost in spite of his other higher costs. First, he included F_3 at no additional cost, and this was worth \$10K. Second, he provided F_3 for \$5K and the evaluators estimated its worth to be \$20K.

2. With this approach there are definite advantages to the vendor to separate as many desirable features as possible from the basic system and provide these as optional cost features at a stated price for each feature. The reason for this is that if the calculated worth of each feature is not stated to the vendors (and it should not be since this information may affect the vendor's price), the vendor has no logical way of determining whether to propose a desirable feature or not. Hence, he is forced to hedge his bets by submitting alternative proposals, which may increase the vendor's proposal costs and the evaluator's selection costs. However, with the proposed procedure, the vendor knows that the evaluator will only choose those desirable features which have value to the user and reject those whose costs are too high. Hence, the vendor will feel free to offer a "shopping list" of optional desirable features, each at a separate price, as part of his proposal, knowing that he cannot be penalized by this strategy.

In the previous illustration, if vendor C had included the high cost of F_1 as part of his basic system, his total cost would have been higher and he would have tied with vendor B.

SECTION IV

CONCLUSIONS

SYSTEM FEASIBILITY

The cost-effectiveness approach described in this paper appears feasible and a test project to apply the method to an actual selection is being carried out.

USER IMPLICATIONS

This evaluation procedure will permit the user to acquire a cost-effective EDP system. It should be emphasized, however, that additional analysis and data will be required from the user, relating system specifications to its expected use, if this procedure is to be implemented. Such data will consist of a representative workload expressed in probabilistic form, as agreed upon by the user and AFADA, a set of defensible mandatory requirements, and a set of desirable features together with the worth to the user for having each feature, as determined by the user and ESQ.

VENDOR IMPLICATIONS

This more useful statement of user needs and the selection criteria to be used allows the vendors to construct a better system design by performing more and better cost-performance trade-off analyses, based on better information. In addition, by permitting the vendor to propose optional features, some of which will be selected by the evaluators on the basis of its cost being less than its worth, the vendor may not have to propose separate, alternative proposals, each containing different combinations of desirable features.

EVALUATION IMPLICATIONS

From the evaluator's point of view, the proposed approach is more defensible than other approaches examined for several reasons. First, it is operationally oriented and, hence, is more rational and should be more understandable to reviewers. Second, it avoids combining cost and performance factors which is always difficult to justify, in favor of choosing that system which will satisfy approved user needs at lowest total cost to the Air Force.

Since it is more explicit and rational than other procedures examined, it offers a means of resolving differences of opinion regarding the worth of system features. It should be stressed that the overall evaluation framework that has been developed does not eliminate the need for vendor validation.

APPROVAL AUTHORITY IMPLICATIONS

The proposed approach is consistent with OSD practices in the field of source selection. In addition, by quantifying the uncertainty in workload, the major factor in the evaluation, rather than using a single deterministic estimate, increased confidence in the final selection is obtained.

ADDITIONAL REMARKS

This report is intended to describe how cost-effectiveness analysis can be applied to EDP system selection. As the reader will appreciate, there are many details involved in the system selection that cannot be discussed in this report. Such details are difficult to discuss in generality since their relevance depends strongly on the context in which they appear. We feel that the approach we have described in this report towards EDP system selection will provide a formal framework into which the details of a specific selection can be inserted. It is our intention, as we gain experience in applying the technique, to supplement this report with a more detailed account of how specific elements of a selection may be processed. At the time of the preparation of this report, we have only considered this technique in relation to a review of a number of past EDP system selections. The validity of the technique can best be established through demonstration. It is our plan to accomplish this by applying the technique to a specific EDP system selection.

APPLICABILITY TO OTHER SOURCE SELECTIONS

One last point of general interest should be made to those readers who have an interest in source selection of systems other than EDP systems. We have attempted to show that the general principles of cost-effectiveness analysis which have been applied so often to the concept formulation or systems planning phase of the systems acquisition process can also be applied to the source selection process, specifically of EDP systems. The same approach can also be applied to other systems. In fact, it may be easier

to apply this to other areas where the measure of effectiveness is more easily defined and measured. For this reason, evaluators in other system areas should give thought to the possibility of applying the cost-effectiveness approach in a form tailored to their problem, as was done for the EDP problem.

REFERENCES

1. O. Dopping, "Test Problems Used for Evaluation of Computers," BIT 2, 1962, pp. 197-202.
2. J. A. Gosden, "Estimating Computer Performance," The Computer Journal, 1962, pp. 276-283.
3. J. A. Gosden and R. I. Sisson, "Standardized Comparison of Computer Performance," Information Processing, Proceedings of the IFIP Congress 1962, pp. 57-61.
4. J. R. Hillegasse, A. C. Nester, J. A. Gosden, and R. I. Sisson, "Generalized Measures of Computer Systems Performance," 1962 ACM National Conference, pp. 120-121.
5. R. W. Rector, "Measuring the Capability of Computing Equipment," SDC internal working paper N-19243, 1 November 1962.
6. C. C. Hendrie and R. W. Sonnenfeldt, "Evaluating Control Computers," ISA Journal, August 1963, pp. 73-78.
7. P. W. Abrahams, M. F. Lipp, and J. Harlow, "Quantitative Methods of Information Processing System Evaluation," ESD-TDR-63-670, October 1963, published by the Directorate of Computers, ESD (USAF), available through DDC and OTS.
8. N. Statland, "Methods of Evaluating Computer Systems Performance," Computers and Automation, February 1964, pp. 18-23.
9. L. Fein, "Assessing Computing Systems," Data Processing for Management, February 1964, pp. 19-21.
10. E. Moslin, "Application Benchmark - The Key to Meaningful Computer Evaluations," Proceedings of ACM Conference - 1965.
11. F. Weinwurm, "The Description of Computer System Performance," Proceedings of the Symposium on Economics of Automatic Data Processing, Rome, 19-22 October 1965.
12. R. A. Arbuckle, "Computer Analysis and Thruput Evaluation," Computers and Automation, January 1966, pp. 12-15, 19.
13. J. R. Hillegass, "Standardized Benchmark Problems Measure Computer Performance," Computers and Automation, January 1966, pp. 16-19.

REFERENCES (CONTINUED)

14. Martin B. Solomon, Jr., "Economies of Scale and the IBM System/360," Comm. ACM 10, June 1966, pp. 435-440.
15. P. Calingaert, "System Performance Evaluation: Survey and Appraisal," Comm. ACM 10, Jan. 1967, pp. 12-18.
16. M. Schatzoff, R. Tsao, and R. Wiig, "An Experimental Comparison of Time Sharing and Batch Processing," Comm. ACM 10, May 1967, pp. 261-265.
17. M. B. Solo, "Selecting Electronic Data Processing," Datamation, Nov.-Dec. 1958, pp. 28-32.
18. J. DeParis, "Evaluating Available Equipment," Data Processing, September 1960, pp. 36-37.
19. Castillo-Fernandez, "Technique for Evaluating Electronic Computers," Data Processing, September 1962, pp. 32-34.
20. C. R. Pack and J. L. Hancock, "When a Commander Picks a Computer...", Armed Forces Management, March 1963, pp. 38-42.
21. Q. N. Williams, R. S. Perrot, J. Weitzman, and J. A. Murray, "A Methodology for Computer Selection Studies," Computers and Automation, May 1963, pp. 18-22.
22. E. Joslin, "Cost-Value Technique for Evaluation of Computer System Proposals," 1964 Spring Joint Computer Conference.
23. S. Rosenthal, "Analytical Technique for Automatic Data Processing Equipment Acquisition," 1964 Spring Joint Computer Conference.
24. C. Koenig and K. Bruck, "EDP Equipment Selection," Management Services, Sep.-Oct. 1964, pp. 37-43.
25. E. O. Joslin and J. J. Aiken, "The Validity of Basing Computer Selections on Benchmark Results," Computers and Automation, January 1966, pp. 22, 23.
26. L. R. Huesmann and R. P. Goldberg, "Evaluating Computer Systems Through Simulation," Computer Journal, Aug. 1967, pp. 150-155.
27. N. R. Nielsen, "Computer Simulation of Computer System Performance," Proceedings of 22nd National Conference, A.C.M. Publication P-67, Thompson Book Company, Washington, D.C., 1967, pp. 581-590.

REFERENCES (CONCLUDED)

28. A. J. Dowkont, W. A. Morris, and T. D. Buettell, "A Methodology for Comparison of Generalized Data Management Systems: PEGS," DDC AD-811682L, Informatics Inc., Sherman Oaks, Calif., March 1967.
29. J. R. Miller, III, "A Systematic Procedure for Assessing the Worth of Complex Alternatives," ESD-TR-67-90, The MITRE Corp., Bedford, Mass., Sept. 1966.
30. Weapon System Effectiveness Industry Advisory Committee (WSEIAC), Final Summary Report, AFSC-TR-65-6, January 1965.
31. C. J. Hitch and R. N. McKean, The Economics of Defense in the Nuclear Age, Harvard University Press, Cambridge, 1960.
32. R. Schlaifer, Probability and Statistics for Business Decisions, McGraw-Hill Book Company, New York, 1959.

DOCUMENT CONTROL DATA - R & D

(Security classification of title, body of abstract and indexing annotation must be entered when the overall report is classified)

1. ORIGINATING ACTIVITY (Corporate author) The MITRE Corporation Bedford, Massachusetts		2a. REPORT SECURITY CLASSIFICATION UNCLASSIFIED	
		2b. GROUP N/A	
3. REPORT TITLE APPLICATION OF COST-EFFECTIVENESS ANALYSIS TO EDP SYSTEM SELECTION			
4. DESCRIPTIVE NOTES (Type of report and inclusive dates) N/A			
5. AUTHOR(S) (First name, middle initial, last name) Jack D. Porter, Bernard H. Rudwick			
6. REPORT DATE March, 1968	7a. TOTAL NO. OF PAGES 58	7b. NO. OF REFS 32	
8a. CONTRACT OR GRANT NO. AF 19(628)-5165	9a. ORIGINATOR'S REPORT NUMBER(S) ESD-TR-67-412		
b. PROJECT NO. 8510	9b. OTHER REPORT NO(S) (Any other numbers that may be assigned this report) MTR-527		
c.			
d.			
10. DISTRIBUTION STATEMENT This document has been approved for public release and sale; its distribution is unlimited.			
11. SUPPLEMENTARY NOTES N/A		12. SPONSORING MILITARY ACTIVITY EDP Equipment Office, Electronic Systems Division, L. G. Hanscom Field, Bedford, Massachusetts	
13. ABSTRACT A conceptual approach for evaluating and selecting among alternative Electronic Data Processing (EDP) systems proposed to meet a set of EDP user needs has been developed by applying cost-effectiveness methods and techniques to the source selection problem. The report provides a framework that allows the EDP system evaluator to combine the selected relevant system performance measures and the related cost elements to arrive at a rational defensible selection decision.			

KEY WORDS	LINK A		LINK B		LINK C	
	ROLE	WT	ROLE	WT	ROLE	WT
EDP EQUIPMENT EVALUATION COST-EFFECTIVENESS						