

LABORATORY FOR  
COMPUTER SCIENCE



MASSACHUSETTS  
INSTITUTE OF  
TECHNOLOGY

MIT/LCS/TR-397

**BOSTON COMMUNITY  
INFORMATION SYSTEM  
1986 EXPERIMENTAL  
TEST RESULTS**

David K. Gifford  
Dawn Heitmann  
David A. Segal  
Robert G. Cote  
Kendra Tanacea  
David E. Burmaster

August 1987

545 TECHNOLOGY SQUARE, CAMBRIDGE, MASSACHUSETTS 02139

*This blank page was inserted to preserve pagination.*

MIT/LCS/TR-397

Boston Community Information System

1986 Experimental Test Results

by

David K. Gifford, Dawn Heitmann, David A. Segal  
Robert G. Cote, Kendra Tanacea, and David E. Burmaster

This research was supported by the Defense Advanced Research Projects Agency of the Department of Defense and was monitored by the Office of Naval Research under contract number N00014-83-K-0125.

© 1987 Massachusetts Institute of Technology

## Table of Contents

Section 1 — Executive Summary	1
1.1 — Background	1
1.2 — The Users	1
1.3 — System Use	1
1.4 — Changes in Participants' News Habits	2
1.5 — Desired Types of Information	2
1.6 — Business vs. Consumer Use	2
1.7 — Value of the Simplex and Duplex Modes	2
1.8 — Feelings Toward Commercial Extension	2
1.9 — Suggestions for Improvements	3
1.10 — Reasons for Loss of Interest	3
1.11 — Overview	3
Section 2 — Experimental Overview	4
2.1 — A New Information System Technology	4
2.2 — The Boston CommInS Technology	5
2.3 — Experimental Design	5
2.4 — References	6
Section 3 — Analysis of Data	8
3.1 — User Population Profile	8
3.2 — Daily System Use	9
3.3 — Changes In Participants' News Habits	10
3.4 — Types of Information Participants Want and Do Not Want	11
3.5 — Business vs. Consumer Use	12
3.6 — How Valuable Participants Find the Broadcast and Two-Way Parts	12
3.7 — Participants' Feelings Toward Commercial Extension	13
3.8 — How Much Participants Are Willing to Pay for the System	14
3.9 — Suggestions for Changes and Extensions to the Boston CommInS	14
3.10 — Why Some Participants Lose Interest in the System	15
3.11 — Profile of People Who Lose Interest in the System	15
Section 4 — Primary Data from the First Year	26

## List of Figures

<b>Figure 2-1:</b>	<b>Boston CommInS System Block Diagram</b>	<b>7</b>
<b>Figure 3-1:</b>	<b>The Boston Community Information System User Population</b>	<b>17</b>
<b>Figure 3-2:</b>	<b>How Much Time Users Spend At Their Keyboard Using the BCIS</b>	<b>18</b>
<b>Figure 3-3:</b>	<b>Number of Minutes Users Spend Carefully Reading Articles</b>	<b>19</b>
<b>Figure 3-4:</b>	<b>Number of Minutes Computer Receives Data via Radio Packet Receiver</b>	<b>20</b>
<b>Figure 3-5:</b>	<b>The Value of the System to the Users</b>	<b>21</b>
<b>Figure 3-6:</b>	<b>Use of the Duplex System</b>	<b>22</b>
<b>Figure 3-7:</b>	<b>How Much Users Would Pay for One-way Service</b>	<b>23</b>
<b>Figure 3-8:</b>	<b>How Much Users Would Pay for Two-way Service</b>	<b>24</b>
<b>Figure 3-9:</b>	<b>Number of Months User Had System Prior to Returning It</b>	<b>25</b>

# Boston Community Information System

## 1986 Experimental Test Data

This report describes the first year of an experimental test of the Boston Community Information System (Boston CommInS). The experiment implements new ideas of data communication and database design in the transmission and reception of data. The system offers the *Associated Press* and New York Times to participants and is provided in exchange for their monthly feedback.

During the first year of the experiment, over 200 homes and businesses in the Boston area used and evaluated our system. This report contains all the data we have compiled and analyzed, in addition to a full discussion of several hypotheses and design goals. Among the conclusions drawn, we found the Boston Community Information System provides a useful complement to existing media forms and has proved valuable to the many users in the test population.

Keywords: database system, electronic newspaper, distributed information system

## Section 1 — Executive Summary

### 1.1 — Background

In December 1985, culminating two years of design, prototyping, and preparation, we launched an experimental test of the Boston Community Information System in Boston area homes and businesses. The Boston CommInS represents a new type of large scale distributed database system architecture. The test documented in this report was designed to explore the usefulness of this new architecture.

The Boston CommInS delivers information to personal computers via digital broadcast and telephone. During the period of this test, the Boston CommInS provided its users access to the full-text of news and features from the New York Times (NYT) and the Associated Press (AP), including reviews, columns, business news, editorials, commentaries, and weather forecasts.

Starting in December 1985, 56 people within a fifteen mile radius of the Prudential Building in Boston's Back Bay began using the system. In February 1986, we distributed the system to more people, bringing the total user population to about 145. In September 1986, we distributed new software to current and new users, increasing the number to 175 total participants. This new software automatically accesses a central server at MIT, if a user's personal computer does not have the data necessary to process a user request. The delivery of data via broadcast is called the *simplex* part of the system, and the delivery of data via modem is called the *duplex* part of the system.

Focusing on the responses to the monthly questionnaires, this report summarizes, interprets, and presents the full responses of the participants for the first 14 months of the experiment (December 1985 through January 1987). Section 2 of this report is an overview of the experiment. Section 3 analyzes the data collected from the monthly questionnaires, and Section 4 presents all the primary data from the 12 questionnaires from the period under review.

### 1.2 — The Users

Most of the participants male, ranging in age from 20 to 50 years old. Most have several years experience with personal computers, and most are or were affiliated with MIT. Thus, even with efforts to broaden the experimental population to include people from many segments of our society, the self-selected participants have a strong technical orientation and high educational achievement. In addition, five visually impaired people use the CommInS system regularly.

### 1.3 — System Use

On average, participants run the CommInS software on their computers 7 hours per day, with some reporting 24 hour use. Of this time, a typical participant sits at the keyboard 20 to 30 minutes per day, but some report that they sit at the keyboard more than 90 minutes per day.

While the statistics on system use are detailed in Section 4, Section 3 illustrates that these numbers and results lead to conclusions on larger issues. First, the participants prefer highly polished news stories (as commonly distributed over the NYT wire) over up-to-the-minute, unformatted, incremental articles (as commonly distributed over the AP wire). Second, our participants prefer to invoke commands by keystrokes rather than from menus, even though the CommInS software supports both options. Third, the participants like the kernel of the user interface since it uses "filter lists". These "filter lists" identify stories for capture to the local database.

#### **1.4 — Changes in Participants' News Habits**

Seventy-five percent of the participants feel they are better informed with the CommInS system. However, at this time, most users see electronic publishing as a supplement to regular newspapers, not a substitute. More specifically, many of the participants prefer to browse or read a newspaper for general information; while concurrently, they rely heavily on the CommInS for the capture of specific information. Thus, the participants use the CommInS in a sophisticated way to supplement and extend their previous news habits.

#### **1.5 — Desired Types of Information**

Most people do not object to the text-only service the system offers. Few report that they greatly miss the graphics or the photographs a regular newspaper offers. Most have expressed an interest in having more financial information on the system, including data on stock prices, and participants most frequently recommended the addition of the Wall Street Journal to the service. In keeping with their technical orientation, users also suggested the addition of professional journals or at least their tables of contents.

#### **1.6 — Business vs. Consumer Use**

The responses to the questions on business vs. consumer use yielded unexpected results. Contrary to conventional wisdom and some market surveys for electronic dissemination of information, we found that participants emphasized personal use more than professional use. If more financial information were added to the system, this situation may change.

#### **1.7 — Value of the Simplex and Duplex Modes**

Almost 75 percent of the users feel that the system is extremely valuable to them. Undoubtedly, users find their ability to filter and scan news stories the most attractive feature of the system. For the period of this report, the simplex mode of the system is more useful than the duplex mode, especially for personal use. However, the duplex mode has value for business and academic research.

#### **1.8 — Feelings Toward Commercial Extension**

When participants were asked if they would be interested in subscribing to a commercial service using the same technology, slightly over half expressed great interest. The participants stated that both the simplex and duplex modes are necessary for commercial success. They were concerned that the CommInS requires some degree of computer literacy, and they suggested changes in the user interface. At the present time, most users do not see the system having mass market appeal. Most importantly, the users report that the system must run in the background under a multi-tasking operating system before any serious commercial possibilities exist. However, once the technology is at an acceptable level, another factor must be taken into account: the cost-effective delivery of services to people. Ultimately, commercial success of the CommInS rests more on the information available than the technology per se.

On a willingness-to-pay basis, most users think that a successful commercial extension of the CommInS depends on proper pricing. Users insist the cost of the service must be comparable to the cost of a conventional newspaper subscription or the cost of one additional cable TV channel. For the simplex



## EXECUTIVE SUMMARY

mode alone, some 62 percent would pay no more than \$10 per month, while the addition of the duplex mode does not change their willingness to pay.

### 1.9 — Suggestions for Improvements

Six suggestions for improvements arise repeatedly from the users. First and foremost, users want the CommInS to run as a background task under a multi-tasking operating system. Some people using Double-DOS or DesqView with their computers have succeeded in this desire. Second, users want the PC software to detect and eliminate all but the most recent copy of a particular article, because the AP wire frequently repeats stories with incremental changes. Third, users do not like to have their computers running long hours due to noise, heat, or fear of damage to a hard disk, so many have suggested that the system have a "small black box" to accumulate stories instead of their PC. Fourth, many users think that the system needs to run on non-IBM or compatible computers for commercial acceptance. Fifth, users of the duplex mode want to access stories in the NYT database over 90 days old. Sixth, many users want to have longer filter lines or the ability to set "global" filter lines to include or to exclude certain types of information with a few keystrokes.

### 1.10 — Reasons for Loss of Interest

In March 1987, we sent "exit questionnaires" to approximately 90 former participants to discover why they lost interest in the system. About 50 percent of the former participants sent in responses to this special questionnaire, and the results show no apparent differences between the population of continuing users and the former participants. Three reasons account for most of the decisions to stop participating in the CommInS experiment. First, some people enrolled in the experiment realized that they live or work beyond the radius of effective reception; these people returned the equipment almost immediately. Second, some users balked at having to dedicate their PC to this purpose, and they returned the equipment after a period of trial and eventual decision. Third, quite a few participants have moved from the Boston area, so they returned the equipment before departing.

### 1.11 — Overview

At the end of the period of this report, over 170 people had the CommInS system in regular use. Over 75 percent of the respondents report that they feel better informed with the system, and some — especially researchers and visually impaired users — have made the system an integral part of their daily lives.

Finally, the participants have demonstrated continuing commitment to the experiment by returning monthly questionnaires. We salute and thank the many people who have contributed their time, energy, and good ideas to make this CommInS experiment a success!

## Section 2 — Experimental Overview

This report describes the first 14 months of a two year experimental test of the Boston Community Information System. The experimental period covered by this report is from December 1985 to January 1987. A subsequent report will cover the test period February 1987 to January 1988.

In this section, we provide an overview of the history and technology of the Boston Community Information System to put the experimental data in the rest of the report in perspective. We also discuss the factors we designed this experiment to test, and the limits of the experimental controls we could apply to guard against external factors.

We have tried to present the experimental data in a way that invokes the interest of both computer system designers and non-expert readers. We hope computer system designers will gain from this report an understanding of the strengths and limitations of the technology we have developed, and we hope non-expert readers will see in the data we present the potential for a new type of information service.

### 2.1 — A New Information System Technology

The overall goal of the Boston Community Information System project is to explore a new type of computer system architecture capable of providing sophisticated information services to every home and office in a city of perhaps a million people. As part of the project we have designed and implemented a system that addresses this goal, and tested it on a sample population in the Boston area.

We are interested in metropolitan area information systems because we believe, in the future, computers will be the basis of a new mass communication medium far more powerful and important than the telephone. Computers have the intrinsic ability to autonomously react to incoming information, which will permit computers to become an active medium as opposed to a passive medium, such as the telephone. For example, computers will be prepared to inform us of important external events, or to take direct action based upon such events according to our preprogrammed instructions.

In order to explore the potential of computers as a communication medium, we started the Boston CommInS project in September of 1982. The central focus of the project was the idea to use both digital broadcast for mass data communication and duplex communication in a single, unified framework. The thought was that this single framework would integrate the cost advantages of digital broadcast with the flexibility of duplex communication.

During late 1982 and early 1983, we worked out the design of an initial system; and once the design was completed in early 1983, we implemented a prototype. This prototype was operational at a site outside of our own research group in April 1984, and a small initial test population of 15 users was established.

Based upon the experience with this prototype, the system was largely reimplemented during late 1984 and early 1985 to prepare it for a larger scale user test. The initial digital radio channel was replaced with a more reliable design, and the software was enhanced to provide new services.

In 1985, we formulated a plan for a two year test of the Boston Community Information System at approximately 200 local area homes and businesses. This report describes the results of the first 14 months of the resulting experimental test. The test started on December 17th, 1985 with Version 6.0 of the system distributing data, via broadcast at 4.8Kbit/sec, to personal databases. On October 7, 1986, users received Version 8.17 of the system. In Version 8.17, queries that cannot be processed at a user's personal computer are automatically forwarded, via modem, to MIT for processing.

## 2.2 — The Boston CommInS Technology

The Boston Community Information System technology is based upon the idea of building a single large system out of a loose confederation of independent, smaller systems. Within this framework, we provide each user with a personal database system that can locally process the user's most frequent requests. These personal databases are kept up to date by transmitting new data to the personal systems via a broadcast channel. Each personal database system listens to all of the data transmitted, and based upon a user specified filter, it saves certain parts of the broadcast transmissions. If a query cannot be processed by a personal database system, the request is automatically routed to a central database that can process the query. Database *content labels* are used to identify the contents of a database and to properly route a request to a database capable of processing it.

Figure 2-1 shows a schematic diagram of the Boston Community Information System. The shared servers in the figure are located at the Laboratory for Computer Science at MIT. Each server contains one or more independent databases, unified by a query routing module. Some databases are replicated on more than one server in order to improve reliability and performance. When the shared servers receive new information, that information is immediately scheduled for transmission to the personal systems via a broadcast packet radio system. The database item's type dictates the number of times the item is transmitted, and the way that item is protected. The personal systems receive the broadcast transmissions and a background task uses these transmissions to update a local database. A user specified filter selects from the broadcast transmissions the data to be saved in a personal computer's database. When a request can not be processed at the personal computer's database, a connection is automatically established to an appropriate shared server.

The reader interested in the design of the system should consult [Gifford85a] and [Gifford85b]. The user reference manual for Version 6.0 of the system is [Lucassen86]; for Version 8.17 it is [Segal86].

## 2.3 — Experimental Design

The experimental test of the Boston CommInS was primarily designed to answer the fundamental question, *Is the information system technology that we have developed useful?* In order to address this question, we performed a longitudinal study on the use of the system by 200 people who were outside of our own research group.

The experimental test of the system was performed on a self-selected population of computer literate volunteers. In order to simplify the test, subjects were required to own or have access to an IBM Personal Computer. Test participants were drawn from three major populations: MIT affiliates, Boston Computer Society members, and miscellaneous people. Participants were recruited via advertisements in the MIT paper *Tech Talk*, a mailing to all MIT computer science professors, announcements at the IBM PC users group of the Boston Computer Society, notices in Boston Computer Society publications, and by asking existing participants to recruit new participants.

Participants were given the system for free. However, each participant was obligated to complete and return a two page questionnaire that we mailed out each month. With the questionnaire, we sent a one page newsletter and a postage paid return envelope. At the onset of the experiment, we told participants that they would have to return the Boston CommInS system loaned to them if they failed to complete and return their questionnaire each month. To reinforce this stipulation, each participant signed a legal agreement to this end when they joined the experiment, along with a statement that they would not redistribute information received via the experiment. Every month, telephone calls were made to participants that had not sent in their questionnaires for the prior two months. As the experimental data show, some of these users returned their systems and some began to mail in the questionnaires again.

Monthly questionnaires consisted of short answer questions and an essay topic. The short answer questions were designed to focus on particular content, technology, or overall system issues. The essay topics were designed for evaluations and opinions on a wide variety of qualitative issues. All questionnaire responses are confidential.

We designed the questionnaires to separate participants' reactions to the information provided via the system from their reactions to the technology we have developed. Our experimental results show that people were largely pleased with the information provided via the system. Therefore, we believe that the experimental results on the technology aspects of the system do not reflect unhappiness with the content the system provides.

In summary, we have tried to produce, within certain constraints, a fair test of the technology we have developed. The next section presents an overview of the major conclusions we have reached based upon data from the experimental test.

#### 2.4 — References

[Lucassen86] Lucassen, J., et. al, "Boston Community Information System User's Manual (Version 6.0)", MIT/LCS/TR-352, MIT Laboratory for Computer Science, April 1986.

[Gifford85a] Gifford, D., et. al, The Application of Digital Broadcast Communication to Large Scale Information Systems, IEEE Trans. on Selected Areas in Comm. SAC-3, 3 (May 1985), pp. 457-467.

[Gifford85b] Gifford, D., et. al, An Architecture for Large Scale Information Systems, Proc. of the 10th ACM Symp. on Operating System Principles, ACM Operating Systems Review 19, 5, pp. 161-170.

[Segal86] Segal, D., et. al, "Boston Community Information System User's Manual (Version 8.17)", MIT/LCS/TR-373, MIT Laboratory for Computer Science, September 1986.

EXPERIMENTAL OVERVIEW

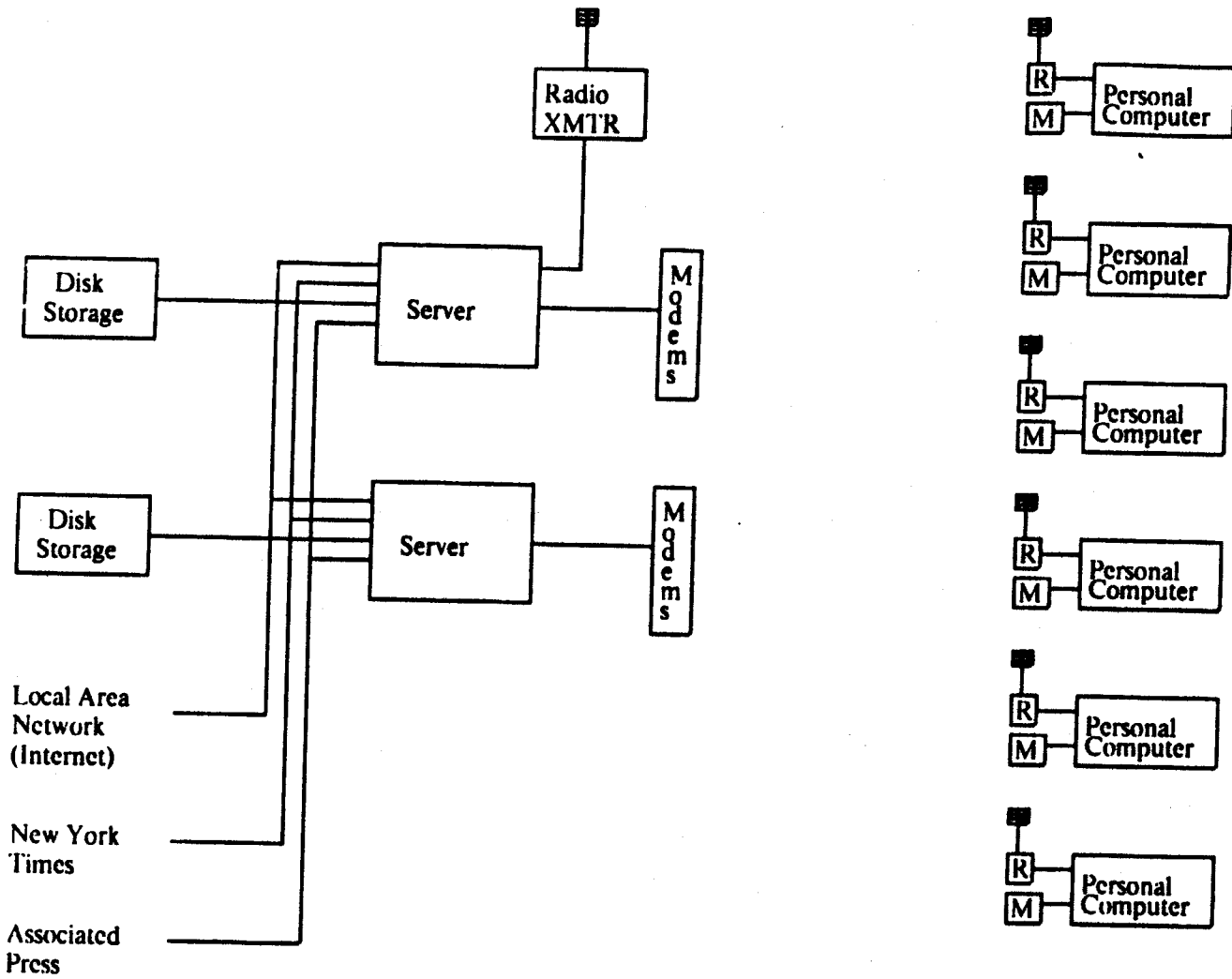

Figure 2-1: Boston CommInS System Block Diagram

## Section 3 — Analysis of Data

Questionnaires were distributed on a monthly basis to all participants in the Boston CommInS experimental test. Certain questions were asked several times throughout the year to explore variations in time. The majority of the responses received, however, did not depend on how long the participant had been using the system. This section focuses on eleven major themes in the experimental data:

- the user profile population
- statistics on system use
- changes in participants' news habits
- types of information participants want and do not want
- business vs. consumer use
- how valuable participants find the broadcast and two-way parts
- participants' feelings toward commercial extension
- how much participants are willing to pay for the system
- suggestions for changes and extensions to the Boston CommInS
- why some participants lose interest in the system
- profile of people who lose interest in the system

### 3.1 — User Population Profile

Figure 3-1, at the end of this chapter, shows the number of participants in the Boston CommInS project on a monthly basis.

The individuals currently using the system are predominantly male, ranging in age from twenty to forty. Over half of the participants in the project are affiliated in some manner with the Massachusetts Institute of Technology. The vast majority of system users have some experience with personal computers, with only 10% of the population considered computer novices with less than one year of PC experience.

#### Statistics on the User Population (N=148)

Sex:

- 85% male
- 15% female

Age:

- 4% under twenty
- 28% in twenties
- 39% in thirties
- 19% in forties
- 10% over fifty

PC Experience:

- 10% less than 1 year
- 61% 1 to 5 years
- 29% over 5 years

The professional range of the users is diverse. The groups represented the strongest are students and professors. The professional profile of the current participants of the Boston CommInS is as follows:

## ANALYSIS OF DATA

- 22% students
- 21% professors
- 15% hardware or software engineers
- 9% administrators
- 6% research scientists
- 4% physicians
- 3% librarians

The remaining 20% of the population is comprised of teachers, physicists, information specialists, a television producer, a consultant, an army officer, a landlord, a publisher, an architect, a mathematician, a journalist, a political scientist, a psychologist, and an archeologist.

While the responses the participants have given on the monthly questionnaires have proven to be an invaluable source of information for researching the trends and needs of information system users, it must be remembered the sample population we have chosen represents a specific group of individuals, not the mass populace. As mentioned before, our users tend to be professionally trained, computer literate males. Over 50% of the participants are affiliated with MIT, which implies some degree of technical orientation. The responses these individuals give may differ vastly from responses that would be given by broader segments of the population.

### 3.2 — Daily System Use

Figures 3-2 and 3-3, at the end of this chapter, illustrate that the participants, on the average, use the system for 20 to 30 minutes per day, 10 minutes of which is spent carefully reading news articles. Figure 3-4 shows that participants have the Boston CommInS running, on average, about 7 hours per day with a median use of about 5 hours. The following conclusions have been drawn based on the responses from the questionnaires.

*Individuals prefer highly polished, edited news stories  
to up-to-the-minute, unformatted articles*

Results from the questionnaires indicate that although both the New York Times and the Associated Press wire services are widely utilized, users perceive the New York Times as the more valuable service. On the average, users read more full articles from the NYT than from the Associated Press.

As stated in the Boston Community Information System User's Manual: "The New York Times and AP databases are founded on different philosophies. The New York Times provides highly polished and readable news stories, corresponding to the printed version of the New York Times. Developing news stories are usually updated once a day by their editors. The AP service, on the other hand, provides up-to-the-minute reports on breaking news stories, as well as corrections, updates, and occasional retractions of previous stories."

*Individuals prefer keystroke processing to menu driven techniques.*

Slightly over two-thirds of the participants found the software easy to use. Less than 10% found it difficult. The system offers the option of using menus or keystroke equivalents. Many might expect the participants to use menus until they become acclimated to the system, at which time they would switch to the keystroke equivalents. This, however, was not the case. The vast majority of the participants preferred using keystroke equivalents right from the start.

*Filter lists provide users with a flexibility that permits them to access a wide range of interests.*

On the average, a user's filter contains approximately thirty-two lines. During the months when new systems were distributed, this number dropped slightly, probably due to the time it takes a participant to become accustomed to the system. Participants altered the lines in their filters on an average of once a week.

The variety in filter lists reflects the wide range of interests of the participants in the Boston CommInS. The questionnaire results showed a large interest in major corporations such as IBM, Digital Equipment, Data General, Wang, Honeywell, TRW, Raytheon, Data General, and Atari. Another major focus was on international news concerning the Soviet Union, the Middle East, Central America, South Africa, and the Philippines. In February 1986, entries such as "space shuttle", "challenger", and "nasa" dominated the filter lists, and in April 1986, there was wide interest in Libya and Khadafi.

The "newssummary" and entries concerning computing, the Strategic Defense Initiative, Wall Street, weather, movie reviews, MIT, Harvard, and the disease aids are commonly found on filter lists. Not as common of an entry, but commanding at least some interest is "subject: sex/romance/dating."

### 3.3 — Changes In Participants' News Habits

*Electronic publishing is not a substitute for the newspaper;  
it is a supplement.*

Approximately 75% of the participants feel that as users of the Boston Community Information System they are better informed now than before they had access to the system. The remainder of the user population reported that they felt no change in their breadth of knowledge due to the use of the system. The average user liked to use the newspaper and the Boston CommInS to supplement one another, thereby supporting the belief that electronic newspaper publishing will not be a substitute for the conventional newspaper. Reasons for this hypothesis are that newspapers have browsing capabilities not shared by systems such as the Boston CommInS and, in addition, newspapers are very transportable. They have headlines and page placements to aid the reader. Newspapers are also passive unlike their electronic counterparts. For the general population with modest needs, there is not an overwhelming desire to switch from paper to screen. Just as television complemented radio, electronic news will probably complement the conventional newspaper.

*Electronic services are preferred to newspapers for gathering specific information. However, the conventional newspaper is still the predominant information source when it comes to browsing or looking for general information.*

When looking for specific information, the majority of the participants, as expected, preferred using the system to the newspaper. The reasons for this are apparent: the system offers a way of filtering out unwanted information and hones in on relevant articles that apply to a specified topic. This eliminates the need to peruse an entire newspaper in search of a specific topic. On the other hand, our results showed that the newspaper is still the predominant information source when it comes to browsing or looking for general information. One reason for this is that a participant, when looking for general



## ANALYSIS OF DATA

information, may not have a predefined filter list in his/her mind. With the filter list, on which the individual's system is operating, the participant may feel as if he/she is missing out on something. For example, when the Challenger Space Shuttle exploded in early 1986, few participants probably had "the challenger" as an item in their filter until after the disaster occurred.

As the statistical data below show, the distinction between use of the Boston CommInS or newspaper for general information is not as great as the distinction between the two for specific information. This may be due to the fact that the Boston CommInS does have the ability to browse through articles captured by the filter list. However, the browsing capabilities are more limited than those in a conventional newspaper because miscellaneous items of interest not captured by the filter list cannot be scanned by the user. Having the "newssummary" in the filter list captures important general information which, as in the case of the Challenger disaster, can be further specified after it has been identified.

### Statistics on Participants' News Habits

- 50% use newspaper and Boston CommInS as supplements
- 30% prefer Boston CommInS as the predominant information source
- 20% prefer conventional newspaper as the predominant information source

When looking for specific information:

- 63% prefer Boston CommInS to newspapers
- 11% prefer conventional newspaper to Boston CommInS
- 26% express no preference

When looking for general information:

- 28% prefer Boston CommInS to newspapers
- 41% prefer conventional newspaper to Boston CommInS
- 31% express no preference

### **3.4 — Types of Information Participants Want and Do Not Want**

A major concern of electronic publishing systems such as the Boston CommInS is discovering the amount of importance the public places on graphics and photographs. Historically, systems that have tried to implement these features have failed because the participants did not want to pay the additional cost to have these features on-line. Text-only systems are significantly cheaper, but the question remains as to whether the general population will be satisfied with such systems.

The results from our questionnaires seem to indicate that the majority of the participants do not deem photographs or graphics as an absolute necessity. Only 22% of all participants said that they greatly missed the graphics, and only 12% of all participants greatly missed the photographs.

The participants expressed substantial interest in having more financial news and information on stocks made available on the system as well as schedules for movies, concerts, and plays in the local area. There was an overwhelming positive response to have the Wall Street Journal added to the system. Other paper suggestions included the Boston Globe, the Washington Post, and the Los Angeles Times. Many suggested having professional journals or at least their tables of contents available on the Boston CommInS. The most requested journals were Byte and a variety of other personal computer magazines such as the Harvard Business Review, Science, Scientific American, New England Journal of Medicine, and American Political Science Review. Once again, the profile of the sample population must be remembered since their requests may not, and probably would not, be indicative of the whole population.

Reactions to adding a classified ads section to the Boston CommInS were mixed. Approximately 40% of

the participants expressed a strong interest in classified ads, while almost the same number were not interested. Suggestions for such a section included that participants be able to create and submit their own advertisements, that an option be made available so that participants could filter out all classified ads regardless of word matches, and that ads be categorized not only by item but also by selling location.

A portion of the population said that they would like the ability to communicate with other Boston CommInS participants. Suggestions included electronic mail or an electronic bulletin board.

### 3.5 — Business vs. Consumer Use

The responses from the questions on business vs. consumer use yielded unexpected results. Market trends in electronic information systems generally suggest professional users as the target population over residential users. In the Boston CommInS, however, personal use seemed to be emphasized more than professional use; 55% of those polled finding the system particularly useful for home or personal applications and only 45% finding the system useful for business or professional applications. A reason for this reversal could be that the Boston CommInS is still in its infancy as far as information offerings go. When the system is expanded to include profit-making news such as financial news and stock information, or expanded to become an in-depth research tool, professional use is expected to dominate.

#### Statistical Data on Business vs. Consumer Use

- 55% use Boston CommInS for both personal and professional use
- 33% use Boston CommInS primarily for personal use
- 12% use Boston CommInS primarily for professional use

### 3.6 — How Valuable Participants Find the Broadcast and Two-Way Parts

*The users perceive the ability to filter and scan news stories to be of great value.*

Almost three-quarters of the participants feel that the system is of great value to them as can be evidenced by Figure 3-5 at the end of this chapter. On a routine basis, participants reported that the single most valuable feature of the system was the ability to scan the filter elements and peruse the summaries to receive the latest breaking news stories.

*The broadcast part of the system is more useful than the two-way part especially in a personal environment. The two-way part, however, takes on an added value in a business or an academic environment.*

While the majority of the participants feel that the two-way service is a complement to the system, over 80% of those polled said that they hardly ever used it. A partial explanation for the low utilization of this service is that almost one-third of the system users do not own the modems necessary for establishing the communications link. Many of the participants said that they were planning to try the remote portion sometime in the near future. When Figure 3-6 is compared to Figure 3-2, the dramatic difference between one-way and two-way use can readily be seen.

Many feel that the broadcast part of the system is more useful than the two-way on a day-to-day basis. However, remote access is convenient for obtaining specific queries not anticipated when the filter was

created. The users felt that the two-way portion would be more essential in a business or academic environment, where it could best be utilized as a research tool to gather background information on specific topics or to track specific stories, rather than in a personal environment. Interest was expressed at having a retrieval period greater than 90 days and of possibly extending the two-way system to include the AP service. There was a fair degree of concern over tying up the telephone line and over the filter line being too short to narrowly define a topic.

### 3.7 — Participants' Feelings Toward Commercial Extension

*Both the broadcast and the two-way portions of the system are necessary for commercial success.*

When participants were asked if they would be interested in subscribing to a commercial service using this technology at the end of this experiment, slightly over half replied that they would be very interested in doing so. Approximately 20% expressed little interest, and the remainder of the participants were undecided. Although the response to buying only a partial subscription was mixed, participants said the categories they would be most likely to subscribe to would be urgent and major news, weather, and financial news. A large number said the category they would be least likely to subscribe to would be sports. Many felt that an offering of both the broadcast and the two-way portions of the system would be essential for commercial success. They suggested that the remote part be an option at a slightly higher charge than the broadcast part alone.

*Use of the system requires a certain degree of computer literacy.*

The participants expressed concern over the need to have a certain degree of computer literacy to be proficient at using the system. According to the participants, commercial success of the system depends on the following revisions: improving the user interface, running the system in the background, and devising a mechanism which saves only the latest version of an article. They felt strongly about keeping the price of subscribing to such a system comparable to the price of a newspaper subscription. Also, participants believed additional benefits could be derived by extending the system to non-IBM compatible computers.

*Success of systems such as the Boston CommInS depends on identifying market needs and not on the technology itself.*

Some participants used phrases such as "useful, but not essential," "nice, but a luxury," "not indispensable," and "a novelty" to describe the system. These comments reflect the fact that although the technology has potential, the information content must be altered to attract users and to fit a real need. The system, as it stands now, is not a replacement for existing information sources; it is a supplement. As one user said, "The Boston CommInS won't soon displace the newspaper for the average user, but with an expanded range of services, it might find an expanding niche amongst those with computers, modems, and the willingness to try something new."

*The target population of systems like the Boston CommInS should be various segments of the population, not the mass.*

The consensus among the participants was that the product should be aimed towards specific interest groups rather than the mass audience. In general, it was felt that the most promising subscribers would be professionals. Suggested factions worth targeting included groups with high PC literacy, financial markets, school systems, journalists, researchers and industry associates. It was also suggested that the handicapped, such as those who are visually impaired, might have specific use for a modified version of the system.

### 3.8 — How Much Participants Are Willing to Pay for the System

*Cost of a system such as the Boston CommInS must be comparable to that of a conventional newspaper.*

Almost 70% of the participants would opt for paying a flat fee for use of the system as opposed to a usage sensitive rate. Most felt that the monthly cost of the system would have to be comparable to that of a conventional newspaper. When asked how much they would be willing to pay for a broadcast or a combined two-way system, the price differential between the two options was narrow as can be seen in Figures 3-7 and 3-8 at the end of this chapter.

For the broadcast system only:

- 31% would pay no more than \$5 per month
- 32% would pay between \$5 and \$10 per month
- 30% would pay between \$10 and \$20 per month
- 7% would pay more than \$20 per month

For the combined two-way system:

- 26% would pay no more than \$5 per month
- 34% would pay between \$5 and \$10 per month
- 32% would pay between \$10 and \$20 per month
- 8% would pay more than \$20 per month

For the present system, but with only AP stories, the average subscription fee was reported to be \$7.50. For the present system, but with only the New York Times, participants were willing to pay \$9.50. For a "black box" that would allow the participants to receive the news with their computers turned off, they were willing to pay a one time price averaging around \$100. Most participants would be willing to pay slightly more, if they could run other programs concurrently with the Boston CommInS.

### 3.9 — Suggestions for Changes and Extensions to the Boston CommInS

There were six major suggestions for improving the Boston Community Information System:

- run system in background mode
- eliminate duplicate articles
- design a "black box" so computer doesn't always have to be running
- expand to more than IBM and IBM compatible computers
- have remote system retrieve further back than 90 days
- increase allowable length of filter lines

Other suggestions include the addition of an "undelete" key, global filters that would eliminate topics of no interest to a specific user, an improved user interface, and the addition of an electronic mailbox.

Participants listed the inability to run the system in background mode as a major drawback of the Boston CommInS. Many felt they could not afford to dedicate an entire PC to gathering information. A majority of the participants' personal computers are located in their workplaces where they have to use the Boston CommInS in conjunction with their daily work activities. Receiving duplicate articles was also a major complaint about the system. Participants suggested developing a filtering technique at the user's computer that would flush out duplicate articles and minor variants of the same story, leaving only the most updated version. Also, users were reluctant to leave the computer on 24 hours a day to receive the news. They feared the constant accessing of the disk would cause a failure.

### **3.10 — Why Some Participants Lose Interest in the System**

In March 1987, a questionnaire was sent out to participants in the Boston CommInS project who had dropped out of the experiment for one reason or another. Approximately 90 questionnaires were sent out with a return of about 50%. Some reasons participants gave for their loss of interest in the system are listed below.

There appears to be three major reasons why some participants lose interest and discontinue use of the Boston CommInS:

- poor reception of radio signal
- requirement to dedicate the computer during use
- moving from the Boston area

Other reasons include:

- lack of time
- incompatible personal computers
- computer being too noisy to sleep through
- fear that constant accessing of the disk would cause an eventual failure
- not being able to easily avoid capturing minor variants of the same story
- not being able to take the PC where the newspapers are normally read

### **3.11 — Profile of People Who Lose Interest in the System**

The profile of the former participants does not differ that much from the current user population. A few apparent distinctions explain why some participants have decided to discontinue use of the system. The majority of the former users were again predominantly computer literate males, and over 50% of the former participants were affiliated with MIT. The reasons why people leave the Boston CommInS can best be seen in the section above rather than by analyzing personal traits for which there seems to be no direct correlation. Figure 3-9, at the end of this chapter, shows the number of months former participants used the system prior to returning it.

#### Statistics on Former User Population

Sex:

- 89% male
- 11% female

Age:

- 2% under twenty
- 36% in twenties

- 34% in thirties
- 19% in forties
- 9% over fifty

PC Experience:

- 9% less than 1 year
- 67% 1 to 5 years
- 24% over 5 years

Once again, the academic sector represented a large portion of the population. Former participants categorized themselves as belonging to the following occupational groups:

- 23% students
- 19% hardware or software engineers
- 17% professors
- 13% administrators
- 6% consultants
- 4% physicians
- 3% lawyers
- 3% research scientists
- 3% political scientists

Other occupations represented by the former participants included librarians, financial analysts, chemists, photographers, accountants, and technical writers.

ANALYSIS OF DATA

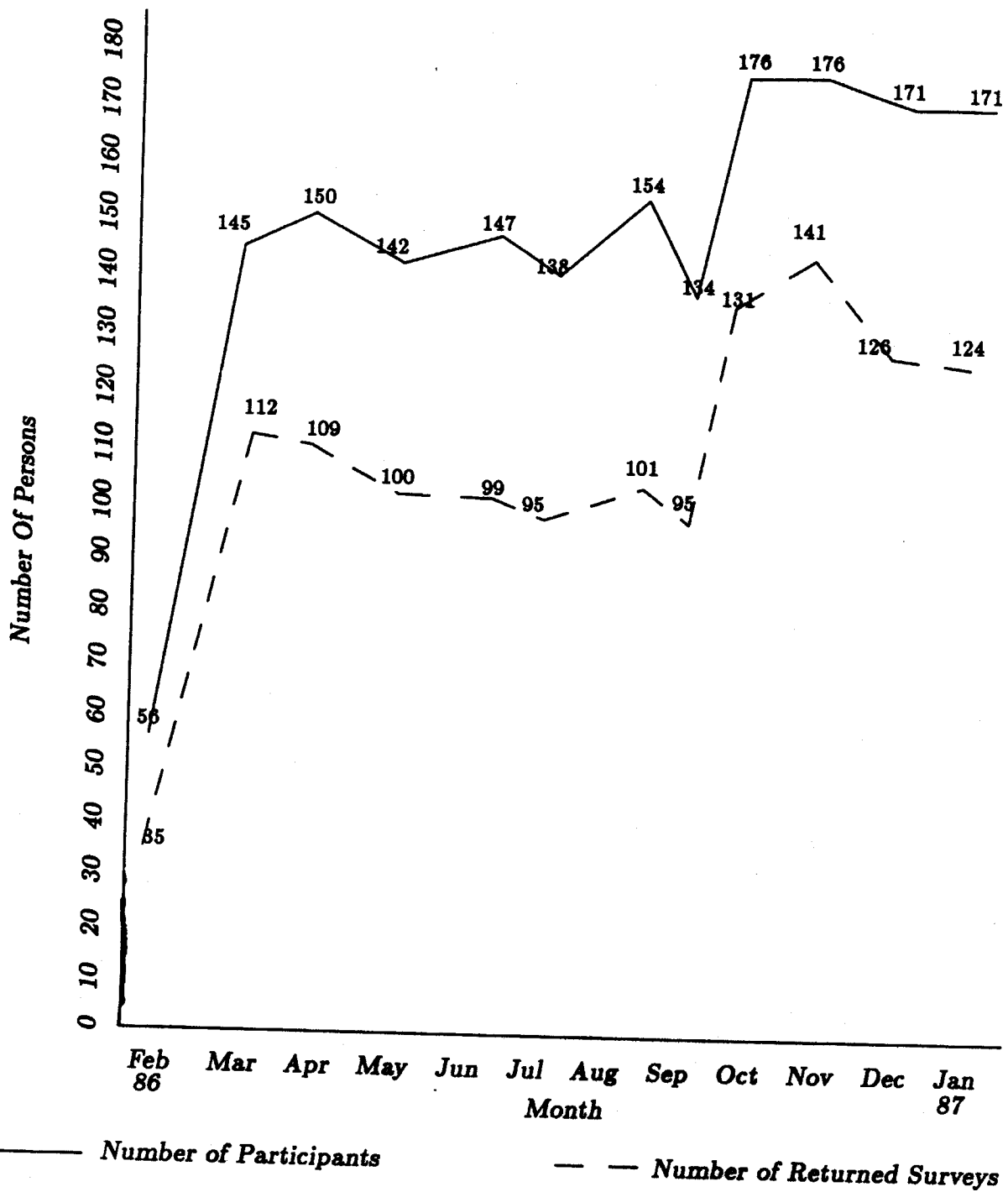

This graph shows the total user population of the Boston Community Information System. It also shows the total number of returned surveys in each given month.

Figure 3-1: The Boston Community Information System User Population

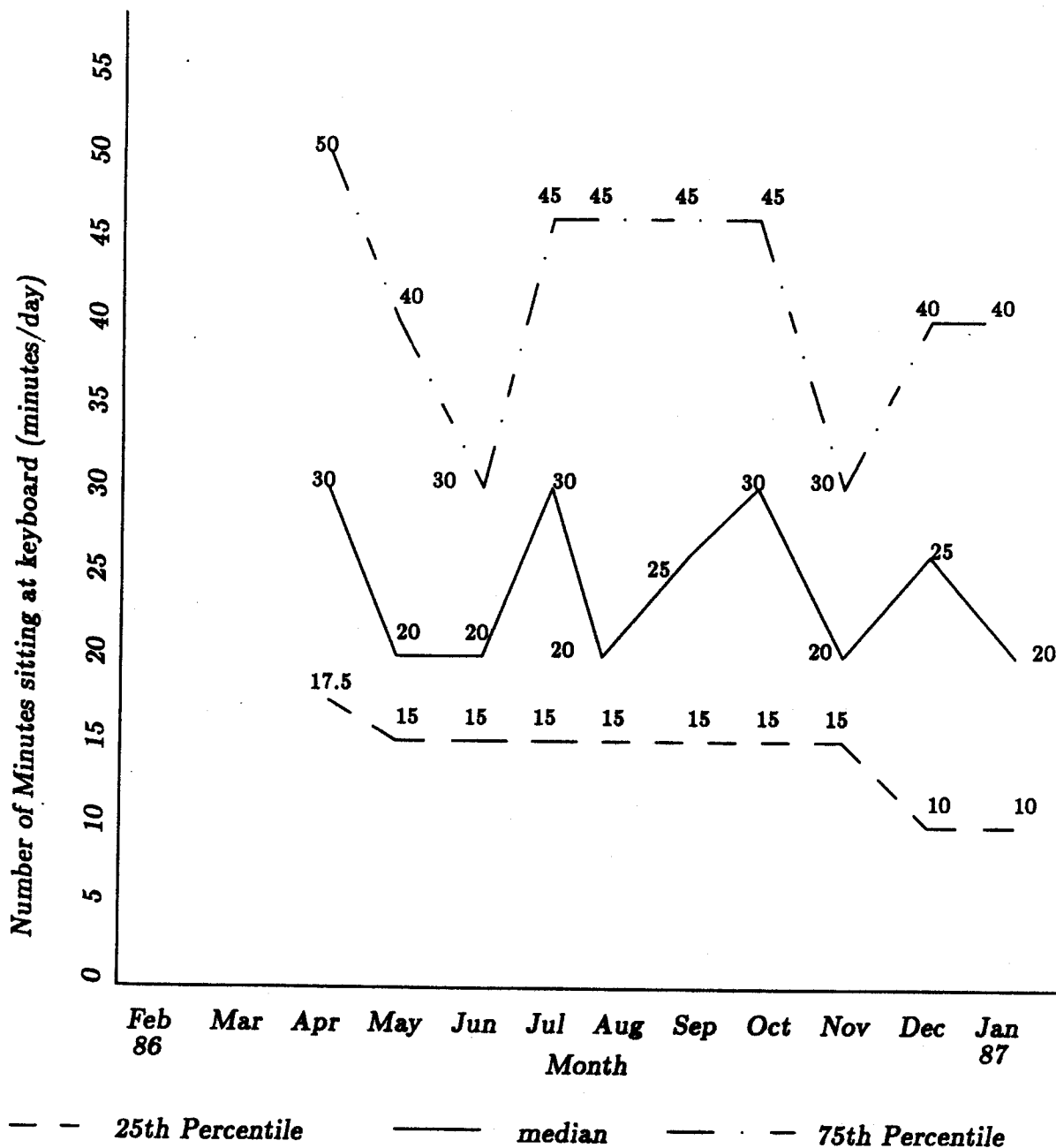

This graph displays the various percentiles of time users spend at their keyboards using the Boston Community Information System. It is based on the responses to question 81. [Note: This question was first asked in April of 1986.]

Figure 3-2: How Much Time Users Spend At Their Keyboard Using the BCIS



ANALYSIS OF DATA

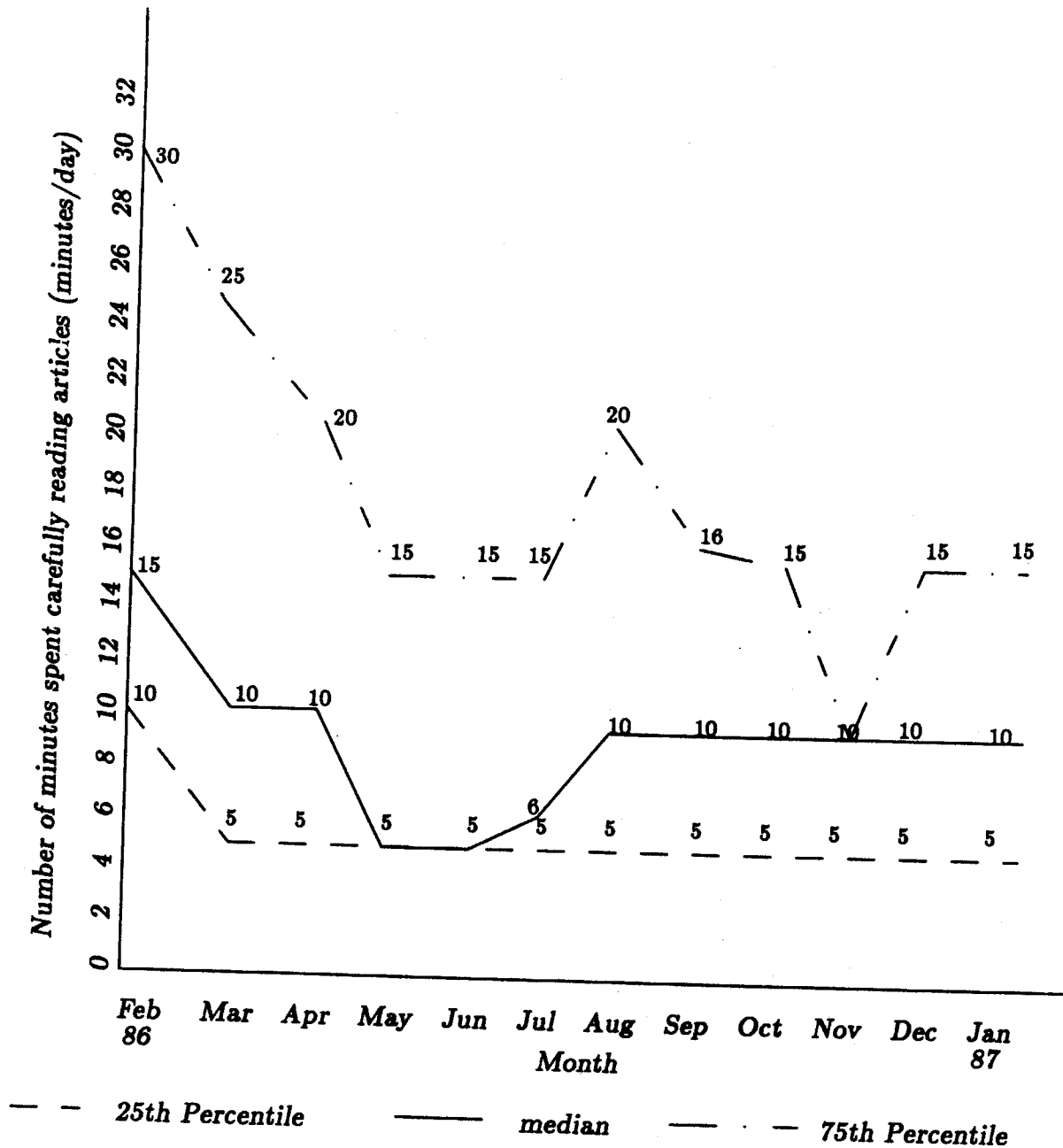

This graph plots the 25th, 50th, and 75th percentiles of the amount of minutes users reported that they carefully spent reading articles in each given month. This graph is based on the responses to question 47.

Figure 3-3: Number of Minutes Users Spend Carefully Reading Articles

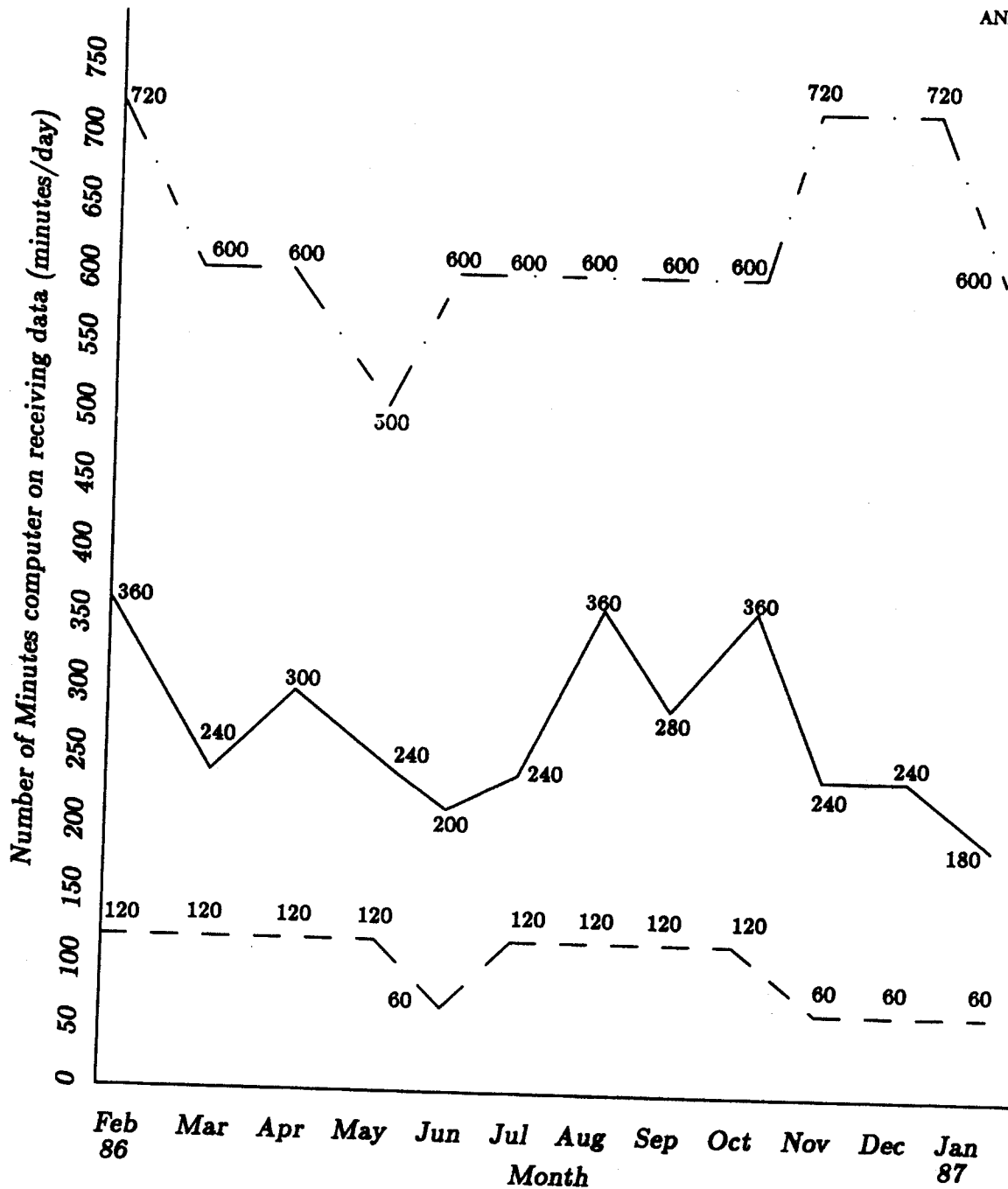

--- 25th Percentile      ——— median      - · - 75th Percentile

*This graph displays the percentiles of the number of minutes per day that users have their computers turned on receiving data. It is based on question 44.*

**Figure 3-4:** Number of Minutes Computer Receives Data via Radio Packet Receiver

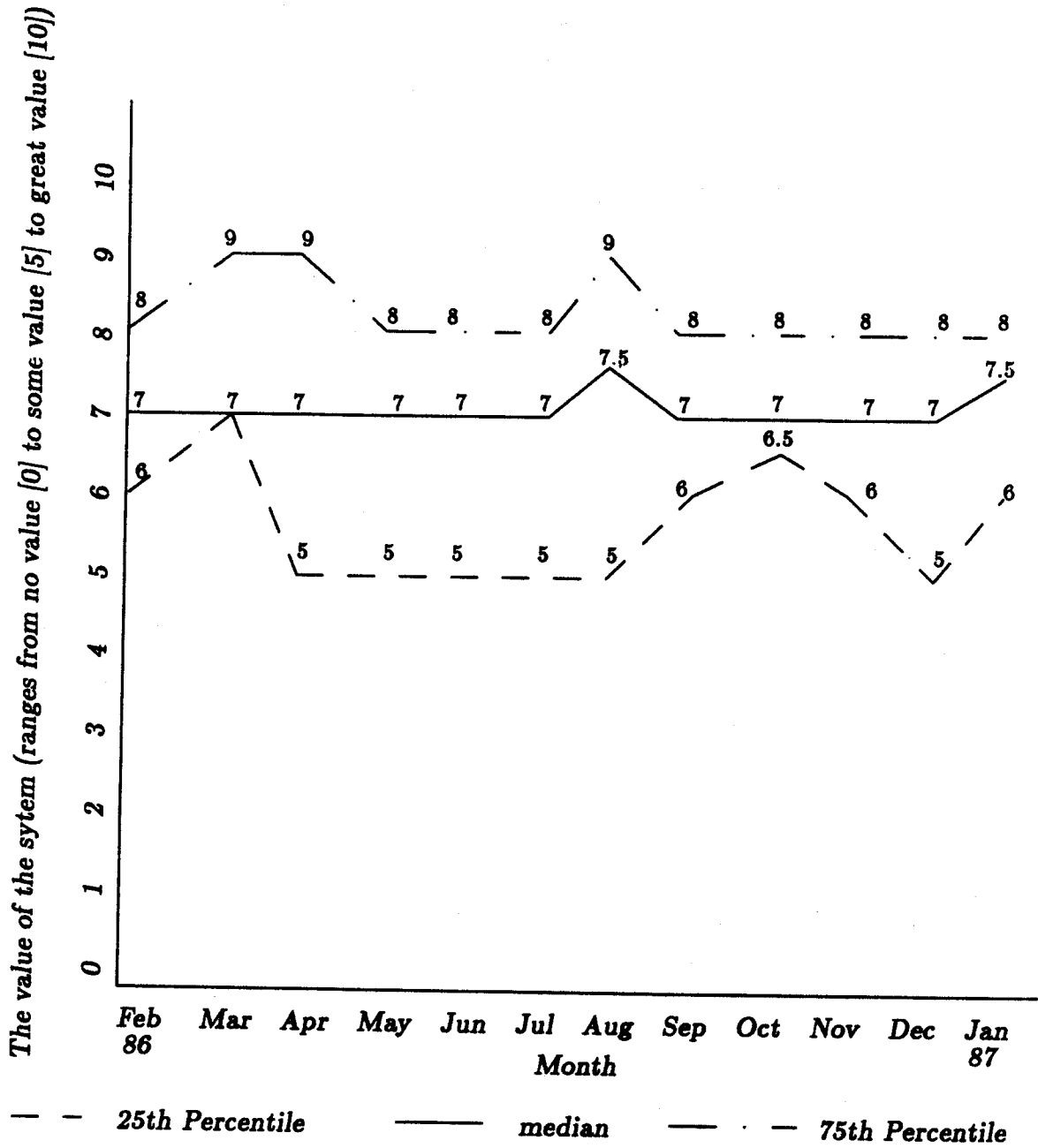

*This graph plots the various percentiles of the user perceived value of the system. They rated the value on a zero (0) to ten (10) scale. The graph is based on responses to question 70.*

**Figure 3-5: The Value of the System to the Users**

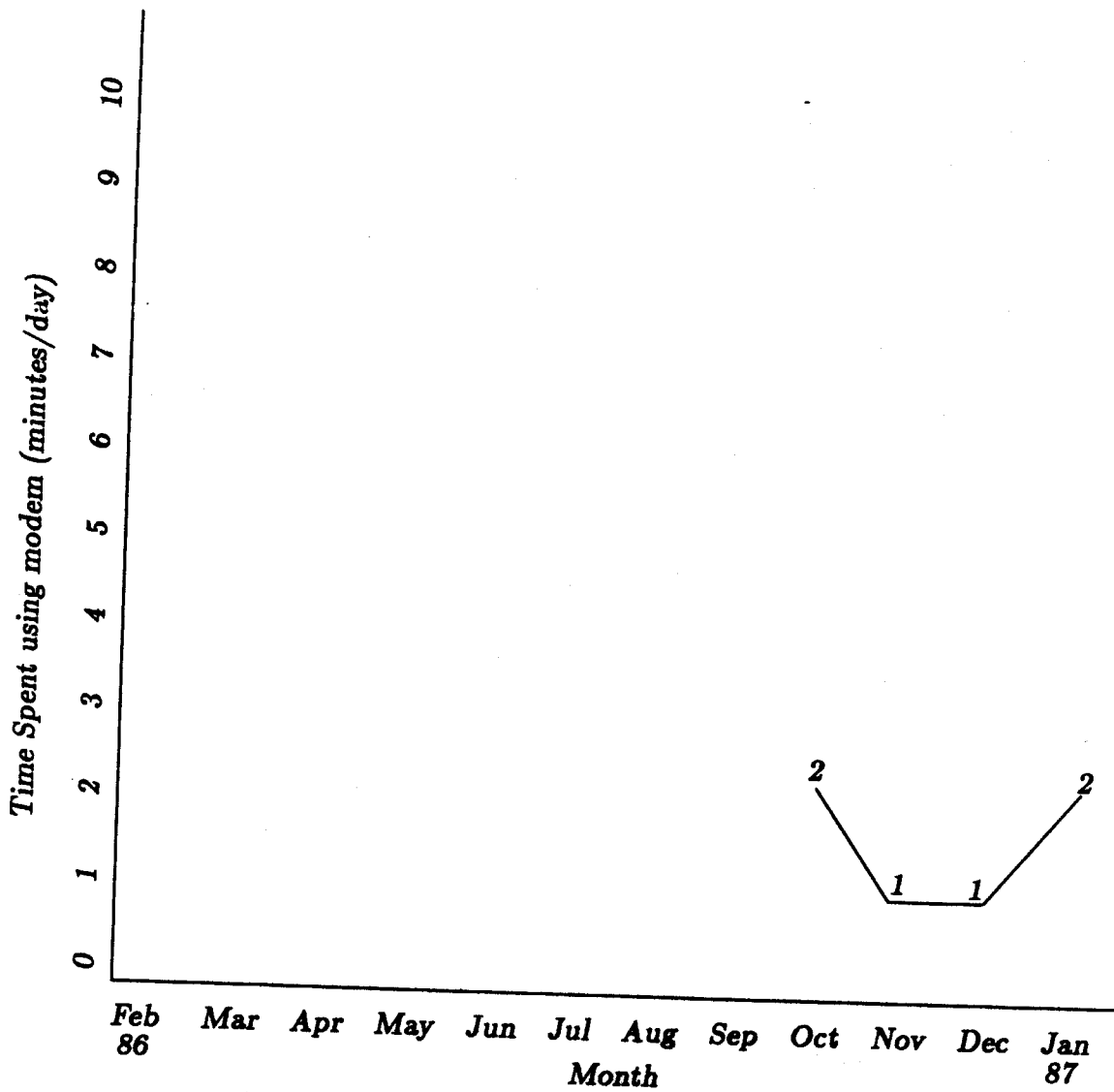

*This plot shows the 75th percentile cut-off of modem usage. The 25th and 50th percentile marks are zero. The data for this plot is from responses to question 130. [The duplex option was not available prior to October 1986]*

**Figure 3-6:** Use of the Duplex System

ANALYSIS OF DATA

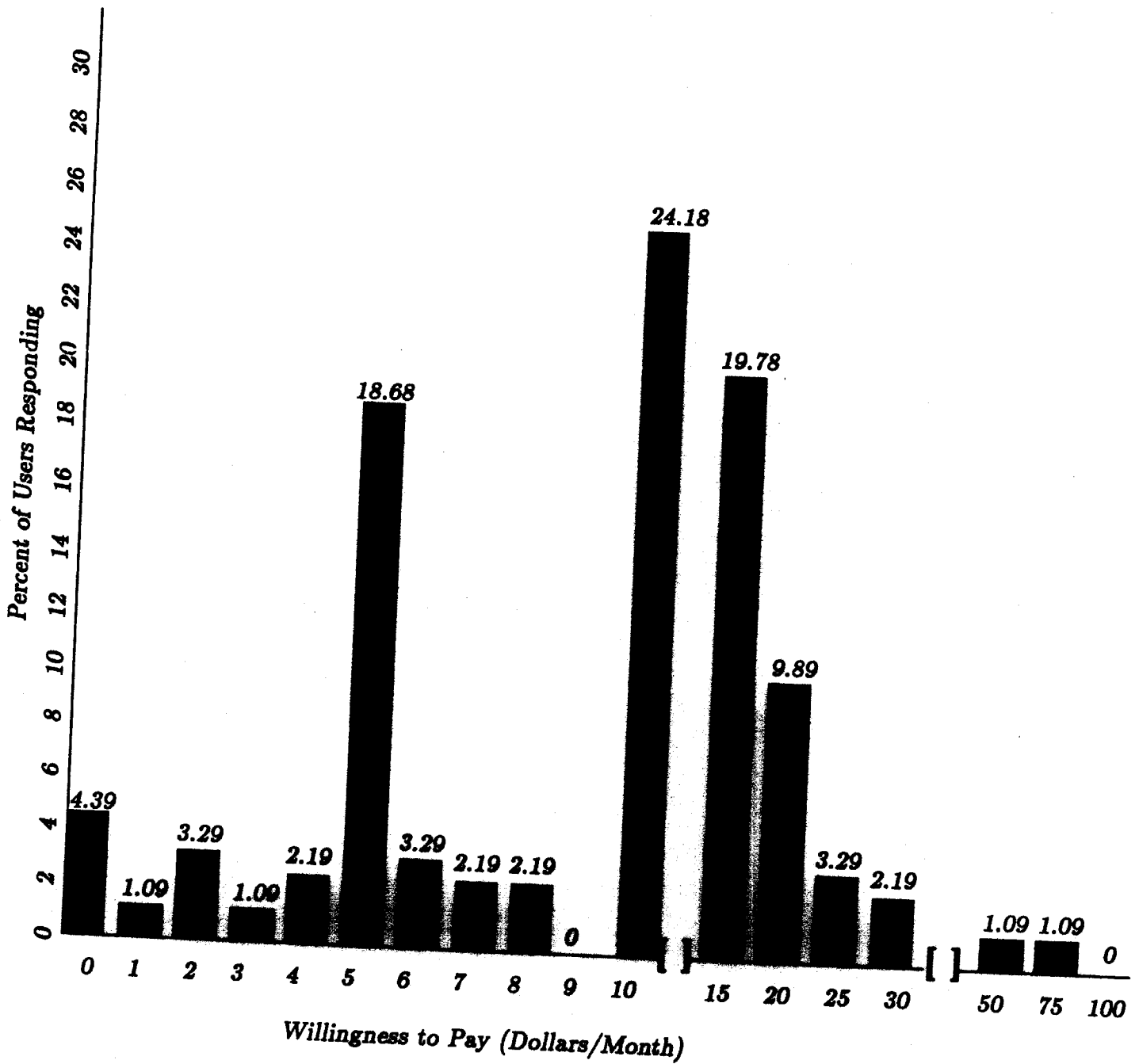

This plot is based on question 87 asked in May 1986. It shows the amount users would be willing to pay for the service "exactly as it is" per month vs. the percent of people answering the question with that price.

Figure 3-7: How Much Users Would Pay for One-way Service

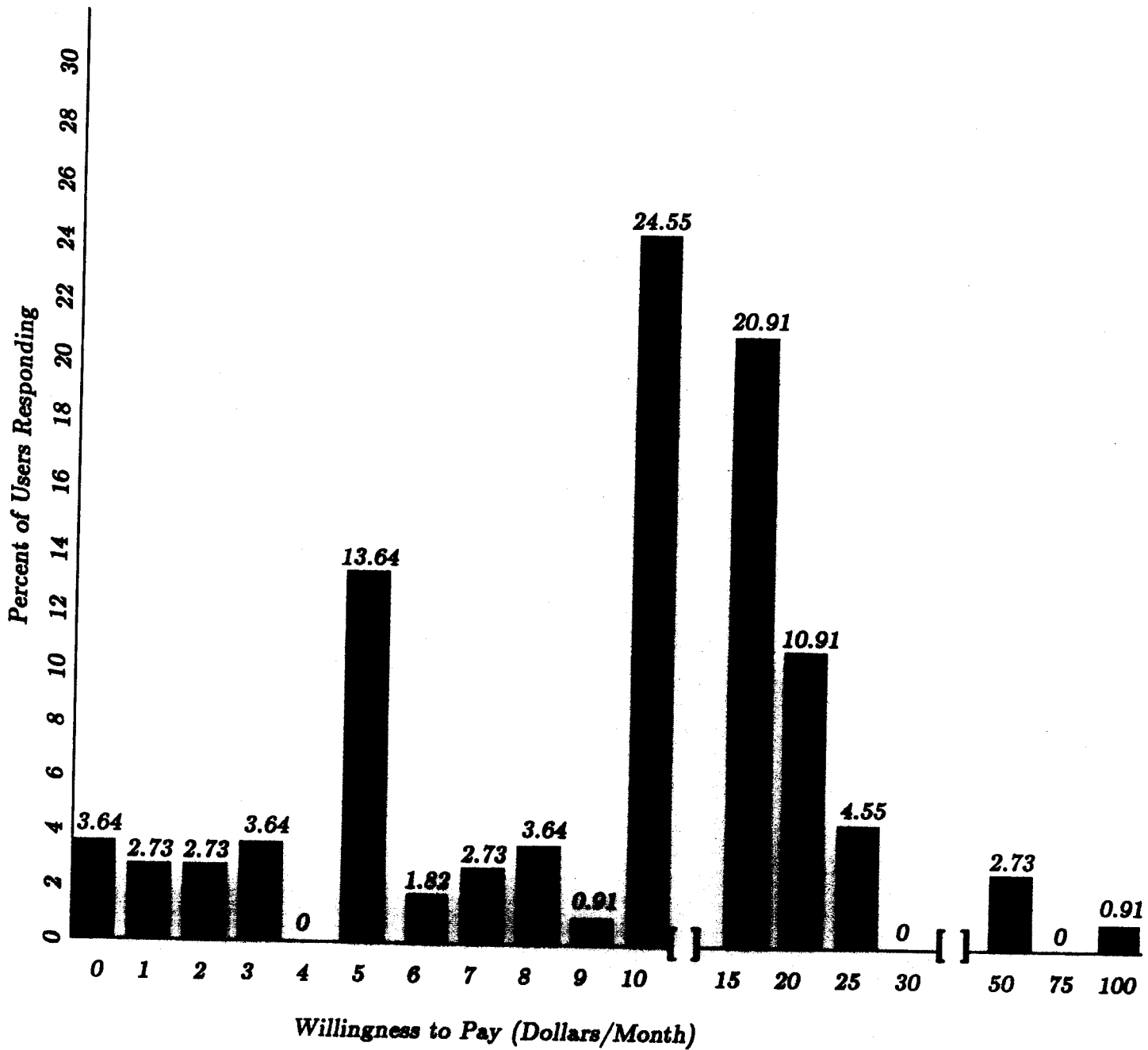

*This plot is based on question 87 asked in January 1987. It shows the amount users would be willing to pay for the service "exactly as it is" per month vs. the percent of people answering the question with that price.*

*In October 1986, the software adding the duplex feature was released.*

**Figure 3-8: How Much Users Would Pay for Two-way Service**

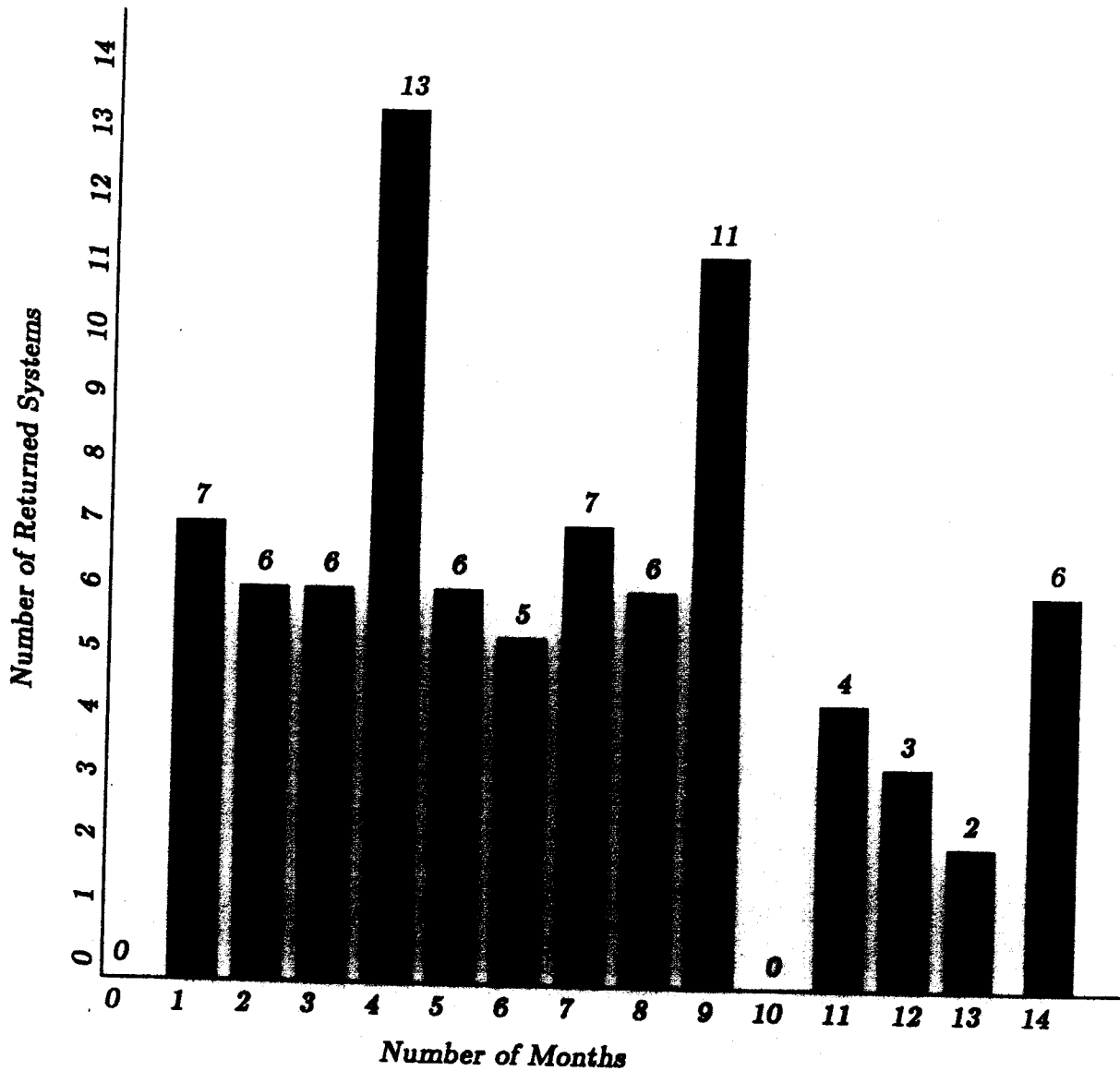

*This graph shows when users returned their systems. It plots the number of returned units vs. the number of months the user had the system prior to returning it to MIT. The data for this graph was prepared from the distribution and return date for each former user.*

**Figure 3-9:** Number of Months User Had System Prior to Returning It

## Section 4 — Primary Data from the First Year

This chapter presents the questions posed in the monthly questionnaires along with the responses we received from each user. To insure privacy each user is identified in this chapter by an unique serial number. The chapter is divided by months, starting with February 1986 and ending with January 1987. Each month is further divided between questions which required a numerical response and questions which required an essay response.

The questions requiring a numerical response are given as a question number and corresponding text. These questions are numbered so that the same or similar questions from month to month can be easily compared. The numbering does not correspond to a sequential ordering of each months questions, but rather a grouping of similar questions throughout the year. For instance, the following question appeared in most of the monthly questionnaires: My system has been operational \_\_\_ weeks. We can easily compare how the response to this question has changed over time because this question is numbered the same for every month. It is question 43. Note that the numbering each month does not necessarily start at 1, nor is it devoid of gaps.

An example of the format of numerical response questions in this chapter is:

43 My system has been operational \_\_\_ weeks

34	1.00	3.00	5.00	6.00	9.00	5.03
----	------	------	------	------	------	------

As the column headings in the chapter will show, the first column is the number of users who responded to the question. In this case, 34 users responded to this question this month. The second and sixth columns are the minimum and maximum responses received, 1.00 and 9.00 respectively in this example. The middle three columns are the 25th, 50th and 75th percentiles of the responses, shown here as 3.00, 5.00 and 6.00. The last column is the average response, which in this example is 5.03.

There is a second type of numerical question format. This format is for questions which use numbers to enumerate valid answers to the question. For instance, a typical question of this form is:

62 To use the commands, I mostly: Use the Menus [0] Use the Keystroke Equivalentents [1] Other [2]

[0]	52	[1]	49
-----	----	-----	----

The format for these questions lists each valid answer to the question and the number of users responding with that answer. Here we see that 52 users responded that they use the menus to execute commands and 49 users responded that they use the keystrokes to execute commands.



February 1986

Question  
# Text

Responses	Minimum	25th %tile	50th %tile	75th %tile	Maximum	Average
<b>43 My system has been operational ___ weeks</b>						
34	1.00	3.00	5.00	6.00	9.00	5.03
<b>44 Average time spent using Boston CommInS during last month : Computer Receiving Data from Boston CommInS ___ Minutes/Day</b>						
33	7.00	120.00	360.00	720.00	1440.00	556.24
<b>45 Average time spent using Boston CommInS during last month : Browsing Summaries caught by your Filter: ___ Minutes/Day</b>						
33	2.00	10.00	15.00	20.00	100.00	22.18
<b>46 Average time spent using Boston CommInS during last month : Browsing Full Articles caught by your Filter: ___ Minutes/Day</b>						
33	5.00	10.00	20.00	30.00	100.00	25.30
<b>47 Average time spent using Boston CommInS during last month : Reading Carefully Articles caught by your Filter: ___ Minutes/Day</b>						
32	2.00	10.00	15.00	30.00	100.00	22.22
<b>48 Average time spent using Boston CommInS during last month : Printing Articles caught by your Filter: ___ Minutes/Day</b>						
29	0.00	0.00	0.00	3.00	50.00	4.71
<b>49 Average number of articles found using Boston CommInS during the last month : Articles Caught: ___ Number/Day</b>						
33	15.00	30.00	50.00	70.00	500.00	83.39
<b>50 Average number of articles found using Boston CommInS during the last month : Summaries Browsed: ___ Number/Day</b>						
33	2.00	15.00	30.00	70.00	210.00	56.52
<b>51 Average number of articles found using Boston CommInS during the last month : Articles Browsed: ___ Number/Day</b>						
32	5.00	10.00	20.00	25.00	75.00	21.52
<b>52 Average number of articles found using Boston CommInS during the last month : Articles Read Carefully: ___ Number/Day</b>						
32	.50	4.00	10.00	15.00	70.00	14.20
<b>53 Average number of articles found using Boston CommInS during the last month : Articles Printed: ___ Number/Day</b>						
30	0.00	0.00	0.00	1.00	78.00	4.52
<b>55 I find that the information available is of: little interest--great interest</b>						
32	3.00	6.00	7.00	8.00	10.00	7.16
<b>56 I use the system for: personal use--both--professional use</b>						
34	0.00	3.00	5.00	5.00	10.00	4.68
<b>57 For important news, I rely on the system: not at all--some--exclusively</b>						
33	0.00	2.00	5.00	7.00	8.00	4.79
<b>58 On the system, I use the summaries: not at all--some--very much</b>						
34	3.00	5.00	8.00	9.00	10.00	7.35

PRIMARY DATA FROM THE FIRST YEAR

59	On the system, I miss the photographs: not at all--some--very much	34	0.00	0.00	1.00	5.00	8.00	2.47
60	On the system, I miss the advertisements: not at all--some--very much	34	0.00	0.00	0.00	1.00	7.00	1.32
61	I find the software: difficult to use--OK--easy to use	33	2.00	5.00	8.00	9.00	10.00	7.09
63	On average, I have approximately this number of lines in my filter: ___ Lines	31	0.00	17.00	25.00	30.00	65.00	26.84
65	Concerning storage capacity, I find that the system can hold: not enough articles--OK--more than enough	33	0.00	5.00	7.00	8.00	10.00	6.70
66	With the experiment underway, I use my PC: less frequently--the same--more frequently	33	4.00	5.00	7.00	8.00	10.00	6.97
67	Using the system, I feel: awkward--OK--comfortable	34	0.00	7.00	8.00	9.00	10.00	7.90
68	I find the documentation: inadequate--OK--excellent	33	0.00	5.00	5.00	7.00	10.00	5.67
69	I think that MIT provides: not enough support--OK--more than enough	30	0.00	5.00	5.00	7.00	10.00	5.87
70	I find the system has: no value to me--some--great value to me	34	3.00	6.00	7.00	8.00	10.00	7.26
71	I prefer to read the news: in newspapers--mixed--on the system	34	1.00	4.00	5.00	7.00	10.00	5.76
72	When looking for specific information, I prefer to: read the newspaper--use the system	32	0.00	6.00	8.00	9.00	10.00	7.36
73	When reading for general information, I prefer to: read the newspaper--use the system	31	0.00	2.00	5.00	7.00	10.00	4.66

---

54	On the system, I read more full articles from: New York Times [0] Associated Press wire [1]	[0]	18.00	[1]	8.00	Total	26		
62	To use the commands, I mostly: Use the Menus [0] Use the Keystroke Equivalents [1] Other [2]	[0]	6.00	[1]	27.00	[2]	1.00		
64	On average, I change the lines in my filter: Never [0] Once/Week [1] Once/Day [2] More-Often [3]	[0]	7.00	[1]	22.00	[2]	3.00	[3]	1.00

---

PRIMARY DATA FROM THE FIRST YEAR

I find that these two filter lines catch articles of greatest interest to me with the greatest probability:

newssummary

claiborne or 60 minute gourmet

-- 1005

shuttle or nasa or "space shuttle"

ibm or amiga or commadore

-- 1006

(category: entertainment and culture)

(category: news) (priority: urgent | bulletin | flash)

-- 1007

military and electronics

computer and software

--1009

(ibm pc) or (personal computer)

(priority: bulletin | flash)

--1011

(epa | osha) & ((regul\* | legal\* | congress) | chem\* | tox\*)

((chemic\* | toxic\*) ~ (gas\* | petrol\*)) & (spil\* | releas\* | acid\*)

--1016

ibm or compaq or (apple and computer) or atari

subject: business digest

--1019

(subject: science watch)

forecast boston vicinity

--1020

trw or raytheon or telex

wang or "digital equipment" or "prime computer" or "data general"

--1022

science | technology

ibm | lotus | ashton tate | microsoft

--1023

(text: nigeria)

(subject: russia or soviet or ussr)

--1025

(subject: briefing) | (subject: digest briefs)

(subject: space shuttle)

(subject: compute\*)

--1031

videodisc or videodisk

shuttle

--1032

(shuttle | challenger) (crash | explosion) cause (category: ~multiple)

ibm

movie\*

--1036

electric\* and (rates or prices)  
 (subject: newsummary) (type: nyt)  
 --1038

(subject: comput\*)  
 (title: comput\*)  
 --1041

(subject: newsummary) (type: nyt)  
 --1045

university federal research  
 star wars or adi or "strategic defense"  
 --1046

ibm or compaq or (apple and computer)  
 wang or "data general" or "digital equipment"  
 --1048

network & computer  
 (category: news) (priority: urgent | bulletin | flash) (type: nyt)  
 --1049

hazardous wastes  
 health and (risk\* or effect\*)  
 --1101

ibm or compaq or (apple and computer) or atari  
 software\*  
 --[unknown]

boston (not category:sports) not (category: general domestic news)  
 argentin\* not sports  
 --[unknown]

ibm or international business machines  
 --[unknown]

(category: sports) (subject: track or volleyball)  
 (category: sports) (not "individual sports scores")  
 (category: individual sports scores)  
 -- [unknown]

### Additional comments from users.

"In general, I am impressed with the system. ... The manual needs to be extensively revamped. The direction for use does not 'flow' in a logical manner. ... Better explanations are needed on filter use, with more examples ... Put major options in a 'control' line at the bottom or top of the screen. ... Have an option to 'blank' the screen after 10 minutes. ... Multitasking might be possible, so that I can use the computer while receiving articles." -- 1003

"It seems to take very long sometimes to get info from the system that should be there every day." -- 1005

"I would be willing to help put out a newsletter of categories that people use. I feel that it would be very interesting to see how other people are using the system. ... Would like to delete by date ... Lots of duplicate articles under different headings ... Would be nice to have the system save the directory periodically so that if it hangs, it is saved ... Great system" -- 1007

"Additional command/menu item: 'Print current article then delete.' ... Problem: Print-on-arrival command erased when CIS is exited. ... Note-- Receiver is installed below grade level in Wayland ... few 'hits,' or unframed packets are experienced" -- 1009

## PRIMARY DATA FROM THE FIRST YEAR

"I like the idea of this system. Maybe it will solve my frustration with searching through the garbage in newspapers for articles that I am interested in. ... It is a way to use my computer and learn about the world at the same time. Before all the things I would [do] on my computer were in a sense exercising my mind in only a narrow way. It was actually making me into a more shallow person. Now I am expanding my interests in healthy ways." -- 1011

"I have found the system very easy to use, after a few hours of experimenting. I found it of great use, and find it very convenient for everything. I am using the system more than I thought I would. It's nice to be able to access this information so easily. It is definitely a change from piling up old newspapers, and dirty ink. If I had more time I would probably use it more." -- 1014

"The use of certain keys is very different from what I am used to for various commodity software packages. In particular, the ESC key is usually used to cancel.... A function key, typically F1 is used to bring up the help screen. ... Highlighting the word(s) that cause the article to be selected is a very helpful technique." -- 1019

"Duplicate articles are a nuisance. ... Nice if only the most recent 'write through' was saved and prior version(s) deleted. ... The menu should include return to show summaries in reading articles. ... How about more professionally oriented news like full text of New England Journal of Medicine, etc." -- 1020

"The ability to print a viewed article immediately upon reading .... I am successfully running Boston CommInS under DoubleDos ... but am constantly aggravated by nasty direct screen write ... A 'screen-saver' option ... would be considerate. ... a screen display of the most recently received article would be very nice." -- 1022

"Scanning articles on PC/XT is painfully slow while receiver is running. ... The Alt-D, Alt-R and Alt-N command are hard to hit with one hand." -- 1023

"Your key commands and menu instructions can be made much easier-- Your boot procedure is unnecessarily complicated. ... The software puts data in memory of my PC which messes up other software-- users should be warned to boot DOS before running another program. ... I am located in Weston-- have to keep fiddling." -- 1024

"I've been meaning to write a page of my ideas ... I figured I better send this in before you cut me off. I am not a non-respondent, but an addicted participant." -- 1031

"Questions concerning application and cost" -- 1032

"I would like to have different background/foreground colors. ... I am getting proficient at making filters. ... My (type:cis) has not put out an article ... Too many junk items are marked urgent." -- 1036

"The menu facility is appreciated, but made awkward by the use of very non-standard keys. ... Sometimes the system does not work when it starts up. I can toggle to 'Switch Comm. lines' to get it going. ... Surely there is some way to get rid of the multiple copies of almost identical AP documents. ... The code is incredibly sensitive to the hardware. (Printer) ... You should mention several possibilities to people [about printing] 1) DOS PRINT 2) COPY <filename> PRN: 3) Personal File Manager, etc." -- 1038

"It is difficult to devise a truly precise and effective search query on a single 80-character line. ... the highlighting of matching terms in the article is often off by a few characters." -- 1041

"I hate one feature. Typing <Return> when browsing a summary brings you to the top of the summaries." -- 1042

"There needs to be some intelligence somewhere that allows the machine to filter out duplicate articles. ... It would be nice if I could enter DOS commands from inside CIS. ... I would like a feature that takes the current date ... and only traps articles dated that day." -- 1048

"The AP articles repeat too often. It would be nice if there were ways to filter out 'near' matches." -- 1049

"I am legally blind ... I am looking forward with great anticipation to the use of the Boston CommInS system." -- 1052

"[Do I] find that the system collects duplicate information? Always" -- ????

"Is it possible to indicate what subdirectory you would want?" -- ????

---

**March 1986**

---

**Question****# Text**

	<b>Responses</b>	<b>Minimum</b>	<b>25th %tile</b>	<b>50th %tile</b>	<b>75th %tile</b>	<b>Maximum</b>	<b>Average</b>
<b>43</b>	<b>My system has been operational ___ weeks</b>						
	103	0.00	3.00	4.00	8.00	18.00	5.50
<b>44</b>	<b>Average time spent using Boston CommInS during last month : Computer Receiving Data from Boston CommInS ___ Minutes/Day</b>						
	103	0.00	120.00	240.00	600.00	1440.00	416.68
<b>45</b>	<b>Average time spent using Boston CommInS during last month : Browsing Summaries caught by your Filter: ___ Minutes/Day</b>						
	101	0.00	10.00	15.00	30.00	100.00	23.93
<b>46</b>	<b>Average time spent using Boston CommInS during last month : Browsing Full Articles caught by your Filter: ___ Minutes/Day</b>						
	101	0.00	10.00	15.00	20.00	125.00	19.99
<b>47</b>	<b>Average time spent using Boston CommInS during last month : Reading Carefully Articles caught by your Filter: ___ Minutes/Day</b>						
	102	0.00	5.00	10.00	25.00	120.00	18.16
<b>48</b>	<b>Average time spent using Boston CommInS during last month : Printing Articles caught by your Filter: ___ Minutes/Day</b>						
	103	0.00	0.00	0.00	5.00	120.00	4.47
<b>49</b>	<b>Average number of articles found using Boston CommInS during the last month : Articles Caught: ___ Number/Day</b>						
	97	0.00	30.00	50.00	100.00	2700.00	124.14
<b>50</b>	<b>Average number of articles found using Boston CommInS during the last month : Summaries Browsed: ___ Number/Day</b>						
	95	0.00	15.00	40.00	70.00	400.00	55.86
<b>51</b>	<b>Average number of articles found using Boston CommInS during the last month : Articles Browsed: ___ Number/Day</b>						
	96	0.00	5.00	10.00	25.00	150.00	21.79
<b>52</b>	<b>Average number of articles found using Boston CommInS during the last month : Articles Read Carefully: ___ Number/Day</b>						
	96	0.00	2.00	5.00	10.00	80.00	10.29
<b>53</b>	<b>Average number of articles found using Boston CommInS during the last month : Articles Printed: ___ Number/Day</b>						
	96	0.00	0.00	0.00	2.00	20.00	1.88
<b>55</b>	<b>I find that the information available is of: little interest--great interest</b>						
	103	1.00	6.00	8.00	9.00	10.00	7.27
<b>56</b>	<b>I use the system for: personal use--both--professional use</b>						
	104	0.00	2.00	5.00	5.00	10.00	4.00
<b>57</b>	<b>For important news, I rely on the system: not at all--some--exclusively</b>						
	103	0.00	3.00	5.00	7.00	10.00	5.24
<b>58</b>	<b>On the system, I use the summaries: not at all--some--very much</b>						
	104	0.00	7.00	8.00	9.00	10.00	7.35

PRIMARY DATA FROM THE FIRST YEAR

59	On the system, I miss the photographs: not at all--some--very much							
104	0.00	0.00	2.00	5.00	9.50	2.58		
60	On the system, I miss the advertisements: not at all--some--very much							
104	0.00	0.00	0.00	2.00	10.00	1.29		
61	I find the software: difficult to use--OK--easy to use							
105	2.00	5.00	7.00	9.00	10.00	7.06		
63	On average, I have approximately this number of lines in my filter: ___ Lines							
100	5.00	20.00	25.00	35.00	150.00	29.67		
65	Concerning storage capacity, I find that the system can hold: not enough articles--OK--more than enough							
101	0.00	5.00	5.00	9.00	10.00	6.15		
66	With the experiment underway, I use my PC: less frequently--the same--more frequently							
103	2.00	5.00	7.00	8.00	10.00	6.95		
67	Using the system, I feel: awkward--OK--comfortable							
104	0.00	6.00	8.00	9.00	10.00	7.73		
68	I find the documentation: inadequate--OK--excellent							
104	1.00	5.00	6.00	8.00	10.00	6.08		
69	I think that MIT provides: not enough support--OK--more than enough							
87	3.00	5.00	6.00	8.00	10.00	6.43		
70	I find the system has: no value to me--some--great value to me							
105	2.00	7.00	7.00	9.00	10.00	7.43		
71	I prefer to read the news: in newspapers--mixed--on the system							
105	0.00	5.00	5.00	7.00	10.00	5.89		
72	When looking for specific information, I prefer to: read the newspaper--use the system							
103	1.00	6.00	8.00	9.00	10.00	7.28		
73	When reading for general information, I prefer to: read the newspaper--use the system							
104	0.00	3.00	5.00	7.00	10.00	4.95		
<hr/>								
54	On the system, I read more full articles from: New York Times [0] Associated Press wire [1]							
	[0]	44.00	[1]	40.00	Total	84		
62	To use the commands, I mostly: Use the Menus [0] Use the Keystroke Equivalents [1] [OTHER--2]							
	[0]	32.00	[1]	71.00	[2]	0.00		
64	On average, I change the lines in my filter: Never [0] Once/Week [1] Once/Day [2] More-Often [3]							
	[0]	19.00	[1]	60.00	[2]	21.00	[3]	3.00

I find that these two filter lines catch articles of greatest interest to me with the greatest probability:

(subject: shuttle)

(category: sports) (subject: track or volleyball)

-- 1002

computers

philippines

-- 1003

book review

business digest

-- 1004

space shuttle

nih

-- 1005

(category: entertainment and culture)

(subject: tv weekend | tv review | tv tonight)

-- 1007

military and electronics

comput\*

-- 1009

(priority: urgent | flash | bulletin)

nasa

-- 1010

(priority: bulletin | flash)

(subject: on language) or (subject: words)

-- 1011

"south africa" (not "news digest") (subject: not newssummary)

airline\* or faa or "air line" or boeing

shuttle

-- 1013

sports

entertainment

-- 1014

ibm or compaq or (apple and computer) or atari

subject: patents or technology

-- 1019

shuttle (not (subject: advisories))

computer\*

-- 1020

aids

halley's comet

-- 1021

(category: financial) and computer

lotus or microsoft or "ashton tate" or (software and "ms-dos")

-- 1022

(category: news) (priority: urgent | bulletin | flash)



PRIMARY DATA FROM THE FIRST YEAR

nasa  
"health risk"  
-- 1024

(text: nigeria)  
(text: russia or soviet or ussr) (type: nyt)  
-- 1025

newssummary  
mass digest  
-- 1028

ibm  
software  
-- 1030

(subject: shuttle or nasa)  
(subject: compu\*)  
-- 1031

touch screen  
videodisc  
-- 1031

halley's comet  
chile  
-- 1037

(subject: comput\*)  
-- 1041

(category: news) (priority: urgent | bulletin | flash)  
(category: commentary)  
-- 1043

(subject: newssummary) (type: nyt)  
reston  
-- 1045

(category: news) (priority: urgent | bulletin | flash)  
star wars  
challenger  
-- 1046

(mit or "massachusetts institute") & (category: ~sports)  
"local area network" or ((network & computer) & ~television)  
-- 1047

(apple and computer) or (macintosh and computer)  
ibm or compaq  
-- 1048

(category: news) (priority: urgent | bulletin | flash) (type: nyt)  
network & computer  
-- 1049

ibm | apple | atari | data general  
-- 1051

(category: news) (priority: urgent | bulletin | flash)  
ibm | compaq | (apple computer) | atari | "digital equipment" | att

-- 1054

aids  
blood\*  
-- 1059

sdi  
unions  
-- 1060

(category: news)  
-- 1061

(type: nyt) (digital or ibm or computer\*)  
(type: nyt) movie\* or film\* or vcr\*  
-- 1065

israel or palestinian or lebanon  
-- 1066

(category: news)  
aids  
-- 1068

subject market  
computers  
-- 1069

(asia | africa) & (relief | aid)  
(category: news) (priority: urgent | bulletin | flash)  
-- 1070

ibm  
foreign exchange  
-- 1071

(subject: sex\* | romance | dating)  
(subject: science\* | patents)  
-- 1072

international news (priority: regular | urgent)  
(type: nyt) (category: commentary)  
-- 1075

health risk  
mortgage  
-- 1077

(category: international news) (priority: urgent)  
(category: news) (priority: urgent | bulletin | flash)  
-- 1078

(category: news) (priority: urgent)  
(category: state and local news)  
-- 1081

space shuttle (not subject: advisories)  
robot\*  
-- 1083

archaeolog\* or archeolog\*

PRIMARY DATA FROM THE FIRST YEAR

dentist\* or teeth or tooth or periodont\* or periodent\*  
-- 1084

international news  
movies  
-- 1086

nutri\*  
medic\*  
-- 1088

fin digest  
wall street  
-- 1089

(category: news)  
digest briefs  
-- 1092

frontpage  
summary  
-- 1093

mets & yankees  
bkc  
-- 1094

mit  
aids  
-- 1096

(subject: ski)  
(subject: economy)  
-- 1097

nasa  
(category: news) (priority: urgent | bulletin)  
-- 1098

(type: ap) (category: sports)  
(category: financial)  
-- 1099

hazardous waste  
woburn  
-- 1101

("mets" | "new york mets") (category: sports)  
(category: sports) baseball  
-- 1104

nuclear  
aviation  
-- 1106

boston (not sports)  
sex or drug  
-- 1107

harvard  
celtics

-- 1108

satellite dish

"south africa" | botha | (subject: safrica)

-- 1109

skiing

-- 1110

(priority: urgent)

"texas" or "dallas"

-- 1111

"space shuttle" or nasa or "o-ring"

airline\* not (category: advisories)

-- 1112

(subject: newssummary)

(subject: fin digest)

-- 1114

(category: news)

mit or massachusetts institute

-- 1116

military | pentagon

soviet | ussr | gorbachev

-- 1117

(type: nyt) (category: entertainment & culture)

(type: nyt)

-- 1118

newssummary

-- 1119

(subject: international relations)

africa

-- 1121

(subject: patents or technology)

electronics or microelectronics or semiconductors

-- 1124

(soviet | ussr | gorbachev) ~(category: sports) ~(category: advisor\*)

(defense | "defense budget" | pentagon | military) & ~(category: sports)

-- 1126

"central america" | nicarag\* | salv\* (subject: digest briefs)

-- 1128

(category: news) (priority: urgent) ~(subject: weather | forecast\* | lottery)

(category: financial) | (subject: busi\* | finan\* | indus\* | market\*)

-- 1130

(car | autom\* | truck) and (theft | thief | stolen)

dominican republic

-- 1134

computer or cad or cadcam

honeywell

## PRIMARY DATA FROM THE FIRST YEAR

- 1136

soviet union

fcc

- 1137

(subject: personal finance) "mortgage rates" or "mortgage"  
ibm or "ibm pc at" (subject: comput\*)

- 1138

(gm | "general motors") (not (category: sports))

(toyota | honda | nissan) ((not (category: sports)) (not (golf)))

- 1139

editorials

parents children

aids

- 1140

ibm or compaq or (apple and computer) or atari

(subject: wall street)

- 1142

(category: international news) (priority: urgent)

(subject: news digest) (type: ap)

- 1144

(ski conditions)

(priority: bulletin | flash)

- 1146

sdi

- 1147

technology

- 1150

comput\*

communicat\*

- 1151

"nuclear plant" or "nuclear power" or reactor

"tax exempt bond" or "tax exempt bonds"

- 1152

---

### Additional comments from users.

"I feel the software could be better designed .... Also, having to dedicate my computer to it is a hassle. Perhaps a 'Windows' compatible version would be good." -- 1003

"The lag time seems very great. It took overnight to get any articles after the space shuttle crash. Although the signal strength meter reads at the top of the scale, above the value written on receiver, sometimes the reception is very bad with many unframed packets." -- 1005

"I'd like to use my Microsoft mouse and 'pop-up' menus on the system .... Would prefer that the entire article, not just page at a time be dumped into [printer] spooler." -- 1009

"Since we began the experiment we have 1) upgraded to a 30 meg drive 2) Moved the system to an office with better reception 3) slightly reconfigured the filter to get more specific information ... we are quickly getting hooked on our daily information gathering via the air waves." -- 1010

"I was distressed not to be able to pickup anything on the shuttle disaster for 6 hours after the accident. It is annoying to get duplicate articles, which happens a lot. I still enjoy the system very much." -- 1011

"Some filter items must be very long to be useful ... allow longer filter lines ... have a special 'exclude' filter line, with its own budget -- the system would save up to the budget of the item, but not include them under other filter lines ... " -- 1013

"I think the system is great. I've gotten so used to it, that the only time I read the newspaper, is when I find it on the subway. And even then most of the stories I know. At first, I didn't realize the availability of so many different articles. I used to hate those 'Late Night' sports games whose results were not printed in the next day's paper, but there's no problem now. Also it's great for following the entertainment [scene] in New York" -- 1014

"I had no problem in setting up the hardware and software. ... It would be nice if you offered the connector cord in both old and new forms. ... I'd like to see the article inserted into a date-ordered list as they arrive. You could provide a way to delete all articles on a list that came before a given date and time. ... The keyboard interface seems to require both hands. ... Occasionally I would see some characters that weren't meant for me to read -- some control sequence or such. ... Aren't there titles supplied with the articles? I'd like to see the articles presented a little more like they would be in a newspaper. ... You could make use of color for those who have a color display. ... when I press the PgDn key, the bottom line becomes the top, and I tend to re-read it." -- 1017

"When using the read summaries option I find it frustrating not to be able to read an article and then 'return to same place in summaries' (rather than returning to the beginning of the summaries)." -- 1020

"A subtle operational disruption is sporadic disk accessing. When reading summaries or paging through an article there is occasional delay while the disk drive does magic. ... Articles satisfying multiple filter lines can disappear inadvertently if they are marked read and do not seem to contain lasting relevance for the particular filter category being viewed. ... Display burn-in and direct screen writing is annoying ... Boston CommInS should allow the user to specify the writing path for every file." -- 1022

"My experience with CIS has generated two software problems. ... 1) the inability to print using a non-IBM printer. 2) There should be an error message if when you boot CIS ... it has to delete files ... Aside from this complaint [sic], I enjoy using the program quite a bit. I have not found it to be a replacement for the newspaper, however, as I find I can peruse the paper in 30-60 minutes, reading the parts I want. On the other hand, CIS does provide me access to stories that I wouldn't find in the paper, thus supplementing my information access." -- 1026

"Am trying to find a multiprocessing system that allows CIS to run in background ... Double Dos ... DesqView [do not work]." -- 1043

"This is actually a nifty system. Already there have been a couple of times when I have followed developing events with it. However, it has some difficulties which will have to be fixed before it might become a viable commercial entity. The principal problem is duplication of stories. ... A second problem that I have noted is that the subject and category headings of stories appearing on the air are often inaccurate.... The good news is that the software is easy to use and not terribly cumbersome." -- 1047

"This has become an indispensable central source of information. I consider this type of system to be a major breakthrough for disableds' access to the news information. The information available has helped me in some major decisions, financially. I'm totally blind and use speech synthesis for access." -- 1051

"The filter is currently a large disjunction of all the filter lines-- a lot of small and/or statements-- filter lines should be able to link together ... At my home, the reception is very erratic. ... I think it would be very useful to have a special warning message -- whenever the percentage of bad packets goes above some threshold. ... Currently, the only way to modify a filter line is to remove it and insert a new one. But this throws away any articles held under the old filter line. ... I wish there was some way by which I could run the program in 'background' mode." -- 1054

"Global queries ... I get too many repeat articles ... The New York Times has stopped using categories for the last two weeks or so." -- 1065

"... upgraded to a 20Meg disk, etc. [suggestions:] skip to next summary subject, delete until arrow, [user mentioned other functions that exist] With time, I may find you have it already. If so, the [documentation] doesn't suggest it. Thanks. System's fun to use. Will bring it into office in a week or so." -- 1070

## PRIMARY DATA FROM THE FIRST YEAR

"For many users, to collect data on a given subject to establish a file of information is almost completely offset by not being able to store data legally for more than 90 days. Manual is OK for reference, but the order for a new user is poor. One cannot read the manual without referring to appendices or later chapters." -- 1071

"I wish the system would not save duplicate articles. ... I would like to see the Wall Street Journal ... The manual is generally good, except for the section on setting up filter lines. ... Needs more examples. ... I wish there was a way to change a filter without losing the articles in the filter." -- 1072

"If the software could run in the background it would be more useful." -- 1078

"I am very pleased with the performance and volume of information that is provided by the Boston CommInS. Living just outside Route 128, in the shadow of the Blue Hills, it was necessary to install an outdoor FM antenna ... Escape to execute a command? ... Remove menu by pressing space bar? ... Enter should execute all commands. ... Thank you again for the opportunity to be involved in this project." -- 1081

"We are about 15 miles north of the 128 [perimeter] ... the signals apparently come in very strong. ... necessary to toggle Alt-V to get program running. ... We live in a non-urbanized area, highly rural. The system is a considerable boon as newspapers tend to die of old age before they get to us and certainly before they get read. And now to be a bit piggy! Are there any other wire services which will be added? And also color would be nice." -- 1084

"Our system is a lab computer shared by 35 people. The greatest interest in its use has been for news of 'home' that never makes it into print, especially for foreign scientists. ... We love reading stories without all the splits from page to page in newspapers. Also, farewell to newsprint all over the fingers! ... Topic selection has another advantage-- we don't have to scan columns of dramatic murders, etc. to find what we want. The trend toward dramatic stories gives a cumulative false impression of the news over time." -- 1087

"When a filter is modified, the articles associated with the original filter can't be transferred to the new one. The same bell sound occurs with an error as with an incoming file. 'Beep on Arrival' is not stored when the system is turned off." -- 1088

"Not getting any of the specific columns ... Need a NEC 3550 spinwriter print driver!!!!" -- 1092

"It is an excellent idea which has been developed very well. ... My friends who have seen it have also been impressed. I have noticed two minor problems: ...1) Print on Epson FX-80 ... 2) I get some cold starts that result in no incoming articles. ... I wish I could edit existing filter lines. I would like to see a different scrolling algorithm ... when I'm using the down arrow key in the FILTERS WINDOW, I get the next screen full when I reach the last line." -- 1097

"You had 'Massachusetts' spelled wrong in the sample filter. Beep-on-arrival does not remain on when you re-enter the program. The program says 'no more articles' even if there are. Filter lines should not be limited to one line. Adjusting budget on full line causes crashes." -- 1098

"Capacity not enough ... inability to control the Epson FX printer, ... replication of the same material in several places." -- 1099

"[I would like] a copy of the software that will run under DoubleDos." -- 1106

"Add comment to save an article permanently. ... Any way to filter out duplicate articles?" -- 1107

"Would you be using your computer during this time if you didn't have the system?" -- 1108

"Overall, I must say that I find the system incredibly interesting and useful. The text search feature has come in handy many times. I would like to see a more flexible deletion system. ... I find the key definitions very awkward to use. ... I would greatly appreciate the ability to see diagrams with the text. ... The documentation could be improved by adding more cross references." -- 1109

"Overall, I am thrilled with the system. I feel like I can remain in touch with many issues much more effectively. While looking at the AP urgent summaries keeps me abreast of what's happening in the world. It's like having an encyclopedia of current news-- you just type in what you want to know about. Wait a while, and presto! the latest information." -- 1112

"I find that the system is a great way to keep up with current events. Being an MIT student, I do not read the newspaper

frequently, because I am so pressed for time. With the news retrieval system, I can scan the article summaries when I come back from classes or just before I go to bed." -- 1116

"The 'unframed' packet count fluctuates dramatically. ... is there a way so you do not get 4 or 5 copies of the same article ... please send beta-test version [DoubleDos compatible]" -- 1119

"Make future versions of the software interrupt driven and 'Windows' compatible." -- 1124

"It would be nice to be able to delete files with date before xx-xx ... difficult to edit filter listings ...an undo control to restore an erased story might be helpful. ... After reading a story it would be nice to get back to the summary list at the same point one left it." -- 1125

"The system is very good, and quite useful. .... I have a subscription to the New York Times, and I find that the articles in the Times that I find interesting are usually caught by the computer system. .... The AP material is very useful for fast-breaking events, and it gives a good alternative set of information. ... Longer filter lines are needed ... There should be some way of changing filter lines without having to delete and insert. .. The ESC key as the 'execute' key is rather clumsy." -- 1126

"Minor errors in the User Manual: p.32 dos limit on double-sided diskettes is 112. p. 35 should be 'CIS\_DIR' ... Escape key is highly unconventional and confusing ... printer support very device dependent and shouldn't be ... the ability to run CIS in the background is a very important feature." -- 1130

"The filter line is too short ... include UPI and Washington News ... support other printers." -- 1134

"I enjoy using the system and am anxious to see something like this that I can use at home on my Macintosh." -- 1137

"How much have you learned about the way newspapers use the AP wire to put out a newspaper?" -- 1139

"The antenna was very hard to position ... with floppies and two drives the HELP file was missing. ... The program fouls up so that instead of the cursor moving to highlight a line on the Filter or an article summary, the entire list moves. ... 'We Love It!' The only thing we miss are the comics (the literature section). No more black fingers from news print! We keep up a lot better on what's happening, and it's fun to pick out obscure and interesting topics, or favorite New York Times journalists." -- 1140

"My biggest complaint is that it's too damn much fun, and is eating up my time! When an article is printing, if (from summary window) I touch Alt-R the highlighted article is deleted!! ... In the summary window, carriage return should not be used to send the pointer back to the first article. An 'undelete' option would be nice ... A file protect feature would be good. The ability to run in background mode should be the number one priority. ... Allow filter lines greater than one line. ... allow editing filter lines ... duplications are annoying." -- 1141

"The experiment is outstanding. Information is a valuable commodity and to be able to receive [it] quickly and on radio waves is phenomenal. I think the system is wonderful." -- 1144

"One thing I would like to see on the system is the addition of the capability to edit a filter line ... there are printing problems" -- 1146

## April 1986

Question #	Text	Responses	Minimum	25th %tile	50th %tile	75th %tile	Maximum	Average
43	My system has been operational ___ weeks	103	0.00	8.00	8.00	12.00	28.00	9.97



PRIMARY DATA FROM THE FIRST YEAR

44	Average time spent using Boston CommInS during last month : Computer Receiving Data from Boston CommInS ___						
	Minutes/Day						
	100	0.00	120.00	300.00	600.00	6600.00	497.79
45	Average time spent using Boston CommInS during last month : Browsing Summaries caught by your Filter: ___						Minutes/Day
	96	0.00	5.00	10.00	25.00	200.00	21.15
46	Average time spent using Boston CommInS during last month : Browsing Full Articles caught by your Filter: ___						Minutes/Day
	98	0.00	5.00	10.00	15.00	200.00	18.77
47	Average time spent using Boston CommInS during last month : Reading Carefully Articles caught by your Filter: ___						Minutes/Day
	99	0.00	5.00	10.00	20.00	200.00	19.68
48	Average time spent using Boston CommInS during last month : Printing Articles caught by your Filter: ___						Minutes/Day
	96	0.00	0.00	0.00	2.00	200.00	6.72
49	Average number of articles found using Boston CommInS during the last month : Articles Caught: ___						Number/Day
	94	0.00	25.00	70.00	130.00	650.00	110.59
50	Average number of articles found using Boston CommInS during the last month : Summaries Browsed: ___						Number/Day
	97	0.00	15.00	25.00	60.00	400.00	51.20
51	Average number of articles found using Boston CommInS during the last month : Articles Browsed: ___						Number/Day
	99	0.00	8.00	15.00	30.00	400.00	25.83
52	Average number of articles found using Boston CommInS during the last month : Articles Read Carefully: ___						Number/Day
	99	0.00	3.00	6.00	15.00	80.00	12.18
53	Average number of articles found using Boston CommInS during the last month : Articles Printed: ___						Number/Day
	97	0.00	0.00	0.00	1.00	30.00	1.78
55	I find that the information available is of: little interest--great interest						
	103	2.00	7.00	8.00	9.00	10.00	7.41
56	I use the system for: personal use--both--professional use						
	104	0.00	2.00	5.00	5.00	10.00	3.88
57	For important news, I rely on the system: not at all--some--exclusively						
	104	0.00	5.00	6.00	7.00	10.00	5.82
58	On the system, I use the summaries: not at all--some--very much						
	102	0.00	6.00	8.00	9.00	10.00	7.37
61	I find the software: difficult to use--OK--easy to use						
	102	2.00	5.00	7.00	8.00	10.00	6.95
63	On average, I have approximately this number of lines in my filter: ___						Lines
	98	10.00	20.00	25.00	35.00	100.00	31.27
66	With the experiment underway, I use my PC: less frequently--the same--more frequently						
	103	0.00	5.00	7.00	8.00	10.00	6.65
70	I find the system has: no value to me--some--great value to me						
	104	0.00	5.00	7.00	9.00	10.00	7.21
71	I prefer to read the news: in newspapers--mixed--on the system						
	104	0.00	5.00	5.00	7.00	10.00	5.77

PRIMARY DATA FROM THE FIRST YEAR

72	When looking for specific information, I prefer to: read the newspaper--use the system	101	0.00	5.00	7.00	9.00	10.00	6.88
73	When reading for general information, I prefer to: read the newspaper--use the system	102	0.00	2.00	4.00	6.00	10.00	4.35
74	On the system, I miss the stock prices: not at all--some--very much	104	0.00	0.00	2.00	7.00	10.00	3.59
75	On the system, I miss the graphics: not at all--some--very much	104	0.00	1.00	3.00	6.00	10.00	3.52
78	Signal strength and radio reception are: poor--adequate--excellent	100	0.00	7.00	9.00	10.00	12.00	8.12
79	I use the documentation: never--sometimes--often	104	0.00	1.00	3.00	5.00	10.00	3.32
80	I have shown the system to ___ friends.	104	0.00	3.00	6.00	10.00	30.00	7.57
81	I sit at the keyboard and use the Boston CommInS system ___ minutes/day on average.	101	0.00	17.50	30.00	50.00	200.00	39.70

---

54	On the system, I read more full articles from: New York Times [0] Associated Press wire [1]	[0]	42.00	[1]	46.00	Total	88		
63	To use the commands, I mostly: Use the Menus [0] Use the Keystroke Equivalents [1] [OTHER--2]	[0]	21.00	[1]	77.00	[2]	1.00		
64	On average, I change the lines in my filter: Never [0] Once/Week [1] Once/Day [2] More-Often [3]	[0]	15.00	[1]	73.00	[2]	12.00	[3]	2.00
76	On average, my filter lines contain: <3 words [0] 3-4 words [1] >4 words [2]	[0]	30.00	[1]	35.00	[2]	36.00	Total	101
77	I have my system tuned to hold: <50 articles [0] 50-100 articles [1] >100 articles [2]	[0]	8.00	[1]	49.00	[2]	44.00	Total	101

**I find that these two filter lines catch articles of greatest interest to me with the greatest probability.**

(type: nyt) (category: financial)  
 software or ((subject: tech\*) comput\*) or (subject: comput\*)  
 (subject: bkn | track) & (not box)  
 -- 1002

(subject: fin digest)  
 india  
 chess  
 -- 1003

libya

PRIMARY DATA FROM THE FIRST YEAR

ibm  
book review  
- 1004

news digest  
briefing  
space shuttle  
- 1005

(subject: newssummary) (type: nyt)  
(category: entertainment and culture)  
(category: news) (priority: urgent | bulletin | flash)  
- 1007

military and electronics or avionics  
military and intelligence  
(subject: comp\*)  
- 1009

(priority: bulletin | flash)  
boston commuter  
raytheon or "state street"  
- 1011

libya\*  
"kh-77" or "kh-12"  
airline\* or ntsb or faa or "air line" or boeing  
- 1013

(priority: urgent | bulletin | flash)  
chicago ~(category: sports)  
music\*  
- 1014

"ibm pc"  
(category: news) (priority: urgent | bulletin | flash)  
(subject: movie)  
- 1017

ibm or compaq or (apple and computer) or atari  
(subject: patents and technology)  
(subject: business digest)  
- 1019

shuttle not(category: advisories)  
forecast boston vicinity  
- 1020

halley's comet  
marijuana  
drugs  
- 1021

(subject: mortgage) or (mortgage and interest)  
lotus or "ashton tate" or microsoft or trw or (software and ms-dos)  
(category: financial) and computer  
- 1022

(priority: flash or urgent)  
nasa  
(subject: market)

-- 1024

(text: nigeria)  
 (subject: russia or soviet or ussr)  
 (subject: comput\*)

-- 1025

(subject: movie\*)  
 ((subject: column | (category: commentary)) ~ (category: sport\*))  
 ("public opinion" | poll | polls | polling | survey\*) (not sport\*)

-- 1026

(subject: newssummary)  
 harvard (not sports)  
 ibm or compaq

-- 1028

microcomputer\*  
 software\*  
 teach\* and (science or math)

-- 1030

(subject: nasa or shuttle)  
 (subject: newssummary) (type: nyt)  
 (subject: compu\*)

-- 1031

soviet nuclear  
 ibm compaq apple  
 videodis\*

-- 1032

xerox  
 home health care  
 ap news (priority: flash | exclusive)

-- 1037

(subject: comput\*)  
 (title: comput\*)  
 (lingu\* or langu\*) (comput\*) not (category: advisory)

-- 1041

(category: news) (priority: urgent | bulletin | flash)  
 (category: commentary)  
 (subject: newssummary)

-- 1043

lotus or microsoft or (software and computer)  
 ibm or compaq  
 "expert systems" or "artificial intelligence"

-- 1048

libya | khada | khadafy  
 (subject: newssummary) (type: nyt)  
 (category: news) (priority: urgent | bulletin | flash)

-- 1049

"nuclear" or "accident"  
 (subject: newssummary) (type: nyt)  
 (category: news) (priority: post bulletin | post flash)

-- 1051

PRIMARY DATA FROM THE FIRST YEAR

(category: news) (priority: urgent | bulletin | flash)  
india | punjab | panjab | gandhi | delhi  
(subject: foreign)  
-- 1054

(star wars or sdi)  
(priority: bulletin | flash) (category: not sports)  
(mit or "massachusetts institute")  
-- 1057

(category: news) (priority: urgent | bulletin | flash)  
wang or "data general" or "digital equipment" or "analog devices"  
\*  
-- 1064

(type: nyt) (libya)  
(type: nyt) (nasa or aeronautics)  
(type: nyt) (digital or ibm or computer\*)  
-- 1065

health risk  
inoculation  
mci or nec or matsushita  
-- 1067

(category: news) (priority: urgent | bulletin | flash)  
health risk  
(subject: digest briefs)  
-- 1068

computers  
(subject: market)  
blindness  
-- 1069

libya and legal  
((asia | africa) & (relief | aid) & "news digest")  
(subject: fin digest | market\*) (type: nyt)  
-- 1070

ibm  
wine  
travel  
-- 1071

(category: international news) (priority: regular | urgent)  
(category: washington news)  
(type: ap) (category: financial)  
-- 1075

osteoporosis  
bone disease  
mit  
-- 1076

health  
mortgage  
computer  
-- 1077

latr\* or riga

(category: news) (priority: bulletin | flash)  
 (subject: newssummary) (type: nyt)  
 -- 1078

medicare  
 movie\*  
 (category: news) (priority: urgent | bulletin | flash)  
 -- 1080

space shuttle  
 robots  
 extendeds  
 -- 1083

(britain or wales or england) not "new england"  
 comput\*  
 (subject: wall street)  
 -- 1084

international news  
 movies  
 health  
 -- 1086

pharmacy  
 animal research  
 [names of individual countries]  
 -- 1087

israel\* | jewi\* | juda\*  
 sci\*  
 medic\* | nutri\*  
 -- 1088

(subject: newssummary) (type: nyt)  
 ap bulletin  
 digest briefs  
 -- 1092

mets & yankees  
 fin digest  
 (subject: newssummary) (type: nyt)  
 -- 1094

mit  
 ibm  
 aids  
 -- 1096

ski  
 "formula one" or imsa or "formula modiale"  
 (category: news) (priority: urgent | bulletin | flash)  
 -- 1097

(category: news) (priority: urgent | bulletin | flash)  
 nasa  
 physics | physicist\*  
 -- 1098

hazardous waste  
 health effect\*

PRIMARY DATA FROM THE FIRST YEAR

pcb or dioxin\* or radon  
-- 1100

(category: news) (priority: urgent | bulletin | flash)  
business digest | highlights | mirror  
economy | indexes  
-- 1105

aviation  
nuclear  
libya  
-- 1106

harvard  
comput\*  
ibm or compaq or (apple and computer)  
-- 1108

(category: international news) (type: nyt)  
(subject: newssummary) (type: nyt)  
(category: news) (priority: urgent)  
-- 1109

movie review  
mass news  
weather  
-- 1110

(\*texas\* or \*dallas\*)  
(category: sports)  
(priority: update | urgent) (date ??/??/??) (category: not finan\*)  
-- 1111

nasa or \*solid rocket booster\* or \*space shuttle\*  
airlin\* or jetlin\*  
(category: news) (priority: urgent | bulletin | flash)  
-- 1112

(category: news) (priority: urgent | bulletin | flash)  
libya or khadafy  
wang or \*data general\* or \*digital equipment\* or \*analog devices\*  
-- 1116

(libya) & (category: sports | advisors\* | financial)  
nuclear | weapons | \*arms control\*  
military | pentagon | defense (category: not sports)  
-- 1117

(type: nyt)  
(subject: orbit\*)  
(category: entertainment and culture)  
-- 1118

(subject: newssummary)  
(subject: fin digest)  
(subject: business briefs)  
-- 1119

environmental protection  
\*epa\*  
boston harbor

-- 1120

(category: international relations)  
political or social change  
(category: news)

-- 1121

current events (currently libya)  
sports red sox celtics  
professional hazardous waste

-- 1125

(soviet | ussr | gorbachev) ~(category: sports | advisor\*)  
(libya\*) & ~(category: sports | advisor\*)  
(defense | "defense budget" | pentagon | military) & ~(category: sports)

-- 1126

health or medic\* (type: nyt) ~(category: sports)  
(subject: editorial)  
"central america" or nicara\* or salvad\*

-- 1128

((category: fin\*) | (subject: busi\* | finan\* | indus\* | market\*)) computer\*  
software | "computer program" | "computer programs"  
(subject: science\* | technology | patents | comput\*)

-- 1130

denmark or argentina  
mit or massachusetts institute of technology  
(category: news) (priority: urgent | bulletin | flash)

-- 1131

a | an | "and" | the (subject: ~sports)

-- 1132

interactive or videodisc or "cd rom"  
ibm or "digital equipment" or (apple and computer) or amiga  
(subject: calendar)

-- 1133

caribbean | dominican republic  
(crime and (vehicle or auto\*))  
start up | (initial cable offering) | ipo

-- 1134

(priority: urgent | bulletin | flash)

-- 1135

soviet union  
cable television  
vcra

-- 1137

(category: lifestyle) (subject: bc homes)  
"mortgage rates" or "mortgage"  
(category: financial) (subject: bc mortgage)

-- 1138

(libya)

-- 1139



PRIMARY DATA FROM THE FIRST YEAR

libya  
(subject: newssummary)  
(subject: column)  
-- 1140

news bulletin  
ibm  
-- 1143

(category: international news) (priority: urgent)  
(category: washington news) (priority: urgent)  
(subject: libya) (priority: urgent)  
-- 1144

(subject: not multiple) <some topic>  
(subject: hkn) washington or capitals  
(subject: digest briefs)  
-- 1146

nica \* or salvad\* or hondura\* or guat\* or grenada\* or korea\*  
philipp\* or vietna\* or cambod\* or libya\*  
israel\* or palest\* or plo or arab\* or leban\*  
-- 1148

australia ~(category: sports)  
new zealand  
mit and technology  
-- 1150

comput\*  
communicat\*  
digital  
-- 1151

"nuclear plant" or "nuclear power" or reactor  
"tax exempt bond" or "tax exempt bonds"  
"animal rights"  
-- 1152

aids  
health risk  
science | technology  
-- 1153

news  
(subject: newssummary) (type: nyt)  
wall street  
-- 1155

wall street  
(priority: urgent) news  
column  
-- 1161

---

**Will you please tell us what other sources of information you would like to have available via this technology, e.g. the Wall Street Journal, TV Guide, professional journals, etc.**

"Primarily, I would be interested in receiving articles from periodicals relevant to my profession, namely computers. I am an avid reader of the Wall Street Journal. Of course, having the Boston Globe would be nice." -- 1002

"I would be interested in more entertainment reviews, articles from Byte, and stock prices." -- 1005

"The other sources I would be interested in would be: TV Guide, Wall Street Journal, Byte, and any PC magazines. Great system." -- 1007

"Aviation Week and Space Technology, Washington Post, Byte or PC or PC World, etc." -- 1009

"Other sources desired: Boston Globe, Time, articles from Boston CommInS" -- 1011

"Wall Street Journal and TV Guide. Periodicals not depending heavily on graphics. Good up to date weather forecasts. Local entertainment reviews and advertisements." -- 1013

"I think it would be great if I could get the TV Guide. Also, Byte, Personal Computing. It took me awhile to get used to the budgeting system, but after a little experience, it's easy to use." -- 1014

"Wall Street Journal, PC Technical Journal, Dr. Dobbs, Globe, Science News." -- 1017

"(Assuming that the direct print capability is working) PC Week, Wall Street Journal, New England Journal of Medicine, Harvard Business Review." -- 1019

"We are confirmed news fanatics who have been using the Boston CommInS software since December, 1985. We are both academics and find it extremely useful for keeping track of relevant news articles. Before obtaining the software, we clipped articles from the newspapers; these articles then accumulated in huge and unmanageable files all over our house and offices. Replacing the unwieldy files with a small number of diskettes has itself offered a considerable benefit. We have also found the software useful for collecting breaking news stories." -- 1025

"Wall Street Journal" -- 1026

"Oh please, please don't make me go cold turkey! I admit I am an 'info junkie.' I am addicted to Boston CommInS. It has become so much apart of my daily routine that the issues of the other 14 magazines and journals I subscribe to are piling up unread. The PC is in my bedroom and is on continuously. Just before bed I sit down and examine the days catch, I'm really trying to keep myself to less than 45 min/day." -- 1031

"Classified and Commercial. Advertising would be great!" -- 1032

"Wall Street Journal, Byte, Computer Systems News, Electronic Business News, PC Week, professional journal. I would like to know if the software can be run in the background with Topview, DoubleDos. I would buy a copy of whatever works." -- 1034

"What I miss most is stock quotes and a lot of the financial news found in The Wall Street Journal. I also would enjoy the type of 'insider' articles found [in] PC Week, etc. I like the system but don't use it as much as I expected I would." -- 1037

"Boston Globe, TV Guide, Byte, InfoWorld, PC Week. Skip the small niche markets, e.g. New Republic." -- 1038

"Of course, the somewhat greater potential for more immediate transmission could give the radio broadcast route somewhat of an edge over online access." -- 1041

"Wall Street Journal, Barrons, TV Guide." -- 1045

"AP repeated too frequently. There are many other sources of information that would be useful, but there has to be a better way to read them." -- 1049

PRIMARY DATA FROM THE FIRST YEAR

"Wall Street Journal, UPI, Reuters, TV Guide, and a 'local' paper such as Boston Globe." -- 1051

"Wall Street Journal, Dial, PC Tech Journal, Dr. Dobb's Journal, PC, PC World, Byte, reviews of movies. I find the key assignment [not to be] mnemonic or friendly for several functions. If I were to grade a student's assignment which came up with that one, I think I would flunk him." -- 1052

"Byte, etc. Science 86, etc. I would use the system a lot more if I could run it in the background to collect articles" -- 1054

"The other complaint I have about article reception is that some of the categories listed in the manual do not seem to do what is advertised. For example: (subject: editorial) does not seem to capture the NYT editorials." -- 1057

"Wall Street Journal or TV Guide" -- 1064

"It would be more helpful if pressing the return key would activate the command. I would like to have the Village Voice, the Wall Street Journal, the Boston Globe, etc." -- 1065

"Wall Street Journal, High Technology, History, Science." -- 1067

"WALL STREET JOURNAL, Nature and Science and Medline" -- 1068

"First choice, IBM PC specific ... Second Choice: Financial news." -- 1070

"I would like to see the Wall Street Journal on the system. I think magazines like Scientific American rely too much on pictures/graphics and would be useless." -- 1072

"Wall Street Journal" -- 1073

"First of all, I think this is a great service. I really appreciate being able to get the late breaking stories as [they] happen. It is very interesting to watch a story evolve as several versions of the same article come over the wire. I would like TV guide, and of course, comics. A crossword puzzle wouldn't be a bad idea. I'm wondering if there is some sort of facility for mailing things to broadcast on CommInS. Escape to execute a menu selection is a little strange. F1 should be the help key. ... [Need] ability to modify filter line." -- 1074

"Byte, Wall Street Journal" -- 1077

"I would love to see some professional journals. Also some other arts/entertainment news -- Boston Globe, TV Guide." -- 1080

"TV Guide, Wall Street Journal, and listing of local arts and entertainment." -- 1083

"Wall Street Journal, Byte, IBM Users Group." -- 1084

"Add services from magazines of scientific interest: Science, Scientific American, etc. Yes, more art and entertainment. Can you devise a way in which we could communicate among users?" -- 1086

"The Wall Street Journal would be a very positive service. If medical and general scientific journals were available, I would be reading abstracts." -- 1088

"Wall Street Journal, Boston Globe, Business Week, Time, Newsweek." -- 1090

"During the past several months the FM receiver has been very useful. The receiver has become my primary source of information." -- 1091

"More commentary and opinion. General scientific journal articles. Wall Street Journal." -- 1092

"Wall Street Journal" -- 1093

"Wall Street Journal" -- 1094

"I'd like to see more news and more computer related info. How about public domain software?" -- 1096

- "I would like to see up to date cable TV program listing, public domain software, and Wall Street Journal." -- 1097
- "Wall Street Journal, Time, Newsweek, Astrophysical Journal, Scientific American, and musical events in Boston. You should be able to 'edit' an existing filter line." -- 1098
- "Science, Scientific American, PC Week." -- 1100
- "I do not feel the need to read the NYT as carefully as I did in the past. The system demonstrated its power during the recent Libyan Crisis -- three stars. Would appreciate updated lists of subjects and categories as you expand and make revisions to the current list. TV listings would be of interest." -- 1105
- "Use of subdirectories. Get rid of garbage (formatting?) in articles. Include computer magazines, sports, and Reader's Digest. Print a schedule of when things are sent out?" -- 1108
- "I'd like to see: TV Guide, Movie Reviews." -- 1110
- "Wall Street Journal and Washington Post. Better format for AP Box scores? An automatic date updater would be nice." -- 1111
- "Would like: Washington Post, movies and times of local theaters, Aviation Week, The New Republic, Science, Nature, and Physics Today. If this is to be a community information system, it seems that movies, concerts, exhibitions, etc. deserve a place on the system." -- 1112
- "News: Wall Street Journal, Financial Times, Washington Post. News Magazines: Business Week, Manchester Guardian Weekly, Newsweek, Time. Arts and Entertainment: TV Guide. Professional Journals: Science, Nature, Byte, Dr. Dobbs, PC News." -- 1115
- "Addition of the Wall Street Journal would be fantastic. It would be nice to see articles from Time or US News and World Report. I placed a filter line for Libya or Khadafy the day before the US attack, and I could nearly follow the developments as they occurred." -- 1116
- "Suggest: Washington Post, Wall Street Journal, tables of contents of professional journals. Last suggestion reflects feeling that the system is best used as a time-urgent-news-source, and as a bell-ringer cueing the reader that resources are available." -- 1117
- "Would like to see either The Wall Street Journal or Barrons." -- 1119
- "Boston Globe (really need local and state news!), Environmental Journals, Science, Policy Analysis type journals, journal of Experimental Marine Biology and Ecology, Marine Biology, Limnology and Oceanography, Environmental Science and Technology, Estuaries." -- 1120
- "I would love to see more sources of information available. Wall Street Journal, Physical Review B&D, Physical Rev. Letters, and Scientific American." -- 1124
- "Science, TV Guide." -- 1125
- "The Economist, Wall Street Journal, Byte, InfoWorld, Scientific American, Science, Foreign Affairs." -- 1126
- "TV Guide definitely." -- 1128
- "It would be great to see more journals and publications made available on the airwaves. My preference would be for the Wall Street Journal, Computerworld, and some of the better computer-related magazines like PC Magazine, Byte, etc. I found the summary window display feature very useful. The most annoying thing is that the system always returns to the start of the summary window, instead of returning to the last position. I find the keyboard conventions rather awkward and confusing. Scrolling should be smoother." -- 1130
- "My main problem with the system is that I can't afford to devote a whole computer to receiving information. I would like Wall Street Journal. Have any public libraries in the area used the system?" -- 1131
- "Items I can store into my own permanent free-text database. Current proclamations, legislation and law reports. Notices of

PRIMARY DATA FROM THE FIRST YEAR

upcoming talks by Prof. Gifford. Structured calendar notices. Computer software. Price indexes. Notices posted by CIS participants." -- 1132

"I could use more documentation on the wire services ... I would like to be able to request more information on an item appearing within a news service summary. ... It would be nice, if when deleting articles, the system simply flagged the article for deletion ... The system feels a little slow ... Like many other folks, I am eagerly awaiting support for non-IBM printers." -- 1133

"The quality of the news is poor. They are short and incomplete. The antenna was very hard to position and it doesn't look nice. In general I am not satisfied with this system. And I can't use my computer while running the system ... I don't know why." -- 1135

"The following would make CIS more useful: Wall Street Journal, Washington Post." -- 1137

"I would like to have access to Byte Magazine, Tech Journal." -- 1138

"Frankly, the current data sources pretty well cover my interests." -- 1139

"Wall Street Journal, Business Week, any others. Include [the problem of having] the [two] antenna wires touching [in the] trouble-shooting [guide] (brought in for service with machine)." -- 1140

"Washington Post, political science book reviews, foreign broadcast info service." -- 1141

"I am enjoying the system. The software is very easy to operate. The information is incredible and in much more detail than news heard over the radio or printed in the newspapers. I would be interested in Scientific American, Byte, and the Wall Street Journal. Thank you very much for the system. The transmission is terrific." -- 1144

"I would like information from: AirForce Times, Los Angeles Times, Albuquerque Herald, National Enquirer, foreign papers, and the Chicago Tribune." -- 1146

"Wall Street Journal, PC Week/Info World" -- 1150

"I would like to be able to reject articles that merely mention 'comput\*' once or twice. By way of formatting: A lot of the articles are poorly formatted. Mainly, though, I like the system a lot." -- 1151

"I am buying fewer newspapers and reading them more casually. I do not watch the news on television as often as I used to. I would like to see more news on the level of the Wall Street Journal. The delete function, accessed at any filter level, wipes out all versions of the article on the disk, even those caught by other filters." -- 1152

"I would very much like to have journals of commentary and opinion such as New Republic, Nation, Progressive, Public Interest, Dissent, National Review available." -- 1159

"Wall Street Journal, stock ticker." -- 1161

---

May 1986

---

Question  
# Text

Responses	Minimum	25th %tile	50th %tile	75th %tile	Maximum	Average
43 My system has been operational ___ weeks						
90	.14	10.00	12.00	16.00	32.00	13.86
44 Average time spent using Boston CommInS during last month : Computer Receiving Data from Boston CommInS ___ Minutes/Day						
87	0.00	120.00	240.00	500.00	1440.00	378.33

PRIMARY DATA FROM THE FIRST YEAR

45	Average time spent using Boston CommInS during last month : Browsing Summaries caught by your Filter: ___ Minutes/Day					
88	0.00	5.00	10.00	20.00	180.00	17.24
46	Average time spent using Boston CommInS during last month : Browsing Full Articles caught by your Filter: ___ Minutes/Day					
85	0.00	5.00	10.00	12.50	180.00	13.49
47	Average time spent using Boston CommInS during last month : Reading Carefully Articles caught by your Filter: ___ Minutes/Day					
85	0.00	5.00	5.00	15.00	120.00	13.11
48	Average time spent using Boston CommInS during last month : Printing Articles caught by your Filter: ___ Minutes/Day					
84	0.00	0.00	0.00	5.00	240.00	6.01
55	I find that the information available is of: little interest--great interest					
94	1.00	6.00	8.00	9.00	10.00	7.27
63	On average, I have approximately this number of lines in my filter: ___ Lines					
94	10.00	20.00	25.00	35.00	100.00	31.31
70	I find the system has: no value to me--some--great value to me					
95	2.00	5.00	7.00	8.00	10.00	6.87
71	I prefer to read the news: in newspapers--mixed--on the system					
95	1.00	4.00	5.00	7.00	10.00	5.36
72	When looking for specific information, I prefer to: read the newspaper--use the system					
94	1.00	5.00	7.00	8.00	10.00	6.96
73	When reading for general information, I prefer to: read the newspaper--use the system					
94	0.00	2.00	4.00	6.00	10.00	4.17
80	I have shown the system to ___ friends.					
87	0.00	4.00	7.00	12.00	50.00	9.22
81	I sit at the keyboard and use the Boston CommInS system ___ minutes/day on average.					
87	3.00	15.00	20.00	40.00	180.00	31.84
82	On the system, I would like classified ads re articles for sale, job opportunities, housing, etc.: not at all--some--very much					
95	0.00	0.00	4.00	8.00	10.00	4.33
83	I would like detailed TV schedules on the system: not at all--some--very much					
95	0.00	0.00	3.00	7.00	10.00	3.87
84	I would like stock prices and other financial information on the system: not at all--some--very much					
95	0.00	3.00	7.00	9.00	10.00	5.81
85	I would like the CommInS program to run in a way so that I could use other software simultaneously: not at all--some--very much					
94	0.00	9.00	10.00	10.00	10.00	9.12
86	At the end of this experiment, I would be interested in subscribing to a commercial service using this technology: not at all--some--very much					
95	0.00	5.00	7.00	8.00	10.00	6.52
87	For the service exactly as it is, I would be willing to pay a total subscription fee of: \$ ___/month					
91	0.00	5.00	10.00	15.00	75.00	11.71

**PRIMARY DATA FROM THE FIRST YEAR**

<b>88</b>	At the price named in the last answer, I would subscribe to the service with probability: zero--one-half--one						
89	0.00	6.00	8.00	9.00	10.00	7.33	
<b>89</b>	If I could run other programs at the same time as I use the CommInS program, then I would be willing to pay a total subscription fee of: \$ ___/month						
87	0.00	7.50	12.00	17.00	75.00	14.86	
<b>90</b>	If possible, I would be interested in buying only a partial subscription, say only to sports or a few other topics, in order to reduce the monthly fee: definitely no--maybe--definitely yes						
90	0.00	3.00	5.00	8.00	10.00	5.45	
<b>91</b>	For a commercial system with classified ads (on jobs, automobiles for sale, housing, etc.) I would be willing to pay an EXTRA \$ ___/month						
86	-5.00	0.00	0.00	2.00	20.00	1.81	
<b>92</b>	For important news, I rely on the system: not at all--some--exclusively						
95	0.00	5.00	6.00	7.00	10.00	5.97	
<b>93</b>	My interest in the system is: decreasing--unchanged--increasing						
93	0.00	4.00	5.00	7.00	10.00	5.45	

**On routine/daily basis, I find that the single most valuable use of the system is:**

- "Getting current info on the day's biggest news on my own terms, not having it read to me by a newscaster." -- 1002
- "News Update" -- 1004
- "Briefings" -- 1005
- "Acquiring instantaneous news (urgent | bulletin | flash)" -- 1006
- "Keep up to date on the latest national news" -- 1007
- "Scanning filter items, printing some" -- 1009
- "Boston commuter" -- 1011
- "Keep up with 'late breaking' work news" -- 1013
- "General News, (Priority, Flash) Sports" -- 1014
- "Turn on the system and come back in a couple of hours and know that the topic or headline news you are interested in will be available, current (up to date) and not buried on an unknown page or glanced over quickly in a TV newscast." -- 1019
- "Monitoring for news about companies in which I have invested" -- 1020
- "Up to the minute updates" -- 1021
- "Tracking major financial news" -- 1022
- "Urgent News" -- 1025
- "Browsing for news items not carried in major media" -- 1026
- "Reading the next days news summary before going to bed" -- 1031

- "Learning the Technology" -- 1032
- "As an insight into potential information systems." -- 1041
- "Industry Announcements" -- 1047
- "International and Computer news" -- 1051
- "Foreign news, better than any single newspaper" -- 1054
- "Quick update on the 'headlines'" -- 1057
- "Not missing economic news that gets lost in or left out of the papers." -- 1060
- "Tracking major news stories, discovering unusual items not in newspaper" -- 1064
- "Breaking news stories" -- 1065
- "To get news that the newspapers censor (of which there is quite a bit)" -- 1066
- "To find the latest news" -- 1068
- "Finding items I'd miss while reading NYT and [The Boston] Globe paper" -- 1070
- "Latest travel info" -- 1071
- "I don't have a single most valuable use" -- 1072
- "News summaries/headlines" -- 1073
- "International news summaries" -- 1075
- "Scanning summaries" -- 1077
- "Weather report" -- 1078
- "Culling articles which pertain to my company (employer)" -- 1080
- "Current events" -- 1081
- "News" -- 1084
- "Breaking news" -- 1086
- "Foreign news, pharmacology news" -- 1087
- "Sci\*" -- 1088
- "Recent news international and national" -- 1090
- "To see what the news is" -- 1091
- "AP News Flash" -- 1092
- "Quick perusal of news summaries" -- 1093
- "Keeping up with news" -- 1096
- "Scan summaries of urgent news bulletins" -- 1097
- "Getting fast news from Washington" -- 1101



PRIMARY DATA FROM THE FIRST YEAR

- "Daily news survey" -- 1106
- "News filtering" -- 1107
- "(subject: safrica)" -- 1109
- "Current News" -- 1110
- "News Flashes/Sports Results" -- 1111
- "News" -- 1115
- "National/International News" -- 1116
- "Scanning for fast-breaking international news" -- 1117
- "Getting caught up on news quickly" -- 1118
- "New York Times" -- 1119
- "Pulling off national news related to Environmental Protection -- particularly concern[ing] status of legislation" -- 1120
- "Current news" -- 1121
- "Business News" -- 1124
- "Current Events" -- 1126
- "Keeping up with 'fast-breaking' news" -- 1128
- "Random tidbits of business/computer and technical news" -- 1130
- "Current world and national news highlights" -- 1131
- "Monitoring topics of specific interest" -- 1133
- "Get details on a narrowly defined subject like new tax reform" -- 1134
- "Finding articles with obscure topics" -- 1137
- "Access to late breaking news" -- 1138
- "International news" -- 1144
- "Current reports of Sport Scores and World News" -- 1146
- "Material that does not appear in the press" -- 1148
- "Hot Breaking News" -- 1150
- "Screen for news items of transient interest" -- 1152
- "Medical/science news updates" -- 1153
- "Very specialized searcher (eg. "Air traffic control")" -- 1157
- "Browsing through the filter/summaries reading articles of interest" -- 1160
- "Check stock market progress/Recent news" -- 1161
- "Scanning for headlines" -- 1162

- "Continued stock market reports" -- 1163
  - "I like the weather forecast and the business news" -- 1164
  - "Detailed info on a few topics of special interest" -- 1165
  - "Current material for case work" -- 1167
  - "Filtering pre-selected categories" -- 1168
  - "Follow breaking news" -- 1199
- 

**During the whole experiment, the single most valuable news item that I have found with the system is:**

- "Not a single item more valuable than others" -- 1004
- "Space shuttle" -- 1005
- "Reviews and announcement of IBM equipment" -- 1006
- "Articles on Diabetes, Chernoybl incident" -- 1007
- "No one stands out" -- 1009
- "Commuter train strike news" -- 1011
- "There have been too many to single out one-- Chernoybl and Shuttle info when news was scarce. I was alerted to one event of great personal significance (Ron McNair Memorial at MIT) by a chance look at the Mass Daybook." -- 1013
- "Berklee College attempts to resolve strike (I'm a Berklee student)" -- 1014
- "Turn on the system and come back in a couple of hours and know that the topic or headline news you are interested in will be available, current (up to date) and not buried on an unknown page or glanced over quickly in a TV newscast." -- 1019
- "Story on refinancing mortgages" -- 1020
- "Chernoybl updates" -- 1021
- "An article on IBM's new products before it was publicly announced" -- 1022
- "Urgent News" -- 1025
- "Marcos left the Philipines, IBM Laptop will be unveiled" -- 1031
- "Chernoybl, USSR" -- 1032
- "Nothing remarkable-- sometimes see items sooner or that I would have missed otherwise." -- 1041
- "Chernoybl" -- 1051
- "Full reports on Chernoybl accident" -- 1064
- "Grants for artists" -- 1065
- "One about aids" -- 1068
- "Oxfam related news story" -- 1070

PRIMARY DATA FROM THE FIRST YEAR

- "IBM and South Africa" -- 1071
- "An article about romance in China" -- 1072
- "Cost of housing in selected cities" -- 1075
- "Mortgage/Interest rate information" -- 1077
- "Shooting of Olaf Palme" -- 1078
- "Health care financing administration's budgetary plans" -- 1080
- "When Marcos fled the Philipines" -- 1081
- "Space shuttle and Soviet nuclear disaster reports." -- 1083
- "Chernobyl disaster" -- 1084
- "Shuttle disaster" -- 1086
- "Preliminary report about a Lilly drug for depression about to be used to treat obesity." -- 1087
- "Articles for school papers/exams" -- 1090
- "Urgent" -- 1091
- "AP News Flash" -- 1092
- "An article about an incident at my undergraduate college" -- 1096
- "AP report of friend coming first in pro ski race" -- 1097
- "Congressional action on statutes" -- 1101
- "Chernobyl accident" -- 1106
- "Health and medical news" -- 1107
- "(type: nyt) (subject: newsummary)" -- 1109
- "Current News" -- 1110
- "Items on the Libyan Bombing" -- 1111
- "Toxic wastes, nuclear" -- 1115
- "No single news item has been singularly outstanding." -- 1116
- "Articles on space shuttle and Chernobyl" -- 1118
- "News Summary" -- 1119
- "EPA', Environmental Protection" -- 1120
- "Current news" -- 1121
- "Patents Column" -- 1124
- "NYT article reviewing various AT clones" -- 1130
- "Up to date news on Chernobyl accident" -- 1131

- "A story relating to my business" -1133
  - "Meeting of the Journalism Fraternity" -- 1134
  - "FCC/communications industries" -- 1137
  - "Mortgage Rates, Trends" -- 1138
  - "Full Text of Presidential addresses" -- 1141
  - "Technicare sold by J&J to GE" -- 1142
  - "Chernobyl and Libyan crisis" -- 1144
  - "Updated Report which described nearly precisely the Libyan bombing" -- 1146
  - "Chernobyl Information" -- 1150
  - "Information shared with my colleagues in Nuclear Engineering Department, re: Chernobyl" -- 1152
  - "AIDS info" -- 1153
  - "Congressional vote on aid to Contras" -- 1155
  - "I have yet to get a piece of news on the system that I had not." -- 1157
  - "We have most closely followed the items on Libya and Chernobyl" -- 1160
  - "Those relating to space program" -- 1162
  - "10AM and midday stock market report" -- 1163
  - "Article on CBS for a current case project" -- 1167
  - "Quick pick up of Sperry acquisition" -- 1168
- 

**If it were possible to subscribe to just a few topics, I would definitely want to subscribe to these topics.**

- "News Digests, Stocks, TV, Books and Movies" -- 1003
- "Financial news, Stock prices" -- 1004
- "News Flashes, Business, Weather, Sports" -- 1006
- "TV, National News, Local News" -- 1007
- "Specific news on filter subjects" -- 1009
- "News, Job opportunities" -- 1011
- "Entire NYT wire, Bulletins and flashes" -- 1013
- "Sports, TV Listings, Entertainment" -- 1014
- "Business, Technology, Medical" -- 1019
- "Financial, Computer Science" -- 1022

PRIMARY DATA FROM THE FIRST YEAR

- "International News" -- 1025
- "Newssummary, comput\*" -- 1031
- "Classified and Commercial Advertisements" -- 1032
- "Commentary, International, Denmark" -- 1043
- "Stock prices, Late-breaking news" -- 1048
- "International news, TV, jobs (temporarily), special news, as topical, Regional & Computer news" -- 1051
- "News, Commentary, Foreign news, India, science & technology" -- 1054
- "International, economic, business, labor-relations news" -- 1060
- "Urgent and Major news, Stock Prices" -- 1064
- "Complete New York Times" -- 1065
- "International News and better filters" -- 1066
- "News Urgent, International, National, etc." -- 1068
- "PC news off ARPAnet, stock prices" -- 1070
- "Travel, Food" -- 1071
- "News, Finance" -- 1073
- "News" -- 1075
- "Classified Ads, Stocks, In-Depth speciality articles" -- 1077
- "Weather, News" -- 1078
- "Health issues, computers" -- 1080
- "Weather, major news (world and US). I prefer the NYT wire service." -- 1083
- "News, weather, financial" -- 1084
- "News" -- 1086
- "Scientific articles" -- 1087
- "International/National News, News/Summaries" -- 1090
- "Urgent, Financial News" -- 1091
- "Finance, News, International News, Science/Health" -- 1092
- "News summary, financial info" -- 1093
- "News, Financial" -- 1096
- "Sports, technology, stock prices" -- 1097
- "News, Arts, Science" -- 1098
- "News, financial" -- 1101

- "Aviation weather, stock market report" -- 1106
  - "World and local news, for sale ads, local entertainment and events, housing ads" -- 1107
  - "News, technology" -- 1109
  - "Movies, news, TV" -- 1110
  - "Sports, News" -- 1111
  - "Financial" -- 1115
  - "National/International News, Financial News with stock quotes." -- 1116
  - "International News, Political affairs, defense/military" -- 1117
  - "Entertainment, book reviews, classified ads" -- 1118
  - "Environmental Issues, sports" -- 1120
  - "International news" -- 1121
  - "Finance, Wall Street, Science, Technology" -- 1124
  - "International News, Domestic News, Science News" -- 1126
  - "General business news, computer, technology" -- 1130
  - "Business, Entertainment and Culture, Domestic, International, Financial" -- 1133
  - "Financial" -- 1134
  - "News (local, domestic, international), topics related to my research" -- 1137
  - "Byte, Jobs, houses, stocks, sports" -- 1138
  - "International, politics" -- 1141
  - "TV Schedules, Jobs, Sales" -- 1142
  - "News, science, computers, financial" -- 1144
  - "Sports, World News, weather information" -- 1146
  - "News, science news, bulletins, medicine, etc." -- 1153
  - "Closing Wall Street Prices" -- 1155
  - "Bad Ideal I think this should be an all-or-nothing service." -- 1157
  - "Since two of us would use the system and our interests differ, we would want it all." -- 1160
  - "Stocks, Financial, Business" -- 1161
  - "Science/Technology news, International, Washington, Classified ads" -- 1162
  - "Business News by Industry/Company" -- 1168
-

**If it were possible to subscribe to just a few topics, I would definitely NOT want to subscribe to these topics.**

"Sports" -- 1004

"There aren't any." -- 1006

"Sports, Stocks" -- 1007

"Sports, TV, Weather, etc." -- 1009

"Politics, Financial Information" -- 1014

"Sports, music, TV" -- 1019

"Sports, Lifestyle, International" -- 1022

"Sports, financial" -- 1031

"I want it ALL!" -- 1032

"Sports, Entertainment" -- 1043

"Sports, TV" -- 1048

"Sports, Aids" -- 1051

"Sports, Real Estate, Theater, ..." -- 1054

"?" -- 1060

"Sports" -- 1064

"AP" -- 1065

"Sports" -- 1066

"Sports, Financial" -- 1068

"Sports, AP Wire" -- 1070

"Sports, TV" -- 1071

"Sports" -- 1072

"Sports" -- 1075

"Sports Scores, TV Listings" -- 1077

"Sports" -- 1078

"sports, daybook" -- 1080

"Sports" -- 1083

"Sports" -- 1084

"Financial, sports, TV" -- 1086

"Sports, Ads" -- 1087

"Sports, TV, Lotteries, NY News" -- 1090

"Sports" -- 1091

"Sports" -- 1092

"Most AP bulletins" -- 1093

"Sports, TV" -- 1096

"Lotteries" -- 1097

"Sports, Financial" -- 1098

"Sports, Racing" -1101

"Sports" -- 1107

"Stocks, sports" -- 1109

"Stocks" -- 1110

"Financial, commercial" -- 1111

"Sports" -- 1115

"State News" -- 1116

"Classified ads, TV schedules, stock prices, etc." -- 1117

"Sports, stock prices" -- 1118

"Ads, TV, Real Estate" -- 1119

"Stocks, Classified (personal use stuff)" -- 1120

"Sports, stock quotations, weather" -- 1126

"Sports, [junk], lottery" -- 1130

"Sports, racing" -1133

"Sports" -- 1134

"Sports, weather, TV schedules" -- 1137

"Advisories, Financial, sports" -- 1141

"Sports" -- 1142

"Home and Living, Entertainment" -- 1146

"Sports" -- 1150

"Sports, TV, stocks, etc." -- 1153

"Sports, local" -- 1161

"Sports" -- 1162

"Movies, local news" -- 1168



June 1986

Question  
# Text

Responses	Minimum	25th %tile	50th %tile	75th %tile	Maximum	Average
<b>44 Average time spent using Boston CommInS during last month : Computer Receiving Data from Boston CommInS ___ Minutes/Day</b>						
83	0.00	60.00	200.00	600.00	1440.00	399.80
<b>45 Average time spent using Boston CommInS during last month : Browsing Summaries caught by your Filter: ___ Minutes/Day</b>						
82	0.00	5.00	10.00	15.00	120.00	14.84
<b>46 Average time spent using Boston CommInS during last month : Browsing Full Articles caught by your Filter: ___ Minutes/Day</b>						
84	0.00	5.00	10.00	12.50	120.00	11.74
<b>47 Average time spent using Boston CommInS during last month : Reading Carefully Articles caught by your Filter: ___ Minutes/Day</b>						
79	0.00	5.00	5.00	15.00	120.00	13.24
<b>48 Average time spent using Boston CommInS during last month : Printing Articles caught by your Filter: ___ Minutes/Day</b>						
73	0.00	0.00	0.00	1.50	120.00	4.49
<b>55 I find that the information available is of: little interest--great interest</b>						
96	3.00	6.00	7.00	8.00	10.00	6.94
<b>70 I find the system has: no value to me--some--great value to me</b>						
96	1.00	6.00	7.00	8.00	10.00	6.81
<b>71 I prefer to read the news: in newspapers--mixed--on the system</b>						
95	0.00	4.00	5.00	6.00	10.00	5.21
<b>72 When looking for specific information, I prefer to: read the newspaper--use the system</b>						
94	0.00	5.00	7.00	9.00	10.00	6.79
<b>73 When reading for general information, I prefer to: read the newspaper--use the system</b>						
92	0.00	3.00	4.00	7.00	10.00	4.57
<b>81 I sit at the keyboard and use the Boston CommInS system ___ minutes/day on average.</b>						
81	0.00	15.00	20.00	30.00	150.00	30.38
<b>92 For important news, I rely on the system: not at all--some--exclusively</b>						
94	0.00	5.00	6.00	7.50	10.00	6.03
<b>93 My interest in the system is: decreasing--unchanged--increasing</b>						
96	1.00	4.00	5.00	7.00	10.00	5.33
<b>94 On the system, I would like schedules for academic seminars at local universities: not at all--some--very much</b>						
95	0.00	4.00	6.00	9.00	10.00	6.12
<b>95 On the system, I would like schedules for Boston Computer Society meetings: not at all--some--very much</b>						
96	0.00	2.00	5.00	8.00	10.00	5.03

PRIMARY DATA FROM THE FIRST YEAR

<b>96</b>	<b>On the system, I would like Tables of Contents for Important academic and professional journals: not at all--some--very much</b>					
94	0.00	3.00	7.00	9.50	10.00	6.14
<b>97</b>	<b>On the system, I would like schedules for movies, concerts, &amp; plays for Boston area: not at all--OK--very much</b>					
96	0.00	5.00	8.00	9.00	10.00	7.05
<b>98</b>	<b>On the system, I would like crossword puzzles: not at all--OK--very much</b>					
97	0.00	0.00	0.00	2.00	10.00	1.64
<b>99</b>	<b>On the system, I would like to be able to receive (free) copies of public domain software: not at all--OK--very much</b>					
97	0.00	7.00	9.00	10.00	10.00	8.34
<b>104</b>	<b>With the system, I feel: less informed--same--better informed</b>					
95	5.00	6.00	8.00	9.00	10.00	7.50
<b>105</b>	<b>I have telephoned the CommInS HOTLINE ___ time(s) for help during the course of the experiment.</b>					
92	0.00	0.00	1.00	2.00	5.00	.98
<b>106</b>	<b>The CommInS HOTLINE has been responsive to my requests for help: too slow--OK--great</b>					
51	0.00	3.00	5.00	8.00	10.00	5.01
<b>107</b>	<b>In my filter, I select stories by the CATEGORY field, e.g. (category: lifestyle): not at all--some--exclusively</b>					
94	0.00	2.00	5.00	8.00	10.00	4.51
<b>108</b>	<b>In my filter, I select stories by the SUBJECT field, e.g. (subject: arts): not at all--some--exclusively</b>					
95	0.00	4.00	8.00	7.00	9.50	5.65
<b>109</b>	<b>In my filter, I select stories by the PRIORITY field, e.g. (priority: flash): not at all--some--exclusively</b>					
94	0.00	1.00	2.00	5.00	9.00	3.32
<b>110</b>	<b>In my filter, I select stories by the AUTHOR field, e.g. (author: reston): not at all--some--exclusively</b>					
94	0.00	0.00	0.00	2.00	7.00	1.51

**On the system, I would like Tables of Contents for important academic and professional journals. I vote for these 3 journals:**

"Science, Nature, Byte" -- 1005

"Journal of the ACM, Unix World, PC Tech Journal" -- 1006

"Aviation Week" -- 1009

"PC Magazine, Info World" -- 1011

"Byte, NE Journal Of Medicine, Harvard Business Review" -- 1019

"Byte, InfoWorld, Computer World" -- 1022

"American Political Science Review, Political Science Quarterly, American Historical Review" -- 1025

"American Political Science Review, American Journal of Political Science, American Economic Review" -- 1028

"High Technology, Technology Journal, Byte" -- 1031

"Journal of the ACM, PC Magazine, Harvard Business Review" -- 1032

"PC Tech Journal, PC Week" -- 1040

**PRIMARY DATA FROM THE FIRST YEAR**

- "Journal of Documentation, Artificial Intelligence, Expert Systems" -- 1041
- "CACM, Computer, InfoWorld" -- 1045
- "MISQ, Communications of the ACM, Harvard Business Review" -- 1048
- "CACM, TOCS, IEEE Spectrum" -- 1049
- "IEEE Transactions on Magnetics, ... Electrical Insulation, ... Energy Conversion" -- 1057
- "AI Journal, Cognitive Science, Cognition" -- 1065
- "New England Journal of Medicine, Atherosclerosis, Journal of Molecular Biology" -- 1068
- "ACM Micros, IEE, ARPA" -- 1070
- "IEEE Journals, Science, Nuclear Instruments and Methods" -- 1076
- "Harvard Business Review, Journal of the American Medical Association, American Journal of Public Health" -- 1080
- "IEEE Robotics and Automation, ASME Journal of Dynamics Systems and Control, International Journal of Robotics Research" -- 1083
- "Economic History Review, English Historical Review, Medical Archaeology" -- 1084
- "Journal of Clinical Investigation, American Journal of Physiology, New England Journal of Medicine" -- 1086
- "Sloan Management Review, Harvard Business Review" -- 1090
- "ACM Journal Databases, ACM Journal Office Automation" -- 1091
- "New England Journal of Medicine, Science, Nature" -- 1092
- "Byte, PC, PC Tech Journal" -- 1097
- "Astrophysical Journal, Nature, Physical Review" -- 1098
- "Science, Scientific American, Nature" -- 1100
- "Science, Scientific American, Byte" -- 1106
- "Science, Nature, Hearing Research" -- 1112
- "American Political Science Review, International Security, Journal of Strategic Studies" -- 1117
- "Journal of Finance, Fortune, Forbes" -- 1119
- "American Political Science Review, American Sociological Review, American Journal of Sociology" -- 1121
- "Physics Review, Journal Of Applied Physics, Journal of Math. Physics" -- 1124
- "Cell, PNAS, Nature" -- 1125
- "Foreign Affairs, APSA Quarterly, PC Magazine" -- 1126
- "Any law related periodicals index, Business Reviews" -- 1127
- "Computerworld, PC Week, Byte" -- 1130
- "Library HiTech, Database End User, Wilson Library Bulletin, Journal of Taxation, Byte, Journal of Artificial Intelligence" -- 1132

- "Computer, Electronic, Accounting" -- 1132
  - "IEEE Proceedings, Science, Communications of the ACM" -- 1137
  - "American Political Science Review, International Organization, World Politics" -- 1141
  - "New England Journal of Medicine, Science" -- 1142
  - "JACM, SIAM Journal of Computing, New England Medical Journal" -- 1149
  - "Byte, National Association Business Economists, American Statistical Society" -- 1150
  - "PNAS, NEIM, Nature" -- 1153
  - "Scientific American, Journal of American Planning Association, Journal of Political Economy" -- 1154
  - "PC World" -- 1158
  - "Econometrica, Journal of Political Economy, American Economic Review" -- 1160
  - "ACM, HBR" -- 1161
  - "Byte" -- 1162
  - "HBS" -- 1167
  - "Byte, Harvard Business Review" -- 1171
  - "Journal of Rheumatology, Arthritis and Rheumatism, Journal of Immunology" -- 1173
  - "EDN, Electronics" -- 1196
  - "New England Medical, Law Review" -- 1198
- 

**Imagine that -- in response to your queries -- your personal computer could access the entire text of the past three months of the New York Times by telephoning a computer at MIT. Do you think this new service would complement the system?**

- "Very much so. I think it is much more appropriate than many of the other possible ideas presented here." -- 1002
- "Yes" -- 1005
- "... would greatly enhance the system.... Also, it would enable those with minimum storage available, to have complete articles available." -- 1006
- "Yes, very much. I realize that I am probably missing articles because of space limitations and not having exact filters. The query system would allow endless possibilities." -- 1007
- "Maybe for some people. I'd prefer having more magazines made available." -- 1011
- "Absolutely, given effective search and management tools. Current text search is marginal, given the spotty conventions for date entry by wire services." -- 1013
- "Yes, in that some data went past daily. User interfaces/search could be made similar and easy to use." -- 1019
- "Yes" -- 1021

PRIMARY DATA FROM THE FIRST YEAR

- "Yes, this would complement the existing system. I can see how this historical feature would be valuable for many users, ...." -- 1022
- "Absolutely -- allows in-depth searches, catches articles missed due to vacation, etc." -- 1024
- "Yes" -- 1025
- "Yes, very much. I cannot accommodate all the items I receive...." -- 1026
- "Yes. I suppose if one caught a story by accident and was intrigued, it would be possible then to search backwards for other occurrences." -- 1031
- "Absolutely." -- 1032
- "Yes!" -- 1038
- "Yes." -- 1040
- "Very much." -- 1041
- "Yes." -- 1045
- "Yes." -- 1047
- "Yes. It would [to] have looking for older articles possible." -- 1049
- "Yes." -- 1052
- "Marginally." -- 1054
- "Not for me." -- 1056
- "Yes. It would certainly not duplicate what the current system does." -- 1057
- "Yes" -- 1062
- "Yes, it would begin to give a library flavor." -- 1064
- "Yes, but would the existing filter system allow tight enough filtering. There tends to be too much related information; how would I make the subtle distinctions necessary for research into a certain area." -- 1065
- "Yes." -- 1066
- "Enormously" -- 1070
- "Yes." -- 1071
- "Yes." -- 1072
- "Yes." -- 1073
- "Yes." -- 1076
- "Yes." -- 1080
- "Yes, but may serve a different set of needs from those currently addressed." -- 1083
- "I should imagine yes; as your data bases would hold news. Also end of month or end of quarter hindsight news more appropriate than daily guess work." -- 1084

PRIMARY DATA FROM THE FIRST YEAR

- "It could help to follow back some important news when you come back from traveling abroad." -- 1086
- "Yes -- It would be a giant step towards the goal of sensitivity in capturing all relevant news." -- 1088
- "Yes -- would be very useful to certain people with a specific need for past NYT data/info." -- 1090
- "For those with an interest in past newspaper articles." -- 1091
- "Very much so." -- 1092
- "Yes." -- 1096
- "I would certainly use it." -- 1097
- "I think it would be quite useful and appropriate complement to the existing system." -- 1098
- "In theory, yes, but I have trouble seeing the details." -- 1100
- "Very definitely -- since I do not have Double-Dos available to me there have been periods when the system was used for word processing and Dow Jones in this manner I could fill in information gaps." -- 1105
- "Yes, definitely. Users can search for news items that they missed during daily use of the system. This service would also be very helpful to pilots who need to observe the weather pattern in areas of their flights." -- 1106
- "Yes, the telephone service is not the same, though. It is more for people who are trying to do research than for people who want news. My use for such a system would be primarily limited to research." -- 1109
- "I guess it could if I read the Times." -- 1110
- "Yes. Now, I keep some articles on subjects, but I have no real capacity for deciding what I will want to have read and saved 2 months from now." -- 1112
- "I do not think this new service would complement the existing service. Old NYT can be looked up in a library, where all the old issues are in the form of microfilm or microfiche, while the existing system gives the most recent news available, often before the next day's papers are printed." -- 1116
- "Yes. One can't retrieve old articles using the current system." -- 1117
- "Definitely." -- 1118
- "Yes. (This is something I wish the system had when it started!)" -- 1119
- "Yes." -- 1120
- "Yes." -- 1121
- "Yes." -- 1124
- "No." -- 1125
- "For the reasons discussed above I think it would complement the current system quite well. I don't think it is essential, but it would be a useful and convenient extension of the service." -- 1126
- "Yes. Many stories 'slip by' at the time, and some are undoubtedly missed if one doesn't have the computer on much a particular day or is away several days." -- 1127
- "Yes." -- 1129
- "Yes, but I would prefer to see broader current coverage than old reruns cluttering the limited available bandwidth." -- 1130

PRIMARY DATA FROM THE FIRST YEAR

"Yes, especially if done at no/low cost." -- 1131

"Yes. It would allow searches of the recent past for new topics of interest. As it operates now, it only lets the user look forward for information known to be of interest today." -- 1133

"Yes, quite well. It is easy for my system to miss important articles if I don't have it turned on at the right time or if I am away for the weekend. Having the database would allow me to make sure I find all articles of use to me." -- 1137

"Yes, to those who have not saved any particular items/text to their own database." -- 1138

"Definitely!" -- 1141

"Yes." -- 1142

"I definitely feel that this service would complement the existing system. News is vital, and too often the exact events leading up to a particular crisis are forgotten or misinterpreted. It would be extremely beneficial to have this information at your fingertips." -- 1144

"Yes. It would be awesome if it was quick (ie. good response)." -- 1146

"Yes, it would provide a significant advantage over daily delivery of my newspaper, which the existing system does not have." -- 1150

"Yes! The scope of broadcast stories is often limited. Some items cry out for more detail." -- 1152

"Yes." -- 1153

"It depends upon speed with which article could be identified and downloaded and coordinated with selected articles from existing system." -- 1154

"Yes." -- 1155

"Yes-- very much." -- 1160

"Very much so. The problem with the current system alone is that past info is lost." -- 1161

"Absolutely." -- 1162

"Yes." -- 1163

"Yes." -- 1165

"It could. Longer backlog would make it more attractive." -- 1168

"Quite a bit, for the extended research capabilities it would provide. If an interesting item were discovered on the receiver, additional research could easily be done." -- 1171

"Yes, especially for those who hesitate to leave computer on continually, but would like up to date information." -- 1173

"Yes." -- 1198

---

**Imagine that -- in response to your queries -- your personal computer could access the entire text of the past three months of the New York Times by telephoning a computer at MIT. How often might you use this new service?**

"I can see myself using it quite frequently. However, it would be greatly influenced by how much time it required tying up the phone and by how powerful the query capability was. I have no qualms about using the service as is because there really are no

- strings attached or extra costs involved. But accessing a database by telephone is very different psychologically and possibly economically." -- 1002
- "Sometimes, not often" -- 1005
- "This service would be valuable, but not as a daily event. ... I would use this service on an average of 1 or 2 times a week." -- 1006
- "Probably in the beginning a few times per month ... After the system was tuned probably a few times a week." -- 1007
- "20 minutes a month." -- 1011
- "A few times per week." -- 1013
- "Twice a month." -- 1019
- "Very rarely." -- 1021
- "Not very often." -- 1022
- "Once a week on average." -- 1024
- "Once every ten days to two weeks." -- 1025
- "2-3 times a month" -- 1026
- "I might occasionally ... go back and skim the lifestyle stories." -- 1031
- "At least once a week." -- 1032
- "Depends on convenience (baud rate, busy signals, software, cost, etc.). I would try 2 or 3 times in the first weeks then adjust in response to early success or frustration." -- 1038
- "3 to 4 times a year." -- 1040
- "Depends on cost and utility compared with competing services. At most, once per month." -- 1041
- "Once a week." -- 1045
- "Not very." -- 1047
- "Once or twice a month." -- 1049
- "Due to lack of my time, I would be unable to utilize such a facility at this time. I can certainly see that the availability of this service would be of great value to many users (especially students and teachers)." -- 1051
- "1 or 2 times a week." -- 1052
- "Not very often -- I have a hard enough time keeping up with current events!" -- 1054
- "Very rarely -- I don't find much time to use the present service at the office (where I have it). I think (know) I would use it more at home, if it were there." -- 1056
- "I doubt I would use it if it had only a three month memory." -- 1057
- "Weekly." -- 1062
- "5 to 10% of the time perhaps." -- 1064
- "It is hard to tell before it exists. I never go through old newspapers, but I do look up old movie reviews. In this case, the medium would be the message. The current system could almost be replaced by a newspaper, but a historical system couldn't. It would break new ground, and therefore should prove interesting." -- 1065



PRIMARY DATA FROM THE FIRST YEAR

- "Depends on research activities." -- 1066
- "2 or 3 times a week." -- 1070
- "Monthly." -- 1071
- "Approximately 2 times per week." -- 1072
- "Would depend on effectiveness of indexing scheme and ability to zero in on sought for text." -- 1073
- "Few times per week." -- 1076
- "1 to 3 times a month." -- 1080
- "Probably 2-5 times a month for about 30 minutes each." -- 1083
- "Generally once a quarter." -- 1084
- "Occasionally." -- 1086
- "Weekly." -- 1088
- "Not very often." -- 1090
- "Not at all." -- 1091
- "Maybe even more than present system." -- 1092
- "Hard to say, but when I did, it would be very useful reference." -- 1096
- "4-5 times a week." -- 1097
- "About two to three times a month, to be honest." -- 1098
- "[twice a] week." -- 1100
- "Very hard to estimate but at present I read newspapers and CommInS." -- 1105
- "Probably weekly." -- 1106
- "That depends on the amount of research I would need to do. For a term like my last one, about 2-3 times per week with multiple queries each time." -- 1109
- "Not to read the Times." -- 1110
- "If I had a modem, maybe a few times a week." -- 1112
- "Not at all unless I am researching a paper that needed recent events." -- 1116
- "Sporadically. But it would be of great and unique value on those occasions when it was accessed." -- 1117
- "Once a month." -- 1118
- "Daily (I'm serious. On a daily basis, I find numerous situations arising when I wish I had the ability to look back into the past with the system.)" -- 1119
- "Not very often -- The media ... often distorts the position of a party in a decision." -- 1120
- "Several times a week." -- 1121

"If it has financial data, I would use it daily." -- 1124

"Rarely." -- 1125

"My initial guess is that I wouldn't use it that often. However, often a new resource tends to become used more often as new reasons for using it are discovered. (It would be very useful for looking up movie reviews, I just realized.) My initial estimate is about 1 access per week, but this could be off (in either direction) by a factor of 3 or 4." -- 1126

"I don't have a modem, so not at all for a while. If I had one, about once a week would be likely." -- 1127

"3-10 times a year." -- 1129

"I would not have frequent occasion to use such a service. I would probably use an online service like Dialog or Knowledge Index if I wanted to look into past issues for specific topics." -- 1130

"At least twice weekly." -- 1131

"Once a week perhaps (steady state), more often during start-up experimentation." -- 1133

"2-3 times a week." -- 1137

"Depending on access cost, perhaps twice weekly." -- 1138

"Average one hour a day." -- 1141

"Often." -- 1142

"I would use this service daily, and frequently during the day." -- 1144

"1/2 hour a day." -- 1146

"Often." -- 1149

"Once per week." -- 1150

"Hard to say -- depends in large measure on transmission speed-- even 1200 baud would be too slow for casual use." -- 1152

"Not sure (weekly?)." -- 1153

"Frequently." -- 1155

"Probably only once a month or so." -- 1160

"Dozen times a week." -- 1161

"Daily." -- 1162

"Once a week or so. Depends on the response time." -- 1163

"Twice a week." -- 1165

"Without library access as a faculty member, three times a month." -- 1168

"For investment purposes, only occasionally, since I am only an occasional investor. For checking on professional activity in my field, a number of times a week. For background info on breaking events, probably a number of times a week." -- 1171

"1 to 2 times a month." -- 1173

"Three times a day." -- 1198

PRIMARY DATA FROM THE FIRST YEAR

**Imagine that -- in response to your queries -- your personal computer could access the entire text of the past three months of the New York Times by telephoning a computer at MIT. For what might you use this service?**

"Financial -- I would like to go back and find all references to a particular company to use in annotating graphs of that company's stock prices. General News -- I would like to track opinions/views on an issue after it has been 'decided.' For example, it would be fun to review how news on the shuttle broke, after the fact." -- 1002

"Research of Current Events" -- 1005

"The main use ... would be to track a specific news story.... This would benefit those that didn't have a correct filter turned on to capture the news story." -- 1006

"To gather all info available on a particular subject in one place. To keep myself and my family more interested and to find articles we might have missed." -- 1007

"Probably wouldn't very often." -- 1011

"Researching interesting stories in depth, and catching up on missed news." -- 1013

"School assignments/papers. Look back to see beginning of event that became currently important. Refresh your recollections." -- 1019

"Basically general information on a particular subject. I personally don't think I would have a great deal of use for this service." -- 1021

"Not much. The NYT information is too general to be worth using as a serious researching resource. ..." -- 1022

"Looking for trends in business would be possible. ... could also read articles missed for any reason." -- 1024

"Researching articles for academic journals; finding information for college-level classes." -- 1025

"Research, especially academic work, when I need detailed info on well-defined subjects." -- 1026

"I can't think of anything. The main fascination with the system is getting the latest, most recent stories. I now always delete a story over 2 days old, regardless of topic." -- 1031

"To research a story-line. Get background information on a particular subject. Search for possible relationships in the time-ordered database." -- 1032

"Much more useful. I could use it for exploration of a sequence of topics to help refine my filter. Also, look for predecessors of a story. Finally, I often want information on a company. Now, I have to set my filter and wait, and hope for the best." -- 1033

"Don't have any idea." -- 1040

"Retrospective retrieval of news both for international needs and for system evaluation." -- 1041

"1. Finding stories that I didn't have a chance to read, but which are no longer around. 2. Finding old stories on a topic I'm currently interested in." -- 1045

"Don't know." -- 1047

"If someone were to tell me of a recent article in the Times on a subject of interest, I would use the service to look it up." -- 1049

"1a. I would use it for reading more deeply into particular events. 1b. It would save my disk storage." -- 1052

"Looking up articles on specific issue -- e.g. India, SDI, World Cup Soccer" -- 1054

"Not much, I'm afraid." -- 1056

PRIMARY DATA FROM THE FIRST YEAR

- "For getting a more complete picture on something. The trouble is that three months is not far enough back. I might, for example, want to be able to find out what X said about Y seven years ago..." -- 1057
- "Occasionally to find an article I hadn't cut out, but actually 3 months wouldn't be very useful. Far more useful would be the NYT Index as far back as possible." -- 1060
- "a) Looking at weather trends. b) Getting previous background stories related to a major current event. c) Looking for back-referenced articles." -- 1062
- "Looking up a story or article someone told me about. Reading Movie Reviews (ie. specific ones)." -- 1064
- "Movie reviews, stock market investment information, computer trends." -- 1065
- "Political science analysis of news reporting." -- 1066
- "To retrieve two ways: 1) by category -- narrowly used such as a specific column or movie reviews. 2) by subject -- such as India to Economics." -- 1070
- "Background info on various topics. To collect non-news items -- for example, travel." -- 1071
- "Movie reviews, occasionally, I miss an article on the system that I really want to read. This is a hard question to answer since the service is not available. If it were available I would probably use it." -- 1072
- "Background on current stories, following news 'threads.'" -- 1073
- "I wouldn't be interested in this service." -- 1075
- "Looking up information to expand something that caught my attention." -- 1076
- "Download and print texts relating to health care law issues for my company." -- 1080
- "Reviewing old stories, collecting recipes, getting copies of stories recommended by friends, scanning 'Science-Times' in NYT. Sounds like a great idea -- we used to have such a system on line at Stanford's AI Lab -- it was wonderful." -- 1083
- "Subject oriented research; quarter and financial funds." -- 1084
- "I wouldn't have much use for it, except to document how many times did Reagan change his position on arms control in the past 3 months. I would be extremely interested, however, to be able to pull out news from the past 10-20 years!" -- 1086
- "Instead of having the software running daily, one would be [free] to miss days (e.g. when I am out of town) without necessarily missing important articles!" -- 1088
- "Academic research -- papers, etc." -- 1090
- "Since my interest is for current information, or academic articles, past issues of the NYT would be of little use." -- 1091
- "To scan for occurrence of key words/names/phrases related to an area I'm working in or interested in reviewing." -- 1092
- "Catching up on news in dumps (timewise) by subject." -- 1096
- "Market research to follow trends in CAE/CAD/CAM technologies. Compilation of Formula 1 racing statistics." -- 1097
- "This service could be used to trace carefully a news story from beginning to end. It would be useful, also to 'catch-up' on missed news events." -- 1098
- "Checking history of legislation." -- 1100
- "Financial, world and national events. I would primarily find this useful for personal interest and research." -- 1105

## PRIMARY DATA FROM THE FIRST YEAR

- "Literature search of a particular news topic. This service would be very helpful for observing an evaluation of an event." -- 1106
- "I would use the service for classes and general background information. There were a number of times last semester when I used the system to look for articles." -- 1109
- "I think that it could be good if I read the Times, but I do not." -- 1110
- "I would probably use this to get background material about subjects of current interest to me. If some major development happens in Upper Volta, say, then I would search the text for articles about that development to gain a longer perspective, and some of the motivating causes." -- 1112
- "Occasionally professors assign students essays which require research into recent events. I remember when I had to write a paper on the recent changes to medicare; it would have been helpful then to have such a service. Other than research papers, I can't imagine any use for such a service myself." -- 1116
- "Researching current events sufficiently recent as to be not yet available in the NYT Index, or on microfilm, and few libraries have the space to keep a 3-month stock of the Times." -- 1117
- "To catch book or movie reviews that were missed previously, or a series of articles on a particular subject." -- 1118
- "1) Background research 2) To learn more about a particular item. The system would be used for MIT related work and personal investigation. The availability of such a system would provide the necessary impetus to buy a 1200 baud modem." -- 1119
- "Research public positions of players involved in an environmental dispute -- such as Boston Harbor." -- 1120
- "Research and background on African states." -- 1121
- "Researching papers would be a possibility. Stock analysis could be performed if NYSE data were to be included." -- 1124
- "Not much as I read the NYT daily. The AP has been much more useful for me." -- 1125
- "This sort of resource would be very useful for research for papers, as well as just to get caught up on certain issues. I guess that my main use would be for research for papers, more than for casual use." -- 1126
- "Research in my field -- the area of housing and real estate development. Some stories which did not seem worth printing at the time might be useful when a specific issue crops up." -- 1127
- "Nation magazine often contains criticism of the NYT. I'd like to be able to go back to the original. Also for studies of word frequency, etc." -- 1129
- "I'd look for articles with my present filter lines for selected topics of lasting interest, e.g. computer software and business-related." -- 1130
- "To search for specific information on cultural events, city happenings (conferences held, politics), national and international news, trends and analysis pieces." -- 1131
- "Research (academic, market)" -- 1133
- "Background material for research." -- 1137
- "I wouldn't have use for this service other than for reference on particular items/trends in real estate." -- 1138
- "1) Research on political science topics 2) Content analysis of journalistic coverage 3) Generally staying informed -- in blocks." -- 1141
- "Research current events mentioned by friend/associates for factuality. Lots of half-truths and rumors in conversations. I try to sort these out." -- 1142

"I would find this service invaluable. I work with students researching countries of the world and current world problems, crises, and events, a service of this type during the experiment would be a tremendous data base of recent world events that I would access daily." -- 1144

"1) Retrieving background information on current stories, 2) Research for papers, general information." -- 1146

"Yes." -- 1149

"To provide background on the latest news stories, to search for specific references to: movies, records, people, companies." -- 1150

"Same as CommInS -- but more intensive. Possibly also for more casual use because broadcast stories are some[times] too 'telegraphic' for many issues." -- 1152

"Professional use [such] as science journals to track medical and science news." -- 1153

"1) Track unfolding stories that I begin following in the middle, 2) Research financial news or press." -- 1154

"Movie Reviews, background info on current stories." -- 1155

"I would use it in digging up collections of articles on a news event of interest as it unfolded. This would come in handy in doing research (I'm an economist)." -- 1160

"1) Research topics of current interest to trace developments over time, 2) Track down items that just became interesting and thus not trapped by filter." -- 1161

"As a writer I would use the system mainly for research." -- 1162

"Following up a story which I hadn't been paying attention to." -- 1163

"Information on companies for research, information on movies, travel or other leisure activities." -- 1165

"Very little -- my university library is bound to be cheaper -- Free." -- 1168

"This type of service would be tremendously useful for researching industry activity in my business, for following recent company activity for investment purposes, and to get summaries of recent histories of current events for personal reading." -- 1171

"News to an industry group on a particular company for investment purposes." -- 1173

"At this time I cannot justify a need for such an addition." -- 1196

"Research, back info." -- 1198

## July 1986

### Question # Text

	Responses	Minimum	25th %tile	50th %tile	75th %tile	Maximum	Average
44 Average time spent using Boston CommInS during last month : Computer Receiving Data from Boston CommInS _____ Minutes/Day	73	0.00	120.00	240.00	600.00	1440.00	435.18
45 Average time spent using Boston CommInS during last month : Browsing Summaries caught by your Filter: _____ Minutes/Day	73	0.00	5.00	10.00	20.00	120.00	16.61

**PRIMARY DATA FROM THE FIRST YEAR**

**46 Average time spent using Boston CommInS during last month : Browsing Full Articles caught by your Filter: \_\_\_ Minutes/Day**

72            0.00            5.00            10.00            15.00            120.00            12.99

**47 Average time spent using Boston CommInS during last month : Reading Carefully Articles caught by your Filter: \_\_\_ Minutes/Day**

71            0.00            5.00            6.00            15.00            120.00            13.48

**48 Average time spent using Boston CommInS during last month : Printing Articles caught by your Filter: \_\_\_ Minutes/Day**

68            0.00            0.00            0.00            2.00            120.00            4.26

**55 I find that the information available is of: little interest--great interest**

85            3.00            6.00            7.00            8.00            10.00            7.05

**70 I find the system has: no value to me--some--great value to me**

86            0.00            5.00            7.00            8.00            10.00            6.69

**71 I prefer to read the news: in newspapers--mixed--on the system**

85            1.00            5.00            5.00            7.00            10.00            5.42

**72 When looking for specific information, I prefer to: read the newspaper--use the system**

85            2.00            6.00            7.00            9.00            10.00            7.11

**73 When reading for general information, I prefer to: read the newspaper--use the system**

84            0.00            2.00            4.00            7.00            10.00            4.54

**81 I sit at the keyboard and use the Boston CommInS system \_\_\_ minutes/day on average.**

80            0.00            15.00            30.00            45.00            180.00            34.97

**92 For important news, I rely on the system: not at all--some--exclusively**

87            0.00            5.00            6.00            7.00            10.00            5.98

**93 My interest in the system is: decreasing--unchanged--increasing**

87            0.00            4.00            5.00            6.00            10.00            5.31

**99 On the system, I would like to be able to receive (free) copies of public domain software: not at all--OK--very much**

84            0.00            6.00            9.00            10.00            10.00            7.80

**104 With the system, I feel: less informed--same--better informed**

85            3.00            6.00            8.00            8.00            10.00            7.38

**111 I read the information from the Associated Press with: little interest--some--great interest**

84            1.00            5.00            7.00            8.00            10.00            6.49

**112 For the present system, but only with stories from the Associated Press (AP), I would willing to pay \$ \_\_\_ per month**

84            0.00            2.00            5.00            10.00            35.00            7.51

**113 At the price named in the last answer, I would subscribe to such an AP-only service with probability: zero--one-half--one**

81            0.00            5.00            7.00            8.00            10.00            6.30

**114 I read the information from the New York Times with: little interest--some--great interest**

85            2.00            6.50            8.00            8.00            10.00            7.36

**115 For the present system, but only with stories from the New York Times (NYT), I would willing to pay \$ \_\_\_ per month**

82            0.00            4.00            6.00            12.00            50.00            9.48

**116 At the price named in the last answer, I would subscribe to such an NYT-only service with probability: zero--one-half--one**

81            0.00            5.00            7.00            9.00            10.00            7.01

PRIMARY DATA FROM THE FIRST YEAR

117 For the present system (with stories from the AP and NYT), but with a method to distribute public domain software, I would willing to pay AN EXTRA \$\_\_\_ per month

83	0.00	1.00	4.00	5.00	20.00	4.40
----	------	------	------	------	-------	------

118 At the price named in the last answer, I would subscribe to public domain software with probability: zero--one-half--one

81	0.00	6.00	8.00	9.00	10.00	7.50
----	------	------	------	------	-------	------

121 For a "black box" that would receive articles of interest while my personal computer was turned off, I would be willing to pay a (one time) cost of \$\_\_\_.

78	0.00	25.00	50.00	100.00	500.00	107.18
----	------	-------	-------	--------	--------	--------

122 At the price named in the last answer, I would buy such a "black box" with probability: zero--one-half--one

79	0.00	5.00	7.00	9.00	10.00	6.85
----	------	------	------	------	-------	------

128 When running the CommInS system, my hardware and/or software "crashes" \_\_\_ times per month

79	0.00	0.00	0.00	2.00	25.00	1.33
----	------	------	------	------	-------	------

119 My personal computer has a hard disk: (circle one) Yes[1] No[0]

[1]	21.00	[0]	65.00	Total	86.00
-----	-------	-----	-------	-------	-------

120 I deliberately do not run my computer 24 hours each day in order to save my hard disk from "wear and tear": (circle one) Yes[1] No[0]

[1]	41.00	[0]	37.00	Total	88.00
-----	-------	-----	-------	-------	-------

123 I own and use a modem for telecommunications: (circle one) Yes[1] No[0]

[1]	22.00	[0]	50.00	Total	77.00
-----	-------	-----	-------	-------	-------

126 Baud Rate:

300	4.00	1200	58.00	2400	3.00	4800	0.00
-----	------	------	-------	------	------	------	------

**How much do you object to leaving your computer turned on so that you can receive data from the Boston CommInS?**

"Learned to sleep through the noises it makes. Just recently tried to keep on all time. Still learning." -- 1004

"I do worry about wear and tear, especially to hard disk. I limit use to 3-4 hours [per] day for this reason and thus amount of time is barely adequate to utilize the system." -- 1006

"Very much. I have an XT running this system at present, and the noise level is annoying. ... Two options presented in this questionnaire have been, a black box to capture the information while the machine is off, and the availability of a 3 month database of past articles. A combination of these two would be fantastic. I could retrieve all information for the past 3 months without turning on my machine. ..." -- 1006

"Do not object. I feel leaving it on does less harm to the system." -- 1007

"I feel uncomfortable leaving my PC on for more than 3 or 4 hours a day for the following reasons: 1) I am using floppy disks which fill up quickly. 2) The disks do a lot of spinning 3) use of electricity for extended periods." -- 1011

"Leaving my machine on is the biggest problem in using CIS. It's too noisy to leave on when people are sleeping in the room with the machine, and the heat generated is considerable. The system and use is unusually large, an AT with PRO Graphics. It draws quite a bit of current and runs very hot." -- 1013



## PRIMARY DATA FROM THE FIRST YEAR

"I don't mind for a couple of hours, but I don't like leaving it on overnight. I get worried it may over heat (in summer), and also there is a lot of disc drive usage. I have left it on overnight a few times, and the system was fine, but I'm still a little concerned for long periods of time. Unless there was something I was specifically looking for, I wouldn't leave my computer on for more than 3 or 4 hours at a time." -- 1014

"Only when I or members of my family want to use the PC for other tasks. This will no doubt be solved when more powerful PCs and multi-tasking operating systems are commonly available and priced for the home market. My wife and I feel uncomfortable leaving the PC running when no one is home. The concern is that there may be an electrical malfunction that leads to a fire, and/or electrical storms and power surges which damage the PC." -- 1019

"Somewhat." -- 1021

"I have little objection to leaving my PC & hard disk running in order to receive data from BCIS. Although there is wear & tear, I don't expect it to have much impact on the lifespan of the system. The major cause for concern is electrical stability or lack thereof from the local power company. ... However, the possibility of buying a Black Box which would receive BCIS type data is a highly desirable alternative. ... This would reduce the risk of variant/deviant power fluctuations causing damage to the entire PC, which is its main selling point." -- 1022

"I have a PC and 2 disk drives. Before Boston CommInS, I would turn it on in morning (or when I needed it). Once turned on, I would leave it on until I was sure I wouldn't be using it again that day. Between uses, I turn the monitor brightness down. Each night I turn off my PC. To avoid running continuously, I use your program during the day if I'm not using my PC otherwise and limit overnight use to 3 times per week." -- 1024

"Let's just say, it would be spectacular if it ran in the background." -- 1025

"Since I do not have exclusive use of the computer, it would be imposing on the person who comes into the office in the morning to do the word processing. However, if we had a disk, and did not have to share the computer with secretaries it would be practical to leave the computer on for 24 hours." -- 1028

"I don't. My computer is on continuously. I only turn it off when I pop the cover or move it." -- 1031

"Some. Due to fan noise." -- 1032

"My computer is already kept on all the time. I think powering down a hard disk is a risk. I wish you transmitted late at night." -- 1034

"It is definitely an issue. A related problem is looking everything up before I leave at night." -- 1038

"I worry that the power may fail, and the computer may start a fire." -- 1040

"A lot. Have had hard disk problems." -- 1041

"Not at all." -- 1045

"No objection." -- 1047

"My main objection is the noise. It is loud. Disk wear isn't a factor since it is MIT's machine." -- 1049

"I had a friend who lost his life during a thunder storm, and his home was destroyed by the fire (directly due to his computer being left on). Supposedly, it was a properly grounded system. Wear and tear on hard disk drive IS a factor." -- 1051

"I have no objections whatsoever to leaving my computer turned on. The Seagate design engineer stated that he designed the bearings for five-year continuous use." -- 1052

"A lot: my computer is noisy and next to my bedroom!" -- 1057

"Mildly." -- 1059

"I would be willing to experiment for a while." -- 1064

"I turn off the computer during the day because of the following reasons: 1) The temperature is over 85 degrees indoors. 2) A power failure is likely to occur. 3) I don't think I would receive any more articles by leaving the computer on all day. 4) The computer is noisy when my wife is working at home during the day." -- 1065

"A fair amount." -- 1066

"Mixed, prefer foreground and background use." -- 1068

"I leave the machine on, often for 3-4 hours at night around 6-9 pm and sometimes (1/4 the time) in the day while I'm away. I don't leave it on constantly as the (1) disk/fan noise is bothersome (2) TV interference." -- 1070

"I only object to it when I am not at home. I find the fan to my computer annoys me if I have it on constantly when I am at home. I do not object to leaving it on at all during the day." -- 1072

"My major problem with leaving [the] machine on is more connected with the machine's location in a lab than it is with worries about wear on disk. The machine is also used to collect data and this tends to limit its overnight use." -- 1076

"Leaving my computer turned on so that I could receive data from the Boston CommInS would be a significant deterrent to my purchasing/renting any commercial CommInS system. I object to it for three reasons: my computer is noisy when on, the fan and other moving parts would experience extra wear-and-tear, and my computer heats the room significantly when turned on." -- 1078

"I object quite a bit to leaving my PC on so I can receive articles. The only time I have that I am not using [it] for other tasks is at night, and my office building, is subject to frequent power outages because it is still partly under construction." -- 1080

"Quite a bit. The noise and wear on the computer bother me. Faster transmission rates could help with this I suppose." -- 1083

"Not too much as we have 2 computers for 2 people and really only need 1-1/4 computers for our work. This may change in the future." -- 1084

"My main objection is that we cannot use the computer for other tasks while connected to CommInS. My second concern is wear and tear of hard disks, etc." -- 1086

"Don't mind except that we miss stories when other users are on the system." -- 1087

"The black box ... would improve the functionality of the system from marginal to highly desirable: I do not like to leave the hard disk running and I do not like the random capture of articles between intermittent runs of the system -- alternating with other PC applications. If the black box could be running concurrently with other PC applications, then 100% reliable capture of essential information is likely." -- 1088

"I would like to know how much wear and tear receiving articles causes. I always turn the video down to where the screen looks blank, as several people say the VDT will wear down quickly. My hard disk sometimes starts squeaking and so I'll turn it right off, but even when it's working well it's noisy enough to bother me if I'm working near it. I have no idea how much electricity it is costing and that should probably make a difference in leaving it on, too." -- 1090

"Not very much. The electrical expense is small, but I worry about storms." -- 1091

"Very much -- it is somewhat noisy and inhibits other work in same room when I am working away from the computer." -- 1092

"I don't object at all to leaving my AT compatible by AMT on all day -- a) it's under warranty b) I trust it. I do worry about the NCR PC compatible I'm currently using at home. It's flakier and unwarranted. I have no particular pattern to my use. I'm often away from home for days at a time, and rushed away when I am at home. I have been meaning to change my filter for about 2 months in a thoughtful way -- instead I think of something and make little changes, but not really spending the time to learn the commands and make the system of greatest use. My use of the system depends a lot on how much time I spend in front of a PC at work. If I do a lot of PC work, I don't want to look at one at home, even if I'm interested in the news. And I don't print stuff out much [... it is too] time consuming and noisy." -- 1096

## PRIMARY DATA FROM THE FIRST YEAR

"Right now my bedroom is too warm to run my PC all day and my power supply is too noisy for all night use." -- 1097

"I don't worry too much about leaving my computer on to receive data. I believe computers should be designed to handle this without a problem. But, I do not like leaving it on around the clock. ~12 hours a day, or a bit more is no problem." -- 1098

"Not a bit." -- 1100

"The reason I have not kept the CommInS system turned on 24 hours per day as I have in the past are twofold: 1) Our Compaq is located in a 'study'; actually a windowless dressing room off the master bedroom in our apartment. The heat thrown off by the compaq is noticeable. Concern about discomfort rather than wear and tear of 2 floppy drives or cooling fan. 2) I have been using the system quite frequently (several evenings per week). ..." -- 1105

"I would moderately object to the idea because I have experienced two hard disk failures in the past. Those failures were contributed to motor ceasing, worn heads, and worn media. Although most of the damages to the hard disk occur upon startup, I believe continuous operation of the hard disk would shorten its life due to the continuous heat buildup and the less than perfect alignment on the read/write heads. I however would be willing to leave the computer on so long as it is receiving useful data from the news service." -- 1106

"I [do] not [object] to leaving my computer turned on." -- 1107

"I have some objection to having to leave my computer on 24 hours a day to receive the news. The objection stems from the noise of the computer and not from any concerns over 'wear and tear' on the machine. I have an old XT with the fixed speed fan and it is pretty loud at four in the morning. The noise doesn't usually bother me but it does sometimes annoy my roommate. The inconvenience of leaving the computer on overnight is made up for by being able to have the latest news when I wake up. Leaving the computer on during the day is usually no problem as no one is usually around to be bothered by it." -- 1109

"I turn it on at night and leave it off during the day." -- 1110

"I don't object at all. I do it all the time." -- 1112

"I do not mind leaving my computer turned on to receive data from the Boston CommInS. Working most of the day, I have no qualms about leaving my computer on while I am away. When I get back, I still leave the computer on until I go to bed, or if I want to run an application program, I will exit from the news retrieval program and start the other one. I feel that if I am not using the PC for applications, then I might as well let it gather news off the air waves." -- 1116

"Only run it during office hours." -- 1117

"I have no problem having my computer on all the time to receive data. I turn the monitor screen off at night but otherwise leave it running. I don't believe that it harms the hard disk any more than turning it on and off every day." -- 1118

"I am quite hesitant to run my system for 24 hours a day because of the terrible experiences I have been subjected to. The reception has been fine and I feel the hard disk drive can run for extended periods without problems but I am very concerned with power transients here in the Cambridge area between 2 am and 3 am. You see, even with a surge protector, I have had 2 systems utterly DESTROYED by power surges! For this reason, I will not run 24 hours per day." -- 1119

"Leaving the computer on has not been a problem. Instructions are posted for turning the software back on, and it is left on overnight. I am not aware of what this means in terms of wear and tear on the hard disk. If I knew that this was a significant problem, I would probably value highly a black box alternative." -- 1120

"Not at all." -- 1121

"I limit the time that I leave my PC on. The MTBF for a hard disk system is only around 10,000 to 20,000 hours. I'm a graduate student who relies heavily on a PC for terminal sessions with mainframes. If my PC fails, it would be a major hardship." -- 1124

"Your question about wear and tear on computers is timely. I have not been using the BCIS system much in the past month precisely because of hardware (bug not hard disk) problems. Normally I have little objections to running the computer for long periods of time, but in the past few weeks my computer has been randomly resetting itself, probably because of line voltage

fluctuations or the high temperature and humidity. Given this problem, leaving BCIS running overnight, or for any long period of time, is not very practical. I have also just moved the computer to a different position that the BCIS RS-232 cable won't reach, making use of it impossible without rearranging the antenna installation. In short, my only problems with BCIS have been with my own computer, rather than the hardware or software. The 'average use' times given on the form represent roughly one week of constant use of BCIS, followed by 3 weeks of not using it much at all. In the next few weeks I hope to track down my computer problems, fix them, and get BCIS working again." -- 1126

"Don't have enough technical knowledge to evaluate the cost/benefit. I am generally leery of using the machine more than a few hours at a time." -- 1127

"In response to this month's essay question -- I do object to leaving my computer on all day to run BCIS. Since I use BCIS with RAMDISK, it's not a matter of wear and tear on the drives. I'm more concerned about the problem of burning out my computer, or whatever it is that happens. Maybe I'm just superstitious. Actually, it's the inconvenience of tying up my computer, getting in and out of BCIS, and copying from RAMDISK to real disk that are my more immediate reasons for limiting BCIS use." -- 1130

"Greatly, because other people may have to use it or might abuse it." -- 1131

"I don't have any specific objection to leaving my PC/XT turned on. In fact, I've found over several years that the reliability of the hard disk is considerably improved if the machine is left on continuously rather than cycled daily." -- 1133

"Leaving computer on is BEST way for frequent users having hard disks. The PROBLEM is dedicating the \$3000.00 resource to this task." -- 1134

"I find it difficult to leave my PC on overnights and especially weekends. Besides wear and tear on the power supply, disk, and monitor, my PC's fan bothers my office mates, it keeps the office warm, and even though MIT pays the electric bill, I feel guilty using up all that power." -- 1137

"I don't object to leaving my 'AT' on for long periods of time, but if the above 'black box' becomes available, I won't leave it on to receive, only to browse, read and print articles." -- 1138

"I frankly have no objection to it -- my problem arises from my hardware. The PC/XT on which I run the system has a fan with a bearing that is slowly, slowly dying. As a consequence, there is a noticeable noise emanating from the machine. This noise is never comforting, but it is particularly troubling when meetings are being held in the room where the PC/XT is. IBM will not replace the fan alone -- the power supply also must be changed and the cost of that is too much to support extended use of CIS. When the fan dies and the power supply must be replaced, I think my objections will disappear." -- 1139

"A lot (without multitasking capabilities)." -- 1141

"At the present time, I am devoting the use of the IBM solely to receiving the news and in participating in the experiment. I am captivated by the news being broadcast in this way and in the ability to filter the news I am interested in. ... I do not object to leaving the computer on so that I may receive data." -- 1144

"Not at all." -- 1148

"I don't like to leave it running although I understand that turning the hard disk on and off is more wearing than leaving it going all the time. I am particularly concerned about brown outs or lighting strikes and other surges in line voltage. A black-box approach would be better. Double-Dos is not [much better] because I need all my 640K to run Symphony properly." -- 1150

"Not at all!" -- 1152

"Not at all." -- 1153

"Wear and tear worries us a little, but computers are pretty durable, so not much. How much we leave it on depends on whether there is a news story that we really want to follow." -- 1160

"Generally prefer not to leave on for more than 6 hours unless plan to use for other work, usually turn off at night! Having program run in background would help." -- 1161

PRIMARY DATA FROM THE FIRST YEAR

"There isn't really any problem at this point since we have an extra machine." -- 1163

"I don't leave it on. I don't use it in the summer at all." -- 1164

"Very little, but have some qualms given electric costs and wear and tear on PC." -- 1165

"I don't worry about this; should I? (Perhaps it would be better to save wear and tear and power but it's worth it.)" -- 1174

"Not much -- but when I need to use the system, I would like to run CommInS in the background." -- 1197

"Not at all." -- 1198

## August 1986

**Question  
# Text**

	Responses	Minimum	25th %tile	50th %tile	75th %tile	Maximum	Average
43 My system has been operational ___ weeks	82	4.00	24.00	24.00	32.00	120.00	28.33
44 Average time spent using Boston CommInS during last month : Computer Receiving Data from Boston CommInS ___ Minutes/Day	79	0.00	120.00	300.00	600.00	1440.00	449.00
45 Average time spent using Boston CommInS during last month : Browsing Summaries caught by your Filter: ___ Minutes/Day	76	0.00	5.00	10.00	30.00	430.00	28.07
46 Average time spent using Boston CommInS during last month : Browsing Full Articles caught by your Filter: ___ Minutes/Day	76	0.00	5.00	10.00	15.00	120.00	13.87
47 Average time spent using Boston CommInS during last month : Reading Carefully Articles caught by your Filter: ___ Minutes/Day	76	0.00	5.00	10.00	20.00	60.00	14.36
48 Average time spent using Boston CommInS during last month : Printing Articles caught by your Filter: ___ Minutes/Day	74	0.00	0.00	0.00	2.00	120.00	3.80
49 Average number of articles found using Boston CommInS during the last month : Articles Caught: ___ Number/Day	78	0.00	30.00	60.00	120.00	2500.00	150.40
50 Average number of articles found using Boston CommInS during the last month : Summaries Browsed: ___ Number/Day	76	0.00	20.00	35.00	70.00	300.00	55.37
51 Average number of articles found using Boston CommInS during the last month : Articles Browsed: ___ Number/Day	76	0.00	6.00	10.00	20.00	100.00	19.86
52 Average number of articles found using Boston CommInS during the last month : Articles Read Carefully: ___ Number/Day	78	0.00	3.00	6.00	12.00	150.00	11.84
53 Average number of articles found using Boston CommInS during the last month : Articles Printed: ___ Number/Day	78	0.00	0.00	0.00	1.00	30.00	1.88

PRIMARY DATA FROM THE FIRST YEAR

55	I find that the information available is of: little interest--great interest	86	1.00	5.00	7.00	8.00	10.00	6.75
56	I use the system for: personal use--both--professional use	86	0.00	3.00	5.00	5.00	8.00	4.12
57	For important news, I rely on the system: not at all--some--exclusively	86	0.00	5.00	6.00	7.00	10.00	5.60
58	On the system, I use the summaries: not at all--some--very much	87	0.00	7.00	8.00	8.50	10.00	7.25
61	I find the software: difficult to use--OK--easy to use	87	0.00	5.00	7.00	9.00	10.00	6.89
63	On average, I have approximately this number of lines in my filter: ___ Lines	86	10.00	20.00	25.00	42.00	100.00	34.49
66	With the experiment underway, I use my PC: less frequently--the same--more frequently	86	2.00	5.00	8.00	8.00	10.00	6.45
70	I find the system has: no value to me--some--great value to me	86	2.00	5.00	7.50	9.00	10.00	7.19
71	I prefer to read the news: in newspapers--mixed--on the system	87	0.00	4.00	5.00	7.00	10.00	5.34
72	When looking for specific information, I prefer to: read the newspaper--use the system	86	1.00	5.00	7.00	8.00	10.00	6.75
73	When reading for general information, I prefer to: read the newspaper--use the system	85	0.00	3.00	4.00	7.00	10.00	4.64
74	On the system, I miss the stock prices: not at all--some--very much	86	0.00	0.00	2.00	7.00	10.00	3.74
75	On the system, I miss the graphics: not at all--some--very much	86	0.00	0.00	3.00	6.00	10.00	3.55
78	Signal strength and radio reception are: poor--adequate--excellent	87	0.00	5.00	9.00	10.00	10.00	7.64
79	I use the documentation: never--sometimes--often	84	0.00	5.00	5.00	7.00	10.00	5.53
80	I have shown the system to ___ friends.	85	0.00	5.00	8.00	12.00	50.00	10.47
81	I sit at the keyboard and use the Boston CommInS system ___ minutes/day on average.	83	0.00	15.00	20.00	45.00	150.00	32.92

---

54 On the system, I read more full articles from: New York Times [0] Associated Press wire [1]  
 [0] 35.00 [1] 29.00 Total 64

PRIMARY DATA FROM THE FIRST YEAR

62	To use the commands, I mostly: Use the Menus [0] Use the Keystroke Equivalents [1] [OTHER-2]							
	[0]	20.00	[1]	65.00	[2]		1.00	
64	On average, I change the lines in my filter: Never [0] Once/Week [1] Once/Day [2] More-Often [3]							
	[0]	18.00	[1]	62.00	[2]	6.00	[3]	2.00
76	On average, my filter lines contain: <3 words [0] 3-4 words [1] >4 words [2]							
	[0]	19.00	[1]	42.00	[2]	25.00	Total	86
77	I have my system tuned to hold: <50 articles [0] 50-100 articles [1] >100 articles [2]							
	[0]	11.00	[1]	34.00	[2]	41.00	Total	86

---

**I find that these three filter lines catch articles of the greatest interest to me with the greatest probability.**

business

\*

Any third world country currently in the news.

-- 1004

comput\*

movie\*

newsummary

-- 1005

(ibm and announcement) or (commodore and announcement)

commodore amiga

ibm and (pc or personal computer)

-- 1006

(subject: newsummary) (type: nyt)

(category: news) (priority: urgent | bulletin | flash)

diabetes | diabetic

-- 1007

military and electronics

defense and budget or gramm-rudman

military and intelligence or spy\*

-- 1009

(priority: bulletin)

ibm pc

boston commuter

-- 1011

Very hard to pin down-- I regularly read from a large number of lines

-- 1013

urgent, bulletin, news flash

boston, not sports

sports

-- 1014

ibm or compaq or (apple and computer) or atari

(subject: business digest)

wang or "data general" or "digital equipment" or honeywell

-- 1019

(subject: mortgage) or (mortgage and interest)

(discount rate)  
 (honda or mazda or wankel or "rotary engine")  
 - 1022

ibm or commodore or (comput)  
 wang or "data general" or "etc..  
 health risk  
 - 1024

(subject: russia or soviet or ussr)  
 (text: nigeria)  
 comput\*  
 - 1025

(subject: newsummary) (type: nyt)  
 "star wars" or sdi or "strategic defense"  
 massachusetts daybook  
 - 1028

video\* or dis\* or optical  
 india  
 apple or compaq or palantis  
 - 1032

news summary  
 [(priority: urgent or flash)]  
 commentary  
 - 1043

(type: nyt)  
 - 1045

ibm or apple or atari  
 wang or data general or digital equipment or analog device  
 urgent news | summary | post bulletin, etc.  
 - 1051

(priority: urgent) (not (category: sports or unknown))  
 compute\*  
 "star wars" or sdi or "strategic defense"  
 - 1057

(type: nyt) digital or ibm or computer\*  
 (type: nyt) jew or jews or jewish or hebrew or israel\*  
 (type: nyt) (review and (movie\* or film\* or vcr\*))  
 - 1065

innovations  
 philippines  
 MIT  
 - 1067

(category: news) (priority: urgent | bulletin | flash)  
 israel  
 aids  
 - 1068

weekend advance (type: nyt)  
 oxfam | quaker | weston & ma | jaffey & nit  
 pc | ibm pc  
 - 1070



PRIMARY DATA FROM THE FIRST YEAR

ibm  
travel  
china  
-- 1071

(subject: science)  
(subject: comput\*)  
(subject: chemistry) (~sports)  
-- 1072

(category: international news) (priority: regular | urgent)  
(category: washington news)  
(type: nyt) (category: commentary)  
-- 1075

(subject: interest rate)  
money  
computer  
-- 1077

librar\* | bibliophil\*  
(category: entertainment and culture | lifestyle)  
medicine | physicians | nurses  
-- 1080

space shuttle  
robotics  
weather  
-- 1083

britain or wales or england  
comput\*  
(category: news-- etc.)  
-- 1084

movies  
news summaries urgent  
depends on issue of current interest  
-- 1086

fda  
pharmar\*  
chocolate  
-- 1087

(category: news) (priority: urgent | bulletin | flash)  
(congress)  
(subject: gov finances)  
-- 1091

news flash  
nyt news summary  
personal finance  
-- 1092

ibm  
personal computers  
aids  
-- 1096

(category: news) (priority: urgent | bulletin | flash)

(subject: patents or technology)  
 "grand prix"  
 -- 1097

(category: news) (priority: urgent | bulletin)  
 physics | physicist\*  
 -- 1098

superfund  
 health (risk or effect)  
 -- 1100

(subject: nuclear)  
 (subject: aviation)  
 {(type: nyt)}  
 -- 1106

(category: news) (priority: urgent | bulletin | flash)  
 sex\* or child abuse drug  
 boston (not sports)  
 -- 1107

(subject: newssummary) (type: nyt)  
 (subject: mass\* digest) | "ap news digest"  
 (subject: satellite) | satellite  
 -- 1109

movies  
 local news  
 weather  
 -- 1110

(priority: urgent | bulletin | flash)  
 airline\*  
 columns  
 -- 1112

(category: news) (priority: urgent | bulletin | flash)  
 (subject: wall street)  
 (subject: movie\*)  
 -- 1116

nuclear or "arms control"  
 milit\* or defens and not (cat: spo\* | fin\* | advis\* | enter\*)  
 soviet | ussr and not (cat: spo\* | fin\* | advis\* | enter\*)  
 -- 1117

(category: entertainment and culture)  
 (category: lifestyle)  
 (type: nyt)  
 -- 1118

ap news bulletins (news summary)  
 business highlights  
 findigest  
 -- 1119

political or social change  
 (category: news) (priority: urgent | bulletin | flash)  
 revolution or economic  
 -- 1121

PRIMARY DATA FROM THE FIRST YEAR

(subject: business)  
(subject: patents or technology)  
(subject: wall street)  
-- 1124

red sox  
chernobyl  
mass inst tech  
-- 1125

(soviet | ussr | gorbachev) ~(category: sports) ~(category: advis\*)  
"star wars" or sdi or "strategic defense" or "arms control"  
(category: international news) (subject: ~soviet) (priority: ~regular)  
-- 1126

(subject: financial)  
nyt news summary  
-- 1127

((category: fin\*) | (subject: busi\* | finan\* | indus\* | market\*)) computer\*  
tax\* (law\* | legislation) (new | chang\* | revis\*)  
software | "computer program" | "computer programs"  
-- 1130

denmark or argentina  
ibm or compaq or (apple and computer) or atari  
wang or "data general" or "digital equipment" or "analog devices"  
-- 1131

videodisc | videodisk | interactive video | "cd rom"  
(subject: newssummary) (type: nyt)  
museum  
-- 1133

"This is too personal, don't you think?"  
-- 1134

ecc  
"cable television" or "cable tv"  
soviet union  
-- 1137

(category: lifestyle)  
(subject: patents or technology)  
(category: news) (priority: urgent | bulletin | flash)  
-- 1138

(category: news) (priority: urgent | bulletin | flash)  
(gm | "general motors") (not (category: sports))  
-- 1139

(subject: news digest) (type: ap)  
(category: international news) (priority: urgent)  
(category: washington news) (priority: urgent)  
-- 1144

"nuclear power" or "nuclear plant" or reactor  
"tax bill" or 3838  
wine and not houston  
-- 1152

aids  
science  
ecology  
-- 1153

tax reform  
news summary  
russia  
-- 1160

"urgent" news  
business digest  
-- 1161

nasa, space station, sdi  
spy  
space shuttle  
-- 1162

(category: news) (priority: flash | bulletin | urgent)  
(category: financial)  
dow jones  
vaseline | "black light" | twinkies | beer  
-- 1163

(subject: comput\*)  
(subject: bbn nets)  
"harvard business"  
-- 1165

Depends  
-- 1168

ibm  
-- 1171

Not currently using.  
-- 1173

astron\* or astrophys\* or paleontol\*  
(subject: israel\*)  
(subject: lewis column)  
-- 1174

(category: lifestyle | sports) and polo & not ("water polo")  
forecast\* & weather  
farm\* | ranch\* & (beef | cattle)  
-- 1197

---

**Write a short essay on how your use of the CommInS system has evolved over the last 6 months? For example: Do you use the system more or less? Do you use the system for different purposes? Do you capture different types of articles?**

"My use of the system has increased lately. I've got a new job with strange hours, so I'm either sleeping or working through most news broadcast! My new job demands, though, that I be up on the news hourly. I'm an editor who chooses news stories to go into an electronic summary from the ones written by our staffers on the Christian Science Monitor. ... It is very helpful." -- 1004

## PRIMARY DATA FROM THE FIRST YEAR

"I use the system about as much as I did originally. I tend to look for specific items I can't find in the newspaper, as well as the same type of articles I originally did." -- 1005

"When I first received the system it was treated as a new toy and used without any organization or purpose. Six months ago was the start of a transition from toy to useful tool. ... I found myself using more global filters on a specific topic and browsing summaries. Also, at this time I moved the system from my home to my office at MIT. ... My time to read articles was reduced to 20 minutes before work, and occasionally during 'mind breaks.' This pattern of use of the system started 6 months ago and continues until present. I add and delete filters according to current events, with the main use of the system to complement newspaper's coverage. I do use the system exclusively for announcements of new products. Usually these type of queries slip by me in the written media." -- 1006

"The system has been in my home now about 7 months and I don't look forward to giving it up if the project doesn't continue. It has done something that I've been trying to do for years, get my wife to use the computer. ... I change the filters every few weeks after capturing everything with the word 'the' in the article. This shows me almost everything coming across the line and I can further choose my filter lines. When there is a top news story I can put a filter in and catch everything having to do with that story. This is one feature that I like a lot. ... It's a great system and I am very interested in the direction it is taking and whether or not it will be continued." -- 1007

"... my interest in the system has remained undiminished. If anything, I have become a more sophisticated user, more likely to add, change or remove filter lines temporarily to capture articles on subjects of transient interest. I find the system easy to use, but there are a few software problems. It doesn't work with any of my memory-resident programs." -- 1009

I would say that, with the exception of a month or so of getting the hang of things, my usage patterns have changed very little. ... The main changes in my use of the system over time come from external pressures. There are sometimes whole months when I am too busy to spend time with the system, or when I am out of town for extended periods. ... Overall, I enjoy the system. I find that it has greatest value for keeping up with breaking stories, and for added depth on stories which aren't making the local papers. I still enjoy reading the newspapers, particularly the NYT and occasionally the Wall Street Journal. I find that reading a paper is generally more pleasant than using the computer, but each is valuable." -- 1013

"I find that in the past six months I have not altered anything about the way I use the software. I use the same filters, and spend about the same time each day. Once in a while I find a new filter of interest, and try it out. Most of the time I use it for sports scores, and news summaries of the day. Once in a while, I use it for weather." -- 1014

"In the beginning my use was relatively heavy due to curiosity about both the application and the data base. I found the keystrokes required to be less than natural -- but adequate. ... I got heavily involved in some work projects that dropped my newspaper, magazine and CommInS reading to a very low level. ... Resumed a moderate usage with more modest expectations as to total utility. Became more comfortable with changing the filter to reflect interest in a current topic or news event. ... By the way the use of a highlight on the words that caused the article to be selected is very useful, as is the (unread) label in the summary. I also find I don't use the system daily -- but rather weekends or on a weekday when a topic or major event on the morning radio or newspaper catches my attention. ..." -- 1019

"I first started using the system in early May when a close personal friend was in Kiev, USSR. During the recent Soviet Nuclear Crisis, I followed the events there very closely 'by using the system' and it proved to be extremely valuable to me. More recently, however, there has not been enough available computer time and personal time to use the system as I would like, and I have used it much less. I have only used it to browse articles under a couple of filters, primarily because I have not learned how to use the system to its fullest." -- 1021

"Initially, I used the program a great deal -- mostly as a toy. Now I use it for specific purposes: (1) search for articles related to my job (2) general interest of mine (3) Current events which attract my temporary interest. I use the program somewhat [fewer] times per week -- but more powerfully." -- 1024

"When we first started using the CommInS system the system had a considerable novelty value. We experimented several times with the filter lines until we obtained most of the articles we wanted. In the last six months our use of the CommInS system has changed in several ways. First, we are for the most part happy with the kinds of articles we are collecting. Second, we run the system for more hours. Most importantly, the way in which we read articles has changed. We have become more dependent on the

ComminS system for an overview of breaking news. We tend to skim newspapers more quickly and to rely on the news summaries to keep us abreast of the latest events. At the same time, we tend to devote more time and attention to articles on specific interest than we did previously. ... As a student of Soviet affairs, I find that the 'text' filter on the ComminS system catches articles that have references to the Soviets but which I would not normally read in a newspaper." -- 1025

"During the past 6 months, use of Boston ComminS in terms of the filter and pattern of use has been relatively static. This is largely due to a very demanding schedule of the computer as an important tool in the Middle School principal's office. ... During the next academic year the PC will be surplus to the school and its primary function will be devoted to demonstrating the utility of an electronic news service for High School Students." -- 1028

"1) Initial high plateau of use as experimented with possibilities. 2) Computer problems disrupted use. 3) Little time or need to use system personally recently -- but my students use it." -- 1041

"I leave my computer on 24 hours a day. I use CIS for browsing general news. I change filter usually to pick up news of current interest." -- 1043

"I have been using the system less frequently as time goes on. Part of the reason is that my PC is currently being used for something else. Anyway, I am returning my system since I am leaving MIT soon." -- 1049

"I change, refine, add and delete filter lines on a regular basis. Certain filter lines always remain others are added and then deleted a month or so later. Since using the system, I have enjoyed fulfillment of a gap in my receipt of a variety of news topics. Having heard a brief summary on the radio's news (or TV), I use this information to determine the need to add a new filter line, to broaden my information on any given subject. Naturally, I look forward to continuing my use of this fantastic source of information." -- 1051

"I use specific word filters more often now." -- 1052

"I have reported several times that I do not use the system in my office, I would gladly return it to you." -- 1056

"It is difficult to say that my use of this system has changed in any particular way since it was first installed. I use it fairly regularly, perhaps more regularly than when it was first installed. I am, of course, more efficient at browsing through articles than I was at first, so the system is used for shorter periods each day but for looking at more stuff. ... I have been very slow to modify my filter. With your prodding this month, however, I am starting to add more filter lines that match my professional inclinations. I have had a line to catch SDI type articles, I am adding one to catch electric power system type articles." -- 1057

"For the first 2 months I was adjusting my filters to optimize the classification of articles. ... My use has remained the same for the last 6 months. Since your last letter showed me how to use the alt-K, my style of reading has changed. I now read all the summaries for a filter, occasionally choosing an article to read. I delete after I've finished with a filter. This has greatly speeded up my use of the system." -- 1065

"Same. No. No." -- 1068

"We have been using the system about 10 times a month until our system cable failed. Over the past 6 months the system has been shown to over 50 blind and sighted persons." -- 1069

"I've greatly changed my filter. ... I'm now with time and experience able to scan faster. Suggestions: mark for deletion but defer execution, ditto for printing, add a transfer to disk." -- 1070

"Over the past 6 months my use of the system has become more refined. I have my filter set up so that it captures mostly articles that interest me. At the beginning, it seemed that I was capturing a lot of garbage. I still find it unnecessary and a waste of time to print articles from the system. The system seems like less of a novelty now. For example, I frequently use the system to check the weather before going out for the day. I find that I usually look at the system after I come home in the evening and that I read the newspaper in the morning. Thus, they are complementary." -- 1072

"I seem to be using my system less now than when the experiment began. When it was new to me, I was very interested and used it every day. To be honest, I don't think I would purchase this system or use it on a regular basis for the news. I work on a computer during the day, so it is more relaxing to go home and read a newspaper or watch the news on TV." -- 1077

## PRIMARY DATA FROM THE FIRST YEAR

- "My use level is about the same. I'm taking flying lessons now, so [I] spend more time checking weather forecasts." -- 1083
- "Over the past six months or so that we have had the CIS system we find that we have been using it more. Our PC is pretty much dedicated to the system while we generally rely more heavily on the AT for everyday work. Reading and scanning on the system is as addictive now as it was at the start. The early evening or late night TV news gives a hint of what may be of timely interest and appropriate filters are added to the filter." -- 1084
- "We use the system primarily to get the daily news on topics of our interest. It saves a lot of time of browsing the newspaper, when you are interested in specific news and don't have much time! We are using the system less now than when we started, in part because at the beginning we were exploring it, and in part because I guess now we are better at getting what we want from the system. Besides the 'hot' items, we follow pretty much the same news since the beginning." -- 1086
- "My use of the system has decreased as the novelty wore off and I became disenchanted with the idea of leaving my system on unattended for the entire work day. I don't feel it is worthwhile to leave the computer on overnight if the signals are not being broadcast all night long. I rely on the system more for science and medical articles and less for political and international news of interest. Since the latter is easier for me to find and read in the paper while the former are more sporadic -- except in the Tuesday 'Science Times': Is there a good filter to catch all the articles from the Science Times section? In addition: I use the system less since I became more active in using a modem which is sharing the same serial port." -- 1088
- "The evolution of my CommInS system has evolved slowly. The system started with about 14 filter lines. To deal with information overload, the last several months have been spent sub-dividing these filters into smaller areas, while at the same time ensuring that unexpected news items are caught. One example of a missed area was the bombing of Libya. While the usage of data has been relatively mellow to date, it has intensified due to the interest of my roommates. Now there are three people sharing the system and the types of topics received range from New York to India, cooking to HI-tech, and almost everything else. As a result, we are coming up with new filter lines that minimize browsing time, through the articles, and minimize missing article due to filters which are not sufficiently broad." -- 1091
- "My use is down radically this past 6 weeks or so -- I have a dissertation deadline September 1st. Since I am word processing all waking hours, I can't stand to share one PC. However, I eagerly look forward to letting my PC work on its own again come September 1. Also, I've just acquired a second PC which I hope to leave running with the receiver most of the time." -- 1092
- "I've gone from student to working in marketing for the summer. Neither give me a lot of time, but I mind being out of touch more with current events at work, and my job necessitates keeping current on some news areas. When I work on a PC all day, I don't want to see one at home, even if I want the news. This is ironically the biggest determinant besides free time in whether I check what's in my filter, or even if I leave the system up." -- 1096
- "When I first acquired the system, I used it too much (several hours a day). After the novelty wore off, I settled into about 30-60 minutes use per day. But, some days I skip. Occasionally, I'll skip 2 or 3 days (at most) at a time -- depending on how busy I am. ... As time has gone on, I have chosen new filter lines to capture subjects I had not thought of before. So, my interest has kept up throughout the experiment, and the types of articles that I capture have changed somewhat over the past few months." -- 1098
- "I use the filter much more selectively, ie. surgically, to catch stories on a precise topic. I use the system less for general topics." -- 1100
- "My use of the system has remained fairly constant. It has not changed my 'reading interests.' I am primarily interested in world as opposed to local news and business or economic as opposed to sports news. The system and associated filters allow user satisfaction. ... My wife is president of the Boston Mycological Club, we therefore have a filter category 'mushroom, mycology' an AP item several months ago provided us with the most detailed economic-production volumes domesticated and wild mushroom, for the US. Something we would never have obtained in newspapers or especially TV!" -- 1105
- "Initially I used the system primarily at night during which the reception is better in my area. I have since located a position in my apartment for the antenna such that signal strength and directional reflection is at the optimum levels throughout the day. My computer usage time had dropped prior to achieving this. ... This system set-up allows my return to using the computer as much as before the CommInS. The computer is turned on automatically every morning at 0500am. Articles are collected until about 7 am at which time I spend on the average of about 45 minutes to scan the articles before leaving for work." -- 1106

"I have found that I use the system more and more as a primary source of news and information. Where I would have used the radio or television to get the latest news, I now use the CommInS system. I find that the system is much better at finding the news that I'm interested in than I am when I read a newspaper. Still, I read the newspaper because it has the advantage of graphics. Also I find that I will sometimes read an article in a newspaper simply because it catches my attention. My purposes for using the system have changed of the last 6 months. I tend to use the system more for personal use now, while before I was using it more for school use. This change has occurred because of changes in my classes. I still use the system to capture the same kinds of articles as before, although I tend to use more general filter lines to try and 'broaden' the information I receive." -- 1109

"I use the system a little less than when I first started using it. But I still like using it. The articles I capture don't change very much, but I still look at them just as much." -- 1110

"When I first got the system, it was wonderful. All the things you wanted to know about, you could put in your filter and wait. Lately, even though I still tune the system to my interests, I find that the main source of interesting articles is the wire service and the 'week-in-review' articles. ... I find that the best way to find interesting articles is to read the newspaper; the things I find there are unexpected, and can't easily be programmed for in the filter. The system is deterministic; you tell it what you want, it reflects your current interests. ... I still use the system as my main source of news information, I still tune the filter about once a day." -- 1112

"My use of the CommInS has largely been determined by the amount of time I spend inside my dorm room. ... I think I used the service especially frequently at the beginning because of its novelty. After that period I fell into a regular routine of looking at the articles when I would come back from classes and just before I went to bed. I was and still am mainly interested in the headline articles and the news summaries. ... During the summer, my news reading habits have changed. I am not in my room very often so I use the news service less. However, when I do, I read more types of articles. My filter lines remain fairly stable, but I sometimes setup the special lines for hot news items. I noticed that the floppy disk drive I was using for storage was getting quite a lot of wear. Now the news service uses a ram disk to store articles instead of a floppy." -- 1116

"Less over summer, same purposes, little evolution except in complexity of filter lines." -- 1117

"My use of the system has become much more focused. I tend to do little exploring now that I have the filters set up to pick out what I am interested in. The use of the system has become much more varied in frequency. There are periods where I spend very little time with CommInS. Conversely, when events are occurring that pique my curiosity, I spend much more time at the machine. I wish for 2 things: 1) the ability to retrieve past information, 2) more financial information." -- 1119

"My use of the system has evolved only in detail -- Basically as a political scientist interested in certain phenomena and especially certain geographic areas, I get what I wanted in a filter quite early and have only marginally modified it. As for the usage, I find it grows but occasional unexplained failures in the system to load are annoying." -- 1121

"After an initial period of great excitement, I find now that I treat the system as any other medium. When I have time to scan articles, I do. But it's not a scheduled part of my day. Consequently, usage fluctuated dramatically over the monthly period between questionnaires. I change my filters when I find that I have been experiencing a 'dry spell' in the number of interesting articles captured by a specific line. Thanks for the filter line enclosed in the letter. Being an avid Sox fan, I'm sure it will become one of my favorite lines." -- 1124

"My use of the BCIS system has varied over the last 6 months for reasons having more to do with hardware and changing circumstances than the BCIS system itself. ... I find it a very useful system, despite the problems mentioned above [hardware in nature]. If these [hardware problems] had not occurred I expect I would be using the BCIS system even more than I do now." -- 1126

"My range of topic filter choices grows regularly, but my basic approach has stayed fairly constant. CommInS to me is like a news clipping service on a variety of topics on which I want to remain current. I don't use it for serious research. Overall, I would say my use is rather static." -- 1127

"I've shifted from brief initial use of floppies to RAMDISK based operation so as to minimize physical wear and tear. For the same reason, I also like to turn down screen and use beep-on-arrival. Initially I spent a burst of time setting up a decent filter. Now I seldom alter it. ... As it stands, I find BCIS is much more useful for getting general news than for finding specific information. This undoubtedly is due to the coverage of only NYT and AP sources." -- 1130



## PRIMARY DATA FROM THE FIRST YEAR

"Hasn't changed since last month." -- 1131

"I find that I read more analyses and articles from the Times but read the AP for news on developing stories (also local information). ... As an electronic news delivery medium I miss the information structuring capability ability in print media of page formatting and layout. ..." -- 1133

"First and foremost, I've built some skills at writing filters to catch the articles I want. Although I can't be sure of the missed detection probability, I do know the false detection probability is very low. I've also found my use of the system less driven by its novelty than by its usefulness. At first it was just neat -- now it helps with my research and studies." -- 1137

"During the past six months, use of my computer equipment has increased due to Boston CommInS software/hardware. ..." -- 1138

"The major evolution of my use of the CIS has been that I have become more selective/jealous of the time I spend on the system. While in the early months I would spend long periods of time reviewing any and all things that the system caught, I now am more likely to do a quick browse, and read only those articles which seem particularly pertinent. I also have found that I spend more time just discarding articles, rather than refining my filter. I find that I would rather get too many articles than too few, because I have gotten articles of interest with broad filters that I might not have gotten with more narrowly constructed filter lines." -- 1139

"We use the system about the same amount of time as we did at first. During especially heavy news times we have used it more. We generally sit down and read whenever we have a few spare moments, since it is often on gathering articles. ..." -- 1160

"Since the beginning, have tended to use the system less as the novelty wears off and the limits of the system are realized. But the time is now more effectively used given the better knowledge of the system and improved filters." -- 1161

"... So far, I have had the system for several months, and have found it to be of real value. The system is more useful than cable television, and much more useful than a rack of magazines. Having the ability to selectively search for information is very valuable to me, .... I use the Summary Window a lot more than I did when I first setup the system, as it allows much more quick scanning than does the Article Window. I have also started using the beeper facilities to alert me to the presence of choice stories or articles. All in all, I am loving the system more and more. ..." -- 1162

"My use evolved from high interest to no use at all. I really liked the system before because I receive no newspapers. Unfortunately, the antenna does not work through venetian blinds. In the summer months, it is useless to me because of this. I am looking forward to the winter to get it out again." -- 1164

"Due to a recent project which is requiring dedicated use of my PC by my wife, use of the CommInS system has been curtailed. Fears of hard disk crash from continuous use for commins reception also have played a role in use. ..." -- 1173

"In the scant 3 months I've been a system user, it has become for me a sort of constant home companion, increasingly useful. I rely upon it a great deal for specific information and for keeping me generally in touch with national and world news (less so for local issues). In my use of the filter, a configuration has grown that has both more categories and more specific detailing. As the presence of the system has helped rekindle and revive my old interests in several subject areas, I am delighted by its powers to communicate and convey information." -- 1174

"Have not had the system for 6 months." -- 1176

"I have become increasingly frustrated by short-comings in the software. More and more, I find myself forced to exit the system and copy articles into a word processor to prevent the system from losing them or trashing them. ..." -- 1197

---

## September 1986

---

PRIMARY DATA FROM THE FIRST YEAR

Question  
# Text

Responses	Minimum	25th %tile	50th %tile	75th %tile	Maximum	Average
43 My system has been operational ___ weeks 78	1.00	24.00	28.00	36.00	72.00	31.29
44 Average time spent using Boston CommInS during last month : Computer Receiving Data from Boston CommInS ___ Minutes/Day 76	0.00	120.00	280.00	600.00	1440.00	423.91
45 Average time spent using Boston CommInS during last month : Browaing Summaries caught by your Filter: ___ Minutes/Day 76	0.00	5.00	10.00	20.00	180.00	18.70
46 Average time spent using Boston CommInS during last month : Browaing Full Articles caught by your Filter: ___ Minutes/Day 75	0.00	5.00	10.00	15.00	120.00	14.44
47 Average time spent using Boston CommInS during last month : Reading Carefully Articles caught by your Filter: ___ Minutes/Day 75	0.00	5.00	10.00	16.00	120.00	15.61
48 Average time spent using Boston CommInS during last month : Printing Articles caught by your Filter: ___ Minutes/Day 75	0.00	0.00	0.00	3.00	180.00	4.92
49 Average number of articles found using Boston CommInS during the last month : Articles Caught: ___ Number/Day 77	0.00	30.00	60.00	120.00	1000.00	118.88
50 Average number of articles found using Boston CommInS during the last month : Summaries Browsed: ___ Number/Day 75	0.00	15.00	40.00	80.00	600.00	57.01
51 Average number of articles found using Boston CommInS during the last month : Articles Browsed: ___ Number/Day 76	0.00	8.00	15.00	20.00	250.00	20.26
52 Average number of articles found using Boston CommInS during the last month : Articles Read Carefully: ___ Number/Day 76	0.00	4.00	5.00	10.00	150.00	10.61
53 Average number of articles found using Boston CommInS during the last month : Articles Printed: ___ Number/Day 76	0.00	0.00	0.00	2.00	50.00	2.06
55 I find that the information available is of: little interest--great interest 85	1.00	6.00	7.00	8.00	10.00	7.00
56 I use the system for: personal use--both--professional use 86	0.00	3.00	5.00	5.00	10.00	4.69
57 For important news, I rely on the system: not at all--some--exclusively 85	0.00	5.00	5.00	7.00	10.00	5.55
58 On the system, I use the summaries: not at all--some--very much 86	0.00	6.00	8.00	9.00	10.00	7.34
61 I find the software: difficult to use--OK--easy to use 86	2.00	5.00	7.00	9.00	10.00	7.13
63 On average, I have approximately this number of lines in my filter: ___ Lines 85	7.00	20.00	25.00	35.00	160.00	31.96

**PRIMARY DATA FROM THE FIRST YEAR**

<b>66</b>	With the experiment underway, I use my PC: less frequently--the same--more frequently						
84	2.00	5.00	6.00	8.00	10.00	6.45	
<b>70</b>	I find the system has: no value to me--some--great value to me						
85	2.00	6.00	7.00	8.00	10.00	7.13	
<b>71</b>	I prefer to read the news: in newspapers--mixed--on the system						
84	0.00	4.00	5.00	6.00	10.00	5.08	
<b>72</b>	When looking for specific information, I prefer to: read the newspaper--use the system						
85	1.00	5.00	7.00	8.00	10.00	6.82	
<b>73</b>	When reading for general information, I prefer to: read the newspaper--use the system						
85	0.00	2.00	4.00	6.00	10.00	4.39	
<b>74</b>	On the system, I miss the stock prices: not at all--some--very much						
86	0.00	0.00	2.00	6.00	10.00	3.54	
<b>75</b>	On the system, I miss the graphics: not at all--some--very much						
86	0.00	1.00	3.00	6.00	10.00	3.61	
<b>78</b>	Signal strength and radio reception are: poor--adequate--excellent						
84	0.00	6.00	8.00	10.00	10.00	7.64	
<b>79</b>	I use the documentation: never--sometimes--often						
79	0.00	5.00	5.00	7.00	10.00	5.61	
<b>80</b>	I have shown the system to ___ friends.						
86	0.00	5.00	10.00	15.00	80.00	13.29	
<b>81</b>	I sit at the keyboard and use the Boston CommInS system ___ minutes/day on average.						
85	0.00	15.00	25.00	45.00	420.00	38.26	

<b>54</b>	On the system, I read more full articles from: New York Times [0] Associated Press wire [1]						
[0]	27.00	[1]	32.00	Total		59	
<b>62</b>	To use the commands, I mostly: Use the Menus [0] Use the Keystroke Equivalents [1] [OTHER--2]						
[0]	21.00	[1]	64.00	[2]		1.00	
<b>64</b>	On average, I change the lines in my filter: Never [0] Once/Week [1] Once/Day [2] More-Often [3]						
[0]	14.00	[1]	66.00	[2]	3.00	[3]	0.00
<b>76</b>	On average, my filter lines contain: <3 words [0] 3-4 words [1] >4 words [2]						
[0]	19.00	[1]	43.00	[2]	24.00	Total	86
<b>77</b>	I have my system tuned to hold: <50 articles [0] 50-100 articles [1] >100 articles [2]						
[0]	11.00	[1]	34.00	[2]	41.00	Total	96

I find that these three filter lines catch articles of the greatest interest to me with the greatest probability.

comput\*  
60 minute gourmet  
movie\*  
-- 1005

ibm  
commodore or amiga  
"personal computer" or pc  
-- 1006

(subject: newsummary) (type: nyt)  
(diabetic or diabetes)  
(category: advisories) (subject: digest)  
-- 1007

boston commuter  
ibm pc  
concord ma\*  
-- 1011

virus not aids  
-- 1013

honeywell or hon or honwell  
burroughs or sperry  
ibm or compaq  
-- 1019

(compaq or (convergent or (apple comp\*)) and not (category: financial))  
(lotus or "ashton-tate") and not (category: financial)  
(subject: comput\*)  
-- 1022

ibm or compaq  
health risk  
disabled and computer  
-- 1024

(text: election and (philadelphia or new york or chicago or los angeles))  
(subject: russia or soviet or ussr)  
comput\*  
-- 1025

mortgage  
baseball  
(category: new) (priority: urgent | bulletin | flash)  
-- 1028

videodis\* | "optical disk" | "disc"  
ibm | dec | apple | compaq  
india | pakistan | afghanistan  
-- 1032

(title: comput\*)  
(subject: comput\*)  
kasparov  
-- 1041

PRIMARY DATA FROM THE FIRST YEAR

newsummary  
urgent priority flash  
commentary  
-- 1043

(apple and computer) or (macintosh and computer)  
ibm or compaq or att  
lotus or microsoft or (software and computers)  
-- 1048

ibm or compaq or apple or computer or stari  
(category) news post bulletin post flash  
health risk  
-- 1051

"electric power" or "electric utility" or "nuclear power"  
"red sox"  
mit or "massachusetts institute"  
-- 1057

transplant\*  
blood\*  
-- 1059

(category: financial) (cronus or thorind or thor)  
(type: nyt) (reviews and (movie\* or film\* or vcr\*))  
(type: nyt) digital or ibm or computer  
-- 1065

\*Depends on story I am interested in especially 'copy right.'\* -- 1067

(category: international news) (priority: regular)  
(category: news) (priority: urgent | bulletin | flash)  
(category: advisories) (priority: urgent | bulletin | flash)  
-- 1068

computer  
handicapped  
lybia  
-- 1069

oxfam | quaker | weston & ma | jaffrey  
mica\* | ...  
(subject: fin\*)  
-- 1070

ibm  
travel  
-- 1071

(subject: compu\*)  
(subject: science)  
(subject: brit\*) or (subject: lit\*)  
-- 1072

((united states) | us) budget  
el salvador  
computer software  
-- 1073

(category: news) (priority: urgent | bulletin)

(subject: business digest)  
(subject: movie\*)  
-- 1075

osteopo\*  
science watch  
personal health  
-- 1076

mortgage  
health  
medical  
-- 1077

librar\* | biblio\*  
state & regional news  
fashion\*  
-- 1080

news priority  
britain wales england  
comput\*  
-- 1084

local news  
movies - theaters  
nutrition - health  
-- 1086

alzheimer\* or parkinson\*  
chocolate  
research triangle  
-- 1087

nutri\*  
scien\*  
jewi\*  
-- 1088

newsflash  
-- 1092

mit  
ibm  
personal computers  
-- 1096

(category: news) (priority: urgent | bulletin | flash)  
(subject: patents or technology)  
"imsa"  
-- 1097

(category: news) (priority: urgent | bulletin)  
physics | physicist  
(category: sports) mets  
-- 1098

superfund  
hazardous waste  
congress adjourn\*  
-- 1100

PRIMARY DATA FROM THE FIRST YEAR

(subject: chernoby!)  
(subject: nuclear)  
(subject: aviation)  
-- 1106

food & nutrition  
housing  
technology  
-- 1107

(subject: newsummary) (type: nyt)  
"star wars" | sdi | "strategic defense"  
(subject: satellite) | satellite  
-- 1109

movies  
news local  
weather  
-- 1110

"texas" or "dallas"  
(priority: urgent) (type: ap)  
(category: sports)  
-- 1111

(category: news) (priority: urgent | bulletin | flash)  
airline\*  
some filter line to catch an article announced in a "review world" or  
"articles planned" or "NYT page one dummy" article.  
-- 1112

(category: news) (priority: urgent | bulletin | flash)  
(subject: newsummary) (type: nyt)  
(ibm or compaq or (apple and computer) or atari)  
-- 1116

(category: entertainment and culture)  
(category: lifestyle)  
(type: nyt)  
-- 1118

(category: financial)  
(subject: credit)  
(subject: wall street)  
-- 1119

environmental protection  
epa  
water pollution  
-- 1120

(subject: africa)  
social or political change  
(category: news) (priority: urgent | bulletin | flash)  
-- 1121

(subject: wall street)  
(subject: business)  
(subject: patents or technology)  
-- 1124

red sox  
 patriots  
 celtics  
 -- 1125

(soviet | ussr | gorb\*) ~(category: sports | advisor\*) (date: [date -1 : 0])  
 (defense | military) & ~(category: sports | advis\* | regi\*) (date: [date 0])  
 (category: international news) (subject: ~soviet) (priority: ~regular)  
 -- 1126

financial  
 mass daybooks  
 supreme court  
 -- 1127

videodisk\* | ((laser | optical | video | worm) disk\*) | (cd rom) | "cd-rom"  
 software | "computer program" | "computer programs"  
 ((category: fin\*) | (subject: busi\* | finan\* | indus\* | market\*)) computer\*  
 -- 1130

videodisc | videodisk | interactive video | "cd rom"  
 (subject: newssummary) (type: nyt)  
 museum  
 -- 1133

(category: news) (priority: urgent | bulletin | flash)  
 soviet union  
 vcr  
 -- 1137

"mortgage rates" or "mortgage"  
 (subject: wall street)  
 (subject: business digest)  
 -- 1138

varies greatly with the news-- I follow current political events,  
 which come in waves.  
 -- 1141

(news digest) (type: ap)  
 (category: international news) (priority: urgent)  
 (category: washington news) (priority: urgent)  
 -- 1144

boston vicinity forecast\*  
 (subject: sports briefs)  
 (priority: urgent | flash) (category: not multiple)  
 -- 1146

israe\* or palest\* or plo or arab\* or leban\*  
 nica\* or salvad\* or hondura\* or guat\* or korea\*  
 philipp\* or vietna\* or cambod\* or liby\*  
 -- 1148

automobiles  
 records (not sports)  
 new zealand  
 -- 1150

(nuclear power) or (nuclear plant) or reactor  
 tax bill or 3838



PRIMARY DATA FROM THE FIRST YEAR

-- 1152

soviet  
newsummary  
mormon

-- 1160

urgent news  
wall street  
movies

-- 1161

strategic defense  
shuttle or satellite  
apple or ibm or computer

-- 1162

dow jones  
(category: financial)  
vaseline | "black light" | twinkies | beer

-- 1163

(subject: comput\*) (category: ~advis\*)  
(subject: fbn giants)  
(subject: (paris | france) & (explo\* | bomb))

-- 1165

computer industry  
nets  
usx

-- 1168

(category: state or local)  
"murder\*" or "killed" or "attack"  
ibm or compaq or (apple and computer)

-- 1171

astronom\* or astrophys\* or paleontol\*  
jews or jewish  
(subject: israel\*)

-- 1174

research university  
education university  
science technology

-- 1194

---

If you wanted to use the ComminS system to search classified advertisements pertinent to the Boston area, what lines -- or concepts -- would you want to include in your filter? (a) real estate, e.g., houses, condos, apartments? (b) employment? (c) automobiles, motorcycles, bicycles? (d) personals? (e) other topics of interest to you in the short- or long-term?

"I would be interested in items for sale -- cars, computers, furniture, services, possibly employment and personals." -- 1005

"All of the above. This does not mean I would use them all at once, but rather during the course of use of the system I will have need or probable need of the different services in the next 6 months. I would like to see 'classifieds' that would typically make the

magazine 'Want Ads' or the 'Sunday Boston Globe' newspaper. ... Also, I would like a convenient way to filter say, homes that are between \$100,000 and \$150,000 that are 3 bedrooms or more within the Greater Boston area. ... Last, if you have the ability to transmit, say the Globe's classified section, is it possible for a subscriber to Boston CommInS to append their own 'classifieds.' A benefit of this system might be the ability to call MIT via modem and append to a local 'classifieds' filter that is transmitted with the rest of the news services." -- 1006

"I feel classified advertisements would be a definite plus to the system. If I could set up the filter to only scan for those items that I'm looking for it would be a nice addition to the system. It would also be a nice feature to be able to create our own ads and submit them into the service (like a bulletin board system). It seems that with the addition of modem communications to search for articles this would be a likely add on." -- 1007

"The most important thing to me would be [the ability] to qualify the search to the area towns near my own. For example, I don't like to look at cars more than a 15 minute drive." -- 1011

"I'm not that interested in classifieds, but I would use them occasionally if available. It would be essential that appropriate wording be used in the ad's so filters could effectively catch them. The compressed wording and abbreviations in typical classifieds might be very hard to filter unless standards were enforced when the data was entered." -- 1013

"I would only search when seeking a specific item. Typical items for my family would be pets (dogs), employment (part-time, full-time), automobile, garage sales, camera equipment, computer equipment, ice skates. The ability to restrict the search effectively via the filter would probably depend on some standardization of the format or content of various categories of ads -- rental, houses, car, personals, etc. which would handle geographical location (zip codes?), dollar limits, etc." -- 1019

"I search printed classified ads only rarely -- probably would use it for 2nd hand purchases occasionally." -- 1024

"We wouldn't want to receive classified ads on the CommInS system, since we don't read them often enough to make it worthwhile. In a pinch we'd just use the newspaper." -- 1025

"Real estate by price, units and town. Employment by profession, location, salary and contact information. Automobiles by make, price, and year." -- 1028

"So do it! What about 'freeware' distribution in cooperation with BCIS? Public Service Announcements? Image transmission? (easy)" -- 1032

"I'm not sure if the current filter mechanism is adequate (or appropriate) for ads. I would really prefer something that would let me quickly peruse the last week of ads rather than anticipate what I want to see. Unlike the news, ads don't get stale quite as fast." -- 1034

"There are two sets of classified ads which are: 1) Large, 2) Not presently sorted, or not sorted well, 3) therefore, quite useful if on the air. These are: a) Help wanted in Boston Globe, b) Automobiles in Want Advertise, to a larger extent c) Real estate in the Globe. I don't need any of these right now. But when they are needed, this would be very useful! Also, is there any practical way to give some Boston area non-profits or schools a system, so that they could make searches for broader population?" -- 1038

"Huge win: put the Want Advertisements on line, and allow full text search, e.g., 'bookcases' may show-up under several furniture heading as well as 'moving' and 'misc.' Qualification by location is essential, e.g., location = Newton, Brookline, Wellesley, or Dover. That is the fine[st] idea I have seen for which I could usefully imagine paying!" -- 1040

"I might want to search ads (display as well as classified) on most any area or topic. Use would be intermittent but intense. Use would depend on system's ability to select the most interesting ads." -- 1041

"I think classified ads would be useful -- but there should be a way to suppress them if not wanted (e.g. a word match in a classified doesn't commit if you don't want to get ads)." -- 1043

"I wouldn't [use it]. I don't think that is the next set of information to be added. Much better would be: 1) TV listings, 2) stock quotations, 3) other sources of well written material." -- 1045

## PRIMARY DATA FROM THE FIRST YEAR

- "a) and c) as well as computer equipment and bargain basement." -- 1048
- "b) and d) and computer sales, and allied equipment and software." -- 1051
- "Used computers and peripherals and used amateur radio equipment." -- 1052
- "I am not the right person to ask: I never look at classifieds." -- 1057
- "As of now, not interested." -- 1059
- "At this time, I am not looking at the classifieds. Topics which I would like to scan include: movie reviews (after I see the movie), museum shows, specific topics I'm interested in." -- 1065
- "Real Estate and employment. You still need a better way than filters to retrieve stories!" -- 1066
- "Several times this past month I've had a problem using the system -- once, no articles were accepted; a different time (actually 3 times), no signal was read by computer (AT) although the receiver had a signal! Why? Very frustrating." -- 1068
- "Computers -- get ads of sales." -- 1069
- "Classified? Its worth would be determined to me only if: 1) it had many categories so I could get to items of interest fast without scanning a lot of other junk. 2) it gave hours to call and a phone number or had Email features via BCIS." -- 1070
- "I do not currently read the classified ads in the newspaper so I would not find them useful. If I were looking for a job or car or something they might be useful. Personals might be interesting." -- 1072
- "In general, I am not very keen on classifieds. If they were better coded (keyworded) than newspaper ones, maybe. Personals? no. Computer hardware and software -- new and used." -- 1073
- "I think classifieds would be a great idea especially real estate since you could quickly scan to get an idea of market and current costs. Likewise for automobiles, etc." -- 1076
- "Classified articles would be of interest to me -- I am especially interested in access by modem to NYT articles on your computer. In general, I've used the system very little in the past month -- summer activities, vacation, etc." -- 1077
- "I'd use CommInS to browse apartment listings: job listings, personals, maybe also: furniture and electronics." -- 1080
- "There would be little or no interest for us in the concept of classified ads. In terms of purchasing items a somewhat less than casual glance of the Sunday paper 'sale' items is sufficient." -- 1084
- "One great advantage of CIS ads over newspapers would be the possibility of pre-defining your area of interest, and thus get only the ads that match your needs; i.e., instead of having to search through 3 pages of real estate ads to find a 3-bedroom house with garage in certain area, you could define an 'ad filter' and get only those ads of interest to you. The same for employment, personal articles, etc." -- 1086
- "Actually would prefer not to have classifieds on our lab computer because it would be tied up with too many people using it for personal things -- but it sounds like a good idea for home systems." -- 1087
- "I am not interested in classified ads." -- 1088
- "Real estate -- to follow prices and listings in a certain locale -- would enable me to track investment possibilities." -- 1092
- "Access to Boston Computer Exchange database. Other than that, some means of doing a text string search (by dial-up) of current ads would be good, or do you think you could be broadcasting all ads? I have no particular category interest other than PC's, etc." -- 1096
- "A and B" -- 1097

"Definitely, real estate. Other items, sometimes. For the most part, I would not use this feature. I've never liked classified ads in general. Occasionally, I might use if for certain items -- maybe 2-4 times a year." -- 1098

"A) Yes, B) No, C) Maybe, D) Maybe. I think real estate has the greatest potential especially if one could set filters based on: price, town, number bedrooms, and lot size." -- 1100

"I think classified ads on the CommInS system is a great idea. Useful areas would be to set up individual reply mailboxes so as to allow messages and bids to be sent to the sellers." -- 1106

"A, B, and D. Subscribe[r] should have access to main frame data bank (via modem) to acquire or place sales 'item advertisement.'" -- 1107

"The classified advertisements that would be of the greatest interest to me would be other topics (used equipment) and real estate (houses and apartments). In general, I don't [use] the classified section very often. When I do use it, it is primarily when I'm bargain hunting for a particular piece of equipment. The ability to search for equipment online would be very powerful and helpful to me. I expect that in the future (after I graduate) I will be looking for housing. In that case, an online housing listing would be very helpful in finding the best housing." -- 1109

"I guess I would use the system for classified advertisement. Just like I will look in the paper [for] things I am looking for sale." -- 1110

"Please don't put classified ads on the system. I have seen a great number of bulletin boards and information go from being an excellent service to nothing more than an electronic classified ad section. While some users would have a use for this type of service, I think you would find that most would consider it a nuisance. Your system at this point in time is by far the best in the country. Please keep it that way. I realize that I did not answer your question -- but these are my thoughts on the idea." -- 1111

"For classified ads, I would want to search: by location for apts, garage sales, etc. Type of ad (autos, cameras, computers, machinery, apts, garage sales, etc.) A price range (perhaps) I feel that any more detail would not be productive, and depending on how you handle it, would be difficult, due to strange abbreviations one often encounters in classifieds." -- 1112

"All but D. Travel (airline, tours, etc.) information would be very useful with the continuously changing market and competition and chaos." -- 1115

"Classified advertisement filter line would be of incidental use to me. I would set up a filter line for a specific item that I needed to get in order to see if it were on sale at a store. For example, if I wanted to buy tennis shoes, I might set up a line to get all ads for sales on tennis shoes. Other than using the system for short-term items, I would not have much use for classified advertisements." -- 1116

"A" -- 1117

"I find real estate and employment ads to be the most helpful. I would much rather look through my computer for job opportunities than scanning the newspaper. I would also like very much to see the existence of support groups for various personal experiences [sic] appear in the filter." -- 1118

"I do not feel there is a need to set up a classified section in the system. I remain unconvinced that the system would provide better exposure than does the existing newspaper media -- Sorry to be such a pessimist!" -- 1119

"To search classified ads, I would enter in word form the make and model of what I was looking. For example, I would enter '85 Volvo' to locate the car from the ads. For apartments, I would search by area -- 'Back Bay,' 'Cambridge.' Used in this way, the CommInS program would save time. I would not initially use the CommInS program, however, I would use only after I know specifically what I want." -- 1120

"It seems to me that classified ads is not a market that would be very useful -- it is true that they are a like a 'bulletin board' but there may be too general an audience. If the classifieds had a narrower focus to the population concerned then why not call it a bulletin board?" -- 1121

## PRIMARY DATA FROM THE FIRST YEAR

"I would definitely use a filter line for houses. Perhaps, if a need arose, I would use a filter that would select information for a specific product that I need. But I rarely look at employment pages. Consequently, I doubt that I would be interested in accessing that information by computer." -- 1124

"I am not particularly interested in searching classified ads via BCIS because I am not currently in the market for anything. However, under some circumstances (e.g. if I have to move) I would be interested in real estate ads (particularly apartments). The For Sale section would also be, at least conceivably, of some interest. I have no interest in personals, employment (at this time), or automobile ads. In fact, it seems to me that the transmission time could be used for broadening the range of topics available on BCIS, rather than for classified ads. Random Notes: The increase in transmission power is quite noticeable. Here in West Newton it has dropped the error rate by about an order of magnitude, to about 0.1% to 0.2%." -- 1126

"Real Estate -- Extremely useful because it is time consuming to get accurate info. Useful info would be: 1) listings by location and type, 2) Recent sales info, 3) Services bulletin board. Others: Retail/Entertainment services: e.g. listing of ski areas, ticket prices, etc., campgrounds, restaurant guide with reviews." -- 1127

"We just bought a house recently, which led to a considerable interest in monitoring news on mortgage rates. Had there been any classifieds on real estate available, this would have been extremely useful to us. I can see how other categories of classifieds would be of great interest when one is in the market for specific services, etc. At the moment we are most interested in professional services for plumbing, carpentry, masonry, electrical, roofing, etc." -- 1130

"I would like to search for real estate and employment openings. Would this be from the Boston Globe? It would be nice." -- 1131

"Housing, entertainment -- dining, music, movies, etc., for sale (by category), personals (why not!), transportation -- car pools, ride sharing. What about an auction format? Auction could go on for 'n' days." -- 1133

"I do not see being involved with real estate, employers, vehicles or people. Other topics? maybe. HiFi, computers, machinery, investor wanted and legal notices re: liquidations and distressed properties at ridiculous prices." -- 1134

"I would not be interested in classifieds. It has been years since I've looked through that part of the paper." -- 1137

"I would consider real estate, personals, and employment listings to be a great addition to an already super service. In addition to the above items of interest, how about offering listings on: 1) Adult education programs or continuing education programs, 2) calendars of events similar to the Boston Globe's 'Calendar.'" -- 1138

"Frankly, I don't see the point. Unlike the news, ads of this type are not fast breaking or hard to locate in the paper. The only advantage I see is a detailed computer search of an ad that frequently is incorrect, or at least overstated." -- 1139

"Excellent idea! In order to facilitate searching, you might want to print out a more specific thesaurus/data dictionary of keywords. This would help avoid problems of synonyms." -- 1141

"I am interested in real estate specifically houses and condos and also [sic]. Employment opportunities. For employment, education, information library science, computer-instruction may be some of the filter lines I would be interested in. Houses in Massachusetts within specific regions would also be of interest." -- 1144

"Classified ads would and do add great value to any newspaper or other news service. The ComminS system is especially well fit for classified ads since the user group all have at least one similar interest. An IBM PC or PC compatible computer. Such a service not only could bring revenue to the news system, by charging fees for ads, but it also could increase the system demand. Being able to quickly sort through the classified ads, without shuffling an entire newspaper page around I would see as a definite advantage. The system is ideal for a classified ads system, and would greatly benefit by it." -- 1146

"This is of no interest to me personally." -- 1148

"Goings on -- organizations, trips, festivals, etc. Computer equipment/software." -- 1150

"It seems 'classified ads' should take advantage of the small user base with probably somewhat esoteric interests. The seller base for real estate, automobiles, etc. would almost certainly be too restricted and I would have to use the Globe. I suspect, however, that a

version closer to a bulletin board with meeting notices, concert notices, interest and advocacy group information, etc. would be frequently scanned." -- 1152

"a) and b). Appliances, professional services (contractors, home supplies), and bio-tech and high-tech employment opts specifically." -- 1153

"I'd like to see a reference system or reliable home services, appliance repair, auto repair, etc. with recommendations of users organized by geographic area." -- 1158

"Employment -- especially if you could specify what you were interested in -- this would be fantastic! I think having this 'edge' would be great. You would be up to the minute on the best job opportunities." -- 1160

"Not very interested in classified ads. Generally, may want to search by type (real estate rental, personal) and pertinent sub-categories (price, location, age) if supplied." -- 1161

"Seems to me that with the compression of classified ads filters would be of much less use, ie. 2 BR or 2 BedR or 2 BedRms." -- 1173

"As a homeowner, I would be especially interested in 'services offered' classifieds per timely needs, i.e., to find a plumber, a carpenter, tile repairer, cleaning service, etc. Local papers have been the most fruitful sources for these other than word of mouth." -- 1174

"I would be interested in adding the following filter lines: condos, employment, personals, cultural & religious events (more than you see in the Sunday listings)." -- 1176

"Not interested for ads." -- 1194

## October 1986

Question #	Text	Responses	Minimum	25th %tile	50th %tile	75th %tile	Maximum	Average
43	My system has been operational ___ weeks	118	2.00	4.00	28.00	36.00	92.00	23.20
44	Average time spent using Boston CommInS during last month : Computer Receiving Data from Boston CommInS ___ Minutes/Day	113	0.00	120.00	360.00	600.00	1440.00	448.77
45	Average time spent using Boston CommInS during last month : Browsing Summaries caught by your Filter: ___ Minutes/Day	115	0.00	5.00	10.00	20.00	180.00	18.17
46	Average time spent using Boston CommInS during last month : Browsing Full Articles caught by your Filter: ___ Minutes/Day	112	0.00	5.00	10.00	15.00	180.00	13.92
47	Average time spent using Boston CommInS during last month : Reading Carefully Articles caught by your Filter: ___ Minutes/Day	114	0.00	5.00	10.00	15.00	120.00	13.80
48	Average time spent using Boston CommInS during last month : Printing Articles caught by your Filter: ___ Minutes/Day	109	0.00	0.00	1.00	5.00	180.00	4.93

PRIMARY DATA FROM THE FIRST YEAR

49	Average number of articles found using Boston CommInS during the last month : Articles Caught: ___ Number/Day	112	0.00	30.00	60.00	150.00	4000.00	153.73
50	Average number of articles found using Boston CommInS during the last month : Summaries Browsed: ___ Number/Day	117	0.00	15.00	30.00	50.00	336.00	50.88
51	Average number of articles found using Boston CommInS during the last month : Articles Browsed: ___ Number/Day	115	0.00	8.00	15.00	30.00	200.00	23.59
52	Average number of articles found using Boston CommInS during the last month : Articles Read Carefully: ___ Number/Day	118	0.00	4.00	5.00	10.00	50.00	9.29
53	Average number of articles found using Boston CommInS during the last month : Articles Printed: ___ Number/Day	115	0.00	0.00	.50	2.00	40.00	2.18
55	I find that the information available is of: little interest--great interest	122	1.00	6.00	7.00	8.00	10.00	7.06
56	I use the system for: personal use--both--professional use	123	0.00	3.00	5.00	5.00	10.00	4.12
57	For important news, I rely on the system: not at all--some--exclusively	122	0.00	5.00	6.00	7.00	10.00	5.60
58	On the system, I use the summaries: not at all--some--very much	123	0.00	7.00	8.00	9.00	10.00	7.76
61	I find the software: difficult to use--OK--easy to use	121	1.00	5.00	8.00	9.00	10.00	7.37
63	On average, I have approximately this number of lines in my filter: ___ Lines	117	6.00	20.00	25.00	40.00	85.00	31.41
67	Using the system, I feel: awkward--OK--comfortable	119	2.00	5.00	7.00	8.00	10.00	6.71
68	I find the documentation: inadequate--OK--excellent	120	0.00	4.50	5.00	7.00	10.00	5.83
70	I find the system has: no value to me--some--great value to me	123	1.00	6.50	7.00	8.00	10.00	7.26
71	I prefer to read the news: in newspapers--mixed--on the system	123	0.00	5.00	5.00	7.00	10.00	5.39
72	When looking for specific information, I prefer to: read the newspaper--use the system	121	0.00	6.00	8.00	9.00	10.00	7.12
73	When reading for general information, I prefer to: read the newspaper--use the system	122	0.00	2.00	4.00	6.00	10.00	4.30
75	On the system, I miss the graphics: not at all--some--very much	120	0.00	1.00	3.00	7.00	52.00	4.32
79	I use the documentation: never--sometimes--often	120	0.00	6.00	9.00	10.00	10.00	7.83

PRIMARY DATA FROM THE FIRST YEAR

80	I have shown the system to ___ friends.	119	0.00	3.00	7.00	19.00	180.00	12.61
81	I sit at the keyboard and use the Boston CommInS system ___ minutes/day on average.	119	0.00	15.00	30.00	45.00	180.00	32.87
129	I use the modem connection for two-way access: not at all--some--every day	114	0.00	0.00	0.00	2.00	10.00	1.63
130	Of this time, I use the two-way features with my modem ___ minutes/day	111	0.00	0.00	0.00	2.00	50.00	3.00
131	Average number of articles found using Boston CommInS since the last questionnaire, via modem : Summaries Browsed: ___ Number/Day	75	0.00	0.00	0.00	1.00	50.00	2.99
132	Average number of articles found using Boston CommInS since the last questionnaire, via modem : Articles Browsed: ___ Number/Day	74	0.00	0.00	0.00	1.00	20.00	1.66
133	Average number of articles found using Boston CommInS since the last questionnaire, via modem : Articles Read Carefully: ___ Number/Day	75	0.00	0.00	0.00	1.00	10.00	.87
134	Average number of articles found using Boston CommInS since the last questionnaire, via modem : Articles Printed: ___ Number/Day	74	0.00	0.00	0.00	0.00	5.00	.28
135	Average time spent using Boston CommInS since the last questionnaire : Computer Receiving Data via modem: ___ Minutes/Day	104	0.00	0.00	0.00	4.00	600.00	9.41
136	The modem connection is: hard to use--OK--easy to use	50	0.00	4.00	5.00	8.00	10.00	6.10
137	I find the modem connection busy: never--sometimes--always	44	0.00	0.00	0.00	3.00	10.00	1.77

54	On the system, I read more full articles from: New York Times [0] Associated Press wire [1]	[0]	58.00	[1]	33.00	Total	91		
62	To use the commands, I mostly: Use the Menus [0] Use the Keystroke Equivalents [1] [OTHER--2]	[0]	42.00	[1]	78.00	[2]	1.00		
64	On average, I change the lines in my filter: Never [0] Once/Week [1] Once/Day [2] More-Often [3]	[0]	13.00	[1]	96.00	[2]	9.00	[3]	4.00
77	I have my system tuned to hold: <50 articles [0] 50-100 articles [1] >100 articles [2]	[0]	15.00	[1]	46.00	[2]	58.00	Total	119



PRIMARY DATA FROM THE FIRST YEAR

I find that these three filter lines catch articles of the greatest interest to me with the greatest probability.

(category: entertainment & culture)  
comput\*  
movie\*  
-- 1005

ibm or "i b m" or international business machines  
commodore or amiga or compaq  
(subject: movie\*)  
-- 1006

(subject: newssummary) (type: nyt)  
(category: state and regional news)  
diabetic or diabetes  
-- 1007

ibm pc  
health risk  
boston commute  
-- 1011

virus not aids  
ibm or "i b m" or "international business machines"  
(subject: scotus)  
-- 1013

honeywell or hon or honwell  
ibm or compaq  
(subject: business digest)  
-- 1019

ibm or compaq  
(category: news) (priority: urgent | etc.)  
health risk  
-- 1024

(subject: russia or soviet ~ussr)  
(text: elections and phil, nyc, la, or chi)  
(subject: harvard not sports)  
-- 1025

"hostage" & "iran"  
"digital" or "dec"  
"india"  
-- 1032

(subject: comput\*)  
(title: comput\*)  
artificial intelligence  
-- 1041

(type: nyt)  
-- 1045

ibm or compaq  
(subject: business digest)  
(apple and computers) or (macintosh and computer)  
-- 1048

news bulletin flash  
 ibm etc  
 weather etc  
 -- 1051

(category: urgent) (subject: not sports)  
 "red sox"  
 "mit" or "massachusetts institute"  
 -- 1057

(type: nyt) libya or syria  
 (type: nyt) digital or ibm or comput\*  
 (type: nyt) (priority: deferred)  
 -- 1065

ibm  
 travel  
 -- 1071

(subject: lite\* | brite\*)  
 (subject: science\*)  
 chemistry  
 -- 1072

(type: nyt) (category: news)  
 (type: nyt) (category: commentary)  
 (subject: wall street)  
 -- 1075

science watch  
 computer medicine  
 science q a  
 -- 1076

health  
 ap  
 computer  
 -- 1077

librar\* | books\* | biblio\*  
 religion | clergy | (methodis\* not sports) | bible  
 state & regional news  
 -- 1080

robots  
 space shuttle  
 urgent  
 -- 1083

financial digest  
 brit\* wales england  
 compute\*  
 -- 1084

baseball  
 art  
 movies  
 -- 1086

brain  
 diet

PRIMARY DATA FROM THE FIRST YEAR

chocolate  
-- 1087

nutri\* | diet\*  
medic\* | health  
jud\* | jewi\* | israel\*  
-- 1088

news flash  
newssummary  
financial summary  
-- 1092

(subject: patents or technology)  
(category: news)(priority: urgent)  
ski  
-- 1097

(category: news) (priority: urgent | bulletin)  
physics | physicist  
(category: sports) (mets)  
-- 1098

epa  
superfund  
health effects  
-- 1100

(subject: iran)  
(subject: seabrook)  
(subject: aviation)  
-- 1106

aids  
housing  
boston  
-- 1107

(subject: newssummary) (type: nyt)  
(subject: mass\* digest)  
(subject: satellite) | satellite  
-- 1109

movies  
weather  
-- 1110

"dallas" or "texas"  
(type: ap) (priority: flash | urgent | bulletin)  
(category: sports)  
-- 1111

red sox  
(subject: news) (category: urgent | flash | bulletin)  
What I program to catch from advisories.  
-- 1112

(category: news) (priority: urgent | bulletin | flash | regular)  
(subject: news summary) (type: nyt)  
(subject: movie\*)  
-- 1116

defense and military  
 soviet union and defense  
 adi or star wars  
 - 1117

(type: nyt)  
 (category: lifestyle)  
 (category: entertainment and culture)  
 - 1118

"environmental protection"  
 "americas cup"  
 "epa"  
 - 1120

revolution or economic  
 (subject: africa)  
 political or social change  
 - 1121

( : wall street)  
 ( : patenta | technology)  
 ( : science\*)  
 - 1124

red sox  
 patriots  
 mit  
 - 1125

(soviet | ussr | gorb\*) ~ (category: sports | advis\*) (date: [date 0])  
 (defense|military) & ~ (category: sports|advis\*|regis\*) & (date: [date 0])  
 ("star wars" | adi | "strategic defense" | "arms control") & (date: [date 0])  
 - 1126

financial  
 supreme court  
 mass daybook  
 - 1127

personal names  
 company names  
 foreign countries  
 - 1134

soviet union  
 telephone company  
 cable television  
 - 1137

"mortgage rates"  
 (subject: wall street)  
 massachusetts daybook  
 - 1138

varies greatly with the news-- changes week by week with political events  
 - 1141

(subject: news digest) (type: ap)  
 (subject: international news) (priority: urgent)  
 health risk

PRIMARY DATA FROM THE FIRST YEAR

-- 1144

(subject: weatherpage)  
(subject: digest briefs)  
(subject: sports briefs)

-- 1146

israe\* or palest\* or plo or arab\* or leban\*  
nica\* or salvad\* or hondura\* or guat\* or korea\*  
phillipp\* or vietna\* or libya\* or ayri\*

-- 1148

automobile  
australia or zealand  
mass and institute

-- 1150

"nuclear plant" or reactor  
tax bill or 3838  
"animal rights" or "animal welfare"

-- 1152

economics  
soviet  
mormon

-- 1160

(subject: wall street)  
(subject: business minor | business highlights)  
(category: news) (priority: urgent) (date [date 0])

-- 1161

shuttle  
spy  
satellite

-- 1162

(priority: urgent | bulletin | flash)  
supreme court (category: not advisories)  
(category: financial)

-- 1163

(subject: comput\*)  
names of individual companies I follow  
marketing & comput\* (category: ~advi\*) (subject: ~(advi\*|dia\*|br\*|high\*))

-- 1165

mass daybook  
red sox  
(type: ap) (subject; news summary ~rhode)

-- 1181

(category: news) (priority: urgent | bulletin | flash)  
(subject: frontpage)  
(subject: fbc)

-- 1184

financial  
dollar  
wall street

-- 1187

(category: news) (priority: flash | urgent | bulletin)  
aids  
category: sports\*  
summary briefs  
-- 1188

research university  
science technology  
mit  
-- 1194

flash bulletin ...  
ibm  
star wars  
-- 1196

gold | gem  
tax & not mass.  
-- 1197

computers  
chinese  
mit  
-- 1201

"san jose" or "santa clara" or "san mateo"  
(subject: column)  
(subject: foreign affairs)  
-- 1202

commentary  
arts | entertainment  
news briefs  
-- 1204

exchange rates  
forecast  
-- 1205

news digest  
urgent / priority  
-- 1207

(category: finan\*) (gm | amc | chrysler)  
(category: news) (canada | vancouver | ottawa)  
-- 1208

not sure yet  
-- 1209

(category: news)  
wall street  
mass news  
-- 1210

computer\*  
"word processing"  
"information processing"  
-- 1211

Demonstrat\* or protes\*

PRIMARY DATA FROM THE FIRST YEAR

generat\* and electric\*  
alternative  
-- 1213

(category: domestic)  
(category: news)(priority: regular) (not forecast\*)  
(category: news) (priority: urgent|bulletin|flash) (not forecast\*)  
-- 1214

nicaragua  
sdi  
frontpage  
-- 1215

news summary  
health risk  
sdi  
-- 1216

international news  
america's cup  
seattle  
-- 1218

ibm  
financial news  
wang, compaq  
-- 1219

wine  
movie reviews  
tv tonight  
-- 1220

news category  
lifestyles  
sports  
-- 1221

information on computers  
-- 1222

japan or japanese  
ibm  
china  
-- 1223

(category: news) (priority: ur\* | bu\* | fl\*) (date: [date 0])  
(category: news) ("south africa" | mali) (date: [date 0])  
(category: entertainment culture) (date: [date 0])  
-- 1225

(subject: newssummary)  
israel  
mit "massachusetts institute"  
-- 1227

fiji or vanuatu or papua or "new caldonia"  
(category: international news) (priority urgent)  
israel, priority urgent, (not sports)  
-- 1228

health  
 "square danc\*\*"  
 nuclear  
 -- 1229

forecast\* boston vicinity  
 health risk  
 (subject: movie)  
 -- 1230

nicaragua  
 child health  
 central america  
 -- 1231

financial news on stocks I hold  
 business news on companies I consult for  
 red sox  
 -- 1232

(subject: architect\*)  
 (category: news) (priority: flash)  
 ibm or compa or (apple and computer) or atari or wang or ...  
 -- 1233

(subject: bbo)  
 (category: news)  
 (subject: wall street)  
 -- 1234

advisories  
 computer industry or software  
 antitrust or intl. trade commission  
 -- 1235

news flash  
 wall street  
 movies  
 -- 1236

mit  
 west germany (category: not financial)  
 sdi or (strategic and defense and initiative)  
 -- 1237

ita\* (category: not sports)  
 ibm pc  
 heath risk  
 -- 1240

hazardous waste  
 boston  
 -- 1241

"aviation" | "airplane" | "jet"  
 (subject: comput\*)  
 "general aviation"  
 -- 1242

people  
 travel



PRIMARY DATA FROM THE FIRST YEAR

tech\*  
-- 1243

(subject: comput\*)  
cambridge [date -2]  
software  
-- 1244

not (category: sports)  
city and state names  
-- 1246

---

**Have you used the new two-way system with your modem to query the master database of stories transmitted from the New York Times in the last 90 days? Will you please tell us about your experience with the new features? For example, we are interested in learning your overall impressions concerning (i) the features -- or lack thereof, (ii) the ease of use -- including comments on the manual and the screen prompts, and (iii) the coverage of the database. We are also interested in learning if and how the two-way features have changed your use of the one-way system -- or if they have changed your reading and listening habits regarding regular newspapers and TV network news, respectively.**

"Yes, I tried it once so far. It couldn't find a weather report, which I felt it should find. The manual was weak on how to download over the modem. I really like the idea of the database, sometimes you need info now, not whenever it comes in. I will have to explore it further. Could you put the setup parameters for CIS to run on desk view concurrently over the radio on the CIS subject. I am having trouble getting it to work and it would really improve my use of the system." -- 1005

"I just received the system at the end of October. It would be best if the question was asked again soon (next month). My first impression from the write-up is that it will be a great service for researching a specific topic, or to play catch-up if one is away from their PC for a long duration." -- 1006

"Haven't had a chance to use it yet." -- 1007

"On the modem, I miss: Highlighted words, ability to store articles and summaries, page breaks for multipage articles when printing, ability to print from summary screen, rapid response time going from summary to full article. However, even with these limitations, it's a great feature!" -- 1009

"Have not used it." -- 1011

"I've used it a couple of times. Some trouble controlling when it dials, and some unintentional dialing when lost in the user interface. Some trouble figuring out that Alt-H would force a hangup. On the whole, it's workable for me. The pre-ready from the modem is useful -- I wish the system could retain articles found, as I've had it to re-retrieve a few when I thought they were already stored. Rules when you can print a remote article are confusing. I use this service only very rarely for very specific subject related queries -- but at least once it was extremely valuable." -- 1013

"I haven't tried the modem capability yet. I will bring one home and try it. The new keyboard assignments are much better and make the system easier to use, especially the ability to select and execute directly from the pop up menus." -- 1019

"Sorry -- haven't used the 2-way system -- will try it out in November." -- 1024

"We have used the two-way system two or three times. The manual was not very clear about what needed (or more accurately, did not need) to be done by people using a Hayes SmartModem to communicate. Repeating the information that no special setup was necessary in the appendix that discussed querying the remote data base would have been helpful. Nonetheless, we were able to gain

access to the remote data base without any problems. Concerning the features present on the remote system, our main comment is that it would be useful to be able to store the summaries in such a way that one could return to the summary window and then go back to the results of the remote query without having to go through the entire query again. Otherwise we haven't used the system enough really to have opinions about the coverage or features. It seems a very useful service to have, however. So far, the two-way features have not changed our reading and listening habits. They have made us less concerned about accidentally deleting articles we wished to keep." -- 1025

"No. I haven't had the time to use it yet. But, I definitely will." -- 1032

"Have not tried it (modem). I have restarted system after being inactive for ~4 months. I still find that a big problem is the time needed to cull out the potentially relevant articles from the 'junk' (to me) picked up by the filter lines." -- 1038

"Since we have only one port, it's a little tricky. The master database is a big enhancement over simple broadcast, but 90 days is still limited for good retrospective searching and you need an inverted file for fast response." -- 1041

"I haven't used it yet." -- 1045

"No modem yet. New version installed 11/2/86." -- 1047

"Not yet tried. Will do so soon." -- 1051

"I have not used the two-way system yet, but hope to. I have not obtained a copy of the new software yet. I was out of town during most of October, and only used the program for one hour during the whole month. I returned as of October 1st, and was looking forward to increased use of the system. However, this didn't happen in Oct., but might in subsequent months if I get the software soon enough." -- 1052

"I took one shot at it, got about 100 summaries in a database, and then was just overwhelmed. Ran out of time and have not played with it again. Trouble is that the filter line is, in many cases, too short to narrowly define a topic." -- 1057

"I just received my new software, I haven't used the remote connection yet." -- 1065

"The main advantage to me of the modem access to the database is ... Now, I can just ask for the previous days main stories from memory. ... Again, I think there is a major advantage of the new system and that is freeing the reader from dependence on having to be on line enough to catch stories of interest." -- 1068

"I haven't used it extensively with the modem. Waiting for upcoming move to new location -- office in Boston or Lab. I like the new printer support." -- 1070

"The modem is far more useful than the radio receiver. With the modem, I see no useful purpose for the receiver." -- 1071

"Problems with system: 1) only NYT, it would be much better to have AP too as the two services complement each other. 2) Cannot download file and look at it later. I dislike printing articles, but find myself forced to because I want to refer to some things later. 3) Adding the date and type specifiers to the line lengthens it so much that it is no longer acceptable. Solution -- allow multi-line filters. 4) My communications software (ProComm) supports Com3. It would be nice if the system did too. Good things: 1) Lately I have been running long digital simulations on my computer and am unable to keep the system on when I go to lab. Allows me to catch some things I have missed. 2) I like the fact that I can usually get through. 3) I can locate previous articles that I didn't save when broadcast, like movie reviews." -- 1072

"I haven't had a chance to hookup a modem to the system I use for ComminS, so I can't comment yet. The software is better." -- 1073

"Have not used two way system yet." -- 1076

"I have not used the modem yet, but definitely will as soon as I find the time. It is [of] great interest to me." -- 1077

"I enclose no answer to the essay, because the questionnaire and the new software arrived simultaneously by mail. I have not used the modem feature because I have not yet had the opportunity." -- 1080

## PRIMARY DATA FROM THE FIRST YEAR

"For the moment my modem is broken. I'll let you know next month how I like using it (assuming it gets fixed)." -- 1083

"We have not used the two way system as the modem is down. However, we are looking forward to using it. Manual (documentation) is reasonable. I find the keystrokes easier to use as the menus are in filter same place [sic], but cannot keep track of a lot. Duplicate items still keep cluttering up the files. Stock quotes would complement the data base nicely." -- 1084

"I have very little experience with this feature so far." -- 1086

"A -- The least clean instructions for me were on how to use the modem with only 1 serial port being shared between the subcarrier frequency decoder and the modem. B -- I was disappointed that the 'retrieved' files can not be directly saved as text files. C -- I find that the system is infinitely more useful to me now. ... D -- Can the time span of the backward search be modified to less (or more) than 90 days." -- 1088

"I've just received my Everex 1200 baud modem -- plan to install it this week -- ask again next month." -- 1092

"No modem." -- 1097

"I haven't used it (yet)." -- 1098

"No experience." -- 1100

"My modem has been out of operation due to problems with my com ports. I'll resubmit this essay after I gain more experience with the system." -- 1106

"No modem." -- 1109

"It has not changed my reading or listening habits I think the screen keystrokes are good and the manual is easy to read overall. ..." -- 1110

"I have just received this new disk, and have not had much of a chance to use it. I will answer this question on the next form." -- 1111

"Unfortunately, I don't have a modem. I would like to get one soon." -- 1112

"Don't have a modem yet." -- 1115

"I am sorry, but I do not have a modem so I have not used the two-way system." -- 1116

"Haven't had the new software long enough to get used to the modem system, but the documentation leaves something to be desired. Moreover, the function key changes are very confusing. Instead of, or in addition to, saying what keys have changed, you should have included a simple listing of what the new keys do, that can be posted next to the machine." -- 1117

"I really enjoy the new software and the modem capability. This is a tremendous improvement over the 'first flight.' I find the menus to be a good idea -- my wife can now use the system much more easily! The manual has also improved with the more detailed descriptions. The modem connection has profoundly influenced my use of the system. I find I rely almost solely on the modem for specific information and use the radio hookup for general news reception. The NYT coverage has been very good -- I only wish there was a way to pull out financial statistics and stock prices. The fact that I now have the ability to query the 90 days of NYT is the reason I like the system so much -- I feel the only reasonable use for the radio systems is for dissemination of real time information as is the case with Lotus Signal." -- 1119

"I have not yet used the two way communication yet, because I am waiting for a return call [from] the hotline." -- 1120

"Yes, I used the modem connection once. I liked it. I plan on using it more in the future. I was confused about its usage, though. I thought one could upload from the database to the user's hard disk. I would rather do this than read on line. I was told on the hot-line that this was policy. I think there are probably ways around this, (ie. redirection of printer port to file), but I haven't tried it yet. I tried to print an article. The result was mixed. The system only printed part of the article, and a message said something like 'Full article not transmitted.' That was annoying. The modem possibilities mean that I will never miss another article transmission. I like that security." -- 1124

"I have used the remote database connection a few times in the last month, and have found it quite useful. There are a few minor problems with it, though. First the menu that pops up when the query is first submitted gives a date range of -90 to 0, and there seems to be no way to change it before the request is submitted. Subsequent searches (once the connection is made) can be conducted in a more restricted time frame, but some way of changing the default (other than editing config.txt) would be appreciated. Second, I find that the filter lines are still too short, especially when the date filter is added. Third, there doesn't seem to be any way to stop the search once it has started, which seems to be a waste of computer time. On the topic of ease of use, the remote connection is OK, but could be made a bit easier. When in remote mode, the menus should display all remote commands. For example, the hangup command is only displayed on the options menu, not on the remote summaries menu. On the hardware side, I am currently running an external modem and the receiver from the same serial port, and switching between them is a nuisance. Coverage is OK, given that it is an experimental system. Obviously more information would be better, but the present service is very useful. I have found that the remote query facility is very useful for catching up on news that I have missed." -- 1126

"Sorry, I don't yet have a modem." -- 1127

"I love the convenience of being allowed to neglect my machine and then snatch defeat from the jaws of success -- I mean stuff my head with all that stuff the MIT brain has soaked up in the meantime. ~~More~~ 90 days are not yet up, however, I am still postponing this wonderful happening. Sure hope it works as advertised. (P.S. Be prepared for the Christmas rush, I'll be leading the onslaught.)" -- 1134

"Not yet, though I plan to soon." -- 1137

"Don't own a modem, sorry!" -- 1138

"I missed the meeting -- so I haven't used this new facility." -- 1139

"Not yet -- looking forward to trying it out!" -- 1141

"My modem operates at 300 baud. I use telecommunications in my work. When my 1200 baud modem arrives I will definitely access the two-way system. Sorry this is late, I had to hook up the new software which works great. I even took some of your filter lines and added them to my filter." -- 1144

"No, I have not used the two-way system yet, but I have recently reacquired my modem and I am really looking forward to trying out the new database with the two-way system. I am hoping to try the two-way remote system this weekend. When I have tried it, I will send you my reactions." -- 1146

"I don't have a modem and am really not familiar with the new features." -- 1148

"No adequate experience yet." -- 1150

"Relatively little use so far. Only difficulty was inability to hang up [until I found the command at the back of the manual]." -- 1152

"During the last 3 months, I have used the system for only a few minutes a week on average due to time dependent work." -- 1153

"Haven't used yet." -- 1159

"We don't have a modem -- sorry -- we wish we did -- there's a chance will have one soon." -- 1160

"I have only used it once given the time consuming connection process if you don't have a Hayes modem and done with only one serial port. Would prefer CIS to handle sign on with non-hayes as well. Separately, have found with the new software a small problem. After reading/browsing an article and moving on to another category, using <F4> produces the previous summary screen, whereas <enter> does not." -- 1161

"I have not used the two-way system." -- 1162

"The 'query-everything-in-last-three-months' facility is a pleasant complement to the up-to-the minute AP wire. Though the NYT

## PRIMARY DATA FROM THE FIRST YEAR

database is not as up-to-date or 'hot' as what comes over the radio, three-month's worth of articles and a surprisingly fast query processing make up for that. At home it would seem undesirable since it ties up a phone line, but in an office with many phone lines, that's no problem... The keystrokes seem to have been changed to be like Lotus 1-2-3, but I find them no more intuitive than the last ones. Suggestion: <Return> goes 'down' a level, while <escape> goes 'up' a level. Before, expanding a summary into an article could be done by <esc> <esc>. Now, the keystrokes are either /<return> or Alt-R.. I like <esc> <esc> the best. ... The 'Bounce' screen saver is very handy, since we have the program running all the time." -- 1163

"No modem." -- 1165

"Sorry, I haven't used the modem system yet -- I'm waiting for a Hayes compatible modem for the XT, and have been spending my time trying to get my system to receive packets! Hope to use the modem system soon, regardless of packet problems -- I've been away at conferences for 2 weeks! Please see copy of my letter attached -- I am willing to purchase a receiver to improve selectivity so that I can receive the packets! Please let me know what you suggest! Thanks so much for your efforts so far -- " -- 1180

"I don't have a modem. I am a new PC user. Prior to getting your system I had not thought seriously about buying a modem. I am now very interested in getting a modem." -- 1181

"The modem provides a needed complement to the FM receiver. In order to access specific information more quickly, recommend the following: (1) Publish a master catalog of filters to be transmitted daily or accessed with modem, (2) Similar to Library of Congress cataloging system, create more discrete subject filters so information can be accessed from different perspectives. When the Boston CommInS is ready for commercialization, the users manual could be restructured for the novice. .... My interests are primarily business and financial info. With the accumulation of data coupled with a greater number of access windows, Boston CommInS would provide greater visibility of data." -- 1187

"Unfortunately, I have not had the opportunity to use the 2-way system yet." -- 1192

"My new system is not working. Help." -- 1194

"1) It's surprisingly fast. At 1200 baud I expected it to be a dog, but the apparent lack of ACK/NAK protocols makes it pleasant. 2) Please get rid of snow on the IBM CGA!!! Drives me nuts. 3) I get frustrated with the limited length of the input line; my filter has some 60-70 char topics, and when I try getting matches via the modem, CIS appends the source and time fields and then can't cope with the long line. 4) I'd like a mode where I can leave the system unattended for an hour or two and have it download the articles matching my filter via the modem. I can't use the receiver hardly at all because of multipath problems, so the modem is very important to me." -- 1199

"I didn't know about this feature. I'll try it out this next month." -- 1201

"Sorry, but I don't have a modem yet. Instead let me tell you about my impressions of the system. I had no problem installing the hardware. The instructions/trouble-shooting section were excellent. I am not, so far, relying on the system for my news. It is still easier to scan through the Times or the Globe, reading articles that catch my eye, than it is to guess in advance what topics interest me and make filter lines. However, the system is wonderful for collecting information on a specific topic -- it does all the work." -- 1202

"I have made little use of the modem connection, partly because I am too lazy to keep disconnecting my modem from the radio receiver link and partly because I find that, assuming I read the documentation correctly, I can access information only up to 90 days old. I am enjoying the regular, off-the-air service immensely and I found the software virtually transparent after just a few days use. There are a few changes I would love to see in it though, and if you'll permit me, I'd like to list them: 1) A means of marking blocks of copy and storing them in separate files for later use. 2) An un-do feature for restoring a mistakenly deleted article. 3) An on-line search facility, like that in a regular word-processor. 4) An on-line editing feature for deleting and/or adding some notes to some of the contents of a given article. 5) A way of changing on screen the margins of articles. 6) A way of getting from reading an article back to the summary at the point you entered it. 7) A gateway to DOS. 8) A way of doing background printing with an EPSON LQ-1500 printer. 9) A way of indicating what line of an article is currently being printed. 10) A way of marking selected articles within a summary and then deleting them all at once, rather than one at a time. 11) A way of limiting the number of articles in a given category without having to fill up available storage first." -- 1204

"It is not specific enough for some of my interests. I still watch evening news on TV, but find myself spending newspaper time at my PC. I would love to see a system that would include some data that is now commercially available, such as real estate search."  
-- 1205

"Having the system has probably increased my news availability, but I do not read the newspaper less or watch TV news less than I used to. The system has simply expanded my news awareness. One thing I wanted to comment on -- at first impression, I did not find the manual or software that easy to follow -- I think the manual could be expanded to put less detail on each page -- to have a step by step use of the software and use of the receiver and the modem setups -- But I still think the whole thing is great." -- 1207

"Documentation on setting up the connection was only fair. Thru trial and error I found out which file to edit to change the phone number to dial. Using modem line is awkward. Many of my filter lines are too long to be used, due to extra items that are automatically added. Even after editing down this default addition, I still encounter problems. Some of my filter lines which are accepted do not function properly, since the remote system's support of the query language is not complete. I often forget to hang-up the modem connection. However, my biggest problem with the modem link is crashing the system, when I browse summaries or articles, I have developed a habit of alt-d to delete junk. In remote mode, this crashes the system." -- 1208

"Have not been able to get the remote modem to operate." -- 1209

"I'm used to online searching and depend on it. So, the addition of the NYT full text is great. Wish it could go back more than the 90 days -- and wish we could search more databases. Finding problems with modem connection: connects fine the first time, but then, often, it cannot connect even though it keeps trying. If you could have the program running continuously in background I'd just use it more. Using system -- both AP and NYT -- feel I'm much more up-to-date, much more attuned to what is happening -- and more in control than having some editor select my 'news.'" -- 1210

"I tried the two-way system only one time. It was obvious that I would have to spend more time learning the query language to use it successfully. To date I have not had the time -- just as I haven't yet successfully fine tuned my filter lines. This aspect takes experience and experimentation. I know what I want to catch, but in some cases I feel that I miss things or catch way too many stories." -- 1211

"I have just completed removing some extensive glitches in my system associated with and resulting from a system reconfiguration and upgrade. I plan to initiate my modem connection before the end of this week and can better address my reactions after that. However, having used the system for ~5 hours, I foresee getting easily hooked on it." -- 1212

"I have no modem, therefore I have not used the two-way system." -- 1213

"1. When inserting filters into the system interactively, the assignment of existing articles is shifted to the filter above the correct one. 2. Is the date on the article the date of transmission or is it the date it was posted on the news service? 3. A better description of how to use the remote system is needed. 4. The ability to rebuild the database should also be invocable from inside the program so that if a filter is added interactively, an attempt can be made to match existing articles in the database. 5. The display of the summaries should include the category and subject. 6. Allow the user to turn off filters without removing them from the filter database. 7. To allow better fine tuning of the filters, longer filter lines are needed. 8. The CIS command line parameters should be valid in both upper and lower case. 9. Allow the user to define the keyboard use to suit their needs. 10. When rebuilding a database, if the files were not read as ASCII files the process might be quicker. I hope that the above will help." -- 1214

"My serial port has been out of commission for most of the first month of this experiment and thus my usage has been minimal. I intend to use it more. I have not used a modem for the system yet." -- 1215

"I am a new user and have only used the two-way system a couple of times. I could really not fairly comment at this early point."  
-- 1216

"I use the modem only occasionally. Since the software does not treat quoted phrases properly on modem searches, I am unable to screen out articles effectively. The coverage seems to be quite good on those occasions I do use the modem. The documentation and screen prompts are clear." -- 1217

"I have only used the 90 day feature once, to cull recipes from the NYT. I am not as interested in old news as new news and thus

## PRIMARY DATA FROM THE FIRST YEAR

have had no cause to use it. It should also be possible to save from database to disk. Also, 1200 baud seems very slow compared to normal speed." -- 1218

"No, have not yet used 2-way system. Planning to do so next month." -- 1219

"Yes, about three times. Had several problems with: 1) Latency of updating screen. 2) Queries too long when source and date added 3) Limited life of articles. 4) Attempting to delete articles crashed system. 5) Took awhile to find out how and when to hang up. Phone link is most useful when: 1) System has been off for awhile 2) To provide information for new filter item." -- 1220

"Only recently have I hooked up the modem, and am still experimenting with it. I think the screen prompts are easy to understand. Also, I now find that I watch the local and network news much less often than before the study. My main interest is the weather and if some way could be found to transmit the satellite pictures, it would be great!!!" -- 1221

"Have not yet used two-way system." -- 1222

"I haven't yet tried this feature, but plan to do so soon." -- 1223

"I have not used the two-way feature, because I have only one com port and an external modem. Because my CPU is on the floor (to cut down on the sound) it's inconvenient for me to switch from radio to modem. I have, however, ordered an I/O board which will provide an additional serial port and permit me to try the database query system." -- 1225

"I have only used the two-way system a few times, usually when I'm searching for something very specific. For the most part, I was very impressed with the ease of use and the results of the query. One thing which I found lacking though, was the ability to transfer an article from the main database onto my local database. This would allow me to read the articles carefully and/or print them at my convenience instead of only while I'm online with the main system. I think that this feature would add greater flexibility to the two-way system." -- 1227

"I am a new user, and I do not have a 1200 baud modem. Other thoughts, though -- I really like the system. I am still learning how to tune my filter, but like having a couple of big categories at the bottom. However, when a major story is going on, I find 2 problems. One, I get multiple copies of the exact same story, all tagged urgent. The second problem is that there can be many copies that are simply updates of the same topic." -- 1228

"My evaluation time has only been 2 hours. I have to dial manually. 1) The old news feature is good. I do not have time to read newspapers daily and this ables me to 'catch up.' 2) The manual is not a user's guide. It is a functional description of the capabilities. 3) The data base is very good but I do use others." -- 1229

"I have not yet tried the two-way system. This is due in part to having only a single serial port on my PC and in part to the modem being tied up with other duties on another PC. I have the fortune of being able to devote the system PC entirely to CommInS." -- 1230

"I am still awaiting the arrival of a modem I have ordered. I haven't used this feature." -- 1231

"Yes, I tried to use the two-way system. I used it for one retrieval and my compaq blew up!! Because of a trip to London, I haven't had time to get the video unit fixed, but I will do so in the next week or two. It looks like a terrific feature, though." -- 1232

"I do not have a modem." -- 1233

"I have not used the two-way system." -- 1234

"I've used the remote file only three times, and one of these was for the purpose of learning its use. The other two were for 'backfill' on new filter lines being added. Every couple of months I have occasion to make on-line bibliographic searches. At theses times I expect to use your remote file also, though usually the things I'm looking for will be more than 90 days old. To me the real benefit of your remote system is peace of mind. First, it makes it easy to retrieve items which caught my eye, but I didn't save. Also, I have set my filters fairly narrow, knowing I can go back and retrieve something if the filter misses it." -- 1235

"I haven't set this up. I am a first time user just getting used to the basic system and making it work. We've had antenna problems. We've hooked our system up to our hugh TV antenna. We're still getting some unframed packets." -- 1236

"We are still waiting for an MIT extension that would allow us to use the NYT databases. We anticipate using the database extensively for looking at particular topics. Less so for general perusal of the news." -- 1237

"First, even though I have Hayes compatible, I still have to use a communication protocol to dial out. I use the PC at work and 'receiving data from the air' is slow, unless you know that exactly at 10 there is a news bulletin etc. There should be a simpler version of the program with less options because eventually one settles for some desired filters and does not need all the other possibilities embedded in the system. Reading news should not be something one should be involved in -- like sitting next to a PC and devoting all the time to it, hence glancing at a newspaper or listening to the radio is more fun to me. The data base of the NYT is nice. It would be nicer to have classified ads as well. Overall, I do not use the system much, say 50 minutes per week-10 days, and not daily. If this situation will continue I will probably return the system in 1 or 2 months." -- 1238

"I haven't tried the modem system yet -- I'm still trying to get the radio system to work -- it's quite frustrating. I had my doubts about the 'regulation' antenna working because 1) I'm about 1/2 mile outside Route 128; 2) I'm on the side of a small hill; 3) my building is maily concrete with no accessible windows. When I hooked up the system, I was receiving unframed packets. The Hotline person told me it sounded like an antenna problem, so I went to Radio Shack and bought their best outdoor FM antenna and had it installed on top of the roof, aimed at Boston. No Luck. I called the Hotline again -- Dave Segal returned my call and said that I should hook up a regular radio to the antenna and try to get the station on that. I did so -- at first, there was a lot of static, but when we turned the antenna, it came in loud and clear. Confident of success, we hooked the antenna up to the computer again. Unframed packets. I've called the Hotline since then, but no response yet." -- 1239

"1) I received my system in October 1986 and have not been able to use it to its full capability, due to a hard disk failure and an initial delay because I needed to buy and amplified antenna. 2) I can't answer this question because I haven't used the modem yet. 3) You didn't allow enough time to answer the questionnaire by the due date. 4) I find the software manual to be poorly organised and incomplete. There should be an index. The query examples are limited. 5) Queries should be able to extend over more than one line. I find that I am unable to create precise enough queries in a single line." -- 1240

"I don't have ready access to a 1200B modem, so I haven't been using the two-way system at all." -- 1241

"Ease of use is excellent. Documentation is almost nonexistent and no help at all. Have not used enough to know how good the database coverage is. Features are adequate for the job -- not exciting but they get the job done. Only use the two-way to search for something very specific. So far, it has not contained what I was looking for, but I've tried it twice." -- 1242

"Have not used the two-way system." -- 1243

"1) Works well -- easy to use. I'd like to be able to search for additional things with the current query without having to re-execute the query. For instance if I ask for all the articles with (subject: movie\*) later I want to look through all those articles to find the ones which contain a particular key word. 2) Of course this could be much better if it went back further than 90 days." -- 1244

"I've not yet. Looks good." -- 1246

## November 1986

### Question # Text

	Responses	Minimum	25th %tile	50th %tile	75th %tile	Maximum	Average
44 Average time spent using Boston CommInS during last month : Computer Receiving Data from Boston CommInS _____ Minutes/Day	122	0.00	60.00	240.00	720.00	1440.00	436.16
45 Average time spent using Boston CommInS during last month : Browsing Summaries caught by your Filter: _____ Minutes/Day	117	0.00	5.00	10.00	20.00	180.00	16.81



PRIMARY DATA FROM THE FIRST YEAR

46	Average time spent using Boston CommInS during last month : Browning Full Articles caught by your Filter: ___ Minutes/Day	115	0.00	5.00	8.00	15.00	180.00	13.31
47	Average time spent using Boston CommInS during last month : Reading Carefully Articles caught by your Filter: ___ Minutes/Day	118	0.00	5.00	10.00	10.00	120.00	11.50
48	Average time spent using Boston CommInS during last month : Printing Articles caught by your Filter: ___ Minutes/Day	114	0.00	0.00	1.00	5.00	180.00	4.34
49	Average number of articles found using Boston CommInS during the last month : Articles Caught: ___ Number/Day	118	0.00	25.00	50.00	100.00	4000.00	147.44
50	Average number of articles found using Boston CommInS during the last month : Summaries Browsed: ___ Number/Day	116	0.00	10.00	30.00	60.00	555.00	49.11
51	Average number of articles found using Boston CommInS during the last month : Articles Browsed: ___ Number/Day	115	0.00	5.00	10.00	25.00	125.00	18.36
52	Average number of articles found using Boston CommInS during the last month : Articles Read Carefully: ___ Number/Day	117	0.00	2.00	5.00	10.00	50.00	9.19
53	Average number of articles found using Boston CommInS during the last month : Articles Printed: ___ Number/Day	117	0.00	0.00	0.00	2.00	30.00	1.91
55	I find that the information available is of: little interest--great interest	122	1.00	6.00	8.00	8.00	10.00	7.22
56	I use the system for: personal use--both--professional use	125	0.00	3.00	5.00	5.00	10.00	4.15
57	For important news, I rely on the system: not at all--some--exclusively	124	0.00	5.00	6.00	7.00	10.00	5.76
61	I find the software: difficult to use--OK--easy to use	125	0.00	5.00	8.00	9.00	10.00	7.17
63	On average, I have approximately this number of lines in my filter: ___ Lines	118	8.00	20.00	30.00	39.00	100.00	32.33
67	Using the system, I feel: awkward--OK--comfortable	125	0.00	5.00	7.00	8.00	10.00	6.74
70	I find the system has: no value to me--some--great value to me	125	1.00	6.00	7.00	8.00	10.00	7.16
71	I prefer to read the news: in newspapers--mixed--on the system	125	0.00	5.00	5.00	7.00	10.00	5.56
72	When looking for specific information, I prefer to: read the newspaper--use the system	126	0.00	5.00	7.00	9.00	10.00	6.85
73	When reading for general information, I prefer to: read the newspaper--use the system	124	0.00	3.00	4.00	7.00	10.00	4.62
79	I use the documentation: never--sometimes--often	126	0.00	7.00	9.00	10.00	10.00	8.06

PRIMARY DATA FROM THE FIRST YEAR

81	I sit at the keyboard and use the Boston CommInS system ___ minutes/day on average.	122	0.00	15.00	20.00	30.00	180.00	30.84
129	I use the modem connection for two-way access: not at all--some--every day	124	0.00	0.00	0.00	1.00	10.00	1.15
130	Of this time, I use the two-way features with my modem ___ minutes/day	117	0.00	0.00	0.00	1.00	50.00	2.33
131	Average number of articles found using Boston CommInS since the last questionnaire, via modem : Summaries Browsed: ___ Number/Day	86	0.00	0.00	0.00	1.00	250.00	5.82
132	Average number of articles found using Boston CommInS since the last questionnaire, via modem : Articles Browsed: ___ Number/Day	82	0.00	0.00	0.00	1.00	50.00	2.40
133	Average number of articles found using Boston CommInS since the last questionnaire, via modem : Articles Read Carefully: ___ Number/Day	83	0.00	0.00	0.00	1.00	10.00	.77
134	Average number of articles found using Boston CommInS since the last questionnaire, via modem : Articles Printed: ___ Number/Day	83	0.00	0.00	0.00	0.00	5.00	.36
135	Average time spent using Boston CommInS since the last questionnaire : Computer Receiving Data via modem: ___ Minutes/Day	117	0.00	0.00	0.00	0.00	45.00	2.88
136	The modem connection is: hard to use--OK--easy to use	66	0.00	1.00	5.00	8.00	10.00	4.80
137	I find the modem connection busy: never--sometimes--always	59	0.00	0.00	0.00	3.00	10.00	1.61
138	I run the CommInS as a background task: ___ Minutes/Day	103	0.00	0.00	0.00	0.00	1440.00	42.23
140	On average, I use the modem connection: less this month--same--more	109	0.00	0.00	2.50	5.00	10.00	3.10
141	With the new software, I find printing stories: hard--OK--easy	90	0.00	5.00	8.00	9.00	10.00	7.16

54	On the system, I read more full articles from: New York Times [0] Associated Press wire [1]	[0]	60.00	[1]	39.00	Total	99		
62	To use the commands, I mostly: Use the Menus [0] Use the Keystroke Equivalents [1] [OTHER--2]	[0]	39.00	[1]	83.00	[2]	1.00		
64	On average, I change the lines in my filter: Never [0] Once/Week [1] Once/Day [2] More-Often [3]	[0]	16.00	[1]	88.00	[2]	13.00	[3]	2.00

PRIMARY DATA FROM THE FIRST YEAR

77	I have my system tuned to hold:	<50 articles [0]	50-100 articles [1]	>100 articles [2]			
		[0] 15.00	[1] 49.00	[2] 56.00	Total		120
139	I run the CommlnS as a background task under:	Double-Dos [0]	DesqView[1]	Not Applicable[2]	Other[3]		
		[0] 9.00	[1] 6.00	[2] 79.00	[3]		2.00

**Do you run the new CommlnS software as a background task under either Double-DOS or DesqView operating systems? If yes, please tell us about your experience. If no, please tell us about your interest in such an arrangement in the future.**

"I really want to run the program in the background using DesqView. I tried to install it but couldn't get it to work. Could you put the installation data out on the CIS group over the radio or in the newaletter?" -- 1005

"I have neither Double-DOS or Desqview operating systems, thus I don't run the CommlnS software as a background process. Currently, I have two PC's, one that I use quite frequently, the other less often. During the idle time of the less used PC, I run the CommlnS software. This is an expensive way to acquire multiprocessing. I will be losing one of the machines, leaving me with a PC AT. I would use the CommlnS as a background process if I had an operating system that would support it (Double-DOS or Desqview), but I don't. I will continue to run the CommlnS mostly at times I am not using the AT such as lunch, late afternoon, or over the weekends." -- 1006

"I have been running CommlnS under Double-DOS and find it really beneficial. I mainly use the 2 partitions so I can dial up bulletin boards, but still receive the latest news. With the screen blanking feature in this version, it makes Double-DOS even more attractive. I tried running under Desqview but had some problems. As soon as I configure my new AT system I'll try it again." -- 1007

"Do not now have background software. I would indeed like to not have to exit CIS to work with another program." -- 1009

"No" -- 1011

"The idea sounds OK, but I'm not interested enough to invest any money in Double-DOS or Desqview. My PC is free enough of the day that I capture more than I can read anyway." -- 1013

"No, however I feel it (running in the background) will be very important to the successful use of this type of capability. Then you can use the PC when and how you wish without feeling that you must choose to 'interrupt' the monitoring of stories. Sort of a feeling that if I switch now, then there is a break in the continuity or completeness of the activity. (Even though intellectually I know it doesn't matter; however, I even have trouble throwing out old newspapers without reading them)." -- 1019

"Don't have Double-DOS or Desqview -- Sorry. New disk: easy to use and articles are coming in twice as fast now. Better broadcasting." -- 1024

"We have never run the CommlnS software in the background and do not own Double-DOS or Desqview, but we would definitely be interested in trying such a combination." -- 1025

"I haven't run the CommlnS software in background mode yet. But I hope to." -- 1032

"Not yet, but I plan to try it in future. (I have Desqview and 2 Meg of JRam-2 Memory). I suspect that my PC may not be powerful enough though." -- 1038

"I haven't used the system much since the new software was distributed. The reason is that I haven't been able to get it to work with my Microsoft mouse, and I find it quite inconvenient to use with it's command interface." -- 1040

"Our PC is only lightly used now so we don't need background now. It would be very useful if the PC were heavily used for other functions." -- 1041

"Have tried Double-DOS and Desqview but without perfect results. Hard crash after a while." -- 1043

"Would be interested. Sometimes I forget to start CIS when I leave for the day." -- 1047

"I would be very interested in such a feature because the limiting factor in my use of the system is the time it takes to get in and out of it." -- 1048

"Not yet. At present, I would be interested in doing so, and have been looking for Double-DOS, but have been unable to find it. (I would need to pre-test it with my speech output software). It might be helpful, when I am working on MIM or Lotus, to be able to run CommInS too. As my computer is configured, restructure might be complicated, due to my need for a speech program at all times." -- 1051

"No, but I would be very interested in doing do." -- 1052

"I do not at present have a multi-tasking operating system and so have no such experience. I am somewhat skeptical about the likelihood that your program would run acceptably in the background, however, because it seems to grab the disk for relatively long intervals while it is running in single task mode. I am about to upgrade my hardware (to an AT) and may try multi-tasking with more cycles available." -- 1057

"I plan to use Desqview but am temporarily blocked since my office computer (with good reception) does not have a hard disk and instead uses Remote Virtual Disks over the local network. The problem is that there is not enough memory to hold all the active pieces of program when running CommInS system in the background, while trying to use reasonable sized programs (e.g. 128K) in the foreground. When I get a chance I will check out my options in the situation. At home I am still blocked because of 1) poor reception and 2) no hard disk." -- 1064

"I haven't done this yet, but with PC Slave, I should be able to do this." -- 1068

"I'm not yet running it as a background task for two reasons: 1) I use Paradox (a memory hog) which is only this month (a new release) supporting >640K extended memory so I've delayed using my Rampage Desqview. 2) I'm moving it from home to office where I'm bringing up a Banyan LAN network -- nervous about re-director, DOS 3.2, Desqview into action. 3) Relevant for fast breaking news service my colleagues at Oxfam are in Press Office and Advocacy work otherwise when time is not critical -- I'd be content to run at night and skim 1st thing A.M." -- 1070

"I actually have Double-DOS but find I don't like it. Double-DOS causes everything else to run more slowly. The other things I do on the computer (digital simulations, scientific calculations) take long enough as it is. I prefer to shut the system off when I want to use the computer." -- 1072

"Have both s/w pkgs but haven't used either with CommInS. Am skeptical that performance would be adequate on an XT (or PC)." -- 1073

"Haven't run as a background task yet. I currently have no plans to buy software that would allow multitasking." -- 1075

"No but I am interested. Unfortunately, I also use computer in a lab as a data acquisition system so I'm not sure how well software would interact with Double-DOS or Desqview." -- 1076

"Do not run as background task. Possible interest in doing so in the future." -- 1077

"I do not run CommInS as a background task since I have not purchased multitasker. I would VERY MUCH like to be able to do this because I use my PC all day at work for other tasks and am not able to receive any articles broadcast between 9 and 6, consequently. (I realize I'm supposed to use my Hayes to query the database, but I have so far found the two-way system difficult to use and not worth the bother, even for trying to recoup an article or update I may have missed.) I am not able to justify spending my company's money on Double-DOS or some similar product, especially for enabling an experiment in which I am participating at my own expense and on my own time. Should CommInS ever enable this feature, I'd be delighted." -- 1080

"I don't have software that lets me run the CommInS software in the background. It would be great to be able to since I use my XT several hours a day doing work. I'm often reluctant to leave the machine running when I'm away from home because I worry about wear and tear on it, but with a background process I would pick up more stories than I usually do. Does one really need Double-DOS to do it?" -- 1083

PRIMARY DATA FROM THE FIRST YEAR

"We do not run it in the background yet. We would love to, but our PC should probably be upgraded with a hard disk and/or more than 640K and two disk drives to make that feasible. We, however, are thinking about doing it. My husband and I have two machines and let our smaller PC be dedicated to CIS most of the time." -- 1084

"I don't have those softwares, but I think that it is essential that you do something about this, because -- at least in my case -- it limits the time I can use the system. Can you modify the software so it can be in the 'receiving' mode in the background? It seems all it does now is write 'bounce' on the screen!" -- 1086

"We don't have Double-DOS. It sounds like a good idea." -- 1087

"This would be highly preferable. The modem hookup running in the background would also be highly desirable since the uploading is so slow. I tried Double-DOS soon after I obtained the system but found it impractical due to screen interference between the two tasks." -- 1088

"How much is Double-DOS -- if it is cheap I would buy it because it is a nuisance to have to go in and out of CommInS program." -- 1092

"I haven't had time to run the new one under Double-DOS, but I did use the old system that way, after setting things to a screen whose no 'writes' took place (which leaked through to the foreground task). I expect to use the system under Double-DOS less, because I have a couple of PC's around." -- 1096

"I don't see the need. CIS is the only application I am leaving unattended all day. In fact, for the last month it has been the only program I have run at home." -- 1097

"I would like to run this software in the background in the future although I do not have Double-DOS or Desqview. Sometimes I just want to use my computer for other things, and at the same time, I would like to be collecting articles. I really question, though, how well it might work since with the present software key strokes often take several seconds to process if an article is being captured." -- 1098

"No, but I would greatly desire such an arrangement, with a provision a la Switches in the MacIntosh family." -- 1100

"No -- do not have Double-DOS available to me." -- 1105

"I occasionally use the system under Double-DOS. I find that the computer sometimes locks up due to memory overlap. The screen sometimes gets overwritten by the CommInS when the CommInS is running as a background task. The problems I have had may be due to the version of my Double-DOS. I should be getting the new version shortly. I'll write more after I have some experience with the new version." -- 1106

"I currently use the software with a private PC-DOS multi-tasking system. The system provides me with two PC-DOS sessions. With the CommInS software running in the background, I can continue to use my XT as a normal computer. This has proved to be very interesting, as I can work on my computer and still stay up-to-date with just the push of a button. The multi-tasking software performs very well with the CommInS software and there is no appreciable degradation of my machine's performance. The use of the multi-tasking software allows me to continue receiving news during periods when I would otherwise have had to stop so that I could use my computer for other purposes. I am very pleased with the current situation." -- 1109

"Having trouble using it with Desqview." -- 1110

"I would like to be able to run the CommInS software as a task under Xenix." -- 1112

"Since I do not have either Double-DOS or Desqview, I would be very interested in running the CIS under Double-DOS sometime in the future. From what I've heard of these operating systems, it would seem extremely useful for people to switch from one application to another. I usually leave my computer on for the whole day, so switching from the news service to a word processor without the hassle of saving to disk would be very handy." -- 1116

"I do not currently have Double-DOS or Desqview but would like very much to be able to use the CIS software with one of these programs." -- 1118

"Regarding subtasking, I am afraid I cannot comment! You see I do not use any multi-tasking packages. When using CommInS, I devote my time to reading summaries and articles and am not interested in running stuff in the background." -- 1119

"The idea is great, especially for use on a machine that is shared with a number of users. Most users would never need to know the system exists." -- 1120

"No, I haven't run the new software under DOS\*2 or Desqview. But I would be interested in trying it. It seems to me that the new software should be written to run under Windows, though. Windows will be incorporated into ADOS (DOS 5.0). Windows will be the standard on '386 machines. Why wait?" -- 1124

"I have tried using BCIS as a concurrent task running under the Epsilon text editor, using the latter's limited multitasking capability. Unfortunately, Epsilon is limited to running programs that do not directly address the screen (e.g. compilers) and will not work with BCIS. I do not use Double-DOS or Desqview. I find the idea of multi-tasking appealing, but given the small addressable memory available under DOS and the limited speed (even with my Deskpro's 7 MHz 8086) I am not sure how practical it would be. I certainly wouldn't mind giving it a try, but I can't afford to spend \$50-\$100 on an experiment." -- 1126

"To the extent I understand the question it would be of great value to be able to run the CommInS in the background while freeing up the DOS system for other use." -- 1127

"I am very interested in trying out the BCIS system with Double-DOS, but have not had an opportunity to play with this combination yet." -- 1130

"I have used CIS and DD. I sure wish I had Carousel or Desqview because DoubleDOS is weird." -- 1134

"I tried Desqview with the old software but it didn't work. Does the new software work with Desqview?" -- 1137

"I'm interested, I'm interested! I've tried Double-DOS; its too slow. The problem is the OS and the 8088 chip, not your system." -- 1141

"I do not have either Double-DOS or Desqview, therefore I have not had the opportunity to run CommInS as a background task. My view of such a system is that it would be nice, but it is not necessary. Most of the time I run the system to receive articles is at times when I normally wouldn't be able to use the system anyway (while I am sleeping or at school). Also, to exit the program when I wish to run some other program is easy enough not to be considered a hassle. I do not fear missing some interesting article while I am working on some other program. However, if my only source of news were the CommInS system, I would think such an arrangement would be nearly a mandatory. The ability for the system to be run in background mode, as I see it, would greatly add to the value of the system. For me personally it wouldn't make a great deal of difference, but that's because I use my computer much less frequently for things other than CommInS than the average person would. Therefore, acquiring a system to run CommInS as a background system is low on my list of priorities." -- 1146

"I would like to use the system with Microsoft windows" -- 1147

"No -- I don't have the background task facility" -- 1148

"I have not run either. Double-DOS takes too much memory for me to work on my normal tasks. I am interested in Desqview and would like it running under EEMS but don't have the necessary hardware now." -- 1150

"I have tried it using Double-DOS. However, because I prefer using RAM Disk (rather than hard-disk) for storage, there isn't really enough room in 640K. I find that for rapid scanning of summaries, even hard disk isn't quite fast enough." -- 1152

"I do not yet have this software capability." -- 1153

"No" -- 1159

"No, software not available to us right now. I think this would be nice, but we leave the computer on all night and get lots of articles anyway. Would Double-DOS or other background use slow down performance?" -- 1160

"I would be very interested in such an arrangement." -- 1162

PRIMARY DATA FROM THE FIRST YEAR

"We're not really interested as we have enough PC's with hard drives around that we can dedicate one exclusively to CommInS. It would be a hassle if we had to invoke the system <no matter how fast it is> explicitly compared to the present situation of walk up, sit down, read." -- 1163

"No but I'm getting Windows. Will CIS run under Windows? If it does I'd like to use it." -- 1165

"I would like to be able to run CommInS as a background task because my wife is currently using the computer frequently for a project and there is little time for me to use the system." -- 1173

"Sorry, I have no experience with such systems and am not familiar with how they differ from a standard system. I am for any improvement that lessens the risk of missing articles of interest while putting computer to other uses." -- 1174

"I don't run it, but I am interested in running CommInS software as a background task in the future." -- 1176

"I don't have Double-DOS or Desqview (yet), but am very interested in the ability to run CommInS in the background. I'd like to leave the news filter running 24 hours a day, but currently have to shut it down whenever the PC is used for something else." -- 1178

"I have tried Desqview on AT and XT for CommInS, but my rev of Desqview won't work on the new AT I have on loan. I'm expecting that the XT with Desqview will be how I use it, and will report on the performance penalty experience I have." -- 1180

"I do not own the software to run CommInS in the background. I have only had the CommInS for 2 months but am convinced that I must be able to run the program in the background to get the most from it. The CommInS program needs to be run every day for a long, uninterrupted period. This cannot be done if the program cannot run while other programs are being used. I am thinking of acquiring Desqview or some similar program so CommInS can be run in the background. I would like to know how others have made out before I get my software. The CommInS software should definitely come with the capability of starting the program then 'going to DOS' to run other programs while CommInS is running." -- 1181

"I do not plan to use the feature." -- 1184

"Not to date. I have recently received Double-DOS, but must copy to 3 1/2" disk. It is a definite must to obtain maximum use of your computer. Will comment on next questionnaire concerning my use of Double-DOS." -- 1187

"[First User:] No. Very interested. We have tons of RAM and the system is in high demand. Thus, such a system would be of great value to us and also would be relatively easy to implement. Please send info! [Second User:] No we do not have background capability. We would be very interested in such an environment." -- 1188

"I use Desqview all the time, though I do find I hang the system much more frequently with Desqview installed. This is a Desqview problem though. I hope to get Double-DOS soon to replace Desqview, which is not reliable enough." -- 1192

"No -- would like to know more about this." -- 1194

"I have attempted to run the CommInS software under Microsoft windows. Unfortunately, it doesn't quite work. The software can be loaded into memory and switched with the other applications, but it doesn't actually run -- i.e. access the receiver and download data -- unless it is in the foreground. [extensive randomness about running CommInS under Windows, why he thinks the program is great, bad reception, rabbit ears, etc., etc.]" -- 1195

"No, at this time I do not have any interest in such an arrangement." -- 1196

"I didn't know it was possible, but it seems like a good idea. I dedicate a PC to the CommInS software and it seems as though the system does not have many spare cycles so maybe it would only be practical on an AT." -- 1201

"No. It would be nice (though I suspect infeasible) to have the software be DOS resident so it can be run continuously from PC-DOS." -- 1202

"Sorry, do not use it that way. Have been in Mexico most of November on business therefore the reduced use of the system." -- 1204

"Don't use. No experience. The hardware required (expense) does not warrant it at this time." -- 1205

"I don't use the system as a background yet though I'd like to. I run it while I'm doing other things including working on the other computer but fear my storage capacity isn't set right for constant use. I am so busy, I'm always missing the news and often missing lunch and remembering to get the paper. This project is the solution! I love it!" -- 1206

"I do not run the CommInS software that way because at present I do not own those packages -- if I am able to purchase them soon I will then be a lot happier I think with the way I need to use my computer -- right now everytime I or someone else needs to use the computer for a database search I am often in the middle of reading an article -- or printing. I intend to purchase something like Double-DOS or Desqview eventually -- also more memory." -- 1207

"Have not done so. Find that nearly-dedicating a machine to CommInS is very awkward. Therefore if a background system can be made to work at reasonable cost, it would be of great interest for office applications. At home, since there is less demand for computer time, this is less of a problem." -- 1208

"I don't now, but would like to. Looking for memory board -- or might get Double-DOS." -- 1210

"I haven't tried this yet but am about to use Double-DOS, or Concurrent DOS or Windows to run CommInS and a BBS for college teachers. Since both require frequent disk I/O the result should be interesting -- something like the 1812 overture I expect. I'll let you know if it works and what happens." -- 1211

"Plan to implement Desqview in January." -- 1212

"Don't use it but I would be very interested in having such features in the future. The CommInS system should be on all the time!" -- 1213

"I have run Double-DOS with CIS and found the combination useful for receiving articles while still using the computer for other work. It is really an ideal set up. Currently I do not use CIS with Double-DOS for one reason. That reason is that the reduced memory available under Double-DOS forces a lower total system budget due to memory requirements for database maintenance. I therefore cannot receive the number of articles that I would like. If the software could be run so that articles are only put on disk, with no database maintenance, then I would use Double-DOS with CIS more often." -- 1214

"I own Desqview, however I only have 640K in my computer. When I tried to use the CommInS system with my normal activities I did not have enough memory to avoid swapping to disk. Thus at present I haven't used the software in a background task. If I could limit the system size to 100-150K I would use it as a background task -- is this possible? Perhaps sacrifice (i.e. a separate receive only module) some features for the ability just to receive in the background?" -- 1215

"I have just acquired DoubleDOS and intend to use it for this purpose. It is not yet installed so I have no experience." -- 1216

"No, I do not run it as a background task. I use the system with an 80286 turbo board for software development, which makes background tasks impossible. I usually just set up CIS to run for a few hours unattended during the day and then read the articles in the evening." -- 1217

"I don't run under these operating systems because I don't own them. I would be very willing to try using them in the future if provided for me. I am not sure how great a use they will be though because of the memory limitations of the 8086. However, an AT with n-Meg would be more suited for this application." -- 1218

"Yes. Works fine [?!] difficulty." -- 1219

"No. However have a AT&T 6300+ capable of running MSDOS as a process under UNIX. Plan to bring up UNIX sometime and see what works!" -- 1220

"Please explain what background task is?" -- 1221

"We do not use the system in the background. However we would find it very useful if it didn't tie up our system when trying to carry out our other telecommunications tasks." -- 1222



## PRIMARY DATA FROM THE FIRST YEAR

"I've been too busy to try to set this up yet -- but I plan to try it in the future." -- 1223

"As I indicated on the questionnaire, I would like to be able to run the news service as a background task, because I have to use my computer for work (mostly word processing) as much as 6-8 hours a day, during which time I am cut off from the news. I suspect that since I have a turbo-charger board, I ought to be able to handle both -- at least it would be worth finding out." -- 1225

"As of yet I have not run the CommInS software as a background task, however I am very interested in setting up such a system. I have found, however, one problem with leaving the system unattended for a long period of time. The self-maintenance features of the software are very crude, and thus it is very difficult to specify which articles to delete when the system is over budget. If there were some sort of self-maintenance feature (i.e. the ability to delete all articles more than x days old in a certain filter), the system would require much less user maintenance, such as manually deleting old unread articles to make room for new articles. I think that such a feature would allow the system to be left unattended or as a background task for longer periods of time, without the user having to read and delete articles every few hours." -- 1227

"I would be very interested in running CommInS as a background task, but I don't have enough RAM (only 320K) in my computer right now. I find that I am using my computer less for non-CommInS programs since I got CommInS. I leave it running about 24 hours/day and tend not to turn it off for word processing or modeling tasks." -- 1228

"No -- I do spend about 20 hours/week using my system as a word processor. It would be nice to run the radio in the background. I have not purchased multi-tasking software because I have never found a need. I am interested in multi-tasking software." -- 1229

"I would like to use Double-DOS as it would enable me to get more use of the radio broadcast. If only my computer could receive whole articles." -- 1231

"I hope to get Double-DOS very soon for the express purpose of using CIS. Sounds like a great use for it." -- 1232

"I do not use Double-DOS or Desqview." -- 1233

"No, I would be interested in background capability." -- 1234

"(1) Just got Desqview last week. I can't get Desqview's 'learn' feature (keyboard macros) to work right with your program. (2) Otherwise, seems to work OK. (3) It would help if you allowed more load-time switches, particularly something for <Alt-B> and <Alt-S>, (4) Desqview still doesn't solve the problem of long pauses in the printing." -- 1235

"I don't. I think we don't want to do this because our machine is heavily taxed by my husband's doing CSD activities on it. (He's a technical illustrator.) He needs every bit of speed he can get from the machine. (We actually have 2 machines, one 10MHz and one 12MHz, and both are in constant demand during daytime. I used the CommInS system in the evening.)" -- 1236

"This is my second questionnaire and I am again unable to respond to the essay question. I do not have the appropriate software to run CommInS as a background task. Since I leave the system running overnight, I see little need to use it as a background system. I am more concerned with fine-tuning the filters. I find that I am unable to catch articles I wish to read, while my hard disk fills up with unwanted articles I had hoped to use CommInS for most of my newspaper reading, since I usually read the main news stories and selected columns. I find instead that I must use both means to get the coverage I want." -- 1240

"I don't currently have enough memory to run CommInS under Double-DOS or Desqview, but I would certainly like to if I did have the memory." -- 1241

"I have grave doubts that the system would be very usable in background mode on a standard PC, although it would probably work better on an AT. The programs I tried that use background mode (mostly for printing), have slowed the foreground operations to the point of annoyance. On a PC, with the slow processor and the slow disk drive (I'm assuming a hard disk -- on a diskette it would be impossible ...), I think the BostonCommInS program would take big chunks out of the usable operating time of the system while it was writing articles to the disk. Perhaps with a filter set much tighter than mine (10-25 articles/day), so that articles would be caught much less frequently (2-3/day), it would be a reasonable system. I am an impatient person (at least with my computer), and I insist on having a very responsive system at all times because I am under constant time pressure in my work." -- 1242

"Have no interest in running in the background since the IBM PC XT's performance becomes very poor in the foreground task

processing. The system's hardware is really not designed for multi-tasking or foreground/background tasking. Thus I have no desire or interest in the future for such an arrangement." -- 1243

"Sounds interesting -- I don't have enough memory to do this now. Also I'd need a hard disk since both floppys are in use for CommInS." -- 1244

"Would be very much interested in its use in the future with multi-tasking but would have a more immediate need to use it with the 'program swapping' program Software Carousel." -- 1247

"I do not. I would be interested in knowing more about this." -- 1248

## December 1986

### Question

#### # Text

	Responses	Minimum	25th %tile	50th %tile	75th %tile	Maximum	Average
<b>20</b>	How much RAM memory does this machine have? ___ Kilobytes [In Dec, phrased My computer has ___ Kilobytes of RAM memory and .. 32]						
	114	256.00	512.00	640.00	640.00	4000.00	754.88
<b>32</b>	If yes, how large is the hard disk? ___ Megabytes [In Dec, phrased 20.. and ___ Megabytes of harddisk capacity]						
	112	0.00	0.00	20.00	20.00	120.00	17.74
<b>44</b>	Average time spent using Boston CommInS during last month : Computer Receiving Data from Boston CommInS ___ Minutes/Day						
	112	0.00	60.00	240.00	720.00	1440.00	432.56
<b>45</b>	Average time spent using Boston CommInS during last month : Browsing Summaries caught by your Filter: ___ Minutes/Day						
	109	0.00	5.00	10.00	20.00	180.00	15.39
<b>46</b>	Average time spent using Boston CommInS during last month : Browsing Full Articles caught by your Filter: ___ Minutes/Day						
	108	0.00	5.00	10.00	15.00	120.00	13.01
<b>47</b>	Average time spent using Boston CommInS during last month : Reading Carefully Articles caught by your Filter: ___ Minutes/Day						
	106	0.00	5.00	10.00	15.00	120.00	13.31
<b>48</b>	Average time spent using Boston CommInS during last month : Printing Articles caught by your Filter: ___ Minutes/Day						
	103	0.00	0.00	0.00	3.50	240.00	6.09
<b>49</b>	Average number of articles found using Boston CommInS during the last month : Articles Caught: ___ Number/Day						
	109	0.00	25.00	50.00	100.00	1017.00	103.49
<b>50</b>	Average number of articles found using Boston CommInS during the last month : Summaries Browsed: ___ Number/Day						
	107	0.00	11.00	30.00	50.00	400.00	50.58
<b>51</b>	Average number of articles found using Boston CommInS during the last month : Articles Browsed: ___ Number/Day						
	106	0.00	5.00	15.00	24.00	100.00	19.15
<b>52</b>	Average number of articles found using Boston CommInS during the last month : Articles Read Carefully: ___ Number/Day						
	105	0.00	3.00	8.00	10.00	65.00	10.24

PRIMARY DATA FROM THE FIRST YEAR

<b>53</b>	Average number of articles found using Boston CommInS during the last month : Articles Printed: ___ Number/Day	106	0.00	0.00	.20	2.00	40.00	2.08
<b>55</b>	I find that the information available is of: little interest--great interest	115	1.00	6.00	7.50	8.00	10.00	7.10
<b>56</b>	I use the system for: personal use--both--professional use	115	0.00	3.00	5.00	5.00	10.00	4.18
<b>57</b>	For important news, I rely on the system: not at all--some--exclusively	115	0.00	4.00	5.00	7.00	10.00	5.53
<b>67</b>	Using the system, I feel: awkward--OK--comfortable	116	2.00	5.00	7.00	8.00	10.00	6.97
<b>70</b>	I find the system has: no value to me--some--great value to me	118	0.00	5.00	7.00	8.00	10.00	7.11
<b>72</b>	When looking for specific information, I prefer to: read the newspaper--use the system	116	0.00	5.00	7.00	8.00	10.00	6.56
<b>73</b>	When reading for general information, I prefer to: read the newspaper--use the system	117	0.00	2.00	5.00	7.00	10.00	4.73
<b>74</b>	On the system, I miss the stock prices: not at all--some--very much	114	0.00	0.00	3.00	7.00	10.00	3.82
<b>75</b>	On the system, I miss the graphics: not at all--some--very much	113	0.00	0.00	3.00	6.00	10.00	3.76
<b>81</b>	I sit at the keyboard and use the Boston CommInS system ___ minutes/day on average.	109	0.00	10.00	25.00	40.00	205.00	31.19
<b>82</b>	On the system, I would like classified ads re articles for sale, job opportunities, housing, etc.: not at all--some--very much	117	0.00	2.00	5.00	8.00	10.00	4.98
<b>83</b>	I would like detailed TV schedules on the system: not at all--some--very much	117	0.00	0.00	4.00	8.00	10.00	4.24
<b>92</b>	For important news, I rely on the system: not at all--some--exclusively	116	0.00	5.00	6.00	8.00	10.00	5.81
<b>93</b>	My interest in the system is: decreasing--unchanged--increasing	117	0.00	4.50	5.00	7.00	10.00	5.85
<b>94</b>	On the system, I would like schedules for academic seminars at local universities: not at all--some--very much	117	0.00	5.00	7.00	9.00	10.00	6.59
<b>95</b>	On the system, I would like schedules for Boston Computer Society meetings: not at all--some--very much	118	0.00	2.00	5.00	8.00	10.00	5.40
<b>97</b>	On the system, I would like schedules for movies, concerts, & plays for Boston area: not at all--OK--very much	118	0.00	6.00	8.00	10.00	10.00	7.39
<b>104</b>	With the system, I feel: less informed--same--better informed	116	4.00	7.00	8.00	9.00	10.00	7.61

PRIMARY DATA FROM THE FIRST YEAR

129	I use the modem connection for two-way access: not at all--some--every day	112	0.00	0.00	0.00	1.00	9.00	1.24
130	Of this time, I use the two-way features with my modem ___ minutes/day	105	0.00	0.00	0.00	1.00	20.00	1.97
131	Average number of articles found using Boston CommInS since the last questionnaire, via modem : Summaries Browsed: ___ Number/Day	78	0.00	0.00	0.00	1.00	40.00	3.04
132	Average number of articles found using Boston CommInS since the last questionnaire, via modem : Articles Browaed: ___ Number/Day	75	0.00	0.00	0.00	2.00	20.00	1.88
133	Average number of articles found using Boston CommInS since the last questionnaire, via modem : Articles Read Carefully: ___ Number/Day	74	0.00	0.00	0.00	1.00	18.00	1.23
134	Average number of articles found using Boston CommInS since the last questionnaire, via modem : Articles Printed: ___ Number/Day	72	0.00	0.00	0.00	0.00	3.00	.33
135	Average time spent using Boston CommInS since the last questionnaire : Computer Receiving Data via modem: ___ Minutes/Day	105	0.00	0.00	0.00	0.00	45.00	2.60
136	The modem connection is: hard to use--OK--easy to use	68	0.00	3.00	5.00	7.00	10.00	4.91
137	I find the modem connection busy: never--sometimes--always	54	0.00	0.00	0.00	3.00	10.00	1.87
140	On average, I use the modem connection: less this month--same--more	92	0.00	0.00	4.00	5.00	10.00	3.22
141	With the new software, I find printing stories: hard--OK--easy	97	0.00	5.00	5.00	9.00	10.00	6.48

54	On the system, I read more full articles from: New York Times [0] Associated Press wire [1]	[0]	56.00	[1]	40.00	Total	96
139	I run the CommInS as a background task under: Double-Dos [0] DesqView[1] Not Applicable[2] ___ Other[3]	[0]	9.00	[1]	5.00	[2]	80.00 [3] 3.00

**For those of you who had experience with the original CommInS software, do you like the new key assignments better than the original? Can you suggest any further changes -- perhaps ones that add functionality?**

"The new keys are fine" -- 1005

"I find the new key assignments have improved, but not enough to cause me to use one system or another. I can easily adapt to using either 'key set'. One improvement might be to have the function keys displayed on the last line at all times vs. hitting '/' to get the menu." -- 1006

## PRIMARY DATA FROM THE FIRST YEAR

"I feel that the new system keys are very good compared to the old software." -- 1007

"Yes [better than original]. Built-in print spooler. Built-in 'Double-DOS' program to allow running in background." -- 1009

"I like it better. I don't need the [Alt]-[E] combination to execute a command." -- 1011

"Not much difference one way or the other. Better, context sensitive, interactive 'help' would be valuable for new users. Easier correction of filter lines." -- 1013

"The new key assignments are a significant improvement! Thanks. The beep on error, which was removed, was useful in orienting the antenna." -- 1019

"I don't understand what benefit you've achieved by changing the key assignments. I find myself hitting the wrong key (annoying) more often now. For instance, ALT-Y instead of ALT-E. I can't say one's better than the other, but why bother?" -- 1024

"They seem about the same--that is, equally learnable or arbitrary, just different from what they were before." --1025

"New key assignments are good EXCEPT for Alt-X Alt-E sequence." --1032

"Yes!!" -- 1038

"Yes" -- 1051

"I have had a little trouble shifting from the old software to the new. In particular, the change of the confirm key from alt-y to alt-e initially caused me to blank the screen and cuss softly several times. Time and use have fixed that problem now. The new assignments are about as good as the old ones." -- 1057

"No." -- 1068

"Yes [better assignments]. NEED MOST: ability to browse summaries from F4 without a preceding Alt-read, i.e. to, from first menu, move cursor to desired filter line, be able to use F4 key to see summaries and then have a single key to read (like F5) or then give an Alt-r on article." -- 1070

"I dislike the way to exit from the program. How about allowing a simple Y to confirm. I dislike Alt-e intensely. It is inconsistent with every other program. The other assignments are fine." -- 1072

"The new key assignments are somewhat better, but I still find the interface confusing. It is convenient to dive from the list of filters to the summaries for the current highlighted line by pressing ENTER, but its surprising that you cannot dive from a summary to a story by another ENTER.

"In general, I find ALT-keys awkward. I think that you should just be able to press plain, unshifted keys to execute commands/navigate -- 'R' for 'Read' etc. Instead, the default seems to be that unadorned keys are input to a new filter line. I spend far more time reading/navigating/commanding than I do typing new filter lines. Therefore, I feel that the 'modes' should be reversed so that plain keys command and that you have to give a command to get into building a new filter -- that may well be a heretical view." -- 1073

"I think the key assignments are good. In general, once I learn the keystrokes, I would rather stay with what I know than change -- even if the changed keystrokes are easier." -- 1077

"I like the new key assignments better." -- 1083

"Yes!" -- 1084

"Yes, except that some people use them without de-activating lightning, which has different key assignments--leads to freezing the system." --1087

"They are fine." -- 1088

"OK" -- 1092

"I like the new key assignments better than the original. I can't think of any further changes." -- 1098

"Better than before." -- 1100

"I like the new key assignments better than the original one. I however like to see that the page down key would bring to cursor down to the bottom of the page rather than flip immediately to the next page. I find this to be annoying and inconsistent with the existing software on the market." -- 1106

"The new key assignments (after a bit of initial confusion) seem to be somewhat easier to use. However, there are two problems that I encounter. First, I don't like having to type A-X and A-E to exit. I find it awkward. Second, everyone always has 'their' favorite set of key assignments (i.e. the Quit key, the Browse key, the Page Forward/Backward Keys) that they use for other popular software packages. It can be particularly unnerving to switch from an editor with one set of keystrokes, to the CommInS Project with a different set. I would like to see user-assignable keystrokes. That way everyone could customize their definitions to match the other software packages that they use and that way I wouldn't keep bringing up the command menu every time I want to quit." -- 1109

"On my AT keyboard (the 'old' one) they are both pretty awkward for some keystrokes. I do not prefer one over the other." -- 1112

"Yea!!" -- 1115

"The old and new key assignments make no difference to me. Since the program has menus, I don't need to know the key assignments." -- 1116

"At first it was confusing because I kept wanting to use the old key assignments but once I became acclimated I liked the new ones much better. The slash key in place of the escape key is definitely superior." -- 1118

"I am ambivalent about the keystrokes -- the new ones are just as easy to use as the old ones although I find the definitional menus very helpful. One function that would be particularly handy would be one that would write a 'modem' article from the telephone line to the users hard disk." -- 1119

"No difference, just a matter of getting used to them." -- 1120

"Took a while to switch comfortably, but they're slightly more convenient." -- 1121

"I like the new key assignments. They're not all that different from the original." -- 1124

"Consistency: I think the new command set is an improvement over the old one. New users will find the lotus-like use of the '/' and Esc key far more intuitive. Only one aspect that I find inconsistent is the use of 'CR' key. In the filter window, it acts as an 'execute' key, in that it processes the current line. In the Summary window, I expect it to select the summary being pointed at and present it in the article window. Of course, it doesn't, instead it resubmits the filter line. I still find this counterintuitive, although I realize that there are some good reasons for making it work this way.

"The use of Emacs-style key assignments in editing the filter lines is OK, but there are some sub-optimal key assignments there too. The 'delete' key deletes the whole line, which is bizarre and the 'end' key takes one to the end of the filter window, losing whatever filter line was being edited. I've made these errors several times, even though I use an Emacs clone for text-editing. I think better key assignments could be created for line editing, including more attention to the cursor control keys. (For example, include movement by words with a ^ or shifted arrow key.)" -- 1126

"New keys work fine." -- 1130

"How about an 'accounting' system in the software so I don't have to guess when I fill out the hours/day section of the survey? The software would tell me how much time I spend in reading surveys, reading articles and letting the system work on its own (in 'bounce' mode). -- 1137

"I have adapted to the new key assignments and am able to retrieve the information I want easily. The only problem I have been experiencing, is when I am ready to exit to DOS, the box appears on the screen. I highlight execute and press return and sometimes I exit and other times I have to repeat the procedure several times before saving and exiting." -- 1144

## PRIMARY DATA FROM THE FIRST YEAR

"Yes, I like the new function keys better, but the F1 key should be a menu rather than a help file. It is very frustrating to be working and accidentally hit the F1 key and have to wait for the help file to load and print on screen. The help file should be a 2 key stroke command or at least an obscure key." -- 1146

"In general the key assignments are better; they follow industry norms for PC applications. I would prefer not to have to make continued alt-key combinations to do things though e.g. if I choose 'wipe all articles', I have already used an alt-key combo and should only have to type 'y' or 'n' for confirmation. One finger is better than two." -- 1150

"Prefer the new ones. Would like 1) ability to 'tag' articles for printing (from several filter lines at once). 2) ability to delete all articles (other than \*, [enter], alt-k, alt-e)." -- 1152

"I have trouble printing on arrival." -- 1159

"We don't have a new manual so we have had to find them (the new key assignments) out by trial and error. They seem fine, but I have mixed feelings about having to hit Alt-e (execute) to get out. It's a good protection, but requires more keystrokes." -- 1160

"User bindable key bindings. Don't always be in the mode to enter a search string. I shouldn't have to use the alt key for 95% of my use of the system." -- 1163

"I like the new keys, but I can't get the modem system to work." -- 1165

"I still have trouble printing to a non-IBM printer. And located on 128 in Canton, reception is only marginal. Overall, though, I am still very excited about the system." -- 1171

"Move A-H from F10 menu to F2 menu, so remote connection can be terminated as well as initiated from same 'location'. Printing on non-IBM printer seems to have '2nd class' status. Is there a way for the software to create a queue for printing several articles on non-IBM printer, without requiring close operator attention?" -- 1174

"The key assignments are fine - '/' to get menu window is very handy as a quick reminder, quicker than using 'F1' Help. '?' should get a quick help pointer to 'F1' and/or a quick menu." -- 1178

---

**What changes or improvements would you suggest that the CommInS Project make in the next year? What do you think that the CommInS Project should accomplish in 1987? Would you like to see:**

- 1. additional newspapers?**
- 2. news magazines?**
- 3. regular magazines?**
- 4. professional journals?**
- 5. schedules for meetings and the arts?**
- 6. new software features?**
- 7. new hardware features?**

**Please be specific or general in your answers!**

"Globe, Time, Newsweek, Byte, Science, Nature, Boston area [schedules for meetings and arts]. Run in background by itself. Include stock prices." --1005

"I am a very happy customer/tester of your system. There is not a great need to have more functionality and I find the system very stable with one exception. When I leave the system up over the weekend, it is not uncommon for the budget of 200 to be reached. Usually, at this point the system hangs. What I would like to see for 1987 is the availability of more information (Professional journals and calendar of events to be specific yet vague). Software tools to organize and search unique database will probably need to be re-written." -- 1006

"I feel that more newspapers, magazines, computer related magazines would be a definite plus. Schedules of the Boston Computer Society and other professional organizations would also help. Software: COLOR, COLOR, COLOR -- PLEASE - would like to set some budget items so will only be deleted by me and also set budget to only keep 'x' items. This way I would keep my total budget equal to all line item budgets." -- 1007

"Washington Post, LA Times, Wall St. Journal, Aviation Weekly" -- 1009

"I don't like Associated Press articles. Too much of it is of no interest. I'd like to see more Boston coverage and better quality articles like from professional journals or Time magazine." -- 1011

"All of these sound great. I'd particularly like to get schedule for local events. It would be particularly valuable if you could come up with a query interface to check on events according to time, type or place." -- 1013

"Boston Globe, suburban (local) papers. Trying to download software would give some new experience to some of your community and the experience may be something you would find interesting to observe -- however I don't feel you should try to become a PC bulletin board. Adding items like classified, tv & meeting schedules will be more (or less) useful depending on the unique search/filter techniques you devise. Table of contents of the stories and articles in current issues of various magazines and journals might be more useful and less expensive than attempting to abstract them." -- 1019

"A problem we have with using the system on our office computer is that the system competes for time with too many other uses. Over the past month or so the system has consistently lost. Our office subscribes to the WSJ and the Globe finds its way here each day as well. So, the system seems to be used only during special events -- Chernobyl, Shuttle explosion, etc... -- rather than as a matter of routine." -- 1021

"Wall Street Journal, Boston Globe, U.S. News and World Report, too many [regular magazines and professional journals] to choose from unless user can select. [Schedules for meetings and the arts is a] good idea. How about the Wall Street Journal? If you can add only one service that's it! Modem: How can you cut down on-line times? Will I have to tie up my phone 4-6 hours/day? Radio is better this way -- have you any ideas? I'd like to see some batch files for installing on a hard disk and for booting the program disk. I wrote my own but you need to think about future commercial users." -- 1024

"The software could still use improvements. An 'undelete' key for accidentally removed articles and a more efficient way to filter out duplicate articles come immediately to mind. The new key assignments seem OK, although the reason for changing F1-F3-F5-F7 to F2-F4-F6-F8 escapes me. In the future we would like to see a selection of professional academic journals and possibly local film or TV schedules. Some of the categories need better definitions: for example, 'column' catches all kinds of text besides regular columns. We haven't used the two-way system much but value it has as a backup. So far its main effect has been to make us less insistent on keeping valuable articles, since we know we can always recover them." --1025

"Schedules would be a welcome addition. Professional journals and 'freeware' would be great!" --1032

"Boston Globe, PC Magazines and especially weeklies. I need some way to increase my 'hit rate', i.e. the % of stories collected that are genuinely interesting to me. The problem is the 45 minutes/day to wade through the material. I view this as a systems engineering issue; but better software filters would help. (eg. 'variable' -- user defined agglomerations of search words, which could then be used in further compound expressions)." -- 1038

"I think the most exciting challenge is to investigate how CommlnS could be integrated with, or at least, connected to, other information systems so that information or functionality not practical for it can be accessible via gateways and/or coordinated with other software." -- 1041

"Additional papers -- eg. Washington Post, Wall Street Journal would be welcome. I am happy with software and hardware as is. Key assignments and features are definitely better than original software." -- 1043

"Yes [to all information source additions]. Your system has terrific potential in its features. The thing that's missing is the information and the quality of the rendition of the information (ie. not graphics)." -- 1045

"Globe. Yes [to all other information source additions]." -- 1051



## PRIMARY DATA FROM THE FIRST YEAR

"A sorely needed improvement to the system would be a better way of reducing the incidence of duplicate articles. Very often I find the same article in my queue four times, with only trivial differences (if any) between incarnations.

In the statement for this question, several suggestions were made: additional newspapers, magazines, journals and so forth. Most of these would lead the system away from its original purpose (or at least what I see as its original purpose), which is to provide rapid and flexible delivery of the news.

A few additional newspapers might be added, but be careful about how it is done. If the broadcast channel winds up sending each article less frequently, those whose systems are not running continuously will miss more stories. Also, adding newspapers may result in more duplication of stories.

My suggestion for other newspapers would be the small-scale, local papers that will not print stories carried by the AP and NYT wires. In my location (Brookline) those are the TAB and a paper published by the Citizen's group.

A system in which journal abstracts and a good search system are available would be of great interest to me. I have used the computer-based search services available in the MIT libraries, and would like to have something like that more readily accessible. This would be, however, something quite separate from the existing system. To be useful, it would have to incorporate several of the major abstract databases: I suspect quite a bit more information than you now have on line." -- 1057

"There is a limit to what I can read. The New York times is usually all I'm interested in. I would be interested in software distribution. The feature I would like most in the system is a baby! like filing system. There are certain articles I would like to save, but there is no convenient way of doing this with the current system." -- 1065

"WSJ, Time or US News, Scientific American, New Eng. J. of Medicine. Faster rematching after a reboot (put the (\*) that tells you the total # of articles on the top line so that you know if other lines are filled on a separate page." -- 1068

"As stated earlier, would pay a fee \$5-\$10 a month for market prices and ability to get news on specific companies. No [additional newspapers or news magazines]. Hi level PC techs like the ARPANET PC information. Local area [schedules for meetings and the arts] like the Boston Magazine. Ability to have a network version or present version work on a network it's acceptable that only one user can edit the filter window, delete or print but others should be able to read -- not and infringement I hope of the license agreement. (i.e. needs access to the directory to select files). An index to reviews of 1. Movies, 2. Video Cassettes, 3. PC Programs. Review should give source i.e. reviewer name and mag title." -- 1070

"I would like to see an expansion of the dial up data base to at least include the AP wire service. I would also like to see additional newspapers. If your database were improved (and I could capture things as files instead of being forced to print them) I would use the database exclusively in place of the radio." -- 1072

"1. The new key assignments are somewhat better, but I still find the interface confusing. It is convenient to dive from the list of filters to the summaries for the current highlighted line by pressing ENTER, but its surprising that you cannot dive from a summary to a story by another ENTER.

In general, I find ALT-keys awkward. I think that you should just be able to press plain, unshifted keys to execute commands/navigate -- 'R' for 'Read' etc. Instead, the default seems to be that unadorned keys are input to a new filter line. I spend far more time reading/navigating/commanding than I do typing new filter lines. Therefore I feel that the 'modes' should be reversed so that plain keys command and that you have to give a command to get into building a new filter -- that may well be a heretical view.

2. The 'bell' is atrocious and offensive. Worse, the new software seems to have lost the mechanism for shutting it off. Try to use it in a room where someone else is trying to do work!

3. It is hard to manage stories by date/time -- I often find that I would like to flush all stories before X dat/time in the database -- sometimes I just would like to do this on a filter. Also for some items, I would like to just keep the last one -- weather report, for example.

4. I have trouble making filters that get just what I want. A lot of my catches wind up being omnibus packages of small stories -- on a day's financial news, for example. I have to read a fair distance to find out why the item was caught -- the summary may not show it. It might be nice to be able to jump to the occurrence of the word(s) that triggered the catch.

5. If I don't keep my computer on all day listening, I feel that I have missed things and cannot rely on the system.

6. I have not tried the phone-in access to the database.

7. I think it would be nice if the system abstracted personal computer magazines and computer-related professional journals. It would also be nice to have a schedule of meetings, courses, events related to computers." -- 1073

"The modem connection to a database of articles is of more interest to me than daily news articles. I work on a computer all day, so I prefer newspapers or TV for my daily news stories. Regular magazines and professional journals would be more important to me than additional newspapers or news magazines." -- 1077

"How about an index to prof. journals (IEEE, ASME, etc.)? Background mode so I can run other programs at the same time (I don't have double-dos, etc.)? How about detailed weather reports for pilots (NOAH)? movie listings, club listings" -- 1083

"Yes [additional newspapers]. Yes, maybe [news magazines]. Dont care [about regular magazines]. Yes [professional journals] -- data processing & archeology only however. Don't care [schedules for meetings and arts]. 1. Would like to search within articles caught by filters -- refilter articles. 2. Would like to be able to set the colors on the screen. 3. Want stock and Mutual Fund Prices." -- 1084

"1) The most important improvement would be the ability to receive data in the background. There are several communication packages that can do that. Why not CIS? 2) It would be very useful if we could seat at the PC and get some job done, such as literature search, scientific news, professional journals, etc. 3) It would also be nice to have some bidirectional communication, i.e. a sort of bulletin board or mailbox. 4) Isn't the need of a modem defeating the philosophy of the whole thing, i.e. cheap, direct communication, from your computer to the outside world, no umbilical cord, etc? 5) Could all of the above be delivered without going back to the traditional modem-phone method? 6) Thank you very much for an exciting experience!" -- 1086

"Magazines like US News and World Report, Christian Science Monitor, schedule for meetings and arts." --1087

"Wall Street Journal. General scientific journals: Science, Nature. Capacity to download articles into text files from the modem, as per the subfrequency carrier decoder. Background printing on epson-compatible printers!" -- 1088

"1. A local newspaper 2. A national news magazine 3. Local arts schedules 4. Science magazine" -- 1092

" 1) Wall Street Journal 2) Bulletin board for users? (use sloan school's!) 3) Boston Computer Exchange database. 4) Collection of PD software?" -- 1096

"I would be nice to have more newspapers available, but I think one or two news magazines and professional journals would be more useful. You should definitely get concert schedules on-line. And if you are serious about doing classified ads, you should try it in '87! The software should have the following improvements: 1. Longer filter lines 2. Subdivision of filter lines similar to sub-directories in UNIX for example 3. 'Local' filter lines which can be activated at keyboard and would operate only on captured articles not on incoming ones." -- 1098

"Run in background" -- 1100

"My interests are primarily in the area of international, national and financial news. With the exception of the lack of stock prices the system does satisfy most of my needs and interests." -- 1105

"1. I have an IBM-AT system. I found that if I use the menu to exit CIS, the command must be entered twice before leaving the program successfully. I have not experienced this problem when using the equivalent key-stroke commands.

2. I'd like to see a feature added to include a set-up option such that the user can select a desired interrupt vector and address location for the com ports being used. I installed 5 additional serial ports to my AT and they are not DOS compatible. I managed to change the CIS.EXE file by using DEBUG to make the program access my Com 3 port. However, I still have problems changing the Com 2 port to address my Com 4 port for modem connection use. Maybe Dave Segal can help me with this." -- 1106

"Yes [additional newspapers]. No [news magazines]. Maybe [regular magazines]. Yes, desperately needed [professional magazines]. Yes, desperately needed [schedules for meetings and the arts]. Yes [new software and hardware features].

## PRIMARY DATA FROM THE FIRST YEAR

1. Create electronic mailbox for users who might want this feature, so they can leave or retrieve messages for/from other users.

2. Software: create status command help line on screen so all commands are visible" -- 1107

"I would like to see local newspapers (e.g. The Boston Globe) carried by the CommInS Project. Also national newspapers like the Wall Street Journal and USA Today. I still read the Boston Globe and USA Today because they carry interesting human interest stories that aren't carried by the New York Times and the Associated Press. In terms of magazines, U.S. News and World Report and Newsweek would make good additions. Professional journals like IEEE Spectrum or some such similar journals would be nice, especially when combined with the dial-up database. Schedules for local and on-campus events would also be handy. The prime advantage I have found with the CommInS Project is the ease with which I can research/find information of interest or use to me, whether it is for a paper on the Iran/Contras Affair or the information on the latest forecast. Any information that is put into the system is easier to access electronically than in its comparable paper form. The only problem I see with the system, is what I don't see, and that is graphics. Even a rough approximation of the photos and diagrams presented in the newspapers would be extremely helpful in many situations. The lack of graphics is the main reason why I still read many of the main stories and almost all of the Science Section. In terms of software features, I would like to be able to shell to DOS from the system. It's not necessary for the system to continue operating in the background (although it would be nice), but it would allow me to do things like printing a short report, or some other small task, without having to bring the system down and then bring it back up (something that can take quite a while when there are many articles." -- 1109

"More on modem connection. The software is OK but I think that more features would be nice -- and maybe some new hardware features too." -- 1110

"-Schedules for movies, plays, lectures, concerts would be very nice. -Have a software switch that would allow me to save only those articles which originated after a specific time/date (i.e. when I last went thru my articles). -It would be nice to have abstracts of articles in magazines like the economist, New Republic, Atlantic monthly, time, Scientific American, Byte, etc. -Would it be possible to get abstracts of professional journals thru the dial-up line?" -- 1112

"Newspapers: Wall Street Journal, Manchester Guardian, Washington Post. Magazines: Business Week. Software Features: printing in background with non-IBM printer, delete by date. Hardware features: more lines on remote. I have been unable to get on!" -- 1115

"The information I would like to see on the system would be stock market and options market quotes. Other than that, I find that the New York Times and the AP provide most of the important news that I want to read. If the technology ever became feasible, it would be nice to have pictures pertaining to the news stories." -- 1116

"I would be very interested in receiving articles from computer journals and news magazines like TIME and Newsweek. Meeting schedules for local lectures and users group meetings would be very helpful, and graphics would be a big plus." -- 1118

"WSJ, Washington Post, Boston Globe, Economist, Business Week, Fortune, Time, Newsweek, Journal of Finance, Econometrika, Academic, school, professional organizations [schedules for meetings]. Allow for dumping of modem articles to disk. I think that the group is doing an outstanding job -- one thing I am interested in is 'what is a typical user? How much does he/she use the system? What are their uses? etc.' The addition of the modem feature was tremendous! Perhaps retrieval >90 days would be of value to some. The modem feature clearly reduced my use time since it allowed for a much more focused session than just scanning article after article. The system became an active tool rather than a passive window! The group should focus its thinking on how people could optimize their use of the system. Some users, I am sure, haven't the faintest idea of how to effectively use a dbase. Perhaps some points would be in order to assist those who may be mired in all the 'good' data available to them!" -- 1119

"The addition of professional journals and newspapers -- specifically the Boston Globe -- would improve the software." -- 1120

"I would like to see this as a combined vehicle for the material now covered and as an access point to the many large databases out there now accessed via Dialog, etc. -- In part access to bibliographic databases including 'current periodicals' would be a special case of this request and deal until a number of issues posited above." -- 1121

"I would like to see the addition of Dow Jones data to the data base. Also, I would like to see the next version of software run under MS-Windows." -- 1124

"The CommInS system in general works very well, and provides a useful service. Some suggestions for improvements are presented below.

Software:

Longer Filter Lines: I have suggested this many times in the past, and I still think they are a necessity. Often there is a lot of stuff that I want to keep out of a filter line, and defining the 'not' stuff can take up a lot of the filter line. For example '(defense | military)~(category:spo\*|adv\*|reg\*)(type:NYT)(date:[date 0])' is about as long as I can make a filter. There isn't much room for putting in new terms, like ~Iran. The inability to make filters more restrictive is quite a nuisance -- it means I have a lot of articles caught by overlapping filters, which slows down the browsing process. (eg. an article on the Irangate business that has the words defense, soviet and Iran, will be caught by three filter lines.) Even if longer lines could only be input into the filter file, rather than edited from within the CommInS software, it would be a big advantage.

Global or Hierarchical Filters: I've suggested global filters before. I'm not much interested in sports or the stock market, so it would be handy to have a global filter that would get rid of them without having to put a separate entry in each filter line. Hierarchical filters is a new (for me) idea. If one could define a common filter for a set of filter lines, one could create groups, and again reduce filter line clutter. For example, one could cluster all of the NYT and AP articles into separate sets by using one 'upper level' TYPE filter. Hierarchical Filter System (category: ~sports | ~stock) (type: NYT) <bunch of filter lines that apply only to NYT> (type: AP) <bunch of filter lines that apply only to AP> I don't know enough about your database system to know if a hierarchical system is practical, but if you're going to add several more services clustering and specializing there filter lines makes a lot of sense.

Features: I think that the news coverage provided by CommInS is excellent. My only complaint is that there is a great deal of repetition -- AP seems to send 5 or 6 revisions of stories, cluttering up the system. If your software could filter out stories which supersede old ones and only re-transmit the new ones it would perhaps help a bit. (I note that some of the AP stories include 'supersedes' lists.)

I am not terribly enthusiastic about adding news magazines. First, they would not much benefit from CommInS's rapid delivery. Second, since they depend more on graphics, more would be lost. Third, I don't think very highly of Time or Newsweek anyhow. If you do want to put a news magazine on, then I think the best choice would be The Economist, which provides a wider range of news, and doesn't rely heavily on graphics.

One magazine that would work well on CommInS is Inforworld. It has short newspaper-type articles, can do without some of its graphics, is timely, and would probably appeal to CommInS users. (Inforworld is a microcomputer weekly). Perhaps as an experiment they might be willing to let you transmit their text 1 week after the paper is published, thus avoiding direct competition with print sales. Other general-interest magazines might be worthwhile, but many of them suffer the same problems as news magazines. I have no particular recommendations to make.

Schedules for movies, meetings, etc. are a very good idea. That is one of the few things that CommInS doesn't offer that a local paper does. They would also take up relatively little transmission time." -- 1126

"Globe [yes to additional newspapers, news magazines, professional journals and schedules for meetings and the arts]. Documentation needs to be much, much better. We can't get the modem connection to work satisfactorily." -- 1130

"Based upon use of old system, which I haven't been able to use for a couple of months: I would like to see general business and current events magazines on the system: Business Week, Time, Newsweek. Local Boston cultural events and meetings would be of interest. I cannot comment on the software/hardware." --1131

"The software should be smart enough to do the usage data collection. Would provide much more standardized interpretation/collection of much of the data of interest. When questionnaire arrives, select 'summarize usage' and then copy data to the form and complete the data that cannot be tracked by the machine." --1133

"Penny stocks and New Issues/IPOs. Industry analysis ex. semiconductors, pets, shoes. Dept. of Commerce - foreign business opportunities. Support for more PCs especially CP/M Tandy Mod IV, Xerox, Zenith, Osborne and Apple II. Faster directory load/save." -- 1134

## PRIMARY DATA FROM THE FIRST YEAR

"Even if you can't get full professional journals, tables of contents would be nice." -- 1137

"Being part of the Boston CommInS Project, I feel much more in touch with the world and national events as they are shaping our society. News magazines, professional journals in education and computer technology would be of special interest, also schedules of meetings and the arts and a job line would be terrific to include. The data base features, key words make it much easier to access information instantly and fill specified needs for information. With a 1200 baud modem now available to me, I am especially interested in accessing the data base for information via modem." -- 1144

"Some improvements I would like to see added would deal with improvements for printers other than the IBM. Such as background printing for my Star 86-10 printer. Also, as mentioned in the questionnaire, graphics would be nice. But, what I really would like to see done (if possible) is the transmission of pictures as well. The graphics on the IBM should be good enough to get a fair representation of what the picture actually looks like. The final improvement I'd like to see, as mentioned above, is a schedule for arts, music and entertainment (including TV)." -- 1146

"The Washington Post and the news weeklies would be useful for my purposes." -- 1148

"Why I enjoy the Wall St. Journal - 1) good writing, 2) serendipitous contact with areas I didn't know would interest me 3) quick scans. Why I like Smithsonian - 1) well written 2) wide ranging topics. Why I like Car and Driver - 1) well written 2) specific to my interests 3) unique information. Why I like Infoworld - 1) timely information 2) good reviews.

How does CommInS Compare: -writing at AP is featureless. News for news sake. NYT is a little better. Remedy: special interest or news articles, well written. -the system doesn't catch peripheral articles of interest. Remedy: a 'specials' heading or category. -in-depth information is lacking. Remedy: special interest articles -Timeliness; CommInS is king in areas it covers -Ease of use. Magazines are nicer to read but its not just the pictures; its type faces and paper. Remedy: wait for new technology in screens.

I would really like a more powerful signal. Can't receive easily in Lexington." -- 1150

"Still arguing for all solid-state machine. I run my system on Ramdisk but I do get tired of the hard disk whine." -- 1152

"Wall Street Journal, Christian Science Monitor." -- 1159

"I think the news quality is fine. I love the idea of having classified job opportunities ads sent to my system. Similarly, arts and events schedules would be very much appreciated. (My husband thinks the main disadvantage of the system is that it doesn't have comics. Maybe you should have a "jokes" category)." -- 1160

"More flexible filter. Easier to use modem start-up (for non-Hayes). Add local reference material (movies, TV, etc.)." -- 1161

"Info sources meeting schedules more CIS info fall stock listings Rights to use info for longer than 90 days, etc if we subscribe to the Times.

User bindable key bindings.

Don't always be in the mode to enter a search string. I shouldn't have to use the alt key for 95% of my use of the system.

For stat data, have program monitor it, show it to user and user can then report it to you. If you want the data, make it easy to collect." -- 1163

"News & business magazines would be helpful. So would additional newspaper of high quality (e.g. Washington Post) and news services (e.g. UPI, Reuters). The more the better. Movie and TV schedules would be great." -- 1165

"PC Week. Newsletters not just journals. Text compression for storage to disk!! Tie in to desktop publishing software that recreates NYT/Newspaper 'look'." -- 1168

"I like the new key assignments - more Lotus like. I still think it would be even more intuitive to use the function keys only -- for a given filter line, F4 would display the summaries and F6 would display the highlighted article. The Wall Street Journal is the publication I would most like to see added to the database." -- 1171

"I have had some difficulty using my Qursie modem (internal) with CommInS software. I suspect that this relates to the fact that the Qursie 'fakes' the DTR signal and will not disconnect if DTR is 'dropped'. This could be circumvented by using the on line escape and issuing the hang up command 'ath0'." -- 1173

"Would like to see modem access extended to AP databases, even if it only goes back a week or so. I miss the beep-on-error feature. It was useful for antenna orientation. WSJournal. Would like to be notified (flagged) by system when one's favorite films (previously entered) were to be shown on TV or anywhere in Greater Boston (including the obscurer campus file series) with as much lead time as possible. Stock prices would be welcome (mutual funds as well). How about CIS - originated bulletins on status, including percentage of valid data transmitted on previous day; anticipated outages; any other items of daily interest (numerical or otherwise)? Would like to see all news and publicity releases from Smithsonian Astrophysical Observatory, including notices of public meetings." -- 1174

"Specific - 1. ability to temporarily comment out a filter line 2. ability to edit a change to a filter line, then have it take effect without losing accumulated articles under that filter. 3. ability to abort modem retries with Alt-H (when Hayes is losing). 4. support of longer queries in filter lines - <80 chars is not enough! 5. when remote dial-up queries are used, the qualifiers appended to the filter line make it too long - eats up half of the line! Don't waste precious space with blank characters, use '&' instead of 'and', etc. 6. in remote retrieve, ability to go from article window back to summary window without clearing out and retransmitting whole buffer 7. better screening out duplicate articles 8. better printer support, using standard print spooler running in background 9. compatibility with MS-Windows. DESQview

General - 1. I'd love to apply some filtering to Usenet news and ARPAnet boards, since there are some real useful gems of information buried in the torrent of data coming in every day. This would be incredibly useful for my work." -- 1178

"I would like to see you add regular magazines to the service. Including Sports Illustrated, Time, Newsweek, and USN&WR. Maybe add the Globe." -- 1184

"Access to Fortune 500 news releases at the same time made available to the AP. Definitely more stock information." --1187

"Please make it possible to select and go to next window by pressing [RETURN]! I'm tired of finding myself back at the first summary instead of in the article I wanted to read. Cartoons would be nice (a bit on the whimsical side, but worth a shot). Wall Street Journal." -- 1188

"I would like to see the Post included and schedules for meetings, etc. Prof. journals table of contents would be great." -- 1192

"I still have not decided whether it is more reliable to get important-to-me news via CIS or regular newspaper. Seems a toss-up so far." -- 1194

"Wall Street Journal, Globe and Mail (Toronto), Times(London), The Economist, Science News, New Scientist, News sections from Nature, Science.

Support for MS-Windows.

So far, the system has served me best not as a general news source, but as a device to alert me to items in areas of interest which I would otherwise have missed. This function would be vastly improved if the system had access to current issues of the various 'current contents' bulletins in the sciences, the 'Readers Guide to Periodical Literature', and other similar indexes. The system need not carry the text of all the articles -- I'm sure that would be impossible anyway at this point -- but even just titles and (where available) abstracts would be very helpful in keeping up with progress in areas of interest.

At the moment access to system resources is severely constrained by the absence of a modem in my computer and by the inability of my present hardware/software to support background operation of CIS. I hope to remedy one or both of these conditions in the near future. However, my experience with CIS to date makes it clear that a system which relies on a single FM channel for communicating data is inadequate as a general information utility. Obviously, adding modem capability for 2-way communication will help, but then the system is significantly more resource intensive (modem, phone line: cost) for the user. Perhaps a system can be built on multiple FM channels, thus multiplying the effective communication bandwidth at low cost to the end user? I should note also that as long as the system depends on modems for useful bandwidth, it's not much different from existing on-line services,

## PRIMARY DATA FROM THE FIRST YEAR

except that it doesn't cost anything to the user -- but zero cost is surely an artifact of the system's experimental status, and could not be continued in a commercial system." -- 1195

"Yes [additional newspapers]. Sure [professional journals]. Yes [schedules for meetings and the arts]. If it is possible to add more newspapers, that would be great! In particular, it would be great to get local news. I'd also be very interested in getting stock quotes/info. Would it be possible to find out when/where a particular article appears in newspapers? I would like to be able to refer friends, family, colleagues, etc. to a published article." -- 1201

"Additions: Washington Post, Wall Street Journal, US News and World Report." -- 1202

"-A means of marking and storing blocks of copy from the articles for later viewing or printing. -An undo feature for restoring mistakenly deleted articles -An on-line search facility for getting quickly to the part of the article that is of interest -An on-line editing facility for deleting or adding notes to different parts of an article. -A means of changing the margins of articles for easier reading on-screen -A gateway to DOS -A means of doing background printing on an EPSON LQ-1500 printer. -A means of knowing what line of an article is presently being printed to determine how long before printing is completed. -A means of selectively marking and then deleting articles through the article summary rather than deleting all at once or one at a time. -A way of limiting the number of articles in a given filter line without having to fill available storage first.

To these I would add a request: a) for making the software faster to exit -- with more than 100 articles stored (on a RAMdisk) this can now take over a minute. b) for adding an alarm whenever an article in a designated category is stored.

I am in favor of adding all the extra services you mention and would love to see the Los Angeles Times and The Wall Street Journal on line.

I would imagine a conferencing feature with specific topics listed and accessible through filter lines would also be a popular feature." -- 1204

"Yes [additional newspapers]. I would like to be able to access specific stock prices, and mutual fund prices. I use my system for specific information, but prefer to see the evening news for general news. I would also like to see classified ads that can be filtered, and the entertainment schedules. My interest in the system is diminishing because I can't filter specifically to my interests. For instance, under the heading (dentist\* or dental or teeth or tooth or periodon\* or periodent\*) I get mostly unrelated articles. I like to pick even the browsing reading that I do during the day (twice being such a factor). If I browse, I usually pick up something that might catch my interest. Take the subject of travel, for instance. I'd rather pick up the New York Times travel section than read the travel filter. I pick my browsing articles with more speed, and seem to get engrossed in full reading more easily." -- 1205

"Yes [to all suggested additions/modifications]. The project is so valuable it would be good to cover more newspapers and magazines. Washington Post etc. I'd love to see the photographs before editing (wire photos). Can you do this? I notice more now how different TV news is. Can you incorporate that?" -- 1206

"I would greatly appreciate receiving news from other wire services, e.g. the UPI or Reuters if possible. Also, if other newspapers around the country could be acquired, e.g. Washington Post, Chicago Tribune, L.A. Times. News magazines would be something else I would like to see, and possibly transcripts of news programs -- MacNeil Lehrer News Hour, Washington Week in Review, etc. Also professional journals, but that list is so extensive that I would suggest sticking with news oriented stories." -- 1207

"Software features -- make remote database use more 'goof-proof' (alt-d makes system crash). Would be very, very useful if the software were designed to run as a background task in high or upper-low memory. Generally, software is very nice to use. More international news would be very nice. As a Canadian, Canadian news is impossible for me to find. However, even other non-USA news would be fine. Less financial prices would be nice. Hard to monitor financial features without filling the filter with quotes on March potato futures. Adding more features, commentary would be great. Local arts and meetings also interesting." -- 1208

"Make the program a background RAM resident program. I'd prefer a dedicated board or interface so I don't have to swap RS-232 devices. AP and NYT are fine. Maybe add WSJournal. Need a delete all function for times when I can't read the news for several days and it's all old. Also need a way to eliminate duplicates." -- 1209

"You still can't beat the newspaper for general information -- far-ranging, features, items that catch the eye. But the system beats it

for reference, late-breaking news, and specific information. I'd like to see the Boston Globe on-line for local reference and be able to search back in the AP wire. Would like to see more reference ability; not so interested in schedules (movies, meetings, etc.) which are available in the newspaper or now on-line with CityNet. Would also like to search further back than 90 days in NYTimes or anything else for that matter." -- 1210

"Introduction

My only specific comments are about a new software feature I think you know has the potential to restore my (and others'!) initial enthusiasm for the CommInS system, which has declined a little.

Likes

Getting just the news I want

Getting interesting stories unexpectedly

Dislikes

How the CIS system ties up my computer

By talking about Double DOS and DesqView, you have planted in me a seed of an inexorable dissatisfaction. This occupies the foreground of my view of the CommInS system such that it obscures all other things I might have thought to mention.

It would be GREAT to have the CommInS system running along side my other applications. Because I do not have Double DOS or DesqView, I usually run the CommInS system for several hours when I am home AND unable to sit and work at my PC. Often I must shut down the CommInS system to use another application or to turn off the PC without having had the chance to spend time checking what was captured. Here are some of the implications:

1. Sometimes I never get around to the news articles
2. My system cannot capture articles when I'm using the PC with another application, even though at those times I am in the best position to invest some time in looking at what has come in.
3. My use of other applications 'punishes' me, reducing the amount of time my system can spend capturing articles for me, again at the times when I am in good position to look at some articles.

If the system came with a memory partitioning utility, I could just leave it on all the time (which is how it should be), not only to capture articles but also to pop out of what I am doing and quickly peek at what has been captured." -- 1213

"1) Better database maintenance capability - delete articles before a given date - lock articles against deletion - speed up database rebuilding x2) Better memory management for Double DOS users - allow system to be put in 'receive' mode where matching articles are only placed on disk. Database management is not performed. This will not only allow article reception to be done as a background task with little memory, it will also not cause a lower system article limit as a result of too little memory for database management. Later, the program can be run in full memory for database management. - support extended and expanded memory 3) Eliminate 'bounce' and make a blank screen default 4) Improve modem connection (make it easier) and document its use!" -- 1214

"Articles from News Commentary Magazine (e.g. the New Republic, The Nation, Atlantic) would be useful. Professional journals in my field (medicine) would be of tremendous interest to me. I would also suggest creation of a Users Group with 1. regular meetings 2. electronic bulletin board." -- 1216

"I would very much like to see text from Forbes, the Washington Post, and computer magazines such as Byte and PC Tech Journal. The only new software feature of interest is the ability to run the program in background without Double DOS or DesqView. Finally, some sort of graphics ability is necessary, even if only able to reproduce line drawings and simple charts." --1217

"Other news sources would be useful, say the Washington Post, Time, etc. This would probably be too much for one packet channel so it might entail a second radio frequency with either software or hardware switch in it. Also, more regional news from other regions than this one if possible. Software key response is slow. Perhaps put an on screen echo of keystrokes by intercepting PC Interrupt #9 (KbdHit). Ability to save to disk things downloaded via modem." -- 1218



## PRIMARY DATA FROM THE FIRST YEAR

"1. Would be nice to revamp software, add Color and Graphics. 2. I would use the system extensively if stock prices (even slightly delayed prices) could be obtained. 3. Entertainment listings for Boston would be of great value. 4. Setting filters should be made easier to implement. 5. Would be great to receive scientific journal articles of a specific type or field." -- 1219

"More local news and features. Stock prices. Maybe a user-driven electronic bulletin board updated by modem." -- 1220

"Yes [professional journals]. I would like to see specific professional journals in the area of astronomy or space." -- 1221

"A hardware feature allowing to switch from receiver to modem would be a real plus. People who are heavy modem users are not likely to find the attractions of CommInS great enough to sacrifice the convenience of their modem installation. Also, expanding service into areas covered by CompuServe, Citinet, etc. seems like re-inventing the wheel. How about a link with universities." --1222

"Yes [additional newspapers] especially foreign press (pie in the sky?) Yes [professional journals]. Yes [schedules for meetings and the arts]. Many articles seem to duplicate information found in others -- any way to screen these out? Still haven't had a chance to try modem -- in January. I hope I'll have the time! I haven't found it all that useful for newspapers alone -- not much in it that I don't get from reading the morning paper. Adding general magazines and professional journals would be a great help." -- 1223

"Improvements: 1. More timely stories (not just stories that have already appeared in the newspapers). Perhaps you can't do anything about this. 2. News stories tend to get repetitive. It would be useful to see more drama/movie/tv/radio listings and reviews. 3. I especially like the Times 'Roundup' features, where they describe what events will be covered in the next day's news. I always enjoy reading the 'Mass. Daybook' feature. These aren't the kinds of things that appear in the newspapers, and its the 'inside' nature, as well as the brevity and timeliness of the features, that make them interesting to me." -- 1224

"I have very little to suggest except 'more of the same' -- i.e. save of the items mentioned in the questionnaire: stock prices, TV schedule, local/regional arts and entertainment information, etc. I guess the remote feature needs mirror improvement. I find I'm not clear on how to disconnect, and I sometimes have my query re-submitted when I don't want that done. The manual should include a separate section on remote use rather than having the information interspersed with the directions for radio reception. I have purchased Double-DOS so that I can have the news services operating 24 hours a day, but have not been able to implement it yet because of 1) your software writing directly to the screen and 2) finding that 640K memory is inadequate to run your software and my word processing software. Have telephoned your office for advice." -- 1225

"I think the system could definitely be enhanced by the addition of other newspapers (i.e. the Wall Street Journal) as well as certain magazines. Professional journals lend themselves especially well to this system since one is generally looking for very specific information (or specific topics) in these journals, for which the query system is well suited. One software feature I would really like to see is an enhanced self-maintenance capability, where the user has more control and flexibility over which articles are automatically deleted and when." -- 1227

"Overall, I am extremely pleased with the system. The only major suggestions I have, I made 2 (maybe 3) months ago in my essay. Other than those, I would enjoy some content additions (local arts and movies, stocks). For your sake (during the testing phase), you might want to put some automatic recording features into the software. I know that for the 1st couple of months I only estimated my usage. Now I am recording my use while at the computer -- but still miss a few minutes or articles. Another thought -- such a system would allow you to learn how often people don't use the system at all. (By the way, when you ask for average use, do you want us to include days when we don't use the system at all, or only those days when it is used?)." -- 1228

"I do not feel that additional newspapers will help because most carry the same national and state news. I would, in any case, still have to read the local town paper for the community type news. Believe it or not, ads are still an important part of newspapers. Magazine articles would be nice." -- 1229

"Yes [schedules for meetings and the arts]. In addition to schedules of meetings for the arts, academic, community interests (a great ideal), additional focus on info dispersion would be nice. Abstracts from some of the major research magazines would be nice to keep us up-to-date on important research in the arts and sciences. Since I use the system for business/information uses, a wider range of articles & info is useful to me as opposed to longer more in depth stories. Other suggestions: Business Week, Science, Fortune, Airline/Airport status." -- 1232

"Having seminar listings is a great idea. My system cannot print in background. How can this be fixed? Also how about offering a background option (suggest last month) for the system." -- 1234

"Reuters, for more international coverage. Weather forecasts direct from NOAA. [Schedules for meetings and the arts] would be a nice addition. Filtering improvements: wildcards inside phrases, shorthand way to say (category: not sports). Fast way to look at first screenful of an article (without the automatic caching now done). After 2 months, your service is settling into a regular part of our daily routine. I now leave the machine on and running your program any time its not being used for something else. Our use of TV and Radio news is now down to zero. But our use of newspapers is down only a little. Because of computer hardware problems, the system was off for several days, and my wife complained so strongly that I moved in a substitute machine. There's a lesson in that; she rarely has time to read the papers, but your system's ability to focus on just a few topics got her hooked. Stripping away the clutter made all the difference. Looking ahead, I would suggest two main thrusts for your efforts: 1. more material, e.g. international news, local papers, 2. productivity improvements: faster printing, faster review of articles (summaries often say only 'Editors please not ..'), more precise filtering to save time weeding out stray articles, eliminating redundancies (e.g. check serial numbers against articles I've deleted in past 2 hours)." -- 1235

"Yes [to suggested information additions]. Better printer support. Improved documentation. I would like additional sources of information to be included in the project -- not only news media, but special interest magazines (computers, music, etc.). Radio and TV schedules as well as concert/lecture/movie schedules would be desirable. For example, I try to see as many Italian films as possible, but I often miss them when they are shown because of lack of information. I would like to be notified of all the Italian films playing in the Boston area. The greatest single improvement in the Project would be to improve the documentation. An index should be high priority (very easy to do with a word processor such as WP 4.2). More examples should be given. The transmitted material should be indexed more fully to allow better searching." -- 1240

"Yes [additional newspapers, schedules for meetings and the arts, and new software features]. Local paper (Middlesex News). Use of color, not just pretty -- but useful if used to denote such things as already read, age of article, repeat status, etc. Way to avoid duplicate article saves -- both within a filter and across system. Way to both limit total articles saved for one filter -- some go way over budget and also to avoid having articles deleted before you've looked at them." -- 1241

"I don't think magazine articles would be very useful. I use the system more for news than for feature-type information. Schedules of meetings and the arts, however, would be useful. Also useful would be some means of information exchange (uploading - although I understand this would add lots of work). A classified section would be very interesting. It would be nice if someone could modify the software so there'd be less snow on a LLa (??) display -- it's really awful and it is possible to do." -- 1242

"Including 'News Magazines' (Time, NewsWeek, etc.) would nicely complement daily newspaper articles." -- 1243

"I am seriously thinking of getting a hard disk because of this project -- diskettes are SLOW! I feel like I am wasting my time when browsing through lots of duplicate articles and waiting for things to be deleted -- also I am probably missing articles of interest due to limited disk space. I'd welcome any other types of information such as calendars of events, advertising, etc. Scanning classifieds in a newspaper is tedious." -- 1244

"The greatest improvement in the system for 1987 would be to expand the information available on the system to include full journals such as computer magazines and professional journals. Although it would be preferable to have the entire text of these journals, selected articles on a wider range would probably meet with more general support and interest." --1247

## January 1987

### Question # Text

Responses	Minimum	25th %tile	50th %tile	75th %tile	Maximum	Average
44	0.00	60.00	180.00	600.00	1440.00	381.52

44 Average time spent using Boston CommInS during last month : Computer Receiving Data from Boston CommInS \_\_\_\_\_  
Minutes/Day

PRIMARY DATA FROM THE FIRST YEAR

45	Average time spent using Boston CommInS during last month : Browsing Summaries caught by your Filter: ___ Minutes/Day					
97	0.00	5.00	10.00	20.00	180.00	17.92
46	Average time spent using Boston CommInS during last month : Browsing Full Articles caught by your Filter: ___ Minutes/Day					
96	0.00	5.00	10.00	20.00	120.00	15.12
47	Average time spent using Boston CommInS during last month : Reading Carefully Articles caught by your Filter: ___ Minutes/Day					
97	0.00	5.00	10.00	15.00	120.00	14.51
48	Average time spent using Boston CommInS during last month : Printing Articles caught by your Filter: ___ Minutes/Day					
91	0.00	0.00	1.00	5.00	120.00	4.64
49	Average number of articles found using Boston CommInS during the last month : Articles Caught: ___ Number/Day					
100	0.00	25.00	50.00	100.00	2000.00	118.31
50	Average number of articles found using Boston CommInS during the last month : Summaries Browsed: ___ Number/Day					
97	0.00	10.00	25.00	70.00	400.00	51.03
51	Average number of articles found using Boston CommInS during the last month : Articles Browsed: ___ Number/Day					
97	0.00	5.00	15.00	20.00	300.00	23.41
52	Average number of articles found using Boston CommInS during the last month : Articles Read Carefully: ___ Number/Day					
98	0.00	2.00	5.00	10.00	100.00	10.25
53	Average number of articles found using Boston CommInS during the last month : Articles Printed: ___ Number/Day					
98	0.00	0.00	1.00	2.00	30.00	2.21
55	I find that the information available is of: little interest--great interest					
112	1.00	6.00	7.00	8.00	10.00	6.96
57	Using the system, I feel: awkward--OK--comfortable					
108	4.00	5.00	7.00	8.00	10.00	6.83
70	I find the system has: no value to me--some--great value to me					
110	0.00	6.00	7.50	8.00	10.00	7.02
72	When looking for specific information, I prefer to: read the newspaper--use the system					
111	0.00	5.00	7.00	8.00	10.00	6.47
73	When reading for general information, I prefer to: read the newspaper--use the system					
111	0.00	2.00	4.00	7.00	10.00	4.47
81	I sit at the keyboard and use the Boston CommInS system ___ minutes/day on average.					
102	0.00	10.00	20.00	40.00	420.00	36.66
80	At the end of this experiment, I would be interested in subscribing to a commercial service using this technology: not at all--some--very much					
114	0.00	4.00	6.00	8.00	10.00	5.92
87	For the service exactly as it is, I would be willing to pay a total subscription fee of: \$ ___/month					
110	0.00	5.00	10.00	15.00	100.00	12.42
88	At the price named in the last answer, I would subscribe to the service with probability: zero--one-half--one					
109	0.00	5.00	8.00	9.00	10.00	7.38
90	If possible, I would be interested in buying only a partial subscription, say only to sports or a few other topics, in order to reduce the monthly fee: definitely no--maybe--definitely yes					

PRIMARY DATA FROM THE FIRST YEAR

	109	0.00	1.00	5.00	8.00	10.00	4.47
<b>91</b>	For a commercial system with classified ads (on jobs, automobiles for sale, housing, etc.) I would be willing to pay an EXTRA \$___/month						
	101	0.00	0.00	0.00	2.00	15.00	1.75
<b>93</b>	My interest in the system is: decreasing--unchanged--increasing						
	112	0.00	5.00	6.00	7.00	10.00	5.91
<b>104</b>	With the system, I feel: less informed--same--better informed						
	111	0.00	6.00	8.00	9.00	10.00	7.54
<b>121</b>	For a "black box" that would receive articles of interest while my personal computer was turned off, I would be willing to pay a (one time) cost of \$___.						
	106	0.00	37.50	50.00	100.00	800.00	89.54
<b>122</b>	At the price named in the last answer, I would buy such a "black box" with probability: zero--one-half--one						
	102	0.00	5.00	8.00	10.00	15.00	7.39
<b>129</b>	I use the modem connection for two-way access: not at all--some--every day						
	108	0.00	0.00	0.00	3.00	8.00	1.66
<b>130</b>	Of this time, I use the two-way features with my modem ___ minutes/day						
	97	0.00	0.00	0.00	2.00	100.00	3.75
<b>131</b>	Average number of articles found using Boston CommInS since the last questionnaire, via modem : Summaries Browsed: ___ Number/Day						
	67	0.00	0.00	0.00	5.00	100.00	4.18
<b>132</b>	Average number of articles found using Boston CommInS since the last questionnaire, via modem : Articles Browsed: ___ Number/Day						
	64	0.00	0.00	0.00	3.00	25.00	2.17
<b>133</b>	Average number of articles found using Boston CommInS since the last questionnaire, via modem : Articles Read Carefully: ___ Number/Day						
	64	0.00	0.00	0.00	2.00	20.00	1.41
<b>134</b>	Average number of articles found using Boston CommInS since the last questionnaire, via modem : Articles Printed: ___ Number/Day						
	64	0.00	0.00	0.00	0.00	5.00	.40
<b>135</b>	Average time spent using Boston CommInS since the last questionnaire : Computer Receiving Data via modem: ___ Minutes/Day						
	89	0.00	0.00	0.00	5.00	60.00	4.36
<b>140</b>	On average, I use the modem connection: less this month--same--more						
	88	0.00	1.00	5.00	5.00	10.00	3.76
<b>143</b>	For business/professional applications, I find the system: not useful--very useful						
	111	0.00	4.00	6.00	8.00	10.00	5.79
<b>144</b>	For home/personal applications, I find the system: not useful--very useful						
	111	0.00	4.00	7.00	8.00	10.00	6.13

PRIMARY DATA FROM THE FIRST YEAR

142	If paying for the system, I would prefer to be charged: a flat monthly fee[0]--a usage-sensitive fee[1]					
	[0]	78.00	[1]	32.00	Total	110

**Please tell us your thoughts on (i) the desirability of and (ii) the methods for the possible commercial extension of this technology at the end of this experiment. Please be as specific in your answer as possible!**

"I think it would be a good commercial product. If more financial info -- stock prices or access to public domain software it would be better." -- 1005

"I find the system very useful in trapping articles of particular interest, but I would rather read 'printed' material for general information. I am split on whether I would subscribe to the Boston CommInS service. For archival resources, I view CDROM technology as a more viable media than the news service. But, for instant news service, I view the Boston CommInS as a needed service. To make the system commercially probable, I would limit the functionality of the program if cost became a factor. My use for the system is limited, but what I use, I use daily. The modem connection could go, graphics is not needed, and the ability to capture articles without the PC being on is needed. Also, the system needs to run more than IBM PC's." -- 1006

"I feel that the charge should be close to the cost of a newspaper or magazine subscription. Between \$10-\$25/month would be about right. The system could be advertised in computer periodicals and magazines where there would probably be the greatest interest." -- 1007

"The system needs to work with a printer I didn't have a printer until now and enjoy it more reading on paper. The desirability depends upon the news service subscribed to. Its like asking if I would buy a newspaper. It depends on what the newspaper is. I don't like the AP service but do like the New York Times." -- 1009

"1) The price has to be reasonable. Critical for me would be the quality of information provided. I would pay much more for NYT than AP. The right price would be in the same ballpark as subscribing to the equivalent delivered paper, has some for the stuff you don't transmit. 2) The main change I would want to see would be a way to collect info silently -- I can't run at night while sleeping, more flexible, reliable filters and many people would want a less confusing user interface." -- 1013

"I think this type of service is desirable and will be more so in coming years with multi-tasking home computers. Like cable TV and videotex, it is very price sensitive -- since it does not replace but supplements newspapers (\$150/year), magazine (\$25/year), TV (I donate \$100/year to channel 2), etc. That is why I think the price of \$10/month is a good target. At \$20/month you'd lose me. Reading from screens at today's resolution (CGA) is barely acceptable and you can browse a newspaper faster. On the plus side, the concept of the filter and getting news topics (with certainty) and also less obvious topics is unique and useful. As to marketing it, I would target groups with high PC literacy such as BCS, librarians, high tech firms (an employee activity fund, benefit) and count on using referrals (use high cost advertising)." -- 1019

"1) Does this system have a real competitive edge over AP news (CompuServe and other information systems)? You may find you're in a tight squeeze price-wise. 2) Commercial extension -- I haven't a good idea really. If you're looking for a place in the market find a need not being met presently -- How about specific articles aimed at specific industries (i.e. Realtors, travel agencies, financial analysis, etc.)." -- 1024

"This system offers schools a wonderful potential to teach students how to develop research strategies. While schools (public) tend to be very conservative, there is a constantly growing interest by librarians and teachers. If it were to be marketed to schools there would have to be more supplementary materials (i.e. teacher's guide, student activities)." -- 1028

"Very desirable to commercialize. I would be happy to discuss my methods if suitable business arrangements could be established." -- 1032

"1. Target the business market -- clipping service customers, for example. For one thing, they'll pay more for the right service. 2. More AI in the filters, e.g. a filter which observes which article I actually read, and eventually points this out to me. 3. Ability to create multiple target subdirectories and specify which filter lines send articles to which subdirectories. Thus: 'Sam's articles', 'Articles related to our home care division', and 'Everything else'. Each subdirectory can then be searched & maintained separately." -- 1038

"Broadcasting info as you do could be viable if it can be shown to be more economical (substantially) than centralized filtering and distribution (via phone or broadcast) of the selected material (as e.g. with your clipping service). Have you made such comparisons? As I've said before, the main question is whether this facility can be integrated with various info retrieval and other functionalities." -- 1041

"Any handicapped individual would derive a great benefit from such a system. For me, having this system has enabled a more rounded personality. The information has allowed me to make informed decisions with respect to my personal finances, without having to rely on someone else's eyes. As you can see, I appreciate this lessening of the 'information gap' made available to me. However, while the system has been most helpful, I feel some changes should/could be made to further enhance [the] usefulness of the program prior to its commercial use. 1) configuration to run in the background, while other software is being used. 2) A 'black box' for receipt of articles, while the computer is off, would be most desirable for home users (not having computer in the office). 3) configuration to allow a choice of access to database either through com1 or com2 without clearing the buffer in unused com. (for speech etc.)." -- 1051

"The format of the system is good as is. It should be non-intrusive (no fan, no effect on system performance), and some of the negative features of this system (duplicate and old articles) should be cleaned up. The base of news services should be increased." -- 1057

"It is certainly desirable to commercialize the technology, but it will be difficult [to] perform the commercialization without some infrastructure. Just as television needs programs, a communication system will need various information programs. Just replacing a newspaper won't be enough. You will need a whole array of information services to offer. The line between what your doing and videotex is very slim. What I would do is come up with the equivalent of a radio schedule of services offered. There is no reason that the same information has to be repeatedly rebroadcast. Have time slots for specific information. Also have multiple broadcasting -- 1065

"If it isn't cheap, I wouldn't take it. It's very nice, but, basically, a luxury." -- 1068

"I'd like it to continue enough to pay \$10-\$15/month for the NY Times and Boston weather, i.e. as is. The analogy is to cable TV services and pricing in my mind -- on a personal household budget; higher if corporate. Since I moved it to the office to shape data with our [Oxfam America] Press office and Ex. Dir. I have less discretionary leisure time to browse at 6 am than at home. How about the corporate & personal package price as little more than the corporate package. I think that PC users not in the Arpanet would pay for a quality forum -- bulletin board like Arpanets and better than Bytes Info-Pix -- to include full text product announcements and reviews, both terse off-hand and publication quality. Perhaps funded or moderated by a Boston retail micro chain. Corporate info center managers would pay a premium I think and house users might pay a little." -- 1070

"I like the system but it has not become indispensable. If it could be commercialized at low cost, I would most likely take advantage of it. If the cost becomes comparable to most existing commercial databases I would not use it." -- 1072

"(i) software must be improved for commercial success & manual needs improvements on using filters (examples) to really zero in on topics of interest. I can never get filters to zero in enough -- partly this is because they catch omnibus stories with lots of little stories inside -- need also to understand broadcast cycle so do not miss (or minimize missing) stories if computer off some or most of time. Think that program consumes too much of a PC or XT to succeed as co-process. (ii) Maybe more likely on domain like all computer magazines/trade publications/tech journals that does not suffer cheap competition as news does. I would be interested in an abstract system of that domain." -- 1073

"Commercialization would be desirable to keep the system going. The problem of paying for it might be solved by some sort of advertising method. For example, if subscribers interest profiles were available, an advertiser would be able to target a very narrow market segment. This is somewhat the same as the profiles used in some technical magazines 'bingo' cards to send out literature. If subscribers didn't want this advertising, they would pay a higher price." -- 1076

"I enjoyed the system very much in the beginning, but the novelty has worn off and I am busier now so I find it easier to get news from newspapers of TV news." -- 1077

"i. Desirability -- depends on copyright (see below) and price. If I can't keep the articles, and have to pay lots for it, it's just an expensive toy to sell to hackers. ii. It could be marketed as a way to never have to read the parts of the paper you don't care about, never have a soggy paper and be able to save relevant articles on disk." -- 1080

## PRIMARY DATA FROM THE FIRST YEAR

"The desirability of the system should be high especially since its 'non-hard line' cost is low (except for modem use). Commercial extension of this system would be based upon how specialized or how many specialized compartments can be handled to please a wide range of interests with detail. (Increased sources)." -- 1084

"Our lab has a big problem with the software -- we have many incompetent users on the system who freeze it or simply neglect to return to it after using other programs: so everybody loves to get 'their' stories but finds it frustrating. This should not be a problem with most users where there are a limited number of people and less turnover on a single machine." -- 1087

"I think that this service is valuable to a large population of people. Its practicality will depend on either a peripheral device which can be left running when the computer is off or being used for other applications. When the 80286/80386 chips are running with true multitasking systems, the modem connection will be especially useful. Even now, I feel the modem system would be cost effective for me." -- 1088

"1) Need a 'black box' for storing information off line. 2) Need larger database -- more specific information than in AP and NYT (e.g. government announcements)." -- 1092

"Develop a menu-based query system for searching a classified database. Charge fees automatically to charge cards. Consider some of CitiNets features. Modem software should be more configurable." -- 1096

"(i) I think that there would be great interest in this system if it were commercially available. Its greatest asset, in my opinion, is that nothing needs to be done -- once the system is configured and running -- to capture articles that are of interest. Current systems require one to tie-up his phone line and laboriously search for items of interest. (ii) I like the idea of the 'black box'. How about renting this box as the monthly fee? Boxes which are able to receive more topics or journals could have a higher rate." -- 1098

"No comment" -- 1100

"I feel that this experiment is very suitable for commercialization due to the fact that news comes directly to the computer almost as it happens. The ability to collect a massive amount of information on the computer and being able to manipulate the information with normal computing tools that are available to current PC users should attract a large number of subscribers." -- 1106

"(i) I think the CommInS system has great desirability as a commercial product. It offers an easy way to quickly browse specific news items. If I hear about interesting news (say on the radio), I can quickly get more information by just adding a new filter line (or calling up the server). It offers a very interesting new alternative means of information retrieval. The cost of the system will be an important factor in its desirability. (ii) The best commercial implementation would be a sort-of 'pay-per-view' type of arrangement, where you pay not for each news item, but rather for each news category. People could subscribe to sports news, stock quotes, financial news, local/metropolitan news, etc. This way the service costs could tailored better to each subscriber's individual interests and budgets." -- 1109

"I like the modem set up. Being able to get information from the telephone line is great." -- 1110

"This type of service is desirable for those interested in specific information (news). I don't think it will completely replace the newspaper, although a list of all articles with a summary printed in the paper would go a long way to solving the diversity of a newspaper that seems impossible to capture on the system. Commercial extensions should include some community information (tv/movie/lecture schedules). Method: a monthly fee for the equipment and the service." -- 1112

"(i) Great commercial potential. Is there some way to eliminate identical files in the same filter line? An on-line message to the CIS operator would be useful through the modem connections. (ii) The expansion to other news services (e.g. Wall St. Journal, Business Week, etc.) would allow application of this technology to commercial areas such as Investment, Engineering, Military, etc." -- 1115

"As I have stated before, the desirability of this technology should be compared to that of a newspaper. If I can purchase the service at a price comparable to that of a monthly newspaper subscription, I would find this service attractive -- equivalent to getting a second newspaper. If you wanted to find possible commercial extension, then segment the market. Offer a separate stock price/commodities/options service that would be cheaper than Lotus' Signal. Offer a separate service that would send articles from different magazines -- Time, Newsweek, Byte, etc. Use separate subcarrier frequencies for the services and charge the user accordingly." -- 1116

"I feel anyone with a computer would be interested in having access to news articles, stock prices and/or classified ads. The ease with which you can use the CIS program with your PC makes it impossible to find it inconvenient. It is such an enhancement and computer users are naturally inclined towards finding ways that computers can make information processing easier. The subscription fee would be more than worth it to access timely news go easily." -- 1118

"I find the systems to be quite useful. I DO NOT feel the FM receiver is commercially viable since queries are impossible and the short time horizon inherent in the technology. I feel the modem connection is extremely useful and would be an amazing success if properly priced (properly means low). The existence of Dow Jones News retrieval and CompuServe or Mead's Nexus and Lexus provide illustration of how to price a modem service so high as to discourage anything but 'business' expense subsidized use." -- 1119

"The system is basically fun. Its business utility depends on the business you're selling to. It's particularly good at following specific issues. However, its not clear what measurable benefit the system is to my organization. In short, does the additional information have any actual value? If I could answer that question I could market the system." -- 1120

"I think there is a widespread market if the price is right! Particularly for news and BB type communication devices." -- 1121

"I really like the idea of a 'black box' buffering the information while the computer's off. I don't see any other rate structure other than a flat fee. How can you regulate FM?" -- 1124

"I think that the bcis technology provides the basis for a commercially successful product. In order for it to be successful, though, the software may need a bit more work, and the purpose of the system must be better defined.

The software is fairly easy to use as it is, but some extensions, such as more printer support, and a way of pasting 'addatends' onto articles would make it easier still. The ability to archive information, to save articles in a separate database for future use (an electronic clipping file) would also be very useful. I also think that a wider range of information services should be provided.

More important is the question of how to market the system. First, let us consider the packet-radio part of the system. BCIS provides an alternative to other new services, primarily the newspaper. But what advantages does it provide? Certainly, it is more timely than the newspaper (but not the radio). But it requires leaving a computer running for hours at a time, doesn't provide graphics, and occasionally the filters capture only parts of stories. For these reasons, I don't think that a packet radio BCIS-type service could be priced at much of a premium (if any) over a regular newspaper. Given a choice between paying \$18 per month for a Times subscription of BCIS, I would choose the Times -- it gives me much the same information, and I'm not tied to the computer when I want to read it. I also suspect that most people prefer reading print to displayed text, even those of us who are used to using computers extensively. Therefore, I don't think that a premium over the newspaper price could be charged for a packet radio news service. ....

Finally, let me expand on the legal restrictions issue. The current setup is very restrictive. Are we really supposed to purge our files every 90 days of printed copies of articles? I can keep a clipping from the Times for as long as I like -- what is so special about the version I printed on my Okidata? (Of course, it is the difference between buying and licensing the data.) I realize that there are tricky legal questions concerning who owns what sort of information, my point is that these questions may be crucial in determining the success of the technology. I would like to be able to keep an electronic file of data from the service. With the current legal restrictions (not to mention my limited disk space) this is not feasible. Yet keeping a 'personal database' seems to me to be one of the most useful aspects of this technology.

To sum up, I think there may be a small market for this technology if it is priced carefully. It won't soon displace the newspapers for the average user, but with an expanded range of services and less legal hullabaloo it might find an expanding niche amongst those with computers, modems, and the willingness to try something new." -- 1126

"General news info is already available at relatively low cost (newspapers, radio, etc.). Therefore, you compete with Nexus and other search services. To be worth the cost of searching, you would have to expand the databank -- e.g. Wall St. Journal, Forbes, Barron's, etc in the financial world. That would be worthwhile." -- 1127

"I think there is a possibility for a home market for an information service that is inexpensive and provides current interest (newspaper, weekly magazine type) information. I must run in the background or unattended overnight. Reception, though, is going to be an obvious problem. The average consumer doesn't want to fuss for hours establishing the setup, especially if there is an initial



## PRIMARY DATA FROM THE FIRST YEAR

cost factor involved. I don't think there will be a large enough market for professional information to be transported this way. Databases I would like to see: Time, Newsweek, Boston Globe, local info a la community access cable channels." -- 1131

"Excellent as a 'clipping' service, except that only a few publications are represented. Classified ads, jobs, houses, etc. sound very promising if the user can electronically sift through the ads, i.e. a '4 BR house <\$225K' or 'Cambridge'. The value would be proportional to the ability of the system to substitute electronic scanning for my time reading. I suspect business use would be a promising market. Differential pricing should consider which services/topics are of interest to business/residential users. I suspect the two sets have a small area of intersection. Consider time-of-day pricing for dial-up access. I would be reasonably happy to file a search request and have the results returned the next morning if there was a large cost differential." -- 1133

"Clipping Service. Satellite distribution." -- 1134

"I'm undecided whether it would be better to have a black box that caught broadcast articles or whether it would be better just to have an on-line system. I don't think the idea of using a PC as a filter/receiver would sell, even if the CIS works in the background. Perhaps people would 'download' their filters to a centralized filtering facility and call in occasionally to pick up their 'mail'. That way, people wouldn't have to leave their computers/black boxes on all the time and wouldn't have to type in search commands for the on-line system." -- 1137

"One method of extension would be to offer a repackaged receiver (in the form of a card) in order to install into a portable computer. Ideally, it would fit into the slot provided for a modem and be able to run off of the unit's power pack and/or AC. I'm very interested in the commercial prospects of this technology." -- 1138

"I would very much like to continue this service. I think a flat fee per month would be great depending on the number of services you subscribed to. I am interested primarily in international and national news. I would definitely prefer to use my computer for other services while have the news captured by the black box." -- 1144

"I think the system is valuable for hot-breaking news. I find it vague on specific topics. Sort of like the Boston Herald vs. the New York Times; even the Times articles. I would not pay more than my newspaper subscription (say 25 cents \* 30) per month. PC week and Infoworld both offer free subscriptions. Won't they supply text in electronic format if you can get ads inserted? I don't mind advertisements if the area of focus is narrow enough." -- 1150

"(i) A stand-alone all-solid-state (i.e. diskless) system with radio link would be highly desirable. Modem link has proved much less useful than I thought -- perhaps because data base is small and services limited compared to, for example, CompuServe. The simple system could, in principle, have your daily newspaper printed out for you every morning. I would buy such a gadget and suspect it would almost sell itself. (ii) I'm not sure what you mean by 'methods' but it seems the obvious path is to sell the dedicated hardware and then rent the monthly service." -- 1152

"(i) I don't have a real idea of what your market would be -- perhaps you do from your data. The key question is how many people/organizations who don't already pay clipping services need database management style access to information too current to be on extent on-line services? (ii) I would advise advertising in the sorts of periodicals you cover. The idea of a 'black box' that could capture data without computer sounds like a really good idea to me -- that allows people like me with antediluvian, small-core machines to use the machine and system non-competitively." -- 1153

"I think it is very viable as a commercial product. Reception needs to be perfected however -- i.e. if our ... gets moved at all, etc reception gets hopelessly screwed up. Also, what if you don't have a window facing the Pru? Reception is the biggest problem. Also, how would you transmit the comics?" -- 1160

"A commercial extension of this technology is very desirable. I find the system very useful. Perhaps following the same pattern as cable T.V." -- 1162

"I think the system has a great deal of commercial use. For business people interested in tracking particular markets and companies, it is of great value. It would be even better if WSJ and other publications were on-line. Also, the interface should be improved to reduce learning time." -- 1165

"Sell, with more information sources." -- 1168

"I would rather have the CommInS service than subscribing to the N.Y. Times. I would probably prefer the local paper for local news, but CommInS for national and regional news, if priced at level of newspaper subscription." -- 1171

"I find the current system very desirable and would use it more except for concerns about the effect of continuous use on the lifetime of my computer and especially of my hard disk. If it would be possible to combine the receiver, filter and storage capability in a diskless 'black box' as suggested I would find it more appealing -- have you considered using magnetic bubble memory, 1-2 megabytes say." -- 1173

"[some random comments about how to improve the user interface] ... Though the system would probably appeal to a great many people 'as is' I suspect that its attractiveness could be enhanced considerably with the addition of a few features or rule-changes. 1.Ability to work in the background, or better yet, on a separate 'black box'. I find I am frequently reluctant to use my PC for necessary tasks, so as not to risk missing incoming articles. This creates conflicts. 2.Ability to 'flag' certain film showings or cultural events per user-specified filter, as I suggested in Nov. or Dec. reply. 3.Ability (i.e. permission) to retain & share clippings and full articles. 4.Ability to create a print queue & to print in background on non-IBM printers (the majority today!). And items for sale, common interests, housing, etc. bulletin board feature could be a most attractive addition, provided there were a way to avoid overwhelming the user. Perhaps you have in mind an extension of the filter concept to keep things selective & avoid clutter. I would certainly hope so." -- 1174

"(i) As a reminder, I am visually impaired person. For myself and others with my impairment, a commercial offering would be quite attractive, for business as well as for personal use. With the system, I am clearly better informed. I would be surprised if anyone would not find the system increasing their productivity. (ii) My use of the system would not include use of the modem option. This leads me to prefer a flat fee scheme and retention of any modem feature as an option, the 'black box' ability to capture material when I am not at the computer (home and business office seems mandatory)." -- 1176

"I would be very interested in subscribing to some type of CommInS system. It is very difficult to say what I would be willing to pay without knowing what will be on the system and what is available on other competing systems.

The CommInS system is a combination of two different types of systems. The broadcast system is very useful for keeping track of current developments in specific areas or on specific subjects. The modem system is very useful as a starting point for looking into current topics.

I would assume the broadcast system has the greatest commercial possibilities for a low cost information system because its cost is independent of the number of users. It also does not require the home or small business user to dedicate a separate telephone line to the system. I like the CommInS system and would be willing to pay for it -- how much may depend on the competition. I have heard that cable TV is considering some type of computer news system. ... Some of the information you talk about adding, such as employment advertising, is available for free now on a very limited basis from services such as Boston CitiNet." -- 1181

"I would be interested in commercial extension -- especially with the cost begin a function of the frequency of use. Cost geared to selected topics should also be made available. The black box idea is also good as is the feasibility of being able to run other programs simultaneously." -- 1184

"Commercial extension of this technology is a must. Limited applications already exist, such as Telenet, Alexandria, Virginia and other services which integrate news and data in the same medium. Companies like Leading Edge are exploring low cost alternatives. Because information is time sensitive, I prefer the use of the FM receiver for continuous data. However, more specific subject headings would eliminate extraneous data.

In general, excellent proven concept. There is no reason why continuous data could not be received over telephone line for a flat monthly fee. (maybe even a cable transmission)." -- 1187

"(i) On-line news is one of the 'great things' many people have been expecting from the 'electronic revolution'. When speaking to family and friends not acquainted with computer technology, many ask why it isn't already available to the general public. I think that indicates a strong desire for the service on the part of the general public. Perhaps equally important, friends in the newspaper business (reporters) don't feel as threatened by the idea as they do by TV news. Advertisers, however, are another story. They could conceivably threaten to drop contracts with newspapers supplying stories to the service. AP, UPI and Reuters would not be affected, but syndicated features and individual newspapers (like NYT) might have problems. (ii) It seems to me that there is already an

## PRIMARY DATA FROM THE FIRST YEAR

example of this sort of commercialization in cable TV -- especially the all-news channels. I definitely think that receiving via radio is a better way to introduce the service: no telephone message unit charges, no effort to set up the communication, and the telephone line is left free for normal use. It's probably not feasible to broadcast each database separately -- not only would the on-line news supplier have to broadcast on several frequencies, but the user would have to make a choice about which frequency to tune in and when. So, at least at the beginning, it's probably best to offer a given package, say, AP and NYT, with the only options being unalterable filters. The biggest problem I see is protecting yourself from piracy. Phone #'s can be passed by word of mouth and even radio receivers can be rigged up. Perhaps you could look into a system like cable -- even after the hardware is in place the supplier maintains control." -- 1188

"This system has great potential as a commercial service. The key is to keep the price low; with the exception of the remote service, it should be priced at a flat rate. Also, the memory requirements should somehow be reduced to allow it to run in background with a full power up program in the foreground. Methods: because of the united and specialized market, you could get best results through user groups, BCS, and computer dealers. This is not an easy product to make commercially successful (i.e. make \$\$) given the low penetration of PC's. If you could tap the non-home market, the prospects improve greatly (add Wall St. Journal). Reception in downtown office buildings may limit the appeal of the radio service, and the remote service is already well-served with existing databases." -- 1192

"What I'd like to see -- Hardware: subscriber's choice of a 'black box' which can receive information while the computer is off (I'd pay \$200) or a similar box incorporating a dedicated modem to allow addition of the 2-way feature (\$300). Software: Allows downloading of data from black box to computer and optional access to central database via modem. Runs in background as 'windowable' task under MS Windows (or optionally Apple Macintosh or any other popular windowing system), and can signal through other applications when user-set filters are matched. Information offered: ... Classified ads would be useful only if they were (1) very comprehensive in coverage and (2) easily filterable to cut down the amount of junk through which the user must sift. Filterable display ads paid for by advertisers and optionally available at no charge to user might also be nice.

Some general remarks -- As matters stand, this system is not a direct substitute for newspapers, because for many people -- myself included -- half the value of a newspaper is discovering the unexpected, not just stories which match our existing 'mental filters'. Using this system -- or probably any computer based system at the present state of the art -- for extended, general interest browsing is impractical because of bandwidth and storage problems and above all because of the ergonomic drawbacks of even the best pc keyboards and video displays available today.

Nor is it a likely substitute for radio or TV, because of these media's richness of audio and/or video content and their unbeatable price -- usually zero after you've bought the receiver. Thus this system will have to be better/different in some important way in order to be more than a niche product like current on-line systems. Some possibilities -- 1. price: make it so cheap that the crude filtering abilities and somewhat limited database are worth having at the price. 2. broaden the coverage of the database to allow the user timely access to developments in areas of interest not widely covered by daily news media. 3. Make it easier to use than existing media. E.g. the filter which is not always an advantage for general news, could be a great tool for sifting classified ads -- if the ad database is as comprehensive as that represented by, say, a typical daily newspaper. 4. broaden the potential market beyond the current -- and fairly limited -- range of users who are very comfortable with PC's as they exist today or who are for some reason motivated to use them anyway. Possibilities to make the system more 'user-friendly': -Market the 'black box' as a simplified, inexpensive, free-standing terminal such as the French use in their national videotex system. -Integrate it into a Jef Raskin style 'information appliance'.

I think that the system's most practical function and most realistic market in the near future would be as an inexpensive news scanner/filter for those people who for some reason -- professional or other -- must keep up in a timely fashion with developments in areas of interest. Expensive scanner/filters are already available in many areas for those whose business/profession can justify the significant cost." -- 1195

"We view the service as exciting, interesting and useful -- all to a degree. City of Boston is a large governmental institution under continuing budget pressures. To this degree the service could be viewed merely as a frill if we had to pay a full commercial rate. On its present (exp. volunteer/free) terms its a positive boon. We have employed it to save executives' time to stay abreast of developments in government and technological fields of interest without having to peruse the NYT daily. Most users continue to read the local papers anyway so there has been some overlap in coverage. We seem to be approaching the service as two distinct entities. One, the on-line current wire, has received the most intensive use; although we have not succeeded in installing it via

DoubleDOS because our version of the program needed to be updated to run under DOS 3.2. Two, the 2-way system has been used almost exclusively to research a particular topic. It appears to us that a pricing mechanism that separated (unbundled) the over-the-air and two-way portions of the service might maximize ultimate subscriptions. Also usage sensitive pricing might apply best to the two-way service." - 1203

"I am very enthusiastic about the idea of CIS going commercial. I am far less certain about who else might be interested, though. My guess is that CIS works best as a research tool rather than as a source of random information. The 'serendipity' satisfactions of newspaper reading, casually scanning pages with a cup of coffee in hand, looking at the pictures, etc., is pretty much absent in a computer. I find it physically wearing, even painful, after a short time to scan a CRT for news and often can miss important information because my eyes have become tired. I don't know if others share my low threshold in that regard.

I'm pretty confident, though, that anyone needing the latest information on some topic will find CIS appealing. And adding consumer values like classifieds should be a big attraction. As someone once said it is not the features that sell product in the long run, but the value. Being able to flip through on-screen summaries quickly loses its pizzazz, being able to get quick information on a used car or new job opportunity is a joy forever.

In my own work as a television writer and producer, CIS serves as a source of fresh ideas. I have set my filter to catch as many human interest stories as possible (with category: people and category: names, for instance and type: nyt category: domestic) and usually get inspired once a week by the articles this nets me to do some stories of my own. Other people in the media like me might find CIS similarly useful.

The intellectual appeal of a product ('this might be great for me, maybe I should try it') and the visceral ('I love this thing -- gimme more!') are two different things, though. I have discovered that it takes a while to warm up to CIS's potential and I might not have kept at it if I were paying for it. The first few months, after the initial thrill wore off, I found little to appreciate in CIS -- the information was hard to filter properly, I couldn't harness its power, and I got tired reading everything it threw at me. During the last month, however, I have suddenly grown far more comfortable with and enthusiastic about it. This may be a natural process of [acclimating], of getting to know what I really want from it, of 'getting down my chops' with a new instrument. I would imagine, on that basis, that I might take several months to 'hook' a commercial subscriber and, to keep him interested until that happens, extra features that give instant gratification might be desirable. A conferencing ability might be one of those features, classified personal ads, even an occasional raffle, to be crass.

It's hard for me to name an acceptable price for such a service as CIS. I'm often stunned by how much I shell out for software I rarely use. I do think, though, that charging a monthly rate can discourage a lot of first-time users ('Gee, I better know a lot more what I really want it for, 'cause it's going to be costing me every second') whereas a fee for use attracts more novices, makes them feel comfortable, since it encourages experimentation and greater involvement and use in the long run. I, for instance, subscribe to CompuServe rather than the Source because the first doesn't charge a fixed monthly fee and the second does. And if anyone had told me at the start how much I was going to spend on CompuServe at the start I never would have subscribed. No doubt there is some marketing law that covers this, like 'the less you know about what it's going to cost, the more you'll pay for it.'" - 1204

"I find that I like to use the system for very specific information, such as exchange rates. Often when I try to get this information, I find yesterday's information on my screen. So I am learning to rely less on the system. I would be very interested in classified ads for real estate, but only for the period of time that I was selling or buying such. I would also be very interested in a system that would let me follow my stocks or mutual funds. I find that for professional purpose this system has very limited value. For instance, I can say that I have not missed an article in the NYT on dentistry. But the number of articles that appear having no relevance to the subject of dentistry is too great, and usually we hear about important news in the field by being made aware a day or two later by colleagues, or in professional journals. The fact that I have to detach my system in order to run any other software, is also a contributing factor to my slowly decreasing interest. I have shown my system to many people as a novelty and to show how 'with it' I am. However, I find it even awkward here when strangers see my menu of interests -- sort of an invasion of privacy." - 1205

"You must offer this after the experiment: we're hooked! I'm concerned about expense of course. It's also a problem that you can't save what you print: I should think researchers would be more attracted if you could adjust that restriction since a lot of us don't write our stuff in 90 days. It would be nice if the database would hold more than 90 days worth too. But that wouldn't entirely solve the problem. Don't link up with one of the phenomenally expensive commercial services. It would ruin everything." - 1206

## PRIMARY DATA FROM THE FIRST YEAR

"I personally would subscribe to the system but would only be willing to pay a small sum per month. The college I work for could pay much more and the information could then be distributed by them as needs or interests arose. I personally would not like [to] see limits on the type of information acquired as with cable TV where you pay extra for sports, HBO, etc. I think most people would be interested in a general news info bank that included classifieds as well with a flat fee or per use fee. Definitely would be preferable to use you computer while news was collecting in its memory -- I think people are ready for this type of service -- there is immense popularity for videotex in France for instance." -- 1207

"I would very much like to continue using this service at the end of this experiment, but would have trouble justifying it at a cost much above that of a newspaper subscription (I miss newspaper ads. I find them a valuable source of info.) The value of this service would be enhanced if it could receive info while performing other tasks. (I presently leave on the CommInS whenever I am not using the machine for something else. Admittedly, this might change if I had a modem.) Also, enhancing its ability to use ram-drives would be an asset. The present software seems to crash if you have less than 368K available." -- 1208

"I would see a commercial application of the filter could be more sharply defined. I'd pay as much as I would for the NY Times but prefer a one time fee. It would also require a lot of work on the user interface. I believe that many time sensitive businesses would subscribe to the service. Keep it inexpensive and pay for it over time.

Now that I've used it, I can see how valuable it is to have my news. I'm intrigued by filtering AP for specific topics and believe that has significant commercial value. I'm still amazed that a filter for 'turkey' (the country) gets me stories about truck lot prices ... Gotta fix the filter before people will pay. Also the slash commands need to be put on the function keys and I need to be able to edit filter lines on the fly." -- 1209

"(1)I'd buy at \$10 a month as it is. (Already pay a flat \$12 a month to BRS whether I use it or not. However, I dropped my 'Source' subscription because I found I wasn't using it enough. I use 'CompuServe' on a pay-as-you use basis and like that. However, neither offers me what Boston CommInS does and I want and need that (general news and some availability to search). I would like availability of more searchable databases (encyclopedia, Boston Globe, Wall St. Journal -- all more than 90 days). I'd still pay a monthly minimum to have access and would then agree -- as I do on BRS -- to pay for any [unreadable] in use above the minimum my monthly fee would buy. (2) The 'black box' capture of information would be very useful and I'd use the system more." -- 1210

"I would find the system desirable, but not at a high cost. Many sources of information are already available at modest prices: TV, newspapers, and magazines. Also, the software needs to be made easier to use. It requires too much knowledge and thinking to use. TV is brainless. You just watch and listen. As far as implementation is concerned, separate prescription topics could be made available by using a 'black box' in which special crystal modules controlling receiving frequency could be installed. As an alternative everything could be broadcast over one frequency and the black boxes programmed to receive, via transmitted codes, particular topics.

If a new topic is desired, a phone call to the service will result in a special code being broadcast. This code, when received, will program the particular users box to now receive the new topic. In a likewise manner, service could be terminated for non payment of bills." -- 1214

"I think the system has potential as a commercial product. Its desirability would increase with more sources of news (i.e. in addition to AP and NYT). I like a flat fee approach, one that is affordable, so that I wouldn't have to limit my usage because of fear of incurring too many charges. A black box that collected data with the computer off would be nice. I don't like the idea of leaving my PC on over night or during the day unattended. Classifieds wouldn't be a selling point for me. I can find them in the newspaper. Multitasking is definitely a big plus (or running background with programs like Desqview). I'm looking forward to getting the AST Premium board that I have ordered, so I can run the system while I do my other work. This will significantly increase my usage and the benefits of the system. I would buy the system as a supplement to the daily newspaper. I find it valuable in following breaking news stories. My usage tends to be issue based, I'll change my filter to follow aspects of a given news item, for example the Iran-Contra scandal." -- 1215

"Commercial extension would be useful for my profession -- medicine -- as a system to filter specific subject of interest in a large number of journals. My interest in general news is usually satisfied with newspapers." -- 1216

"The system would have to contain a much greater depth of information, from a wider range of sources. I would strongly recommend increased financial/business information, available on a timely basis. Fees should be a flat monthly charge, as the radio receiver needs to be used as much as possible to increase the number of interesting articles captured." -- 1217

"Commercial extension is very possible and probably cost effective. Commercial extension should include more services, Washington Post, magazines, etc. Perhaps special purchasing services." -- 1218

"With present software, I would not be willing to pay very much money for the service. I would only pay flat monthly fee, and fee should never exceed a daily newspaper cost." -- 1219

"It is tough to find a mass market which can be served better than by competing technologies! A number of ideas come to mind: (1) business related (to markets) (2) classified ads (paid by sellers) (3) local happenings such as cinema, presentations, etc. There are already two-way outlets -- some sponsored by ads -- that provide access to similar information. The advantages of (1) real-time information (2) powerful selection criteria and (3) low variable cost might be more apparent if there were more information sources available." -- 1220

"I would be willing to subscribe to a commercial system. My only objection would be that the advertisements should pay the cost (entire cost), not the person reading them." -- 1221

"A number of commercial services similar to the one suggested are already available. Unless this system could offer something unique -- a professional or academic network, for example, it is unlikely it could compete." -- 1222

"Probably has possibilities, especially for business -- professional use -- information on specific topics best." -- 1223

"I would definitely be interested in subscribing to a commercial version of the system. After all I have invested in an I/O Board and DoubleDOS in order to have the system operate 24 hours a day. Because of the poor reception of WERS in my area I would urge that delivery be by cable (perhaps that's the user's responsibility to pressure the cable company). Minor quibbles: It seems to me that when a story is garbled, it's almost always in the heading and/or in the lead sentence. Why? By numbering and temporarily saving the story numbers, could the many duplicates be eliminated? Could take 1 be queued before take 2?" -- 1225

"I feel the system has great potential for commercial feasibility, provided that the subscription rate is kept reasonable, say between \$10 - \$15 /month. In order to attain greater commercial appeal though, I think the user interface has to be refined a bit. The experiment is now limited to a small range of users who, for the most part, are familiar with computer and/or computer languages and therefore have little problem dealing with the query language. Other people, however, with less experience, might find it difficult or cumbersome to deal with the query system in order to get the information they want. As for classifieds, I think the system lends itself very well because it allows you to filter from thousands of classified ads [and] select a few which fit your criteria." -- 1227

"I would love to keep this service; many of my friends (who have seen it) would [like] to have such a service for home use. BUT, I can't see going too much higher than \$15 or \$20 a month -- that is not out of the rough price range of a newspaper. Admittedly, I get much more value than a paper (less, too, in that I can't catch the full range of stuff I'd like with my 2-floppy system). Still, as a private user, I can't see spending a lot. Multi-tasking would be great. I don't have a 1200 baud modem (I hope to get one soon) -- so I hate to turn off the ComlnS program." -- 1228

"Yes. This appears to be a very desirable product for business -- it will keep executives informed. I will have to defer marketing to marketing people, I have little experience." -- 1229

"The information of the system is very useful to me, however the substitutes available (radio, TV, newspapers) limit its exclusive hold on a niche. I'm sure that this attribute would change had I access to a modem on my business PC which would allow me to use the DB features. In fact, that is where the system is unique -- the DBing (a word?) of current, real-time news. Most other commercial DB services are 2 weeks to 2 months behind in their cataloging of articles. Also the idea of a 'black box' to capture useful info off-line is appealing. Many people would prefer not to leave their machines on round the clock (even though its probably better for the machine!)." -- 1232

"Good for current literature searches." -- 1233

"In thinking hard about this prospect, I find myself less keen on the idea than a couple of months ago. Here are the pros and cons as I see them: Pros -- up-to-date weather on demand; up-to-date ski report on demand; up-to-date stock report on demand; up-to-date top-of-the-news on demand; info on local towns (andover area); info on companies I deal with; info on out-of-the-ordinary topics (e.g. antitrust). Cons -- Yet another 'thing to maintain' in my life (at a time when I'm very stretched already); too technical - I can't

## PRIMARY DATA FROM THE FIRST YEAR

delegate it to my wife or secretary; still has too much clutter, e.g. redundant articles, too much on Iran, too many articles which turn out to be only advisories; limited by scope and depth of AP and NYT -- I often find myself wishing the coverage was broader. Price and Packages: should be something akin to cable TV. About \$20/month max. Fee Structure: flat monthly rate. I would be turned off by per-item charges. Classified Ads: no interest. Existing sources are less hassle (maybe there would be a small market for highly specialized kinds of things, e.g. computer programming). Modem 2-way Link: I would be willing to pay a small per-item charge for infrequent use. Enhancements to add value: Reuters, Dow-Jones, Arts/Entertainment calendar, lectures/speeches/conferences calendar, software improvements (better filtering, 'global' filters, faster display of 1st screen of an article, comment lines in filter, blackout of articles I've already deleted), stores' special sales and promotions calendar, filtered TV and radio listings." -- 1235

"I believe that it would be definitely worthwhile to make this system available commercially. Many individuals and businesses need to keep up to date in their fields, and would find a system such as this invaluable. However, the system needs to be greatly improved in a number of areas. The number and diversity of information sources should be expanded. Articles should be better indexed so that less extraneous information is captured. The user interface is poorly designed, and the documentation should be substantially improved. Better printing capability would also be required. Finally, it should be moderately priced." -- 1240

"Yes I think it should be made commercially available. There should be a flat fee which covers rental of receiver and base usage amount, plus fee schedule for extra usage -- although I don't know how you'd track this. Also, if black box were available, it could be purchased or rented for additional amount. I think the system would have a lot more commercial appeal if it made use of color." -- 1241

"i) Desirable? Absolutely. ii) Methods? I would be most interested in seeing it included as part of a CompuServe-type on-line service. You could set your filters and let articles accumulate while you were off-line, then log in to look at summaries and download interesting articles. It would be especially handy if the requested articles were in \*ARC or some other compressed form, to reduce download time. An alternative method would be the current broadcast system with an expanded receiver with its own storage system for storing filtered articles. This would eliminate the need to keep the PC on all the time and would allow articles to collect while the PC was otherwise engaged. A foreground/background OS that really permitted simultaneous operation could also be used, but there might be a problem when storing long articles and trying to access the disk for other reasons at the same time." -- 1242

"I think it would be very desirable to sell or lease this technology for commercial use. It would be great if the technology could be built into existing IBM portables or clone portables available today or leased as a complete system with computer, firmware and several different filters built into keyboard function keys. With added computer speech synthesis it would be great for the blind or visually handicapped or people in hospitals that are undergoing long treatment." -- 1243

"I would be extremely interested in the service particularly if it were to include most of the features of a newspaper (ads, classifieds, etc.) and was comparably priced. I see little reason that it should cost more than a newspaper. I bought an inexpensive used computer just for CommInS, so obviously I was willing to invest in a one-time hardware charge." -- 1244

"To adequately service a large enough # of customers to be profitable, response bandwidth must be enhanced, including the use of LPTV (low power television) licenses for packet video and data. For a scanner to keep up with data flow, preprocessing of word indices must be transmitted." -- 1246

"Has great value to the visually impaired for personal use as well as employment use. I believe that both a flat rate and a metered rate should be made available. Limited service, i.e. non-modem, should also be available. Journals of particular interest to the visually impaired professional and blind computer users would meet with greatest success in advertising this system." -- 1247

"... I would not pay to have the system installed if it were made commercially available. This derives from two conditions, both of which might be overcome. First, I have been restricted from operating in the receiving mode due to other uses of my computer. Perhaps this could be obviated by nighttime receipt of input, or by somehow implementing dual use of the computer system, for which I do not have adequate knowledge, and perhaps not even the hardware-software capability. Second, I have found the time necessary to browse and print too much for me. I have not successfully printed articles, having used the print-screen mode." -- 1249

**I would definitely want to subscribe to these topics:**

- "movies, Claiborn" -- 1005
- "business, wall street" -- 1006
- "jobs, news, for sale" -- 1007
- "government and general news, financial, science and technology, computers." -- 1009
- "hard news, NYT" -- 1013
- "business, technology, medical" -- 1019
- "computer info, daily headlines" -- 1024
- "news, (subject: africa or usar)" -- 1025
- "too specific" -- 1032
- "news, business" -- 1038
- "commentary, news" -- 1043
- "NYT wire" -- 1045
- "news, travel" -- 1057
- "New York Times" -- 1065
- "news" -- 1068
- "NYTimes, Stocks, top quality PC info net" -- 1070
- "travel" -- 1071
- "commentary, business" -- 1075
- "entertainment/lifestyle, wine/cooking" -- 1080
- "financial, commentary/editorials" -- 1084
- "science/medicine, international news" -- 1088
- "news, sports" -- 1098
- "national news, foreign news, business" -- 1100
- "news, stock market" -- 1106
- "news, local events" -- 1109
- "finance, science" -- 1115
- "category: news, subject: newssummary" -- 1116
- "financial and economic news" -- 1119
- "environmental issues, sports" -- 1120
- "news and computer topics" -- 1121



PRIMARY DATA FROM THE FIRST YEAR

"Wall Street, science" -- 1124

"New York Times -- news only" -- 1126

"financial" -- 1127

"financial, technical/computer, recipes [??]" -- 1130

"domestic and international news, business news (general)." -- 1133

"financial, science" -- 1134

"financial, investments, general news" -- 1138

"foreign affairs, politics" -- 1141

"international news, national news" -- 1144

"varies from month to month" -- 1150

"news, science related topics, computer related topics" -- 1153

"business" -- 1161

"financial, sports" -- 1165

"finance, business, health" -- 1173

"international and editorial, scientific, technological, financial" -- 1174

"NYT, electronic news" -- 1176

"business, financial, local news" -- 1181

"financial, stocks" -- 1187

"(category: news) ("high priority"), patents and technology" -- 1188

"political, telecommunications, sports" -- 1192

"science, medicine and computer related categories" -- 1195

"taxes, law" -- 1197

"I'd like to be able to change it dynamically" -- 1201

"exchange rates" -- 1205

"arts, washington briefs" -- 1206

"would not want limits on the service" -- 1207

"news, international news, finances, comments" -- 1208

"international" -- 1209

"news (local and national), weather and TV listings" -- 1214

"business headlines, medical news" -- 1219

"stock ticker" -- 1220

"news" -- 1221  
"foreign affairs, computers" -- 1223  
"NYT features" -- 1225  
"news service" -- 1227  
"business/financial/news" -- 1232  
"sports, news regarding specific cities" -- 1233  
"business, local (andover area) info" -- 1235  
"aviation, computer technology" -- 1242  
"computers, human interest" -- 1247

---

**I would definitely NOT want to subscribe to these topics:**

"sports" -- 1005  
"sports" -- 1006  
"sports, personals" -- 1007  
"sports, weather, hard news" -- 1009  
"associated press" -- 1011  
"sports, tv schedule" -- 1019  
"sports" -- 1024  
"massachusetts daybook" -- 1025  
"sports" -- 1038  
"unknown, undefined" -- 1043  
"AP wire" -- 1045  
"sports, classifieds" -- 1057  
"AP" -- 1065  
"sports" -- 1068  
"sports, ads" -- 1070  
"sports!" -- 1076  
"sports, financial" -- 1080  
"sports, travel" -- 1084  
"sports" -- 1088  
"sports" -- 1096

PRIMARY DATA FROM THE FIRST YEAR

"financial/business" -- 1098

"sports" -- 1100

"sports" -- 1109

"sports, lottery" -- 1115

"massachusetts daybook" -- 1116

"advertisements, movies, schedules, etc." -- 1119

"wall street news" -- 1120

"sports, entertainment" -- 1121

"sports" -- 1124

"sports, stock market" -- 1126

"general daily news that I read about and hear on TV news" -- 1130

"sports" -- 1133

"sports, cooking" -- 1134

"sports, stocks" -- 1137

"sports" -- 1138

"sports, features (domestic)" -- 1141

"sports" -- 1144

"varies from month to month" -- 1150

"sports, financial" -- 1153

"sports" -- 1161

"sports, pop culture" -- 1174

"governor's calendar, sports" -- 1176

"sports, entertainment" -- 1181

"sports, general news" -- 1187

"mass\* digest, movie\*" -- 1188

"sports" -- 1197

"sports" -- 1199

"I'd like to be able to change it dynamically" -- 1201

"all sports" -- 1205

"sports, price of cheese" -- 1206

"would not want limits on service" -- 1207

"sports" -- 1208  
"sports" -- 1209  
"sports" -- 1214  
"sports" -- 1215  
"sports, local news" -- 1219  
"sports" -- 1221  
"sports, daily news" -- 1223  
"sports" -- 1225  
"sports, entertainment" -- 1232  
"sports, Iran, etc." -- 1235  
"sports" -- 1242  
"sports, weather" -- 1247

---

**If you were a participant in the Boston CommInS last May, please tell us whether and how the availability of the 2-way system has changed your opinions about the desirability of possible commercial extensions of the technology.**

"The two way ability would enhance the commercial aspects, especially being able to query a financial database." -- 1005

"I do not use the 2-way system because the information I deem important is what happens today. I will use a library for past articles, provided they are on a suitable media, such as CD Rom." -- 1006

"I use it periodically to get articles I might have missed on a certain subject. I feel that it is a very welcome addition to the system." -- 1007

"Have not used 2-way system." -- 1011

"I'm afraid I very rarely find use for it. I have enough capacity in my AT to capture most of what interests me 'on the fly'." -- 1013

"Sorry, but haven't tried it yet. Planned to hack up a modem over Christmas but didn't get to it yet. Seems like a good idea for someone who is away for a few days or needs to research a topic of current interest." -- 1019

"1) I'm having trouble running the 2-way system. 2) Don't like the idea of tying up a phone line for hours daily. 3) Like idea of a black box which would receive while I use my PC otherwise. Personally much prefer the radio system of reception." -- 1024

"I haven't used the system yet." -- 1028

"I haven't used the 2-way very much. I need a better reason to use the modem connection for data." -- 1032

"Yes" -- 1038

"The 2-way system is a major step forward. Ultimately, access to larger databases is vital and this is one mechanism for so doing." -- 1041

"2-way makes it too much like other services -- (e.g. CompuServe), although query approach is nice. Probably, radio-only system could be sold to a wider audience at lower cost." -- 1043

PRIMARY DATA FROM THE FIRST YEAR

- "Not at all: I have not really given the 2-way system much of a chance, but my initial impression is that the data base is too limited. Such a system should have a lot of information to be really attractive." -- 1057
- "No real change. I don't use it." -- 1068
- "Just haven't had time to hook it up. I will as soon as I get it working on the network ... Now I have to switch Hayes settings on modems 3 ways on PCs -- for FIDO incoming, Qmodem outgoing and Banyan asynch PC to network. Hope your settings are soft or similar to one of these." -- 1070
- "I prefer the 2-way system and could probably do without the FM broadcast entirely if some of the improvements I have suggested in previous questionnaires were made." -- 1072
- "Haven't used yet." -- 1073
- "no" -- 1076
- "I have not used the modem connection." -- 1077
- "I find the 2-way system virtually impossible to use. Also, it's not very useful to me. I can use it to search for articles in NYT or AP, but I can't keep copies of these articles for extended periods (up to 6 months), nor can I distribute CommInS articles around my company, therefore I have to use CommInS as an index and obtain hardcopy for files or in house circulation. For personal use, therefore the majority of my usage, it's just fun to read articles and browse. For business, CommInS isn't any use -- also it doesn't have the NASDAQ stocks I need, so I have to buy NYT in hardcopy. For pleasure browsing, why bother with the 2-way feature?" -- 1080
- "The availability of the 2-way system has made our view much more favorable. We will use it when our modem is repaired." -- 1084
- "2-way sounds great although we have not been using it." -- 1087
- "The 2-way system is the only part of the system that fits into my lifestyle. It offers complete searches at my own convenience. I feel it is commercially viable and I'd be likely to subscribe at moderate prices (e.g. up to \$15 per month)." -- 1088
- "Not using this feature." -- 1092
- "I haven't tried the 2-way system yet." -- 1096
- "I think the 2-way system makes the system more desirable simply because of the flexibility it provides and the security of having a complete base of articles to filter in case you may have missed something. Unfortunately, I am not able to use the 2-way system, but I would like to." -- 1098
- "The availability of the 2-way system has added versatility to the current basic system in that categorized information such as classified ads should be suited for this application." -- 1106
- "The availability of the two-way system has made the system much more commercially attractive to me. However, it raises some questions concerning scale. The system without the two-way service has the benefit of very small incremental cost increase per subscriber (only the cost of the box, software duplication, and manual reproduction). Adding more subscribers to the two-way system means adding more modems and telephone lines, more powerful computers, etc., thus increasing the incremental cost." -- 1109
- "I like the 2-way system and use the system a lot more ..." -- 1110
- "I have not used the 2-way system." -- 1112
- "I have found it impossible to get into the remote system -- possibly because of too few lines?" -- 1115
- "Though I haven't had a modem to use the 2-way system, the commercial extensions of the technology are similar to that of the 1-way system. Target a market that would pay a price for recent up-to-date information. Perhaps lawyers would be willing to get

- the service if they need to do research on recent cases that have not had time to appear in law journals. It all depends on finding people who need a certain type of information." -- 1116
- "I do not have a modem at the present time." -- 1118
- "The modem option has increased the strength of my opinion regarding commercial extensions of the system. Quite frankly, I do not see many people paying much \$ for just the FM receiver feature due to its extreme limitations." -- 1119
- "Has not changed it at all. I have only one port on my XT. Its too inconvenient to disconnect the local system and reconnect the 2-way system. Therefore, I have only done it once." -- 1120
- "Unchanged." -- 1121
- "I think it's a great innovation, but I haven't really taken advantage of it. The end of the term crunch left me with little time. Obviously, the 2-way features make it a more desirable commercial product." -- 1124
- "... For general use, I find the modem system useful for getting caught up on past news after not having read it for a few days. It also has an obvious potential for research, replacing or supplementing the printed indexes for the Times. How useful the database is for research depends on how far back it goes, and this runs a foul of your 90 day limit. Pricing of the modem connection may be best done on a connect-time basis." -- 1126
- "I don't yet have a modem." -- 1127
- "I moved the equipment to my home in Tyngsboro, Ma before Christmas for anticipated use on my Epson Equity 1 system. I discovered too late that it was very inconvenient to switch between a modem (my primary use) and the antenna with one serial port. I therefore made the decision to install an AST board with additional serial port. I did this 1/30. To my disappointment, I have not been able to get the system operational with my new configuration. No articles are being captured. I am doing the obvious trouble shooting but will be calling for some more ideas on what I should try." -- 1131
- "Haven't tried it yet. Look forward to it, but I need to set up comm. software to work with a non-standard modem. Seems good if you've been off-line for a couple of days." -- 1133
- "I have been freed from wearing out my dual hard-disk. It's like life after the super-bowl, that is up until the Sox opener." -- 1134
- "I'm not too interested in the 2-way system. I have no need to access the database." -- 1136
- "I have just received a 1200 baud modem & will be accessing the 2-way system. I think I will like this even more for retrospective searching." -- 1144
- "I think the two-way system is better but I find the interface kludgy and it holds my phone line open. A primer on what information is available would be helpful." -- 1150
- "The two-way system has impact for me only if a much larger database were available. I catch items of interest to me 'on the fly' and have had little occasion to search for yesterday's news." -- 1152
- "not at all" -- 1153
- "We don't have a modem, but if we did we'd surely use it with the CIS system." -- 1160
- "N/A" -- 1162
- "Not at all. I don't have the modem needed to use it." -- 1165
- "Really haven't used it." -- 1168
- "For research on specific topics or items, the 2-way system is tremendous! Where as the receiver is great for intercepting 'breaking' news, the modem connect to the database is good for background research on specific topics." -- 1171

PRIMARY DATA FROM THE FIRST YEAR

"I find the 2-way system cumbersome to use -- mainly because my Qubie 1200 interior modem is not exactly hardware compatible with Hayes. If laser disc read-write devices become available it would seem like a reasonable approach to [sending] the entire database to the remote [site] with automatic purging after 90 days -- let the database inquiry occur locally -- at the remote site rather than via phone line. Laser disk might provide enough storage for pictures as well as text." -- 1173

"I view the 2-way capabilities as a valuable enhancement, but secondary to the main value of the system -- that it is based on immediacy. The two-way query system is great if one is an active researcher referencing the NYT, or for hindsight generally, or if one's computer was off-line for a significant period of time. ... And why not an AP archive as well?" -- 1174

"I was not [a participant] last May." -- 1176

"The value of the modem system depends on what information is available. The limited information available now is very useful for someone who is not willing to pay for a 'regular' service such as the Source or Dow Jones. If some more services could be added to the system and not make it very expensive, I would subscribe. I find the current modem system very easy and quick to use." -- 1181

"N/A" -- 1187

"N/A" -- 1192

"... the 2-way system, has been used almost exclusively to research a particular topic or check facts regarding news coverage (treatment) of a particular topic. It appears to us that a pricing mechanism that separated (unbundled) the over-the-air and two-way portions of the service might maximize ultimate subscriptions. Also usage sensitive pricing might apply best to the two-way service." -- 1203

"Since I signed up in October, but didn't use the remote until January, I'll answer this anyway. It's definitely a better service with the remote if you don't have the computer on all the time for real-time news. I've had a lot of trouble with it though. It crashed on me 3 times today for instance (1st it said put disk with com.com in A (it was there already); then it froze when I asked for the summaries after reading an article; then it said stems must be at least 2 characters ... and I couldn't get it to move to the next query) -- very temperamental! The remote is very useful for research; for instance I'm trying to look at all the Alzheimer's stuff and when new material came in, I had a crash and lost it all, so I could get it off the remote. I would say it's really an essential part of the system if you commercialize." -- 1206

"Sorry -- no modem." -- 1208

"Not a participant in May." -- 1217

"N/A" -- 1218

"Not a participant." -- 1221

"I make practically no use of the 2-way capability of the system -- particularly now that I can, through Double-DOS, have the system 'on' 24-hours a day. Let me put it this way: I don't think I would pay very much extra for a 2-way option. If there were access to other data banks (libraries), I think I would want the service." -- 1225

"I was not in during May." -- 1228

"N/A" -- 1229

"I did not participate" -- 1233

"N/A" -- 1235

"Not a participant." -- 1241

"Was not a participant then." -- 1242

"I was not a participant last May." -- 1243

"2-way most valuable, if quick response is available via tuner-addressed packet transmissions. More useful publications such as Aviation Weekly and Space Technology magazine and up-to-date scientific and science fiction publications." -- 1246

---



**CS-TR Scanning Project**  
**Document Control Form**

Date : 4/26/96

Report # LCS-TR-397

Each of the following should be identified by a checkmark:  
Originating Department:

- Artificial Intelligence Laboratory (AI)  
 Laboratory for Computer Science (LCS)

Document Type:

- Technical Report (TR)     Technical Memo (TM)  
 Other: \_\_\_\_\_

**Document Information**

Number of pages: 183 (189-IMAGES)

Not to include DOD forms, printer instructions, etc... original pages only.

Originals are:

- Single-sided or  
 Double-sided

Intended to be printed as :

- Single-sided or  
 Double-sided

Print type:

- Typewriter     Offset Press     Laser Print  
 InkJet Printer     Unknown     Other: \_\_\_\_\_

Check each if included with document:

- DOD Form     Funding Agent Form     Cover Page  
 Spine     Printers Notes     Photo negatives  
 Other: \_\_\_\_\_

Page Data:

Blank Pages (by page number): \_\_\_\_\_

Photographs/Tonal Material (by page number): \_\_\_\_\_

Other (note description/page number):

Description :

Page Number:

IMAGE MAP! (1-183) UN# 'ED TITLE PAGE, 1-ii, UN# 'ED  
INFO. PAGE, 1-178  
(184-189) SCAN CONTROL, COVER, DOD, TRGT'S (?)

Scanning Agent Signoff:

Date Received: 4/26/96 Date Scanned: 4/29/96

Date Returned: 5/2/96

Scanning Agent Signature: Michael W. Cook

**REPORT DOCUMENTATION PAGE**

1a. REPORT SECURITY CLASSIFICATION Unclassified		1b. RESTRICTIVE MARKINGS	
2a. SECURITY CLASSIFICATION AUTHORITY		3. DISTRIBUTION/AVAILABILITY OF REPORT Approved for public release; distribution is unlimited.	
2b. DECLASSIFICATION/DOWNGRADING SCHEDULE		4. PERFORMING ORGANIZATION REPORT NUMBER(S) MIT/LCS/TR-397	
5. MONITORING ORGANIZATION REPORT NUMBER(S) N00014-83-K-0125		6a. NAME OF PERFORMING ORGANIZATION MIT Laboratory for Computer Science	
6b. OFFICE SYMBOL (if applicable)		7a. NAME OF MONITORING ORGANIZATION Office of Naval Research/Department of Navy	
7b. ADDRESS (City, State, and ZIP Code) 545 Technology Square Cambridge, MA 02139		7c. ADDRESS (City, State, and ZIP Code) Information Systems Program Arlington, VA 22217	
8a. NAME OF FUNDING/SPONSORING ORGANIZATION DARPA/DOD		8b. OFFICE SYMBOL (if applicable)	
9. PROCUREMENT INSTRUMENT IDENTIFICATION NUMBER		10. SOURCE OF FUNDING NUMBERS	
8c. ADDRESS (City, State, and ZIP Code) 1400 Wilson Blvd. Arlington, VA 22217		PROGRAM ELEMENT NO.	PROJECT NO.
		TASK NO.	WORK UNIT ACCESSION NO.
11. TITLE (include Security Classification) <u>Boston Community Information System 1986 Experimental Test Results</u>			
12. PERSONAL AUTHOR(S) Gifford, David K., Heitmann, Dawn, Segal, David A., Cote, Robert G., Tanacea, Kendra and			
13a. TYPE OF REPORT Technical	13b. TIME COVERED FROM _____ TO _____	14. DATE OF REPORT (Year, Month, Day) August 1987	15. PAGE COUNT 178
16. SUPPLEMENTARY NOTATION			
17. COSATI CODES		18. SUBJECT TERMS (Continue on reverse if necessary and identify by block number)	
FIELD	GROUP	database system, electronic newspaper, distributed information system	
19. ABSTRACT (Continue on reverse if necessary and identify by block number) This report describes the first year of an experimental test of the Boston Community Information System (Boston CommIns). The experiment implements new ideas of data communication and database design in the transmission and reception of data. The system offers the <u>Associated Press</u> and <u>New York Times</u> to participants and is provided in exchange for their monthly feedback. During the first year of the experiment, over 200 homes and businesses in the Boston area used and evaluated our system. This report contains all the data we have compiled and analyzed, in addition to a full discussion of several hypotheses and data goals. Among the conclusions drawn, we found the Boston Community Information System provides a useful complement to existing media forms and has proved valuable to the many users in the test population.			
20. DISTRIBUTION/AVAILABILITY OF ABSTRACT <input checked="" type="checkbox"/> UNCLASSIFIED/UNLIMITED <input type="checkbox"/> SAME AS RPT. <input type="checkbox"/> DTIC USERS		21. ABSTRACT SECURITY CLASSIFICATION Unclassified	
22a. NAME OF RESPONSIBLE INDIVIDUAL Judy Little, Publications Coordinator		22b. TELEPHONE (include Area Code) (617) 253-5894	22c. OFFICE SYMBOL

12. Burmaster, David E.