

SYSTEM / **32**

**IBM System/32
Installation Manual
Physical Planning**

32

*IBM System/32
Installation Manual
Physical Planning*

GA21-9177-5
File No. S32-15

Preface

This publication contains information of interest to anyone planning to install an IBM System/32. It contains physical, electrical, and environmental specifications and offers a few suggestions for preparing the data processing room for the system before the system actually arrives.

Careful advance planning lets you install the system with little or no interruption of the daily office routine. If you need additional assistance, IBM sales representatives, customer engineers, and installation planning representatives are available for consultation.

Sixth Edition (January 1977)

This is a major revision of, and obsoletes, GA21-9177-4. Information on voltage changes for GBG/I for the 5321 Mag Card Unit have been added and miscellaneous changes have been made throughout the manual. Additions and changes are denoted by a vertical line at the left of the addition or change; new or extensively revised illustrations are denoted by a bullet ● at the left of the figure caption.

Changes are continually made to the specifications herein; any such changes will be reported in subsequent revisions or technical newsletters.

Requests for copies of IBM publications should be made to your IBM representative or to the IBM branch office serving your locality.

A readers' comment form is at the back of this publication. If the form is gone, address your comments to IBM Corporation, Publications, Department 245, Rochester, Minnesota 55901.

PLANNING FOR THE INSTALLATION OF YOUR	
IBM SYSTEM/32	1
Space Requirements	1
Scheduling	1
Relocation	1
Environmental Considerations	2
Temperature and Humidity	2
Fire Protection	3
Electrical Requirements	3
Power Supply	4
Power Distribution	4
Grounding	4
Lightning Protection	4
Convenience Outlets	4
SYSTEM SPECIFICATIONS	5
Standard Symbols and Specifications	5
5320 System Unit	6
Plan View	6
Specifications	6
5321 Mag Card Unit (MCU)	7
Plan View	7
Specifications	7
1255 Magnetic Character Reader Models 1 and 2	8
Plan View	8
Specifications	8
1255 Magnetic Character Reader Model 3	9
Plan View	9
Specifications	9
129 Card Data Recorder	10
Plan View	10
Specifications	10
5496 Data Recorder Models 1 and 2	11
Plan View	11
Specifications	11
CABLING INFORMATION	12
INCH TO CENTIMETRE CONVERSION CHART	14

SPACE REQUIREMENTS

At the time you place your order for the system, prepare a preliminary layout of the data processing area. Because of differing room sizes and shapes, support column locations, desk and file cabinet requirements, and work areas, we cannot publish a single floor plan that will satisfy everyone's requirements. However, experience has taught IBM that the customer should prepare a floor plan of the proposed data processing area, showing the location and arrangement of all equipment to be included. As you plan the area, consider the possibility of future expansion so that, as your business grows, you can add more equipment without making costly and time-consuming revisions to the original plans, or to the data processing area.

You should provide enough space for people to work efficiently. For example, it is essential that you provide space for servicing the equipment. (The service clearances shown in the specifications page are minimum clearances needed by the IBM customer engineer.) You should provide space for storing system manuals and support documentation. The manuals can be put in a book cart, which can then be placed anywhere in the data processing room that does not interfere with normal work. For example, if the manuals are put in a customer engineer's book cart—about 46 x 56 centimetres (18 x 22 inches) in size—documentation can be stored within the service area designated for the system.

IBM provides a clear acetate template (GX21-9178) of the system that you can use as you determine your floor plan. The template, which is scaled at 1 mm = 48 mm (1/4 inch = 1 foot), provides a floor view of the system and the minimum area that is required around the system for operator and customer engineering work space. When cut apart and used on a 1 mm = 48 mm scale drawing of the data processing area, the template can be moved about to help determine the best room arrangement.

In summary, consider the following items when determining space requirements and unit locations:

- Work space
- Storage space
- System, desk, file, and miscellaneous equipment space
- Aisle space and service clearances
- Space for future expansion
- Weights and floor loading
- Heat dissipation
- Electrical requirements, including service, outlets, and communications facilities (telephone or telegraph lines, etc)
- Doorway sizes, elevator capacities, and loading facilities that will be used while moving the system to the data processing area

SCHEDULING

To be sure that the data processing area is ready when the system is delivered, you may need to schedule alterations and additions to the existing facilities. Any alterations to the area should be finished before system delivery.

RELOCATION

The 5320 system unit should not be moved without prior preparation by IBM customer engineering.

ENVIRONMENTAL CONSIDERATIONS

Temperature and Humidity

The temperature and humidity of a data processing area are influenced by many factors. These include:

- Heat produced by mechanical and electrical equipment
- The volume, temperature, and humidity of fresh air entering the room
- The amount of body heat introduced by personnel
- The amount of heat introduced or dissipated through walls, ceilings, and floors

As these factors change, you may need to deliberately introduce or dissipate heat and humidity by means of heating, cooling, and humidity-controlling equipment to maintain an acceptable environment. (See the *System Specifications* section for temperature and relative humidity requirements.)

The system is designed to operate at altitudes from sea level up to 2,134 metres (7,000 feet) above sea level. It is air cooled; fans bring cool air into the system, circulate the air, and exhaust the resulting heated air into the data processing room.

When air conditioning equipment is required because of extremes in temperature or humidity, it should be designed to maintain a temperature between 21° and 24° C (70° and 75° F) and relative humidity between 40% and 50%. This recommended range for temperature and humidity provides a reaction time should the temperature and humidity leave the recommended range and begin to approach the permitted extreme. The operator can use this reaction time to take corrective measures.

Humidity-Associated Problems

Avoid extremes in relative humidity. Humidity levels approaching the maximum limit can cause improper feeding and stacking of paper documents and continuous forms, operator discomfort, and condensation on windows and outside walls.

Humidity levels approaching the minimum limit aggravate problems associated with static electricity. Static charges, which are usually dissipated without any adverse effects, tend to build into significant charges when the humidity is low. This accumulation causes papers to cling together and can interfere with efficient paper feeding and paper stacking. High voltage static discharges from moving people, carts, furniture, paper, etc can be objectionable to operating personnel and, in extreme cases, can interfere with the correct operation of electronic equipment.

Diskette and Paper Document Storage

Keep paper storage areas at the same relative humidity as the data processing room; otherwise, extreme humidity differences between the two areas may alter the size of the paper documents when they are moved into the working area. This rapid change can result in warpage, the most frequent cause of feeding and stacking problems.

If working and storage areas cannot be kept at the same relative humidity, allow ample time for paper to achieve a moisture balance with the data processing room atmosphere before using the documents.

For detailed information about handling, storing, and shipping diskettes, refer to the IBM publication, *The IBM Diskette General Information Manual*, GA21-9182.

Magnetic Card Handling and Storage

For maximum card life and dependability:

- Handle the magnetic cards by the edges or colored areas only.
- Notations on the magnetic card should be made according to the manufacturer's instructions. Do not use a wax or grease pencil or a hard writing instrument such as a pencil or ballpoint pen.
- Clean the card by wiping with a cotton swab or facial tissue moistened with alcohol (70% denatured or isopropyl). Do not saturate the card with alcohol. Remove all lint and dirt completely when cleaning the card.
- Do not use paper clips or other sharp objects on the magnetic cards.
- Do not curl or twist the cards.
- Store the cards at 10° to 51° C (50° to 125° F), 8% to 80% relative humidity, and a maximum wet bulb temperature of 29° C (85° F).
- The cards can be stored in the containers that they come in or in a file box.
- Do not use the magnetic cards near magnetized objects. Data can be lost from a card that is exposed to a magnetic field.

FIRE PROTECTION

In the interest of safety and fire prevention, selection of site, fire control equipment, electrical system and personnel training become important considerations.

Portable carbon dioxide extinguishers should be provided for use on electrical fires while portable pressurized-water extinguishers may be used on ordinary combustible material (paper, etc) fires.

Fire protection around the outside of the data processing room (in adjoining rooms, the floor space above, and the floor space below), is almost as important to the safety of the system as fire protection within the room itself.

If local building codes or insurance regulations require sprinkler systems, consider using a preaction system that helps prevent accidental release of water.

ELECTRICAL REQUIREMENTS

The system will operate satisfactorily using the normal power supplied by most power companies. There are, however, many outside sources that can cause transient electrical noise signals or voltage level variations that can affect system operations.

Check the electric power environment for unusual loads that might induce excessive noise into the branch circuits for the system. Switching heavy inductive loads or operating certain types of equipment near the system can cause problems, even though the source is on a different branch circuit. If you suspect such a condition, make a thorough investigation to determine whether you must initiate corrective measures. In some cases, it may be advisable to provide a separate feeder for the system directly from the main building power. In extreme cases of severe electrical noise, it may be necessary to install an RF filter and/or an isolation transformer.

Excessive voltage level variations may require use of a constant voltage transformer. In either case, the filter and/or transformers must be capable of withstanding an inrush current (1/2 cycle) 11 times the rated system load while maintaining voltage within 25% of nominal.

Some common sources of electrical noise are:

- Air conditioning devices
- Electric welders
- Electric furnaces
- Elevators
- Electrostatic copying machines
- Large brush-type motors.

If you need help determining whether you must alter your facilities to correct or prevent electrical noise, consult your IBM installation planning representative.

Power Supply

The following statements apply to the power supply:

- The system and attachments use single-phase power.
- Voltage must be maintained within $\pm 10\%$ of the rated system voltage (measured at the receptacle) when the system is operating. A transient-voltage condition must not exceed $+15\%$ or -18% of nominal and must return to within a steady-state tolerance of $\pm 10\%$ of the normal rated voltage within 30 cycles.
- Voltages available in the U.S.A. are shown on the unit specification pages, along with typical plugs, connectors, and receptacles.

50 hertz machines are normally shipped without plugs.

World Trade voltages are:

50 hertz	100/110/123.5/200/220/235 volts
60 hertz	100/115/200/208/230 volts

- Line frequency must be maintained within $\pm 1/2$ hertz (cycles per second).
- The maximum harmonic content of the power system voltage wave forms on the equipment feeder must not exceed $\pm 5\%$ when the equipment is not operating.

Power Distribution

The system requires no special power distribution; it can operate on the feeder that supplies other loads if there are no unusual loads, as discussed in the preceding text. Of course, all wiring should comply with local electrical codes.

Branch circuits should be protected by circuit breakers suitable for motor load application and should contain wiring that will handle the same load. The circuit breakers should be placed in an unobstructed and well-lighted area in the data processing room.

As a safety precaution, there should also be provisions for simultaneously disconnecting power to all data processing equipment in the room. The disconnecting means should be controlled from locations readily accessible to the operator and at designated exits from the data processing room.

Grounding

Power cords have a green-with-yellow-trace grounding conductor for equipment ground. The recommended branch-circuit receptacles have mating equipment ground. The customer-supplied branch circuits must have an insulated wire conductor, equal to the size of the phase conductor, for the purpose of grounding equipment. The branch circuit grounding wire must be tied to a common ground point at the distribution panel, and a single grounding wire should run from the distribution panel to service ground or suitable building ground. *This is a dedicated ground, not a neutral.* Conduit must not be used as the only grounding means. All units of the system must be on the same grounding circuit.

Lightning Protection

Consider lightning protection on your secondary power source if any of the following conditions apply:







- The utility company installs lightning protectors on the primary power source.
- An overhead power service supplies power to the building.
- The area is subject to electrical storms or equivalent power surges.

Convenience Outlets

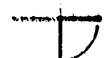
Provide a convenience outlet for use of the customer engineer at a maximum of 1.8 metres (6 feet) from the system. For 60 hertz installation, provide a 115 volt outlet; for 50 hertz installation, consult your customer engineer to determine what power must be provided by the convenience outlet. Provide additional outlets for use of maintenance personnel as needed. The general rules for the electric power environment apply to the wiring of the convenience outlets.

STANDARD SYMBOLS AND SPECIFICATIONS

Standard symbols used on the specifications page and physical planning template are:

-  Power cord exit (power cords are measured from power cord exit)
-  Cover swings
-  Service area boundary
-  Casters
-  Cable entry and exit in base of unit
-  CE service panel
-  Optional equipment outline
-  Glide

The following notes apply to the specification pages:

1. Plan view dimensions are shown in inches. A chart at the back of the manual can be used for inch-centimetre conversion.
2. Power cord style shown applies to 50 hertz machines. IBM ships these cords without plugs. Cord specifications are shown in Figure 1.
3. Plug and receptacle specifications are shown in Figure 2.

Plug Type	Volts	Amps	Lock/Nonlock	Plug Cap*	Connector/Receptacle
H	115	15	Nonlock	5-15P	5-15R
J	115	15	Lock	L5-15P	L5-15R
K	208/ 230	15	Nonlock	6-15P	6-15P
L	208/ 230	15	Lock	L6-15P	L6-15R

*The type numbers shown are National Electrical Manufacturer's Association (NEMA) configuration numbers.

● Figure 2. Plug and Receptacle Specifications.

Style	A	B	C	D	E
Cable nominal OD	13 mm (0.51")	10 mm (0.39")	14 mm (0.53")	11 mm (0.42")	13 mm (0.51")
Number of shields	1	0	0	1	1
Conductors:					
Quantity	3	3	3	3	3
Nominal OD	2.0 mm (0.081")	1.3 mm (0.051")	1.6 mm (0.064")	1.3 mm (0.051")	1.6 mm (0.064")
AWG number	12	16	14	16	14

Figure 1. Cord Specifications

5320 SYSTEM UNIT

Plan View

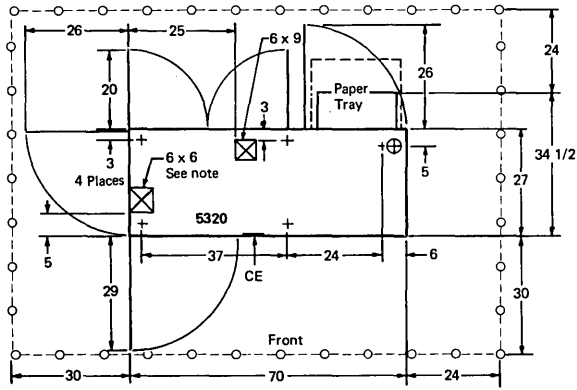

Note: 1255 Cable Entrance

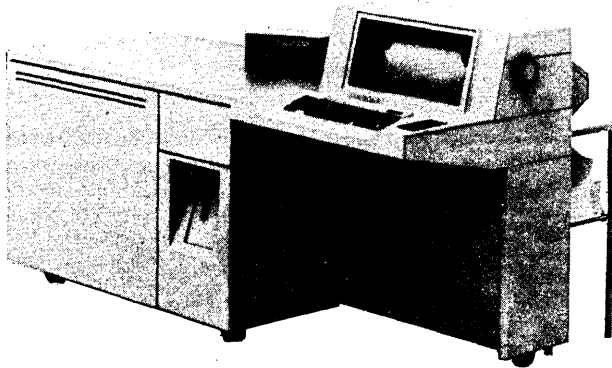

Specifications

Dimensions:

	Width	Depth	Height
Centimetres	178	88	97
Inches	70	34-1/2	38

Service Clearances:

	Front	Rear	Right	Left
Centimetres	76	61	61	76
Inches	30	24	24	30

Weight:

290 kg (640 lb)

Heat Output:

600 watts (2,000 Btu/hr)—Model A
 750 watts (2,500 Btu/hr)—Model B
 825 watts (2,750 Btu/hr)—Model C

Airflow:

150 L/s (300 ft³/min)

Power Requirements:

kVA	0.8—Model A 1.0—Model B 1.1—Model C
Phases	1
Plug type*	L
Power cord style**	C

Operating Environment:

Temperature	16° to 38° C (60° to 100° F)
Relative humidity	8% to 80%
Maximum wet bulb	23° C (73° F)

Nonoperating Environment:

Temperature	10° to 43° C (50° to 110° F)
Relative humidity	8% to 80%
Maximum wet bulb	27° C (80° F)

Note: If unit must be upended, follow the instructions that are shipped with the unit. No special equipment is required.

*See Page 5 for cord, plug, and receptacle information.

**Power cord is 2.4m (8 ft) long.

5321 MAG CARD UNIT (MCU)

Plan View

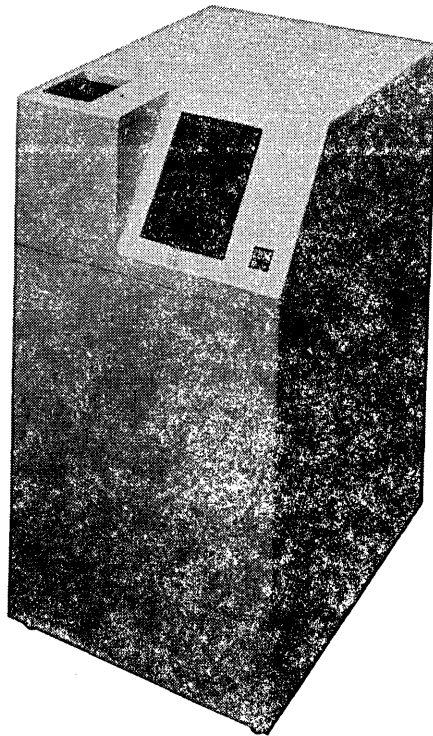
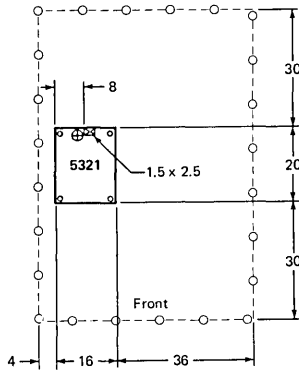

Specifications

Dimensions:

	Width	Depth	Height
Centimetres	41	51	74
Inches	16	20	29

Service Clearances:

	Front	Rear	Right	Left	Top
Centimetres	76	76	76	10	91
Inches	30	30	30	4	36

Weight: 50 kg (110 lb)

Heat Output: 180 watts (615 Btu/hr)

Airflow: 50 L/s (100 ft³/min)

Power Requirements:

kVA	0.2
Phases	1

Plug type*	H
Power cord style**	D

Operating Environment:

Temperature	16° to 38° C (60° to 100° F)
Relative humidity	8% to 80%
Maximum wet bulb	23° C (73° F)

Nonoperating Environment:

Temperature	10° to 43° C (50° to 110° F)
Relative humidity	8% to 80%
Maximum wet bulb	27° C (80° F)

*See Page 5 for cord, plug, and receptacle information.

**The power cord is 4.3m (14 feet) long.

Note: IBM recommends that the 5321 be located at the right end of the System/32.

1255 MAGNETIC CHARACTER READER MODELS 1 AND 2

Plan View

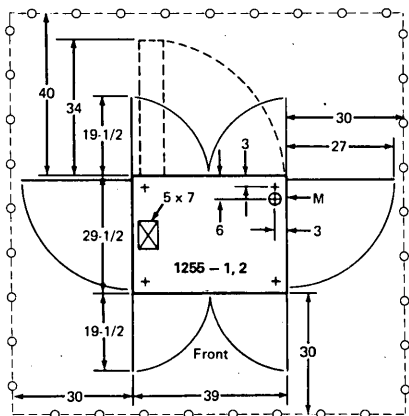

Specifications

Dimensions:

	Width	Depth	Height
Centimetres	99	75	140
Inches	39	29-1/2	55

Service Clearances:

	Front	Rear	Right	Left
Centimetres	76	102	76	76
Inches	30	40	30	30

Weight: 255 kg (560 lb)

Heat Output: 750 watts (2,600 Btu/hr)

Airflow: 150 L/s (300 ft³/min)

Power Requirements:

kVA	1.0
Phases	1
Plug type*	K or L
Power cord style**	E

Operating Environment:

Temperature	60° to 90° F (16° to 32° C)
Relative humidity	20% to 80%
Maximum wet bulb	78° F (26° C)

Nonoperating Environment:

Temperature	50° to 110° F (10° to 43° C)
Relative humidity	8% to 80%
Maximum wet bulb	80° F (27° C)

*See Page 5 for cord, plug, and receptacle information.

**Power cord is 2.4m (8 ft) long.

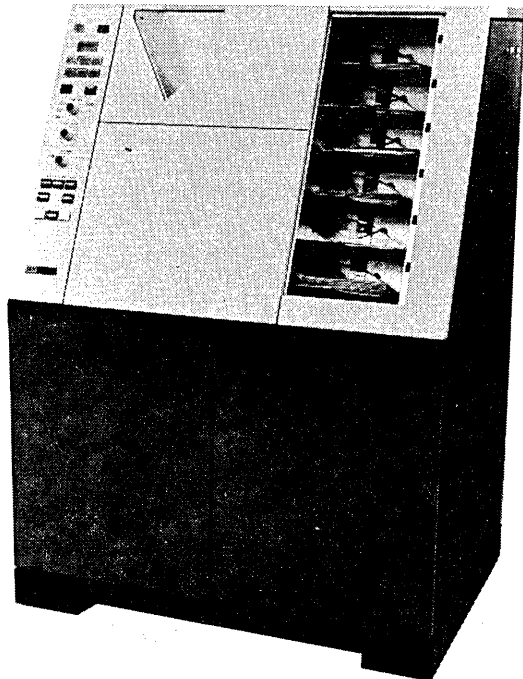

1255 MAGNETIC CHARACTER READER MODEL 3

Plan View

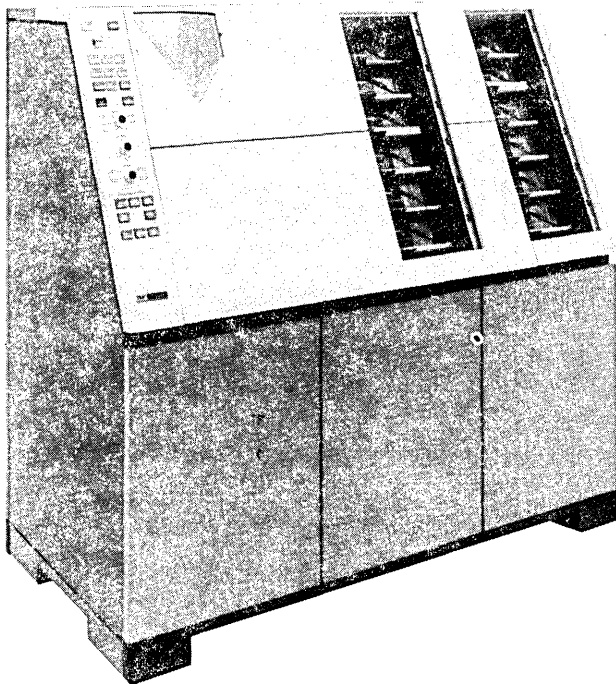
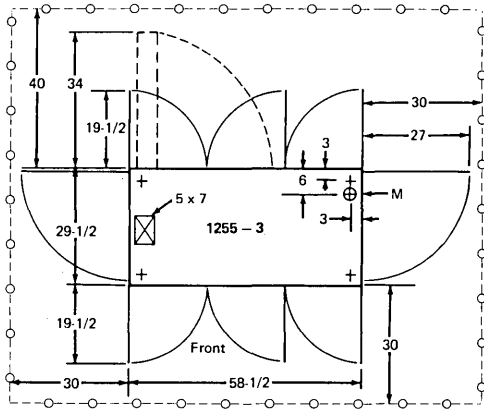

Specifications

Dimensions:

	Width	Depth	Height
Centimetres	149	75	140
Inches	58-1/2	29-1/2	55

Service Clearances:

	Front	Rear	Right	Left
Centimetres	76	102	76	76
Inches	30	40	30	30

Weight: 320 kg (700 lb)

Heat Output: 750 watts (2,600 Btu/hr)

Airflow: 150 L/s (300 ft³/min)

Power Requirements:

kVA	1.0
Phases	1

Plug type* K or L

Power cord style** E

Operating Environment:

Temperature	60° to 90° F (16° to 32° C)
Relative humidity	20% to 80%
Maximum wet bulb	78° F (26° C)

Nonoperating Environment:

Temperature	50° to 110° F (10° to 43° C)
Relative humidity	8% to 80%
Maximum wet bulb	80° F (27° C)

*See Page 5 for cord, plug, and receptacle information.

**Power cord is 2.4m (8 ft) long.

129 CARD DATA RECORDER

Plan View

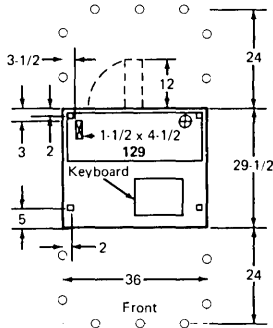

Specifications

Dimensions:

	Width	Depth	Height
Centimetres	91	75	97
Inches	36	29-1/2	38

Service Clearances:

	Front	Rear	Right	Left
Centimetres	61	61	0	0
Inches	24	24	0	0

Weight: 120 kg (255 lb)

Heat Output: 250 watts (850 Btu/hr)

Power Requirements:

kVA	0.4
Phases	1

Plug type* H, J, K, or L
Power cord style** A

Operating Environment:

Temperature	10° to 43° C (50° to 110° F)
Relative humidity	10% to 80%
Maximum wet bulb	29° C (85° F)

Nonoperating Environment:

Temperature	10° to 51° C (50° to 125° F)
Relative humidity	8% to 80%
Maximum wet bulb	29° C (85° F)

*See Page 5 for cord, plug, and receptacle information.

**Power cord is 2.4m (8 feet) long.



5496 DATA RECORDER MODELS 1 AND 2

Plan View

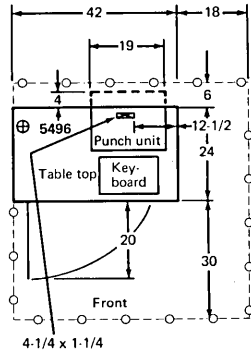

Specifications

Dimensions:

	Width	Depth	Height
Centimetres	107	61	99
Inches	42	24	39

Service Clearances:

	Front	Rear	Right*	Left
Centimetres	76	15	46	0
Inches	30	6	18	0

Weight: 115 kg (250 lb)

Heat Output: 250 watts (850 Btu/hr) @ 60 Hz
360 watts (1225 Btu/hr) @ 50 Hz

Power Requirements:

kVA	0.4 @ 60 Hz
	0.6 @ 50 Hz
Phases	1

Plug type** H
Power cord style*** B

Operating Environment:

Temperature	10° to 43° C (50° to 110° F)
Relative humidity	8% to 80%
Maximum wet bulb	29° C (85° F)

Nonoperating Environment:

Temperature	10° to 51° C (50° to 125° F)
Relative humidity	8% to 80%
Maximum wet bulb	29° C (85° F)

*Clearance required above table top only.

**See Page 5 for cord, plug, and receptacle information.

***Power cord is 2.1m (7 feet) long.

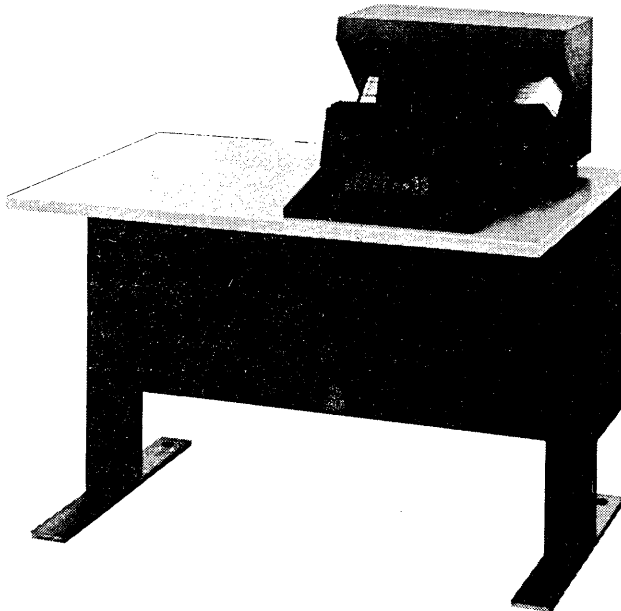

Cabling Information

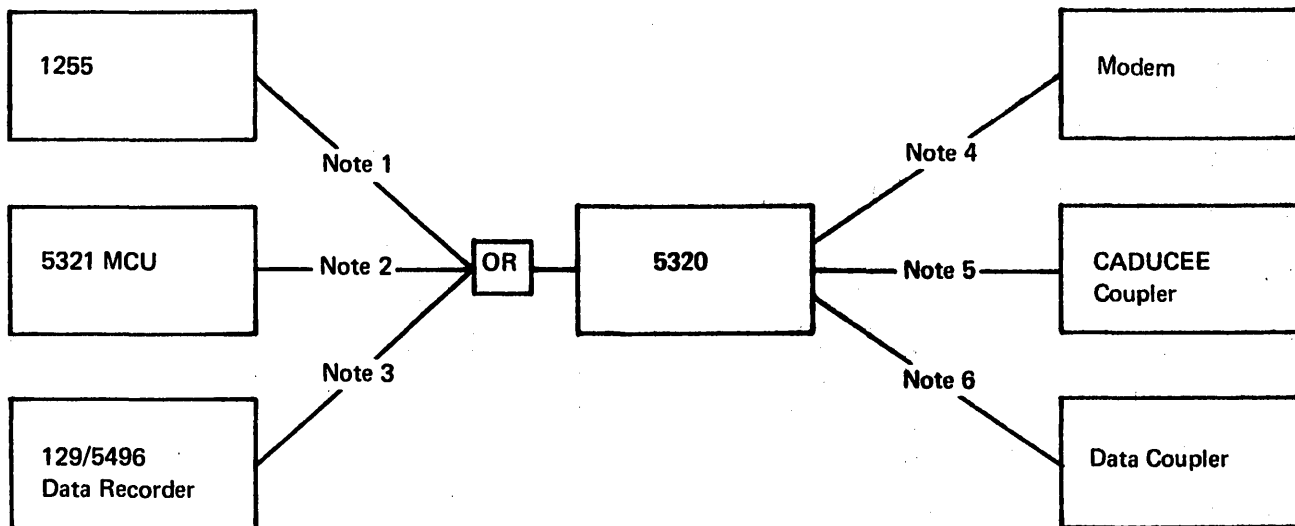

Notes:

1. Order cable group 3255, maximum length of 12.2 metres (40 ft).
2. A 4.6 metre (15 ft) cable is supplied with the 5321 mag card unit attachment feature (SF4900).
3. A 3 metre (10 ft) cable is supplied with the data recorder attachment feature (SF3200).
4. A 6.1 metre (20 ft) cable (SF9460) or a 12.2 metre (40 ft) cable (SF9461), to be specified, is supplied with the EIA/CCITT feature (SF3701). An adapter cable must be ordered for use in: U.K., 0.2 metre (8 inch) (SF2835), Germany, 0.2 metre (8 inch) (SF2898), Japan, 0.3 metre (12 inch) (SF2946).
5. A 6.1 metre (20 ft) cable (SF9460) or a 12.2 metre (40 ft) cable (SF9461), to be specified, is supplied with the CADUCEE feature (SF2881). The cable attaches to the communications facility with an EIA RS-232C connector.
6. A 6.1 metre (20 ft) cable (SF9460) or a 12.2 metre (40 ft) cable (SF9461), to be specified, is supplied with an integrated modem. An adapter (SF2943) must be ordered for use in Japan with nonswitched integrated modems. A second cable will be provided if backup feature (SF7951 or SF7952) is ordered.

Terminations at the data coupler end of the coupler are one of the following:

- a. WE-283B plugs used with 1200 bps integrated modem nonswitched (SF5500), 2400 bps integrated modem nonswitched point-to-point (SF5600), 2400 bps integrated modem nonswitched multipoint tributary (SF5602), and backup feature (SF7951).

For 50 hertz systems used in countries requiring spade terminations for the cable, remove the plug and use the spade terminals provided. SF5501 in IBM WTC countries (except Canada) comes with spade terminals. See Figure 2(a).

- b. Noninsulated spade terminals are used with 1200 bps integrated modems switched with auto-answer feature (SF5501), 2400 bps integrated modem switched with auto-answer feature (SF5610) and backup feature (SF7952). See Figure 2(b).

A

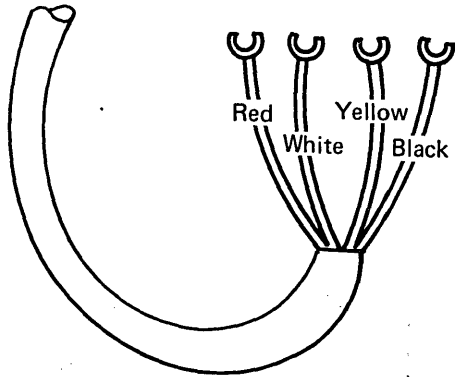

B

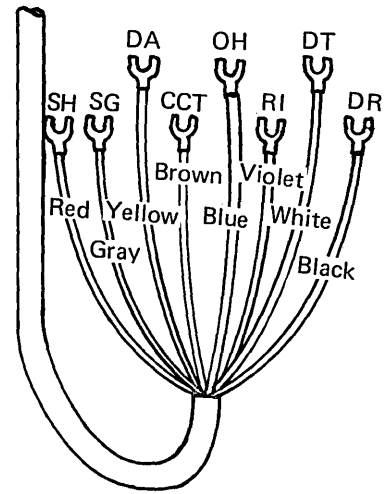

● Figure 2. Terminal Designations

Inch To Centimetre Conversion Chart

	0	1/4	1/2	3/4		0	1/4	1/2	3/4
Inches ↓	Centimetres				Inches ↓	Centimetres			
0	0	0.6	1.3	1.9	50	127.0	127.6	128.3	128.9
1	2.5	3.2	3.8	4.4	51	129.5	130.2	130.8	131.4
2	5.1	5.7	6.4	7.0	52	132.1	132.7	133.3	134.0
3	7.6	8.3	8.9	9.5	53	134.6	135.3	135.9	136.5
4	10.2	10.8	11.4	12.1	54	137.2	137.8	138.4	139.1
5	12.8	13.3	14.0	14.6	55	139.7	140.3	141.0	141.6
6	15.2	15.9	16.5	17.1	56	142.2	142.9	143.5	144.1
7	17.8	18.4	19.1	19.6	57	144.8	145.4	146.0	146.7
8	20.3	21.0	21.6	22.2	58	147.3	148.0	148.6	149.2
9	22.9	23.5	24.1	24.8	59	149.9	150.5	151.1	151.8
10	25.4	26.0	26.7	27.3	60	152.4	153.0	153.7	154.3
11	27.9	28.6	29.2	29.8	61	154.9	155.6	156.2	156.8
12	30.5	31.1	31.7	32.4	62	157.5	158.1	158.8	159.4
13	33.0	33.7	34.3	34.9	63	160.0	160.7	161.3	161.9
14	35.6	36.2	36.8	37.5	64	162.6	163.2	163.8	164.5
15	38.1	38.7	39.4	40.0	65	165.1	165.7	166.4	167.0
16	40.6	41.3	41.9	42.5	66	167.6	168.3	168.9	169.5
17	43.2	43.8	44.4	45.1	67	170.2	170.8	171.4	172.1
18	45.7	46.4	47.0	47.6	68	172.7	173.4	174.0	174.6
19	48.3	48.9	49.5	50.2	69	175.3	175.9	176.5	177.2
20	50.8	51.4	52.1	52.7	70	177.8	178.4	179.1	179.7
21	53.3	54.0	54.6	55.2	71	180.3	181.0	181.6	182.2
22	55.9	56.5	57.1	57.8	72	182.9	183.5	184.1	184.8
23	58.4	59.1	59.7	60.3	73	185.4	186.1	186.7	187.3
24	61.0	61.6	62.2	62.9	74	188.0	188.6	189.2	189.9
25	63.5	64.1	64.8	65.4	75	190.5	191.1	191.8	192.4
26	66.0	66.7	67.3	67.9	76	193.0	193.7	194.3	194.9
27	68.6	69.2	69.9	70.5	77	195.6	196.2	196.8	197.5
28	71.1	71.8	72.4	73.0	78	198.1	198.8	199.4	200.0
29	73.7	74.3	74.9	75.6	79	200.7	201.3	201.9	202.6
30	76.2	76.8	77.5	78.1	80	203.2	203.8	204.5	205.1
31	78.7	79.4	80.0	80.6	81	205.7	206.4	207.0	207.6
32	81.3	81.9	82.6	83.2	82	208.3	208.9	209.6	210.2
33	83.8	84.5	85.1	85.7	83	210.8	211.5	212.1	212.7
34	86.4	87.0	87.6	88.3	84	213.4	214.0	214.6	214.3
35	88.9	89.5	90.2	90.8	85	215.9	216.5	217.2	217.8
36	91.4	92.1	92.7	93.3	86	218.4	219.1	219.7	220.3
37	94.0	94.6	95.2	95.9	87	221.0	221.6	222.2	222.9
38	96.5	97.1	97.8	98.4	88	223.5	224.2	224.8	225.4
39	99.1	99.7	100.3	101.0	89	226.1	226.7	227.3	228.0
40	101.6	102.2	102.9	103.5	90	228.6	229.2	229.9	230.5
41	104.1	104.8	105.4	106.0	91	231.1	231.8	232.4	233.0
42	106.7	107.3	108.0	108.6	92	233.7	234.3	235.0	235.6
43	109.2	109.9	110.5	111.1	93	236.2	236.9	237.5	238.1
44	111.8	112.4	113.0	113.7	94	238.8	239.4	240.0	240.7
45	114.3	114.9	115.6	116.2	95	241.3	241.9	242.6	243.2
46	116.8	117.5	118.1	118.7	96	243.8	244.5	255.1	255.7
47	119.4	120.0	120.6	121.3	97	246.4	247.0	247.7	248.3
48	121.9	122.6	123.2	123.8	98	248.9	249.6	250.2	250.8
49	124.5	125.1	125.7	126.4	99	251.5	252.1	252.7	253.4
					100	254.0			

READER'S COMMENT FORM

Please use this form only to identify publication errors or request changes to publications. Technical questions about IBM systems, changes in IBM programming support, requests for additional publications, etc, should be directed to your IBM representative or to the IBM branch office nearest your location.

Error in publication (typographical, illustration, and so on). **No reply.**

Page Number *Error*

Inaccurate or misleading information in this publication. Please tell us about it by using this postage-paid form. We will correct or clarify the publication, or tell you why a change is not being made, provided you include your name and address.

Page Number *Comment*

Note: All comments and suggestions become the property of IBM.

Check if reply is requested.

Name _____

Address _____

● No postage necessary if mailed in the U.S.A.

Cut Along Line

Fold

Fold

FIRST CLASS
PERMIT NO. 387
ROCHESTER, MINN.

BUSINESS REPLY MAIL

NO POSTAGE STAMP NECESSARY IF MAILED IN THE UNITED STATES

POSTAGE WILL BE PAID BY . . .

IBM Corporation
General Systems Division
Development Laboratory
Publications, Dept. 245
Rochester, Minnesota 55901

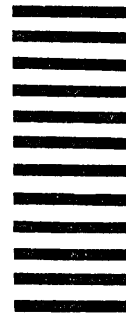

Fold

Fold

S/32 Installation Manual Physical Planning (File No. S32-15) Printed in U.S.A. GA21-9177-5



International Business Machines Corporation
General Systems Division
5775D Glenridge Drive N.E.
Atlanta, Georgia 30301
(USA Only)

General Business Group/International
44 South Broadway
White Plains, New York 10601
U.S.A.
(International)



International Business Machines Corporation
General Systems Division
5775D Glenridge Drive N.E.
Atlanta, Georgia 30301
(USA Only)

General Business Group/International
44 South Broadway
White Plains, New York 10601
U.S.A.
(International)