

GA34-0035-5

File No. S1-00

**IBM Series/1
System Summary**

Sixth Edition (September 1979)

This is a major revision of, and obsoletes, GA34-0035-4. The information in this manual has been reorganized to increase its usability. Because the changes are extensive, this manual should be reviewed in its entirety and does not include revision bars. Significant changes in this edition include:

- The addition of:
 - IBM 3101 Display Station Current Loop Cable
- The deletion of:
 - IBM Series/1 licensed programs and related information.

Use this publication only for the purpose stated in the Preface.

Changes are periodically made to the information herein; any such changes will be reported in subsequent revisions or Technical Newsletters.

It is possible that this material may contain reference to, or information about, IBM products (machines and programs), programming, or services which are not announced in your country. Such references or information must not be construed to mean that IBM intends to announce such IBM products, programming, or services in your country.

Publications are not stocked at the address given below. Requests for copies of IBM publications should be made to your IBM representative or the IBM branch office serving your locality.

This publication could contain technical inaccuracies or typographical errors. A form for readers' comments is provided at the back of this publication. If the form has been removed, address your comments to IBM Corporation, Systems Publications, Department 27T, P.O. Box 1328, Boca Raton, Florida 33432. IBM may use and distribute any of the information you supply in any way it believes appropriate without incurring any obligation whatever. You may, of course, continue to use the information you supply.

Preface

This publication is an introduction to, and reference information source for, the IBM Series/1. It describes Series/1 hardware capabilities, various components, and models.

Its intended primary audience is the data processing customer executive and his technical staff who are responsible for evaluating the applicability of Series/1 to their data processing needs. Engineers, programmers, and operators also will find this publication useful for general information about the Series/1. The reader should be familiar with data processing concepts and event-driven systems.

The subject matter is presented in eight chapters and two appendixes:

- Chapter 1, "Introduction," is an overview of the Series/1. It introduces the reader to the system's design and components, and briefly discusses data security. The topics introduced here are expanded in subsequent chapters.
- Chapter 2, "Processors and I/O Expansion Unit," describes the characteristics and optional features of each Series/1 processor and of the input/output (I/O) expansion unit.
- Chapter 3, "Disk, Diskette, and Magnetic Tape Units," describes the storage devices that can be attached to Series/1.
- Chapter 4, "Printers and Display Unit," describes the printers and display station used by the Series/1.
- Chapter 5, "Sensor I/O Units," describes a unit that attaches process I/O applications to the Series/1.

- Chapter 6, "User Attachment Features," describes optional hardware that permits the user to attach his own I/O devices to Series/1 processors.
- Chapter 7, "Communication Units and Features," describes the various optional hardware features that allow telecommunication with other systems and devices.
- Chapter 8, "Additional Units and Features," describes the various enclosures, the battery backup unit, and the 5250 attachment.
- Appendix A, "Series/1 Hardware," lists all the machine types and feature numbers for Series/1 hardware.
- Appendix B, "IBM 4978 Display Station RPQ," describes a special display and the keyboards available for attachment to Series/1.

Conventions

In this manual, the following conventions are used:

- Signal line names are enclosed in single quotation marks; for example, 'external sync.'
- IBM products are referred to by their full names in Chapter 1, "Introduction," and, thereafter, by shortened names. See also Appendix A, "Series/1 Hardware," for names and feature numbers of Series/1 products.

Related Publications

This publication refers to other publications that describe particular IBM Series/1 products in detail. The *IBM Series/1 Graphic Bibliography*, GA34-0055, describes most of the technical publications about Series/1 machines and programs that are needed by those who plan for, install, program, operate, and maintain the IBM Series/1. The bibliography provides a quick reference to the title, order number, intended audience, and content of each publication.

Other publications that might be helpful are:

- *Data Security and Privacy Study*, G320-1370 through G320-1376
- *The Consideration of Data Security in a Computer Environment*, G520-2169
- *IBM 3101 Display Terminal, Description*, GA18-2033
- *IBM 3101 Display Terminal, Setup Instructions*, GA18-2034
- *IBM 3101 Display Terminal, Operator's Guide*, GA18-2035
- *IBM 3101 Display Terminal, CPAR Guide*, GA18-2036
- *IBM 3101 Display Terminal, Introduction*, GA18-2051
- *IBM 5250 Information Display System, Introduction*, GA21-9246
- *IBM Series/1 Two Channel Switch Feature Description*, GA34-0056
- *IBM Series/1 Programming System Summary*, GC34-0285

To obtain copies of these publications, contact your IBM representative.

Contents

Chapter 1. Introduction	1-1
Series/1 Design	1-1
Series/1 Components	1-5
Processors and I/O Expansion Unit	1-5
Disk, Diskette, and Magnetic Tape Units	1-6
Printers and Display Unit	1-8
Sensor I/O Unit	1-9
User Attachment Features	1-10
Communication Units and Features	1-12
Additional Units and Features	1-14
Programming Support	1-15
Data Security and Integrity	1-16
Chapter 2. Processors and I/O Expansion Unit	2-1
Processor Overview	2-2
Common Characteristics	2-3
Basic Features	2-3
Optional Features	2-8
4952 Processor	2-9
Models	2-9
Basic Features	2-10
Optional Features	2-12
4953 Processor	2-13
Models	2-13
Basic Features	2-14
Optional Features	2-14
4955 Processor	2-17
Models	2-17
Basic Features	2-18
Optional Features	2-22
4959 Input/Output Expansion Unit	2-23
Two Channel Switch (TCS) Feature	2-25
Chapter 3. Disk, Diskette, and Magnetic Tape Units	3-1
4962 Disk Storage Unit	3-3
Models	3-3
Disk	3-4
Diskette	3-4
Specifications	3-5
4963 Disk Subsystem	3-7
Models	3-9
4963 Disk Storage Unit	3-9
Specifications	3-10
4964 Diskette Unit	3-11
Specifications	3-13
4966 Diskette Magazine Unit	3-15
4969 Magnetic Tape Subsystem	3-17
Magnetic Tape Unit	3-17
Specifications	3-20
Chapter 4. Printers and Display Unit	4-1
4973 Line Printer	4-3
Specifications	4-4
International Considerations	4-5
4974 Printer	4-7
Specifications	4-8
International Considerations	4-8
4979 Display Station	4-9
Specifications	4-9
Display Screen	4-10
Console Keyboard	4-11
International Considerations	4-12
Chapter 5. Sensor I/O Unit	5-1
4982 Sensor Input/Output Unit	5-3
Card Sockets	5-6
Digital Input/Process Interrupt	5-7
Digital Output Nonisolated	5-7
Analog-Input Subsystem	5-8
Analog Output	5-10
Chapter 6. User Attachment Features	6-1
Timer	6-1
Teletypewriter Adapter	6-3
Serial I/O Devices	6-3
Data Transfer	6-4
Communication Power Feature	6-4
Customer Direct Program Control (DPC) Adapter	6-5
Integrated Digital Input/Output, Nonisolated	6-6
Registers	6-6
Diagnostic Programs	6-6
Customer Access Panel	6-7
Channel Repower	6-8
Channel Socket Adapter	6-9
Chapter 7. Communication Units and Features	7-1
Data Links	7-1
Integrated Communication Features	7-3
Synchronous Data Link Control (SDLC)	7-3
Binary Synchronous Communication (BSC)	7-4
Asynchronous Communication	7-6
Feature—Programmable Multi-Line Communication	7-7
Support Features	7-8
Communications Indicator Panel	7-8
Communications Power Feature	7-8
4987 Programmable Communications Subsystem	7-9
Subsystem Unit	7-11
Programmable Communications Subsystem Controller	7-12
Device Attachment Features	7-13
Indicator Panel	7-17
4990 Communications Console for the 4987	7-18
Chapter 8. Additional Units and Features	8-1
4993 Series/1—System/370 Termination Enclosure	8-3
4997 Rack Enclosure	8-5
4999 Battery Backup Unit	8-8
Operator Panel	8-9
5250 Information Display System Attachment Feature	8-10
Appendix A. Series/1 Hardware	A-1
Appendix B. IBM 4978 Display Station RPQ	B-1
4978 Display Station RPQ	B-1
Index	X-1

Chapter 1. Introduction

This chapter is an overview of the IBM Series/1. The major topics introduced are:

- Series/1 design
- Series/1 components
- Programming support
- Data security and integrity

Each topic is expanded in later chapters and/or the publications that are referred to in the Preface.

Series/1 Design

Series/1 is a family of small general-purpose computers with a variety of data processing input/output (I/O) devices and I/O attachments:

- Sensor I/O equipment
- Communication lines
- Custom designed devices

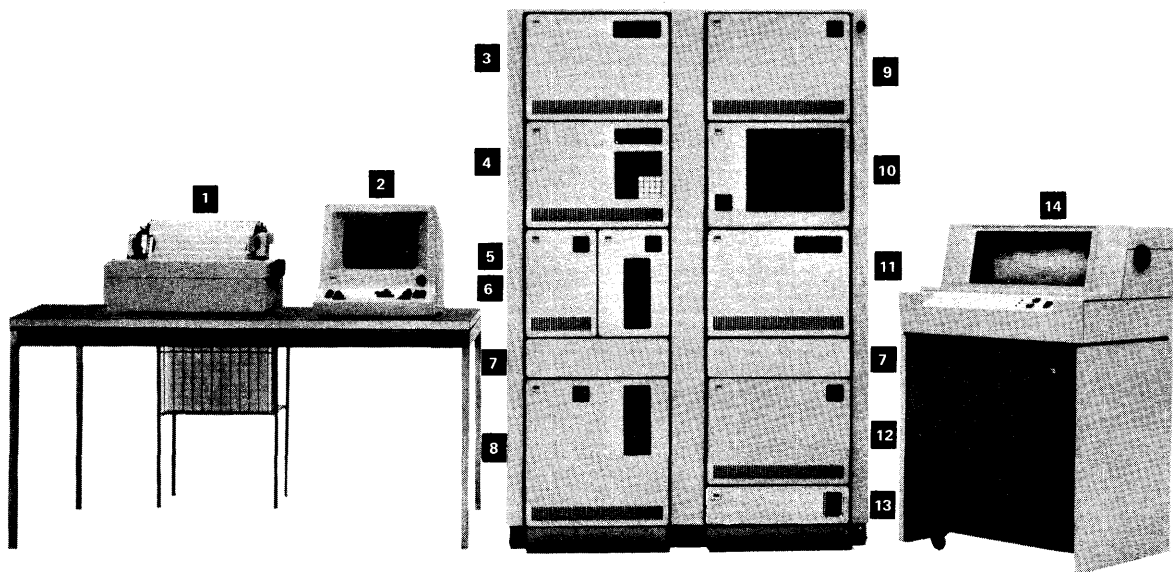

- | | | |
|--|---------------------------------|---|
| 1 4974 Printer | 6 4964 Diskette Unit (on right) | 11 4987 Programmable Communications Subsystem |
| 2 4979 Display Station | 7 Filler Panel | 12 4963 Disk Storage Unit |
| 3 4959 I/O Expansion Unit with Two Channel Switch* | 8 4962 Disk Storage Unit | 13 4993 Series/1–System/370 Termination Enclosure |
| 4 4952, 4953, or 4955 Processor | 9 4959 I/O Expansion Unit | 14 4973 Line Printer |
| 5 4982 Sensor I/O Unit (on left) | 10 4966 Diskette Magazine Unit | |

*A second processor (not shown) is required to operate the Two Channel Switch.

Figure 1-1. Typical IBM Series/1 configuration with selected units in IBM 4997 Rack Enclosures

Series/1 Design (continued)

High reliability is built into the Series/1 by using large scale integration (LSI) technology in the processor and metal-oxide semiconductor, field-effect transistor (MOSFET) logic in main storage.

Series/1 is suitable for various applications:

- Conventional data processing
- Energy management
- Controlled-access security systems
- Other sensor-based applications

Series/1 meets the needs of customers who require either a single computer or multiple small computing systems. To allow flexibility, most Series/1 units are designed for rack mounting. The EIA* (RS-310B) 483-millimeter (19-inch) rack is the standard used for all Series/1 rack-mounting units. Figure 1-1 pictures selected Series/1 units.

Individual I/O attachment features, processor features, and storage additions are constructed on multilayer printed-circuit cards (storage additions on the 4952 Processor are pluggable modules). By selecting the desired modular units and combinations of circuit cards, a Series/1 can be customized to meet the needs of the user.

IBM machine-type numbers are assigned to the modular units, enclosures, and data processing I/O devices. I/O attachment cards and other components are available to expand the capability of the various machine types. Figure 1-2 shows how these units and features are grouped.

The processor unit contains:

- Basic processor card(s)
- Basic storage
- Basic console
- A power supply
- Card sockets for accommodating:
 - Processor features
 - Storage additions
 - I/O attachment feature

When additional I/O capacity is needed, I/O expansion units are available; these units contain a power supply and card sockets for plugging in additional I/O feature cards. In some cases, a channel repower feature is required when attaching an I/O expansion unit.

* Electronic Industries Association

A battery backup unit is available to switch certain processor models to a user-supplied battery to preserve the contents of processor storage only during primary power interruptions. I/O devices and other units are not powered from the battery backup unit. For additional information on this unit and the limitations of its use, refer to Chapter 8.

IBM rack enclosures include a primary-power receptacle panel for powering the individual modular units that can be installed. When a system requires space for modular units beyond the capacity of a single rack, multiple racks can be bolted together to form a multibay enclosure.

I/O attachment feature cards plug into the processor I/O channel sockets. The processor I/O channel directs the flow of information between I/O devices and main storage. I/O attachment feature cards can be:

- I/O attachment features
- Sensor I/O unit attachment features
- User attachment features
- Communication features
- Programmable Communications Subsystem attachment feature

Sensor I/O feature cards and communication device feature cards are also available for plugging into the IBM 4982 Sensor Input/Output Unit and the IBM 4987 Programmable Communications Subsystem, respectively.

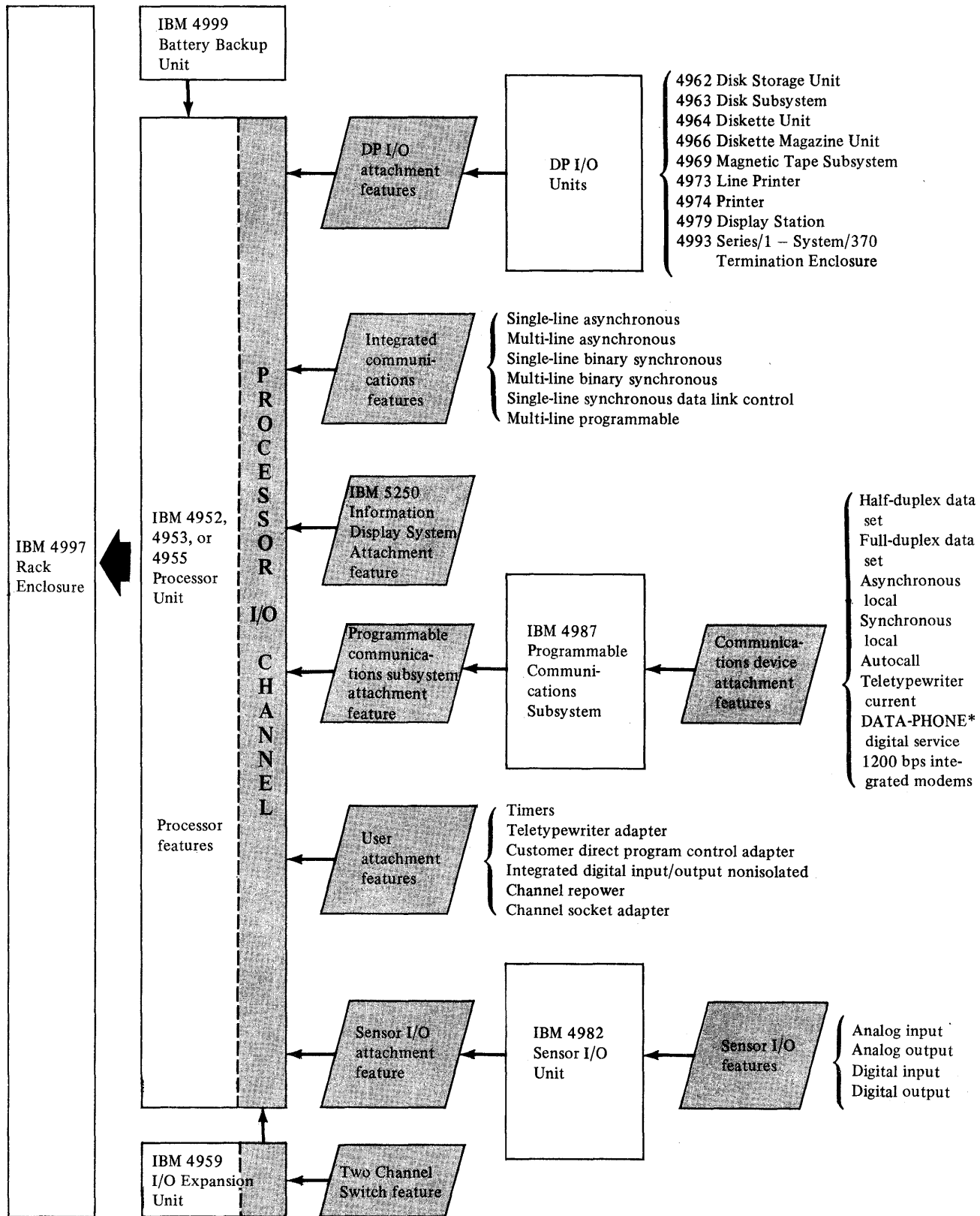

*Trademark of American Telephone and Telegraph Co.

Figure 1-2. Series/1 units and features

Series/1 Components

The following paragraphs describe the Series/1 machine types and each major feature. Additional information about these hardware components can be found in Chapters 2 through 8.

Processors and I/O Expansion Unit

The Series/1 family includes three processors and an I/O expansion unit:

- 4952 Processor
- 4953 Processor
- 4955 Processor
- 4959 Input/Output Expansion Unit

The processors are modular units designed for rack mounting in an IBM 4997 Rack Enclosure.

Each processor includes the circuit card(s) that:

- Control the interpretation and execution of instructions
- Are an integral part of the processor I/O channel linking the processor with its external resources

Each processor also contains a power supply and space for storage additions, processor features, and I/O attachment features. A basic console is standard with each processor; a programmer console is optional.

Each processor has an upward-compatible instruction set that includes a full complement of bit, byte, 16-bit word, and 32-bit doubleword operations. Each processor can operate on four interrupt levels, and an interrupt mechanism automatically switches levels on a preemptive priority basis. Additional characteristics of the processors are discussed in Chapter 2.

Disk, Diskette, and Magnetic Tape Units

Each of these units requires an I/O attachment feature card to be attached to the processor I/O channel. The attachment feature can be plugged into either the processor or an I/O expansion unit.

For additional information, refer to Chapter 3.

IBM 4962 Disk Storage Unit

This unit is a full-width module designed for rack mounting. It provides direct access storage for data records and programs, which are stored on a nonremovable magnetic disk. Movable heads are used to read and write data. Two models of the 4962 are equipped with eight fixed heads to read and write data on the disk.

The nonremovable disk and access mechanism are in a sealed enclosure, offering the following advantages:

- Preventive maintenance of the heads, disk, and spindle is eliminated.
- Reliability is improved by dedicated read/write heads; that is each head reads only the data it has previously written.
- Exposure to external contaminants is virtually eliminated.
- Disk handling is eliminated.

Additional models of the 4962 offer combinations of the disk unit just described and a diskette unit identical to the 4964 Diskette Unit described later in this chapter.

IBM 4963 Disk Subsystem

This subsystem is comprised of one to four full-width modular disk storage units (designed for rack mounting) and a single attachment feature. The subsystem provides high-speed direct access storage for data records and programs. Each disk unit provides storage on nonremovable rigid magnetic disks. Movable heads and, on some models, fixed heads read and write the data. Additional 4963 Disk Subsystems can be attached to the Series/1 for additional storage capacity.

IBM 4964 Diskette Unit

This unit is a half-width module that is mounted in a rack by using the half-rack adapter. Data is stored on removable diskettes. Two heads, one on each side of the diskette, are used to read and write data. By interchanging diskettes, the Series/1 operator can load new programs or transfer data between systems.

IBM 4966 Diskette Magazine Unit

This unit is a full-width module designed for rack mounting. Data is stored on removable diskettes. The 4966 automatically selects diskettes for direct access storage of data records and programs.

IBM 4969 Magnetic Tape Subsystem

This subsystem is comprised of up to four full-width modular tape units (designed for rack mounting) and a single attachment feature. The subsystem allows reel-to-reel magnetic tape to be used with the Series/1 in various recording formats and densities, and at various speeds. All tape units in a subsystem must be models of the same speed.

Printers and Display Unit

Each of these units requires an I/O attachment feature card to be attached to the processor I/O channel. The attachment feature can be plugged into either the processor or an I/O expansion unit.

For additional information, refer to Chapter 4.

IBM 4973 Line Printer

This printer is a free-standing unit and an impact-type line printer with 132 print positions. It provides a medium- to high-speed "hard copy" output for Series/1 on continuous form paper. The 4973 Printer is available in two print speeds with an interchangeable print belt. The printer has a programmable vertical forms control providing variable line spacing and pin-feed carriage to handle up to six-part forms.

IBM 4974 Printer

This printer is a tabletop unit. It is a serial printer with a wire-matrix print head that produces characters by printing a pattern of dots. This printer provides a medium-speed "hard copy" output for the Series/1 on either cut or continuous form paper. It prints in two directions and can handle up to six-part, margin-punched forms.

IBM 4979 Display Station

This display station is a tabletop unit that has a keyboard and cathode ray tube (CRT) display. The display station allows the user to:

- Enter, modify, or delete data on the CRT
- Transfer the displayed data to the processor

All information displayed on the screen is "refreshed" 50 or 60 times per second, creating an easy-to-read display under normal lighting conditions. Two levels of intensity allow special fields and characters, such as the cursor, to appear brighter than other characters.

The data-entry keyboard is similar to that of a typewriter, allowing input of alphanumeric characters, functions, and interrupt requests. Keys are color-coded by function.

Sensor I/O Unit

Remote sensor I/O units and features permit the Series/1 processor to:

- Receive realtime data (analog or digital from transducers, sensors, and other devices that monitor a physical process)
- Transmit signals to elements that control the physical process

For example, the processor might receive data from a gauge or flowmeter, compare the data with a predetermined standard, and then produce a signal that operates a relay, valve, or other control mechanism.

For additional information, refer to Chapter 5.

IBM 4982 Sensor Input/Output Unit

The 4982 Sensor I/O Unit is a half-width module that is mounted in a rack by using the half-rack adapter. The 4982 provides a subset of the processor I/O channel for controlling sensor I/O feature cards. The sensor I/O unit contains:

- A terminator card
- Sockets for eight sensor I/O feature cards
- A power supply

The 4982 attaches to the processor I/O channel by means of the 4982 Sensor Input/Output Unit Attachment Feature card. This card can be plugged into either the processor or an I/O expansion unit.

Sensor I/O Feature Cards

The following sensor I/O feature cards can be plugged into the 4982 Sensor Input/Output Unit:

Digital Features

- Digital Input/Process Interrupt, Nonisolated (16 points per card)
- Digital Input/Process Interrupt, Isolated (16 points per card)
- Digital Output, Nonisolated (16 points per card)

Analog Features

- Analog Input Control (with analog-to-digital converter)
- Amplifier Multirange
- Multiplexer/Reed-Relay (8 channels per card)
- Multiplexer/Solid-State (16 channels per card)
- Analog Output (2 points per card)

User Attachment Features

A variety of features allows the user to attach his own I/O devices and equipment to a Series/1 processor. Serial and parallel data paths are provided in addition to a multifunction timer. The user attachment features mount in the I/O feature sockets of the processor or an I/O expansion unit.

For additional information, refer to Chapter 6.

Timer

The timer feature card has two separately addressable 16-bit timers. There are four time-base options per timer: 1, 5, 25, and 50 microseconds. If desired, the user can supply his own time base and gating signals through a connector on the card.

Each timer can generate periodic or aperiodic interrupts with, or without, the external gate.

In addition to operating as an interval timer or pulse counter, each timer can operate as a self-contained pulse-duration counter with an end interrupt.

Teletypewriter Adapter

The teletypewriter adapter feature card provides a way of attaching the IBM 3101 Display Terminal or other serial I/O device. This feature provides a logical subset of the EIA RS232-C interface. Initial program load (IPL) is supported by the adapter.

Attachment to a teletypewriter is by a direct-current loop (isolated or nonisolated). Two other attachment options are offered:

- Transistor-transistor logic (TTL) compatible interface
- EIA voltage level interface

Customer Direct Program Control Adapter

This feature card supplies a logical subset of the I/O channel architecture and provides a convenient means of attaching I/O devices and subsystems to a Series/1 processor. The interface circuits are TTL compatible. The adapter is designed to perform direct program control (DPC) functions only; cycle steal operations cannot be performed.

Integrated Digital Input/Output, Nonisolated

The integrated digital I/O feature card contains:

- Two 16-point groups of nonisolated digital input/process interrupt (DI/PI)
- Two 16-point groups of nonisolated digital output (DO)

Each group of DI/PI and DO has a 'ready' line and a 'sync' line for synchronizing its operations with attached devices, as well as its own device address. The feature card is designed to perform DPC functions only; cycle steal operations cannot be performed.

Additional Features

Additional user attachment features described in Chapter 6 are:

- Customer Access Panel
- Channel Repower
- Channel Socket Adapter

Communication Units and Features

Communication units and features permit the Series/1 to:

- Receive and/or transmit over communication lines connected to local or remote stations
- Support individual communication applications by using individual features that connect directly to the processor I/O channel
- Support multiple communication applications using a programmable communications subsystem that connects to the processor I/O channel as a single unit

For additional information, refer to Chapter 7.

Integrated Communication Features

These communication feature cards plug into the I/O feature card sockets of the processor or an I/O expansion unit. The following features can be used on switched or nonswitched communication lines:

- Asynchronous Communications Single-Line Control
- Binary Synchronous Communications Single-Line Control
- Binary Synchronous Communications Single-Line Control/High Speed
- Synchronous Data Link Control Single-Line Control
- Asynchronous Communications 8-Line Control (controls for one or two 4-line adapters)
- Asynchronous Communications 4-Line Adapter
- Binary Synchronous Communications 8-Line Control (controls for one or two 4-line adapters)
- Binary Synchronous Communications 4-Line Adapter
- Feature—Programmable 8-Line Communications Control (controls for one or two 4-line adapters)
- Feature—Programmable 4-Line Communications Adapter

All data is transferred to and from the system in cycle-steal mode; that is, I/O operations are overlapped with processor operations. The above communication features (except Binary Synchronous Communications Single-Line Control/High Speed) allow manual dialing, and manual or automatic answering on switched lines.

Binary Synchronous Communications Single-Line Control features allow a remote station to IPL the processor. Asynchronous Communications Single-Line Control and Asynchronous Communications 4-Line Adapter can be locally attached; that is, no modem is required to communicate with other asynchronous terminals that use the asynchronous direct-connect communication cable feature.

The IBM 3101 Display Terminal may be attached to features that support asynchronous communication.

IBM 4987 Programmable Communications Subsystem

The 4987 Programmable Communications Subsystem is a full-width modular unit designed for rack mounting. It can control a number of communication attachment features and contains:

- Scanner(s)
- Sockets for device attachment cards
- An indicator panel with connections for the 4990 Communications Console
- A power supply

The device attachment features are designed to accommodate a variety of communication disciplines.

The 4987 attaches to the processor I/O channel by means of a two-card controller feature. These cards are plugged into either the processor unit or an I/O expansion unit, utilizing two contiguous I/O feature card sockets.

The IBM 3101 Display Terminal may be attached to features that support asynchronous communication.

IBM 4990 Communications Console for the 4987

This console, which is hand-held and connects to the 4987, enables the user to display or alter the following:

- Line interface information
- Controller storage
- Diagnostic data

Additional Units and Features

Additional Series/1 units and features are the various enclosures, battery backup unit, and 5250 attachment.

For more information, refer to Chapter 8.

IBM 4993 Series/1—System/370 Termination Enclosure

This unit is a full-width module designed for rack mounting. This unit provides communication between a Series/1 and either a System/370 (Models 135–168) or a 3031, 3032, or 3033 Processor. When used in conjunction with the Series/1—System/370 Channel Attachment Feature, the 4993 allows the Series/1 to function as a front-end processor to a System/370 in applications for:

- Graphics processing
- Teleprocessing
- Sensor I/O processing

Multiple Series/1 and System/370 processors can be configured using additional 4993 units; however, only one 4993 can be installed per 4997 Rack Enclosure and must be mounted at the bottom of the rack.

IBM Half-Width Unit Enclosure

This auxiliary feature is available for certain half-width modules and is suitable for placing on a table or shelf. When a configuration requires more than one independently enclosed module, the enclosures can be bolted together to form a multi-enclosure configuration.

IBM 4999 Battery Backup Unit

This unit is available to switch certain processor models to a user-supplied battery to preserve the contents of processor storage only during primary power interruptions. I/O devices and other units are not powered from the battery backup unit.

IBM 5250 Information Display System Attachment

This feature consists of two cards and allows one to seven of the following 5250 work stations to be attached to the Series/1:

- IBM 5251 Display Station, Models 1 and 11
- IBM 5252 Dual Display Station, Model 1
- IBM 5256 Printer, Models 1, 2, and 3

For more information on and the limitations of the use of this feature, refer to Chapter 5.

Programming Support

The programming support for IBM Series/1 consists of a variety of operating systems, several licensed programs, and a set of stand-alone utilities. These are discussed in the *IBM Series/1 Programming System Summary*, GC34-0285.

Data Security and Integrity

The user is responsible for protecting data and programs from unauthorized or accidental modification, destruction, or disclosure; however, the Series/1 has these built-in characteristics and optional features to help the user maintain adequate protection:

- Parity checking of main storage data and the I/O channel data bus
- Storage protection (4955 Processor and limited protected in 4952 Processor; for more information, refer to Chapter 2)
- Stand-alone utilities to dump data from disk to diskette for data file backup
- Station address and terminal identification in data communication environments
- Electronic lockout and data-protection features for display stations
- Block checking on all data transmitted and received on binary synchronous and synchronous data-line communication channels
- A battery backup unit to supply the power necessary to preserve the contents of processor storage during primary power interruptions

Additional information about ways to ensure data security can be found in:

- *The Consideration of Data Security in a Computer Environment*, G520-2169
- *Data Security and Data Privacy Study*, G320-1370 through G320-1376

Chapter 2. Processors and I/O Expansion Unit

This chapter describes the following Series/1 units:

- 4952 Processor
- 4953 Processor
- 4955 Processor
- 4959 Input/Output Expansion Unit

The above processors have the following general characteristics:

- Four priority interrupt levels
- 16K bytes, 32K bytes, or 64K bytes basic storage (model dependent)
- Transistor-transistor logic (TTL) and large-scale integration (LSI) technology
- An instruction set that includes:
 - Stacking and linking facilities
 - Multiply and divide
 - Variable-field-length byte operations
 - A variety of arithmetic, logical, and branching instructions
- Supervisor and problem states that are implemented using privileged instructions for the supervisor only
- Standard basic console
- Optional programmer console
- Modular units designed for rack mounting

Processor Overview

The following table compares the processors:

Characteristics	4952	4953	4955
Storage size	32K–128K bytes	16K–64K bytes	16K–256K bytes
Interrupt levels	4	4	4
Clock/comparator	All models	not applicable	not applicable
Storage cycle time	2000 ns (nominal) 2100 ns (worst case)	800 ns	660 ns
Instruction execution time (average—see Note 1)	9.4 μ	7.4 μ s	2.65 μ s
I/O channel			
Burst mode speed (average)	832,000 bytes per second	1,330,000 bytes per second	1,660,000 bytes per second
Capacity (device addresses)	256	256	256
I/O feature locations			
Model A	5	4 (see Note 2)	8
Model B	14	13 (see Note 2)	3
Model C	not applicable	4 (see Note 2)	10
Model D	not applicable	13 (see Note 2)	7
Model E	not applicable	not applicable	7
Packaging			
Full-width	Model B	Models B & D	All models
Half-width	Model A	Models A & C	not available
Basic console	All models	All models	All models
Programmer console	Optional	Optional	Optional
Floating point	not available	not available	Optional
Storage protection	not applicable (see Note 3)	not applicable	All models
Address translator	All models	not available	Models B, D, & E (see Note 4)

Notes:

1. Average instruction execution time is based on an instruction mix of the IBM Series/1 Realtime Programming System.
2. The number of card sockets available for I/O features, on any model of the 4953, is reduced by one for each storage increment installed after basic storage.
3. Limited storage protection is provided by the segmentation registers. For more information, refer to "4952 Processor" later in this chapter.
4. The storage address relocation translator is an optional feature on Models B and D. This function is standard on Model E.

Common Characteristics

The Series/1 processors have in common the standard and optional features discussed below. Standard and optional features unique to each processor are discussed later in this chapter in individual processor sections.

Basic Features

Basic Console

A basic console, shown in Figure 2-1, is standard in each processor unit. It is intended for dedicated systems that are often unattended. Only minimum controls and indicators are provided. These are: a Load key; switches for Power On/Off, IPL Source, and Mode; and indicators for Load, Wait, Run, and Power On.

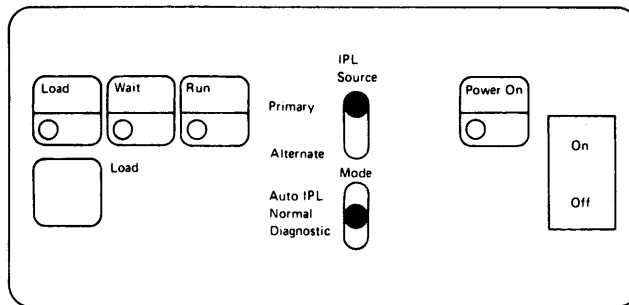

Figure 2-1. Basic console

Addressing Scheme

Each byte location in main storage is directly addressable. Storage locations are numbered consecutively, starting with location 0000; each number is considered to be the address of a byte. Storage addresses are 16-bit unsigned binary numbers. This permits an addressing range of 0 through 65,535.

When the storage address relocation translator is available (see preceding table for applicable processor models), the 16-bit address is used as a logical address to generate a 24-bit physical address, allowing addressing beyond 65,536 bytes.

Interrupt Structure

The processors have four priority interrupt levels with independent registers and status indicators for each level. Level switching can occur in two ways: automatically upon acceptance of an I/O interrupt request from an I/O device or by program control. The interrupt mechanism provides 256 vectored entry points for I/O devices.

Priority Interrupts. Each of the four priority interrupt levels has a bank of hardware registers consisting of eight general registers (16 bits each), an instruction address register, and a level status register that includes a set of result indicators. Depending on the model, each level can have one or more additional registers.

During level switching, the information contained in the interrupted-from level is automatically preserved by hardware; consequently, it is not necessary to store the status indicators and the contents of the general purpose registers in main storage. Automatic vectoring to the service routine for a given device is accomplished by the eight-bit device addresses; thus, 256 direct interrupt entry points are provided.

No software polling of devices is required to accept the interrupt or identify the device. Assignment of a given device to an interrupt level is under program control (by masking) and can be dynamically reassigned. Acceptance of priority interrupts by the processor is under program control on the basis of all four levels, one or more individual levels, or one or more individual devices.

Class Interrupts. A special category of interrupts known as class interrupts is provided in the processor. This is a means of alerting the system about certain classes of errors or exception conditions. Class interrupts can occur on any of the four priority interrupt levels; these interrupts preempt system operation on any of the priority levels until the class interrupt condition has been reset.

The types of class interrupts are processor dependent and are listed in the individual processor sections.

Registers

The registers in the processors are divided into two categories:

- Per-level register (the register is duplicated for each processor priority interrupt level)
- Per-system register (the register is provided only once and is used by all processor priority interrupt levels)

Information that must be saved when a level is preempted is kept in registers supplied for a specific level. Information that is common to all levels or pertains only to the current operating state is kept in registers common to all levels. The registers in each category are listed below.

Registers Supplied on a Per-Level Basis.

- General purpose registers (eight per level, R0-R7)
- Instruction address register (IAR)
- Level status register (LSR)

Registers Supplied on a Per-System Basis.

- Current instruction address register (CIAR)
- Mask register (interrupt levels)
- Processor status word (PSW)
- Console data buffer (with programmer console feature)
- Storage address register (SAR)

I/O Control

The I/O devices are attached to the processor through the processor I/O channel. The I/O channel (which has a defined information format and signal sequence common to I/O devices) accommodates a maximum of 256 I/O device addresses. Four priority interrupt levels can be used to service the devices.

The processor I/O channel directs the flow of information between I/O devices and main storage. It also contains the facilities for controlling I/O operations.

The I/O channel is an asynchronous, multidropped channel that links the processor to its external resources. It consists of address, control, and data lines. Device service through the processor I/O channel can occur as a cycle-steal or direct program control (DPC) operation. Brief descriptions of the cycle-steal and DPC operations follow.

Cycle Steal. Each Operate I/O instruction can initiate multiple data transfers (maximum of 65,535 bytes per control block). I/O operations are overlapped with processing operations. The device must be able to operate in cycle-steal mode and always requests to interrupt the processor upon termination of a cycle-steal operation.

Direct Program Control. An immediate data transfer is made to, or from, the device for each Operate I/O instruction. The data can consist of one byte or one word (two bytes). The operation may or may not terminate with an interrupt request.

Stacking

The processors provide two special types of stacking facilities. There is no restriction (except storage size) on the number of stacks the programmer can define.

Data Stacking. This facility provides an efficient and simple way to handle last-in/first-out queues of data items and/or parameters in main storage. The data items, or parameters, are stack elements. For a given queue, or stack, each element is one, two, or four bytes wide. Instructions for each element size (byte, word, or doubleword) are provided to:

- “Push” an element into a stack (register to storage)
- “Pop” an element from a stack (storage to register)

Linkage Stacking. This facility provides an easy method for linking subroutines to a calling program. A stack, one-word wide, is used for saving and restoring the status of general registers and for allocating dynamic work areas. The Store Multiple instruction stores the contents of the registers into the stack and reserves a designated number of bytes in the stack as a work area. The Load Multiple and Branch instruction reloads the registers, releases the stack element, and causes a branch back to the calling program.

Instruction Set

The instruction set for the processor has a full complement of bit, byte, 16-bit word, and 32-bit doubleword operations. The architecture is general purpose and is designed to support realtime, interactive applications.

There are over 160 instructions in the basic set. These instructions are generally classified by the method of operation or function they perform. Each classification, with an example, is listed below:

- Shifts
 - Shift Left Circular Double
- Register-to-register
 - Move Word
- Parametric
 - Supervisor Call
- Register immediate
 - Reset Bits Word Immediate
- Branching
 - Jump on Condition
 - Branch on Condition
- Single bit manipulation
 - Test Bit
- Register to storage (short and long)
 - Add Byte
 - Operate I/O
- Multiple register to storage
 - Store Multiple
- System register to storage (privileged)
 - Set Level Status Block
- Variable-field-length byte operations
 - Fill Byte Field and Increment
- Storage immediate
 - Subtract Word Immediate
- Storage to storage
 - Move Doubleword
- System register to register (privileged)
 - Copy Current Level

There are seven addressing modes, including single indirect and double displacement indirect addressing. Some instruction types permit up to four address modes per instruction.

All storage addressing is defined by byte (eight data bits plus one parity bit) location. Instructions can refer to bits, bytes, words (two bytes), doublewords (four bytes), or fields as data types.

Optional Features

Programmer Console

This feature is intended for operator-oriented systems where programs are being tested or where various programs will be entered and executed during the day. This type of environment requires a more versatile console to (1) determine program and machine problems, and (2) manually alter data and programs in storage. The following indicators and controls are provided: Check and Data Display indicators; Level, Stop, Stop on Address, Instruction Step, Check Restart, and Stop on Error key/indicators; Reset, Storage, Data Buffer, Console Interrupt, and Start keys (see Figure 2-2).

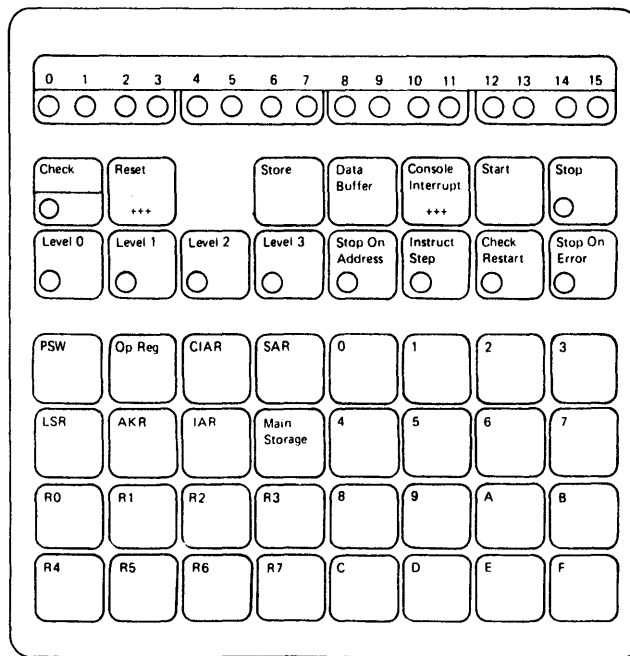

Figure 2-2. Programmer console

4952 Processor

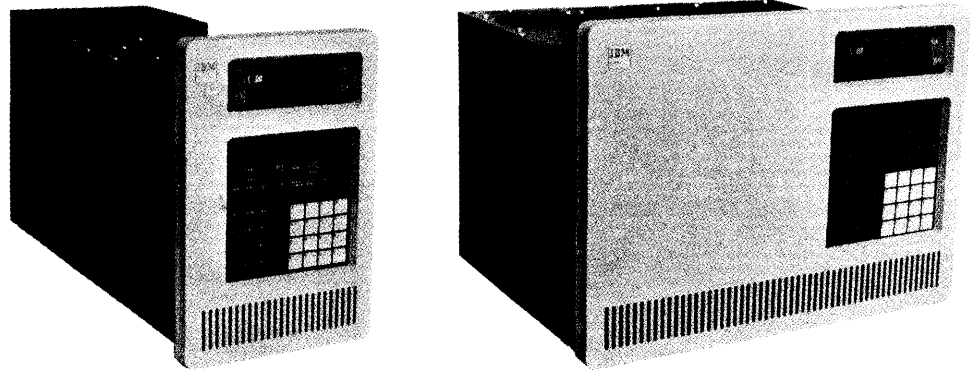

Figure 2-3. 4952 Processor models

Models

The 4952, shown in Figure 2-3, is available in the following models:

- *Model A* is a half-width unit with a storage capacity of 128K bytes, in 32K-byte increments. There are five card sockets available for I/O features.
- *Model B* is a full-width unit with a storage capacity of 128K bytes, in 32K-byte increments. There are 14 card sockets available for I/O features.

A block diagram of a typical system using a 4952 is shown in Figure 2-4, and the 4952 card plugging assignments are shown in Figure 2-5.

Basic Features

Class Interrupts

The 4952 has the following types of class interrupts:

- Machine check
- Program check
- Power/thermal warning
- Supervisor call
- Soft exception trap
- Trace
- Clock/comparator
- Console

Only the power/thermal warning, clock/comparator, and console class interrupts can be disabled under program control. Identification and status information about the exception or error is provided. This information might allow the software to recover such that normal processing can continue with minimum disruption.

The trace class interrupt provides an instruction trace mechanism to simplify software debugging. Instruction tracing can occur on any priority interrupt level. When “trace” is turned on, a unique class interrupt occurs before executing each instruction. Upon exit from the trace routine, the next instruction is executed and the process is repeated until the trace routine is turned off.

Registers

In addition to the eight common registers, the 4952 has:

Register Supplied on a Per-Level Basis.

- Address key register

Registers Supplied on a Per-System Basis.

- Segmentation registers
- Clock register
- Comparator register

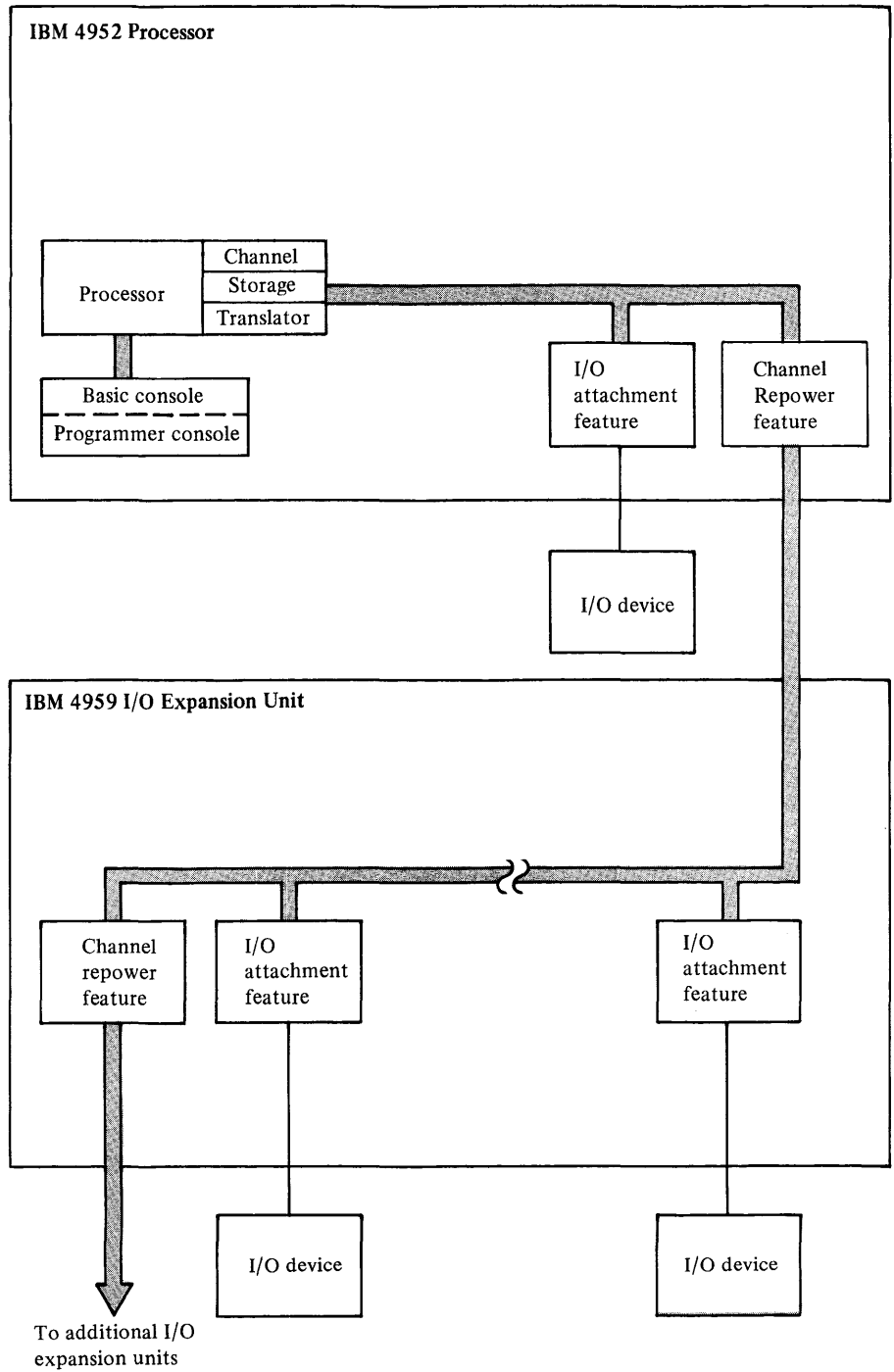
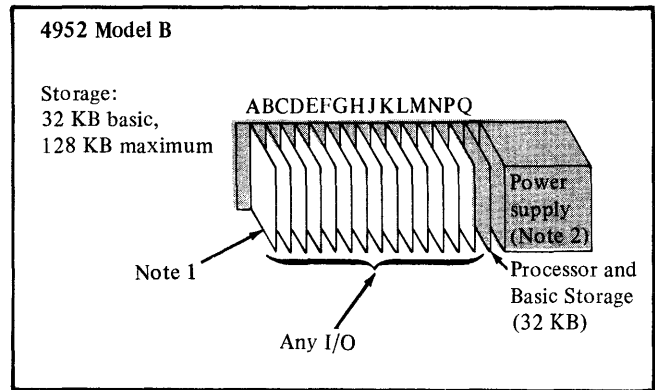
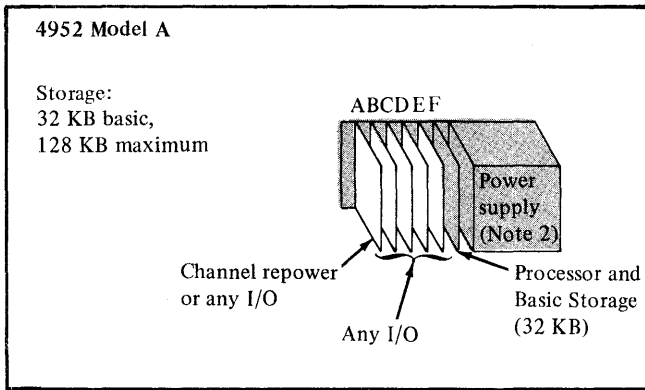

Figure 2-4. Block diagram of a 4952 Processor and a 4959 Input/Output Expansion Unit



Notes.

1. On Model B only the following feature cards may be plugged into the A position due to voltage limitations:
 - Teletypewriter adapter feature using TTL voltage levels
 - Teletypewriter adapter feature using isolated current loop where user supplies external $\pm 12V$ power
 - Timer feature
 - Customer direct program control adapter feature
 - 4982 Sensor I/O Unit Attachment feature
 - Integrated digital I/O nonisolated feature
 - Channel repower feature
2. On Models A and B, ± 12 volts is standard

Figure 2-5. Card plugging assignments for 4952 Processor

Processor I/O Channel

The maximum burst data rate of the processor I/O channel is 416,000 transfers per second (a transfer is either one word or two bytes of data). When multiple cycle-stealing devices are interleaved, the aggregate data rate is also 416,000 transfers per second.

Storage Address Relocation Translator

This translator permits addressing of main storage locations beyond 64K.

Segmentation Registers (Storage Protection)

Because each stack of segmentation registers has access to storage only within its assigned region, protection is provided against writing into storage or fetching instructions from another region.

The translator also provides no-access and read-only protection within the regions controlled by each stack of segmentation registers. This allows storage protection of shared segments of storage.

Optional Features

For additional features, see "Optional Features" under "Common Characteristics" earlier in this chapter.

4953 Processor

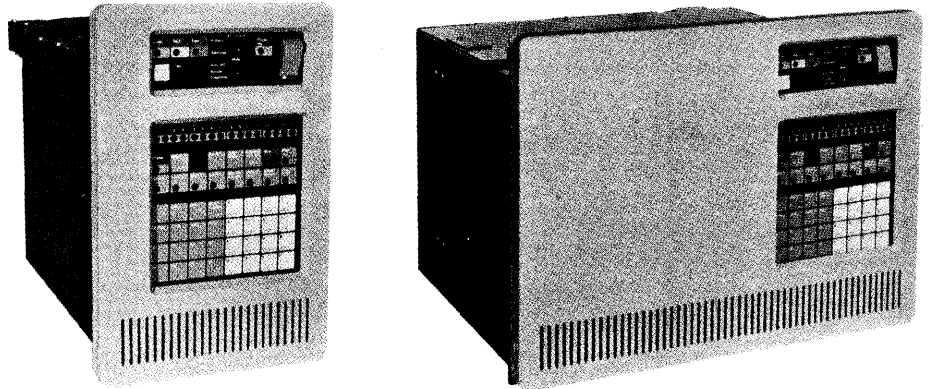

Models A and C

Models B and D

Figure 2-6. 4953 Processor models

Models

The 4953, shown in Figure 2-6, is available in the following models:

- *Model A* is a half-width unit with a storage capacity of 64K bytes of storage, in 16K-byte increments. There are four card sockets available for I/O features, three of which can be used for storage additions.
- *Model B* is a full-width unit with a storage capacity of 64K bytes of storage, in 16K-byte increments. There are 13 card sockets available for I/O features, three of which can be used for storage additions.
- *Model C* is a half-width unit with a storage capacity of 64K bytes of storage, in 32K-byte increments. There are four card sockets available for I/O features, two of which can be used for storage additions.
- *Model D* is a full-width unit with a storage capacity of 64K bytes of storage, in 32K-byte increments. There are 13 card sockets available for I/O features, two of which can be used for storage additions.

The number of card sockets available for I/O features, on any model of the 4953, is reduced by one for each storage increment installed after basic storage. This number is also reduced by one when the 4959 I/O expansion unit is added because the channel repower feature is a prerequisite for adding the I/O expansion unit to the 4953.

A block diagram of a typical system using a 4953 is shown in Figure 2-7, and the 4953 card plugging assignments are shown in Figure 2-8.

Basic Features

Class Interrupts

The 4953 has the following types of class interrupts:

- Machine check
- Program check
- Power/thermal warning
- Supervisor call
- Soft exception trap
- Trace
- Console

Only the power/thermal warning and the console class interrupts can be disabled under program control. Identification and status information about the exception or error is provided. This information might allow the software to recover such that normal processing can continue with minimum disruption.

The trace class interrupt provides an instruction trace mechanism to simplify software debugging. Instruction tracing can occur on any priority interrupt level. When “trace” is turned on, a unique class interrupt occurs before executing each instruction. Upon exit from the trace routine, the next instruction is executed and the process is repeated until the trace routine is turned off.

Processor I/O Channel

The maximum burst data rate of the processor I/O channel is 666,000 transfers per second. When multiple cycle-stealing devices are interleaved, the aggregate data rate is also 666,000 transfers per second.

Optional Features

For additional features, see “Optional Features” under “Common Characteristics” earlier in this chapter.

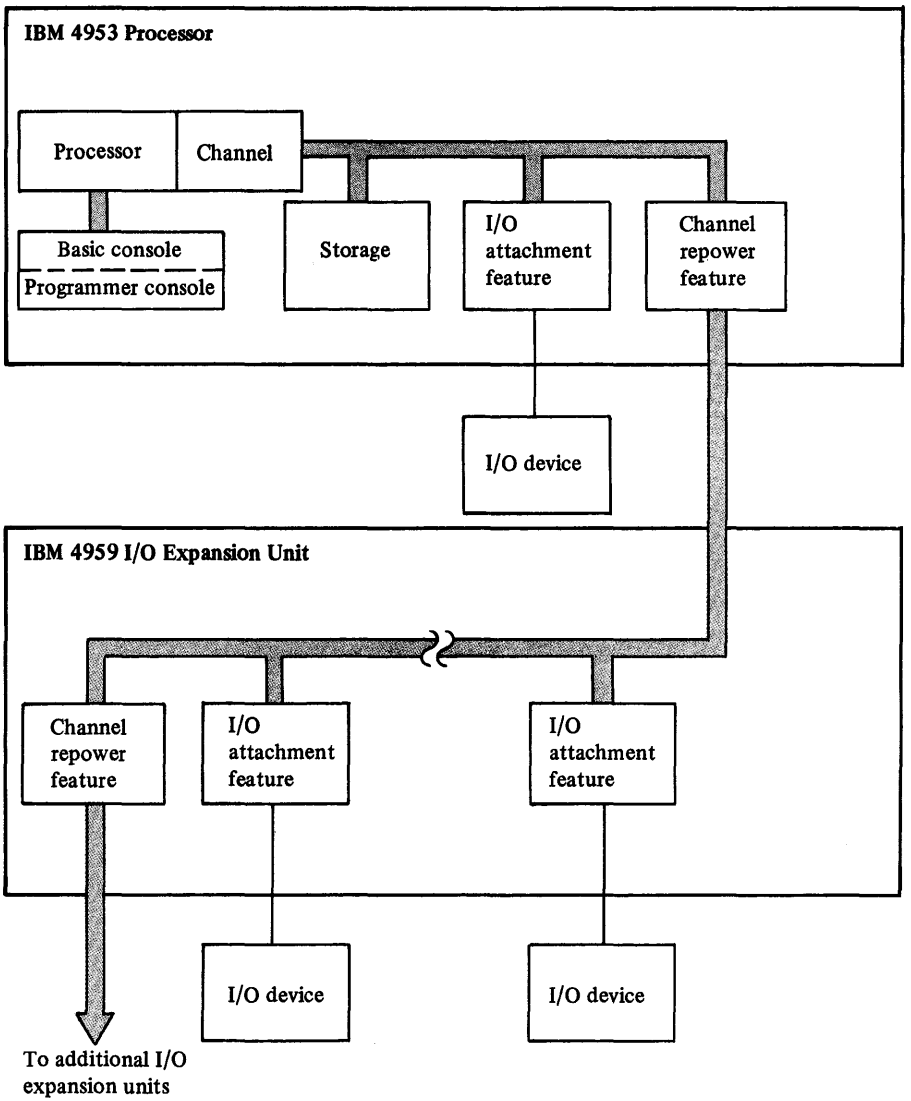
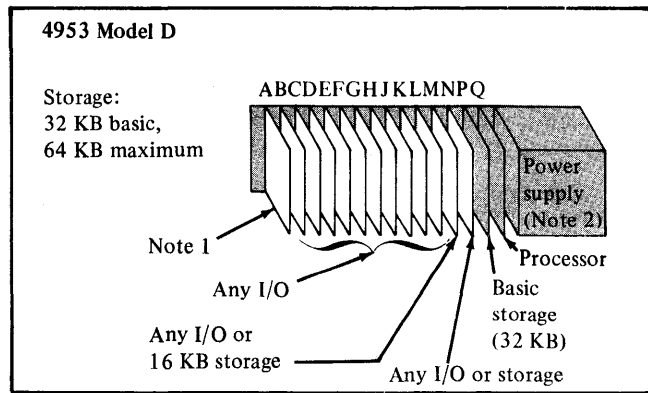
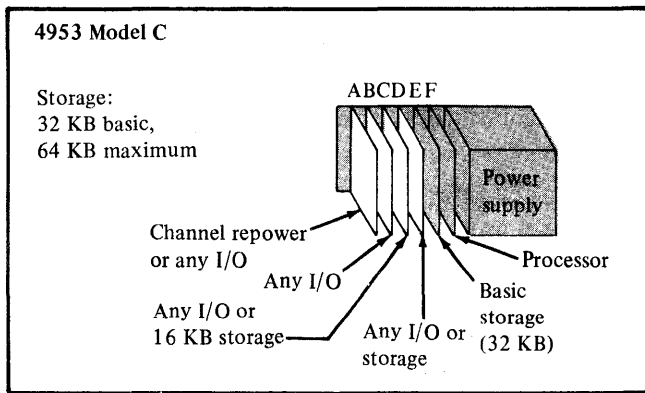
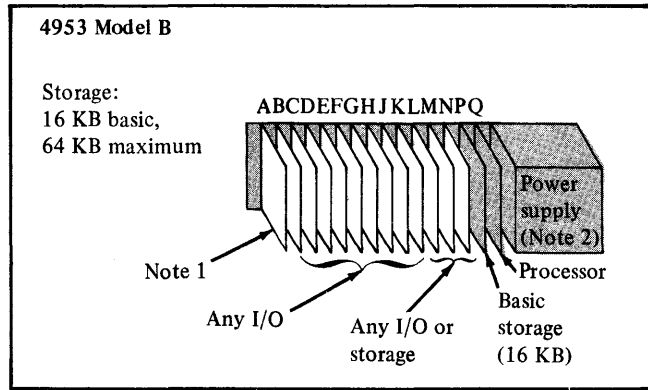
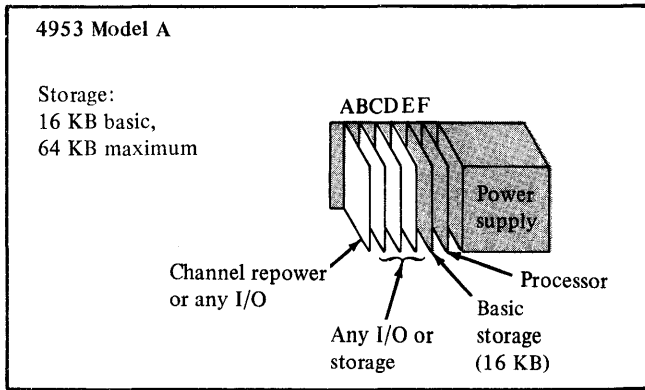

Figure 2-7. Block diagram of a 4953 Processor and a 4959 Input/Output Expansion Unit



Notes.

1. On Models B and D, only the following feature cards may be plugged into the A position due to voltage limitations:
 - Teletypewriter adapter feature using TTL voltage levels
 - Teletypewriter adapter feature using isolated current loop where user supplies external $\pm 12V$ power
 - Timer feature
 - Customer direct program control adapter feature
 - 4982 Sensor I/O Unit Attachment feature
 - Integrated digital I/O nonisolated feature
 - Channel repower feature
2. On Models B and D, the communications power feature provides ± 12 volts and is a prerequisite for the following I/O feature cards (on Models A and C ± 12 volts is standard):
 - All communications features
 - Teletypewriter adapter feature using the non-isolated current loop
 - Teletypewriter adapter feature using the EIA voltage level interface

Figure 2-8. Card plugging assignments for 4953 processor

4955 Processor

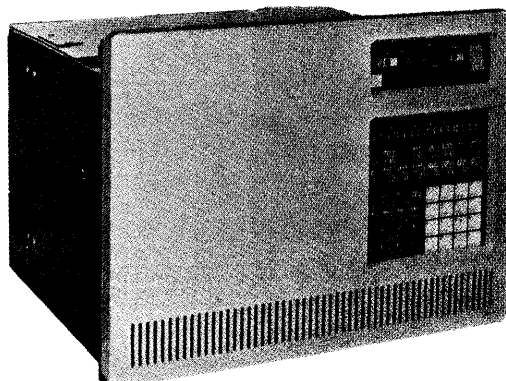

Models A, B, C, D, and E

Figure 2-9. 4955 Processor

Models

The 4955, shown in Figure 2-9, is a full-width unit available in the following models:

- *Model A* has a storage capacity of 64K bytes, in 16K-byte increments. There are eight card sockets available for I/O features.
- *Model B* has a storage capacity of 128K bytes, in 16K-byte increments. The storage address relocation translator feature is required when storage capacity exceeds 64K bytes. There are three card sockets available for I/O features.
- *Model C* has a storage capacity of 64K bytes, in 32K-byte increments. (A maximum of one 16K-byte storage card can be used for a storage capacity of 48K bytes.) There are 10 card sockets available for I/O features.
- *Model D* has a storage capacity of 128K bytes, in 32K-byte increments. (A maximum of one 16K-byte storage card can be used for intermediate storage capacities, such as 80K or 112K bytes.) The storage address relocation translator feature is required when storage capacity exceeds 64K bytes. There are seven card sockets available for I/O features.
- *Model E* has a storage capacity of 256K bytes of storage, in 64K-byte increments. (A maximum of one 32K-byte storage card can be used for intermediate storage capacities, such as 96K or 160K bytes.) The storage address relocation function is standard in this model. There are seven card sockets available for I/O features.

The number of card sockets available for I/O features, on any model of the 4955, is reduced by one when the floating-point feature is installed.

A block diagram of a typical system using a 4955 is shown in Figure 2-10, and the 4955 card plugging assignments are shown in Figure 2-11.

Basic Features

Class Interrupts

The 4955 has the following types of class interrupts:

- Machine check
- Program check
- Power/thermal warning
- Supervisor call
- Soft exception trap
- Trace
- Console

Only the power/thermal warning and the console class interrupts can be disabled under program control. Identification and status information about the exception or error is provided. This information might allow the software to recover such that normal processing can continue with minimum disruption.

The trace class interrupt provides an instruction trace mechanism to simplify software debugging. The trace routine can occur on any priority interrupt level. When "trace" is turned on, a unique class interrupt occurs before executing each instruction. Upon exit from the trace routine, the next instruction is executed and the process is repeated until the trace is turned off.

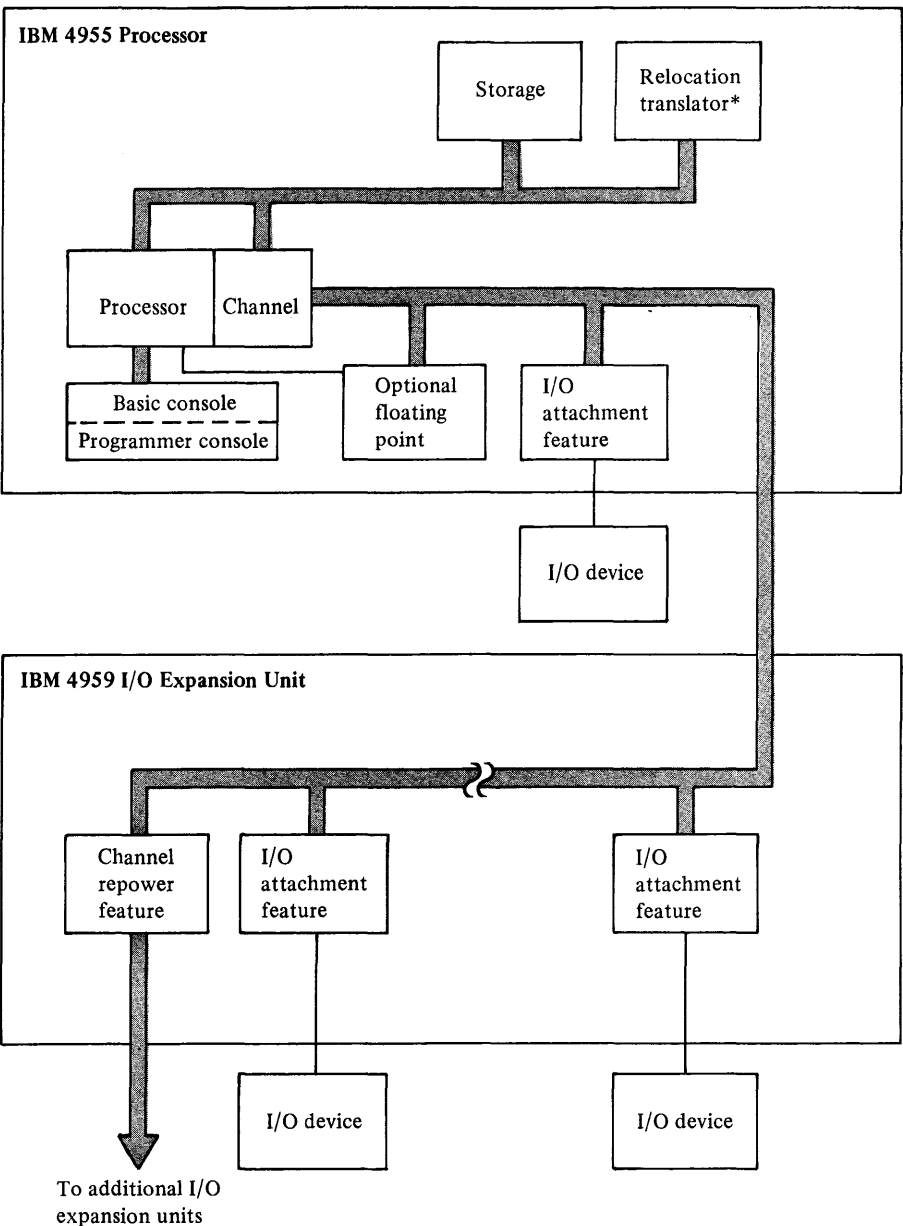

* The relocation translator is optional on Models B and D, standard on Model E, and not available on Models A and C.

Figure 2-10. Block diagram of 4955 Processor and 4959 Input/Output Expansion Unit

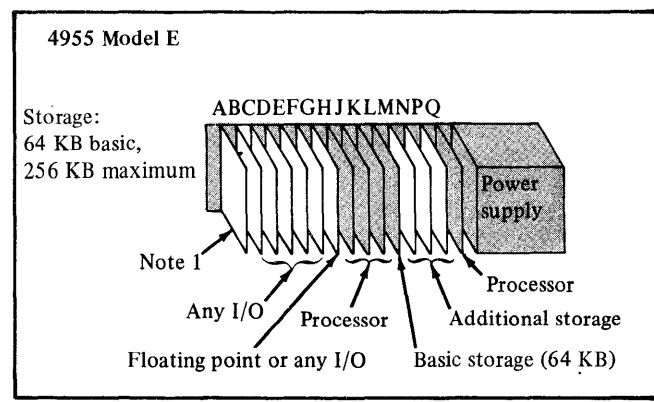
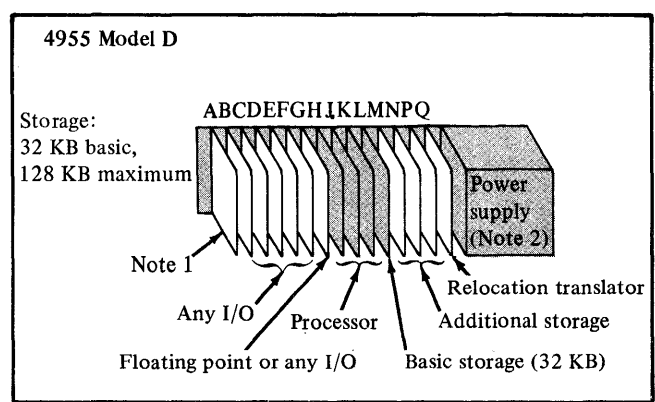
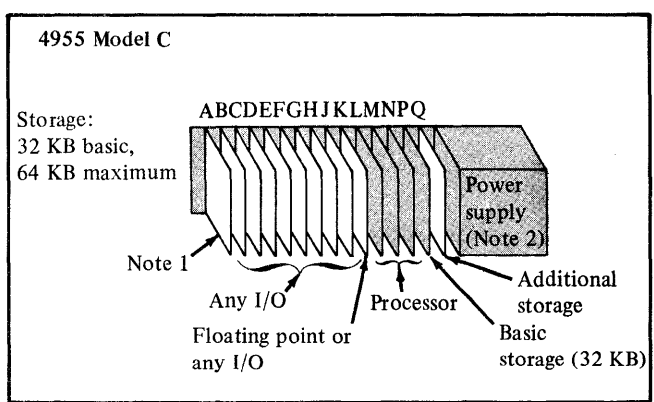
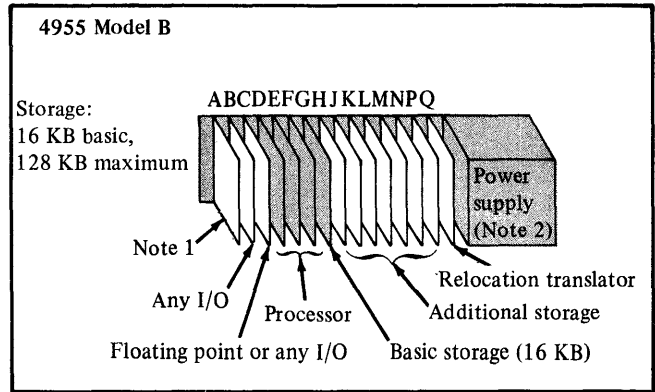
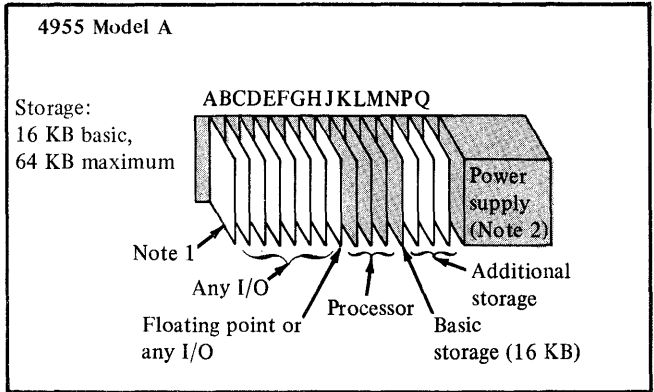

Notes.

1. The A position for all Models is reserved for the I/O cables or, due to voltage limitations, one of the following I/O features cards:
 - Teletypewriter adapter feature using TTL voltage levels
 - Teletypewriter adapter feature using isolated current loop where customer supplies external ±12V power
 - Timer feature
 - Customer direct program control adapter feature
 - 4982 Sensor I/O Unit Attachment feature
 - Integrated digital I/O nonisolated feature
 - Channel repower feature
2. The communications power feature provides ±12 volts and is a prerequisite for the following I/O feature cards (on Model E, ±12 volts is standard):
 - All communications features
 - Teletypewriter adapter feature using the nonisolated current loop
 - Teletypewriter adapter feature using the EIA voltage level interface

Figure 2-11. Card plugging assignments for 4955 Processor

Registers

In addition to the eight common registers, the 4955 has:

Registers Supplied on a Per-Level Basis.

- An address key register
- Four floating-point registers (when the floating-point feature is attached)

Register Supplied on a Per-System Basis.

- Segmentation registers (when the storage address relocation translator is attached)

Processor I/O Channel

The maximum burst data rate of the processor I/O channel is 832,000 transfers per second. When multiple cycle-stealing devices are interleaved, the aggregate data rate is also 416,000 transfers per second.

Storage Protection

Storage protection is a basic part of the 4955. It prevents writing into and reading defined storage areas. This protection is accomplished by comparing a storage key associated with a storage block against an address key associated with the current operation. A read-only bit is associated with each storage key. If the storage address relocation translator is enabled, storage protection is controlled by the relocation feature.

Optional Features

Floating Point

The floating-point feature is an optional high-speed arithmetic unit for the 4955. Four 64-bit floating-point registers are provided for each of the four priority interrupt levels. Normalized numbers (those used in floating-point arithmetic), contained in these registers, are floating-point normalized in sign magnitude form. Signed binary integers can be loaded from main storage into the registers with automatic conversion to floating point, or floating-point numbers can be loaded directly. Arithmetic operations can be performed between two registers or between main storage and one register. (Data in main storage must be in floating-point format.) The contents of the floating-point registers can be stored in main storage as floating-point numbers or converted to signed binary integers and stored in main storage.

The floating-point format is identical with the IBM System/360, System/370, System/7, and System/3 formats. The instructions permit addition, subtraction, multiplication, division, comparing, loading, storing, and integer conversion.

Storage Address Relocation Translator

The storage address relocation translator is an optional feature for the 4955 Processor Models B and D; however, the function is standard on all Model E processors. The storage address relocation translator permits addressing main storage locations beyond 64K.

For additional features, see “Optional Features” under “Common Characteristics” earlier in this chapter.

4959 Input/Output Expansion Unit

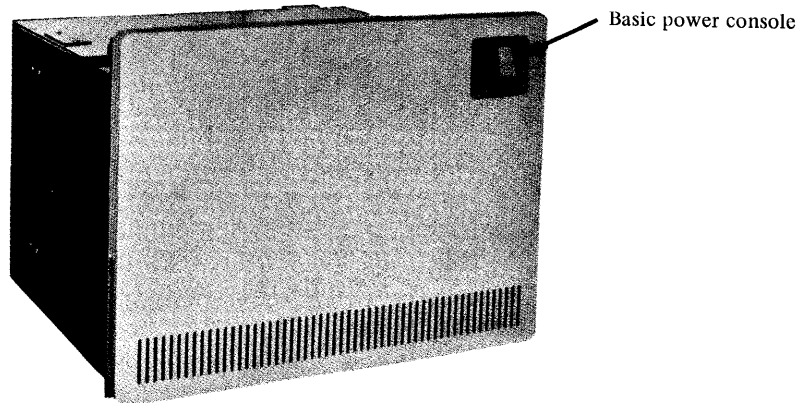

Figure 2-12. 4959 Input/Output Expansion Unit

This unit, shown in Figure 2-12, provides the Series/1 Processor with additional I/O feature card sockets. A channel repower feature is required in the attached-from unit if the 4959 is attached to:

- 4952 Processor, all models
- 4953 Processor, all models
- 4955 Processor (with battery backup)
- Another 4959 I/O Expansion Unit

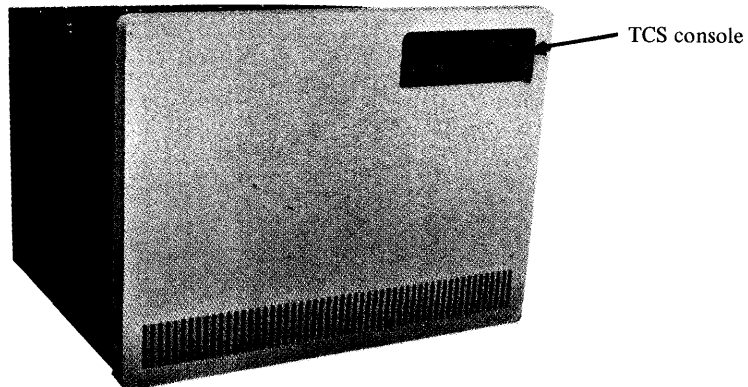
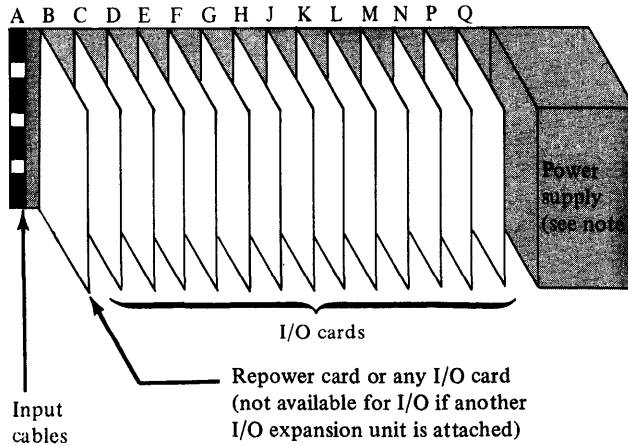

Figure 2-13. 4959 I/O Expansion Unit with Two Channel Switch feature

The 4959 I/O Expansion Unit is available with a Two Channel Switch (TCS) feature, as shown in Figure 2-13. The TCS feature allows a set of common I/O devices to be switched between two Series/1 processor units.



Note. An optional communications power feature provides ± 12 volts and is a prerequisite for the following I/O feature cards:

- All communications features
- Teletypewriter adapter feature using the nonisolated current loop
- Teletypewriter adapter feature using the EIA voltage level interface

Figure 2-14. 4959 I/O Expansion Unit card plugging assignments

A maximum of 14 card sockets are available for I/O features in this full-width modular unit as shown in Figure 2-14. I/O features that can be plugged into the 4959 include:

- Data processing I/O attachment features
- Communication features
- User attachment features
- Sensor I/O unit attachment feature

Two Channel Switch (TCS) Feature

The TCS feature provides two Series/1 processors with a common I/O configuration. The TCS feature card, shown in Figure 2-15, is plugged into the 4959 I/O Expansion Unit and is connected by cable to the I/O channels of two Series/1 processors.

The TCS feature can be configured to automatically switch the I/O devices from the primary processor to the secondary processor if the primary processor fails. Manual intervention is required when switching back to the primary processor; switching can be done in either direction by the operator. The TCS is not apparent to the channel that is using the common I/O devices, as shown in Figure 2-16.

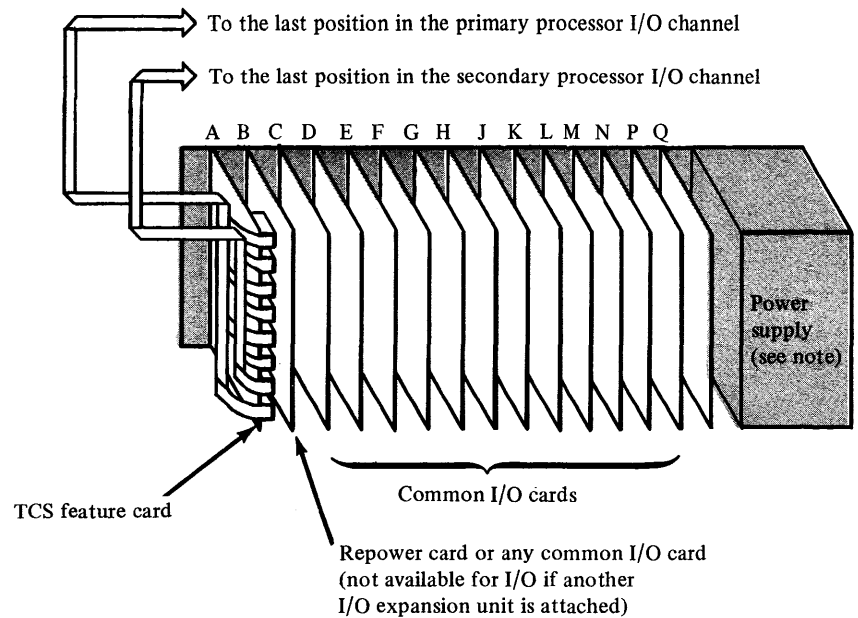

Note. An optional communications power feature provides ± 12 volts and is a prerequisite for the following I/O feature cards:

- All communications features
- Teletypewriter adapter feature using the nonisolated current loop
- Teletypewriter adapter feature using the EIA voltage level interface

Figure 2-15. 4959 I/O Expansion Unit and Two Channel Switch feature—card plugging assignments

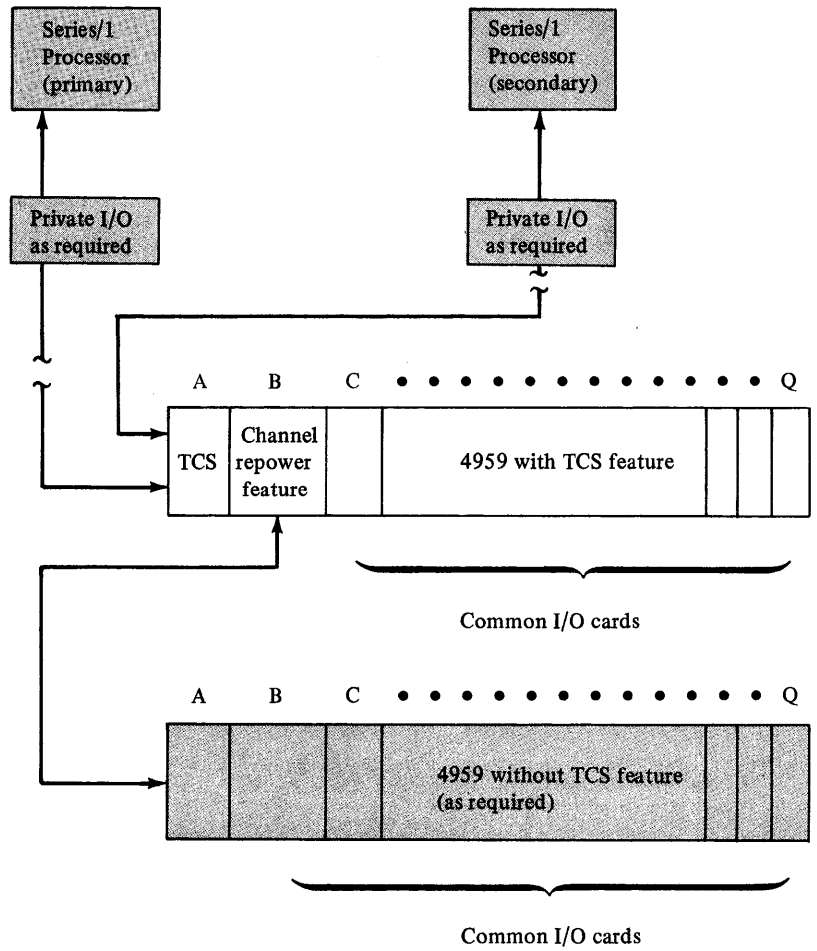

Figure 2-16. System diagram of a dual processor system with a 4959 I/O Expansion Unit and TCS feature

TCS Console

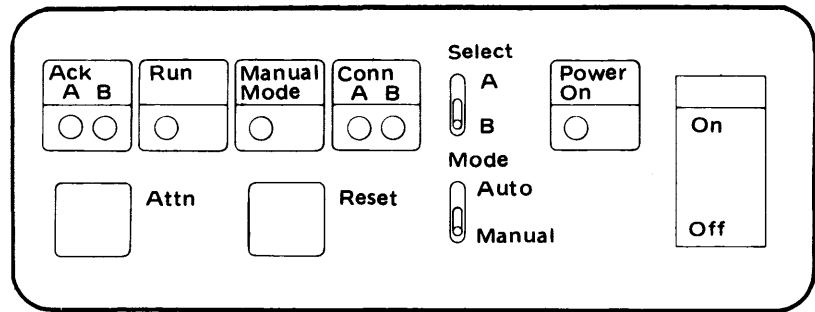

Figure 2-17. TCS console

The TCS console, shown in Figure 2-17, provides indicators, switches, and keys for:

- Turning unit power on and off
- Manual or automatic mode selection
- Manual selection of processors
- Manual processor interruption
- Channel reset
- Manual error recovery
- Displaying unit status

For additional information concerning the TCS feature, refer to the *IBM Series/1 Two Channel Switch Feature Description*, GA34-0056.

Chapter 3. Disk, Diskette, and Magnetic Tape Units

This chapter describes the following Series/1 units:

- 4962 Disk Storage Unit
- 4963 Disk Subsystem
- 4964 Diskette Unit
- 4966 Diskette Magazine Unit
- 4969 Magnetic Tape Subsystem

This page intentionally left blank.

4962 Disk Storage Unit

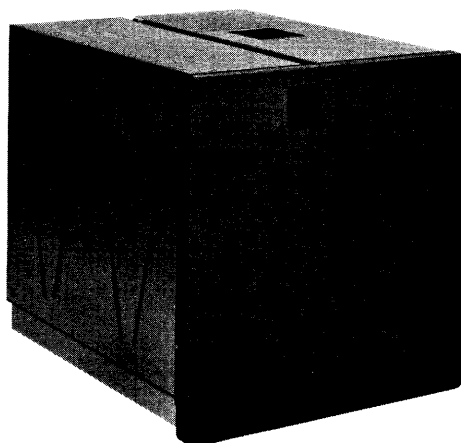

Models 1, 1F, and 3

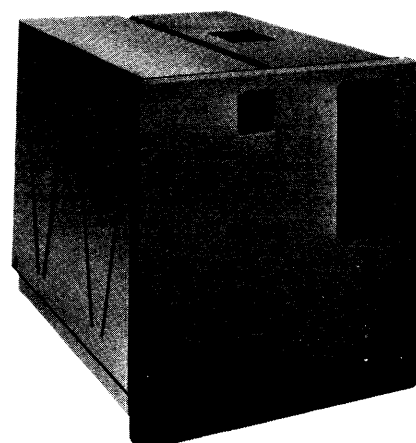

Models 2, 2F, and 4

Figure 3-1. 4962 Disk Storage Units

This unit, shown in Figure 3-1, is a direct access storage device available in six models. Models 1, 1F, 2, and 2F have 9,308,160 bytes of storage accessed by two movable heads. Models 3 and 4 have 13,962,240 bytes of storage accessed by three movable heads. Models 1F and 2F have an additional 122,880 bytes on the same disk accessed by eight fixed heads. Models 2, 2F, and 4 also have an additional 606,208 bytes storage (maximum) on a removable diskette.

Models

The six models of the 4962 Disk Storage Unit are summarized below:

Storage Capacity of 4962 Models (in bytes)			
4962 model	Disk storage (movable heads)	Disk storage (fixed heads)	Diskette storage (maximum)
1	9,308,160		
1F	9,308,160	122,880	
2	9,308,160		606,208
2F	9,308,160	122,880	606,208
3	13,962,240		
4	13,962,240		606,208

All models of the 4962 require the 4962 Disk Attachment Feature for attachment to the Series/1. The 4962 Models 2, 2F, and 4 include a diskette drive identical in function to the 4964 Diskette Unit; consequently, 4962 Models 2, 2F, and 4 require two attachment features: the 4962 Disk Attachment Feature and the 4964 Diskette Attachment Feature, either of which can be plugged into a processor or an I/O expansion unit.

Disk

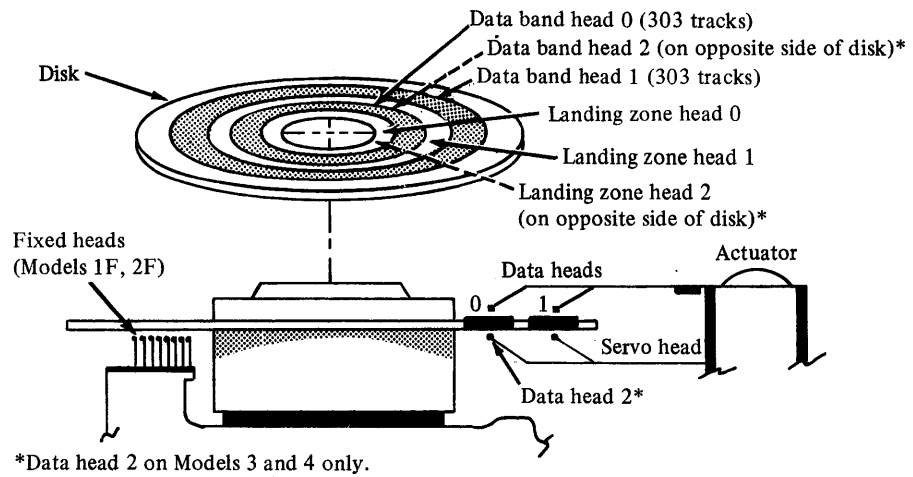

Figure 3-2. Disk and access mechanism

As shown in Figure 3-2, three read/write heads are used to record or retrieve information from concentric data bands on the single, nonremovable disk on Models 3 and 4; two read/write data heads are used on all other models. A servo head, used for data clocking and seek controls, is mounted with the read/write heads on the actuator assembly.

The data tracks accessed by heads 0 and 1 are located on one surface of the disk; the data tracks accessed by head 2 and the servo tracks are located on the opposite surface. On Models 1F and 2F, the servo track surface of the disk also contains eight data tracks that are accessed by fixed read/write heads. Data or programs requiring the highest accessibility should be placed in this area.

Diskette

Except for external physical characteristics, the diskette unit in the 4962 Models 2, 2F, and 4 is identical to the 4964 Diskette Unit. This unit is described later in this chapter.

Specifications

The 4962 Disk Storage Unit provides the Series/1 with direct access data storage capacity. The specifications of the disk drive (all models) are:

Characteristic	Magnitude
Rotation speed	2964 RPM (nominal)
Rotation time	20.2 milliseconds
Average rotation delay or latency	10.1 milliseconds (nominal)
Capacity (movable heads)	
Bytes/sector	256 bytes
Sectors/track	60 sectors
Tracks/cylinder	
Models 1, 1F, 2, and 2F	2 tracks
Models 3 and 4	3 tracks
Cylinders/disk (see Note 1)	303 cylinders
Total disk capacity	
Models 1, 1F, 2, and 2F	9,308,160 bytes
Models 3 and 4	13,962,240 bytes
Data rate	
To or from disk (see Note 2)	889,000 bytes/second (nominal)
To or from channel (see Note 3)	380,000 bytes/second
Access time (movable heads)	
Cylinder to cylinder	10 milliseconds (max)
Average seek (101 cylinders)	40 milliseconds (max)
Capacity (fixed heads—Models 1F and 2F only)	
Fixed heads	8 heads
Bytes/sector	256 bytes
Sectors/track	60 sectors
Total capacity	122,880 bytes
Average rotation delay or latency	10.1 milliseconds (nominal)

Notes:

1. The tracks (one under each head) that can be accessed without repositioning the heads are called a cylinder.
2. The data rate to or from the disk is 1.13 microseconds per byte or 141 nanoseconds per bit.
3. The data rate to or from the channel is the average time for multiple-sector data transfers over two rotations of the disk.

This page intentionally left blank.

4963 Disk Subsystem

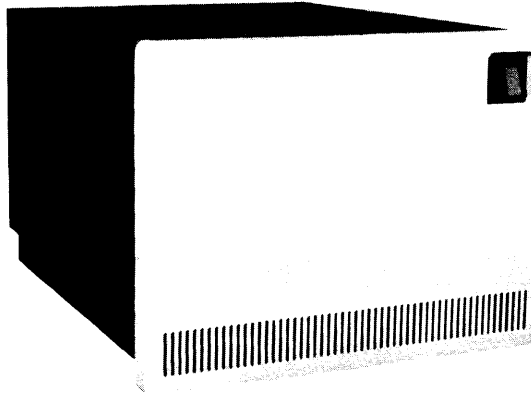

Figure 3-3. 4963 Disk Storage Unit

This subsystem is a combination of 4963 Disk Storage Units. These direct access storage devices provide the Series/1 with data storage capacities of 23 to 258 million bytes per subsystem. Figure 3-3 shows a disk storage unit.

The disk storage unit is available in eight models: four primary disk storage models (23A, 29A, 58A, 64A) and four expansion disk storage models (23B, 29B, 58B, 64B).

The 4963 subsystem is attached to the Series/1 by the 4963 Disk Subsystem Attachment feature, which can be plugged into either a processor or an I/O expansion unit.

Up to three expansion disk units can be attached to the primary unit to expand the disk storage subsystem to its maximum configuration, as shown in Figure 3-4.

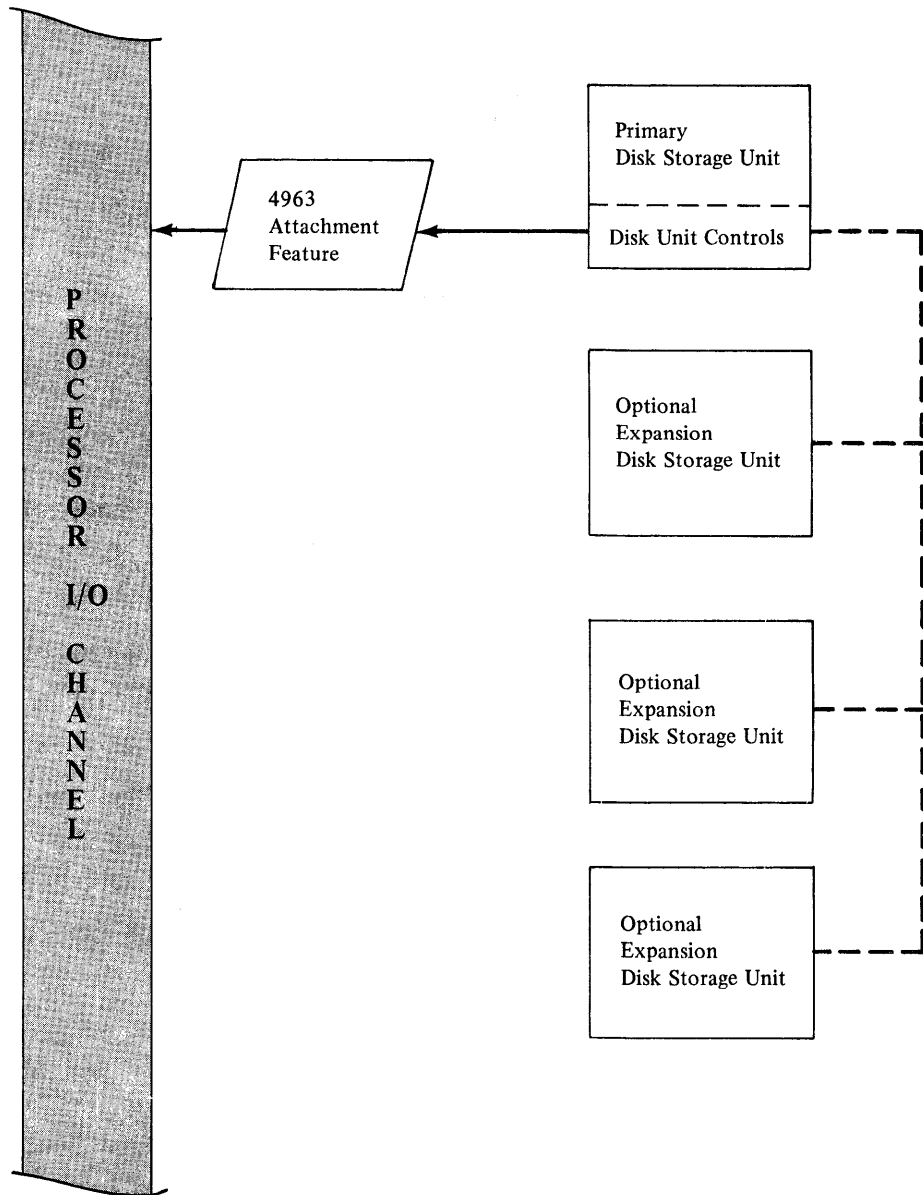

Figure 3-4. Block diagram of the 4963 Disk Subsystem

Models

The eight disk storage unit models of the 4963 Disk Subsystem are summarized below:

4963 model	Description	Disk storage capacity (in bytes)		
		Movable heads	Fixed heads	Total storage
23A	Primary unit*	23,461,888	131,072	23,592,960
23B	Expansion unit*	23,461,888	131,072	23,592,960
29A	Primary unit	29,327,360		29,327,360
29B	Expansion unit	29,327,360		29,327,360
58A	Primary unit*	58,654,720	131,072	58,785,792
58B	Expansion unit*	58,654,720	131,072	58,785,792
64A	Primary unit	64,520,192		64,520,192
64B	Expansion unit	64,520,192		64,520,192

*With fixed heads

The 4963 subsystem is comprised of full-width modular units designed for rack mounting. The minimum subsystem configuration is one primary 4963 Disk Storage Unit and a 4963 Attachment Feature; the maximum is one primary 4963 Disk Storage Unit, three expansion 4963 Disk Storage Units, and a 4963 Attachment Feature. Multiple 4963 Disk Storage Subsystems of any configuration can be attached to a Series/1.

4963 Disk Storage Unit

The disk storage unit has multiple, nonremovable rigid magnetic disks accessed by moving read/write heads. The various models provide storage capacities of 23 to 64 million bytes. The fixed-head models have storage of 131,072 bytes under the fixed heads. Data or programs requiring the highest accessibility should be placed in the fixed-head storage area.

Disk Unit Controls

Each of the primary disk unit models has disk unit controls that provide for attachment and control of up to three expansion disk storage units.

The controls also serve as an interface for exchanging commands and data between the 4963 Attachment Feature and the disk storage units.

Specifications

The 4963 Disk Storage Unit provides the Series/1 with large amounts of direct access data storage. The specifications of the disk storage unit (all models) follow:

Characteristic	Magnitude
Rotation speed	3125 RPM (nominal)
Rotation time	17.2 milliseconds
Average rotation delay or latency	9.6 milliseconds (nominal)
Capacity (movable heads)	
Bytes/record	256 bytes
Total disk capacity	
Models 23A, 23B	23,592,960
Models 29A, 29B	29,327,360
Models 58A, 58B	58,785,792 bytes
Models 64A, 64B	64,520,192 bytes
Data rate	
To or from disk (see Note 1)	1,031,000 bytes/second
To or from channel (see Note 2)	426,666 bytes/second
Access time (movable heads)	
Cylinder to cylinder	9.0 milliseconds (max)
Average seek (approx. 100 cylinders)	27.0 milliseconds (nominal)
Capacity (fixed heads—Models 23A, 23B, 58A, 58B)	
Bytes/record	256 bytes
Total capacity	131,072 bytes
Average rotation delay or latency	9.6 milliseconds

Notes:

1. This is the instantaneous data rate to or from a given disk storage unit.
2. The data rate to or from the channel is the average time for a multiple-sector data transfer over two rotations of the disk.

4964 Diskette Unit

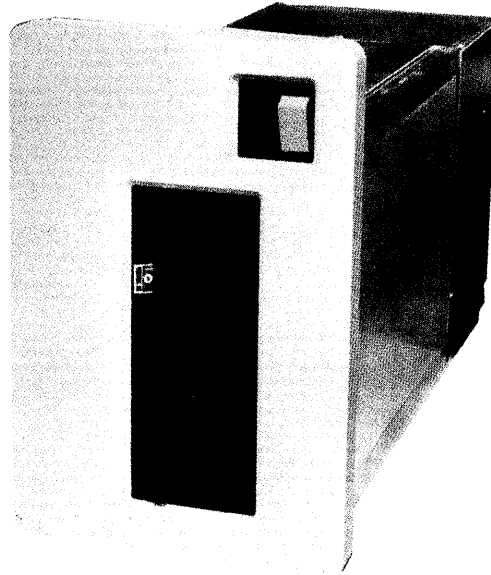
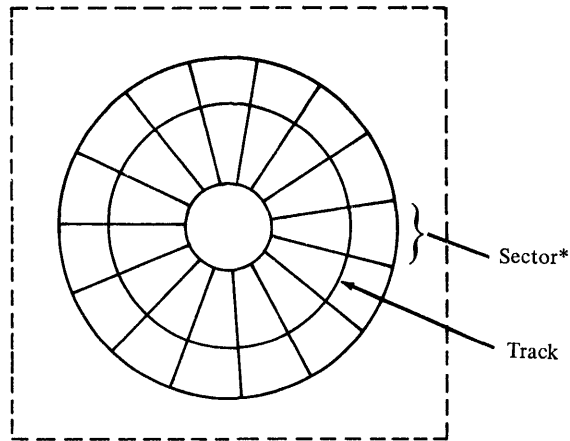

Figure 3-5. 4964 Diskette Unit

This unit, shown in Figure 3-5, is a data-exchange storage device designed for use with the Series/1 processor. This compact, direct access storage device has a single, removable, magnetic diskette that serves as a data exchange medium. The diskette combines the small, batch, data-storage properties of punched cards with many of the features of magnetic tape. The diskette also provides direct access to a specified group of records filed sequentially or randomly on it. The unit is used for temporary or permanent storage of programs or data; the processor can refer to this storage to complete a specific task or application.

The 4964 is attached to the Series/1 by the 4964 Diskette Attachment feature, which can be plugged into either a processor or an I/O expansion unit.



*This illustration shows a diskette formatted for 15 sectors per track, 256 bytes per sector

Figure 3-6. Diskette

Because the 4964 Diskette Unit is a half-width unit, a rack-mounting fixture is required. A rack-mounting fixture is required when using a 4997.

Two heads are used to read and write information on the 74 data tracks on each side of the removable diskette, shown in Figure 3-6. The read/write heads are mounted on a carriage that moves the heads to the track specified by the I/O command. The data tracks are divided into physical locations on the diskette called sectors. When the diskette is initialized, each sector is assigned a unique ID. This permits random access to any sector on a data track. The diskette can be initialized with sector lengths of 128, 256, or 512 bytes.

A 4964 Diskette Unit can exchange diskette data with other IBM devices using a diskette that is recorded on one side in basic data-exchange (128-byte sector) format.

Figure 3-7 shows the diskette with its permanent jacket which protects the surfaces from contamination.

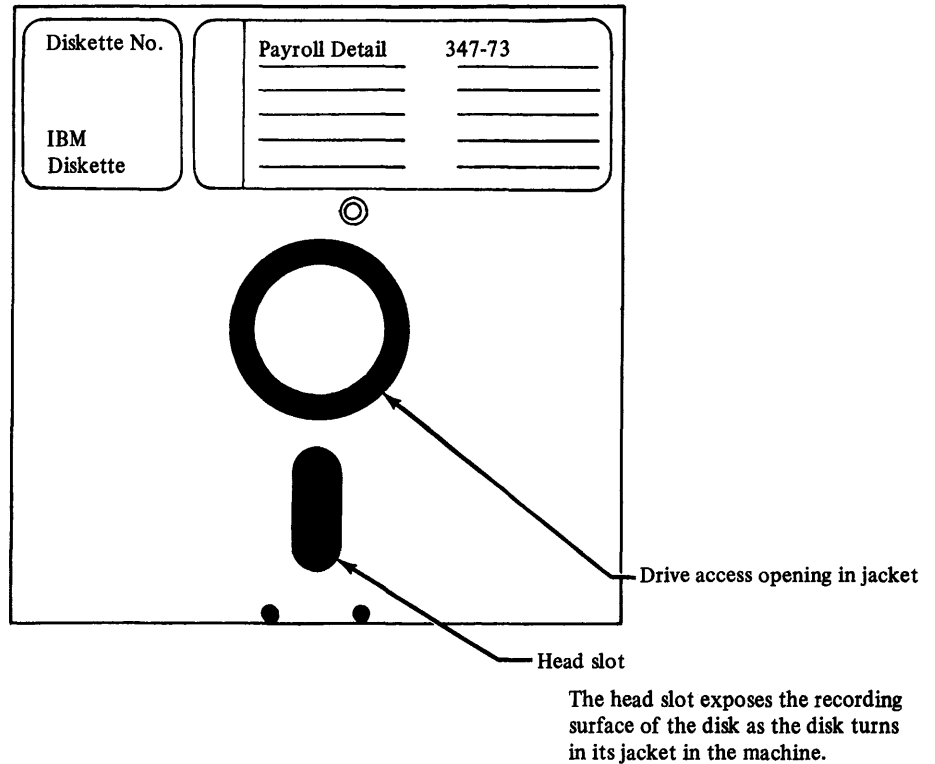

Figure 3-7. Diskette

Specifications

The data storage capacity of the 4964 depends on the sector length selected. This information and other specifications for the diskette unit are provided in the following table:

Characteristic	Magnitude
Maximum data storage capacity for a two-sided diskette (formatted 512-byte sectors)	606,208 bytes
Data transfer rate	31,250 bytes/second
Track to track access time	40 milliseconds
derived from:	
$T = (\text{number of track crossings} \times 5 \text{ ms}) + (35 \text{ ms settling time})$	
Tracks/inch	48 tracks
Total tracks/diskette surface	77 tracks
Data tracks/diskette surface	74 tracks
Capacity by sector size (formatted)	
128 bytes/sector	492,544 bytes
256 bytes/sector	568,320 bytes
512 bytes/sector	606,208 bytes
Rotational speed	360 RPM
Latency	83.8 milliseconds

This page intentionally left blank.

4966 Diskette Magazine Unit

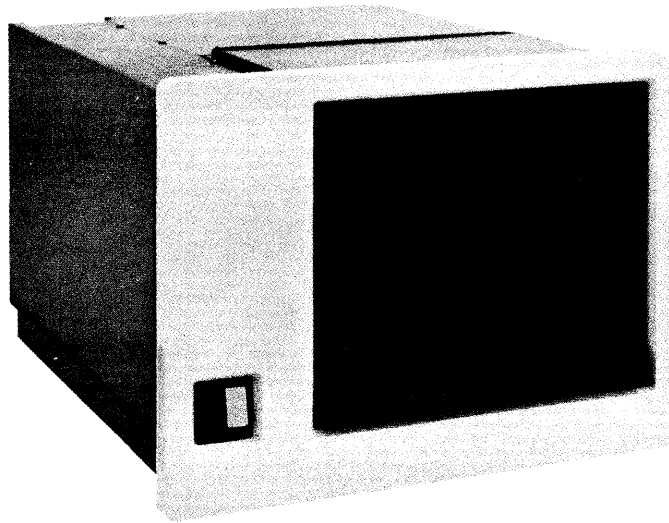

Figure 3-8. 4966 Diskette Magazine Unit

This unit, shown in Figure 3-8, is a direct access multi-diskette storage device designed for use with the Series/1 processor. This device has multiple, removable, magnetic diskettes that serve as a data exchange medium.

The diskette magazine unit provides the Series/1 with data storage capacities of 1.21 to 27.8 million bytes, at data rates up to 125,000 bytes per second. Diskettes written by other IBM diskette drives can also be processed. The 4966 is attached to the Series/1 by the 4966 Diskette Magazine Attachment feature, which can be plugged into either a processor or an I/O expansion unit.

The diskette magazine unit consists of a diskette storage area and a diskette drive unit, as shown in the block diagram of Figure 3-9.

Diskette storage consists of a direct-access movable carriage containing space for two removable diskette magazines and three removable single diskettes or 23 diskettes, since one magazine can hold up to 10 diskettes. The system automatically moves the selected diskette to the drive station.

The diskette drive unit selects and aligns the diskettes for read/write operations. The diskette is returned to its proper storage space before selection of another diskette.

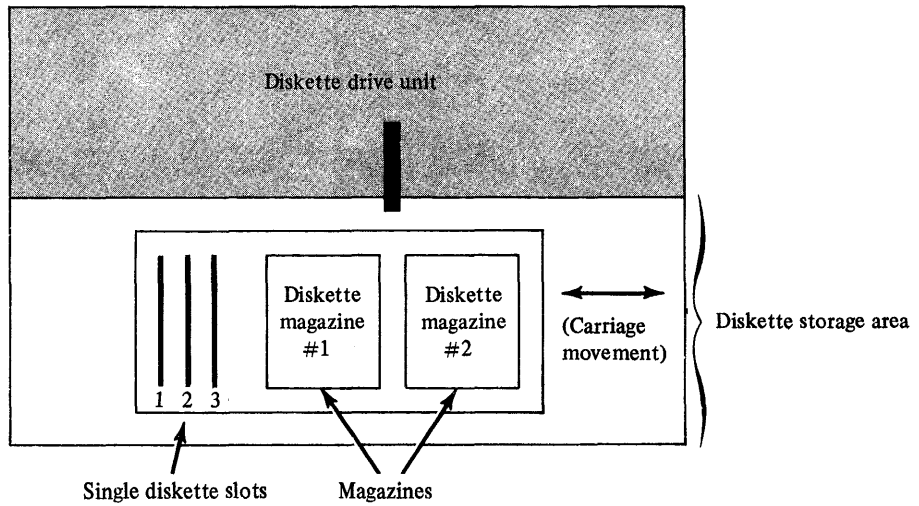
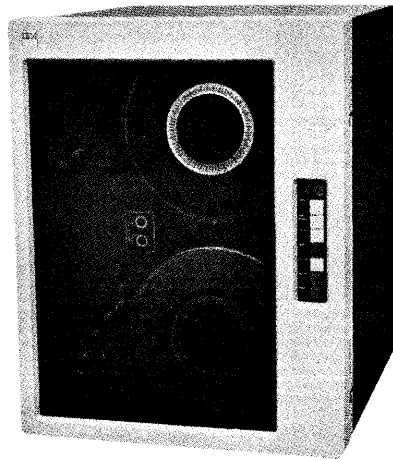

Figure 3-9. Block diagram of the 4966 Diskette Magazine Unit (top view)

4969 Magnetic Tape Subsystem



Models 04N, 04P, 04D



Models 07N, 07P, 07D

Figure 3-10. 4969 Magnetic Tape Unit models

This subsystem consists of one to four 4969 Magnetic Tape Units, shown in Figure 3-10, for each 4969 Attachment feature and Controller feature. All units in a subsystem must have the same speed.

The 4969 subsystem is attached to the Series/1 by the 4969 Magnetic Tape Subsystem Attachment feature, which can be plugged into either a processor or I/O expansion unit.

The subsystem allows 13-millimeter (0.5-inch) wide, 9-track, reel-to-reel magnetic tape to be used with the Series/1. A block diagram of the subsystem is shown in Figure 3-11.

Magnetic Tape Unit

There are six tape unit models available:

Model	Speed (inches/second)	Recording format	Recording density (characters/inch)
4969-04N	45	NRZI*	800
4969-04P	45	PE**	1600
4969-04D	45	dual density	800, 1600***
4969-07N	75	NRZI	800
4969-07P	75	PE	1600
4969-07D	75	dual density	800, 1600

*Non-return-to-zero change-on-ones recording

**Phase encoded

***NRZI records at 800 CPI; PE records at 1600 CPI

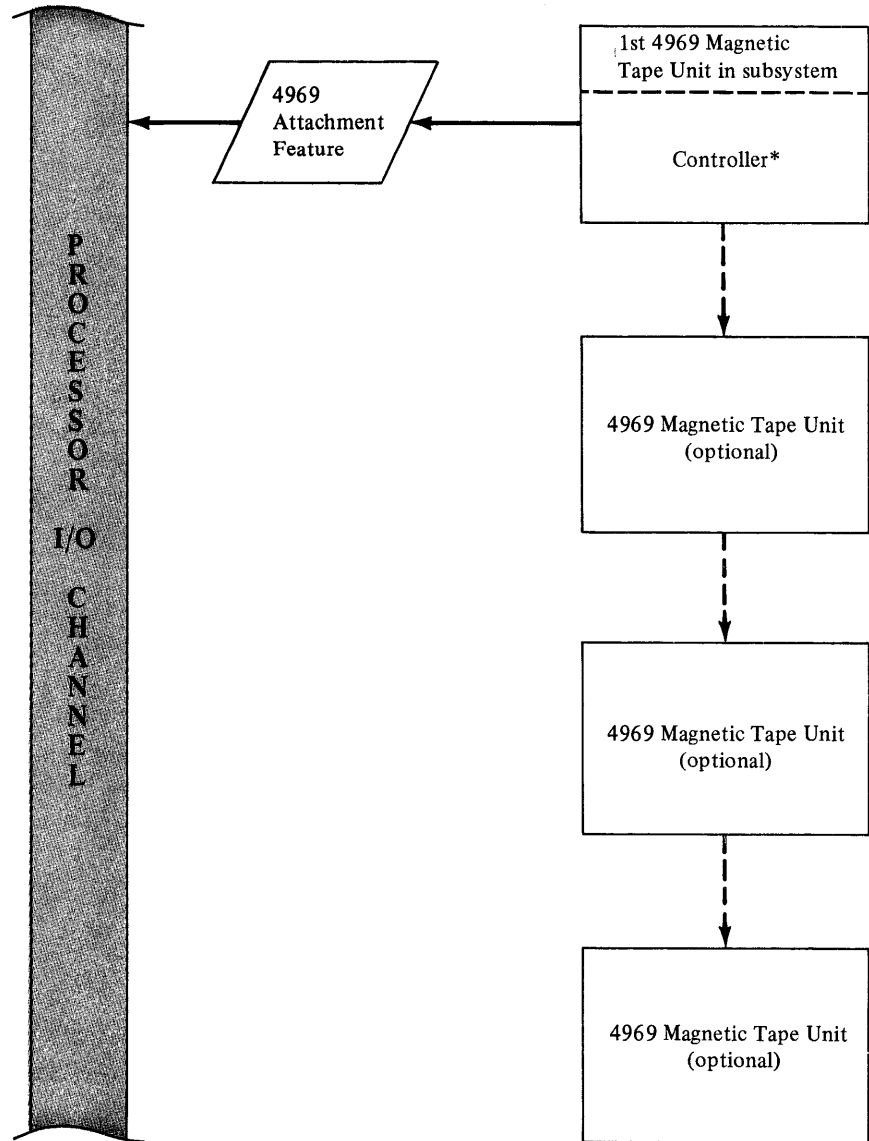

*In first 4969 Magnetic Tape Unit only.

Figure 3-11. Block diagram of a 4969 Magnetic Tape Subsystem

Controller Features

The first tape unit connected to the attachment feature requires a Controller (this unit is also called the primary tape unit). There are three types of controller features to provide a selection of recording formats.

- The controller for 800-characters-per-inch (CPI) NRZI units mounts in the first (primary) unit and supplies formatting and control function for up to three optional (expansion) 800-CPI units of the same speed.
- The controller for 1600-CPI PE units mounts in the first (primary) unit and supplies formatting and control function for up to three optional (expansion) 1600-CPI units of the same speed.
- The controller for Dual Density units mounts in the first (primary) unit and supplies formatting and control function for up to three optional (expansion) units of the same speed and any of the supported formats.

Specifications

Characteristic	Magnitude
Data density	9 track—1600 CPI or 800/1600 CPI
Tape velocity	
Models 04X	1143 mm/sec (45 in/sec)
Models 07X	1805 mm/sec (75 in/sec)
Rewind speed	
Models 04X	3810 mm/sec (150 in/sec)
Models 07X	5080 mm/sec (200 in/sec)
Total speed variation	±4% maximum
Start/stop distance	
Start	4.32 ± 0.5 mm (0.17 ± 0.02 in)
Stop	4.83 ± 0.5 mm (0.19 ± 0.02 in)
Start/stop time	
Models 04X	8.3 ± 0.6 ms
Models 07X	5.3 ms maximum
Head	Dual gap
Number of tracks	9
Recording mode	PE or NRZI
Tape specifications*	Computer grade, 13 mm (0.5 in) wide, 0.0381 mm (1.5 mil) thick Mylar base
Reel size*	Up to 266.7 mm (10.5 in) diameter
Altitude	
Models 04X	0–2135 m (0–7000 ft)
Models 07X	0–1524 m (0–5000 ft)

* For more information on reel hubs and magnetic tape for use on the 4969 Magnetic Tape Subsystem, see *Tape Specifications for IBM One-Half Inch Tape Drives at: 556 and 800 BPI and 3200 FCI*, GA32-0006.

Chapter 4. Printers and Display Unit

This chapter describes the following Series/1 units:

- 4973 Line Printer
- 4974 Printer
- 4979 Display Station

This page intentionally left blank.

4973 Line Printer

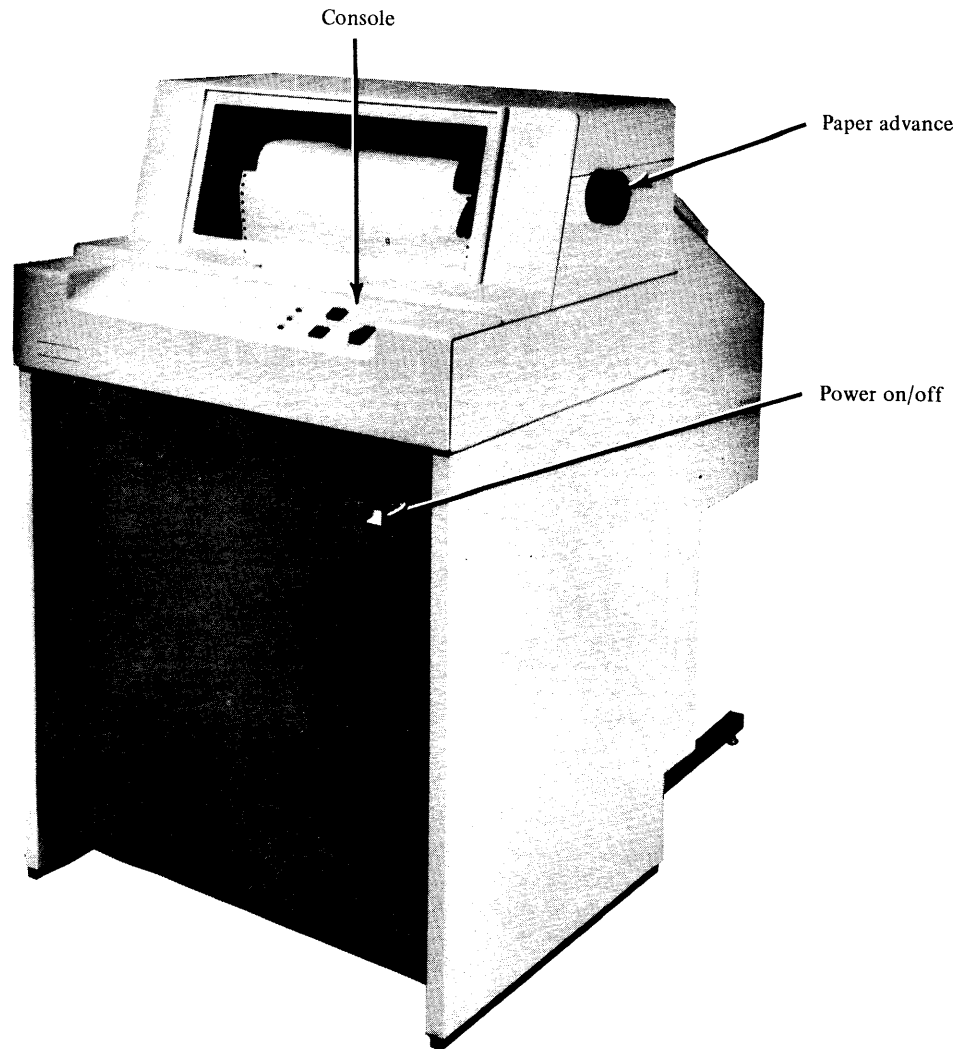

Figure 4-1. 4973 Line Printer

The 4973 Line Printer, shown in Figure 4-1, is a free-standing unit. It consists of three basic components:

- Printing unit
- Carriage
- Console

This printer provides medium- to high-speed “hard copy” output for the Series/1 on continuous form paper.

Two models, with different printing speeds for corresponding character sets, are available.

The 4973 is attached to the Series/1 by the 4973 Line Printer Attachment feature, which can be plugged into either a processor or an I/O expansion unit.

The printing unit consists of a platen, print belt, ribbon, and print hammers (66 print hammers for Model 1, 132 hammers for Model 2). To print, hammers selectively force the paper against the inked ribbon and the engraved characters on the print belt. The print hammers are selected through a belt translator and fired when the desired character on the belt is in the correct print position. The belt translator can be loaded, under program control, with the print belt position to be printed for each of the possible 256 hexadecimal codes. The print belt is interchangeable and is available with 48, 64, or 96 EBCDIC characters.

Both models of the 4973 have a pin-feed carriage that handles up to six-part forms. The carriage moves the forms under program control to produce either 6 or 8 lines per inch. The carriage can also "skip" forms at the rate of 12 inches per second.

The 4973 Printer will handle up to six-part forms with a maximum width of 381 millimeters (15 inches) and a maximum thickness of 0.46 millimeters (0.018 inches).

The printer console contains indicators and switches necessary for manual control of the printer, as shown in Figure 4-2.

Specifications

The approximate printing speeds attained by each model of the 4973 are:

Length of character set	Lines per minute	
	4973 Model 1	4973 Model 2
48	155 (max)	414 (max)
64	120	300
96	80	235

Other specifications for both models include:

Print-line length	132 characters per line
Horizontal character spacing	10 characters per inch
Vertical line spacing	6 or 8 lines per inch
Forms skipping rate	12 inches per second

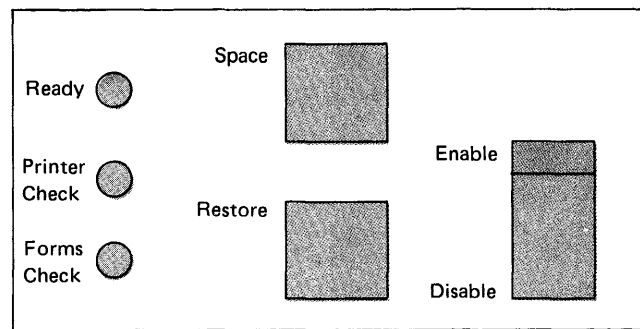

Figure 4-2. Line printer console

International Considerations

Print belts are available to accommodate various countries: English (U.S., Canada), English (U.K.), Austrian/German, Belgian, Danish, French, Italian, Japanese (English), Japanese (Katakana), Norwegian, Spanish, Spanish Speaking, and Swedish.

Japanese (Katakana) Considerations

In addition to the previously mentioned printing speeds, 128 characters are available with the Japanese (Katakana) print belt. Printing speeds for this character set are:

- 40 lines per minute (Model 1)
- 160 lines per minute (Model 2)

The 4973 printer will handle up to four-part forms when using this print belt.

This page intentionally left blank.

4974 Printer

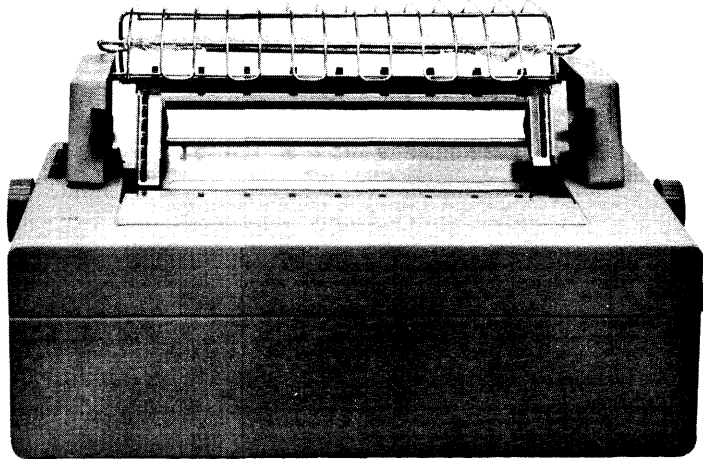

Figure 4-3. 4974 Printer

This serial printer, shown in Figure 4-3, provides medium-speed “hard copy” output for the Series/1 on either cut or continuous forms. The 4974 Printer is a tabletop unit. It consists of two basic components:

- Printing unit
- Forms tractor

The printing unit consists of a platen, print head, and ribbon.

The print head has eight vertically arranged wires that are individually controlled by magnets. Characters are formed by printing a pattern of dots that corresponds to a matrix 8 positions high by 7 positions wide. When a character is to be printed, the print head moves horizontally across the paper along the print line and selectively forces the print wires against the inked ribbon to make dots on the paper.

The matrix is stored in a wire-image buffer that can be loaded with the standard 64 EBCDIC characters. When the buffer is initialized, certain alternate characters can be specified to overlay their EBCDIC equivalents in the standard character set. Or, the user can load his own complete wire-image table from main storage. Any eight-bit character code can be defined and selected (and altered) by the user to print a character set of up to 96 characters.

Forms are moved vertically using either a pressure feed for cut forms or a forms tractor for margin-punched continuous forms. Movement of the forms is under program control. During an I/O operation, parameters can be specified for forms length, overflow line, and either the skip line on the next form or the number of lines to be spaced (84 lines maximum).

The 4974 is attached to the Series/1 by the 4974 Printer Attachment feature, which can be plugged into either a processor or an I/O expansion unit.

The 4974 Printer will accept up to six-part forms with a maximum thickness of 0.46 millimeters (0.018 inches). The use of card-stock continuous forms is not recommended. For optimum handling of continuous forms, a forms stand is available.

The 4974 Printer has the following controls for moving and adjusting the paper or forms:

- Power switch
- Mode switch
- Paper-advance knob
- Paper-release lever
- Horizontal fine-adjustment knob
- Copy-control dial
- Ribbon feed-roll release knob
- End-of-Forms switch

Specifications

The approximate printing speeds are:

Characters per line	Lines per minute
34	150
45	122
70	86
90	69
132	49

Other specifications for the 4974 include:

Characteristic	Magnitude
Print speed	120 characters per second
Print-line length (maximum)	132 characters per line
Horizontal character spacing	10 characters per inch
Vertical line spacing	6 lines per inch

International Considerations

The following character sets are program selectable: English (U.S., Canada), English (U.K.), Austrian/German, Belgian, Danish, French, Italian, Japanese (English), Norwegian, Spanish, Spanish Speaking, and Swedish.

4979 Display Station

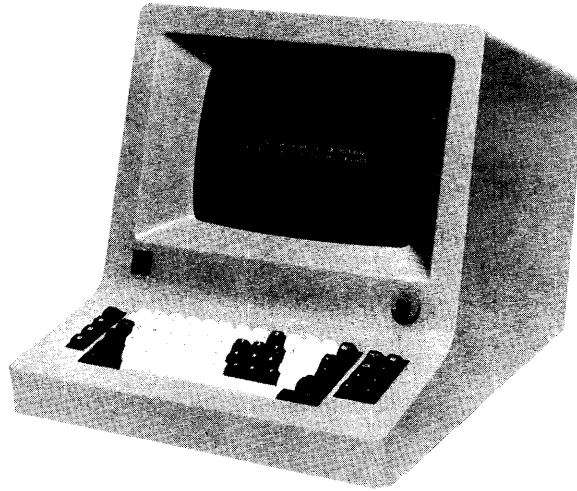

Figure 4-4. 4979 Display Station

This display station, shown in Figure 4-4, is a communication link between the user and the system. It displays data being transmitted to or from the processor. The display station allows the user to:

- Retrieve data from the processor
- Enter, modify, or delete data on the display
- Transfer the data to the processor

The display station has a control above the keyboard to turn the power on and off and to adjust the display for comfortable viewing.

The 4979 is attached to the Series/1 by the 4979 Display Station Attachment feature, which can be plugged into either a processor or an I/O expansion unit.

Specifications

A summary of the characteristics of the 4979 follows:

Characteristic	Magnitude
Screen size (diagonal)	300 millimeters (12 inches)
Display format	
Characters per line	80
Number of lines	24
Total capacity	1920 characters
Display buffer capacity	1920 characters
Number of keys on keyboard	66

Display Screen

The display screen is a 300-millimeter (12-inch) cathode ray tube (CRT). It has the capacity for 1920 characters arranged in 24 lines of 80 characters each. Each character displayed consists of a dot pattern in a 7-by-7 matrix on the CRT screen. The display station can generate numerals, the uppercase alphabet, and special symbols. A special underscore symbol, called a cursor, is displayed beneath a character or character position on the display screen to indicate where the next character entered from the keyboard will appear.

All data moved to the screen and from the keyboard is held in a buffer. The buffer capacity is 1920 characters. System data is transmitted to and from the buffer under program control.

The screen displays data entered by the operator and data from the system. Under operator control, characters are displayed on the screen as they are entered and can be altered before they are transmitted to main storage.

Areas on the screen that always contain the same type of information are called fields.

There are two types of fields on the display:

- A *protected data field* is primarily used by the application program and the data cannot be entered into this field from the keyboard.
- An *input field* is used by the operator to enter, modify, or delete data by keyboard action.

The user's program defines which data is protected. Protected characters are displayed with less intensity than unprotected characters.

When a screen is divided into fields, it is called a formatted screen.

Unformatted screens can be used also, allowing the operator to use the screen in any format.

Console Keyboard

The display station keyboard, shown in Figure 4-5, is a data-entry keyboard similar to that of a typewriter. The alphanumeric and special-character keys are in the center area of the keyboard; control keys are on each side.

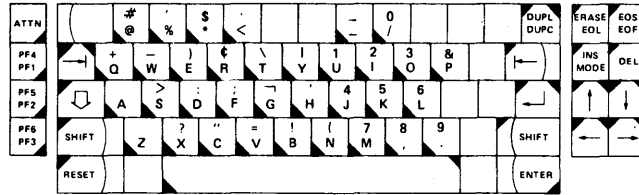

Legend





-  (Typamatic action)
-  Graphic alphanumeric
-  Local function & Shift Lock
-  Interrupt request

Figure 4-5. 4979 keyboard

The keyboard has four key groups:

- Shift/Lock
- Graphic Alphanumeric
- Local Function
- Interrupt Request

The Shift/Lock keys operate the same as those on a standard typewriter keyboard.

The graphic alphanumeric keys represent the printable alphanumeric, space, and graphic symbols contained within the EBCDIC character set.

The local function keys move the data characters or the cursor within the attachment, but do not cause an interrupt request.

Certain keys within the graphic alphanumeric and local function categories are typamatic keys; that is, the corresponding action is repeated automatically as long as the key is held down. The other keys have momentary action; that is, there is only one action each time the key is pressed.

The Interrupt Request keys send an attention-interrupt request to the processor. The keyboard has electronic lockout; that is, it can be locked under program control to prevent unauthorized use.

International Considerations

Keyboards are available to accommodate various countries: English (U.S., Canada), English (U.K.), Austrian/German, Belgian, Danish, French (AZERTY), French (QWERTY), Italian, Japanese (English), Norwegian, Spanish, Spanish Speaking, and Swedish.

Chapter 5. Sensor I/O Unit

This chapter describes the 4982 Sensor Input/Output Unit.

This page intentionally left blank.

4982 Sensor Input/Output Unit

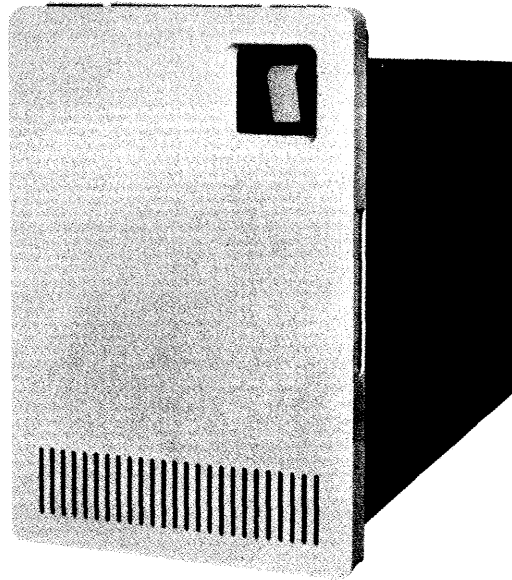
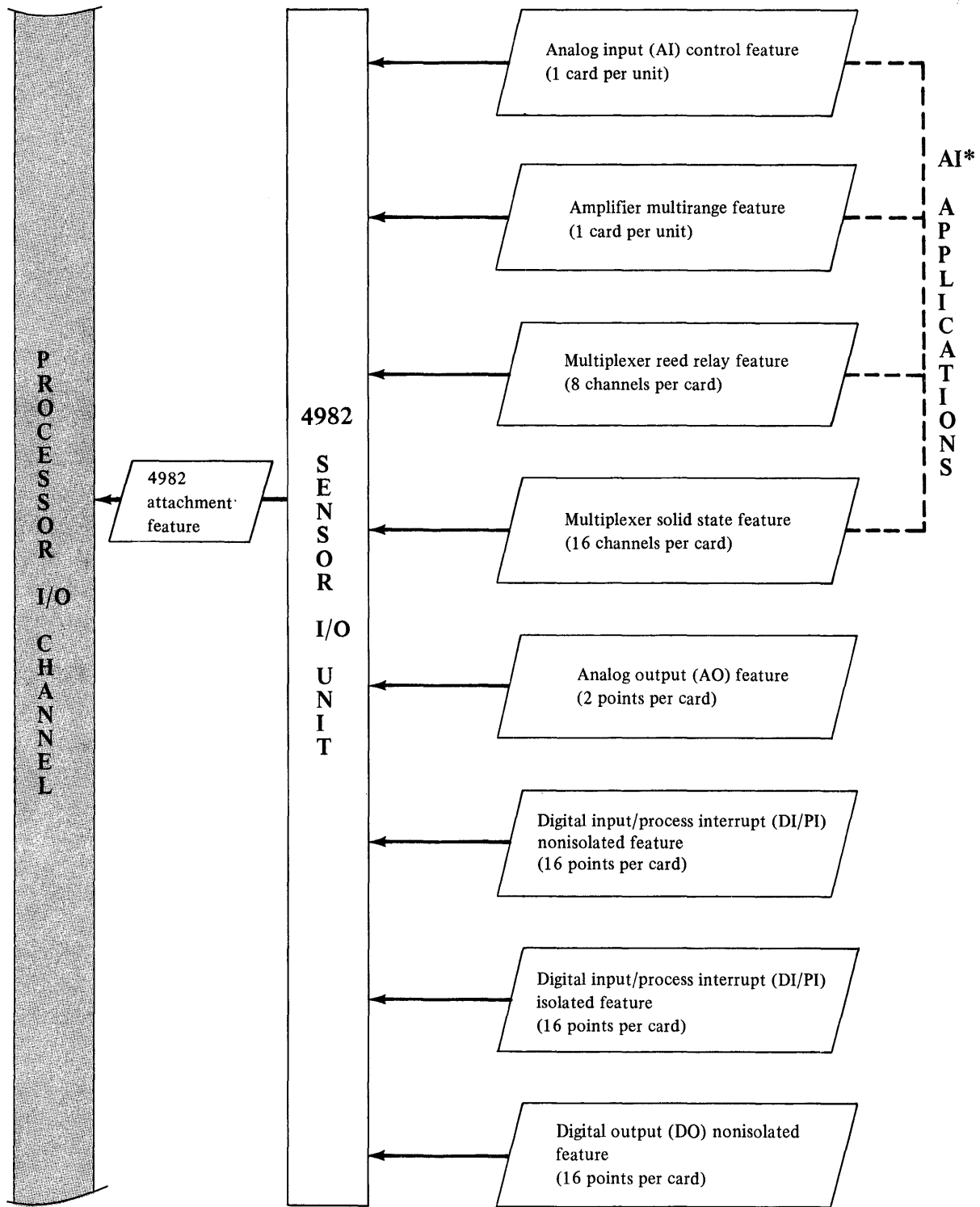

Figure 5-1. 4982 Sensor Input/Output Unit

This unit, shown in Figure 5-1, provides a flexible, modular approach for attaching the user's process I/O applications to the Series/1. The sensor I/O unit has the capacity for eight sensor I/O feature cards. The various feature cards available are shown in Figure 5-2. These feature cards can be used in any combination except that only one analog-input (AI) control card and one multirange amplifier card can be used in any one unit. These two cards service all the AI multiplexer cards installed in the particular 4982.

The 4982 is attached to the Series/1 by the 4982 Sensor Input/Output Unit Attachment feature, which can be plugged into either a processor or an I/O expansion unit.



*All AI applications require the control card and one or more multiplexer card. See "IBM 4982 Sensor Input/Output Unit" for configuration requirements.

Figure 5-2. Block diagram of 4982 Sensor Input/Output Unit

Each 4982 Sensor I/O Unit, although not restricted to a single sensor I/O type, can contain up to the following number of sensor points of each type:

- 128 Digital Input/Process Interrupt (DI/PI) points, either isolated or nonisolated
- 128 Digital Output (DO) points
- 112 Solid-State Multiplexer Analog Input (AI) channels (sometimes referred to as points)—no Amplifier Multirange card used
- 96 Solid-State Multiplexer Analog Input channels (Amplifier Multirange card used)
- 56 Reed-Relay Multiplexer Analog Input channels (no Amplifier Multirange card used)
- 48 Reed-Relay Multiplexer Analog Input channels (Amplifier Multirange card used)
- 16 Analog Output (AO) points

Because the 4982 Sensor Input/Output Unit is a half-width unit, a rack-mounting fixture is required for mounting the unit in a rack enclosure. The 4982 unit is equipped as follows:

- Circuit board with nine card sockets (eight sensor I/O feature sockets and space for one termination card)
- 3.1-meter (10-foot) attachment feature cable
- Cable termination and control functions (termination card)
- Power supply

The eight feature sockets and the termination card are accessible from the rear of the unit. The termination card, which connects the 4982 to the attachment feature cable, contains termination and control logic for the unit.

Card Sockets

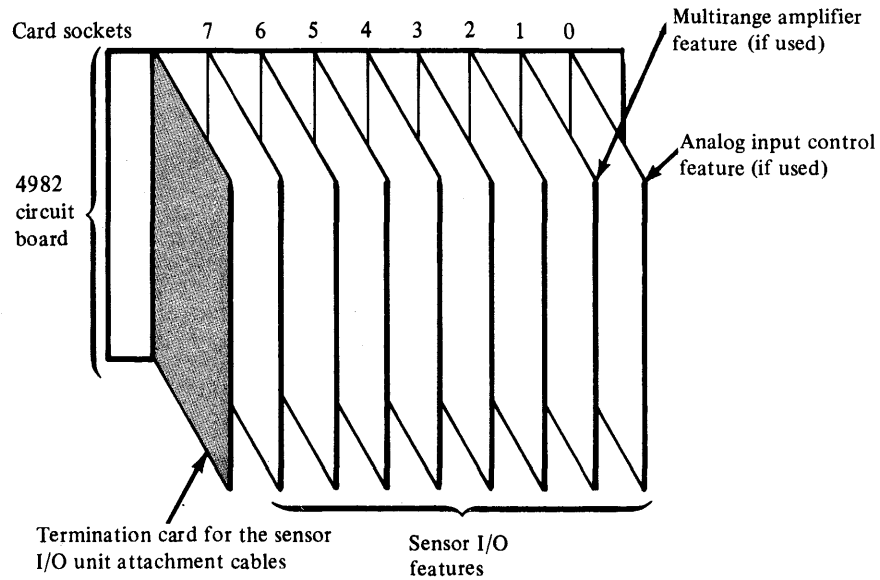

Figure 5-3. 4982 Sensor I/O Unit card sockets (rear view)

Card sockets for the 4982 termination card and sensor I/O features are shown in Figure 5-3. Sensor I/O features are installed in any socket and in any order, with the exception of the AI control feature and multirange amplifier. If used, the AI control feature occupies card socket 0, and the multirange amplifier feature, if used, must occupy card socket 1. An AI multiplexer feature occupies the socket adjacent to the AI control feature or to the multirange amplifier feature. Additional multiplexer features occupy adjacent locations.

The suggested user cable connector is a commercially available 56-pin connector with a protective hood. This connector requires no special tools for installation and provides an orderly method of terminating the large number of connections required for attaching a typical user process. For additional information, refer to *IBM Series/1 Customer Site Preparation Manual*, GA34-0050.

Direct program control commands are used for data transfers between the processor I/O channel and the sensor I/O features. The features are individually addressed from the processor by using assigned feature addresses.

Digital Input/Process Interrupt

Isolated

The isolated DI/PI feature is a digital input logic card with signal conditioning at the user inputs. The card provides 16 points of optically isolated digital inputs for sensing high and low logic-voltage levels. There are four modes of operation:

- *Digital input* allows 16 bits of “unlatched” user input data to be transferred to the processor. No interrupts are generated.
- *Process interrupt* generates an interrupt when a positive transition occurs at the user inputs; 16 bits of “latched” user data can be transferred to the processor. This mode is enabled by program control.
- *External sync* allows the user to move 16 bits of input data into registers and then generate an interrupt. A nonisolated ‘external sync’ input line and a ‘sync ready’ output line are available for the user to synchronize parallel data transfers by using the DI/PI feature. External-sync mode is enabled by program control.
- *Diagnostic* mode can force input data to be 0-bits or 1-bits, overriding any user input states. Consequently, data flow and feature card operation can be checked by software. In addition, a status word is available to determine or verify the state or mode of the DI/PI card. Diagnostic mode is enabled by program control.

Nonisolated

The nonisolated DI/PI feature is a DI logic card with signal conditioning at the user inputs. The card provides 16 points of digital input for sensing contact closures or logic voltage levels.

The nonisolated DI/PI feature is similar to the isolated DI/PI feature except for the following:

- A process-interrupt input is sensed as a negative transition.
- Each of the 16 input points, with high- or low-level capabilities, can detect either user contact closure (contact sense) or user voltage levels (voltage sense).

The 4982 supplies +48 volts dc to sense the opening and closing of the user contacts in the contact-sense application. The user contacts are connected directly to the input terminals.

The level (high or low) of a user voltage is sensed in the voltage-sense application.

Digital Output Nonisolated

This feature card provides 16 points of solid-state nonisolated digital output. Each card has a 16-position register, in which data is stored under program control. The DO points correspond to the positions of the register. With a user-supplied voltage, each point is rated at a maximum of +52.8 volts dc and 250 milliamps. Without a user-supplied voltage, each point supplies a TTL-compatible output voltage.

Analog-Input Subsystem

The simplest AI subsystem configuration consists of:

- The AI control card
- A single multiplexer card

The AI control card is used in every AI configuration because it contains the analog-to-digital converter and the control logic for the rest of the AI subsystem.

There are two kinds of multiplexer cards to choose from: solid state and reed relay. When additional inputs are required, up to seven multiplexer cards of either type, in any mix, can be used with the AI control card. For measuring low-level signals, the multirange amplifier is added to the subsystem. The 4982 can accommodate six multiplexer cards when the multirange amplifier is installed.

The AI subsystem configuration using multiplexer/solid-state cards provides the fastest scanning and sampling rates. This configuration provides a differential input when the multirange amplifier is installed. The input is single ended when the multirange amplifier is not installed. The conversion sequence lasts 72-172 microseconds, depending on the input-voltage range selected and whether zero correction is to be done.

The AI subsystem configuration using multiplexer/reed-relay cards provides the best performance in noisy environments because of its high common-mode voltage rejection. This configuration has a true differential input regardless of whether or not an amplifier card is installed. The conversion sequence lasts 5 milliseconds when the 5-volt input range is used, and 8.2 milliseconds for the other input voltage ranges. All conversions automatically incorporate zero correction.

The AI subsystem achieves a temperature coefficient and stability specification with the zero-correction logic on the AI control card. The zero-correction feature measures the offset voltage error, caused by temperature and aging in the multirange amplifier and the AI control card, and digitally subtracts the error to obtain corrected measurements.

Analog-Input Control Card

This card contains an 11-bit-plus-sign-bit analog-to-digital converter for measuring signals in the -5 volt to +5 volt range. The card also contains the logic for controlling the sequencing of the other AI subsystem cards. Only two adjustments are required on the card: one for zero calibration and the other for full-scale calibration. Two diagnostic commands are used for this purpose; they help diagnose the AI control card and the amplifier card.

Amplifier Multirange Card

This card is a true differential-input instrumentation amplifier with seven programmable input voltage ranges. It is required for measuring low-level signals. The amplifier uses switched-frequency compensation for wide bandwidth and fast settling. It uses FET-input operational amplifiers for high input impedance, low input bias current, low noise, and acceptable common-mode rejection ratio. There are two adjustments on the card: one for the offset voltage adjustment of the input stage and the other for the offset voltage adjustment of the output stage.

Multiplexer/Solid-State Card

This card is a solid-state multiplexer using MOSFET transistors for switching. There are 16 two-wire inputs on the card. Solder tabs are provided so the user can solder capacitors to the card. This forms a low-pass input filter for attenuating high-frequency normal-mode noise. The user can adjust the filter bandwidth by adjusting the capacitance value. The sampling rate with an input filter is restricted to 100 samples per second. If external noise is not a problem, much faster sampling rates can be obtained by operating without the capacitor. The maximum voltage that can be applied to either input line under normal operating conditions is 10 volts. Up to 15 volts can be applied as overload to all inputs simultaneously without damaging the filter. The input signal can have an equivalent source resistance of 1,000 ohms with a 250-ohm source unbalance.

Multiplexer/Reed-Relay Card

This card is a reed-relay multiplexer using the “flying capacitor” method of isolation. This technique gives the card a 200-volt common-mode voltage limit and a common-mode rejection ratio of 120 decibels. There are 8 two-wire inputs per card with a 0.64 Hertz, low-pass input filter on each input to attenuate normal-mode noise. Because of the polarized capacitor in the input filter, the normal-mode signal on the 5-volt range is limited to -0.5 volts to +5 volts and the normal-mode overvoltage limit is -1 volt to +6 volts. The input signal can have an equivalent source resistance of 1,000 ohms with a 1,000-ohm source unbalance.

Analog Output

This card generates two points of analog output with a resolution of 9 bits plus sign, or 10 bits. Each output point can be programmed to generate an output voltage up to ± 5 , ± 10 , or 0 through +10 volts full scale, with a long-term stability of $\pm 1/2$ the least significant bit (LSB) per 10,000 hours. The maximum output impedance is 1 ohm; the maximum current output is 5 milliamps at ± 10 volts, and is short-circuit protected.

Chapter 6. User Attachment Features

The user attachment features permit the user to attach his own I/O devices and attachments to an IBM 4952, 4953, or 4955 Processor. This chapter describes the following features:

- Timer
- Teletypewriter Adapter
- Customer Direct Program Control (DPC) Adapter
- Integrated Digital Input/Output, Nonisolated
- Customer Access Panel
- Channel Repower
- Channel Socket Adapter

Timer

This feature provides two 16-bit timers. Each timer can be used as an interval timer, pulse counter, or pulse-duration timer with an end interrupt. The timers are packaged on one printed-circuit card that plugs into either the processor or an I/O expansion unit.

The timer feature can be used with external signals. Each timer has four signal lines that are TTL compatible. Two are input lines:

- Customer clock
- External gate

Two are output lines:

- Run state
- External gate enable

The timers are separately addressable and are started, stopped, read, and set independently under program control. The timers can be read without disturbing their operation; however, to set the timer's value or mode, it must be stopped.

Each timer has a mode register that is used to select one of four internal time bases or an external time base. The timer value is decreased according to the selected time base. The internal time bases are 1, 5, 25, and 50 microseconds. The external time base is provided by the user and must be:

- 20 microseconds or greater when the input is filtered
- 1 microsecond when not filtered

Optional filtering can be selected with jumpers that are built into the timer card. An external-gate-enable bit is also contained in the mode register. The time-base and external-gate-enable bits are program selectable.

Timer (continued)

The following program-selectable running modes are available for each timer:

- *Periodic interrupts—internal*

A 16-bit auto-load register is set to any value by program control. This register automatically reloads the timer when the timer underflows, and an interrupt is generated. This permits generating periodic interrupts on 65,536 possible base values of the timer without program intervention.

- *Aperiodic interrupts—internal*

The timer is loaded with a value under program control, and an interrupt occurs when the timer underflows. After the first interrupt, the timer is *not* reloaded from the auto-load register; therefore, it counts the full 65,536 intervals before the next interrupt occurs unless a new value is loaded under program control.

- *Periodic or aperiodic interrupts—external*

The timer generates periodic or aperiodic interrupts, but starting and stopping the timer is controlled by the external gate when the timer is in the run state.

Teletypewriter Adapter

This feature permits attaching a serial I/O device to the Series/1 by providing a logical subset of the EIA RS232-C interface. The adapter was designed primarily to attach a teletypewriter I/O device such as a Teletype* Model ASR 33, ASR 35, or KSR 33, but can also be used to attach other devices meeting the interface requirements.

Note: The teletypewriter adapter feature must be at Engineering Change (EC) level 375542 if it is to be used to attach a buffered device that generates only one stop bit. Teletypewriter adapter features of any EC level may be used to attach unbuffered devices or buffered devices that can be programmed to generate two stop bits.

Serial I/O Devices

Some of the devices commercially available that can be attached to this interface are:

- Printer keyboards
- Keyboard-display units (such as the IBM 3101 Display Terminal)
- Keyboard-display-printer units
- Printers
- Tape cassettes
- Tape units
- Card readers
- Badge readers
- Plotters

The following interface types can be selected:

- Nonisolated current loop
- Isolated current loop
- EIA voltage-level interface
- TTL voltage-level interface

The “mark” and “space” signal-level convention can also be selected. The teletypewriter adapter uses a four-wire interface for data exchange, two wires for receiving and two for transmitting. Operation is full duplex; that is, data can be transmitted and received concurrently.

* Trademark of the Teletype Corporation

Data Transfer

Data bytes are transmitted across the adapter or device interface serially by bit with the least-significant bit being transmitted first. An 11-bit start-stop frame is used to synchronize each byte. The bit rate is selectable on the feature card with jumper wires. If the attached device is buffered, the program in use might not allow the full bit rate selected on the feature card. Various bit rates are available, as shown below:

Available bit rates (bits per second)

50	300
75	600
100	1200
110	2400
150	4800
200	9600

The teletypewriter adapter feature transmits and receives all 256 binary combinations. The data exchange over the interface is not checked for parity or device-dependent control characters. The adapter can be configured to provide IPL capability.

Data transfer between the adapter and the processor is by byte, using DPC commands; however, during IPL the transfer is by byte, using cycle-steal mode.

Diagnostic capability is designed into the teletypewriter adapter feature. A special command places the adapter in diagnostic-wrap state. A subsequent write command sends data to the device and to the receive data register. The adapter then presents an interrupt so that a read command can be issued to verify that the correct data is sent back to processor storage.

Communication Power Feature

This feature furnishes ± 12 volts and is a prerequisite for the teletypewriter adapter feature *if* the attached device is connected to either the nonisolated current-loop interface or the EIA voltage-level interface. Exceptions to this are when the teletypewriter adapter is plugged into one of the following processors where ± 12 volts is standard:

- 4952 Processor, all models
- 4953 Processor, Models A and C
- 4955 Processor, Model E

The communication power feature is *not* a prerequisite for the teletypewriter adapter *if* the attached device is connected to either the isolated current-loop interface or the TTL voltage-level interface. When the attached device is connected to the isolated current-loop interface, the user must supply power to drive the transmit and receive loops. When the attached device is connected to the TTL interface, normal logic levels present on the teletypewriter adapter card are used to drive the transmit and receive loops.

Customer Direct Program Control (DPC) Adapter

This adapter feature card provides a convenient means of attaching customer equipment to the processor I/O channel. The DPC adapter can be used to attach any of the following:

- Typical digital instruments (such as another computer)
- Data processing I/O equipment (such as low-speed readers, punches, or plotters)
- Commercial data-acquisition systems

The DPC adapter provides no functional capability in a stand-alone configuration.

The customer DPC adapter feature provides the user with a subset of the processor I/O channel. The interface conforms to the processor I/O channel architecture with an additional throughput delay of approximately 2.5 microseconds.

The DPC adapter feature is designed to perform DPC functions only and can be configured to accommodate 4, 8, or 16 I/O device addresses. Consequently, it allows interrupt vectoring for up to 16 interrupting sources. All the devices attached to the DPC adapter share a common interrupt level. The adapter has 75 lines:

- 18 data bus out (two parity bits)
- 18 data bus in (two parity bits)
- 16 interrupt request-in (when configured for 16 I/O device addresses)
- 12 control and response
- 4 modifier bits
- 4 I/O device address bits
- 3 function bits

The data flow contains groups of 16 bits without the parity option, or 18 bits (including two parity bits) with the parity option.

Diagnostic capability is designed into the DPC adapter feature card. This capability allows the user to send data or control information from the processor and “wrap” the same information back to the processor from either the adapter card or from an external I/O device.

The DPC adapter feature uses TTL nonisolated cable drivers with a current capacity of 175 milliamps, allowing a wide range of customer termination schemes.

Integrated Digital Input/Output, Nonisolated

This feature allows the user to:

- Add digital sensor I/O equipment when the 4982 Sensor Input/Output Unit is not required
- Attach simple original equipment manufacturer (OEM) devices

The integrated digital I/O feature contains 32 points (two 16-point groups) of nonisolated digital input/process interrupt (DI/PI) and 32 points (two 16-point groups) of digital output (DO). Each group of 16 points is separately addressable and has 'ready' and 'sync' lines for synchronizing its operation with attached devices. External synchronization is enabled by program control.

Registers

The DI/PI groups have two 16-position registers, one DI register for reading "unlatched" data and one PI register for reading "latched" data. Each position of the DI register follows the state of the corresponding user-input point until the register is read. Each position of the PI register records a 0-to-1 transition at the corresponding user-input point. When a bit in the PI register becomes active, a process interrupt is generated if PI mode was previously armed by program control. The DI/PI points provide voltage sensing to ± 24 volts dc.

Each DO group has a 16-position register. Data is stored in this register under program control. The DO points correspond to the positions of the register. With a user-supplied voltage, each point is rated at a maximum of +52.8 volts dc and 100 milliamps. Without a user-supplied voltage, each point supplies a TTL-compatible output voltage.

Diagnostic Programs

Diagnostic capability is designed into the integrated digital I/O feature. DI/PI groups can be tested with diagnostic commands that disable the user's input lines and force the input data to either 0-bits or 1-bits. Read commands can then be issued to verify that the correct data is sent back to processor storage. DO groups can be tested in a similar manner. A diagnostic command disables the output lines. A special read DO command allows the program to verify data previously sent to the DO group with a write command.

Customer Access Panel

This feature provides an assembly for mounting optional, quick-disconnect connectors for I/O equipment. The assembly can accommodate:

- One timer connector
- One teletypewriter connector
- Up to four connectors for either the integrated digital I/O feature or the customer DPC feature

The assembly can be mounted only behind vacant locations in the 4997 enclosure that are at least 133 millimeters (5.25 inches) high, or behind some card files.

Channel Repower

The channel repower feature repowers and isolates I/O channel along a chain of I/O expansion units. The feature is required when a 4959 I/O Expansion Unit is attached to the following units:

- 4952 Processor, all models
- 4953 Processor, all models
- 4955 Processor, all models, if a 4999 Battery Backup Unit is installed
- All 4959 I/O Expansion Units

The channel repower feature can be a cable connection to a user's attachment or unit. When used for this purpose, the repower feature must be the last series element that is plugged directly into the I/O channel. This last series element could be in either a processor or an I/O expansion unit, depending on the Series/1 configuration.

Channel Socket Adapter

This feature is an IBM printed-circuit card that plugs into the backpanel of a Series/1 processor, or the 4959 I/O Expansion Unit. On the top edge of the printed-circuit card is an industry-standard connector that accepts a user-provided I/O adapter card. The connector makes +5 volts dc at 3 amperes available to power the user's circuits.

Note: The channel socket adapter feature is described in the *IBM Series/1 User's Attachment Manual, GA34-0033*. The adapter converts the 1-millimeter (0.040-inch) IBM backpanel socket to a 1.5-millimeter (0.060-inch) commercially available connector for printed-circuit cards that have tabs on 4-millimeter (0.156-inch) centers. This adapter is intended for the user who builds his own cards.

Chapter 7. Communication Units and Features

This chapter describes the Series/1 communication units and features. These units and features provide a variety of communication options, including several single-line and multiple-line telecommunication capabilities. In addition, there are various combinations of line speeds, line configurations, clocking sources, and data codes to choose from. All of the communication features transfer data to and from the processor in cycle-steal mode, either through direct or indirect attachment to the processor I/O channel.

This chapter describes:

- Data links
- Integrated communication features
- Support features
- 4987 Programmable Communications Subsystem

Data Links

Communication lines operate in one of three types of data links:

- Point-to-point, nonswitched
- Point-to-point, switched
- Multipoint

A point-to-point nonswitched data link, shown in Figure 7-1, is a communication line connecting a single local station and a single remote station in a nonswitchable connection.

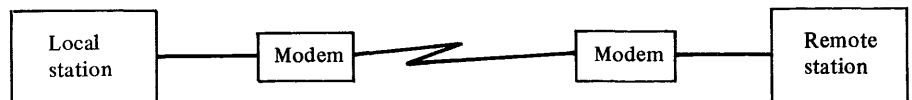

Figure 7-1. Point-to-point nonswitched data link

A point-to-point switched data link, shown in Figure 7-2, is a communication line with one local station that can be switched to any one of several remote stations.

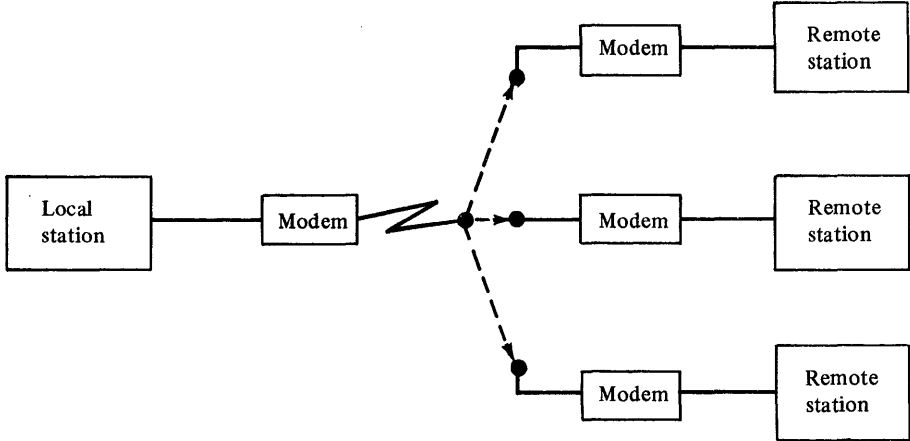

Figure 7-2. Point-to-point switched data link

A multipoint data link, shown in Figure 7-3, is a communication network with a local (control) station physically connected to all remote stations. The control station can communicate by using a poll routine and a unique remote station address. Only the addressed station can respond to the poll.

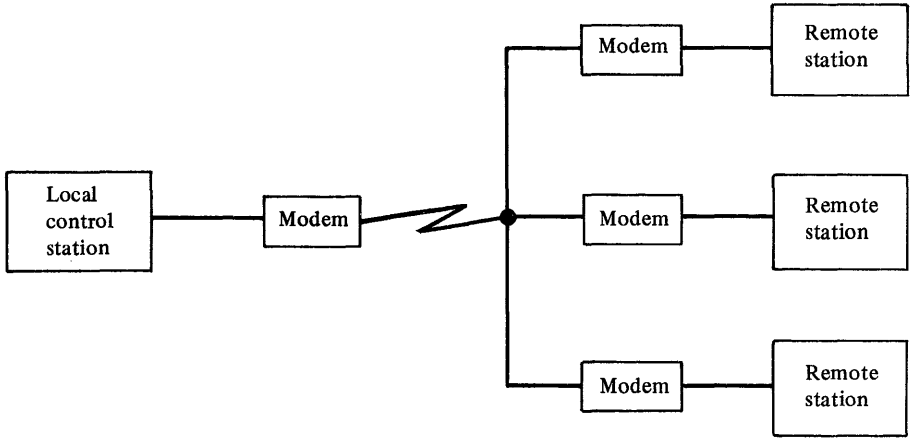

Figure 7-3. Multipoint data link

Integrated Communication Features

These features allow multiple communication lines to be connected directly to the I/O channel. The types of lines discussed are:

- Synchronous data link control
- Binary synchronous
- Asynchronous
- Programmable multi-line

Synchronous Data Link Control (SDLC)

Single-Line Control

This feature is a medium-speed option that allows the Series/1 to communicate with remote terminals and host systems through a modem and a communication line.

Control circuitry is provided for a single half-duplex communication line at data rates up to 9600 bits per second (bps) on a switched or nonswitched basis.

Data transmission is serial-by-bit, using the synchronous data link method of character and bit transmission. Communication can be established with devices using any eight-bit code.

The following communication characteristics apply to SDLC:

- Point-to-point control, nonswitched
- Point-to-point control, switched
- Multipoint control
- Primary station
- Secondary station
- Manual call/answer
- Business machine clocking
- Modem clocking
- Error recovery

Binary Synchronous Communication (BSC)

Single-Line Control (Medium Speed)

This feature is a medium-speed option that allows the Series/1 to communicate with remote terminals and host systems through a modem and a communication line.

Control circuitry for a single half-duplex communication line is provided at data rates up to 9600 bps on a switched or nonswitched basis.

Data transmission is serial-by-bit, using the BSC method of character and bit transmission. ASCII and EBCDIC transmission codes can be used. Transparency is available when using EBCDIC code; that is, characters with the same bit configuration as control characters can be recognized as information by the receiving station without taking on the control meaning.

The following communication characteristics apply to BSC:

- Point-to-point control, switched
- Point-to-point control, nonswitched
- Multipoint
- Primary station
- Secondary station
- Manual call/answer
- IPL (host initiated)
- Business machine clocking
- Modem clocking
- Error recovery

Single-Line Control (High Speed)

This feature is a high-speed option that allows the Series/1 to communicate with remote terminals and host systems through a modem and a communication line.

Control circuitry for a single half-duplex communication line is provided at data rates up to 56,000 bps on a nonswitched basis only.

Data transmission is serial-by-bit, using the BSC method of character and bit transmission.

The following communication characteristics apply:

- Point-to-point control, nonswitched
- Primary station
- Secondary station
- IPL (host initiated)
- Modem clocking
- Error recovery

8-Line Control

This feature provides the control circuitry for up to two BSC 4-line adapters. Data rates are 9600 bps for lines 1 and 2, and, when two BSC 4-line adapters are used, up to 2400 bps on lines 3 through 8. When all four lines are used with a single 4-line adapter, the data rates can be up to 4800 bps per line. Data is transferred to and from the processor in cycle-steal mode.

The communication characteristics of the BSC 8-line control feature are the same as described above for BSC single-line control, except that IPL cannot be performed.

4-Line Adapter

This feature provides the circuitry necessary to accommodate up to four half-duplex communication lines. Data rates depend on the number of lines and the line speed.

This device requires the BSC 8-line control feature to provide control circuitry. When five to eight lines are used, two BSC 4-line adapters are required. The BSC 8-line control feature is described below.

The multiple-line data rates are up to 9600 bps on lines 1 and 2, and, when two 4-line adapters are used, up to 2400 bps on lines 3 through 8. When all four lines are used with a single 4-line adapter, the data rates can be up to 4800 bps per line.

Asynchronous Communication

Single-Line Control

This feature is a medium-speed option that allows the Series/1 to communicate with remote terminals (such as the IBM 3101 Display Terminal) and host systems through a modem and a communication line.

This feature provides the control circuitry for a single half-duplex communication line at data rates up to 9600 bps on a switched or nonswitched basis.

Data transmission is serial-by-bit, using the asynchronous communication start-stop method of character and bit transmission. Applicable transmission codes include PTTC/EBCD, PTTC/Correspondence, and Eight-Bit Data Interchange.

The following communication attributes apply:

- Point-to-point, nonswitched
- Point-to-point, switched
- Multipoint*
- Primary station
- Secondary station*
- Business machine clocking
- No modem clocking
- Error recovery

*This feature does not recognize station addresses. If the feature is to be used as a secondary station in a multipoint network, station address recognition must be provided by programming.

8-Line Control

This feature is an option that allows the Series/1 to communicate with remote terminals (such as the IBM 3101 Display Terminal) and host systems through a modem and up to eight communication lines.

This feature provides the control circuitry for up to two Asynchronous Communications 4-Line Adapters.

The communication attributes of Asynchronous Communication 8-Line Control are the same as discussed above for Asynchronous Communication Single-Line Control.

4-Line Adapter

This feature provides the circuitry to accommodate up to four half-duplex communication lines. Each of these lines can operate at data rates up to 2400 bps.

This device requires Asynchronous Communications 8-Line Control to provide control circuitry. When five to eight lines are used, two Asynchronous Communications 4-Line Adapters are required.

Feature—Programmable Multi-Line Communication

The multi-line adapter and controller make communication programmable when using asynchronous terminals (such as the IBM 3101 Display Terminal) connected to Series/1. Up to eight lines can run at 7200 bps, or at combinations of different speeds.

8-Line Control

This feature provides the control circuitry for up to two Feature—Programmable 4-Line Communications Adapters. The following communication attributes apply to 8-line control:

- Aggregate throughput is 64,000 bps (based on a 12-bit character)
- Point-to-point control, switched
- Point-to-point control, nonswitched
- Multipoint control

4-Line Adapter

This feature provides the circuitry to support up to four communication lines. Each line can be programmed to select:

- Speed—37.5 bps to 1200 bps, or 300 bps to 19,200 bps
- Synchronous or asynchronous operation
- 5, 6, 7, or 8 bits per character
- Odd, even, or no parity checking/generation
- Stop-bit length of 1 or 2
- Synchronous character specification
- Change-of-Direction (COD) character recognition
- Echo-plex operation
- Break character recognition/generation
- Block check character reception (for 1 character)

Each line also has “strap selection” for EIA RS-232-C or current loop interface.

When five to eight lines are used, two 4-line adapters are required.

Support Features

Communications Indicator Panel

This feature is optional for full-width processors and the I/O expansion unit. This panel provides a way to display the various states and conditions of a single selectable communication line, as well as a means of manually controlling certain modem functions.

This panel attaches to any single- or multiple-line control through a connector on the control. The panel has eight switches for selecting lines and displaying information. The eight indicators on the panel can display coded status information and modem control-lines such as 'data set ready,' 'clear to send,' 'transmit,' and 'receive data.'

The panel mounts under the front cover of:

- 4952 Processor, Model B
- 4953 Processor, Models B and D
- 4955 Processor, Models A, B, C, D, and E
- 4959 I/O Expansion Unit

Communications Power Feature

This feature provides the additional ± 12 -volt regulated power required to attach one or more communication feature cards to the processor I/O channel. The communications power feature is *not* required on the following processors, where ± 12 -volt power is standard:

- 4952 Processor, all models
- 4953 Processor, Models A and C
- 4955 Processor, Model E

The communication power feature is required for some applications of the teletypewriter adapter feature. See "Teletypewriter Adapter" in Chapter 6.

4987 Programmable Communications Subsystem

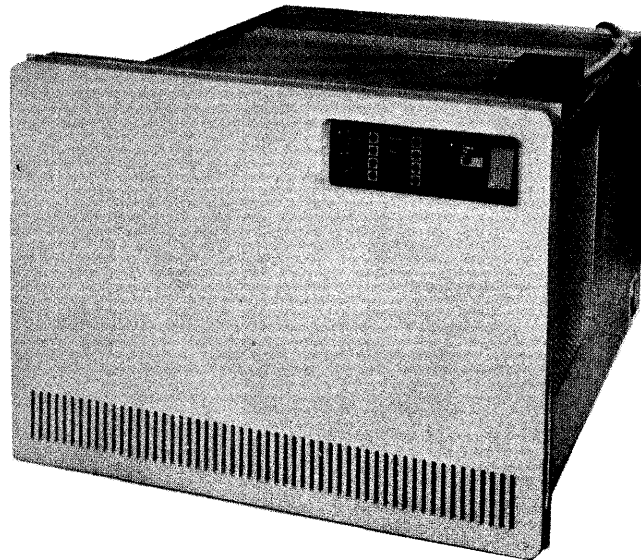

Figure 7-4. 4987 Programmable Communications Subsystem

The 4987 subsystem consists of:

- The subsystem unit (enclosure)
- Controller feature
- Device attachment features

This subsystem, shown in Figure 7-4, provides attachment and control facilities for a variety of communication lines. It may be configured with a single controller/scanner, in which case it can accommodate up to 32 communication lines of mixed-line disciplines at data rates of 45 to 9600 bps. The maximum combined data rate for all communication lines is 4800 characters per second, assuming eight-bit characters.

Multiple subsystems may be attached to the Series/1. By installing a second controller/scanner, a single 4987 can be converted into two units of 16 lines each. Each controller/scanner would have an aggregate data rate of up to 38,400 bps.

For additional information concerning data rate combinations, refer to the *IBM 4987 Programmable Communications Subsystem and 4990 Model 1 Communications Console for the 4987 Description*, GA34-0049.

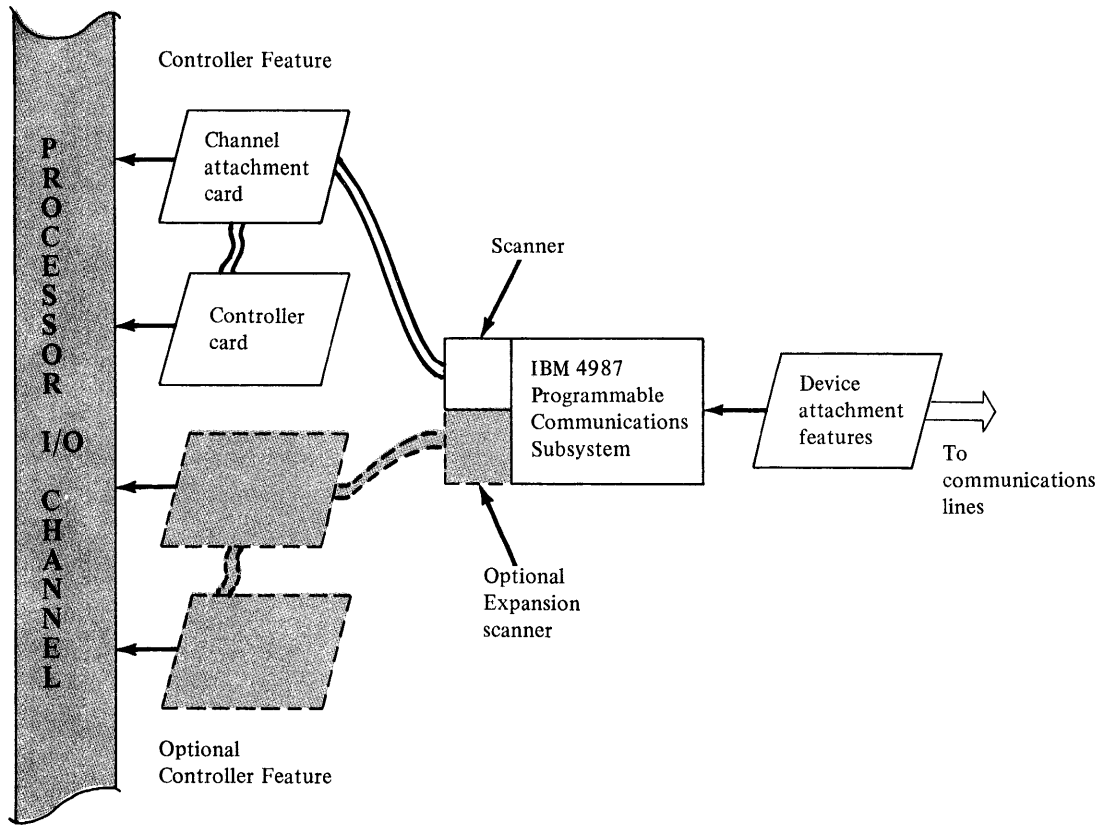

Figure 7-5. Block diagram of a 4987 Programmable Communications Subsystem

The 4987 attaches to the Series/1 by means of the Programmable Communications Subsystem Controller. This is a two-card feature that plugs directly into either a processor or an I/O expansion unit, requiring two I/O feature card sockets. This subsystem provides an improved price-to-performance ratio for large communication applications by:

- Reducing the required number of I/O feature card sockets
- Reducing processor overhead by performing basic program-controlled tasks at the unit level

A block diagram of the 4987 is shown in Figure 7-5.

Subsystem Unit

The 4987 enclosure contains a power supply, space for two scanner cards, a backplane, an indicator panel, receptacles for an optional console, and space for 16 device-attachment feature cards. The 4987 device attachment feature card sockets (rear view) are shown in Figure 7-6.

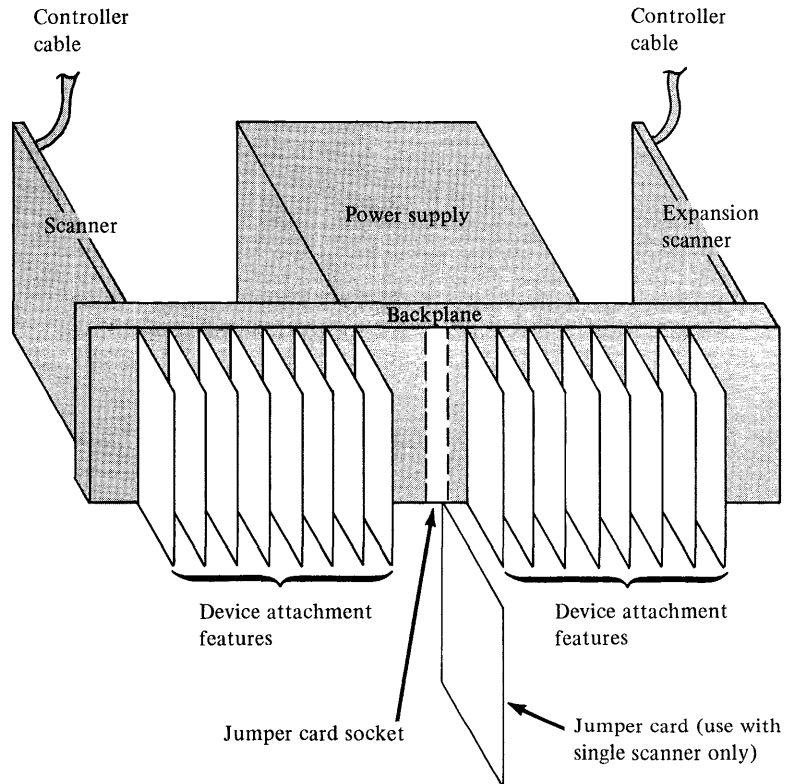

Figure 7-6. 4987 device attachment feature card sockets (rear view)

The backplane is a circuit board mounted across the middle of the subsystem unit that provides the connections between the scanner card, power supply, and the 32 device interfaces. There are two interfaces for each device-attachment card socket. The scanner card is plugged into the front of the backplane, and the device attachment features plug into the rear of the backplane. The backplane is divided into two halves that are connected by a jumper card when one scanner is used. This card is removed when two scanners are used.

A panel on the front of the subsystem unit contains controls and indicators. These controls and indicators are described later in this chapter.

The scanner is a programmable circuit card that performs the multiplexing and serializing/deserializing functions for the 4987 subsystem. The scanner connects to each of the device attachment cards, monitors the timing of data, and presents service requests to the controller.

The scanner contains the storage and logic functions that allow it to be programmed with parameters for line frequency, bit rate, and bits per character. Using these programmed parameters, the scanner addresses each active line, in turn, and either assembles characters (when receiving) or sends bits (when transmitting). It also signals the controller when a character is needed for transmission, or when a character has been assembled and is available for storage. An expansion scanner (second scanner) is available as an optional feature and requires a second controller.

Programmable Communications Subsystem Controller Feature

This feature connects the scanner card to the processor I/O channel, and is two cards: the controller card and the channel attachment card. These cards can reside in either a processor or an I/O expansion unit and require adjacent slots.

The communication program designed by the user loads the controller's read-only storage with line definitions, controller orders, and tables of special characters. A microprocessor interprets the orders and the line definitions, causing the Programmable Communications Subsystem to transfer data and control lines as required. Controller-to-channel functions are also directed by the microprocessor.

Device Attachment Features

These features provide the line drivers, receivers, and logic required to attach the scanner to the communication lines. Physically, any of the attachment features can be plugged into the backplane. Each feature card socket provides two device addresses that are logically independent. Some device attachment features provide two independent line addresses; some provide only one address, preempting the second address. This allows a maximum of 32 communication lines to be plugged into the 16 feature card sockets.

The device attachment features are:

- Half-Duplex Data Set Attachment
- Asynchronous Local Attachment
- Synchronous Local Attachment
- Autocall Attachment (with half-duplex attachment)
- Teletypewriter Current Attachment (isolated current loop)
- 1200 bps Integrated Modem for Asynchronous Switched Network (U.S.)
- 1200 bps Integrated Modem for Asynchronous Leased Line with Switched Network Backup (U.S.)
- 1200 bps Integrated Modem for Asynchronous Leased Line (U.S.)
- 1200 bps Integrated Modem for Asynchronous Leased Line (International)
- 1200 bps Integrated Modem with Clock for Synchronous Switched Network (U.S.)
- 1200 bps Integrated Modem with Clock for Synchronous Leased Line with Switched Network Backup (U.S.)
- 1200 bps Integrated Modem with Clock for Synchronous Leased Line (U.S.)
- 1200 bps Integrated Modem with Clock for Synchronous Leased Line (International)
- DATA-PHONE Digital Service Attachment
- Full-Duplex Data Set Attachment

An EIA Extension Cable is also available.

Half-Duplex Data Set Attachment

This feature provides two interfaces, each with its own device address, for direct connection of two independent switched or nonswitched external modems. The interfaces are designed according to the specifications of EIA RS-232-C and CCITT* V.24 and V.28, operate only in half-duplex mode, and can be used in asynchronous or synchronous networks (such as those that attach an IBM 3101 Display Terminal to a Series/1). Synchronous network applications require modem clocking and the maximum data rate is 9600 bps. Two 6-meter (20-foot) cables with connectors are included.

* International Telephone and Telegraph Consultative Committee

Asynchronous Local Attachment

This feature provides two interfaces, each with its own address, for direct connection of local asynchronous terminals or I/O devices (such as an IBM 3101 Display Terminal). The interfaces are designed according to the specifications of EIA RS-232-C and CCITT V.24 and V.28. The attachment operates only in half-duplex mode at programmable data rates from 45 to 1200 bps, and at 2400, 4800, or 9600 bps. Modems are not required with this interface. Two 6-meter (20-foot) cables with appropriate connectors are provided.

Synchronous Local Attachment

This feature provides two interfaces, each with its own device address, for direct connection of local synchronous terminals or I/O devices. The interfaces are designed according to the specifications of EIA RS-232C and CCITT V.24 and V.28. Transmit and receive clocks are provided for both the scanner and the attached device. Modems are not required with these interfaces.

The data rate for each device is individually selectable, but transmit and receive rates within a device must be the same. The attachment operates only in half-duplex mode at data rates of 600, 1200, 2400, 4800, and 9600 bps. This device attachment cannot be used for bit-synchronous disciplines like SDLC. Two 6-meter (20-foot) cables with appropriate connectors are provided.

Autocall Attachment

This feature provides one automatic calling unit interface and one interface to connect to an external modem. Each interface has its own device address. The automatic calling unit interface is designed according to the specifications of EIA RS-366. It can be used with an IBM 3872 Modem, IBM 3874 Modem, or Western Electric Type 801 (or equivalent) automatic calling unit. The modem interface is identical to the half-duplex data set attachment. Two 6-meter (20-foot) cables with appropriate connectors are provided.

Teletypewriter Current Attachment (isolated current loop)

This feature provides two unipolar direct-current (dc) loop interfaces, each with its own device address, for connection to teletypewriters or devices such as an IBM 3101 Display Terminal. The interfaces provide for half-duplex operations with either a 2-wire or 4-wire connection option. A programmable local-copy option is supported in the 4-wire operation. This feature requires an external current source and operates at speeds of 45 to 1200 bps, and at 2400, 4800, and 9600 bps. Two 6-meter (20-foot) cables with appropriate connectors are provided.

1200 bps Integrated Modem for Asynchronous Switched Network (U.S.)

This feature provides a complete switched-network modem. The functions include auto answer, auto-answer test, wrap test, and manual answer. The modem is intended for asynchronous operation only, at speeds of 45 to 1200 bps. This feature uses one device address but requires a second device address in the 4987. A 6-meter (20-foot) cable with appropriate connectors is provided.

1200 bps Integrated Modem for Asynchronous Leased Line with Switched Network Backup (U.S.)

This feature provides a complete leased-line modem with switched-network backup auto-answer capability. Auto-answer test and wrap test are included. The modem is intended for asynchronous operation only, at speeds of 45 to 1200 bps. This feature requires two device addresses; one is used when operating in half-duplex mode, and both are used when operating in full-duplex (4-wire) mode. A 6-meter (20-foot) cable with appropriate connectors is provided.

1200 bps Integrated Modem for Asynchronous Leased Line (U.S.)

This feature provides a complete leased-line modem with a wrap test. The modem is intended for asynchronous operation only, at speeds of 45 to 1200 bps. This feature requires two device addresses; one is used when operating in half-duplex mode, and both are used when operating in full-duplex (4-wire) mode. A 6-meter (20-foot) cable with appropriate connectors is provided.

1200 bps Integrated Modem for Asynchronous Leased Line (International)

This feature provides a complete leased-line modem with a wrap test. The modem is intended for asynchronous operation only, at speeds of 45 to 1200 bps. This feature requires two device addresses; one is used when operating in half-duplex mode, and both are used when operating in full-duplex (4-wire) mode. A 6-meter (20-foot) cable with appropriate connectors is provided.

1200 bps Integrated Modem with Clock for Synchronous Switched Network (U.S.)

This feature provides a complete switched-network modem for synchronous operation at program-selectable speeds of 600 or 1200 bps. The functions include auto answer, auto-answer test, wrap test, and manual answer. This feature uses one device address but requires a second device address in the 4987. A 6-meter (20-foot) cable with appropriate connectors is provided.

1200 bps Integrated Modem with Clock for Synchronous Leased Line and Switched Network Backup (U.S.)

This feature provides a complete leased-line modem with switched-network backup auto-answer capability. Auto-answer test and wrap test are included. The modem is intended for synchronous operation only, at program-selectable speeds of 600 or 1200 bps. Timing logic required for connection to communication lines in configurations that require business-machine clocking is included. This feature requires two device addresses; one is used when operating in half-duplex mode, and both are used when operating in full-duplex (4-wire) mode. A 6-meter (20-foot) cable with appropriate connectors is provided.

1200 bps Integrated Modem with Clock for Synchronous Leased Line (U.S.)

This feature provides a complete leased-line modem with a wrap test. The modem is intended for synchronous operation only, at program-selectable speeds of 600 or 1200 bps. Timing logic required for connection to communication lines in configurations that require business-machine clocking is included. This feature requires two device addresses; one is used when operating in half-duplex mode, and both are used when operating in full-duplex (4-wire) mode. A 6-meter (20-foot) cable with appropriate connectors is provided.

1200 bps Integrated Modem with Clock for Synchronous Leased Line (International)

This feature provides a complete leased-line modem for synchronous operation. The modem is intended for synchronous operation only, at program-selectable speeds of 600 or 1200 bps. Timing logic required for connection to communication lines in configurations that require business-machine clocking is included. This feature requires two device addresses; one is used when operating in half-duplex mode, and both are used when operating in full-duplex (4-wire) mode. A 6-meter (20-foot) cable with appropriate connectors is provided.

DATA-PHONE Digital Service Attachment

This feature provides an interface to the DATA-PHONE Digital Service, a service of the Bell Telephone System, and attaches to a nonswitched network through a channel service unit. This feature operates in synchronous mode only, at data rates of 2400, 4800, or 9600 bps for non-SDLC synchronous disciplines. The network provides clocking. This feature requires two device addresses; one is used when operating in half-duplex mode, and both are used when operating in full-duplex (4-wire) mode. A 6-meter (20-foot) cable with appropriate connectors is provided.

Full-Duplex Data Set Attachment

This feature is designed according to the specification of EIA RS-232C or CCITT V.24 or V.28, provides a full-duplex interface for simultaneous transmission and reception, and requires an external full-duplex data set or modem. The feature operates in asynchronous mode at data rates of 45 to 1200 bps, and at 2400, 4800, and 9600 bps; split-speed operation is permitted. The feature operates in synchronous mode at speeds up to 9600 bps with modem clocking. This feature requires two device addresses: one for transmitting and one for receiving. A 6-meter (20-foot) cable with appropriate connectors is included. This feature also allows an IBM 3101 Display Terminal to be attached to a Series/1.

EIA Extension Cable

This feature provides additional cables with appropriate connectors. Each cable is 6 meters (20 feet) long. The number of extension cables that can be attached depends on (1) the drive capability of the devices at each end, and (2) the bit rate and communication mode used. For additional information, refer to *IBM 4987 Programmable Communications Subsystem and 4990 Model 1 Communications Console for the 4987 Description*, GA34-0049.

Indicator Panel

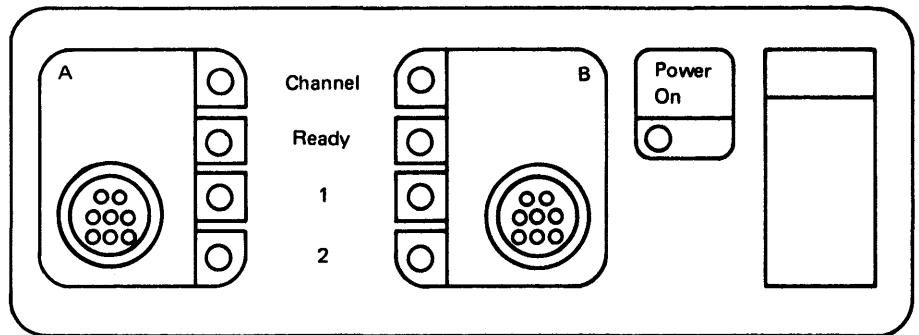

Figure 7-7. Indicator panel

As shown in Figure 7-7, there are two groups of indicators on the panel:

- Group A displays the status of the expansion scanner.
- Group B displays the status of the basic scanner.

Two eight-pin receptacles permit attaching the 4990 Model 1 Communications Console to either scanner network.

4990 Communications Console for the 4987



Figure 7-8. 4990 Model 1 Communications Console for the 4987

This console, shown in Figure 7-8, has a functional keyboard and a set of indicators for problem diagnosis. A 2-meter (6-foot) cable connects the console to the scanner card through the indicator panel. The console enables the user to display the status of communication lines, and display or alter the following:

- Line interface information
- Controller storage
- Diagnostic data

If two scanners are installed, the console can be used with either scanner by plugging it into the appropriate receptacle. A single 4990 Communications Console can be used on multiple subsystems by plugging it into the appropriate unit.

Chapter 8. Additional Units and Features

This chapter describes the following Series/1 units and features:

- **4993 Series/1—System/370 Termination Enclosure**
- **4997 Rack Enclosure**
- **4999 Battery Backup Unit**
- **5250 Information Display System Attachment Feature**

This page intentionally left blank.

4993 Series/1—System/370 Termination Enclosure

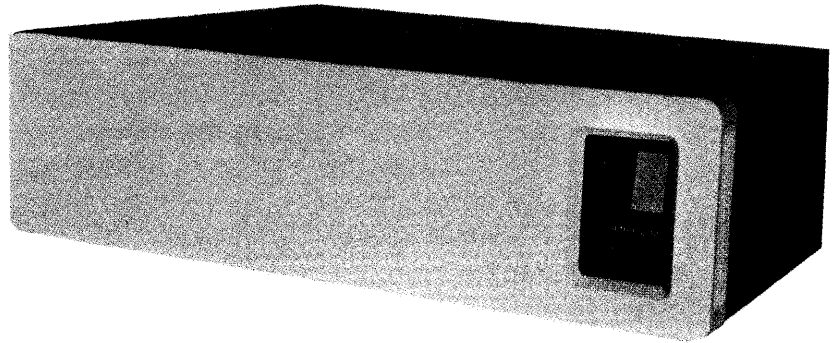

Figure 8-1. 4993 Series/1—System/370 Termination Enclosure

This unit, shown in Figure 8-1, provides communication between a Series/1 and either:

- A System/370 (Models 135–168), or
- A 3031, 3032, or 3033 Processor

A selector or block-multiplexer channel (IBM 2860 Selector Channel or IBM 2880 Block Multiplexor Channel) is supported only on Models 165 and 168.

It appears as an I/O unit to the Series/1 and a control unit to the System/370. The attachment feature responds to Series/1 and System/370 instructions.

This device and its attachment feature allow the Series/1 to function as a front-end processor to a System/370 in typical realtime applications for:

- Graphics processing
- Teleprocessing concentration
- Sensor I/O processing

Data transfer is under control of both processors; the maximum data transfer rate is 300,000 bytes per second.

The Series/1—System/370 attachment consists of:

- 4993 Series/1—System/370 Termination Enclosure
- Series/1—System/370 Channel Attachment Feature

The 4993 attaches to the Series/1 by means of the Series/1—System/370 Channel Attachment Feature. This feature card can be plugged into either the processor unit or an I/O expansion unit. See Figure 8-2 for a block diagram of the unit.

Note: The 4993 responds to a subset of the IBM 3272 Control Unit channel commands. For further information, see *IBM Series/1—System/370 Channel Attachment Feature and 4993 Model 1 Series/1—System/370 Termination Enclosure Description, GA34-0057.*

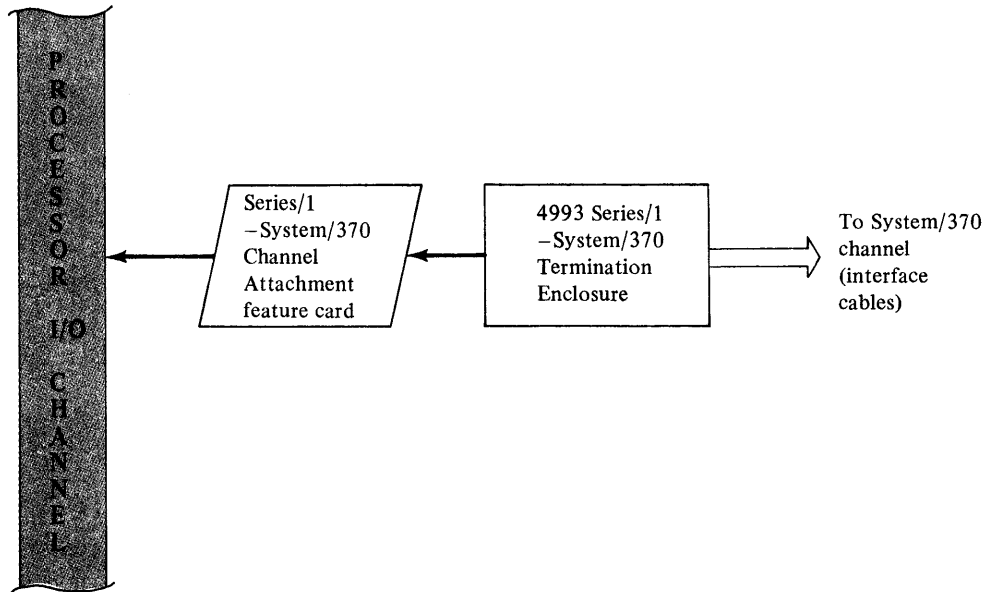

Figure 8-2. Block diagram of 4993 Series/1—System/370 Termination Enclosure

The 4993 enclosure has an operator panel to control unit power and online/offline switching. This unit and its attachment feature logically appear as a cycle-steal device to the Series/1 processor. It requires one control unit position on the System/370 interface and provides 32 I/O device addresses.

The Series/1—System/370 Attachment is connected to the System/370 I/O channel by System/370 interface cables.

4997 Rack Enclosure

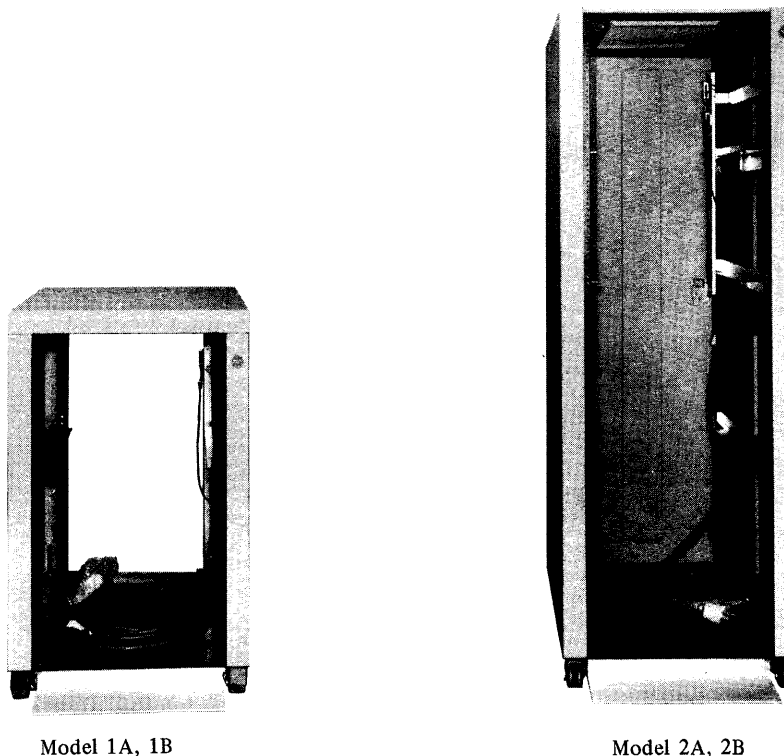

Figure 8-3. 4997 Rack Enclosure models

This enclosure, shown in Figure 8-3, provides mounting space for IBM Series/1 modular units. It has EIA (RS-310B) rack-mounting dimensions for housing standard 483-millimeter (19-inch) rack units. It is available in two sizes, with two model designations for each size.

Models 1A and 1B can hold two full-width modular units or comparable combinations of full- and half-width modular units (limited to one 4962 Disk Storage Unit). The enclosure is 1 meter (39.4 inches) high, 0.61 meter (24 inches) wide, and 0.75 meter (29.5 inches) deep.

Models 2A and 2B can hold four full-width modular units or a comparable combination of full and half-width modular units (limited to two 4962 Disk Storage Units, two 4963 Disk Storage Units, or two 4969 Magnetic Tape Units). The enclosure is 1.8 meters (70 inches) high, 0.61 meter (24 inches) wide, and 0.75 meter (29.5 inches) deep.

4969 Magnetic Tape Units ordered as part of an IBM Series/1 System will be shipped installed in a 4997-Model 2 rack enclosure. Units not ordered with an enclosure will be shipped in a frame (pallet mounted).

Plain front filler panels are provided with Models 1A and 2A, as required; decorative front filler panels are provided with Models 1B and 2B, as required.

A rack-mounting fixture is available for mounting half-width modular units. This optional feature can hold two half-width units.

All models of the 4997 Rack Enclosure provide an ac-power distribution system. The distribution system contains a 20-ampere circuit breaker and either four outlets (Models 1A, 1B) or eight outlets (Models 2A, 2B) mounted vertically at the rear of the enclosure. On the front frame of all enclosures is an instant-power-off switch labeled Emergency Pull. This is a manual control that turns off all power by tripping the main circuit breaker.

Each enclosure has removable side covers, and a rear door. A multibay enclosure can be assembled by removing the side covers and fastening the units together.

This page intentionally left blank.

4999 Battery Backup Unit

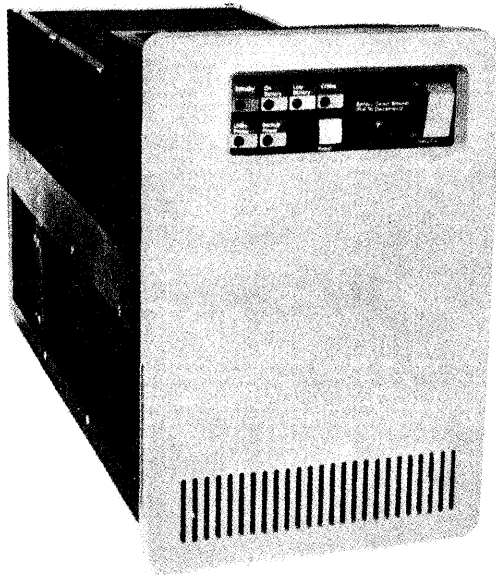

Figure 8-4. 4999 Battery Backup Unit

This unit, shown in Figure 8-4, supplies emergency ac power to the following when primary power is inadequate or temporarily lost:

- A 4952 Processor, Model B, if the ac power consumption, corrected for power factor, does not exceed 800 VA (530 watts square wave)
- A fully populated 4953 Processor, Models A, B, C, D
- A fully populated 4955 Processor, Models A, B, C, D
- A 4955 Processor, Model E, if the ac power consumption, corrected for power factor does not exceed 800 VA (530 watts square wave)

The 4999 does not support a 4952 Processor, Model A.

The 4999 is available in two models based on the operating voltage of the processor:

- Model 1—for 100–123.5 volts ac, 50/60 Hz power
- Model 2—for 200–230 volts ac, 50/60 Hz power

Both models are half-width modular units designed for rack mounting by using the rack-mounting feature.

Utility power is supplied to the Series/1 Processor through connections on the 4999 Battery Backup Unit. This power is monitored by the unit and, in the event of a power failure, the input power to the Battery Backup Unit is automatically replaced by 12-volt battery power. The battery and charger are supplied by the user. The battery power is inverted from dc to ac and supplied to the processor as square-wave ac power at the required voltage level.

A primary power failure produces a class interrupt in the processor and turns on a status bit that remains on as long as power is being supplied by the battery.

The backup unit can support only the processor. (A customer-supplied 100 ampere-hour battery can power the processor for 20 to 60 minutes.)

Operator Panel

The 4999 Battery Backup Unit has controls and indicators that allow manual power control and automatic monitoring of the unit. These controls and indicators include:

- Utility Power On/Off switch
- Battery circuit breaker
- Reset pushbutton
- Utility Power indicator
- Standby indicator
- On-Battery indicator
- Low Battery indicator
- Offline indicator

5250 Information Display System Attachment Feature

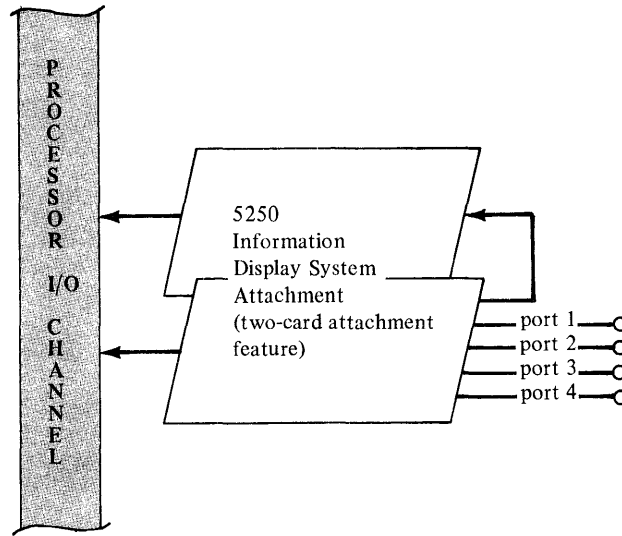

Figure 8-5. 5250 Information Display System Attachment feature

This attachment, as shown in Figure 8-5, consists of two cards that plug into adjacent card sockets of a Series/1 processor or an I/O Expansion Unit. It provides four ports to which the following 5250 work stations may be attached through twinax cabling:

- 5251 Display Station, Models 1 and 11
- 5252 Dual Display Station, Model 1
- 5256 Printer, Models 1, 2, and 3

A maximum of seven work stations, in any combination, may be attached to any single port using a Cable Thru feature on the 5251, 5252, or 5256. The maximum length of twinax cable that can be connected to each attachment feature port is 1524 meters (5,000 feet).

The maximum number of 5250 work stations that can be attached to a single attachment feature is eight. Each 5251 and 5256 counts as one work station while each 5252 counts as two work stations. For example, if port 1 has seven work stations attached to it, only one additional 5250 work station (attached to either port 2, 3, or 4) can be added to this attachment feature.

For further information about the 5250 Information Display System, refer to *IBM 5250 Information Display Station, Introduction*, GA21-9246.

Appendix A. Series/1 Hardware

This appendix is a partial list of the feature numbers and machine types for Series/1 hardware. The symbol # precedes the feature numbers; all other numbers are IBM machine types. Additional features, such as cables, are listed in *IBM Series/1 Configurator*, GA34-0042, and in *IBM Series/1 Customer Site Preparation Manual*, GA34-0050.

Number Name

PROCESSORS AND I/O EXPANSION UNIT

4952-A	Processor Unit, 32K bytes (128K max), 5 I/O feature card sockets
4952-B	Processor Unit, 32K bytes (128K max), 14 I/O feature card sockets
4953-A	Processor Unit, 16K bytes (64K max), 4 I/O feature card sockets
4953-B	Processor Unit, 16K bytes (64K max), 13 I/O feature card sockets
4953-C	Processor Unit, 32K bytes (64K max), 4 I/O feature card sockets
4953-D	Processor Unit, 32K bytes (64K max), 13 I/O feature card sockets
4955-A	Processor Unit, 16K bytes (64K max), 8 I/O feature card sockets
4955-B	Processor Unit, 16K bytes (128K max), 3 I/O feature card sockets
4955-C	Processor Unit, 32K bytes (64K max), 10 I/O feature card sockets
4955-D	Processor Unit, 32K bytes (128K max), 7 I/O feature card sockets
4955-E	Processor Unit, 64K bytes (256K max), 7 I/O feature card sockets
4959-A	I/O Expansion Unit
#7900	Two Channel Switch

PROCESSOR FEATURES

#3920	Floating Point (4955 only)
#5650	Programmer Console
#6335	Storage Address Relocation Translator (4955 Models B & D only)

STORAGE ADDITIONS

#6306	Storage Addition module, 32K bytes (4952 all models)
#6315	Storage Addition, 16K bytes (4953 all models)
#6316	Storage Addition, 32K bytes (4953 Models C and D)
#6325	Storage Addition, 16K bytes (4955 Models A, B, C, and D)
#6326	Storage Addition, 32K bytes (4955 Models C, D, and E)
#6327	Storage Addition, 64K bytes (4955 Model E)

DISK, DISKETTE, AND MAGNETIC TAPE UNITS

4962-1 Disk Storage Unit, 9,300,000 bytes
4962-1F Disk Storage Unit, 9,300,000 bytes (with fixed heads)
4962-2 Disk Storage Unit, 9,300,000 bytes (with diskette drive)
4962-2F Disk Storage Unit, 9,300,000 bytes (with fixed heads and diskette drive)
4962-3 Disk Storage Unit, 13,900,000 bytes
4962-4 Disk Storage Unit, 13,900,000 bytes (with diskette drive)
#3580 4962 Disk Storage Unit Attachment

4963 Disk Subsystem
4963-23A Primary Disk Storage Unit, 23,500,000 bytes (with fixed heads)
4963-23B Expansion Disk Storage Unit, 23,500,000 bytes (with fixed heads)
4963-29A Primary Disk Storage Unit, 29,300,000 bytes
4963-29B Expansion Disk Storage Unit, 29,300,000 bytes
4963-58A Primary Disk Storage Unit, 58,700,000 bytes (with fixed heads)
4963-58B Expansion Disk Storage Unit, 58,700,000 bytes (with fixed heads)
4963-64A Primary Disk Storage Unit, 64,500,000 bytes
4963-64B Expansion Disk Storage Unit, 64,500,000 bytes
#3590 4963 Disk Subsystem Attachment

4964-1 Diskette Unit
#3581 4964 Diskette Unit Attachment

4966-1 Diskette Magazine Unit
#1205 4966 Diskette Magazine Unit Attachment

4969 Magnetic Tape Subsystem
4969-04D Magnetic Tape Unit
4969-04N Magnetic Tape Unit
4969-04P Magnetic Tape Unit
4969-07D Magnetic Tape Unit
4969-07N Magnetic Tape Unit
4969-07P Magnetic Tape Unit
#1215 4969 Magnetic Tape Subsystem Attachment
#1540 Tape Controller, NRZI
#1545 Tape Controller, PE
#1550 Tape Controller, Dual

#9273 Factory mounted in a 4997-Model 2 Rack Enclosure
#9274 Unit shipped in a frame, pallet mounted (not physically mountable by IBM due to size and weight), in an existing enclosure

PRINTERS AND DISPLAY UNIT

4973-1 Line Printer Unit (150 lines/minute)
4973-2 Line Printer Unit (400 lines/minute)
#5630 4973 Line Printer Attachment

4974-1 Printer Unit (120 character/second)
#5620 4974 Printer Attachment

4979-1 Display Station
#3585 4979 Display Station Attachment

SENSOR I/O UNIT

4982-1 Sensor I/O Unit (capacity for up to 8 sensor I/O cards)
#6305 4982 Sensor I/O Unit Attachment
#1060 Analog Input Control
#1065 Analog Output (2 points)
#1070 Amplifier Multirange
#3525 Digital Input/Process Interrupt Nonisolated (16 points)
#3532 Digital Input/Process Interrupt Isolated (16 points)
#3535 Digital Output Nonisolated (16 points)
#4940 Multiplexer/Reed-Relay (8 channels)
#4950 Multiplexer/Solid-State (16 channels)

USER ATTACHMENT FEATURES

- #1560 Integrated Digital Input/Output Nonisolated
(32 DI points; 32 DO points)
- #1565 Channel Repower
- #1595 Channel Socket Adapter
- #5430 Customer Direct Program Control Adapter
- #7840 Timers (two per card)
- #7850 Teletypewriter Adapter

COMMUNICATION

- #1610 Asynchronous Communications Single Line Control (9600 bps)
- #2074 Binary Synchronous Communications Single Line Control (9600 bps)
- #2075 Binary Synchronous Communications Single Line Control/High Speed
(56,000 bps)
- #2090 Synchronous Data Link Communications Single Line Control (9600 bps)
- #2091 Asynchronous Communications 8-Line Control
- #2092 Asynchronous Communications 4-Line Adapter
- #2093 Binary Synchronous Communications 8-Line Control
- #2094 Binary Synchronous Communications 4-Line Adapter
- #2095 Feature—Programmable 8-Line Communications Control
- #2096 Feature—Programmable 4-Line Communications Adapter
- #2000 Communications Indicator Panel
- #2010 Communications Power
- 4987-1 Programmable Communications Subsystem
- #1300 Programmable Communications Subsystem Controller
- #3600 Expansion Scanner
- #4700 Half-Duplex Data Set Attachment
- #4701 Full-Duplex Data Set Attachment
- #4704 Teletypewriter Current Attachment
- #4706 DATA-PHONE Digital Service Attachment
- #4709 Asynchronous Local Attachment
- #4710 Synchronous Local Attachment
- #4713 Autocall Attachment (with half-duplex attachment)
- #4716 1200 bps Integrated Modem for Asynchronous Switched Network (U.S.)
- #4717 1200 bps Integrated Modem for Asynchronous Leased Line with Switched
Network Backup (U.S.)
- #4718 1200 bps Integrated Modem for Asynchronous Leased Line (U.S.)
- #4719 1200 bps Integrated Modem for Asynchronous Leased Line (International)
- #4721 1200 bps Integrated Modem with Clock for Synchronous Switched
Network (U.S.)
- #4722 1200 bps Integrated Modem with
Switched Network Backup (U.S.)
- #4723 1200 bps Integrated Modem with Clock for Synchronous Leased Line
(U.S.)
- #4724 1200 bps Integrated Modem with Clock for Synchronous Leased Line
(International)
- 4990-1 Communications Console for the 4987

ADDITIONAL UNITS AND FEATURES

- 4993-1 Series/1—System/370 Termination Enclosure
- #1200 Series/1—System/370 Channel Attachment
- 4997-1A Rack Enclosure Unit, 1-meter high (plain filler panels)
- 4997-1B Rack Enclosure Unit, 1-meter high (decorative filler panels)
- 4997-2A Rack Enclosure Unit, 1.8-meters high (plain filler panels)
- 4997-2B Rack Enclosure Unit, 1.8-meters high (decorative filler panels)
- 4999-1 Battery Backup Unit (for 100-123.5 volt ac systems)
- 4999-2 Battery Backup Unit (for 200-235 volt ac systems)
- #1210 5250 Information Display System Attachment

AUXILIARY FEATURES

- #1590 Customer Access Panel
- #4540 Rack mounting fixture

Appendix B. IBM 4978 Display Station RPQ

RPQs (requests for price quotation) are alterations and additions that IBM has made available because of such customer requests. This appendix describes the 4978 Display Station and the special keyboards available for attachment to Series/1. Please contact the nearest IBM Branch Office for additional information about this product.

4978 Display Station RPQ

The 4978 Display Station is a tabletop unit that has a cathode ray tube (CRT) display. When this unit is used with a keyboard, the display station allows the user to (1) enter, modify, and delete data on the CRT, and (2) transfer the displayed data to the processor. Specific functions available depend upon the keyboard selected by the user. Several keyboards are available to permit a variety of display station configurations. Physical key arrangements are fixed for a given keyboard but the role of each key can be modified by recoding user-accessible tables in the 4978 Display Station Attachment RPQ, which is required to attach the 4978 to the Series/1. The attachment card can be plugged into either the processor or an I/O expansion unit. The 4978 Display Support Programming RPQ is also available for this device.

- ACC (*see* asynchronous communications)
- access panel, customer 6-7
- adapter feature, socket 6-9
- additional units and features
 - overview 8-1
 - 4993 Series/1–System/370 Termination Enclosure
 - description 8-3
 - overview 1-14
 - 4997 Rack Enclosure
 - description 8-5
 - overview 1-14
 - 4999 Battery Backup Unit
 - description 8-9
 - overview 1-14
 - 5250 Information Display System Attachment
 - description 8-11
 - overview 1-14
- address key register
 - 4952 Processor 2-10
 - 4955 Processor 2-21
- address register, instruction 2-5
- addressing modes 2-7
- addressing scheme (processor) 2-3
- amplifier multirange card (4982) 5-9
- analog input (AI)
 - amplifier multirange card 5-9
 - control card 5-8
 - general information 5-3
 - multiplexer/reed-relay card 5-9
 - multiplexer/solid-state card 5-9
 - subsystem 5-8
- analog-input (AI) subsystem 5-8
- analog output (AO) feature
 - description 5-10
 - general information 5-5
- aperiodic interrupts (timers) 6-2
- assignments, card plugging (*see* card plugging assignments)
- asynchronous communication
 - overview 1-12
 - single-line control 7-6
 - 4-line adapter 7-6
 - 8-line control 7-6
- asynchronous local attachment 7-14
- attachment features (*see* features)
- auto-answer, 4987 7-14
- autocall attachment 7-14

- backplane 7-11
- basic console (processor) 2-3
- basic features
 - common to all processor 2-3
 - 4952 Processor 2-10
 - 4953 Processor 2-14
 - 4955 Processor 2-18
- battery backup unit
 - description 8-9
 - overview 1-14
- binary synchronous communication (BSC)
 - overview 1-12
 - single-line control (high speeds) 7-4
 - single-line control (medium speed) 7-4
 - 4-line adapter 7-5
 - 8-line control 7-5
- BSC (*see* binary synchronous communication)
- byte (defined) 2-7

- card plugging assignments
 - 4952 Processor 2-12
 - 4953 Processor 2-16
 - 4955 Processor 2-20
 - 4959 Input/Output Expansion Unit 2-24
 - 4959 Input/Output Expansion Unit and TCS Feature 2-25
 - 4982 Sensor Input/Output Unit 5-6
 - 4987 Programmable Communications Subsystem 7-11
- card sockets (*see also* card plugging assignments)
- channel capability
 - overview 2-2
 - 4952 Processor 2-12
 - 4953 Processor 2-14
 - 4955 Processor 2-21
- channel repower feature 6-8
- Channel Socket Adapter 6-9
- character sets
 - 4973 Line Printer 4-4
 - 4974 Printer 4-7
 - 4979 Display Station 4-9
- circuit card, 4987 programmable 7-12
- class interrupts
 - general information 2-4
 - 4952 Processor 2-10
 - 4953 Processor 2-14
 - 4955 Processor 2-18
- common characteristics (of processors) 2-3
- communication data links
 - multipoint 7-2
 - point-to-point, nonswitched 7-1
 - point-to-point, switched 7-2
- communication features for processor I/O channel
 - asynchronous communication 7-6
 - binary synchronous communication (BSC) 7-4
 - data links 7-1
 - overview 1-12
 - programmable multi-line 7-7
 - support features 7-8
 - synchronous data link control (SDLC) 7-3
- communication features for programmable subsystem
 - asynchronous local attachment 7-14
 - autocall attachment 7-14
 - DATA-PHONE digital service attachment 7-16
 - EIA extension cable 7-16
 - full-duplex data set attachment 7-16
 - half-duplex data set attachment 7-13
 - overview 7-13
 - synchronous local attachment 7-14
 - teletypewriter current attachment 7-14
 - 1200 bps integrated modem, asynchronous 7-14
 - 1200 bps integrated modem with clock, synchronous 7-15
- communication power feature 6-4
- communication units and features
 - introduction 7-1
 - overview 1-12
- Communications Indicator Panel 7-8
- Communications Power Feature
 - for communications support 7-8
 - when required for teletypewriter adapter 6-4
- communications subsystem, programmable (*see* 4987)
- comparison of processors 2-2
- console
 - basic 2-3
 - for the 4987 (4990) 7-18
 - programmer 2-8
- console keyboard, 4979 4-11

- control
 - card 5-8
 - direct program 2-6
 - of I/O 2-6
- controller feature
 - 4963 3-9
 - 4969 3-19
 - 4987 7-12
- controller storage, 4987 7-12
- controls (*see* operator controls and indicators)
- conventions iii
- current loop (teletypewriter adapter)
 - isolated 6-3, 7-14
 - nonisolated 6-3
- Customer Access Panel 6-7
- customer direct program control (DPC) adapter
 - description 6-5
 - overview 1-11
 - throughput delay 6-5
- cycle steal (I/O operation)
 - BSC 8-line control 7-5
 - I/O control 2-6
- cylinder (defined) 3-15

- data
 - security and integrity 1-16
 - stacking 2-6
- data buffer 2-5
- data links, communication
 - multipoint 7-2
 - operator 4-1
 - point-to-point nonswitched 7-1
 - point-to-point switched 7-2
- DATA-PHONE digital service attachment 7-16
- data transfer 6-4
- design overview, system 1-1
- device attachment features (*see* features)
- diagnostic capability
 - DPC adapter 6-5
 - integrated digital I/O 6-6
 - teletypewriter adapter feature 6-4
- diagnostic mode, DI/PI (4982 feature) 5-7
- digital I/O
 - features for 4982 Sensor I/O Unit 5-7
 - nonisolated, integrated 6-6
- digital input/process interrupt (DI/PI)
 - features for 4982 Sensor I/O Unit 5-7
 - integrated digital I/O, nonisolated 6-6
- digital output (DO)
 - integrated digital I/O feature 6-6
 - nonisolated feature 5-7
- DIPI (*see* digital input/process interrupt)
- direct program control (DPC)
 - adapter feature 6-5
 - definition 2-6
- disk
 - description 3-10
 - specifications (4963) 3-10
 - storage subsystem (4963) 3-7
 - description 3-7
 - overview 1-6
 - storage unit, 4962
 - description 3-3
 - overview 1-6
 - unit controls (4963) 3-9
- disk storage unit (*see* 4962 Disk Storage Unit)
- disk subsystem (*see* 4963 Disk Subsystem Unit)
- diskette magazine (*see* 4966 Diskette Magazine Unit)
- diskette unit (*see* 4964 Diskette Unit or 4962 Disk Storage Unit)
- display screen, 4979 4-10
- display station
 - (*see also* 4979 Display Station)
 - description 4-9
 - overview 1-8
- display terminal (*see* 3101 Display Terminal)
- DO (*see* digital output)
- DPC (*see* direct program control)

- EBCDIC (*see* extended binary-coded decimal interchange code)
- EIA (*see* Electronic Industries Association)
- eight-line control (*see* 8-line control)
- Electronic Industries Association (EIA)
 - extension cable, 4987 7-13
 - interface, device attachment 7-11
 - interface, teletypewriter adapter 6-3
 - rack, EIA (RS-310B) 19-inch 1-2
 - rack, EIA (RS-310B) 19-inch 8-5
- emergency pull control, 4997 8-7
- enclosures
 - rack (*see* 4997 Rack Enclosure)
 - termination
 - (*see* 4993 Series/1-System/370 Termination Enclosure)
- expansion scanner, 4987 7-10
- extended binary-coded decimal interchange code (EBCDIC)
 - 4973 character sets 4-4
 - 4974 character sets 4-7
 - 4979 keys 4-11
- external gate enable (timers) 6-1
- external sync
 - digital input/process interrupt (DI/PI), 4982 5-7
 - integrated digital I/O 6-6

- Feature—Programmable Multi-Line Communication 7-7
- features
 - communication (for processor I/O channel) 7-3
 - asynchronous, single-line control 7-6
 - asynchronous, 4-line adapter 7-6
 - asynchronous, 8-line control 7-6
 - binary synchronous, single-line control 7-4
 - binary synchronous, 4-line adapter 7-5
 - binary synchronous, 8-line control 7-5
 - communications indicator panel 7-8
 - communications power 7-8
 - programmable 4-line adapter 7-7
 - programmable 8-line control 7-7
 - synchronous data link, single-line control 7-3
 - communication (for programmable subsystem)
 - (*see* communication features for programmable subsystem)
 - disk, diskette, and magnetic tape unit attachments
 - 4962 Disk Storage Unit 3-3
 - 4963 Disk Subsystem 3-7
 - 4964 Diskette Unit 3-11
 - 4966 Diskette Magazine Unit 3-15
 - 4969 Magnetic Tape Subsystem 3-17
 - list of Series/1 hardware A-1
 - power
 - communication support 7-8
 - teletypewriter adapter 6-4

- printer and display unit attachments
 - 4973 Line Printer 3-27
 - 4974 Printer 3-31
 - 4979 Display Station 3-33
- processor (*see* processor features)
- programmable communications subsystem 7-9
- programmer console 2-8
- sensor I/O attachment, 4982 5-3
 - analog (overview) 1-9
 - digital (overview) 1-9
 - integrated digital I/O 1-11
 - integrated digital I/O 6-6
 - 4982 Sensor Input/Output Unit 5-3
- user attachment
 - channel repower 6-8
 - channel socket adapter 6-9
 - customer access panel 6-7
 - customer direct program control (DPC) adapter 6-5
 - integrated digital input/output, nonisolated 6-6
 - overview 1-10
 - teletypewriter adapter 6-3
 - timer 6-1
- 4952 Processor 2-9
- 4953 Processor 2-13
- 4955 Processor 2-17
- floating point
 - description 2-22
 - registers 2-21
- four-line adapter (*see* 4-line adapter)
- full-duplex data set attachment 7-16

- general registers 2-5

- half-duplex data set attachment 7-13
- hardware, list of Series/1 A-1

- I/O channel capability 2-6
- I/O control 2-6
- I/O Expansion Unit (*see* 4959 Input/Output Expansion Unit)
- I/O interrupts (automatic vectoring) 2-4
- I/O units
 - disk, diskette, and magnetic tape 3-1
 - overview 1-6
 - printers and display 3-27
 - sensor 5-1
- indicator panel
 - communications 7-8
 - 4987 7-12
- indicators (*see* operator controls and indicators)
- initial program load (IPL)
 - binary synchronous communications 7-4
 - teletypewriter adapter 6-4
- input/output (*see* I/O)
- instant power-off 8-9
- instruction address register 2-5
- instructions
 - addressing modes 2-7
 - average execution times 2-2
 - classification 2-7
 - load multiple and branch 2-6
 - pop 2-6
 - push 2-6
 - store multiple 2-6
- integrated communication features
 - asynchronous 7-6
 - binary synchronous 7-4
 - overview 1-6
 - programmable multi-line 7-7
 - synchronous data link control 7-3
- integrated digital input/output, nonisolated
 - description 6-6
 - overview 1-11
- integrity, data security and 1-16
- international considerations
 - 4973 Line Printer 4-3
 - 4974 Printer 4-7
 - 4979 Display Station 4-9
- interrupts
 - aperiodic (timers) 6-2
 - class 2-4
 - I/O 2-4
 - periodic (timers) 6-2
 - priority 2-4
 - request keys, 4979 Display Station 4-11
 - structure 2-4
 - trace
 - 4952 Processor 2-10
 - 4953 Processor 2-14
 - 4955 Processor 2-18
 - vectoring for DPC adapter 6-5
- introduction 1-1
- IPL (*see* initial program load)
- isolated
 - current loop 6-3
 - current loop 7-14
 - digital input/process interrupt 5-7
 - teletypewriter adapter 6-4
 - teletypewriter current attachment 7-14

- Japanese (Katakana) considerations 4-5

- Katakana (Japanese) considerations 4-5
- keyboard, console (4979) 4-11

- large scale integration (LSI) 1-2
- level, priority interrupt 2-4
- level status register 2-5
- line printer
 - description 4-3
 - overview 1-8
- linkage stacking 2-6
- links, communication data (*see* communication data links)
- list of Series/1 RPQs
- load multiple and branch instruction 2-6
- LSI (large scale integration) 1-2

- machine check 2-4
- magazine, diskette 3-8
- magnetic tape subsystem (*see* 4969 Magnetic Tape Subsystem)
- magnetic tape unit (4969) 3-17
- manual answer, 4987
 - asynchronous switched network (U.S.) 7-14
 - synchronous switched network (U.S.) 7-15
- mark (signal level for teletypewriter) 6-3
- mask register 2-5

- metal-oxide semiconductor field-effect transistor (MOSFET) 1-2
- models
 - battery backup unit, 4999 8-8
 - disk storage units
 - 4962 3-1
 - 4963 3-3
 - magnetic tape unit, 4969 3-17
 - processors
 - 4952 2-9
 - 4953 2-13
 - 4955 2-17
 - rack enclosure, 4997 8-5
- modem, integrated
 - (*see also* communication features for programmable subsystem)
 - asynchronous 7-14
 - overview 7-13
 - synchronous 7-15
- modes, addressing 2-7
- modules
 - how input/output features are plugged 1-3
 - mounted in rack enclosure 1-2
- MOSFET (metal-oxide semiconductor field-effect transistor) 1-2
- mounting fixture, rack 8-5
- multiplexer, analog input
 - overview 5-8
 - reed-relay card 5-9
 - solid-state card 5-9
- multipoint data link 7-2
- multirange card, amplifier (4982) 5-9

- nonisolated
 - current loop 2-25
 - digital input/process interrupt 5-7
 - digital output 5-7
 - teletypewriter adapter 6-3
 - teletypewriter current attachment 7-14
- nonswitched data link, point-to-point 7-1

- operating characteristics
 - 4962 Disk Storage Unit 3-5
 - 4963 Disk Storage Unit 3-10
 - 4964 Diskette Unit 3-13
 - 4966 Diskette Magazine Unit 3-16
 - 4969 Magnetic Tape Unit 3-20
 - 4973 Line Printer 4-4
 - 4974 Printer 4-8
 - 4979 Display station 4-9
- operator controls and indicators
 - Two Channel Switch 2-27
 - 4973 Line Printer 4-4
 - 4974 Printer 4-8
 - 4987 Programmable Communications Subsystem 7-17
 - 4987 Programmable Communications Subsystem 7-18
 - 4993 Series/1-System/370 Termination Enclosure 8-4
 - 4999 Battery Backup Unit 8-9
- operator I/O units
 - overview 1-8
 - 4973 Line Printer
 - description 4-3
 - overview 1-8
 - 4974 Printer
 - description 4-7
 - overview 1-8
- operator I/O units (continued)
 - 4979 Display Station
 - description 4-9
 - overview 1-8
 - operator panel (4999) 8-9
 - optional features
 - common to all processors 2-8
 - 4952 Processor 2-12
 - 4953 Processor 2-14
 - 4955 Processor 2-22
 - panel, 4987 indicator 7-17
 - periodic interrupts (timers) 6-2
 - pin-feed carriage 4-4
 - point-to-point data links 7-1
 - pop instruction 2-6
 - power feature
 - communication support 7-8
 - teletypewriter adapter 6-4
 - power off, instant (4997) 8-6
 - power/thermal warning 2-10
 - preface iii
 - print-belt translator 4-4
 - printer
 - descriptions
 - 4973 Line Printer 4-3
 - 4974 Printer 4-7
 - overview 1-8
 - priority interrupts 2-4
 - process interrupt (PI)
 - features for 4982 Sensor I/O Unit 5-7
 - integrated digital I/O nonisolated feature 6-6
 - processor features
 - addressing scheme 2-3
 - basic console 2-3
 - floating point 2-22
 - I/O control 2-6
 - instruction set 2-7
 - interrupt structure 2-4
 - overview 2-1
 - programmer console 2-8
 - registers 2-5
 - segmentation registers
 - 4952 Processor 2-12
 - 4955 Processor 2-21
 - stacking 2-6
 - storage address relocation translator
 - 4952 Processor 2-12
 - 4955 Processor 2-22
 - storage protection
 - 4952 Processor 2-12
 - 4955 Processor 2-21
 - processor I/O channel
 - delay for DPC adapter feature 6-5
 - 4952 Processor 2-12
 - 4953 Processor 2-14
 - 4955 Processor 2-21
 - processor I/O channel, communications features for 7-3
 - processor status word register 2-5
 - processors
 - comparison 2-2
 - introduction 1-5
 - overview 2-1
 - 4952 Processor 2-9
 - 4953 Processor 2-13
 - 4955 Processor 2-17

- processors (*see also* 4952, 4953, and 4955)
 - component overview 1-5
 - design overview 1-2
 - features (*see* processor features)
 - 4952 Processor 2-9
 - 4953 Processor 2-13
 - 4955 Processor 2-17
- processors and processor features 2-1
- program check
 - 4952 Processor 2-10
 - 4953 Processor 2-14
 - 4955 Processor 2-18
- program control, direct (DPC) (*see* direct program control)
- programmable circuit card (4987 scanner) 7-12
- Programmable Communications Subsystem (*see* 4987)
- Programmable Communications Subsystem Controller feature 7-12
- programmable multi-line communication 7-7
- programmer console 2-8
- programming support, Series/1 1-15
- protection, storage 1-15
 - 4952 Processor 2-12
 - 4955 Processor 2-21
- publications, related iv
- push instruction 2-6

- rack, EIA (RS-310B) 19-inch 1-2
- rack enclosures
 - overview 1-3
 - 4997 Rack Enclosure 8-5
- rack mounting fixture 8-5
- ready line, integrated digital I/O 6-6
- registers
 - address key
 - 4952 Processor 2-10
 - 4955 Processor 2-21
 - clock 2-10
 - comparator 2-10
 - console data buffer 2-5
 - current instruction address 2-5
 - floating-point 2-21
 - general purpose 2-5
 - instruction address 2-5
 - integrated digital I/O, nonisolated 6-6
 - level status 2-5
 - mask 2-5
 - per-level
 - common 2-5
 - 4952 Processor 2-10
 - 4955 Processor 2-21
 - per-system
 - common 2-5
 - 4952 Processor 2-10
 - 4955 Processor 2-21
 - process interrupt (PI) 6-6
 - processor status word 2-5
 - segmentation
 - 4952 Processor 2-10
 - 4955 Processor 2-21
 - storage address 2-5
- related publications iv
- relocation (*see* storage address relocation translator)
- repower feature, channel 6-8
- requests for price quotation (RPQs) B-1
- RPQs B-1
- run state (timer output line) 6-1
- scanner, 4987 7-11
- screen, 4979 display 4-9
- SDLC (synchronous data link control) 7-3
- sectors
 - 4962 Disk Storage Unit 3-15
 - 4963 Disk Subsystem 3-10
 - 4964 Diskette Unit 3-12
- security, data 1-16
- segmentation registers
 - 4952 Processor 2-10
 - 4955 Processor 2-21
- sensor I/O feature cards 1-9
- sensor I/O units and features
 - integrated digital input/output, nonisolated 6-6
 - overview 1-9
 - 4982 Sensor Input/Output Unit 5-3
- serial I/O devices (for teletypewriter adapter) 6-3
- single-line control
 - asynchronous communication 7-6
 - binary synchronous communication (high speed) 7-4
 - binary synchronous communication (medium speed) 7-4
 - synchronous data link control 7-3
- socket adapter feature 6-9
- soft exception trap
 - 4952 Processor 2-10
 - 4953 Processor 2-14
 - 4955 Processor 2-18
- space (signal level for teletypewriter) 6-3
- specifications
 - 4962 Disk Storage Unit 3-5
 - 4963 Disk Subsystem 3-10
 - 4964 Diskette Unit 3-13
 - 4969 Magnetic Tape Subsystem 3-20
 - 4973 Line Printer 4-4
 - 4974 Printer 4-8
 - 4979 Display Station 4-9
- stacking 2-6
- steal, cycle
 - communication units and features 7-1
 - I/O control 2-6
- storage
 - addressing 2-3
 - size
 - 4952 Processor 2-9
 - 4953 Processor 2-13
 - 4955 Processor 2-17
 - 4987 controller 7-12
- storage address relocation translator
 - 4952 Processor 2-12
 - 4955 Processor 2-22
- storage I/O units
 - overview 1-6
 - 4962 Disk Storage Unit
 - description 3-3
 - overview 1-6
 - 4963 Disk Storage Subsystem
 - description 3-7
 - overview 1-6
 - 4964 Diskette Unit
 - description 3-11
 - overview 1-6
 - 4966 Diskette Magazine Unit
 - description 3-15
 - overview 1-7
 - 4969 Magnetic Tape Subsystem
 - description 3-17

- storage I/O units (continued)
 - overview 1-7
 - storage protection
 - 4952 Processor 2-12
 - 4955 Processor 2-21
 - store multiple instruction 2-7
 - subsystem unit, 4987 7-11
 - supervisor call 2-7
 - support
 - communications features 7-8
 - programming 1-15
 - switched data link, point-to-point 7-2
 - sync line, integrated digital I/O 6-6
 - synchronous data link control (SDLC) 7-3
 - synchronous local attachment 7-14
 - system components (overview) 1-5
 - system design (overview) 1-1
-
- TCS (Two Channel Switch) feature 2-25
 - TCS console (4959) 2-27
 - TCS feature (4959) 2-25
 - technology, LSI and MOSFET 1-2
 - (see also transistor-transistor logic)
 - teletypewriter adapter
 - description 6-3
 - overview 1-10
 - teletypewriter current attachment 7-14
 - termination card, 4982 Sensor I/O Unit 5-5
 - termination enclosure (see 4993)
 - text editor
 - thermal/power warning | 2-10
 - timer
 - description 6-1
 - overview 1-10
 - trace, instruction
 - 4952 Processor 2-10
 - 4953 Processor 2-14
 - 4955 Processor 2-18
 - transistor-transistor logic (TTL)
 - cable drivers (for DPC adapter features) 6-5
 - digital output signal line, compatible with 6-6
 - technology (processors) 2-1
 - timer signal lines compatible with 6-1
 - voltage level interface (teletypewriter adapter) 6-3
 - translator, relocation (see storage address relocation trans.)
 - TTL (see transisotr-transistor logic)
 - Two Channel Switch (TCS) console 2-27
 - Two Channel Switch (TCS) feature (4959) 2-25
-
- user attachment features
 - channel repower 6-8
 - customer access panel 6-7
 - customer direct program control adapter 6-5
 - description 6-1
 - integrated digital input/output nonisolated 6-6
 - overview 1-10
 - socket adapter 6-9
 - teletypewriter adapter 6-5
 - timer 6-1
-
- warning, power/thermal 2-10
 - Western Electric Automatic Calling Unit 7-14
 - wire-image buffer, 4974 Printer 4-7
-
- work station (for 5250 Information Display System) 8-11
 - wrap test, 4987 7-14
 - wrap test, 4987 7-15
-
- 1200 bps integrated modem, asynchronous 7-14
 - 1200 bps integrated modem with clock, synchronous 7-15
-
- 3101 Display Terminal attachment to Series/1
 - asynchronous 7-6
 - direct-current loop 7-14
 - full-duplex 7-16
 - half-duplex 7-13
 - programmable 7-7
 - teletypewriter adapter 6-3
-
- 4 line adapter
 - asynchronous communication 7-6
 - binary synchronous communication 7-5
 - programmable multi-line 7-7
 - 4952 Processor
 - basic features (common) 2-3
 - block diagram 2-11
 - card plugging assignments 2-12
 - class interrupts 2-10
 - comparison of processors 2-2
 - models 2-9
 - optional features 2-8
 - overview 1-5
 - processor I/O channel 2-12
 - registers 2-10
 - segmentation registers 2-12
 - storage address relocation translator 2-12
 - storage protection 2-12
 - storage size 2-9
 - 4953 Processor
 - basic features (common) 2-3
 - block diagram 2-15
 - card plugging assignments 2-16
 - class interrupts 2-14
 - comparison of processors 2-2
 - models 2-13
 - optional features 2-8
 - overview 1-5
 - processor I/O channel 2-14
 - storage size 2-13
 - 4955 Processor
 - basic features (common) 2-3
 - block diagram 2-19
 - card plugging assignments 2-20
 - class interrupts 2-18
 - comparison of processors 2-2
 - floating point 2-22
 - models 2-17
 - optional features (common) 2-8
 - optional features (unique to 4955) 2-22
 - overview 1-5
 - processor I/O channel 2-21
 - registers 2-21
 - storage address relocation translator 2-22
 - storage protection 2-21
 - storage size 2-17
 - 4959 Input/Output Expansion Unit
 - block diagram
 - with dual processor and TCS 2-26

- with processor 2-11
 - with processor 2-15
 - with processor 2-19
- card plugging assignments 2-24
- card plugging assignments with TCS 2-25
- description 2-23
- overview 1-5
- TCS console 2-27
- two channel switch (TCS) feature 2-25
- 4962 Disk Storage Unit
 - description 3-3
 - disk 3-4
 - diskette 3-4
 - models 3-3
 - overview 1-6
 - specifications 3-5
- 4963 Disk Subsystem
 - block diagram 3-7
 - description 3-7
 - disk unit controls 3-9
 - models 3-9
 - overview 1-6
 - specifications 3-10
- 4963 Disk Storage Unit 3-9
- 4964 Diskette Unit
 - description 3-11
 - diskette storage medium (illustration) 3-13
 - diskette surface terminology 3-12
 - overview 1-6
 - specifications 3-13
- 4966 Diskette Magazine Unit
 - block diagram 3-16
 - description 3-15
 - overview 1-7
- 4969 Magnetic Tape Subsystem
 - block diagram 3-18
 - description 3-17
 - magnetic tape unit
 - controller features 3-19
 - models 3-17
 - overview 1-7
 - specifications 3-20
- 4973 Line Printer
 - description 4-3
 - international considerations 4-5
 - Japanese (Katakana) considerations 4-5
 - overview 1-8
 - specifications 4-4
- 4974 Printer
 - description 4-7
 - international considerations 4-8
 - overview 1-8
 - specifications 4-8
- 4978 Display Station RPQ B-1
- 4979 Display Station
 - console keyboard 4-11
 - description 4-9
 - display screen 4-10
 - international considerations 4-12
 - overview 1-8
 - specifications 4-9
- 4982 Sensor Input/Output Unit
 - analog input subsystem 5-8
 - analog output 5-9
- 4982 Sensor Input/Output Unit (continued)
 - block diagram 5-4
 - card sockets 5-6
 - description 5-3
 - digital input/process interrupt
 - isolated 5-7
 - nonisolated 5-7
 - digital output nonisolated 5-7
 - overview 1-9
- 4987 Programmable Communications Subsystem
 - block diagrams 7-10
 - controller feature 7-12
 - description 7-9
 - device attachment card sockets diagram 7-11
 - device attachment features 7-13
 - indicator panel 7-17
 - operator controls and indicators 7-17
 - overview 1-13
 - subsystem unit 7-11
- 4990 Communications Console for the 4987 7-18
- 4990 Communications Console for the 4987
 - description 7-18
 - overview 1-13
- 4993 Series/1–System/370 Termination Enclosure
 - block diagram 8-4
 - description 8-3
 - overview 1-14
- 4997 Rack Enclosure
 - description 8-5
 - modules mounted in (illustration) 1-1
 - overview 1-14
- 4999 Battery Backup Unit
 - description 8-9
 - operator panel 8-9
 - overview 1-14
- 5250 Information Display System Attachment Feature
 - block diagram 8-10
 - description 8-10
 - overview 1-14
- 8 line control
 - asynchronous communication 7-6
 - binary synchronous communication 7-5
 - programmable multi-line communications 7-7

READER'S COMMENT FORM

GA34-0035-5

IBM Series/1 System Summary

Your comments assist us in improving the usefulness of our publications; they are an important part of the input used in preparing updates to the publications. IBM may use and distribute any of the information you supply in any way it believes appropriate without incurring any obligation whatever. You may, of course, continue to use the information you supply.

Please do not use this form for technical questions about the system or for requests for additional publications; this only delays the response. Instead, direct your inquiries or requests to your IBM representative or the IBM branch office serving your locality.

Corrections or clarifications needed:

Page	Comment
------	---------

Cut or Fold Along Line

Please indicate your name and address in the space below if you wish a reply.

Thank you for your cooperation. No postage stamp necessary if mailed in the U.S.A.
(Elsewhere, an IBM office or representative will be happy to forward your comments.)

Reader's Comment Form

Cut Along Line

Fold and tape

Please Do Not Staple

Fold and tape



NO POSTAGE
NECESSARY
IF MAILED
IN THE
UNITED STATES

BUSINESS REPLY MAIL

FIRST CLASS PERMIT NO. 40 ARMONK, NEW YORK

POSTAGE WILL BE PAID BY ADDRESSEE



IBM Corporation
Systems Publications, Dept 27T
P.O. Box 1328
Boca Raton, Florida 33432

Fold and tape

Please Do Not Staple

Fold and tape



International Business Machines Corporation
General Systems Division
4111 Northside Parkway N.W.
P.O. Box 2150, Atlanta, Georgia 30301
(U.S.A. only)

General Business Group/International
44 South Broadway
White Plains, New York 10601
(International)

GA34-0035-5
Printed in U.S.A.

This Newsletter No. GN34-1604
Date December 3, 1979
Base Publication No. GA34-0035-5
File No. S1-00
Previous Newsletters None

IBM Series/1
System Summary

© IBM Corp. 1976, 1977, 1978, 1979

This Technical Newsletter provides replacement pages for the subject publication. Pages to be inserted and/or removed are:

8-5, 8-6
A-1, A-2

A technical change to the text or to an illustration is indicated by a vertical line to the left of the change.

Summary of Amendments

This TNL adds specify codes for ordering the 4969 and the proper rack enclosure.

Note. Please file this cover letter at the back of the manual to provide a record of changes.



International Business Machines Corporation

General Systems Division
4111 Northside Parkway N.W.
P. O. Box 2150
Atlanta, Georgia 30301
(U.S.A. only)

General Business Group/International
44 South Broadway
White Plains, New York 10601
(International)