

GA21-9152-2  
File No. 3740-00,15

**Systems**

**IBM 3740 Data Entry System  
System Summary and  
Installation Manual –  
Physical Planning**

**IBM**

## Preface

This manual is intended for company executives, systems analysts, data processing managers and key entry supervisors, installation supervisors, programmers, and data station operators.

This manual provides general information about the system and installation information for centralized key entry. The manual contains descriptive information about the system and each unit, available functions and features, and the media. Programming information, suggestions for system designing, and operating procedures are included; and information necessary for planning the physical installation of the IBM 3740 Data Entry System.

In addition, a bibliography of teleprocessing publications is included.

### Related Publications

*IBM 3741 Data Station Reference Manual*, GA21-9183.

*IBM 3742 Dual Data Station Reference Manual*, GA21-9184.

*IBM 3747 Data Converter Reference Manual and Operator's Guide*, GA21-9170

*IBM 3741 and 3742 Operator's Guides*, GA21-9131 and GA21-9136.

*IBM 3740 System Print Chart*, GX21-9187.

*IBM 1443, 2203 Forms Design Considerations*, GA24-3488.

*The IBM Diskette for Standard Data Interchange*, GA21-9182

*DOS/VS System Information for IBM 3540 Diskette Input/Output Unit*, GC21-5072.

*IBM System/370 Installation Manual – Physical Planning*, GC22-7004.

*IBM 3741 Models 3 and 4 Programmable Work Station Programming Reference Manual*, GA21-9194.

*IBM 3741 Models 3 and 4 Programmable Work Station General Information*, GA21-9196.

### Third Edition (June 1974)

This is a major revision of, and obsoletes, GA21-9152-1. This edition describes new features and devices available with the IBM 3740 Data Entry System; it has been extensively rewritten and should be reviewed in its entirety.

Changes are continually made to the information herein; any such changes will be reported in subsequent revisions or Technical Newsletters.

A form for readers' comments is provided at the back of this publication. If the form has been removed, comments may be addressed to IBM Corporation, Publications, Department 245, Rochester, Minnesota 55901.

<b>SYSTEM CONCEPT</b> . . . . .	<b>1</b>	<b>SYSTEM DESIGN CONSIDERATIONS</b> . . . . .	<b>22</b>
System Overview . . . . .	1	Job Scheduling and Work Flow . . . . .	22
The IBM Diskette . . . . .	2	Data Labeling on the Diskette . . . . .	24
IBM 3741 Models 1 and 2 Data Station . . . . .	2	Single and Multiple Data Sets Per Diskette . . . . .	24
IBM 3741 Models 3 and 4 Programmable Work Station . . . . .	2	Data Recovery . . . . .	24
IBM 3742 Dual Data Station . . . . .	2	<b>PREPARING FOR THE INSTALLATION</b> . . . . .	<b>25</b>
IBM 3747 Data Converter . . . . .	3	General Guidelines . . . . .	25
IBM 3540 Diskette Input/Output Unit . . . . .	3	Events . . . . .	25
IBM 3713 Printer . . . . .	4	Estimating Diskette Requirements . . . . .	25
IBM 3715 Printer . . . . .	4	Centralized Data Entry . . . . .	26
IBM 3717 Printer . . . . .	5	Local Source Department . . . . .	26
Why the System? . . . . .	6	Remote Source Department . . . . .	26
<b>DATA STATIONS</b> . . . . .	<b>9</b>	Example of Estimating Diskette Requirements . . . . .	26
CRT Operator Display . . . . .	9	Summary . . . . .	27
Entering Data . . . . .	9	Key Entry Programs . . . . .	27
Operator Guidance . . . . .	9	Diskette Control . . . . .	30
Program Control . . . . .	10	External Labels . . . . .	30
Program Chaining . . . . .	10	Diskette Library . . . . .	30
Updating Data . . . . .	11	Care and Storage of the Diskette . . . . .	32
Verifying Data . . . . .	11	Documentation . . . . .	32
Adding Records to a Batch . . . . .	11	System Programming Considerations . . . . .	36
Record Insert . . . . .	11	Card Replacement . . . . .	36
Searching Data on Disk . . . . .	11	Tape Replacement . . . . .	37
Search on Record Address . . . . .	11	Teleprocessing Programming Support . . . . .	37
Search on End of Data . . . . .	12	Telecommunications Facilities Considerations . . . . .	38
Search on Content and Sequential Content . . . . .	12	Unit Backup Considerations . . . . .	38
Disk Copy . . . . .	12	Education and Training . . . . .	38
Second Disk . . . . .	12	<b>PHYSICAL SITE PLANNING AND PREPARATION</b> . . . . .	<b>40</b>
128-Character Record . . . . .	12	Space Requirements . . . . .	40
Disk Initialization . . . . .	12	Environmental Considerations . . . . .	40
Production Statistics . . . . .	12	Temperature and Humidity . . . . .	40
Field Totals . . . . .	13	Tape and Diskette Storage . . . . .	40
Self Check . . . . .	13	Dirt and Air Pollution . . . . .	41
Proof Keyboard . . . . .	13	Lighting . . . . .	41
Data Recorder Attachment . . . . .	13	Fire Protection Equipment . . . . .	41
Printers . . . . .	14	Electrical Requirements . . . . .	41
IBM 3713 Printer . . . . .	14	Grounding . . . . .	41
IBM 3715 Printer . . . . .	14	Convenience Outlets . . . . .	41
IBM 3717 Printer . . . . .	15	Power Supply . . . . .	41
Binary Synchronous Communications Adapter . . . . .	16	<b>UNIT SPECIFICATIONS</b> . . . . .	<b>42</b>
Synchronous Clock . . . . .	16	129 Card Data Recorder . . . . .	43
Terminal Identification . . . . .	16	3713 Printer . . . . .	44
Keylock . . . . .	16	3715 Printer . . . . .	45
Operator Identification Card Reader . . . . .	16	3717 Printer . . . . .	46
Expanded Communications . . . . .	16	3741 Data Station Models 1 and 2 . . . . .	47
Expanded Communications/Multipoint Data Link Control . . . . .	16	3741 Programmable Work Station Models 3 and 4 . . . . .	47
3741 and 3742 Function and Feature Summary . . . . .	17	3742 Dual Data Station . . . . .	48
Data Conversion via the 3747 . . . . .	19	3747 Data Converter . . . . .	49
Input via the 3540 . . . . .	20	5496 Data Recorder . . . . .	50
<b>PROGRAMMABLE WORK STATIONS</b> . . . . .	<b>21</b>	<b>3740 SYSTEM CABLING INFORMATION</b> . . . . .	<b>51</b>
Functions under ACL Program Control . . . . .	21	<b>INCH TO CENTIMETER CONVERSION CHART</b> . . . . .	<b>52</b>
Features Available with the Programmable Work Station . . . . .	21	<b>GLOSSARY</b> . . . . .	<b>53</b>
ACL Translator . . . . .	21	<b>TELEPROCESSING BIBLIOGRAPHY</b> . . . . .	<b>56</b>
Storage, 4K Additional . . . . .	21	<b>INDEX</b> . . . . .	<b>57</b>



3742 Dual Data Stations

3747 Data Converter

3713 Printer

3741 Data Station

IBM 3740 Data Entry System



Rising costs, excessive errors, and long delays in the data entry cycle concern all computer users. The IBM 3740 Data Entry System is an integrated family of data entry products that helps the user answer these data entry problems.

### SYSTEM OVERVIEW

A key element of the 3740 Data Entry System is a new reusable media — the IBM diskette. This diskette consists of a flexible disk permanently enclosed in a protective plastic package. The diskette is an economical means for recording and storing data, and is a quiet, inexpensive, high-function media for volume data entry.

The record volume capacity of one diskette is roughly equivalent to that of a box of cards. Data written on the diskette can easily be corrected or updated, eliminating the need to rekey the record and scrap the media on which it is recorded.

Data can be written on and read off of the diskette at high speed. This property of the diskette greatly facilitates record processing and operations such as machine searching of data. It also makes the diskette an appropriate medium for data communications. Sequential arrangement of data records on the diskette parallels arrangement of punched card records. The addition of random accessing of records, however, permits operations not previously feasible with other media, such as cards, paper forms, or ledger cards.

Just like punched cards, magnetic tape, or other familiar media, the IBM diskette offers:

- Offline data batching with unlimited data storage.
- Ease of handling small jobs as well as large jobs.
- Data interchange between devices.

When compared to other media, the diskette has the following advantages:

- Reusability to reduce media costs.
- Easy error correction.
- Easy storage. Small, thin, and light-weight, one diskette usually holds the entire day's output from the typical key entry station.
- Portability and mailability of useful quantities of data.
- The ability to back up easily and re-read data for retransmission in case of communications error.
- Machine-assisted random access to offline batch data files.

### The IBM Diskette

The IBM Diskette (Figure 1) permits increased key entry function and greater versatility in product applications. The diskette is about 8" (20 cm) square and has a net capacity of 1898 128-character records — about one day's data entry activity. Each of the diskette's 73 magnetic recording tracks available for data entry can hold 26 sectors of up to 128 characters each.



Figure 1. IBM Diskette

### IBM 3741 Models 1 and 2 Data Station

The IBM 3741 Data Station (Figure 2) is a key entry device with one operator station. It has a keyboard, diskette drive, control unit, power supplies, and a six-line CRT display. The 3741 Data Station comes in two models: Model 1 without binary synchronous communications, and Model 2 with binary synchronous communications.

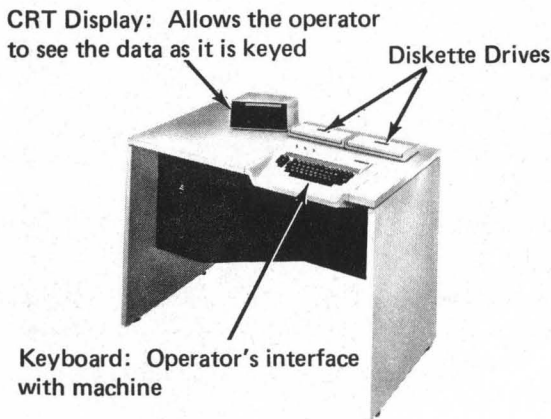

Figure 2. IBM 3741 Data Station (with Second Disk Feature)

### IBM 3741 Models 3 and 4 Programmable Work Station

The IBM 3741 Programmable Work Station (Figure 3) has the same functions and features as the 3741 Data Station, plus a programming capability. This programming capability expands the existing data entry applications and provides the ability to do new applications. The 3741 Programmable Work Station comes in two models; Model 3, without binary synchronous communications, and Model 4, with binary synchronous communications.

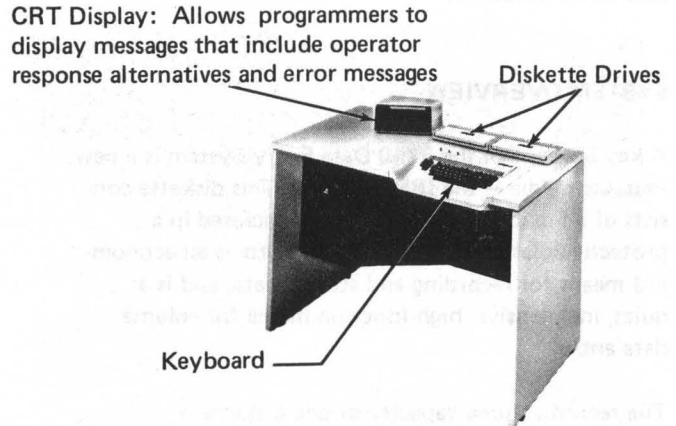

Figure 3. IBM 3741 Programmable Work Station (with Second Disk Feature)

### IBM 3742 Dual Data Station

The IBM 3742 Dual Data Station (Figure 4) is a key entry device with two operator stations. Each station has its own keyboard and diskette drive. A common control unit and set of power supplies serve both operator stations. The CRT display has two screens so that both operators can have independent use of it at the same time. See index entries *features* and/or *functions* for more information about the station.

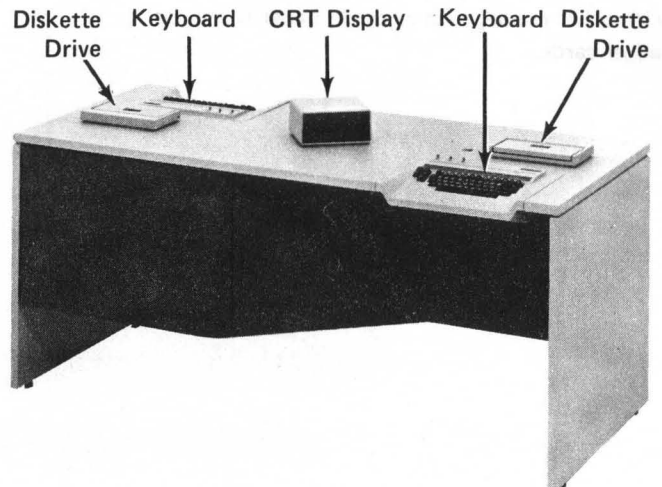

Figure 4. IBM 3742 Dual Data Station

### The IBM 3747 Data Converter

The IBM 3747 Data Converter (Figure 5) automatically feeds, reads, and stacks the diskettes, converts the data to a computer-compatible format, and records the data on 1/2" (1.3 cm) magnetic tape. The data can be used by other tape systems; no programming support other than that for normal tape processing is required. Optional modes of operation include tape to disk and binary synchronous communications.

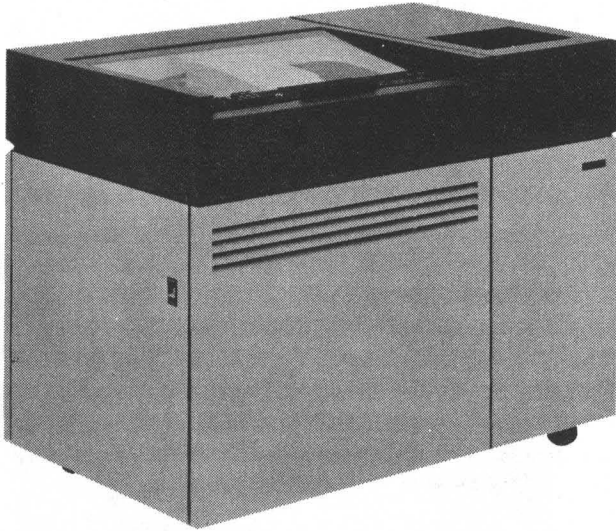
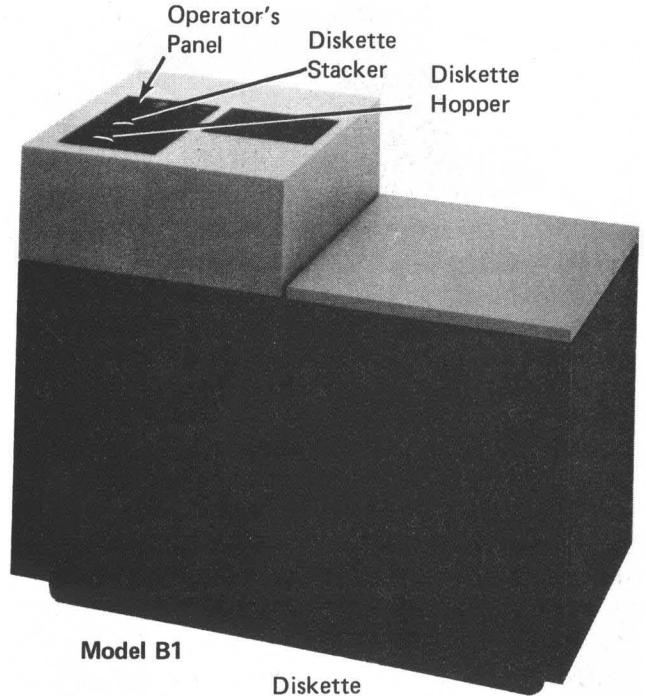

Figure 5. IBM 3747 Data Converter

### IBM 3540 Diskette Input/Output Unit

The IBM 3540 Diskette Input/Output Unit (Figure 6) is a direct input device. With the 3540, the IBM diskette is supported as a new medium on System/370. The 3540 has programming support especially suited for processing information created by the 3740 Data Entry System. Two models are available: Model B1, with a single diskette drive, and Model B2, with two diskette drives.



Model B1

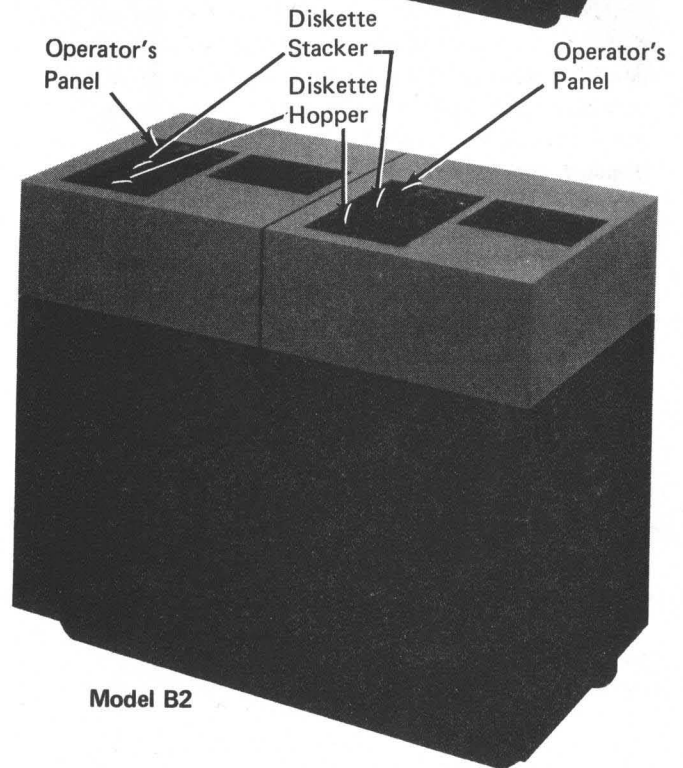

Model B2

Figure 6. IBM 3540 Diskette Input/Output Unit

### IBM 3713 Printer

The IBM 3713 Printer (Figure 7) provides the 3741 with the ability to prepare hard copy offline with or without format control. The 3713 prints at a maximum rate of 40 characters per second.

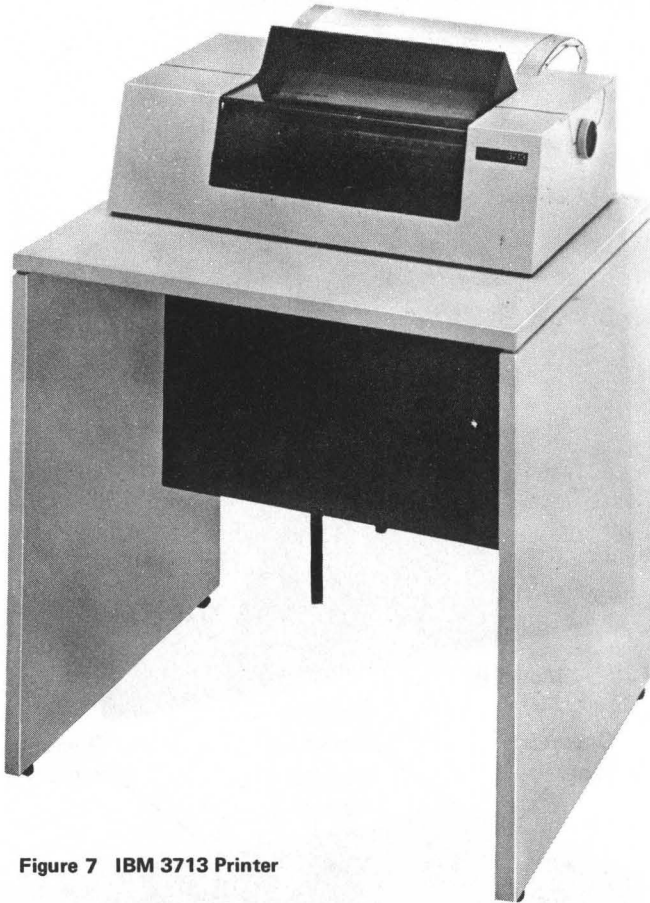

Figure 7 IBM 3713 Printer

### IBM 3715 Printer

The IBM 3715 Printer (Figure 8) provides the 3741 with the ability to prepare hard copy with or without format control. The 3715 is available in two models. Model 1 prints at a maximum rate of 40 characters per second and Model 2 prints at a maximum rate of 80 characters per second. The 3715 has bidirectional printing (prints left to right and then right to left). Other functions include comprehensive editing capability.

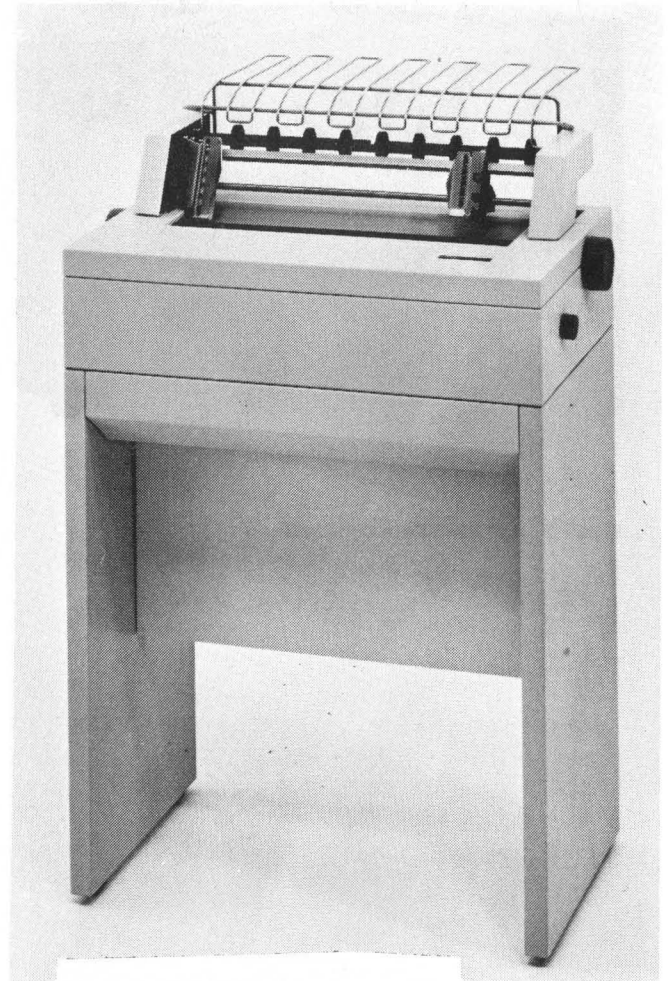

Figure 8. IBM 3715 Printer

## IBM 3717 Printer

The IBM 3717 Printer (Figure 9) provides the 3741 with the ability to prepare hard copy at a high print rate with or without format control. The 3717 can print at a rate up to 155 lines per minute when using a 48-character set and up to 120 lines per minute when using a 64-character set; the character sets are interchangeable. The 3717 uses an engraved font that provides improved legibility. Other functions include comprehensive editing capability.

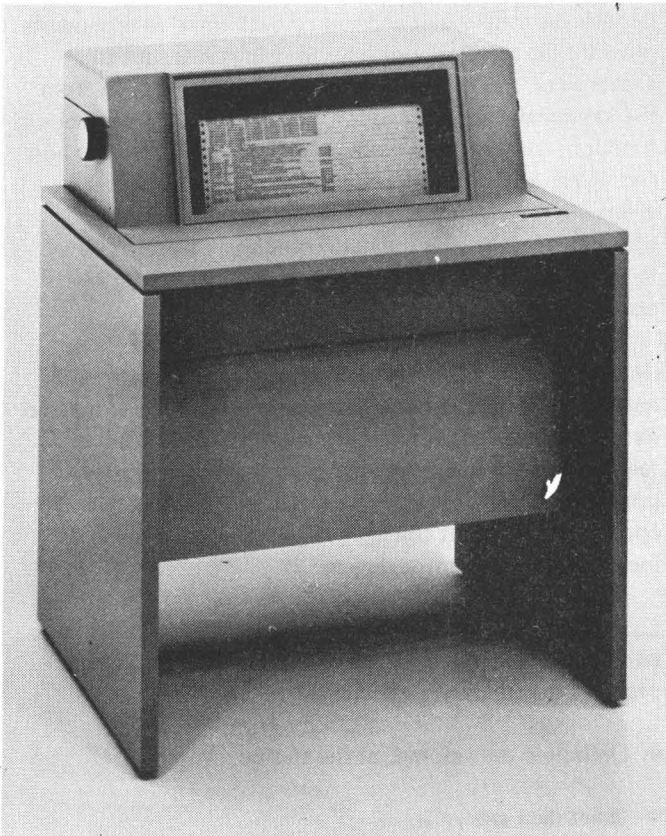

Figure 9. IBM 3717 Printer

## WHY THE SYSTEM?

Key entry operator labor is one of the prominent factors in rising data entry costs. Therefore, improvement of operator productivity is extremely important in controlling these rising costs. The 3740 system features are aimed at:

- Making volume keying in the centralized keypunch room a high productivity operation.
- Changing data entry from pure transcription to an application oriented operation.

In a centralized transcription environment (see upper part of Figure 10), a typical installation includes a number of IBM 3742 Dual Data Stations for recording data on diskettes. An IBM 3747 Data Converter is included to convert the data to ½" (1.3 cm) tape for processing by the host processing unit.

A decentralized or source department keying area (see lower part of Figure 10) is usually characterized by a relatively small number of key entry stations located in the data source area. Source departments may be either local, in the vicinity of the data processing systems and using messenger service or internal mail for delivery of data; or remote, relying on mail or telecommunications for delivery of data. The successful decentralization of the data entry function usually requires special features not normally found in key entry devices. The 3740 system provides such commonly required features as a printer, teleprocessing capability, operator guidance, and large data storage for reference and entry. In a decentralized environment, several 3741s and 3742s are scattered through large installations in the source departments. For instance, one might be in the accounts payable department, where data is entered directly from vendor invoices. Other 3741s might be in the payroll department to enter changes to salaried payroll. Diskettes are sent by interplant mail or messenger to some location having an IBM 3747 Data Converter.

In a typical remote environment (see Figure 11), one or more 3741s are located at various offsite locations. In areas where the workload is heavy, these might be supplemented with some 3742s. For example, if parts are distributed from a warehouse to several divisions of a company, the inventory data is entered on diskettes as transactions occur. Periodically, the data is transmitted to the warehouse through 3741 Model 2 or 4 with binary synchronous communications. The receiving device at the warehouse can be an:

- IBM 3741 Model 2 or 4 with BSCA.
- IBM 3747 Data Converter with BSCA.
- IBM Systems/3 Model 6, Model 10 Disk System, or Model 15 with BSCA.
- IBM System/370 via an:
  - IBM 2701 Data Adapter Unit
  - IBM 2703 Transmission Control Unit
  - IBM 3704 Communications Controller
  - IBM 3705 Communications Controller
  - Integrated Communications Adapter (ICA).

The 3740 concept of an integrated family of devices used in both the centralized and source data entry environments provides the solution, not only to rising costs, but to excessive errors. By moving the data entry function from the keypunch room out to the data source, data control functions such as preparation of keypunch worksheets and coding can often be reduced or eliminated. Moreover, errors are reduced by eliminating hand transcription operations and having the data completely handled by those who are most familiar with it and have direct responsibility for its accuracy.

Data processing users who plan to decentralize their data entry operations must still control their costs in centralized data entry areas today. The 3740 system provides the features needed to increase productivity in today's keypunch room and at the same time, decentralize data entry applications without changing to a new and possibly incompatible data entry system.

Each station in the 3740 system operates independently with its own media. The 3740 Data Entry System provides the following advantages:

- Unlimited data storage at the station.
- Quiet data entry.
- Station independence and system reliability. (Each station can continue to operate regardless of the status of other stations or down time of other facilities.)
- Total configuration flexibility.
- Smooth growth by adding exactly as many stations as are needed.



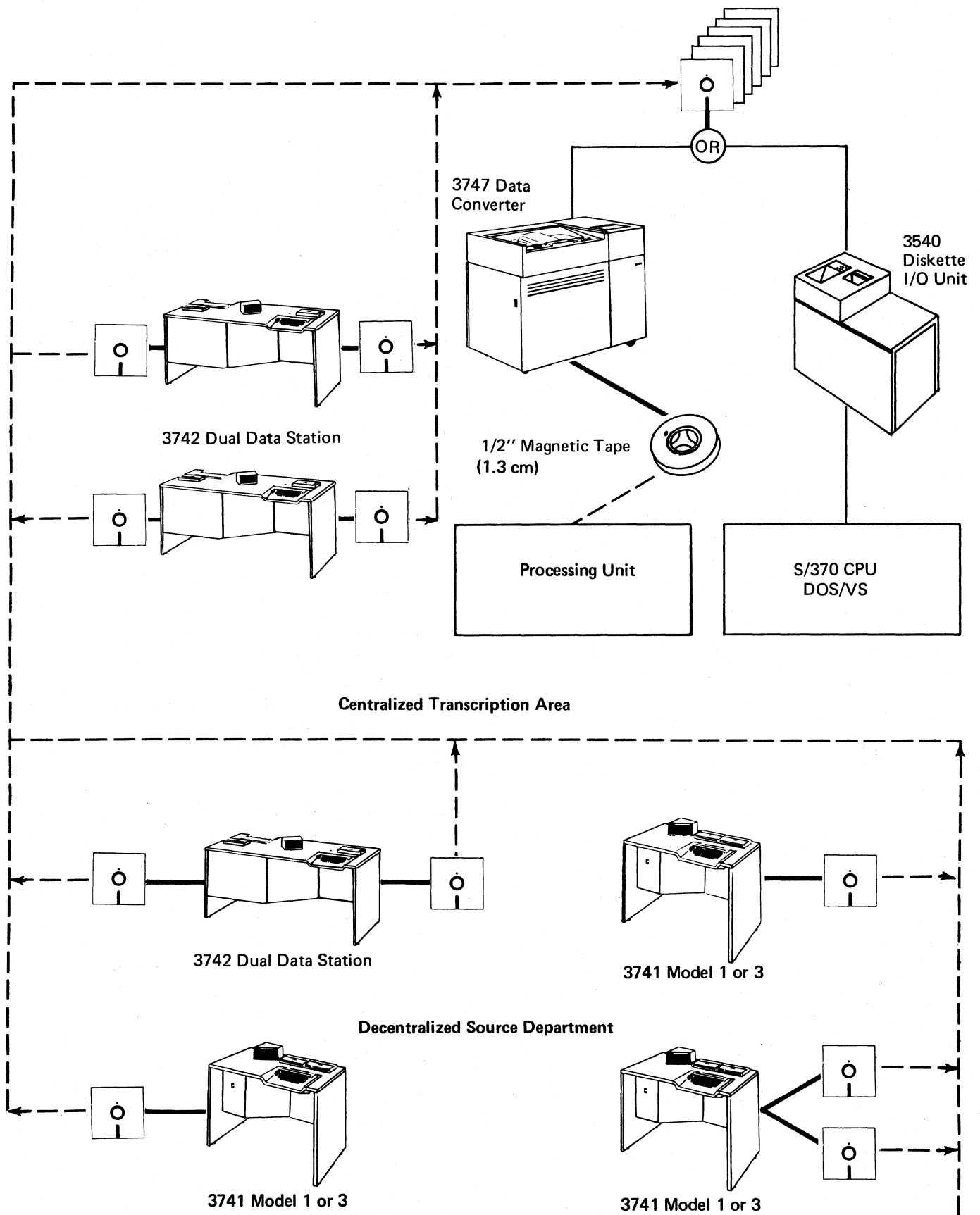

Figure 10. Possible Configurations for Centralized Transcription and Decentralized Source Areas

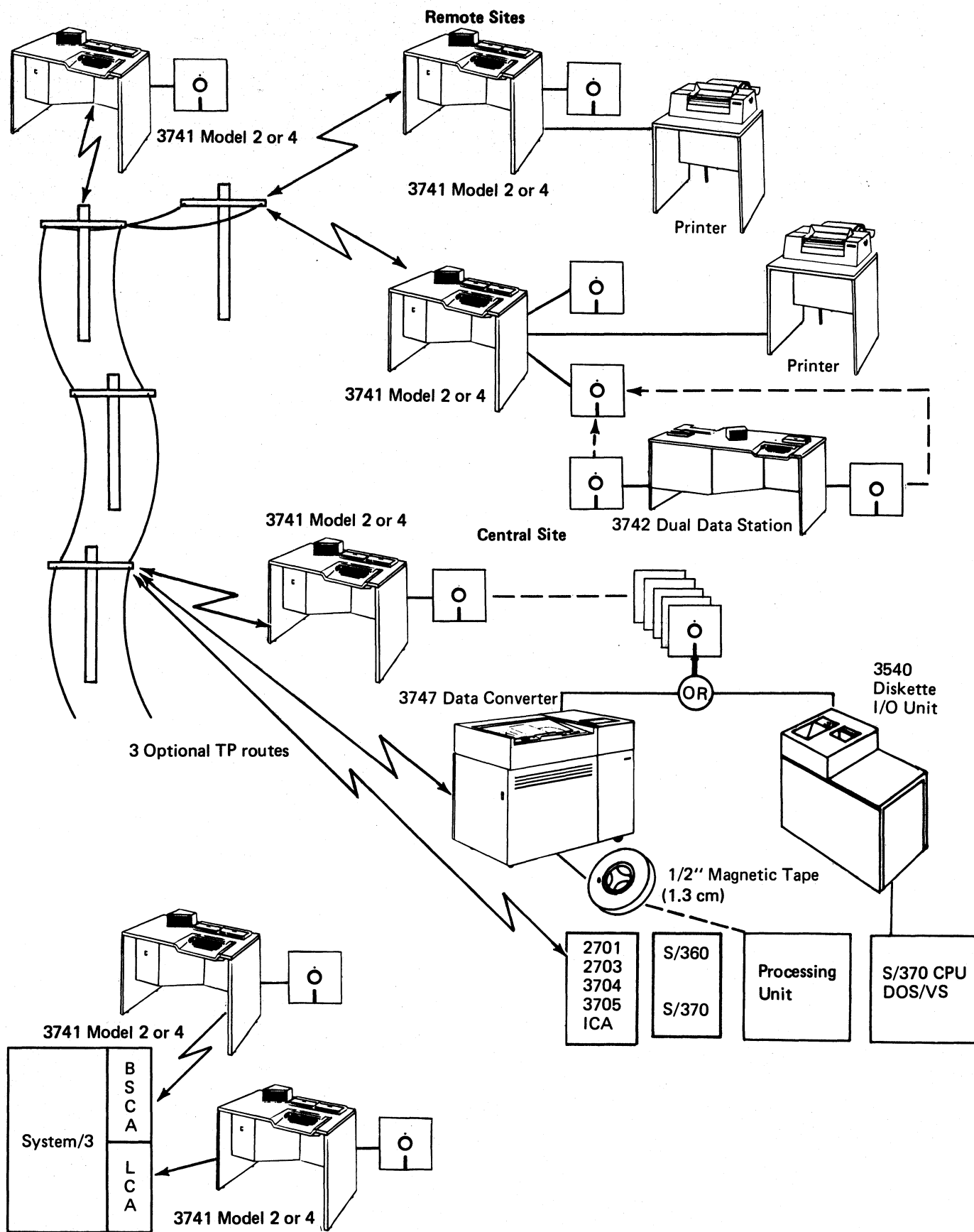

Figure 11. Possible Configuration for Binary Synchronous Communications



Both the 3741 and 3742 stations can be used in any installation to achieve the precise mix of stations and functions required. Operators find no difficulty in moving from one machine to the other because of the common interface presented to the operator; that is, the keyboard, function switches, and display.

### CRT OPERATOR DISPLAY

The CRT operator display significantly affects traditional key entry because it:

- Reduces operator training requirements.
- Provides quick communication of errors to an operator.
- Facilitates scanning and searching of stored records.
- Permits keying with operator guidance on the IBM 3741.

Each operator sees a 40-position status line, plus the data record, as it is keyed or reviewed. The status line displays information such as the position in the record, track and sector number, program level, and mode. (See Figure 12).

The cursor, shown on the left side of the screen in Figure 12, moves as the operator is keying, to show the next position to be keyed.

### ENTERING DATA

Records are entered into the machine by manual keying in Enter mode. As a record is keyed, the characters are placed in a buffer and, at the same time, appear on the CRT. When a complete record is entered, the operator presses the record advance key, which writes the record to the disk, and blanks the screen. If the auto record advance switch is on, the record is automatically written to disk when the last character is keyed.

### OPERATOR GUIDANCE

The operator guidance capability on the 3741 uses the display for interaction between the operator and the unit. Information displayed on the CRT prompts the operator through the required keying sequence. Thus, the capability is helpful both for training new operators and for teaching experienced operators a new job. Operator guidance is especially useful in source departments where operators may perform data entry tasks as a secondary function on an occasional basis. To speed throughput and reduce errors, operator guidance may be permanently used on some complex jobs that are keyed infrequently. Line 5 of the display (Figure 13) shows the prompting messages for the current data field such as CUSTOMER NAME or ADDRESS, and line 6 contains slashes (/) to represent the

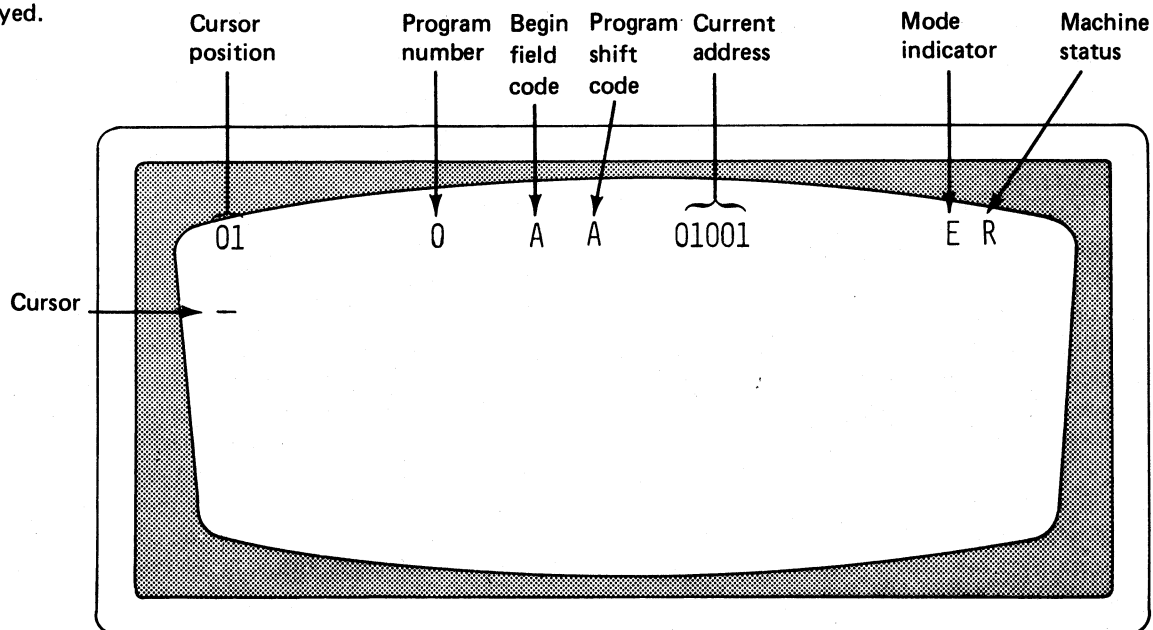

Figure 12. CRT Display of Status Line

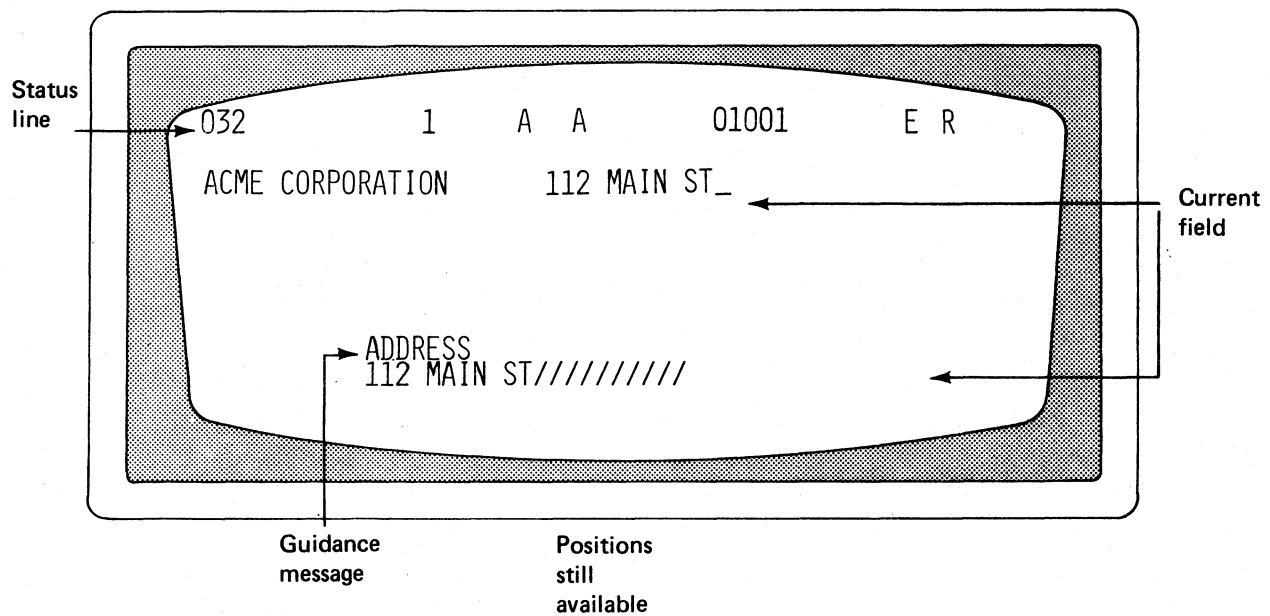

Figure 13. CRT with Operator Guidance

number of positions available in the field for characters. As the operator keys the characters, they appear both in the display of the keyed record in the usual location on lines 2 through 5 and also on line 6, where they replace the slashes, so that the operator may see at a glance how many positions remain in the field she is keying.

When a field is completed, the next prompting message appears. Knowledge of both the source document format and the data record layout is needed to set up operator guidance.

When operator guidance is used, up to five of the program levels can be used to store the prompting messages corresponding to five key entry programs. Program levels not used for operator guidance are available for normal programs.

### PROGRAM CONTROL

Program control allows the operator to preset or program the machine for the normal data entry functions. Program control is also provided for the printer. (See *Printers* for more information.) The operator keys in the coding for the needed functions and then may store this coding on a disk. Creating and storing key entry programs is discussed in detail in the *Preparing for the Installation* section of this manual.

The 3740 system makes available up to ten different program levels at once. The operator selects the programs as needed to make use of the following standard functions:

- Duplication
- Skipping
- Right-adjust (blank fill or zero fill)
- Numeric fields
- Alphabetic fields
- Bypass fields
- End of record position

Available features add these automatic functions:

- Self-check, modulus 10 and 11
- Field totals

### PROGRAM CHAINING

Program chaining permits switching automatically from one program to another while keying data in records with different formats. Different programs are selected by record advancing or record backspacing and designating different program storage areas in the proper position of the current record's program. For more information about program chaining, see the 3741 and 3742 operator's guides and reference manuals listed in the Preface.

## UPDATING DATA

Update mode can be selected to change a record that was keyed previously. After a partial or complete data set is entered, all the records in it can be reviewed as well as modified by either selecting Update mode or using the record backspace key. Update mode can be used to change any field in a record; it might be used to change the amounts in a price field or to make changes in a payroll file.

## VERIFYING DATA

Verify mode checks the accuracy of prerecorded records and permits the operator to make corrections to the records as errors are discovered. Since any errors in the recorded data are corrected during the verify operation, output from this step is converter/computer ready.

All 3740 data entry units in an installation can be used for either entry or verification; thus, workloads can be balanced with fewer units.

Verification is performed much as it is on a card verifier or when visually checking information typed or entered on an accounting machine. In manual fields, keyed data must match the recorded data. The data is displayed on the screen; all characters up through the last character position verified are shown. The entire record is displayed at the beginning of the record, after any record backspace operation, or when an error occurs. If a verify error occurs, the keyboard locks; the display flashes, and an error code is displayed on the status line. The cursor indicates the position in the record in error. Pressing the reset key unlocks the keyboard and allows you to rekey a character. The rekeyed character is accepted as correct if (1) it matches the character originally entered or (2) it matches the verify stroke that caused the error condition. If another verify error occurs, the correction character is accepted only if one of the above conditions is met. (This procedure replaces the error notch and repunching required with cards.) The number of errors in a field may warrant the use of Field Correct. In this mode, an automatic field backspace occurs after the field is rekeyed, thus ensuring verification of the field.

Duplicate fields are compared, character by character, with corresponding data in the previous record. Skip fields are checked for all blank characters from the point of skip initialization to the end of the field. Duplicate and skip errors are handled just as errors are in a manual field.

Your program can Verify Bypass fields that do not require verification. Verify Bypass provides you with the capability to bypass a field without checking its content.

When the last record in the data set is verified, a verify mark is inserted in the data set label; this mark is reset if a record is added to the data set. The verify mark can be checked by the data converter to ensure that all data sets going into the system have passed through the verify operation.

## ADDING RECORDS TO A BATCH

If an error is discovered during verification, batch totals, or a count of the number of records in a batch, one or more records may have to be added. The best way to do this is to add the records to the end of a batch after the rest of the batch is verified.

Some data sets may contain sequence-sensitive records; that is, one or more fields within the records may be arranged in ascending or descending order. The demand for such sequences is usually set up by the computer programs that will eventually process the data. If missing records must be added sequentially, a machine equipped with disk copy can be used to perform this task by copying the data up to the appropriate address, inserting the record, and then copying the rest of the data. This procedure is described in detail in the 3741 and 3742 operator's guides listed in the Preface.

## RECORD INSERT

Another method of adding records to a data set is by using the record insert feature available on the 3741 and 3742. The record insert feature creates space (anywhere in a data set) for inserting records by moving existing data set records from the current disk address toward the end-of-extent (EOE) address of the data set. The number of spaces created can be up to 99. The feature fills the vacated space with deleted records. The deleted records are identified with a D in position 001 and a / (inverse slash) in position 002.

Once all of the spaces are filled with deleted records, the data station is placed in update mode and the disk address is displayed where the operator can begin to insert the additional records. For more information on the record insert feature, see the 3741 and 3742 reference manuals and operator's guides listed in the Preface.

## SEARCHING DATA ON THE DISK

Search mode replaces manual searching through records. The 3740 system offers the following capabilities:

### **Search on Record Address**

Search on record address allows you to find a particular record by specifying its disk address, which is its track and sector number. The search stops at the specified address and the CRT displays the record found.

### **Search on End of Data**

Search on end of data (EOD) finds the last record in a data set. This operation allows you to add additional records to a data set without (1) knowing in advance where the end of the data set is or (2) manually searching for the end of the data set.

### **Search on Content and Sequential Content**

Search on content and search on sequential content locate the record specified by a mask statement identifying the record's contents. Search sequential content is a faster search method for records in which the fields being searched are sequentially arranged. In either type of search, if the record is not found, an error is displayed.

### **DISK COPY**

The disk copy function copies data from one disk to another. Records can be merged both from disk two and the keyboard onto disk one. All disk two functions are fully independent of, and nonoverlapped with, disk one functions.

### **SECOND DISK**

The second disk feature provides the second disk capability on the 3741. The second disk allows disk operations and expanded storage for use with communications.

### **128 CHARACTER RECORD**

The 128-character record feature (3742 only) permits the use of variable length records up to 128 characters long. The feature also adds four more program levels per station.

Record length may be variable between data sets, but must be fixed within each data set. The record length is set in the label of the data set on the index track.

### **DISK INITIALIZATION**

This function allows the operator to reinitialize a disk if irregularities develop in a track during disk usage.

*Note:* It is not necessary to reinitialize a disk every time the disk is to be reused.

When reinitialization is necessary, this feature rewrites the track and sector addresses of each track so that the previously identified irregular tracks are automatically skipped. Each disk contains two spare tracks to replace any irregular tracks. In addition, the initialization feature provides a means of altering the sequence of sector address on the diskette. Normally, the sequence of sectors is in numeric order (1, 2, 3, . . . 25, 26). By changing this sequence, the data conversion, ACL program translation, and search on content rates may be increased. Sector sequencing is transparent to the operator when keying and should not affect operation or throughput capabilities. (See the IBM 3741 and 3742 reference manuals and the standard data interchange manual for further information.)

### **PRODUCTION STATISTICS**

The 3741 and 3742 count the number of records processed, the number of keystrokes used in entering data, and the number of keystrokes used in verify corrections; these three totals are stored in separate counters. Totals can be displayed on the CRT, and can be entered onto a disk. The keystroke counter automatically resets to zero when the count reaches 999,999. The record counter counts record advances in Enter, Verify, and Update modes. The verify correction keystroke counter counts verify correction keystrokes and all characters rekeyed in Field Correct mode.

## FIELD TOTALS

The most important application of the field totals feature is for batch auditing. This feature provides the ability to balance a field to a predetermined total, to create a batch control total, or to crossfoot and enter totals into the same record or a following record under program control. Under program control, data is summed algebraically. A total from at least one field in every record or in specified records of the batch is kept in one of the three 19-digit decimal accumulators. The 3741 and 3742 can compute the totals in an offline pass after the batch is keyed. The 3741 can compute the totals online while in Enter, Update, and Verify modes.

The field totals accumulators may be read out by displaying them on the CRT or they may be automatically written into a record under program control. For example, these totals might be read into another record if the last record was the final total of a bill. These totals can also be visually compared to some predetermined total — a batch audit total of catalog numbers, for example, to determine that every record was entered. If a record was missed or incorrectly entered, the field totals capability helps the operator correct the error by keeping track of the net changes as the operator rekeys the records. For example, if the operator rekeys a 5 when she previously had a 6, the machine records -1. Thus, when the net difference in the accumulator matches the amount by which the batch was out of balance, the operator knows that the error is found and that no further corrections are necessary.

## SELF-CHECK

Self-check checks the entry of numeric fields that have a last digit that was precomputed. When the field is keyed, the data station recomputes the self-check digit and compares it against the self-check digit that is entered. If the digits are not identical, an error is indicated. The machine goes into a wait state and waits for operator action to correct the error. Self-check fields can be entered manually or automatically under program control.

## PROOF KEYBOARD

The proof keyboard differs from a standard 3741 or 3742 keyboard only by a rearrangement of the numeric keys. The proof keyboard numeric key arrangement allows the operator who is more familiar with the adding machine key arrangement, to more effectively enter numeric data. For more information on the proof keyboard feature, see the 3741 and 3742 reference manual listed in the Preface.

## DATA RECORDER ATTACHMENT

The data recorder attachment feature attaches the IBM 129 Data Recorder (Model 2) or the IBM 5496 Data Recorder (Model 1) to a 3741. This feature allows a 3741 to read, punch, punch/print via a 129 (80-column cards) or a 5496 (96-column cards) data recorder. The 129 Model 2 reads cards at a rate of up to 50 cards per minute and punches cards at a rate of 11 to 39 cards per minute. The 5496 Model 1 reads cards at a rate of 21 cards per minute and punches cards at a rate of 17 cards per minute. The reading and punching of cards can be either formatted or unformatted.

The data recorders (online with a 3741) punch cards in four different modes. If the print switch on the data recorder is on, the cards are also printed. The four modes are:

1. Punch a record — The record in the 3741 current record buffer is punched.
2. Punch data set — The current data set is punched.
3. Punch under address control — The records found under search on record address are punched. This operation has the following characteristics:
  - a. If initiated from the index track, all the records from the first record in the data set, up to and including the record at the record address specified, are punched.
  - b. If initiated from a record address in a data set, all the records from that address, up to and including the record at the record address specified, are punched.
4. Punch under search on content — The records found under search on content are punched. Once the operator initiates the search, each record in the data set that satisfies the search criteria is punched.

The data recorders (online with a 3741) read cards in two modes:

1. Read a card — A single card is read.
2. Continuous card read — Cards are read and written to disk until a card with ?\* (indicates end-of-file) in columns 1 and 2 is read. The primary purpose of the continuous card read function is to perform card-to-disk operations in a batch environment. Single or multiple data sets can be created from a continuous card read operation.

This feature also allows the current record buffer to be formatted and written to disk.

*Note:* A data recorder does not have to be online for the 3741 to perform this function.

When not online with a 3741, the data recorders operate with their stand-alone functions.

## PRINTERS

Either the 3713, 3715, or 3717 Printer can be attached to the 3741.

### IBM 3713 Printer

The IBM 3713 printer is available as a feature on the 3741. Printing can be either formatted or unformatted; format control characters can be either entered by the operator or received from the host processing unit via telecommunications; up to nine formats can be loaded at one time. By using printer control programs, records can be reformatted during printing. The 3713 has vertical forms control and horizontal print control capability. The data set being printed can be continued from the first diskette to another diskette without any print forms interruption. For maximum throughput, printing should be left-justified. An *IBM 3740 System Print Chart, GX21-9187*, is available for use in print formatting.

The matrix printer prints from disk serially at a maximum rate of 40 characters per second and a maximum line length of 132 characters. Three different pin feed platens with pin-to-pin widths of 12-1/2" (31.7 cm), 13-1/8" (33.3 cm), and 13-7/8" (35.2 cm) are available. An adjustable margin feature is also available, which allows nine additional platens with pin-to-pin widths ranging from 7-1/2" to 11-1/2" (19.1 cm to 29.2 cm).

Six-part forms with a maximum thickness of 0.018" (0.46 mm) may be used, but for optimum feeding and stacking, IBM recommends using no more than three-part forms. Refer to *IBM 1443, 2203 Forms Design Considerations, GA24-3488*, for more detailed information on forms.

The 3713 can print in four different modes (either with or without program format control):

1. Print record — The current record is printed.
2. Print data set — The current data set is printed.
3. Print under address control — The record found under search on record address is printed.
4. Print under search on content — The records found under search on content are printed. Once the operator initiates the search, each record in the data set that satisfies the search criteria is printed.

### IBM 3715 Printer

The IBM 3715 printer is available as a feature on the 3741. Printing can be either formatted or unformatted; format control characters can be entered by the operator or received from a host processing unit via telecommunications; up to nine formats can be loaded at one time. By using printer format control programs, records can be reformatted during printing. The 3715 has vertical forms control and horizontal print control capability. An *IBM 3740 System Print Chart, GX21-9187*, is available for use in print formatting.

The 3715 is available in two models. The Model 1 prints at a maximum rate of 40 characters per second and the Model 2 prints at a maximum rate of 80 characters per second.

The 3715 has these characteristics:

- Comprehensive editing capability.
- Automatic continuation of printing from disk 1 to disk 2 when a data set on disk 1 is continued on disk 2 (if the 3741 has the second disk feature).
- Bidirectional printing (left to right and then right to left).
- The ability to use individual or continuous forms.
  1. Has an adjustable forms tractor that allows the use of various width forms.
  2. Has a pressure feed platen for individual forms.

The requirements for these forms are:

	Individual Forms	Continuous Forms	
Thickness			
	Multipart	0.004" to 0.018" (0.10 mm to 0.46 mm)	0.004" to 0.018" (0.10 mm to 0.46 mm)
	Single Part	0.004" to 0.0075" (0.101 mm to 0.190 mm)	0.004" to 0.018" (0.10 mm to 0.46 mm)
Width	3" to 14.5" (76 mm to 368 mm)	3" to 14.9" (76 mm to 378 mm)	
Length	6" to 14" (152 mm to 356 mm)	3" to 14" (76 mm to 356 mm)	
Number of Copies	6*	6*	

\*Five- and six-part forms should be tried for satisfactory feeding, registration, and print quality.

- A maximum print line of 132 characters.
- A fabric ribbon contained in a cassette case.
- Program chaining capability.
- Page numbering and page heading capability.
- Printing of constant data stored in program buffers.
- Ability to use 3713 and 3717 printer programs.

Stapled forms or continuous card forms cannot be used.

Refer to *IBM 1443, 2203 Form Design Considerations, GA24-3488*, for more detailed information on forms.

The 3715 prints in the same modes as described under *IBM 3713 Printer*.

## IBM 3717 Printer

The IBM 3717 printer is available as a feature on the 3741. Printing can be either formatted or unformatted; format control characters can be either entered by the operator or received from a host processing unit via telecommunications; up to nine formats can be loaded at one time. By using printer format control programs, records can be reformatted during printing. The 3717 has vertical forms control and horizontal print control capability. An *IBM 3740 System Print Chart, GX21-9187*, is available for use in print formatting.

The 3717 Printer has these characteristics:

- A print rate up to 155 lines per minute with a 48-character set; up to 120 lines per minute with a 64-character set. The character sets are interchangeable by exchanging print belts.
- A maximum print line of 132 characters.
- An engraved character font that increases the readability of printouts.
- Comprehensive editing capability.
- Automatic continuation of printing from disk 1 to disk 2 when a data set on disk 1 is continued on disk 2 (if the 3741 has the second disk feature).
- Program chaining.
- Page numbering and page heading capability.
- Printing of constant data stored in program buffers.
- Ability to use 3713 and 3715 printer programs.

The 3717 has an adjustable continuous-forms drive mechanism. The forms width can be from 3-1/2" to 14-7/8" (8.9 cm to 37.8 cm). The length of the form from fold to fold can be 3" to 14" (7.6 cm to 35.6 cm). Six-part forms with a maximum thickness of 0.020" (0.51 mm) can be used. Stapled forms or continuous card forms cannot be used. Refer to *IBM 1443, 2203 Form Design Considerations, GA24-3488*, for more detailed information on forms.

The 3717 prints in the same modes described under *IBM 3713 Printer*.

## BINARY SYNCHRONOUS COMMUNICATIONS ADAPTER

The binary synchronous communications adapter (BSCA) provides the 3741 Model 2 or 4 with the ability to function as a point-to-point terminal on switched or nonswitched facilities. Operation is half-duplex, synchronous, serial-by-character, serial-by-bit. EBCDIC is used directly as the transmission code. The Model 2 or 4 can communicate with either a 3747 with BSCA or another 3741 Model 2 or 4. The 3747 can communicate with either the 3741 Model 2 or 4 or another 3747 with BSCA. The 3747 and 3741 Model 2 or 4 can also communicate with a computer that has the appropriate communications adapter attached to it. (See index entry *configuration*.) Both the 3741 and the 3747 have autoanswer capabilities.

### Synchronous Clock

The synchronous clock feature provides internal clocking for the BSCA for use with modems that do not provide their own clocking. The bit rate for this feature is 1200 bits per second.

### Terminal Identification

A terminal with the identification feature gives the 3741 with BSCA the ability to transmit a four-character terminal identification sequence and compare a received identification sequence with a keyed-in sequence. The first character of the terminal identification sequence is the same for all machines; the next three characters are a factory installed sequence assigned by IBM and chosen from a random master list.

### Keylock

This feature prevents the 3741 from being placed in Communications mode until the keylock is unlocked. If the keylock is locked when the 3741 is already in Communications mode, it remains in that mode unless the operator takes the machine out of Communications mode. Once removed from Communications mode, it cannot be returned until the keylock is unlocked. The key can be removed from the locked position only.

### Operator Identification Card Reader

With the operator identification card reader feature, only authorized personnel are able to operate the terminal in Communications mode. The operator ID sequence may be transmitted if desired.

## Expanded Communications

The expanded communications feature provides the 3741 Model 2 or 4 with the following additional functions:

- Expanded buffer (512 bytes).
- Capability of transmitting selected fields.
- Capability of transmitting selected records.
- Capability of receiving data and inserting constants.
- Unattended printing after completion of communications, if the 3741 has a printer attached.

*Note:* The expanded communications feature provides the 3741 Model 4 with the capability to load (unattended) an ACL (application control language) program after the completion of communications.

Program buffers 8, 9, and A are used to store programs for transmitting selected records, transmitting selected fields, and receiving data and inserting constants. Each communications program that is loaded into a program buffer applies to only one data set. Therefore, during communications, only three data sets can have program control.

*Note:* The expanded communications feature allows a 3741 Model 2 or 4 to communicate with a 3747 having the blocking/reformatting feature (see *Data Conversion via the 3747*).

## Expanded Communications/Multipoint Data Link Control

The expanded communications/multipoint data link control feature provides the 3741 Model 2 or 4 with the same functions as the expanded communications feature, plus multipoint communications allow the 3741 Model 2 or 4 and other terminal devices to communicate with a processing unit on a shared multi-drop network. The 3741 Model 2 or 4 monitors the line and responds to its own polling and selecting sequence as appropriate.

In addition, an inquiry capability allows the operator to key a single record inquiry message, transmit the inquiry to a remote processing unit, and receive a response to the inquiry. Both the inquiry message and response to the inquiry are recorded on the disk and can be displayed by the operator.

*Note:* The expanded communications/multipoint data link control feature cannot be used when communicating with a 3747.



### 3741 AND 3742 FUNCTION AND FEATURE SUMMARY

Standard Function or Feature	3741 Models 1, 2, 3*, and 4*	3742**
Entering data	Standard	Standard
Updating data	Standard	Standard
Operator guidance	Standard	Not available
Program control: Program chaining Levels of program control	Standard	Standard
	10 Standard	6 Standard (4 additional with feature)
Verifying data	Feature	Standard
Record insert	Feature	Feature
Searching data on the disk: Search on record address Search on end of data Search on content and sequential content	Standard	Standard
	Standard	Standard
	Standard	Feature
Disk copy	Feature	Feature
Second disk	Feature	Not available
Record length	Standard 1-128	Standard 80
128 character record	Not available	Feature
Disk initialization	Feature	Feature
Production statistics	Feature	Standard
Field totals: Offline field totals Online field totals	Feature	Feature
	Feature	Not available

\* The functions and features in this summary apply to the Programmable Work Station (3741 Models 3 and 4) when it is not under ACL program control.

\*\* All functions common to the 3741 and 3742 operate the same way.

<b>Standard Function or Feature</b>	<b>3741 Models 1, 2, 3*, and 4*</b>	<b>3742**</b>
Self-check	Feature	Feature
Proof keyboard	Feature	Feature
Data recorder attachment feature	Feature	Not available
Printers: 3713 Printer 3715 Printer 3717 Printer	Feature	Not available
	Feature	Not available
	Feature	Not available
Binary synchronous communications adapter:  Synchronous clock  Terminal identification  Keylock  Operator identification card reader  Expanded communications  Expanded communications/multipoint data link control	Standard on Models 2 and 4  Not available on Models 1 and 3	Not available
	Feature on Models 2 and 4	Not available
	Feature on Models 2 and 4	Not available
	Feature on Models 2 and 4	Not available
	Feature on Models 2 and 4	Not available
	Feature on Models 2 and 4	Not available
	Feature on Models 2 and 4	Not available
	Feature on Models 2 and 4	Not available

\* The functions and features in this summary apply to the Programmable Work Station (3741 Models 3 and 4) when it is not under ACL program control.

\*\* All functions common to the 3741 and 3742 operate the same way.

## DATA CONVERSION VIA THE 3747

All diskettes to be converted to tape are delivered to the IBM 3747 Data Converter, which might be located in the data entry room or the computer room, depending on the installation. The operator loads a batch of diskettes and mounts a tape. The converter automatically feeds, reads, and stacks the diskettes, converting the data to computer compatible format and writing it on nine-track or seven-track 1/2" (1.3 cm) tape. These tapes are compatible with System/360, System/370 and other IBM tape systems, for which only normal tape processing program support is required. The 3747 can process multiple diskettes per data set and can handle multiple data sets per diskette. With the former, operator intervention is necessary only when starting and ending a job or during error recovery.

If error conditions arise, the 3747 activates an automatic error recovery routine. If the automatic routine fails to correct the error, a message is displayed on the operator's panel and the operator must initiate action. Information displayed on the operator's panel includes the number of diskettes read, the number of data sets on tape, the number of records input, the number of records skipped, the number of records output, and the address of the last disk record read. This information serves as a checkpoint for run procedures by showing whether the correct number of records were converted, the correct number of diskettes were read, etc. Thus, when an error occurs, this information helps isolate the error.

A control record is required for any job that uses the special features of the converter. These features include:

- Tape label processing – Checking and building standard IBM header and trailer records.
  - Erasing tape to the end-of-tape marker following the last data set.
  - Tape to disk conversion – Writing data from tape onto disk. By using the batching capability, a fixed number of records can be copied to any one disk.
  - Verify check option – Checking for verification of disk data sets before conversion to tape. The verify byte in the data set label is checked before the disk data set is converted.
- Communications – You may select from the following options:
    1. Autoanswer or manual answer.
    2. Nontransparent or transparent text.
    3. Identification verification through the terminal or far end device ID codes. These ID codes are specified as part of the control records and are checked automatically by the converter on a switched line.
  - Expanded functions – Increases operational control by:
    1. Adding records to an existing file on tape.
    2. Adding a file or replacing a file on tape.
    3. Checking label name on diskette.
    4. Writing conversion mark and checking on diskette.

The expanded functions feature improves communications operation by:

1. Unattended automatic answering.
  2. Multiple calls out using only one tape.
  3. Restarting without retransmitting data correctly sent.
  4. Restarting without duplicating data correctly received.
- Storage – Provides 2K, 4K, or 8K of storage to support the blocking/reformatting feature.
  - Blocking/reformatting – Provides the capability of:
    1. Blocking of records from disk to tape to increase the processing unit efficiency and communications throughput.
    2. Deblocking of records from tape to disk.
    3. Reformatting of data before recording on tape or sending over BSC entry into the processing unit. It includes deletion of records or fields, rearranging fields, inserting constants, and record splitting or joining.

Details on operation of the converter are found in the 3747 combination operator's guide and reference manual listed in the Preface.

## INPUT VIA THE 3540

Diskettes to be used as input to the System/370 are loaded into the IBM 3540 Diskette Input/Output Unit. This unit attaches directly to System/370. The 3540 feeds, reads, and stacks diskettes just like the 3747, but inputs the data directly to the system at high speed. The 3540 also takes data from the system and writes the data on the diskette. There are two models of the 3540, B1 and B2. Model B1 has a single diskette drive and the B2 has two diskette drives. Each drive is addressed independently, and all operations are fully overlapped: read/read, read/write, write/read, and write/write. Double buffering optimizes performance by allowing the 3540 to process data previously stored in a buffer. More than one 3540 can be attached to the System/370: the total number depends on the number of system control unit positions available. Each 3540 operates independently of the others, regardless of the number of units.

If an error condition occurs, the 3540 activates an automatic error recovery routine. If this automatic routine fails to correct the error, a message is displayed on the operator's panel and the operator must initiate action.

The programming support for the 3540 is especially suited for processing information created by the 3740 system. This support includes:

- DOS/VS supports the 3540 using the sequential access method (SAM) for logical input/output control system (LIOCS) and the system logical units: system reader, system input, system punch, and system list. The 3540 may also be a spooled input device under POWER.
- OS/VS1 supports the 3540 as a system input/system output device. This support includes the capability to submit data separately from the job (JCL). After the data is submitted, it is associated with the job, spooled, and scheduled for execution.

For more information about the 3540, refer to *DOS/VS System Information for IBM 3540 Diskette Input/Output Unit*, GC21-5072, *Planning Guide for OS/VS1 Support of the IBM 3540*, GC24-5106; *IBM 3540 Diskette Input/Output Unit Operator's Guide and Programmer's Reference*, GA21-9197. For installation planning information, refer to *IBM System/370 Installation Manual and Physical Planning*, GC22-7004.

The 3741 Programmable Work Station can be used in many installations to expand the key entry function. The work station has all the functions of the data station, plus it allows you to control all input and output functions, arithmetic and logical operations, and to guide the operator through the application. These additional functions are possible through a programming facility called *Application Control Language (ACL)*.

An application programmer, familiar with data entry devices and operations, will find ACL an excellent tool for implementing work station applications. ACL program source statements consist of control statements and instructions. Control statements give the output object code a program name, define data sets and access methods, specify data formats, provide printer control information, and designate the end of the program. Instructions initiate input/output operations, internal data movement, branching, arithmetic operations, and table searching.

The work station, when not under ACL program control, functions like the data station. The Model 3 has the same functions as the Model 1 and the Model 4 has the same functions as the Model 2.

### FUNCTIONS UNDER ACL PROGRAM CONTROL

In addition to its functions as a data station, the 3741 Programmable Work Station has the following functions under ACL program control.

- *Expanded arithmetic* including add, subtract, multiply, and divide operations that make possible additional field totals, zero balancing, and crossfooting operations.
- *Data checking* including range checking, unit checking, table search, and diskette file search.
- *Data manipulation* which allows data to be reformatted before it is written on a diskette, displayed, or printed.
- *Additional keyboard and display* including displaying prompting messages for data entry, option selection, or error conditions.
- *Additional disk access methods* which allow processing of multiple data sets, reading and writing on two disk drives, and creating and maintaining data set indexes that provide fast access to online data.
- *Overlapped printing* which allows the operator to key data while printing.
- *Ability to check or generate self-check numbers* which allows the programmer to specify any modulus from 1 to 127, and the characteristics of the algorithm to be used.

### FEATURES AVAILABLE WITH THE PROGRAMMABLE WORK STATION

The 3741 Programmable Work Station has the following features available, in addition to the features available for the 3741 Data Station.

#### ACL Translator

The ACL translator feature translates ACL source programs into object programs for the programmable work station. The ACL translator feature is only required on programmable work stations used to generate object programs. The object programs can then be executed on any programmable work station. The printer and second disk features are required for the ACL translator feature. IBM recommends that the programmable work stations with the ACL translator feature have the record insert feature to allow easy source program maintenance.

#### Storage, 4K Additional

The storage, 4K additional feature provides the programmable work station with 32 additional general purpose, 128-byte buffers.

# System Design Considerations

## JOB SCHEDULING AND WORK FLOW

The adjacent diagram shows the work flow in a typical centralized data entry operation:

- 1 Source documents collected at a point central to the data entry operator are logged into the control center and, if necessary, divided into batches.
- 2 After the data has been keyed, the diskette removed from the machine, and the external label updated, the diskette and the source documents are returned to the control center.
- 3 If the batch is to be verified the control center assigns a verify operator.
- 4 The control center collects the various batches of diskettes that comprise a job and places them together for conversion to computer tape by the 3747 or for direct input to the processing unit via a 3540. Source documents are either held for initial computer output or set out for pick up by the originating department.

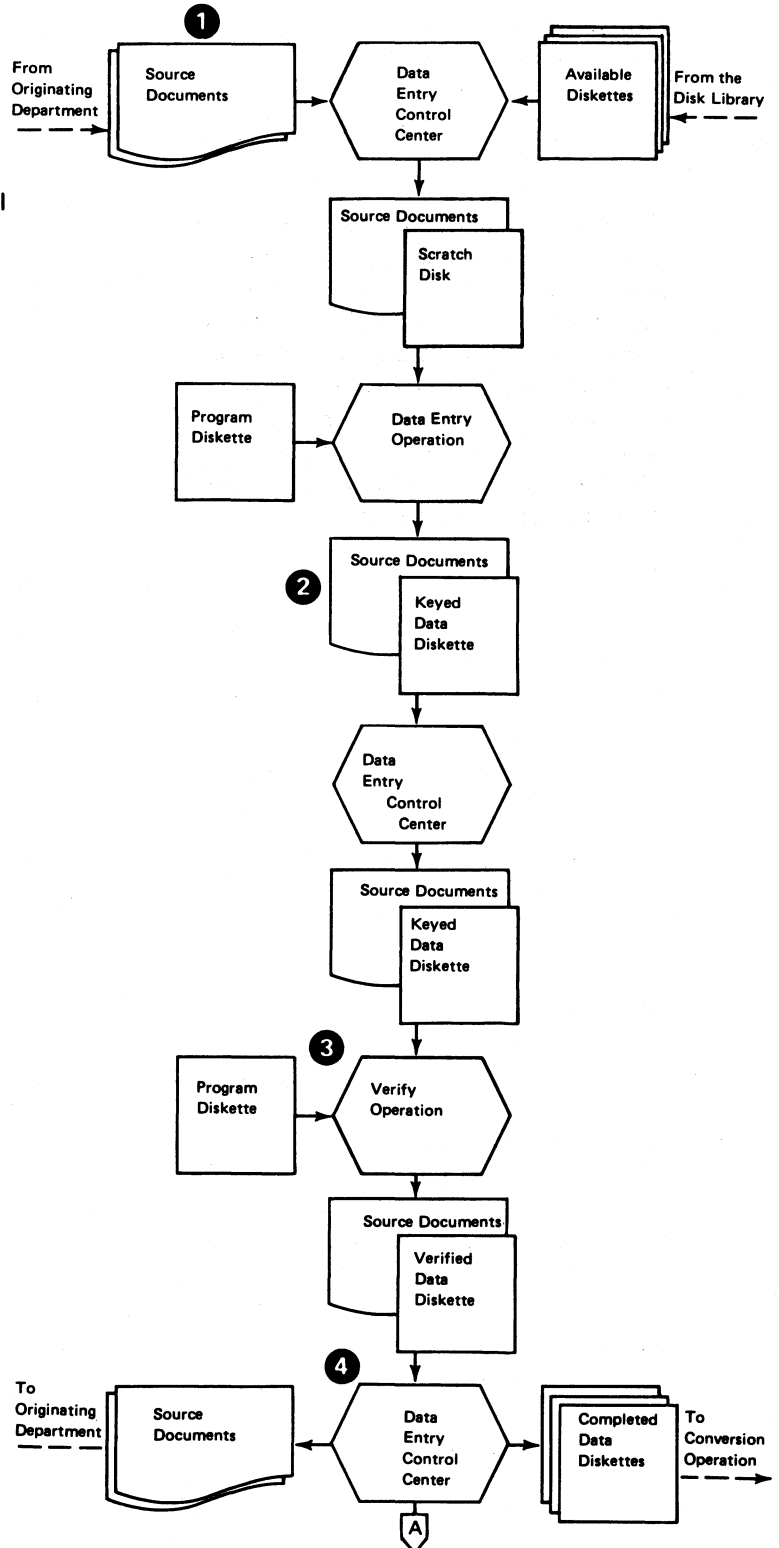

- 5 Diskettes transcribed to tape are returned to the control center and placed in a suspense file. If corrections are needed, the diskettes are sent back to data entry. Once the data is accepted by the computer, the diskettes are removed from the file and placed in a scratch file for reuse.

Basically there should be little change required in present procedures to schedule work through a 3740 installation. To maintain job schedules, structure them to reflect each operator's input to a diskette, sharing of batch keying, batch verifying, etc. Rush jobs can be broken into small batches for assignment to multiple 3740 stations. The 3747 then combines the output from these stations on a single computer tape.

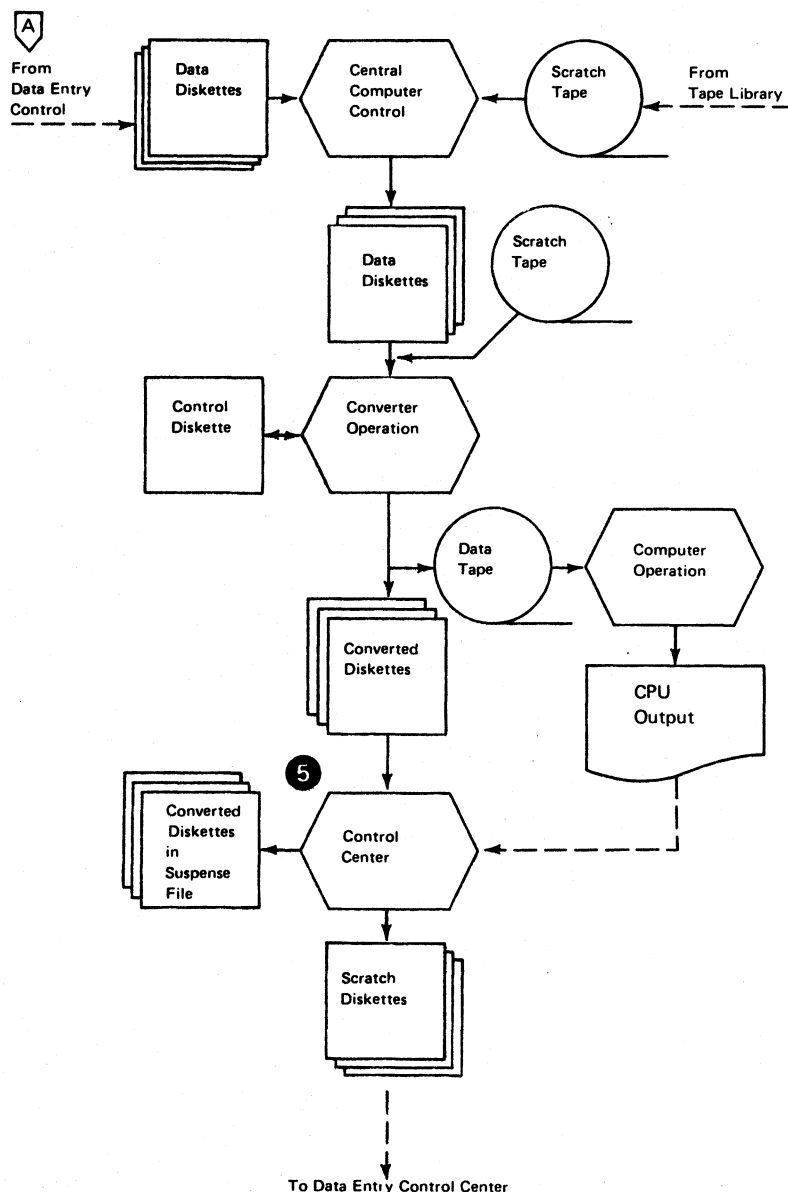

## DATA LABELING ON THE DISKETTE

During initialization, the data set label for a data set is magnetically recorded on the index track (track 00) of the diskette. The primary purpose of this label is to show the location of the data set on the diskette. The label can also be used to identify the data set by name. The degree to which the name field in the label is used is optional. An installation plan that calls for one or any of the following could require use of the diskette label for proper processing of data:

1. Attachment of a 3540 Diskette Input/Output Unit to the system (the 3540 Diskette Input/Output Unit recognizes discrete data set label names when reading the diskettes).
2. The addition of the tape label feature to the 3747 Data Converter (when creating tape labels on the 3747, the label name is taken from the diskette label).
3. The use of multiple data sets on a single diskette.

The 3747 operator's guide and reference manual, the 3741 and 3742 reference manuals, and the standard data interchange manual (all listed in the Preface) contain detailed information as to what data must be in the labels.

## SINGLE AND MULTIPLE DATA SETS PER DISKETTE

One of the earliest systems design decisions to make is whether to use single data set diskettes only or to allow multiple data set diskettes as well. A single diskette may hold multiple data sets, but for easy management of the work flow, keying only one data set on each diskette is recommended.

There are many advantages to keying single data sets on diskettes. (Programs for a specific job can be stored on the diskette that contains the job data set.) One significant advantage of keying single data sets is that work scheduling and distribution is kept simple. No coordination of retention and conversion cycles, of key entry operations, or of data set grouping is necessary for regular jobs. Since jobs are scheduled independently, there are no delays; each job proceeds through the shop according to its usual schedule. Therefore, there are no unknowns in job completion, or efforts spent in creating new schedules. Once keyed, data sets are simply converted to tape, ready for processing.

If a diskette containing multiple data sets is to be processed, some specially designed procedures apply, which provide for proper handling of individual data sets. For example, if data on a diskette is to be converted (or transmitted), and that diskette also contains another data set that needs to be converted (or transmitted), these procedures ensure that the system will differentiate the data sets. (See the 3747 operator's guide and reference manual listed in the Preface for a discussion of these procedures.)

## DATA RECOVERY

Operators will make errors on 3740 stations just as they do with traditional equipment. If an operator should mistakenly write over data that has not yet been converted, the data must be recreated from source or backup materials. To recover a partially destroyed data set, it is important to re-establish the EOD (end of data) address. Operating procedures for recovery of EOD address for overwritten records are found in the 3741 and 3742 reference manuals and operator's guides listed in the Preface.

Although diskettes rarely develop irregularities through wear, irregularities may occur if some foreign material has been present on the diskette. Each installation should have a standard procedure to be followed in case a data record cannot be read or written onto a diskette. If the station has the copy function, the best data recovery procedure is to copy the data onto a new diskette and manually key in the affected records. Alternate methods depend on the mode of operation the station is in at the time the disk error is encountered. (See the 3741 and 3742 operator's guides for information about alternate procedures.)

The operator should make note of diskette irregularities on the external label of the diskette. After data on an irregular track has been recovered, the diskette should be re-initialized, excluding the irregular track(s) and substituting one or both of the alternate tracks provided. If both of the alternate tracks are used up, consider the following before replacing the diskette:

1. Is the new error on one of the first few tracks? (This is apt to be the case since these tracks will be used on most or all jobs.) If so, you can easily modify the data index track to skip the bad track and all tracks that precede it, and simply start recording further into the diskette.
2. Is a full 1898 record capacity necessary? Many installations key work batches that are 300-500 records in size. These would not require a full diskette capacity.



**GENERAL GUIDELINES**

When planning your installation, you may find it beneficial to use the following chart and associated list events to ensure that you omit nothing in your planning. The numbers on the chart refer to installation events, which are ordered in a recommended sequence. These events are represented on the chart so as to show a time relationship; the line length does not indicate how long an activity lasts.

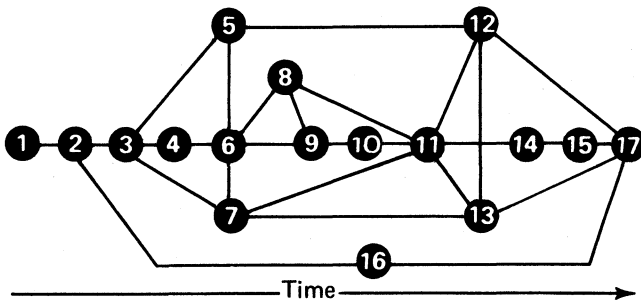

**Events**

- 1 Order and schedule installation of 3740 system.
- 2 Have Systems Analyst attend implementation course (see Note 1).
- 3 Select initial jobs to be converted.
- 4 Evaluate requirements for supervisor/lead operator training (see Note 1).
- 5 Review and modify programs to accept tape or diskette as input rather than cards (see Note 2).
- 6 Establish a diskette control procedure (see Note 3).
- 7 Review and modify keypunch documentation and procedures to reflect 3740 use and changes in terminology (see Note 4).
- 8 Establish requirements for and order diskettes. (see Note 5).
- 9 Install initial 3740 station for practice and training purposes; install 3747 (see Note 1).
- 10 Train supervisors/lead operators on 3740 station; train 3747 operator (see Note 1).
- 11 Try keying data on 3740 system.
- 12 Test computer runs using new media as input instead of cards.
- 13 Test documentation, keypunch procedures, diskette control.
- 14 Phase in 3740 stations for operator training (see Note 1).
- 15 Train operator on 3740 stations; practice keying selected applications (see Notes 1 and 4).
- 16 Plan and prepare physical site (see Note 6).
- 17 Convert applications to full production keying.

*Notes:*

The following are chapters or titled sections in this manual that are given for reference.

- 1. Training and Education
- 2. System Programming Considerations
- 3. Diskette Control
- 4. Documentation
- 5. Estimating Diskette Requirements
- 6. Physical Installation Planning

Although each data entry installation is unique (installations vary in size as well as in application), many general principles apply to all installations and provide the broad guidelines that follow. The success of any system is directly related to the planning that precedes its installation.

**ESTIMATING DISKETTE REQUIREMENTS**

The number of diskettes needed to support each data station in the 3740 system depends on job parameters

and installation policies. The following checklist can serve as a guide to estimating average requirements and will cover factors tending to increase or decrease requirements from the average.

### Centralized Data Entry

**Batch Size:** One diskette should normally be estimated for each separate batch which an operator keys in a day.

In some applications prompt customer service dictates that keying be broken into many small batches; this leads to increased diskette requirements.

**Machines Used to Verify:** Machines that are steadily used for verifying do not require additional diskettes and should be excluded from the estimates. However, each 3740 station can also be used for keying. If you anticipate that, due to the nature and scheduling of jobs, all or most stations may be used for keying on some days of the month, then diskettes should be provided to support those machines when they are used for keying rather than verifying.

**Retention Cycle:** Normally you will retain the diskette after keying for at least one day prior to reuse, just as cards are retained until processing is assured. Diskettes are then used only every other day, which increases diskette life. Twice the daily diskette quantities will be needed to satisfy data retention requirements.

**Data Storage for Weekly Runs:** In some cases, input for weekly computer runs arrives and is keyed daily but is retained in key entry until the weekly computer run. Therefore, batches will be accumulated on disk and stored at the 3740 stations. Such storage periods must be accounted for in your estimate.

**Peak Load:** If monthly, quarterly, or annual peaks result in overtime and an increase in data keyed, diskette requirements will be affected.

### Local Source Department

When machines are placed in local source departments such as payroll or accounts payable, requirements can be estimated the way they are in centralized data entry. Reduction in diskette requirements because of larger batches is partially offset by longer retention cycles caused by diskette 'float' in the interdepartment mail system.

### Remote Source Department

Units in remote locations usually create larger batches on a diskette to facilitate data communications. Diskettes should be retained at least one day to assure that good data has been received by the home office computer. Additional spare diskettes should be maintained at remote sites if it is difficult to obtain additional diskettes quickly.

### Example of Estimating Diskette Requirements

The following example can be used for comparison with your own considerations:

- Installation consists of twelve 3740 stations
- One fourth of all machine time is used for key verifying
- Each operator keys four batches of data per day
- Each batch of data is recorded on a separate diskette
- The retention cycle is such that a diskette can be reused every third day

To determine how many diskettes are needed, first calculate the number of stations used entirely for entering data.

1.  $\frac{1}{4}$  of 12 = 3      Although each station will be used for entering as well as for verifying data, the equivalent of three stations will be dedicated entirely for verification purposes.
2.  $12 - 3 = 9$       This is the number of stations used entirely for entering data.
3.  $9 \times 4 = 36$       The number of stations times the number of batches per day per operator equals the number of diskettes needed each day.
4.  $3 \times 36 = 108$       Diskettes can be reused every third day; therefore, three days of diskettes are needed.
5.  $1 \times 12 = 12$       It is recommended that each operator should have her own program diskette.
6.  $108 + 12 = 120$       The total number of diskettes needed is the sum of steps 4 and 5.

**Summary**

- At least one diskette per machine should be allocated for storage of programs.
- An additional diskette may be desired for recording of daily production statistics.
- Contingencies should be provided for if off-the-shelf delivery of purchased diskettes is not available locally.
- Additional diskettes for control records may be needed if 3747 features are used.

jobs can still be used as the basis for creating key entry programs for the 3741 and the 3742.

The following is a sample key entry program for a record to be keyed on a standard 3740 data entry station:

```
A.....N-----R-----
D-----N-----A.....S---E
```

The 'A' denotes an alphabetic field, the N numeric, 'R' a numeric right-adjust, 'D' a numeric auto dup, 'S' a numeric skip field, and 'E' end of program. Dots and dashes are used to represent alphabetic and numeric field continuation characters respectively. For a complete list of program codes, see Figure 14. These codes are also printed on the backs of the *3740 Job Instructions, GX21-9186* (see Figure 15) which is used to convey information to the operator.

**KEY ENTRY PROGRAMS**

Job descriptions used for current card punch and verify

	Code	Verify Bypass	Shift	Function
Begin field codes	N	V	Numeric	Manual fields
	A	W	Alpha	Manual fields
	J	Y	Numeric	Right adjust, blank fill
	R	X	Numeric	Right adjust, zero fill
	I	Z	Alpha	Right adjust, blank fill
	B			Bypass
	D		Numeric	Automatically duplicates
	U		Alpha	Automatically duplicates
	S		Numeric	Automatically skips
	K		Alpha	Automatically skips
Continue field codes	-		Numeric	Continues field in numeric shift
	.		Alpha	Continues field in alpha shift
End program code	E			Marks end of program
Feature begin field codes	H		Numeric	Self-check, modulus 10
	C		Numeric	Self-check, modulus 11
	F		Numeric	Auto skip, self-check, modulus 10
	G		Numeric	Auto skip, self-check, modulus 11
	L		Numeric	Auto dup, self-check, modulus 10
	M		Numeric	Auto dup, self-check, modulus 11
	Any begin field character followed by 1, 2, or 3.			
B (bypass character) followed by 4, 5, 6, 7, 8, or 9.				Field totals read out

Figure 14. Program Codes



### 3740 Job Instructions

Page \_\_\_\_\_ of \_\_\_\_\_

Date \_\_\_\_\_

<b>Job Name</b>		<b>Job No.</b>		<b>Op. Code</b>		<b>Program Level</b>		<input type="checkbox"/> Enter <input type="checkbox"/> Verify	
						<b>Record Length</b>			
<b>Frequency</b> <input type="checkbox"/> Daily <input type="checkbox"/> Monthly <input type="checkbox"/> Weekly <input type="checkbox"/> Quarterly <input type="checkbox"/> Bi-weekly <input type="checkbox"/> Annually <input type="checkbox"/> Semi-monthly <input type="checkbox"/> Other		<b>Due in</b>		<b>Due out</b>		<b>Estimated Volume</b>		<b>Est. Time</b>	
		Time	Date	Time	Date			Hours	Tenths
<b>Switch Settings—On:</b> <input type="checkbox"/> Prog Num Shift				<b>Disposition of Disk</b>					
<b>Source Documents Used:</b>				<b>Section</b>		<b>Job No. or Dept.</b>		<b>Operation</b>	
<b>Received From:</b>				<b>Disposition of Documents</b>					
<b>Field Name</b>		<b>Function</b>		<b>Columns</b>		<b>Remarks</b>			
				<b>From</b>	<b>Through</b>				
1.									
2.									
3.									
4.									
5.									
6.									
7.									
8.									
Total key strokes per record									

Figure 15. Job Instruction Sheet

**Note:** IBM recommends that all programs be made the same length for each data set, regardless of actual record length, and that the longest actual record length be the length given to each program.

There are two basic approaches to creating programs: The first approach is used in many of today's card punch installations, where each operator is responsible for making and maintaining her own program cards. However, for initial efficiency when installing 3740s, the second approach — creation of a master program diskette — is suggested. This approach involves having a supervisor, lead operator, or system engineer create all of the programs for every operator in the installation. One diskette can hold as many as 1898 programs. A copy of the master program diskette is made for each operator, who then has her own program diskette, as in the first approach; the only difference is that it was prepared centrally. Centrally prepared program diskettes can be maintained by changing existing programs or adding new ones to the master program diskette and making copies for each operator. The effective date of the program diskette can then be noted on the external label to indicate whether the program diskette is the latest

version. The master program diskette approach provides the advantage that the operator does not have to concern herself with making programs during her initial training period.

With either method of program diskette preparation, the programs must be organized in some manner so that they can be located again. The simplest approach is to key the programs on the diskette in any desired sequence, keeping track of the addresses, then locating the record by searching for the record address (called Search on Record Address). (See Figure 16.)

Programs can also be located by name. A header record then precedes each program and is located by searching for the name of the header record (this operation is called a Search on Content operation).

If it is desirable to record programs on the same diskette that is used to record and verify data, programs should be kept in a separate data set. For more information about program preparation and location, see the 3741 and 3742 operator's guides and reference manuals listed in the Preface.

Job Number	Address			Name
	Track	Sector		
24	01	0	01	Accounts receivable (header)
24	01	0	02	Accounts receivable program 1
24	01	0	03	Accounts receivable program 2
25	02	0	01	Payroll (header)
25	02	0	02	Payroll program 1
25	02	0	03	Payroll program 2
25	02	0	04	Payroll program 3
26	03	0	01	Accounts payable (header)
26	03	0	02	Accounts payable program 1
26	03	0	03	Accounts payable program 2

Note that header records are used in the example. Even though the programs are arranged so that they can be located by address, the inclusion of header records containing the names of each program is helpful in establishing that the right program has been found.

Figure 16. Sample Program Address Sheet

## DISKETTE CONTROL

The three primary factors in diskette control are diskette labeling, diskette library maintenance, and physical handling of the diskette.

### External Labels

There are two kinds of diskette labels: external and internal (data set) labels. See *Data Labeling on the Diskette*, in this manual, for information about internal labels.

External labels are visible labels that are physically attached to the diskette. Two kinds are useful. The first type is the permanent diskette label, which contains information such as diskette serial number and the date the diskette was received from the manufacturer. These permanent labels are affixed to the upper left corner of each diskette. It is recommended that a ballpoint pen be used to write information on these labels.

The second type of external label is usually a paper label with adhesive backing. This label is for information such as what data is recorded on the diskette — (job name and number), who keyed the data, whether the data is verified, whether it has been converted for processing, and the date the job is being processed. IBM recommends that this label be no larger than 2.0" by 5.5" (5.1 cm by 14.0 cm) and that it be affixed to the diskette just to the right of the permanent IBM label. This label can be designed to fit your procedures.

Information should be written on the label while the diskette is in the envelope to prevent damage and contamination of the recording surface. The diskette envelope is designed with a slot which exposes this label for access. When a new job is begun, the old label information should be crossed out — not erased. Eraser particles could get inside the diskette permanent envelope and interfere with its being read.

In addition to keeping the diskette clean, this process provides an audit trail. When the entire label is full, it should first be removed, then be replaced by a new label. (If new labels are simply pasted on top of the old labels, the label buildup can affect machine performance.) Don't affix labels to the reverse side of the diskette and don't cover any of the holes in the diskette. Labels

should be replaced every six months; otherwise the adhesive may harden and make label removal difficult.

Colored labels is a good way to convey information at a glance. Each installation can work out a system to increase the security of certain classes of diskettes and reduce handling time and other requirements. Color coding for a hypothetical insurance installation could be:

- Red labels — Reserved for program storage; not to be used for data.
- Green Labels — For general data use; available for data keying if the label shows that the previous job was dumped.
- Blue Labels — Reserved for keying claims, which are 65 percent of the installation workload. Keying program is repeated on each disk (information in the index track tells the converter to bypass the program when dumping disk to tape).
- Yellow Labels — Local or personal files not to be used for general data (operator or job statistics, lists of job charge numbers, ACL source and object programs, etc).

To avoid mismatching the diskette and envelope, no information should be written on the protective cardboard envelope.

### Diskette Library

The second major factor in diskette control is the diskette library. Setting up and maintaining an effective diskette library is more than a matter of providing storage space; it is establishing procedures that are reliable and integrated with the operations of the total data processing system. Diskette control should involve procedures that are simple and constant for all applications. Several possible library systems would satisfy these conditions. One possible system, based on the use of four storage areas for diskettes passing through the data processing cycle, is as follows.

After a diskette is received from the manufacturer, it is given a serial number and an entry is made on a master diskette log sheet. (see Figure 17.)

<b>MASTER DISKETTE LOG SHEET</b>		
<b>Serial Number</b>	<b>Comments</b>	<b>Date Received</b>

Figure 17. Sample Master Diskette Log Sheet

The diskette is then placed in the scratch file containing all diskettes that are available for immediate use. The key entry operator goes to the scratch file to select a diskette for use. A blank job card (see Figure 18) is inserted in the envelope of each scratch diskette. This card is used to show the status of the job as it progresses through the installation. Once the source data has been keyed, the job card is updated, showing such information as job number, job name, date, diskette serial number, operator's initials, and the number of records keyed. (If production statistics are not used, the conversion table found in the 3741 and 3742 reference manuals can be used to obtain an accurate record count.)

Next the diskette, job card, and source documents are placed in a "to be verified" storage area. The verify operator verifies the data, updates her portion of the job card, and places the diskette, etc, in a hold-for-conversion storage area, where it remains until any other diskettes for the job are completed and are also placed in the hold area. After the diskettes have been converted to tape and the job card is updated, they are placed in a suspense file. They remain there until the computer application using that data has been processed. The diskettes are then removed from the suspense file and placed in the scratch file to begin another cycle. The job card becomes a history card for that particular diskette and is filed by serial number.

<b>Job and History Card</b>	
Job # _____	
Job Name _____	
Date _____	
Serial _____	
KP # _____ Volume _____	
KV # _____ Errors _____	
Tape Number _____	
Release OK _____	
Release Date _____	
Miscellaneous	

Figure 18. Sample Job Card

## Care and Storage of the Diskette

The third factor in effective diskette control is the proper physical handling of the diskette. It is important to establish policies to ensure proper handling. The following points should be considered:

- Keep the diskette in the protective cardboard envelope provided when the diskette is not being used. The diskette should be placed in the envelope before writing on the adhesive label so that the label is visible through the cut-away front of the envelope.
- Do not write on labels with an erasable writing instrument. Use a ballpoint pen.
- Handle the diskette by the label area to avoid touching the recording surface. Fingerprints on the surface may cause permanent diskette errors.
- Carry the diskette in a file folder or carrier envelope.
- Keep office utility magnets away from the diskette.

If a diskette is physically damaged or if the recording surface becomes contaminated with foreign material, it should be replaced. Diskettes should be stored in the protective envelope in an upright position. They may be used in most environments that are neither wet nor dusty — environments that are relatively unaffected by climatic variables. If diskettes are mailed, they should be placed in a box or heavy cardboard mailer. Refer to the standard data interchange manual (see the Preface) for comprehensive information regarding diskette handling.

## DOCUMENTATION

An essential part of installation planning is reviewing and updating records containing a vast amount of detail on the various aspects of running an installation. Although many procedures may require no modification at all, some procedures may be modified to take advantage of a new capability or feature available through the 3740 system; also, any missing documentation must be created.

To allow operators to focus their full attention on building speed and productivity on the new units rather than on filling in gaps in the documentation, documents containing special keying instructions should be revised to reflect 3740 terminology. For example, job steps for correcting errors during verification should be rewritten to include correction while verification is in process; references to terms such as verify punches, overpunching, header cards, etc., should be removed.



Documentation for the 3741 Programmable Work Station depends on the programming for each application. It is the programmer's responsibility to provide documentation and training for the operator for each job.

To aid the operator in running the job, a job run sheet and step-by-step instructions should be provided. The job run sheet should include:

- Job name and number.
- Name, location, and telephone number of the programmer.
- Printer setup instructions.
- Diskette data set label specifications.
- Instructions for starting the program.
- Instructions for ending the job.
- Instructions for aborting or continuing the job if a system error is encountered.
- A summary of special keys and functions.

A sample job run sheet is shown in Figure 19.

Step-by-step instructions should be provided to supplement prompting messages to the operator.

Documentation will be needed for the 3747 data converter operations. Procedures must be written to include such functions as:

#### *Job Setup*

- What function is to be performed in this run (that is, diskette-to-tape, tape-to-diskette, etc)?
- Will a control diskette be required to perform this job?
- Will a labeled or unlabeled tape be required?

#### *Error Recovery*

- What action should the operator take if an operational error occurs (job setup instructions specify a labeled tape but an unlabeled tape has been mounted; expiration date on tape is greater than date keyed in at job setup time, etc)?
- What action should the operator take if an unreadable/unwritable record is found (should the record be skipped, the job terminated, etc)?

#### *End of Job*

- Should job statistics be taken?
- What disposition of the diskettes and tape is required after the job is completed?

The IBM 3747 Data Converter Run Sheet, GX21-9185, (see Figure 20) can be used to document the necessary procedures.

IBM 3741 Models 3 and 4 Job Run Sheet

Items with a box  are optional and can be ignored unless checked

Job Name \_\_\_\_\_ Job Number \_\_\_\_\_

Programmer \_\_\_\_\_ Location \_\_\_\_\_ Telephone \_\_\_\_\_

*Printer Setup*

Form Number/Description \_\_\_\_\_

Single  Double  Space 1 2  3 4 5 6 Part Form

Printer Alignment

*Starting Program*

Drive 1 Diskette \_\_\_\_\_

Drive 2 Diskette \_\_\_\_\_

*Program Identification*

Program Identification:  will be displayed when drive 1 is ready.  
 is written on the diskette. Press REC BKSP \_\_\_\_\_ times until it is displayed.  
 must be keyed. Press FUNCT SEL lower and DELETE REC to clear the display, then key the program identification.

After the program identification is displayed, press FUNCT SEL upper then E.

*Ending the Job*

\_\_\_\_\_  
\_\_\_\_\_

*Aborting the Job*

To continue after aborting

*Summary of Special Keys and Functions*

\_\_\_\_\_  
\_\_\_\_\_  
\_\_\_\_\_  
\_\_\_\_\_  
\_\_\_\_\_  
\_\_\_\_\_  
\_\_\_\_\_  
\_\_\_\_\_  
\_\_\_\_\_  
\_\_\_\_\_  
\_\_\_\_\_

Figure 19. Sample Job Run Sheet



### 3747 Data Converter Run Sheet

Job Name \_\_\_\_\_ Job Number \_\_\_\_\_

Operator's Name \_\_\_\_\_ Date \_\_\_\_\_

#### DESCRIPTION

- Disk to tape
- Tape to disk
- BSC to tape
- Tape to BSC
- Labeled tape ID number \_\_\_\_\_
- Unlabeled tape ID number \_\_\_\_\_

Control disk number \_\_\_\_\_ Control record number \_\_\_\_\_

#### DISK ID NUMBERS

Tape file 1	Tape file 2	Tape file 3
1. _____	1. _____	1. _____
2. _____	2. _____	2. _____
3. _____	3. _____	3. _____
4. _____	4. _____	4. _____
5. _____	5. _____	5. _____

#### JOB STATISTICS

	File 1	File 2	File 3
1. Disks read/written	_____	_____	_____
2. Tape file	_____	_____	_____
3. Input records	_____	_____	_____
4. Records skipped*	_____	_____	_____
5. Output records	_____	_____	_____
6. Last disk record address	_____	_____	_____

\* Display and record all job statistics for any error conditions on the back of this sheet.

Comments: \_\_\_\_\_  
\_\_\_\_\_  
\_\_\_\_\_  
\_\_\_\_\_

Figure 20. Data Converter Run Sheet

## SYSTEM PROGRAMMING CONSIDERATIONS

A review of all computer programs may be required, depending on the change of input medium. If tape is replacing card decks, some software modifications will be necessary. In general, the best approach to program modification is to begin with the largest volume jobs. Data from the 3740 to be used as input to a programming system can be in the form of 1/2" (1.3 cm) magnetic tape from the 3747, or it can be in the form of the diskette to be used as input via the 3540. No special tape programming support is required to process the tape from the 3747. The input from this tape will be unblocked and either labeled or unlabeled, depending on the option chosen. The 3540 has programming support especially suited for processing information created by the 3740 system.

Replacing an existing data entry installation with tape input to the processing unit can involve the following:

- JCL changes only
- Application program changes
- No changes when replacing certain tape input

The considerations discussed in this chapter refer to both OS and DOS unless otherwise noted.

### Card Replacement

There are normally two modes of entering card data to a programming system: directly to a processing program or in stages through the SYSIN facility. The former mode may be simply a preprocessing program that provides a labeled tape for direct input to the main processing program. When a card-to-tape utility pools data and creates a tape file for input to the system, the 3747 can do the same job and thus save system time. The 3747 can create an unlabeled or labeled tape for direct input to the application program. If a SYSIN file is used, the 3747 can create the SYSIN file on tape either by pooling JCL disks and data disks or by creating tape from disks on which JCL records have been keyed in with the data. The operator assigns the system reader to the tape instead of to a card reader. The SYSIN procedures assume that all records are 80 characters long.

If the job is being run in OS using a cataloged procedure, each new collection of data on the SYSIN tape must include a record of the form:

```
//procstepname.ddname DD DATA
```

Only JCL changes are required if the tape is input directly to a job (private volume concept) or if labels are added to the input file. These will be the most common changes in an installation.

When only a change in medium is involved (that is, tape instead of card), the device assignment is all that needs to be changed. The DOS change is:

```
From: //ASSGN SYSIPT,X'OOC' or
```

```
ASSGN SYSIN,X'OOC'
```

```
To: //ASSGN SYSIPT,X'181' or
```

```
ASSGN SYSIN,X'181'
```

This change assumes that the input is part of the SYSIN (SYSRDR/SYSIPT) file.

In OS the change is:

```
From: //DATA DD DATA
```

```
To: //DATA DD UNIT=TAPE,DS NAME=DATA,  
LABEL=(,NL)
```

These changes assume that the application program does not have device dependent code (such as stacker select) and is not using a card DTF or DCB control block.

When the 3747 supplies a labeled input tape, the JCL changes include:

- For DOS, add the statement:  
//TLBL...
- For OS, change the existing statement to:  
//DATA DD ...,LABEL=(,SL),...

If the application that is switching from card to tape input uses device dependencies or takes advantage of some converter feature to eliminate effort on a system, programming changes must be considered. Any device dependent control blocks or instructions dealing exclusively with cards must be changed to accept the tape medium; for example, the DOS control block DTFCD must be recoded to a DTFMT or DTFDI. The same is true of OS where the device type of the DCB must be changed from card to tape. Any instruction such as stacker select must be handled differently or eliminated.

In DOS, if the input is currently assigned to a programmer unit (for example, SYS001 – SYSnnn), a device dependent control block is generally used and additional programming changes are required. When an application is modified in any way (for instance, if record types are combined to use the 128 character records), program changes are required. The changes range from simple control block and buffer size changes to partial or total rewrite of the application. In OS, if these changes are size changes only, they may be made through the DCB parameters in the JCL statements.

The converter capabilities can save time by eliminating pre-edit runs used to produce labeled tape. Since the converter can provide the labeled tape input, any simple pre-edit functions can be combined with the main edit program and thus eliminate the need for the pre-edit run.

A card deck of source statements to be processed by a compiler is really a file to be updated. If this type of application is installed using a 3740, the source statements should be maintained on normal DASD source statement libraries. When a programmer submits changes to the source statements using a 3740, these changes will be sent to the source statement library, and the file may be updated by a utility program like IEBUPDTE. The updated source statements are then processed by the compiler as a subsequent step in the job. In other applications where the card input represents a type of master file, a similar procedural change is required to permit the system to do the updating.

### Tape Replacement

When the 3740 supplies data that is to be entered into a system via a tape there are normally no changes to the JCL or programs required. The 3747 can build the input tape in the same format as before the 3740 installation.

JCL changes may be required however, if, for example you are switching from seven-track to nine-track tape or from 800 bpi to 1600 bpi. In DOS, this change would be:

```
From: //ASSGN SYS001,X'187,X'78' (seven-track
      tape drive)
To:   //AASGN SYS001,X'181,X'CO" (nine-track
      tape drive)
```

In OS, this change would be:

```
From: //DATA DD . . . , UNIT=2400-1, . . .
      (seven-track tape drive)
To:   //DATA DD . . . , UNIT=2400, . . . (nine-
      track tape drive)
```

For changes needed to input a labeled tape instead of an unlabeled tape, see the example under *Card Replacement* in this section.

### Teleprocessing Programming Support

Teleprocessing programming support will be provided for the 3741 Model 2 and 4, and the 3747 with BSCA by the following access methods and operating systems:

System/370	System/3 Model 6, Model 10 Disk System, or Model 15
DOS/VS BTAM	RPG II (3741 Model 2 and 4 only)
DOS/VS VTAM	
OS/VS1 BTAM	
OS/VS1 TCAM	
OS/VS1 VTAM	
OS/VS2 BTAM	
OS/VS2 TCAM	
OS/VS2 VTAM	

RPG II can be used with both LCA and BSCA. In System/3 RPG II, the terminal designation is BSCA on the file description specification and blank in the remote device field of the telecommunications specifications. In BTAM and TCAM, the terminal designation is BSC1 or BSC2 depending on whether nonswitched or switched facility is being used. In VTAM, the designation is 3740.

The 3741 Model 2 and 4, and the 3747 with BSCA are transparent to the teleprocessing support that exists in System/360-370 DOS BTAM and System/360-370 OS BTAM and TCAM. The 3740 units with BSCA are transparent through the device classes of BSC1 and BSC2 in the above access methods.

Because of this capability, the following support is provided:

### System/360 – 370

```
DOS BTAM
OS BTAM
OS TCAM
```

Communications with System/360 — 370 can be via an:

- IBM 2701 Data Adapter Unit
- IBM 2703 Transmission Control Unit
- IBM 3704 Communications Controller
- IBM 3705 Communications Controller

In addition, communication with System/370 can take place via the Integrated Communications Adapter (ICA).

More detailed information appropriate to the system and language support being used is found in the corresponding SRLs as defined in the Teleprocessing Bibliography at the end of this manual.

## TELECOMMUNICATIONS FACILITIES CONSIDERATIONS

The communications facilities can be common carrier switched telephone networks, common carrier nonswitched line services (channels), or equivalent nonswitched facilities. Communications services must be arranged by the user. (Refer to the *IBM Teleprocessing Systems Summary*, GA24-3090, for further information.)

The communications facilities used by 3740 BSCA must have appropriate modulation/demodulation capability. To provide this capability, an external modem or integrated 1200 bps modem is used to attach to the telephone lines. The BSC adapter is compatible with the IBM 3872 modem and integrated 1200 bps modems. The BSC adapter is compatible with the IBM 3976-3 modem for World Trade only. Bit rates available are 1200, 2000, and 2400 bits per second (bps). A selectable 600 bps transmission rate is available except in Canada, the United States, and Japan. For additional information about communications facilities, see the Teleprocessing Bibliography at the end of the manual.

*Note:* It is the user's responsibility to have the cable to the communication facility connected or disconnected from the CBS coupler (or equivalent) when the 1200 bps Integrated Modem, Switched with Autoanswer Feature (#5501) is implemented.

## UNIT BACKUP CONSIDERATIONS

A station outage affects at most only two stations. Converter outage does not affect the stations as long as additional diskettes are available to continue accumulation and storage of data until the converter is returned to service. Converter outage impact on computer runs can be minimized by scheduling, but converter backup arrangements with other users having compatible configurations should also be considered.

## EDUCATION AND TRAINING

An education program is required after the decision to install a 3740 system is made. Classes offered are outlined in schedules published by IBM. They consist of detailed training for persons who will perform the systems implementation as well as for those who will operate the stations or program in ACL. Arrangements for attending IBM courses may be made with the local IBM sales representatives.

In addition to classroom instruction, 3740 self-study courses and other training materials are available for operator training. These are also useful to systems analysts and key entry supervisors as a structured approach to learning 3740 data entry operations.

The following analysis of educational and training needs is not intended to be all-inclusive but to serve as a guide for specific planning according to specific needs.

*System Analyst:* Attendance at an installation planning course is recommended. The role of the 3740 system analyst entails responsibility for the total systems effort, from the planning stages through the first sets of application conversion and paralleling activities. The installation planning course is intended to convey the characteristics of the IBM diskette recording medium, the functions of each individual machine, and how these machines interact as a system. Other topics cover the essential steps in any 3740 implementation, the key decisions in 3740 systems design, and the sources of information and assistance available to support installation activities.

**ACL Programmers:** A 5-day training program in ACL is available at the IBM Data Center. The program is intended to teach programmers ACL and familiarize them with the application capabilities of the 3741 Programmable Work Station. It is assumed that the programmer has experience in at least one programming language, before attending the training program.

**Key Entry Supervisors and Operators:** The 3740 Data Entry System Feature Instruction Program is available for training key entry supervisors and experienced operators. Customer Engineering personnel have been trained to provide this instruction. The intent of the program is to enable operators of *current key entry products* to begin equivalent production operations immediately on the 3740 stations. Instruction is in basic 3740 functions only, such as data keying, verifying, program formats, CRT usage, etc. Operators requiring training on advanced machine functions or features such as offline field totals, BSCA operation, and 3713 printer or diskette copy functions should complete the Advanced Topics self-study course.

Machine training schedules should be established as early as possible. It is suggested that supervisors and lead operators be trained first. These people need a thorough understanding of machine operations in order to revise key entry procedures as necessary, to set up initial jobs to be converted, to answer operating questions, and to supervise operator training.

Installation conversion plans determine when each operator should begin training. If plans are such that one application at a time is to be converted to 3740 operation, the operators that normally key the related data should be trained first. Once they have developed speed and accuracy with on-the-job practice, the next application can be converted, additional operators trained, and the process repeated until all jobs have been converted and all operators trained. In the event that all jobs are to be converted simultaneously, it is recommended that the more experienced operators be trained first, as training time normally varies with operator skill (that is, the more skilled the operator the less time needed for training).

**Self-Study Materials – 3740 station operator training** is available also through two separate self-study courses: a basic machine course and an advanced topics course.

- **Inexperienced operators** – It is recommended that the basic machine self-study course should be used when 3740 stations are planned for use in other than the central keypunch room and the situation dictates that clerk typists be trained. Course duration will vary with each student but will normally require 20 - 25 hours.
- **Experienced or inexperienced operators who require additional machine training** – It is recommended that operators take the Advanced Topics self-study course. Course topics include 3740 station operations such as teleprocessing, using the printer diskette copy, and field totals. Course duration will vary, since students will complete only the sections they require, to operate within their own 3740 system design.

**Data Converter Operators:** As part of the instruction program mentioned previously under *Key Entry Supervisors and Operators*, instruction will be given to familiarize the data converter operator with basic machine operations, tape handling, and error recovery procedures. If one or more 3740 station operators will be required to operate a 3747, involvement of experienced computer room personnel in developing application-oriented training is recommended. Operation of this device must be closely tied to established tape handling and tape library conventions and job setup instructions as prepared by systems people in a specific installation.

## Physical Site Planning and Preparation

Customers planning an IBM 3740 Data Entry System installation should use this chapter as a guide to determine how they can best prepare their physical site for the arrival and installation of the system. Careful advance planning and scheduling makes it possible for a customer to install his equipment with little or no interruption of the daily office routine.

### SPACE REQUIREMENTS

Since the data entry areas may differ in room size, column spacing, location of electrical outlets, other equipment, and work areas, it may be advisable to prepare a floor plan of the area showing the location of all the equipment to be included.

To help prepare the floor plan, IBM provides a plastic template (GX21-9155) of each of the 3740 system units. The templates are scaled so that 1/4 inch = 1 foot (1 mm = 48 mm) and show the floor space and working clearance for each unit. When room size permits, additional operator space is recommended. In some cases, clearances shown on the template may be overlapped as long as the larger clearance is maintained.

The following items should be considered:

- Work space
- Storage space
- Aisle space
- Service clearance
- Heat dissipation
- Electrical outlets and communication facilities
- Doorway sizes and loading facilities used in getting machines to their locations.

## ENVIRONMENTAL CONSIDERATIONS

### Temperature and Humidity

The temperature and humidity of a data entry area are influenced by many factors. These include heat produced by mechanical and electrical equipment, amount of fresh air entering the area, personnel body heat, and heat introduced or dissipated through walls, ceilings, and floors. As these factors change, varying amounts of heat and humidity may need to be introduced or dissipated to maintain an acceptable operating environment.

Extremes in relative humidity, if maintained for long periods of time, may have an adverse affect on the overall operating efficiency of the installation and should be avoided whenever possible. High relative humidity may cause improper feeding and stacking of paper, as well as operator discomfort. Low relative humidity aggravates problems associated with static electricity. Static charges, which are usually dissipated without any adverse effects, tend to build into significant charges when the humidity is low. High voltage static discharges from moving people, carts, furniture, paper, etc., can be objectionable to operating personnel and, in extreme cases, can interfere with the correct operation of electronic equipment.

### Tape and Diskette Storage

Tapes and diskettes should be stored in dust proof containers in a vertical position. They should never come in contact with magnetic material since field strengths greater than 50 oersteds can cause noise or a loss of information.

Storage facilities should be within the following limits:

	Tape	Diskette
Dry Bulb Temperature	40° to 90°F (4° to 32°C)	50° to 125°F (10° to 51°C)
Wet Bulb Temperature (maximum)	80°F (26°C)	85°F (29°C)
Relative Humidity	20 to 80%	8 to 80%

If stored outside the stated limits, tape and diskettes should be conditioned in the operating environment to ensure proper performance. Conditioning time for diskettes is at least five minutes; for tape, the



conditioning time is the same as the length of time it was stored outside operating limits (maximum of 24 hours).

**Dirt and Air Pollution**

The amount of contamination usually found in the air within a normal business environment will not interfere with the operation of IBM equipment. However, take normal precautions to keep dust, dirt, and other foreign matter away from the machines. If the system must be installed in an area having a high dust content or where there is an exposure to abrasive materials or corrosive gases, contact your IBM representative for advice and recommendations.

**LIGHTING**

Adequate illumination of a data entry area for operator and service personnel is important. The recommended light level is 50-55 foot-candles (538-592 lumens/m<sup>2</sup>) at a height of 30 inches (76 centimeters) above the floor.

Direct sunlight on either the 3741 or 3742 is not recommended since it would impair the readability of the CRT as well as the comfort of an operator facing the light.

**FIRE PROTECTION EQUIPMENT**

The machine room should be equipped with portable, carbon dioxide fire extinguishers of suitable size for quick, efficient use. These, of course, are subject to local building code and fire insurance requirements. A non-wetting extinguishing agent for electrical equipment (Class C hazard) is recommended.

**ELECTRICAL REQUIREMENTS**

All reasonable efforts have been made in the machine design to ensure satisfactory operation with the normal power supplied by most power companies.

Power should not be supplied from the same electrical circuit that supplies power to machines that may create electrical noise. Some machines having start-stop motor action can cause transient electrical noise signals. If there is a question of electrical noise affecting machine operation, consult your IBM representative.

Branch circuits should be protected by circuit breakers suitable for motor load application and should contain wiring that will handle the same load.

**Grounding**

Power cords supplied with each IBM unit have a green (or green with yellow trace) wire grounding conductor for equipment ground. The receptacles recommended provide for connection of this equipment ground. Each customer-supplied branch circuit must have an insulated wire conductor, equal to the size of the phase conductors, for grounding the equipment. All branch circuit grounding wires must be tied to a common ground point at the distribution panel. A single grounding wire should run from the distribution panel to service ground or suitable building ground. This is a noncurrent carrying ground, not a neutral. Conduit must not be used as the only grounding means.

**Convenience Outlets**

A suitable number of convenience outlets should be available in the area for use by building maintenance personnel, etc. The same general rules for electric power apply for the wiring of the convenience outlets.

**Power Supply**

Power is provided through a separate power cord, 8 feet (2.5 meters) long, connected to each machine (unless otherwise noted on the unit specification page). Plug types (or equivalent) shown on the unit specification page are supplied with the machine. Customer provides matching receptacle.

On 50 Hertz machines, power cords are provided without plugs to accommodate installing a local standard plug. See Figure 21 for power cord specifications.

The following electrical specifications apply (unless otherwise noted on the unit specification page):







	50 Hertz	60 Hertz
Voltage (single phase)	110, 123.5 200, 220, 235	115, 208, 230
Voltage Tolerance:	±10%	±10%
Frequency Tolerance:	±1/2 Hertz	±1/2 Hertz

In Japan, the following specifications should be added to those listed above:

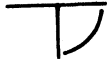
- 100 (50 Hertz)
- 100, 200 (60 Hertz)

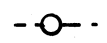
## Unit Specifications

The specification sections of the manual contain individual pages of information about the basic system and the units used with the system. Standard symbols used on the specifications pages and physical planning templates are:

	Power cord exit (power cords are measured from power cord exit)
	Cover swings
	Gate swings
	Service area boundary
	Casters
	Leveling pads or glides
	Cable entry and exit in base of unit
	Non-raised floor cable exit

Plug types (or equivalent) shown in unit specifications are supplied with the machine. The customer provides matching receptacle (or equivalent).

This manual uses the following symbols to denote manufacturers of plugs, receptacles, and connectors:

H = Hubbell (Harvey Hubbell, Inc.)  
 P & S = Pass and Seymour (Pass and Seymour, Inc.)  
 R & S = Russell and Stoll (Midland-Ross Corp.)

The following notes apply to unit specification pages:

1. Power cord styles shown apply to 50 Hertz machines. Figure 21 shows 50 Hertz power cord specifications.

50 Hz Power Cord Style	Cable OD		Shield	Quantity	Conductor	
	(in)	(cm)			Nominal OD	
					(in)	(cm)
A2	0.510	1.0	1	3	0.081	0.2
A5	0.390	1.0	0	3	0.051	0.1

Figure 21. 50 Hertz Power Cord Specifications

2. Plan view dimensions are shown in inches unless otherwise noted. A table at the back of the manual can be used for inch-centimeter conversion.

# 129 CARD DATA RECORDER, MODEL 2

## Plan View

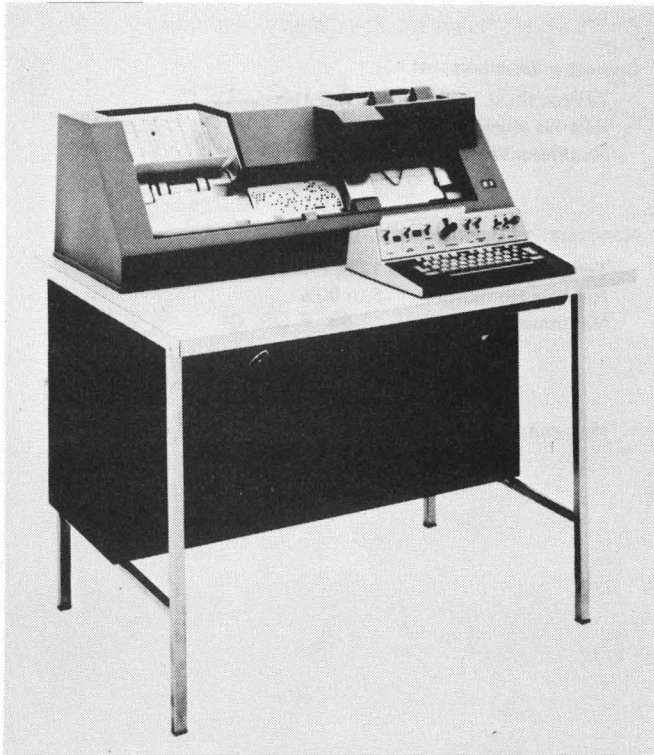
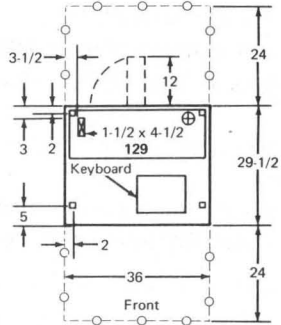

## Specifications

### Dimensions:

	Width	Depth	Height
Inches	36	29-1/2	38
Centimeters	91	75	97

### Service Clearances:

	Front	Rear	Right	Left
Inches	24	24	0	0
Centimeters	61	61	0	0

**Weight:** 255 lb (120 kg)

**Heat Output/hr:** 850 Btu (220 kcal)

### Power Requirements:

kVA	0.4	
Phases	1	
	115V	208/230V
Plug (H and P & S)	5266, 4720*	5666, 4570*
Connector (H and P & S)	5269, 4730*	5669, 4580*
Receptacle (H and P & S)	5262, 4700*	5662, 4550*
Power cord style	A2	A2

### Operating Environment:

Temperature	50° to 110° F (10° to 43° C)
Relative humidity	10% to 80%
Maximum wet bulb	85° F (29° C)

### Nonoperating Environment:

Temperature	50° to 125° F (10° to 51° C)
Relative humidity	8% to 80%
Maximum wet bulb	85° F (29° C)

\* Locking type.

# 3713 PRINTER

## Plan View

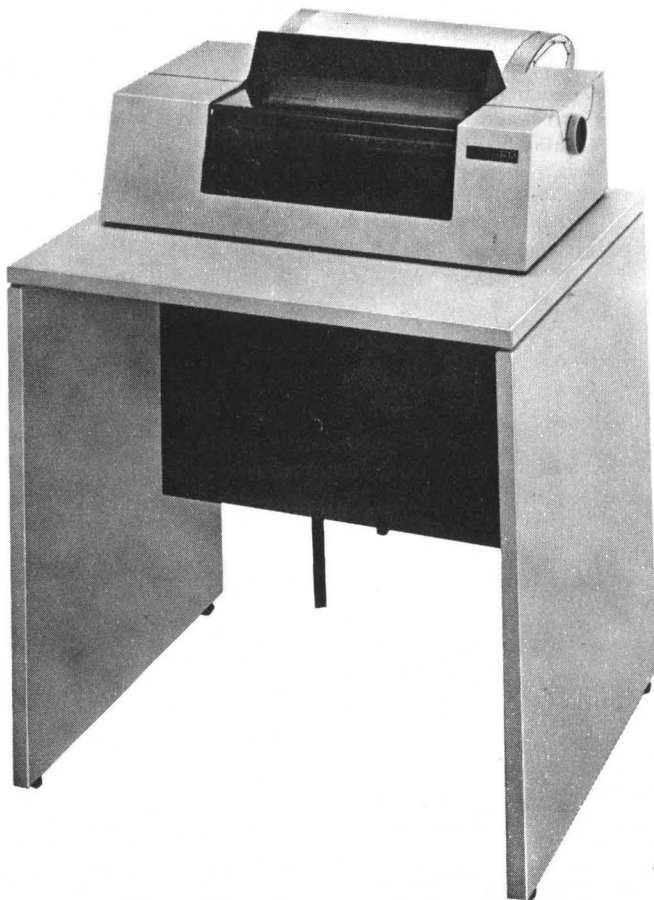
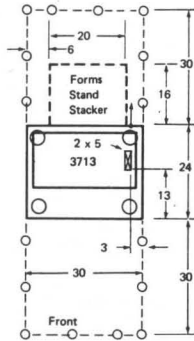

## Specifications

### Dimensions:

	Width	Depth	Height
Inches	30	24	38
Centimeters	76	61	97

### Service Clearances:

	Front	Rear	Right	Left
Inches	30	30	0	0
Centimeters	76	76	0	0

**Weight:** 150 lb (68 kg)

**Heat Output/hr:** 260 Btu (66 kcal)

**Airflow:** Convection cooled

### Power Requirements:\*

kVA 0.2

### Operating Environment:

Temperature 50° to 110° F (10° to 43° C)  
 Relative Humidity 8 to 80%  
 Maximum Wet Bulb 85° F (29° C)

### Nonoperating Environment:

Temperature 50° to 125° F (10° to 51° C)  
 Relative Humidity 8 to 80%  
 Maximum Wet Bulb 85° F (29° C)

\* Powered from 3741

# 3715 PRINTER, MODELS 1 AND 2

## Plan View

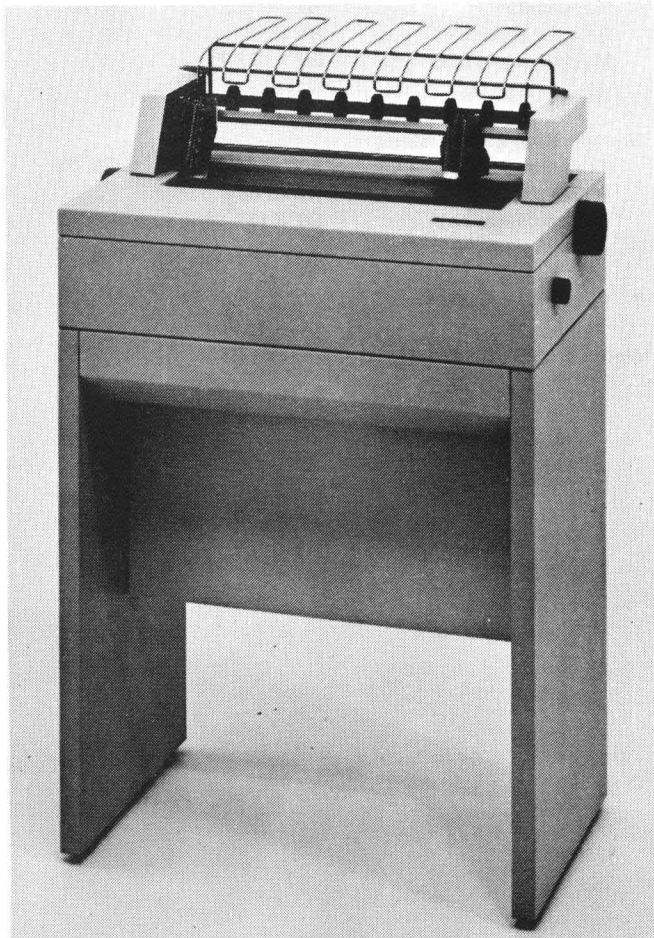
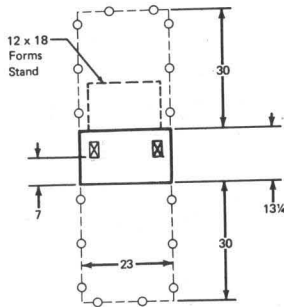

## Specifications

### Dimensions:

	Width	Depth	Height
Inches	23	13-1/4	34-1/2
Centimeters	58	34	88

### Service Clearances:

	Front	Rear	Right*	Left*
Inches	30	30	6	6
Centimeters	76	76	15	15

**Weight:** 110 lb (50 kg)

**Heat Output/hr:** 300 Btu (75 kcal)

**Airflow/min:** 30 ft<sup>3</sup> (1m<sup>3</sup>)

### Power Requirements:\*\*

kVA 0.1

### Operating Environment:

Temperature 50° to 105°F (10° to 41°C)  
 Relative humidity 8% to 80%  
 Maximum wet bulb 80°F (27°C)

### Nonoperating Environment:

Temperature 50° to 125°F (10° to 52°C)  
 Relative humidity 8% to 80%  
 Maximum wet bulb 80°F (27°C)

\* Clearance required above 26" for access to platen knob.

\*\* Powered from 3741.

# 3717 PRINTER

## Plan View

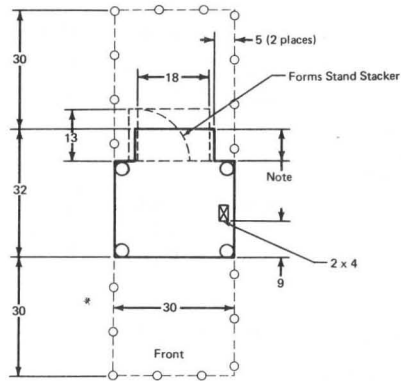

## Specifications

### Dimensions:

	Width	Depth	Height
Inches	30	32	38
Centimeters	76	81	97

### Service Clearances:

	Front	Rear	Right	Left
Inches	30	30	0	0
Centimeters	76	76	0	0

### Weight:

250 lb (113 kg)

### Heat Output/hr:

960 Btu (240 kcal)

### Airflow:

0

### Power Requirements:\*

kVA 0.3

### Operating Environment:

Temperature 50° to 105°F (10° to 41°C)  
 Relative humidity 8% to 80%  
 Maximum wet bulb 80°F (27°C)

### Nonoperating Environment:

Temperature 50° to 125°F (10° to 52°C)  
 Relative humidity 8% to 80%  
 Maximum wet bulb 80°F (27°C)

\* Powered from 3741

Note: Eight inch overhang 24 - 36 inches above the floor.

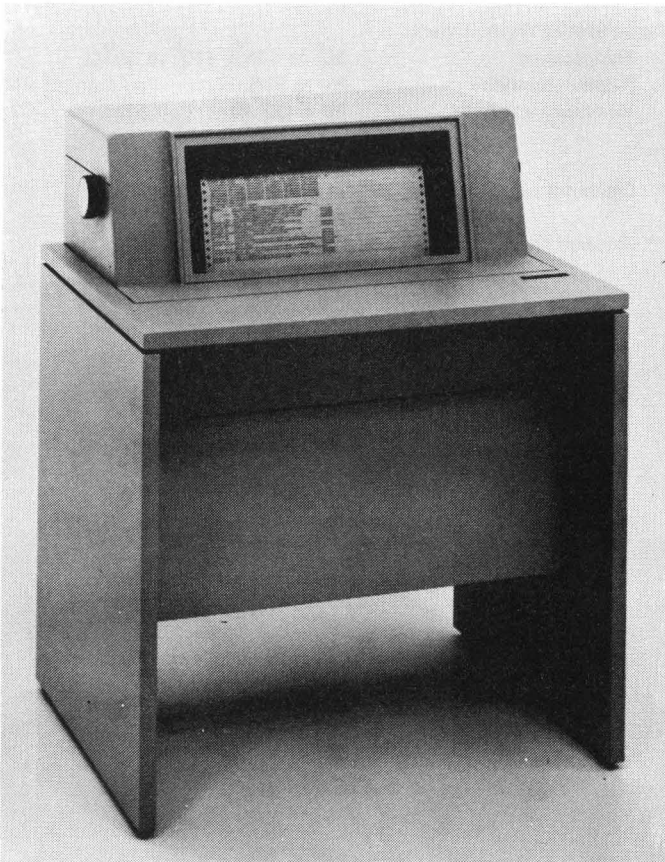

**3741 DATA STATION MODELS 1 AND 2  
3741 PROGRAMMABLE WORK STATION MODELS 3 AND 4**

**Plan View**

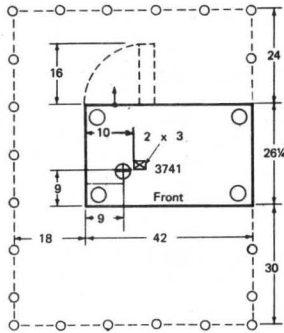

**Specifications**

**Dimensions:**

	Width	Depth	Height
Inches	42	26-1/4	34
Centimeters	107	67	87

**Service Clearances:**

	Front	Rear	Right	Left
Inches	30	24	0	18
Centimeters	76	61	0	46

**Weight (Maximum):** 240 lb (109 kg)

**Heat Output/hr:** 700 Btu (180 kcal)

**Airflow/min:** 150 ft<sup>3</sup> (4m<sup>3</sup>)

**Power Requirements:**

kVA	0.4	
Phases	1	
	<b>115V</b>	<b>208/230V</b>
Plug (H and P & S)	5266, 4720*	5666, 4570*
Connector (H and P & S)	5269, 4730*	5669, 4580*
Receptacle (H and P & S)	5262, 4700*	5662, 4550*
Power cord style	A5	A5

**Operating Environment:**

Temperature	60° to 90° F (16° to 32° C)
Relative humidity	8% to 80%
Maximum wet bulb	73° F (26° C)

**Nonoperating Environment:**

Temperature	50° to 110° F (10° to 43° C)
Relative humidity	8% to 80%
Maximum wet bulb	80° F (27° C)

\* Locking type



# 3742 DUAL DATA STATION

## Plan View

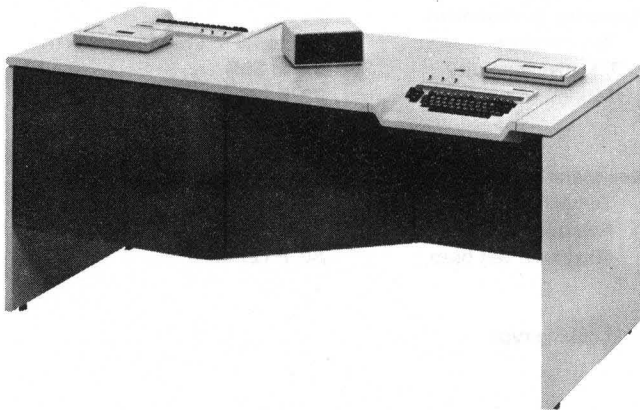
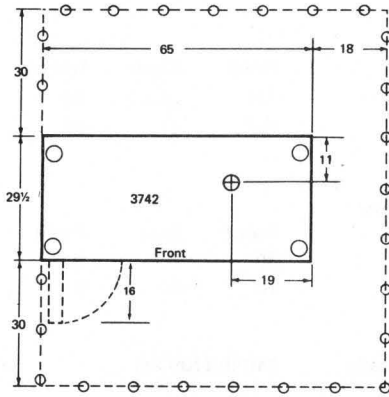

## Specifications

### Dimensions:

	Width	Depth	Height
Inches	65	29-1/2	33
Centimeters	165	75	84

### Service Clearances:

	Front	Rear	Right	Left
Inches	30	30	*	*
Centimeters	76	76	*	*

### Weight:

300 lb (136 kg)

### Heat Output/hr:

730 Btu (185 kcal)

### Airflow/min:

150 ft<sup>3</sup> (4m<sup>3</sup>)

### Power Requirements:

kVA	0.4	
Phases	1	
	<b>115V</b>	<b>208/230V</b>
Plug (H and P & S)	5266, 4720**	5666, 4570**
Connector (H and P & S)	5269, 4730**	5669, 4580**
Receptacle (H and P & S)	5262, 4700**	5662, 4550**
Power cord style	A5	A5

### Operating Environment:

Temperature	60° to 90° F (16° to 32° C)
Relative humidity	8% to 80%
Maximum wet bulb	73° F (23° C)

### Nonoperating Environment:

Temperature	50° to 110° F (10° to 43° C)
Relative humidity	8% to 80%
Maximum wet bulb	80° F (27° C)

\* 18 inches (46 centimeters) service clearance required on one side only.

\*\* Locking type



# 3747 DATA CONVERTER

## Plan View

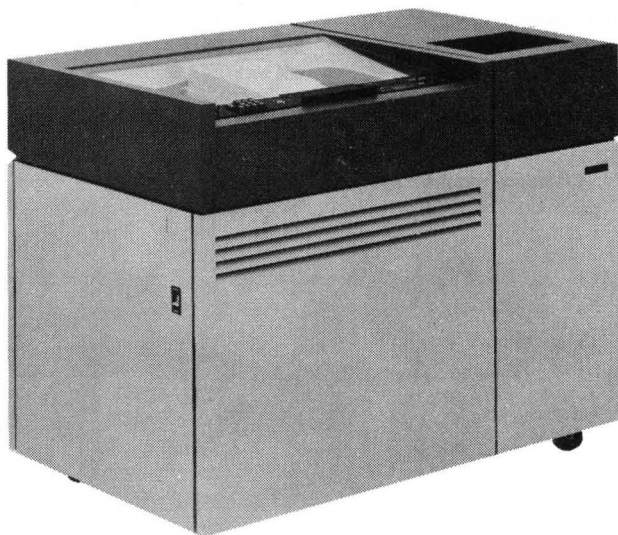
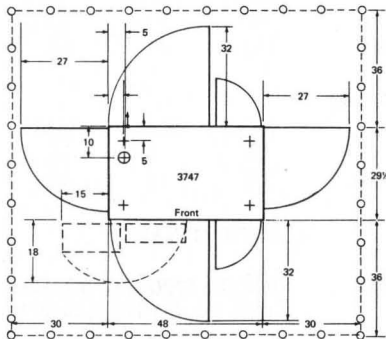

## Specifications

### Dimensions:

	Width	Depth	Height
Inches	48	29½	38
Centimeters	122	75	97

### Service Clearances:

	Front	Rear	Right	Left
Inches	36	36	30	30
Centimeters	91	91	76	76

**Weight:** 540 lb (245 kg)

**Heat Output/hr:** 2050 Btu (515 kcal)

**Airflow/min:** 230 ft<sup>3</sup> (6m<sup>3</sup>)

### Power Requirements:

kVA	0.7	
Phases	1	
Plug (H and P & S)	115V	208/230V
Connector (H and P & S)	5266, 4720*	5666, FS 3720**
Receptacle (H and P & S)	5269, 4730*	5669, FS 3913**
Receptacle (H and P & S)	5262, 4700*	5662, FS 3743**
Power cord style	A5	A5

### Operating Environment:

Temperature	60° to 90° F (16° to 32° C)
Relative Humidity	20 to 80%
Maximum Wet Bulb	78° F (26° C)

### Nonoperating Environment:

Temperature	50° to 110° F (10° to 43° C)
Relative Humidity	8 to 80%
Maximum Wet Bulb	80° F (27° C)

\* Locking type

\*\*R and S locking type.

# 5496 DATA RECORDER MODEL 1

## Plan View

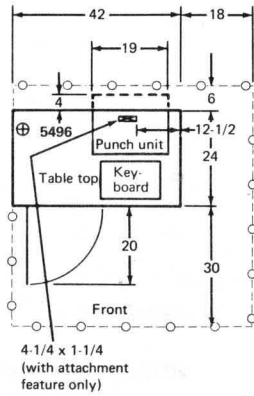

## Specifications

### Dimensions:

	Width	Depth	Height
Inches	42	24	37-1/2
Centimeters	107	61	95

### Service Clearances:

	Front	Rear	Right*	Left
Inches	30	6	18	0
Centimeters	76	15	46	0

### Weight:

250 lb (115 kg)

### Heat Output/hr:

850 Btu (220 kcal) @ 60 Hz  
1225 Btu (310 kcal) @ 50 Hz

### Power Requirements:

Voltage	115 ± 10%
kVA	0.4 @ 60 Hz 0.6 @ 50 Hz
Phases	1
Plug (H and P & S)	5266
Connector (H and P & S)	5269
Receptacle (H and P & S)	5262
Power cord style	A5

### Operating Environment:

Temperature	50° to 110° F (10° to 43° C)
Relative humidity	8% to 80%
Maximum wet bulb	85° F (29° C)

### Nonoperating Environment:

Temperature	50° to 125° F (10° to 51° C)
Relative humidity	8% to 80%
Maximum wet bulb	85° F (29° C)

\* Clearance required above table top only.

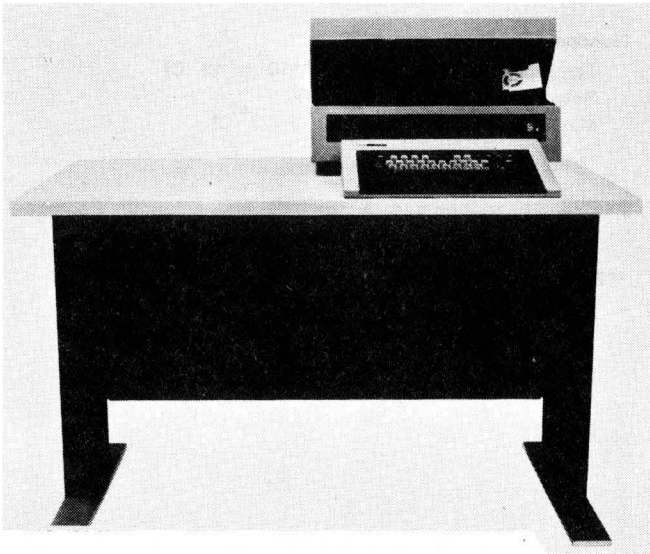

## 3740 System Cabling Information

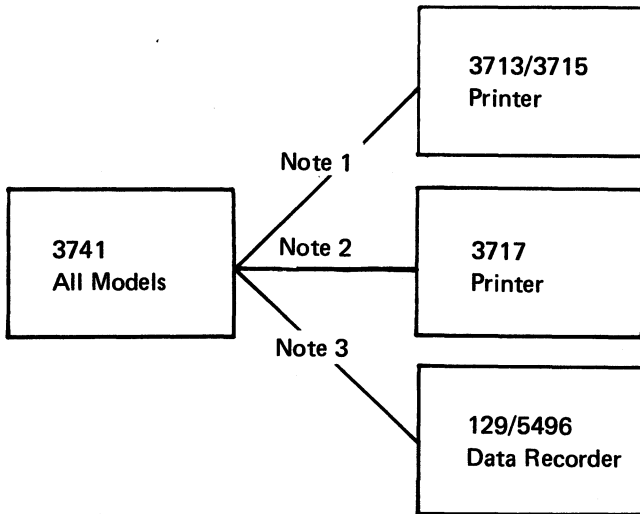

### Notes:

1. 10 foot (3m) cable supplied with the printer.
2. 10 foot (3m) cable supplied with the 3717 expansion feature.
3. 25 foot (8m) cable supplied with data recorder attachment feature.
4. 20 foot (6m) cable supplied as standard with modem adapter. Attaches to communication facility with EIA RS 232 C connector. On a 3741, a 40 foot (12m) cable may be specified with the order. On the 3747, a variable length, to a maximum of 40 feet (12m), may be specified with the order.
5. 20 foot (6m) cable from the 3741 Model 2 or 4 or the 3747 is provided as standard with the 1200 bps line adapter. On the 3747, a variable length, to a maximum of 40 feet (12m), may be specified with the order. Terminations provided are a WE-283 B plug (on FC 5500) and noninsulated spade terminals (on FC 5501), which connect to a CBS automatic data coupler as shown below:

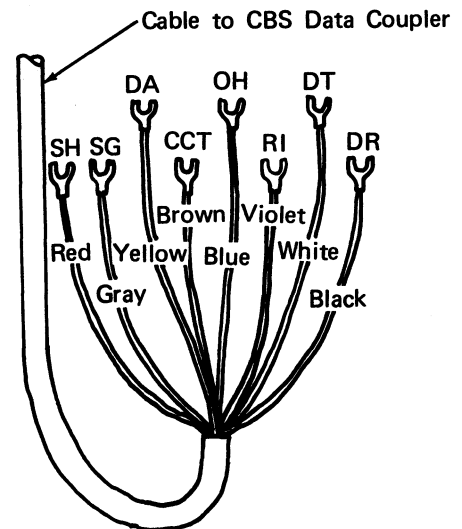
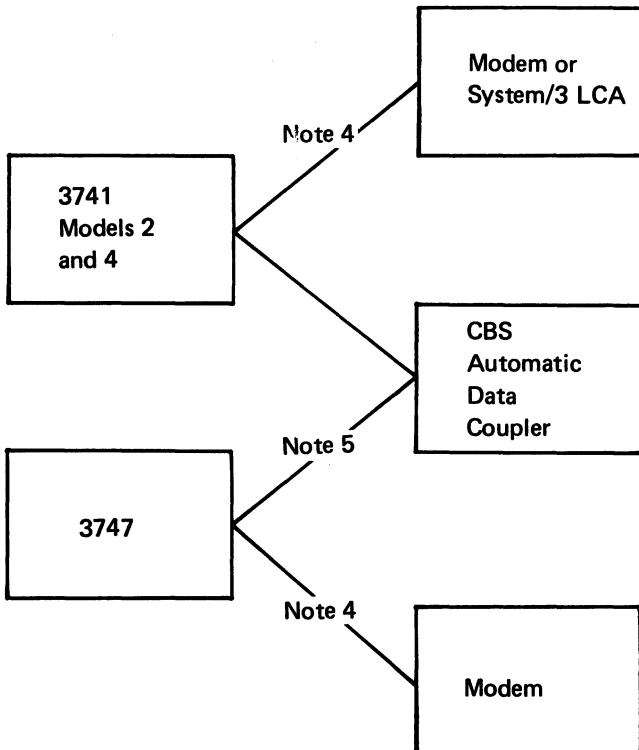

# Inch To Centimeter Conversion Chart

Inch	Centimeters				Inch	Centimeters			
	0	1/4	1/2	3/4		0	1/4	1/2	3/4
0	0	0.6	1.3	1.9	50	127.0	127.6	128.3	128.9
1	2.5	3.2	3.8	4.4	51	129.5	130.2	130.8	131.4
2	5.1	5.7	6.4	7.0	52	132.1	132.7	133.3	134.0
3	7.6	8.3	8.9	9.5	53	134.6	135.3	135.9	136.5
4	10.2	10.8	11.4	12.1	54	137.2	137.8	138.4	139.1
5	12.8	13.3	14.0	14.6	55	139.7	140.3	141.0	141.6
6	15.2	15.9	16.5	17.1	56	142.2	142.9	143.5	144.1
7	17.8	18.4	19.1	19.6	57	144.8	145.4	146.0	146.7
8	20.3	21.0	21.6	22.2	58	147.3	148.0	148.6	149.2
9	22.9	23.5	24.1	24.8	59	149.9	150.5	151.1	151.8
10	25.4	26.0	26.7	27.3	60	152.4	153.0	153.7	154.3
11	27.9	28.6	29.2	29.8	61	154.9	155.6	156.2	156.8
12	30.5	31.1	31.7	32.4	62	157.5	158.1	158.8	159.4
13	33.0	33.7	34.3	34.9	63	160.0	160.7	161.3	161.9
14	35.6	36.2	36.8	37.5	64	162.6	163.2	163.8	164.5
15	38.1	38.7	39.4	40.0	65	165.1	165.7	166.4	167.0
16	40.6	41.3	41.9	42.5	66	167.6	168.3	168.9	169.5
17	43.2	43.8	44.4	45.1	67	170.2	170.8	171.4	172.1
18	45.7	46.4	47.0	47.6	68	172.7	173.4	174.0	174.6
19	48.3	48.9	49.5	50.2	69	175.3	175.9	176.5	177.2
20	50.8	51.4	52.1	52.7	70	177.8	178.4	179.1	179.7
21	53.3	54.0	54.6	55.2	71	180.3	181.0	181.6	182.2
22	55.9	56.5	57.1	57.8	72	182.9	183.5	184.1	184.8
23	58.4	59.1	59.7	60.3	73	185.4	186.1	186.7	187.3
24	61.0	61.6	62.2	62.9	74	188.0	188.6	189.2	189.9
25	63.5	64.1	64.8	65.4	75	190.5	191.1	191.8	192.4
26	66.0	66.7	67.3	67.9	76	193.0	193.7	194.3	194.9
27	68.6	69.2	69.9	70.5	77	195.6	196.2	196.8	197.5
28	71.1	71.8	72.4	73.0	78	198.1	198.8	199.4	200.0
29	73.7	74.3	74.9	75.6	79	200.7	201.3	201.9	202.6
30	76.2	76.8	77.5	78.1	80	203.2	203.8	204.5	205.1
31	78.7	79.4	80.0	80.6	81	205.7	206.4	207.0	207.6
32	81.3	81.9	82.6	83.2	82	208.3	208.9	209.6	210.2
33	83.8	84.5	85.1	85.7	83	210.8	211.5	212.1	212.7
34	86.4	87.0	87.6	88.3	84	213.4	214.0	214.6	214.3
35	88.9	89.5	90.2	90.8	85	215.9	216.5	217.2	217.8
36	91.4	92.1	92.7	93.3	86	218.4	219.1	219.7	220.3
37	94.0	94.6	95.2	95.9	87	221.0	221.6	222.2	222.9
38	96.5	97.1	97.8	98.4	88	223.5	224.2	224.8	225.4
39	99.1	99.7	100.3	101.0	89	226.1	226.7	227.3	228.0
40	101.6	102.2	102.9	103.5	90	228.6	229.2	229.9	230.5
41	104.1	104.8	105.4	106.0	91	231.1	231.8	232.4	233.0
42	106.7	107.3	108.0	108.6	92	233.7	234.3	235.0	235.6
43	109.2	109.9	110.5	111.1	93	236.2	236.9	237.5	238.1
44	111.8	112.4	113.0	113.7	94	238.8	239.4	240.0	240.7
45	114.3	114.9	115.6	116.2	95	241.3	241.9	242.6	243.2
46	116.8	117.5	118.1	118.7	96	243.8	244.5	245.1	245.7
47	119.4	120.0	120.6	121.3	97	246.4	247.0	247.7	248.3
48	121.9	122.6	123.2	123.8	98	248.9	249.6	250.2	250.8
49	124.5	125.1	125.7	126.4	99	251.5	252.1	252.7	253.4
					100	254.0			

**address:** Location on the diskette consisting of a track and sector number; types include: record, program, end of data.

**access method:** Method of moving data between main storage and input/output devices.

**ACL (application control language):** Programming.

**alphanumerics:** Machine processible characters, including both letters and digits.

**application:** A specific type of job.

**autoanswer mode:** Machine feature that allows a transmission control unit or a station to automatically respond to a call that it receives over a switched line.

**backup:** Substitute to be used in case of emergency.

**batching:** See *data batching*.

**begin field code:** The first letter in a program field; defines type of field.

**bit:** The smallest unit of information in a binary system. Eight bits make a byte (see *byte*).

**BSCA (binary synchronous communications adapter):** Provides the ability to transmit data from one location to another.

**buffer:** Machine data storage area.

**byte:** A series of eight adjacent bits that are used to store alphanumeric information.

**channel-attached:** Defines relationship to CPU.

**centralized/decentralized:** See *source, remote*.

**communications:** Telecommunications.

**configuration:** Specific number and types of units related in a specific way to each other and to the CPU.

**control disk:** Disk containing job specifications for converter operation.

**CPU:** Central processing unit; computer.

**CRT:** Cathode ray tube; operator display screen on key entry stations.

**cursor:** Character position underscore (-) on display screen.

**data batching:** Splitting source data for a job into segments to expedite the job.

**data conversion:** Process whereby 3747 writes data from a disk onto tape or vice versa.

**data recovery:** Reconstruction of recorded data that cannot be read.

**data set:** A complete and related group of records (payroll, accounts receivable, etc.).

**data set label:** Data on index track of diskette that identifies a data set recorded on that disk by name and location, and shows whether or not the data set has been verified.

**direct input:** Method of providing data to a CPU.

**disk drive:** The device that moves the disk past a read/write mechanism.

**duplex/half-duplex:** Duplex = data transmission in both directions at once.

**error recovery:** Automatic or operator-initiated action to correct an error condition.

**field, data:** Specific category of information in a record (name, social security number, etc.).

**field, program:** Code specifying format for a given data field.

**half-duplex:** Data transmission in both directions but not at the same time.

**hard copy:** Printed copy of machine output in visually readable form.

**header record:** Record containing identifying information for a group of records that follows.

**ICA:** Integrated communications adapter; provides for direct connection of a device with the CPU.

**index track:** The first track on the diskette (track 00); used for data set labels.

**initialization:** Process resulting in the diskette's original physical format.

**LCA:** Local communications adapter; permits direct attachment of the 3741 Model 2 to System/3 when it is installed.

**library, diskette:** Procedural system for controlling diskette use; typically involves the implementation of a filing system and control cards or forms.

**machine status:** The state the machine is in if it is 1) ready to be operated, 2) not ready, or 3) in a wait state.

**manual fields:** Any field involving operator action character-by-character.

**mask statement:** Information keyed when doing a search that the 3740 system uses to compare to information stored on the diskette.

**mode:** Type of machine operation in which certain functions can be selected and certain simple operations performed (Enter mode, Update mode, etc.).

**modem:** A device that changes machine readable data into a form suitable for transmission over communications facilities.

**nonswitched:** A connection between a remote terminal and a computer that does not have to be established by dialing.

**nontransparent text mode:** See *transparent text mode*.

**offline:** Type of operation in which data recording and machine handling of recorded data are separated by some form of operator intervention.

**online:** Type of operation in which recorded data is operated on by the machine without intervening operator action.

**operating system:** Software controlling the execution of computer programs (OS, OS/VS, DOS, etc.).

**outage:** Not in service.

**print format:** Print line and column specifications.

**program disk:** Disk containing key entry programs.

**program, key entry:** A set of information stored in the machine to relieve the operator of certain actions. Programs can be used, for example, to place the machine in alpha or numeric shift, to automatically skip or duplicate fields, etc.

**program level:** Program storage area in the machine.

**program shift code:** Symbol representing a data field containing either alphabetic (dots) or numeric (dashes) characters.

**record:** One or more data fields that form a unit of information meaningful to your operation; for example, payroll, accounts receivable, accounts payable records. A record can be no more than 128 characters.

**reinitialization:** The process of altering the diskette's current track and sector format.

**remote location:** Offsite.

**retention cycle:** Length of time a job recorded on the diskette is retained before the diskette can be used to record other information.

**right-adjust field:** Field in which characters are recorded at the right end of the field so that the position of the last rather than first character is fixed, regardless of the number of characters in the field; positions not occupied by characters may contain blanks or zeros. Examples of such fields are amount fields, count fields, etc.

**scratch diskette:** A diskette that can be used to record data; a diskette that is no longer in a retention cycle.

**scratch file:** Collection of scratch diskettes.

**sector:** A section in a track on the disk for a record.

**source document:** Material containing the data being keyed.

**source location:** Area generating a source document.

**suspense file:** Collection of diskettes that have been converted to tape and are being held for release by the CPU operator.

**switched:** A communication line in which the connection between the computer and a remote station is established by dialing.

**synchronous:** Occurring with a regular or predictable time relationship.

**tape labels:** Records at the beginning or end of a tape that identify the information on that tape.

**telecommunications:** Data transmission between a computing system and remotely located devices via a unit that performs the necessary format conversion and controls the rate of transmission.

**teleprocessing:** Processing of data that is received from or sent to remote locations by way of telecommunication lines.

**terminal:** A device capable of sending and receiving information over a communication channel.

**throughput:** Rate of production.

**track:** The portion of a moving storage medium, such as a tape or diskette, that is accessible to a given reading head position.

**trailer record:** A record that follows one or more records and contains data related to those records.

**transparent text mode:** Type of operation permitting unrestricted coding of data.

**unit specifications:** Information pertaining to physical machine characteristics such as size, power requirements, etc.

## Teleprocessing Bibliography

### General Information

*IBM Teleprocessing SRL Bibliography*, GA24-3089  
*IBM Teleprocessing System Summary*, GA24-3090

### BSC Information

*General Information Binary Synchronous Communications*,  
GA27-3004  
*IBM 3740 Data Entry System Programmer's Guide*, GC21-  
5071

### Programming Information

*System/370 System Summary*, GA22-7001  
*System/360 Programming Systems Summary (BPS, BOS,  
TOS, DOS)*, GC24-3420  
*OS/VS1 Planning and Users Guide*, GC24-5090  
*OS/VS1 Release Guide*, GC24-5092  
*OS/VS2 Planning Guide*, GC28-0600  
*OS/VS2 Release Guide*, GC28-0601  
*DOS/360 BTAM Reference Manual*, GC30-5001  
*IBM Systems – DOS/VS Version 4 Basic Telecommunica-  
tions Access Method (BTAM)*, GC27-6978  
*OS BTAM Reference Manual*, GC30-2004  
*IBM Systems – OS/VS BTAM*, GC27-6980  
*IBM Systems – OS/MFT and OS/MVT TCAM Program-  
mer's Guide*, GC30-2024  
*IBM Systems – OS/VS TCAM Programmer's Guide*, GC30-  
2034  
*Introduction to VTAM*, GC27-6987



- access methods 37
- accumulators 13
- ACL (see application control language)
- ACL translator 21
- adding records 11
- adjustable margin feature 14
- air pollution 41
- application control language (ACL) 21
- application program changes 36, 37
- autoanswer 16, 19
- automatic error recovery 19
- auto record advance switch 9
  
- backup 38
- balancing (see field totals)
- batch control 26
- batch control total 13
- bibliography, teleprocessing 56
- binary synchronous communications/binary synchronous communications adapter (BSCA) 16, 37
- blocking, reformatting 19
- bypass fields 10, 27
  
- cabling information 51
- card read/punch
  - data recorders 13
  - modes 13
- card replacement 36
- capacity, disk 1, 2
- care, diskette 32
- centralized data entry 4-6, 26
- codes
  - program 27
  - transmission 16
- colored labels (see labels)
- communications facilities/networks 38
- communications, multipoint 16
- configurations 7, 8
- contaminated diskettes 32
- content, search 12
- control (see batch control)
- control center 22
- control record 19
- convenience outlets 41
- conversion data 19
- converter outage 38
- copy 12
- counters
  - record 12
  - keystroke 12
  - verify correction keystroke 12
  
- CPU 4-6
- CRT display 9
- current record buffer, formatted 14
- cursor 9
  
- damaged diskettes 32
- data conversion/data converter (see conversion data)
- data converter operators, education 38
- data entry programs (see programs, key entry)
- data recorder attachment 13
- data recorders 13, 43, 50
- data recovery 24
- data set labels 24
- data stations 9, 10
- decentralization/decentralized department 4-6, 26
- dirt 41
- disk errors/irregularities 24, 32
- disk/diskette
  - capacity 1, 2
  - copy 12
  - damaged or contaminated 32
  - data set labels 24
  - initialization 12, 24
  - internal and external labels 24
  - replacement 24
  - requirements 25, 26
  - storage 32, 40
- diskette description 2
- diskette normal surface wear 32
- diskette serial number 30, 31
- display screen 9
- documentation 32
- dual data station 2
- duplication fields 10-11, 27
  
- education
  - data converter operators 38
  - key entry operators 38
  - supervisor 38
  - system analyst 38
- electrical power 41
- electrical requirements 41-50
- end of data 12, 24
- entering data 9
- environment/environmental considerations 40, 41
- equipment
  - environment 41
  - outage 38
  - specifications 42-50
- expanded communications 16
- expanded communications/multipoint data
  - link control 16
- expanded functions 19
- external labels, disk (see labels)

features 17, 18  
field correct mode 11  
field totals 13  
fire protection equipment 41  
format control  
  print 14  
  program 27  
forms thickness 14  
functions 17, 18

grounding 41

header records 19, 29  
horizontal print control 14

IBM diskette 1, 2  
IBM 3540 diskette input/output unit 3, 20  
IBM 3713 printer 4, 14, 44  
IBM 3715 printer 4, 14, 45  
IBM 3717 printer 5, 15, 46  
IBM 3741 data station 2, 17  
IBM 3741 programmable work station 2, 21  
IBM 3742 dual data station 2, 17  
IBM 3747 data converter 2, 19  
ICA 4-6  
index track 24  
initialization, disk 12, 24  
inserting records 11  
installation guide (see preparing for the installation)  
installation procedural forms 26-31  
internal labels, disk (see labels, disk data set)

JCL cards 36, 37  
JCL changes 36, 37  
job control/job scheduling 22, 28  
job run sheet 34  
job specifications (see documentation)

key entry operators, education 38  
key entry programs (see programs, key entry)  
keyboard, proof 13  
keylock 16  
keystroke counter 12

labeled tape 24  
labels  
  colored 30  
  disk data set 24  
  external 30  
LCA 6  
library, disk 30  
lighting 41  
line code 41

magnetic tape 36  
media 1, 2  
merging records 12  
model 17  
modems 38  
modes of operation 11  
multi data sets per disk 24  
multipoint communications 16

networks 38

offline field totals (see field totals)  
online field totals (see field totals)  
operating procedures (see system design considerations  
  & installation planning in table of contents)  
operating systems 37  
operator guidance 9  
operator identification card reader 16  
operator interface 9  
operators  
  data converter 19, 38  
  key entry 9  
operator training course 38  
outlets 41

physical planning 40  
plan views  
  129 43  
  3713 44  
  3715 45  
  3717 46  
  3741 47  
  3742 48  
  3747 49  
  5496 50

power supply 41  
preinstallation planning (see physical planning)  
preinstallation planning checklist 25  
preparing for the installation 25  
print continuation 14  
printer attachment 3, 14  
printer forms 15  
print format 14, 15  
print modes 14, 15

production statistics 12  
program address 29  
program chaining 10  
program codes 27  
program control 10, 27-29  
program disks 29  
programs, key entry 8, 10, 27-29  
program layout 27-29  
programmable work station 2, 21  
programming changes 36, 37  
programming support 36, 37  
programming, system 36, 37  
prompting messages 9  
proof keyboard 13

record address 11  
record backspace 10, 11  
record counter 12  
record insert 11  
record length 12  
records, header (see header records)  
record, unreadable/unwritable (see data recovery)  
record volume 1, 2  
record, 128 character 12  
reformatting (see format control)  
reinitialization (see initialization)  
replacement, diskette 24-26  
requirements, diskette 25, 26  
reset 12  
restrictions, expanded communications 16  
right-adjust fields 10, 27  
run sheets 35

scheduling 22, 24, 25  
scratch diskettes 22-23, 30  
search mask 12  
search on content 12  
search on end of data 12  
search on record address 11  
search sequential content 12  
second disk 12  
sector 12  
sector sequencing (see initialization)  
self-check 13  
sequential content, search 12  
single data sets per disk 24  
skip fields 10, 27  
source department 4-6, 26  
space requirements 40, 43-50  
spare tracks 24  
specifications  
unit 42  
129 43  
3713 44  
3715 45  
3717 46  
3741 47  
3742 48  
3747 49  
5496 50

standard functions 17  
station outage 38  
status line 9, 10  
storage  
disk 32, 40  
tape 40  
storage, 4K additional 21  
supervisor, education 38  
supplies 25-35  
suspense file 23, 31  
synchronous clock 16  
SYSIN file 36, 37  
system analyst, education 38  
system concept 1-8  
system programming 36, 37

tape  
labeled 19, 24, 32-37  
replacement 37  
storage 40  
tape to disk 19  
telecommunications/teleprocessing 4, 6, 13, 37-38  
teleprocessing bibliography 56  
temperature 40  
terminal designation 37  
terminal identification 16  
terminology 32  
track 2, 11, 12, 24, 29  
trailer labels/records 24  
training 38  
translator, ACL 21  
transmission 4, 6, 13, 37-38  
transmission code 16  
transmitting selected fields 16  
transmitting selected record 16

unreadable, unwritable record (see data recovery)  
unit specifications 42  
updating data 11

verify correction keystroke counter 11  
verify option 19  
verify/verification 11  
vertical forms control 14

wear, normal surface 32  
work flow 22, 23

# READER'S COMMENT FORM

**IBM 3740 Data Entry System  
System Summary and  
Installation Manual – Physical Planning**

**GA21-9152-2  
File No. 3740-00,15**

## **YOUR COMMENTS, PLEASE . . .**

Your comments assist us in improving the usefulness of our publications; they are an important part of the input used in preparing updates to the publications. All comments and suggestions become the property of IBM.

Please do not use this form for technical questions about the system or for requests for additional publications; this only delays the response. Instead, direct your inquiries or requests to your IBM representative or to the IBM branch office serving your locality.

Corrections or clarifications needed:

<i>Page</i>	<i>Comment</i>
-------------	----------------

Please include your name and address in the space below if you wish a reply.

Cut Along Line

Fold

Fold

FIRST CLASS  
PERMIT NO. 387  
ROCHESTER, MINN.

**BUSINESS REPLY MAIL**  
NO POSTAGE STAMP NECESSARY IF MAILED IN THE UNITED STATES

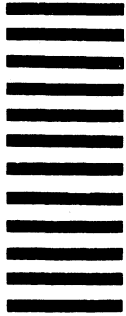

POSTAGE WILL BE PAID BY . . .

IBM Corporation  
General Systems Division  
Development Laboratory  
Publications, Dept. 245  
Rochester, Minnesota 55901

Attention: Publications, Dept. 245

Fold

Fold

IBM 3740 System Printed in U.S.A. (File No. 3740-00,15) GA21-9152-2



**International Business Machines Corporation**  
General Systems Division  
875 Johnson Ferry Road N. E.  
Atlanta, Ga. 30342  
(USA Only)

**IBM World Trade Corporation**  
821 United Nations Plaza, New York, New York 10017  
(International)



**International Business Machines Corporation  
General Systems Division  
875 Johnson Ferry Road N. E.  
Atlanta, Ga. 30342  
(USA Only)**

**IBM World Trade Corporation  
821 United Nations Plaza, New York, New York 10017  
(International)**