

The IBM logo, consisting of the letters "IBM" in a bold, sans-serif font, is positioned inside a dark, textured square.

Systems Reference Library

IBM 1130 Operating Procedures

This is a guide to the operation of the 1130 Computing System. It covers in detail the usual duties of an operator of an 1130 system when operating 1130 input/output devices and when performing certain functions with the 1131 console control panel. No specific programming system is assumed.

This publication describes the control keys, indicator lights, special features, setup procedures, restart procedures, and principles of operation of all input/output devices available for attachment to the 1130 system. Pictorial illustrations are included throughout the text to clarify procedures, and a glossary is presented in the appendix to clarify terminology.

PREFACE

This manual is designed for operators who have had not more than the minimum training on stored-program computers. It covers in detail the usual duties of an operator of an 1130 Computing System.

The practices and techniques given are approved methods based on the preferences of IBM and on the way successful operators do their work in large and small organizations throughout the world. The user of the manual must remember, however, that the employer has the prerogative of determining how a certain task shall be done and what responsibilities his operator shall assume.

The general content and overall plan of the manual are adapted to the needs of the user in an attempt to improve operator efficiency. Pictorial illustrations are included for their value in clarifying procedures. A glossary is presented in the back of the manual to clarify terminology.

First Edition

This manual makes obsolete A26-5890-3. This manual has been rewritten and retitled to reflect changes in the 1130 program.

Significant changes or additions to the specifications contained in this publication are continually being made. When using this publication in connection with the operation of IBM equipment, check the latest SRL Newsletter for revisions or contact the local IBM branch office.

The illustrations in this manual have a code number in the lower corner. This is a publishing control number and is not related to the subject matter.

Copies of this and other IBM publications can be obtained through IBM Branch Offices.

A form is provided at the back of this publication for your comments.

This manual was prepared by the IBM Systems Development Division, Product Publications, Department 455, San Jose, California 95114.

© International Business Machines Corporation, 1968

CONTENTS

THE ROLE OF THE OPERATOR	1	IBM 1231 OPTICAL MARK PAGE READER, MODEL 1	41
The Program and Run Book	1	Operator Controls	41
Summary	2	Readying the 1231	42
INTRODUCTION TO THE IBM 1130 COMPUTING SYSTEM	3	IBM 1403 PRINTER, MODELS 6 AND 7	44
IBM 1131 CENTRAL PROCESSING UNIT	12	Operator Controls	44
Operator Controls: Console Entry Switches	12	Manual Controls	45
Operator Controls: Console Display Panel	13	Inserting a Carriage Control Tape	47
Operator Controls: Console Function Switches and Lights	15	Changing the Ribbon	49
Operator Controls: Console Mode Switch	17	Inserting Forms	50
Operator Controls: Single Disk Storage Panel	18	Changing the Interchangeable Cartridge	53
Operator Controls: Console Keyboard	19	IBM 1442 CARD PUNCH, MODEL 5 AND 1442 CARD READ PUNCH, MODELS 6 AND 7	54
Readying the IBM 1130 Computing System	19	Operator Controls	54
Readying the Console Printer	20	Removing Jammed Cards	55
Readying the Disk Storage Drive	21	Readying the 1442	57
Removing a Typing Element	22	Restarting the 1442	57
Replacing a Typing Element	22	IBM 1627 PLOTTER, MODELS 1 AND 2	60
Removing a Fabric Ribbon Cartridge	23	Operator Controls	60
Installing a Fabric Ribbon Cartridge	23	Installing a Roll of Graph Paper	61
IBM 1055 PAPER TAPE PUNCH, MODEL 1	24	Installing a Sheet of Graph Paper	62
Operator Controls	24	Assembling the Pen	64
Inserting Paper Tape	24	Checking the Plotter Operation	65
Emptying the Chad Box	27	IBM 2250 DISPLAY UNIT, MODEL 4	67
Checking Not-Ready Conditions	27	Operator Controls	67
Splicing Tape	27	IBM 2310 DISK STORAGE, MODELS B1 AND B2	70
IBM 1132 PRINTER	28	Operator Controls	70
Operator Controls	28	Changing the Disk Storage Cartridge	70
Manual Controls	29	IBM 2501 CARD READER	72
Inserting a Carriage Control Tape	31	Operator Controls	72
Installing Forms Tractor	33	Removing Jammed Cards	73
Inserting Forms	34	Readying the 2501	74
Replacing a Ribbon	36	APPENDIX A. CARRIAGE CONTROL TAPE	75
IBM 1133 MULTIPLEX CONTROL ENCLOSURE	37	APPENDIX B. USING THE MACHINE COVERS FOR SAFETY	78
Operator Controls	37	APPENDIX C. RELATED LITERATURE	79
IBM 1134 PAPER TAPE READER	38	APPENDIX D. 1130 CONSOLE CHECK SHEET	80
Inserting Tape	38	APPENDIX E. GLOSSARY	81
Rewinding Tape	39		
Checking a Not-Ready Condition	40		

The operator has very specific duties while he operates the system. His area of speciality is in part the ability to set up the machine and its associated input/output units in a minimum amount of time. In most installations, the tasks of the operator are divorced from those of the programmer, systems analyst, and card punch operator. (In some installations, however, one person performs more than one of these tasks.) The subjects treated in this manual will help the operator learn to operate the equipment used in an 1130 system installation.

In most cases, the operator works directly with the machine. He must understand that he cannot allow the machine to remain idle while he attempts to supply data which should have been provided by the programmer. In such cases, the operator should terminate processing of the job before completion and return it to the programmer for correction.

The operator's job centers on processing data that has already been organized and prepared for processing. The systems analyst has analyzed the information supplied by the user, decided upon the most efficient means of instructing the computer to process the information, and divided the problem into segments. Each segment problem is solved by the programmer, who lists the specific steps required to instruct the computer to solve that segment. The programmer writes the instructions for the computer in a special programming language. This list of instructions is called a program.

The Program and Run Book

The program is then punched into IBM cards (called a source program deck) by card punch operators. The computer cannot execute a source program because a source program is in a programming language and not in machine language. The source deck is then translated during a computer run by a program called an assembler or a compiler, which produces an object program deck that is in machine language. For simplicity, we will refer to the executable program as the "program." An executable program may be in cards as a program deck, or it may be on a disk.

The programmer also supplies a series of instructions and notes (called a run book), which gives the operator specific information regarding the particular program. The program deck and the run book are delivered to the operator, who

depends on the run book to tell him what he must know to proceed with the processing operation. For example, the programmer includes error messages in his program to describe errors that would occur because of incorrect input data or an incorrect operational procedure. The operator refers to the run book to determine what corrective action to take when an error occurs. The run book also tells him which program deck or disk to use, which forms to use in the printer, and how to continue with the processing when departures from conventional procedures are necessary.

To this extent the operator works with the programmer. The run book, which has been prepared by the programmer for each specific program, is used by the operator as one of his tools while running the program through the computer. The operator uses the program and the machine to complete the processing of data. He does not explore all of the factors that determine the structure of the program.

Just as the programmer decides how this particular program will be run, the operations manager decides what jobs will be run, and in what sequence, during any given period. The operations manager is in charge of the overall functioning of the data center and is responsible for the efficient use of the available equipment. Among other duties, he assigns priorities to the various jobs and prepares a daily schedule.

The schedule outlines the operator's (and the system's) work for the day. It always contains a list of the jobs to be done and may contain special information; for example, that a piece of equipment has been scheduled for preventive maintenance and may not be used, or that a local procedure has been modified.

Most of the column headings in the schedule are self-explanatory. The job number and job name or description entries identify the jobs to be run and include a brief description of each job. More complete descriptions will be found in the run book associated with each job. The first column of the schedule indicates the sequence in which each job is to be run. Should it be necessary to change the job sequence, the change can be made by transposing numbers in the sequence column rather than by re-writing the entire form. The last column should be initialed by the operator after completion of the indicated job.

Of the tools at the command of the operator, the program is the final one that makes the various pieces of machinery -- central processing unit, disk units, card read punch, printer, etc. -- function together as a system. The 1130 system is fully capable of using all of these units together in accordance with the requirements of the program and the operator's use of the console control panel and console typewriter.

Summary

During the processing of data, the operator is responsible for all on-line and off-line system components. On-line devices attach to the system and operate according to instructions in the program. At times, it is desirable to make one or more of these components temporarily unavailable to the system (when preventive maintenance is required, for example). While the component is unavailable to the system, it is considered to be off-line. Equipment that is never attached to a particular computer system is also termed off-line. Punched card machines, sorters, collators, and reproducers are typical examples of off-line equipment.

To operate a computing system, the operator must be knowledgeable in three areas:

1. The mechanical details of each unit. For example, he must learn how to load a disk pack into a disk unit and how to load blank forms into the printer. These tasks are basic and easily learned. After the operator has performed such tasks once or twice and has learned that they vary only slightly, he can perform them without difficulty.
2. The particular program being run on the computer. Information concerning the nature of each program and what is required of the operator is supplied to the operator in the run book. The run book describes the specific information that the operator requires to run that particular program.
3. IBM-supplied programs. All programs have certain required common functions; for example:

- Initiation of input/output operations.
- Input/output device error detection and recovery.
- Program loading.
- Communication between the program and the operator.

To save each 1130 system programmer the work of writing the instructions for these common required functions, IBM supplies a series of programs called, as a whole, the control program.

IBM also supplies other programs (which we can call processing programs), such as compilers (which translate source programs into object programs). A control program and the associated IBM-supplied processing programs is called a programming system. A number of these programming systems are available for the 1130 system. The major differences among the various programming systems lie in the capabilities of the various control programs:

1. The number of the various input/output devices that can be utilized.
2. Whether the control program is on cards or disk.
3. The ability to monitor the relatively uninterrupted execution of many programs (a programming system with this type of capability is called an operating system).

Some of the operator's functions (such as loading the control program, interpreting console typewriter messages, and responding to those messages) will vary considerably for each programming system. Operating functions for the card read punch, the printer, and the disk units (such as loading blank forms on the printer or loading a disk pack into a disk unit) will vary hardly at all.

In this manual, the main objective will be to teach you to operate the input/output devices and to perform certain functions with the console control panel. No specific programming system is assumed.

The IBM 1130 Computing System offers the user a variety of input/output devices. This manual describes the devices listed below.

- IBM 1131 Central Processing Unit, Models 1, 2, and 3.
- IBM 1055 Paper Tape Punch, Model 1.
- IBM 1132 Printer.
- IBM 1133 Multiplex Control Enclosure.
- IBM 1134 Paper Tape Reader, Models 1 and 2.
- IBM 1231 Optical Mark Page Reader, Model 1.
- IBM 1403 Printer, Models 6 and 7.
- IBM 1442 Card Punch, Model 5.
- IBM 1442 Card Read Punch, Models 6 and 7.
- IBM 1627 Plotter, Models 1 and 2.
- IBM 2250 Graphic Display, Model 4.
- IBM 2310 Disk Storage, Models B1 and B2.
- IBM 2501 Card Reader, Models A1 and A2.

All input/output devices are under control of the central processing unit program. Instructions in the program initiate all input/output operations. The operations are terminated by completion of the data transfer or by operator intervention at the input/output device. Input/output interrupts enable the central processing unit to provide appropriate programmed responses to conditions that occur in the input/output device. Priority sequences are assigned to allow the most efficient use of all input/output devices.

External documents, such as punched cards, data sheets, and paper tape, transfer information from input devices to the central processing unit. Information transferred to output devices from the central processing unit is represented in printed, graphic, punched card, disk, and paper tape format. Each data transfer rate is determined by the program and by the speed of the input/output device.

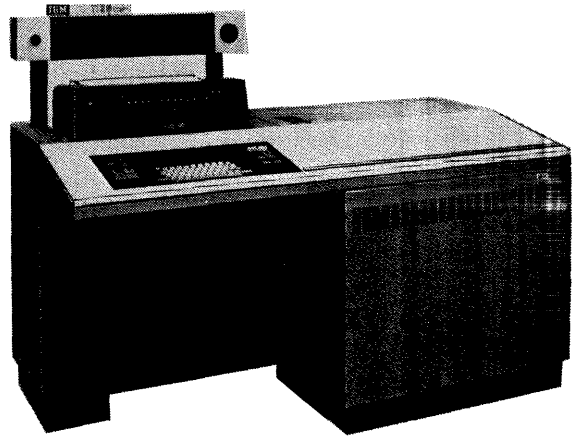

IBM 1131 Central Processing Unit, Models 1A, 1B, 2A, and 2B

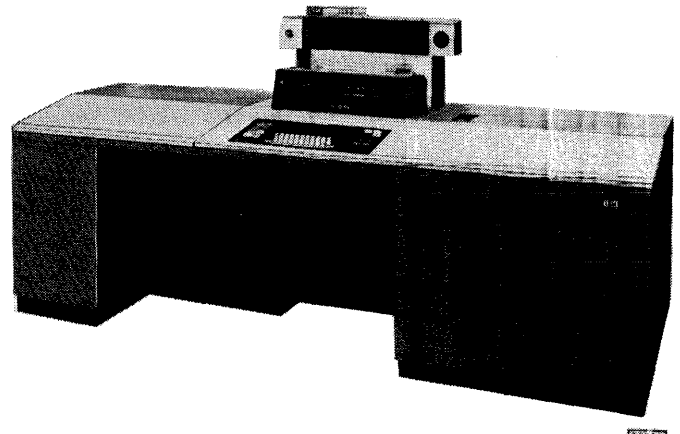

IBM 1131 Central Processing Unit, Models 2C, 2D, 3B, 3C, and 3D

The IBM 1131 Central Processing Unit is a compact and versatile component of the IBM 1130 Computing System. The design is oriented to the operator, and a minimum of training and experience with computing systems is sufficient to use the 1131 to solve problems.

The keyboard/printer console provides control of the operation. The console displays the data in various registers and counters within the central processing unit and provides switches for data entry and program control. The keyboard also provides data entry directly into core storage (under program control), and the printer provides printed output of the data in core storage.

The 1131 has three models: model 1, model 2, and model 3. Model 1 and model 2 each have a 3.6-microsecond core storage cycle time, the time required to enter a word into or retrieve a word from core storage. The model 2 has a single-disk storage drive. The model 3 has a 2.2-microsecond core storage cycle and also has a single-disk storage drive.

Single disk storage is an auxiliary storage device housed within the 1131 Central Processing Unit enclosure. It consists of a single disk drive and a removable disk cartridge. Storage capacity of each cartridge is 512,000 sixteen-bit words. The data transfer rate of the disk storage is 720,000 bits per second. The removable disk cartridge (the IBM 2315 Disk Cartridge) provides easy access to data or to entire programs. Additional disk cartridges can be stored off-line and put on-line as needed, thus providing virtually unlimited off-line storage capacity.

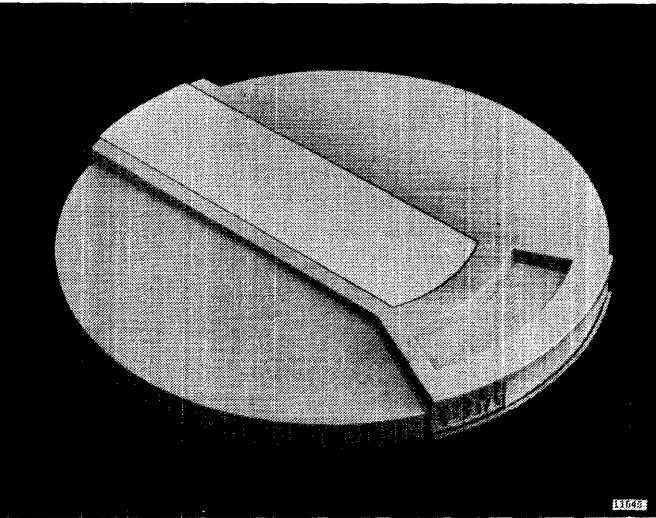

IBM 2315 Disk Cartridge

The 1131 main storage in the central processing unit uses magnetic cores for data and program instruction storage. Core storage capacity is 4,096 (4k) to 32,768 (32k) 16-bit words, depending on the model used:

	A	B	C	D
Model 1	4k	8k	--	--
Model 2	4k	8k	16k	32k
Model 3	--	8k	16k	32k

A 16-bit word can be placed into core storage or retrieved from core storage in one storage cycle, which is 3.6 microseconds for models 1 and 2 or 2.2 microseconds for model 3.

The core storage words are individually addressable or may be coupled and operated upon as double (32-bit) words. Data is recorded and processed in fixed-point binary form. The largest positive number is $2^{31}-1$; the largest negative number is -2^{31} .

The 1131 instruction set consists of 29 discrete instructions. A single-word or double-word instruction format is used to give the central processing unit added flexibility. Instructions fall into five categories: load and store, arithmetic and logic, shift, branch, and input/output. Three index registers and indirect addressing facilities are available for programming use.

The storage access channel provides a means for external devices or systems to communicate directly with the 1131 Central Processing Unit core storage. Communication with core storage from an external device is on either a cycle-steal or an interrupt basis and is initiated by the external device when it is ready to communicate. The IBM 1133 Multiplex Control Enclosure attaches to the storage access channel and provides the optional Storage Access Channel II to provide a similar facility to systems that have the 1133 attached.

The 1133 Multiplex Control Enclosure provides a communication path between external units or systems and the 1131 Central Processing Unit. Units of the 1130 system that require the 1133 are:

1. IBM 1403 Printer, Model 6 or Model 7.
2. IBM 2310 Disk Storage, Model B1 or Model B2.

The interrupt operation of the 1130 system allows each input/output device to operate at a maximum speed consistent with the programmed operation and makes the central processing unit available except during the actual transmission of data.

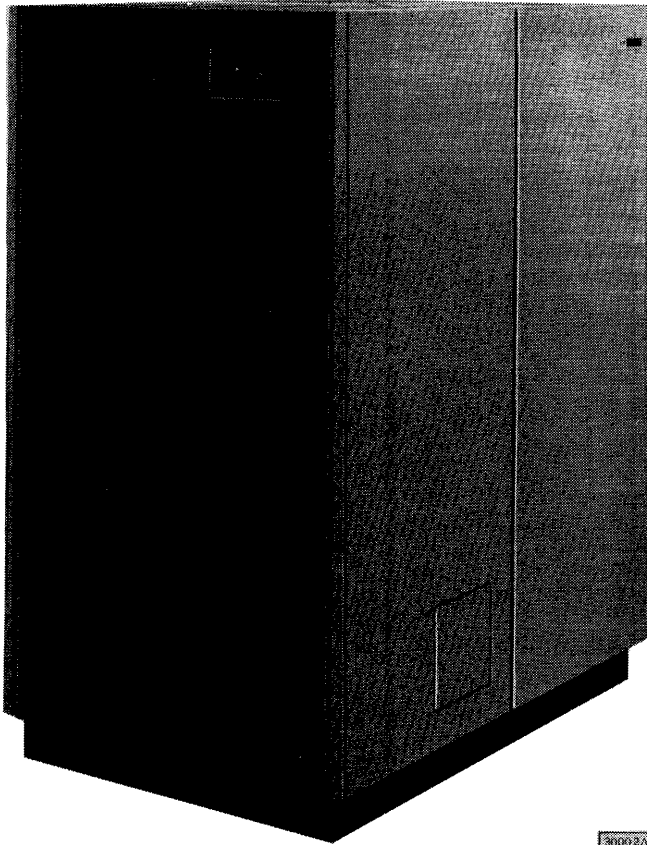

30002A

IBM 1133 Multiplex Control Enclosure

To request service, a device signals the central processing unit on one or more of the six interrupt levels. Each level has an established priority. If a higher priority device is not being serviced, the device requesting service interrupts the program long enough to execute the requested service.

The number of interrupt levels for any given system depends upon the configuration of the system.

High-speed data channels that transmit data to and from the central processing unit on a cycle-steal basis are used to operate the 2501 Card Reader, 1403 Printer, 1132 Printer, 2250 Display Unit, and all disk storage drives.

Cycle stealing should not be confused with interrupt. A device using the cycle-steal method does not interrupt the program to transfer data; it steals one cycle from the instruction being executed and transfers a character directly into or out of core storage without control of the central processing unit.

This type of operation requires less central processing time than would otherwise be required to service the above devices.

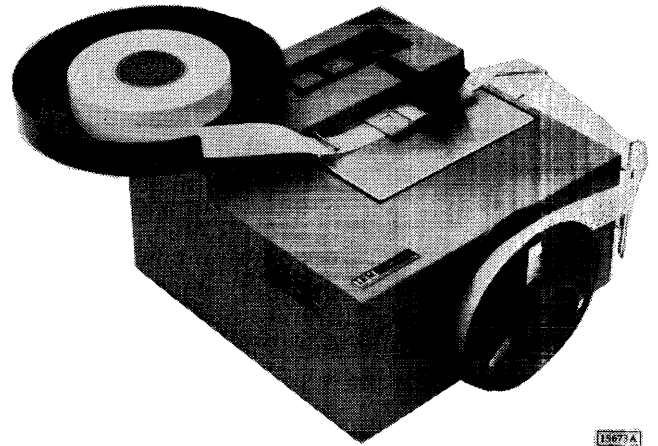

13077A

IBM 1055 Paper Tape Punch, Model 1

The IBM 1055 Paper Tape Punch, Model 1 punches eight-bit codes in eight-channel chad paper tape or edge-punched documents having prepunched feed holes. Chad paper tape means that the perforated holes made in the tape are completely and evenly punched out.

In both the paper tape and the edge-punched documents, the operator can manually punch only the delete and blank codes. All other punching is under control of the central processing unit program. Pressing the feed key or punching program-controlled characters automatically punches feed holes into the tape.

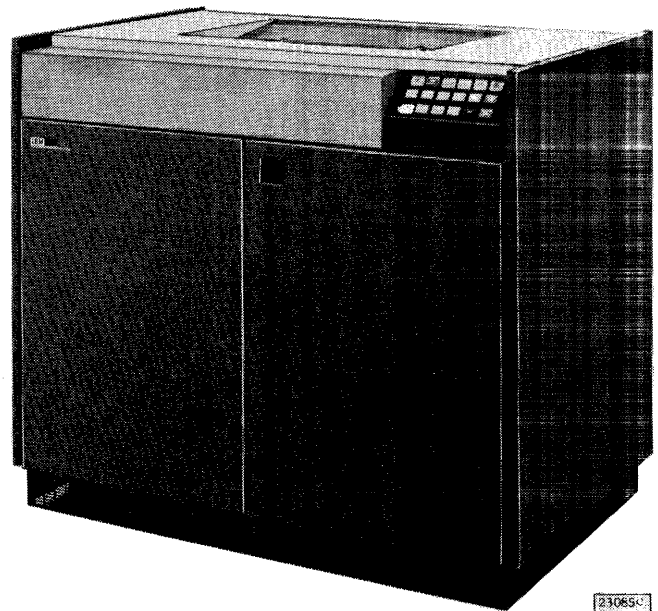

23065C

IBM 1132 Printer

The IBM 1132 Printer prints alphameric data at 80 lines per minute and numeric data at 110 lines per minute. The print line on the 1132 is a maximum of 120 characters, and the vertical (line) spacing is either six lines per inch or eight lines per inch.

With a program stored in the 1131 Central Processing Unit, a paper-tape-controlled carriage feeds forms continuously through the printer and, at the same time, controls skipping and spacing.

The 1132 Printer operates as an on-line output unit.

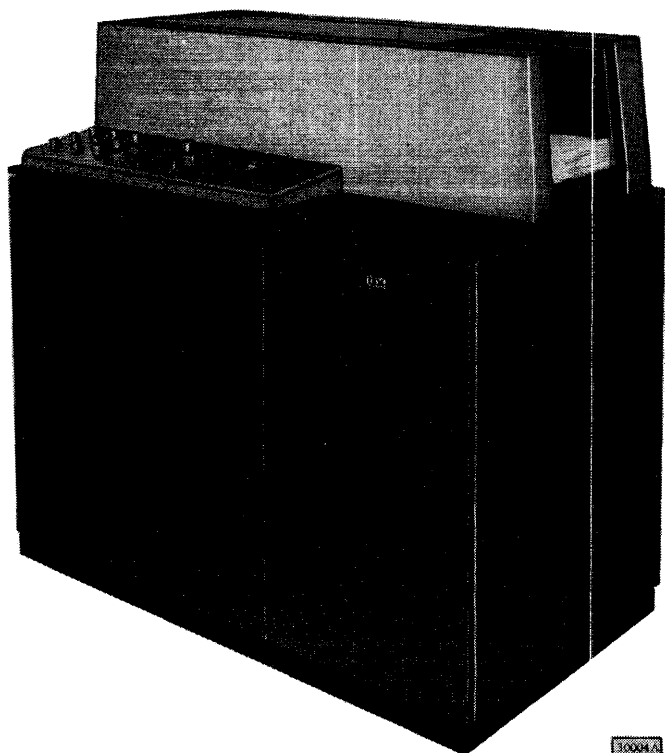

IBM 1231 Optical Mark Page Reader, Model 1

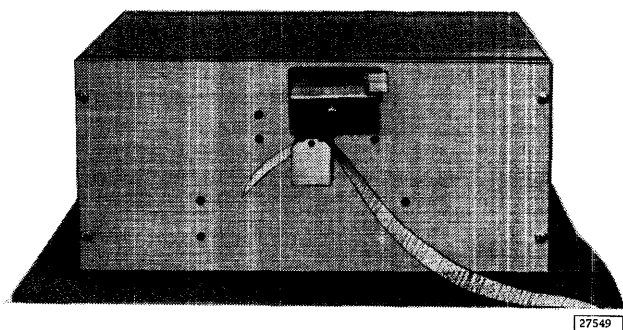

IBM 1134 Paper Tape Reader, Model 1

character code placed in core storage is accomplished through programming.

The IBM 1231 Optical Mark Page Reader, Model 1 reads positional marks made by an ordinary lead pencil on paper documents. The positional marks are converted into a machine-usable form by the 1231 and entered into its own delay line storage. The 1231 attachment in the 1131 accepts one word and makes it available to the system on an interrupt basis. This process is repeated until all of the data is transferred from the 1231 to the 1131.

Documents are read into the 1231 at a maximum of 2,000 sheets per hour. Throughput depends on computer programming.

By means of stored-program controls, the IBM 1231 can control specific data to be stored and identify the end of a field. Three sets of identical switches can be set for checking various conditions under which a document can be selected. These switches are field I, field II, and field III, and all are controlled by the program sheet. Each word can be regarded as a field by appropriate programming of the control sheet.

The IBM 1134 Paper Tape Reader, Models 1 and 2 are compact, self-contained devices capable of reading eight-channel perforated tape at speeds up to 60 characters per second. The model 1 reads strips of punched tape only; the model 2 has supply and take-up reels for reading punched tape fed in strips or from reels. The 1134 dynamically senses the presence of holes in the tape, thus ensuring positive identification of characters. Tape motion and tape reading are controlled by the operating program.

Each punched character is read into one addressed core storage location. Translation of the

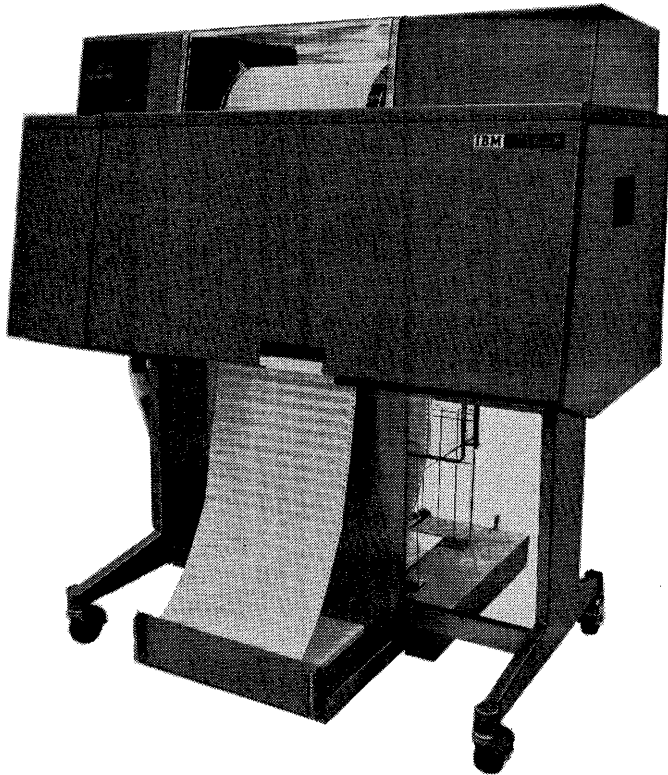

11230A

IBM 1403 Printer, Models 6 and 7

The IBM 1403 Printer provides high-speed on-line printing capabilities for the 1130 system. Models 6 and 7 are available for attachment to the 1130 system through the facilities of the 1133.

Model 6 has 120 print positions and prints a maximum of 340 lines per minute. The type HN chain is standard and has a 48-character printing set. Model 7 is identical to the model 6 except for printing speed. Model 7 prints a maximum of 600 lines per minute.

Both models 6 and 7 are equipped with a single-speed, tape-controlled carriage for transporting continuous paper forms. Printing and carriage operations are under control of the program.

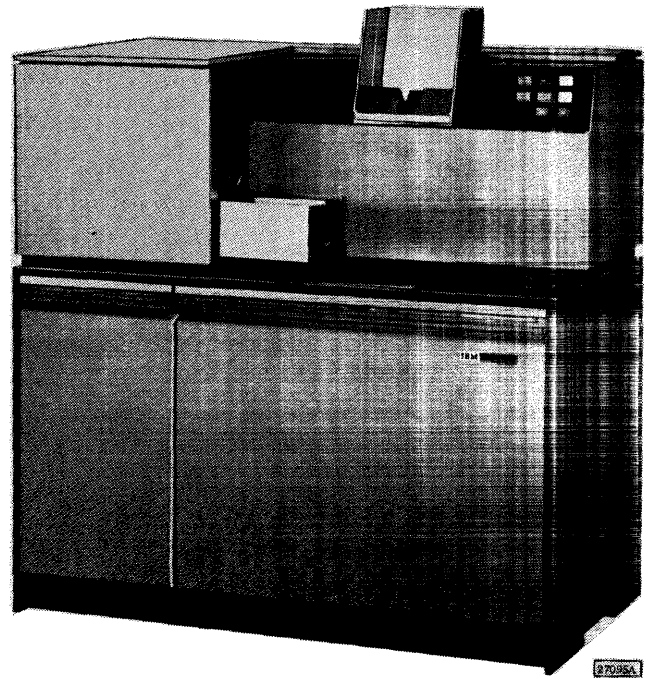

87095A

IBM 1442 Card Punch, Model 5

The IBM 1442 Card Punch, Model 5 is a unit that punches cards serially, column by column, beginning with column 1. The punching speed is 160 columns per second.

Cards are fed from a 1,200 card-capacity hopper, punched serially, and stacked in a 1,300 card-capacity stacker. Three card feed cycles move a card from the hopper through the card punch and into the stacker.

If a punch command is initiated, an incremental punch drive causes the card to be punched and moved through the punch station. The central processing unit compares the punch check echo data with the contents of the single-character punch buffer, consisting of the character from the central processing unit.

The card motion and punching process continue until a signal from the program indicates the last column to be punched. Upon this signal, the 1442

punches and generates an operation complete interrupt. Once punching is terminated in this manner, it cannot be restarted in this card. Punching occurs only by program instruction.

column by column, beginning with column 1. Reading is accomplished through the principle of photocell sensing. Each card column is read twice by the photocells, and the readings are compared for agreement. This read-check process continues until all 80 columns have been read. After a read operation is completed, the card is registered in column 1 at the punch station.

If a punch command is initiated, an incremental punch drive causes the card to be punched and moved through the punch station. The central processing unit compares the punch check echo data with the contents of the single-character punch buffer, consisting of the character from the central processing unit.

The card motion and punching process continue until a signal from the program indicates the last column to be punched. Upon this signal, the 1442 punches and generates an operation complete interrupt. Once punching is terminated in this manner, it cannot be restarted in this card. All cards pass through the read and punch stations, but reading and/or punching occurs only by program instruction. Cards are stacked in a 1,300-card capacity stacker.

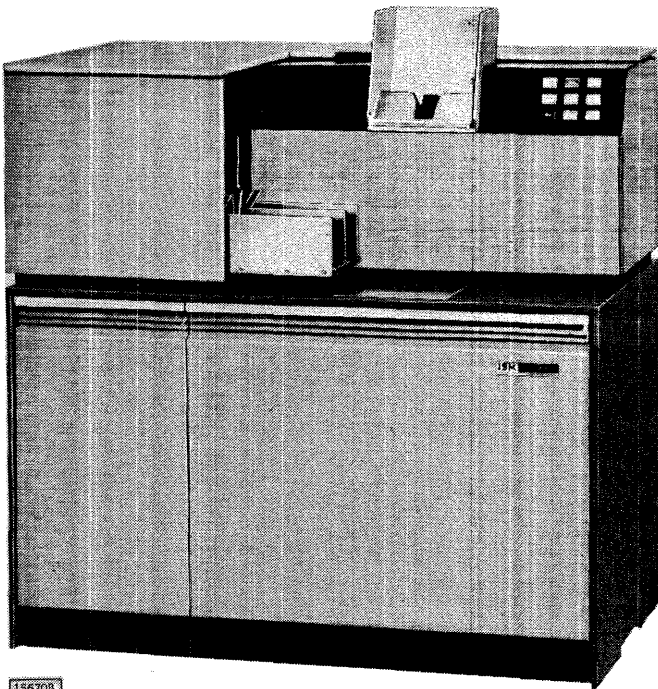

156708

IBM 1442 Card Read Punch, Models 6 and 7

The IBM 1442 Card Read Punch, Models 6 and 7 provide punched card input/output for the 1130 system. Card reading and punching are program controlled by the central processing unit.

The maximum machine speeds for card reading and card punching are:

Model 6: Read — 300 cards per minute.
Punch — 80 columns per second.

Model 7: Read — 400 cards per minute.
Punch — 160 columns per second.

Cards are placed in the hopper face down, 9-edge first. The hopper holds approximately 1,200 cards. Cards are fed from the hopper 9-edge first.

Card reading is initiated by a program command. The card is fed through the reading station during the second card feed cycle (first card read cycle). This feeding causes columns 1 through 80 of the card to be read in one continuous motion of the card. The card is read serially; that is,

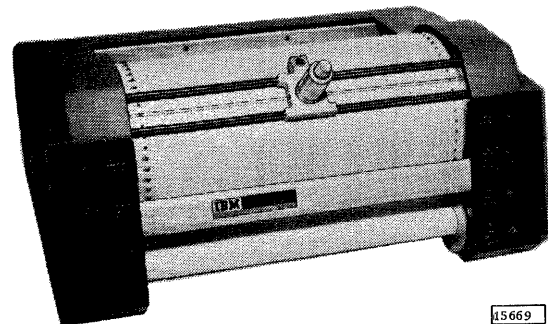

15669

IBM 1627 Plotter, Model 1

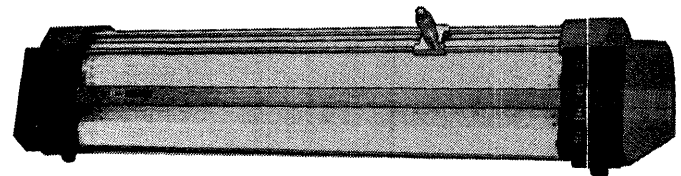

19166

IBM 1627 Plotter, Model 2

The IBM 1627 Plotter, Models 1 and 2 provide a reliable, easy-to-operate plotting system by converting tabulated digital information to graphic form. Bar charts, flow charts, organization charts, engineering drawings, and maps, in addition to graphs or drawings that depict financial, scientific, or technical data, can be plotted on the 1627 Plotter.

The characteristics of the two models of the 1627 are as follows:

Speed	X, Y Increments	Model 1	Model 2
		18,000 Steps/Minute	12,000 Steps/Minute
	Pen Status Change	600 Operations/Minute	600 Operations/Minute
Increment Size	1/100 Inch		
Chart Paper	Width	12 Inches	31 Inches
	Plotting Width	11 Inches	29-1/2 Inches
	Length	120 Feet	120 Feet
	Sprocket Hole Dimensions	0.130-Inch Diameter On 3/8-Inch Centers	0.188-Inch Diameter On 1-Inch Centers

19167

The recording of data by the 1627 is accomplished by the incremental movement of the pen on the paper surface (y-axis) and/or the paper under the pen (x-axis). The pen is mounted in a carriage that travels horizontally across the paper, as viewed from the front of the plotter. The vertical plotting motion is achieved by rotation of the pin feed drum, which also acts as a platen.

The drum and the pen carriage are bidirectional; that is, the paper moves up or down and the pen moves left or right. A control is also provided to lower or raise the pen in relation to the chart paper surface. The pen remains in the raised or lowered position until directed to change to the opposite status.

The drum and pen-carriage movements and the pen status are controlled by the central processing unit instruction. The bits are decoded into a directional signal and relayed to the 1627. Each signal to the plotter causes a 1/100-inch incremental movement of the pen carriage and/or paper, or raises or lowers the pen.

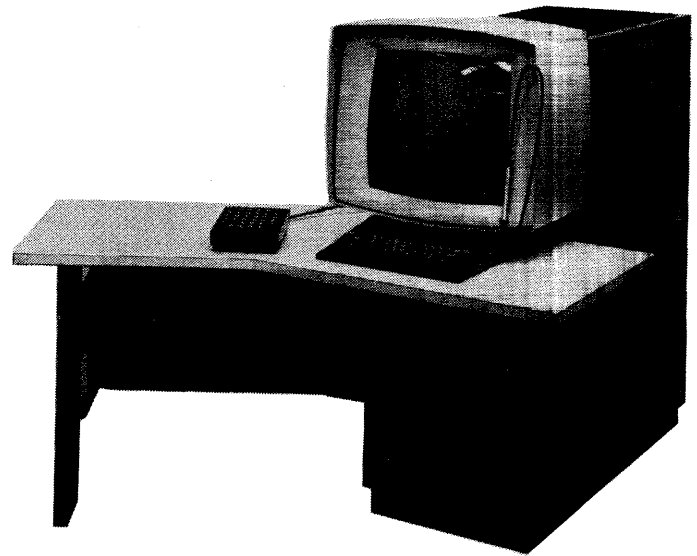

19078

IBM 2250 Display Unit, Model 4

The IBM 2250 Display Unit, Model 4 is a cathode-ray tube display unit that operates asynchronously with the 1130 system. The 2250 operates under the control of a display order program and control commands sent from the 1131 Central Processing Unit via the Storage Access Channel (SAC or SAC II).

The 2250 can generate images of vectors (straight lines), points, and characters on the 21-inch cathode-ray tube. (The usable display area is 144 square inches -- 12 inches by 12 inches.) A visible display is produced when the electron beam in the cathode-ray tube strikes the phosphor-coated cathode-ray tube screen. The screen area struck by the beam glows briefly. Normally, the glow fades within a fraction of a second -- too rapid for human eye perception or recognition. For this reason, the display is continuously regenerated at a discernible rate.

The 2250 display section also performs various nondisplay services by providing communication between the user and the program with three devices: the programmed function keyboard, the alphanumeric keyboard, and the fiber-optics light pen.

The programmed function keyboard provides communication between the user and a central processing unit program. The keyboard consists of keys, indicators, and sensing switches for use with replaceable descriptive overlays. The function of each key and indicator is defined by the central processing unit program. Punches in the top edge of each overlay identify the overlay to the central processing unit program. To identify the key and indicator functions to the operator, the key or indicator labels (or both) can be placed on the overlay. Each key can be used by the program to initiate a subroutine associated with the respective overlay, thereby performing the indicated function. For example, depression of a key might result in the enlargement, reduction, or deletion of the display image.

The alphameric keyboard makes it possible for character displays to be created, edited, or changed by the user. With the typewriter-like keyboard, alphameric messages can be entered into the display program for displaying and editing. The alphameric keyboard key codes can be interpreted by the central processing unit program and used for control purposes in a manner similar to operations with the programmed function keyboard.

The light pen provides the means by which the display order program and the central processing unit program can identify the storage address of the order that initiated the display of a vector, point, or character. This information can be used for operations determined by the display program, by the alphameric keyboard, or by the programmed function keyboard. The user can identify a displayed image simply by pointing the light pen at the image or by pressing the tip switch (the point at the end of the light pen) against the image. The method of identification is determined by the display program.

The IBM 2310 Disk Storage, Models B1 and B2 provide additional random access storage for the 1131. Model B1 contains one disk drive, and model B2 contains two disk drives.

The disk storage recording medium is an oxide-coated disk in an interchangeable IBM 2315 Disk

Cartridge. The disk cartridge is divided into 200 cylinders of two tracks each: one track on the upper surface and one track on the lower surface. A magnetic head, which performs reading and writing functions, is provided for each of these surfaces. All accesses are direct, and the access mechanism will move plus or minus the number of requested cylinders from its present position.

Each track is further divided into four sectors for ease of block handling. The total capacity of each disk is 512,000 sixteen-bit words. Although the capacity of each sector is 321 words, it is recommended that one word be written as a sector address, leaving 320 data words. A command may

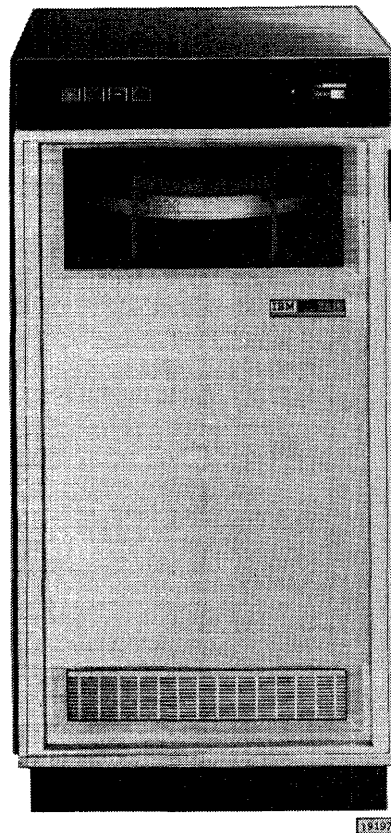

IBM 2310 Disk Storage, Model B1

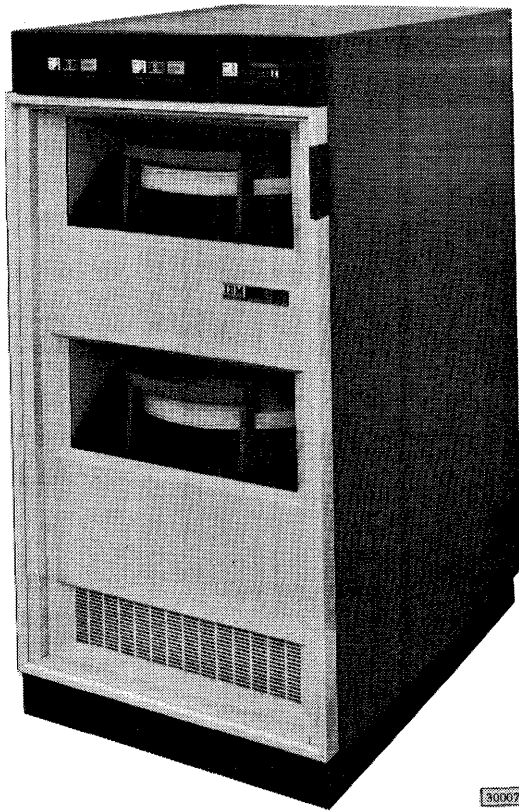

IBM 2310 Disk Storage, Model B2

specify any number of words equal to or less than 321. A zero word count is illegal and causes an interrupt. Nothing in the 2310 limits reading or writing to 321 words; therefore, the program must limit the word count.

The magnetic disk turns at 1,500 revolutions per minute, making the revolution time 40 milliseconds. The word rate is 36,000 words per second or approximately 27.8 microseconds per word.

Cylinder-to-cylinder access time is 15 milliseconds. At least 20 to 25 milliseconds must be allowed for the carriage to stabilize itself at the addressed cylinder before reading or writing can begin.

The IBM 2501 Card Reader, Models A1 and A2 provide punched card input for the 1130 system. Model



IBM 2501 Card Reader, Models A1 and A2

A1 reads cards at a maximum of 600 cards per minute; the model A2 reads at a maximum of 1,000 cards per minute.

Under program control of the 1131, cards are read serially; that is, column by column, beginning with column 1. Each column is read twice, and the two readings are compared to check reading accuracy. Off-punched and mispositioned cards are thereby detected.

Reading is done by photocells, which convert light energy into electrical energy. Twelve cells, one for each row of punching positions in the card, are exposed to light as holes in the card pass by them.

Cards are fed from the hopper, through the read station, and into the stacker. The hopper has a capacity of approximately 1,200 cards. The stacker has a capacity of approximately 1,300 cards.

IBM 1131 CENTRAL PROCESSING UNIT

The console display panel displays the contents of the central processing unit registers by small incandescent lamps -- one lamp for each register position. Each lamp glows when the register position it represents has a binary 1. If a binary 0 is in a register position, no light comes on. All registers are programmable and operate as necessary to enable the central processing unit to provide the results specified by the program.

Operators of an 1130 system should be familiar with the following indicators: instruction address, storage address, accumulator, accumulator extension, operation register, W (wait), and interrupt levels. All other indicators are primarily used by programmers and customer engineers.

To read the contents of the registers, imagine that each register is divided into four sections, each containing four binary positions (exceptions: instruction address register -- 15 positions, and storage address register -- 15 positions). These four sections represent a hexadecimal number, which in one case represents the contents of the instruction address register; in another, the storage address register; in still another, the storage buffer register; etc.

To determine the contents of the registers, simply note which lights are on in each of the four

sections and translate each group as in the following example:

	Section 4				Section 3				Section 2				Section 1			
INSTRUCTION ADDRESS	1	2	3		4	5	6	7	8	9	10	11	12	13	14	15
Binary	0	0	1	1	0	1	1	0	1	1	1	1	0	0	0	1
Conversion	8	4	2	1	8	4	2	1	8	4	2	1	8	4	2	1
Hexadecimal	3				6				F				1			

Starting at the right in the first section, a light is on in position 15, indicating that section 1 contains a bit configuration of 0001, which is equal to the hexadecimal digit 1. In section 2, lights are on in positions 8, 9, 10, 11, indicating that section 2 contains a bit configuration of 1111, which is equal to a hexadecimal F or 15 (8 + 4 + 2 + 1). Section 3 contains 0110 bits, or 6 (4 + 2); and section 4 contains 0011 bits, or 3 (2 + 1). The instruction address is /36F1.

Note: When a "/" precedes a number, the number is hexadecimal; for example, /26 is the same as hexadecimal 26 or 26 (base 16).

Operator Controls: Console Entry Switches

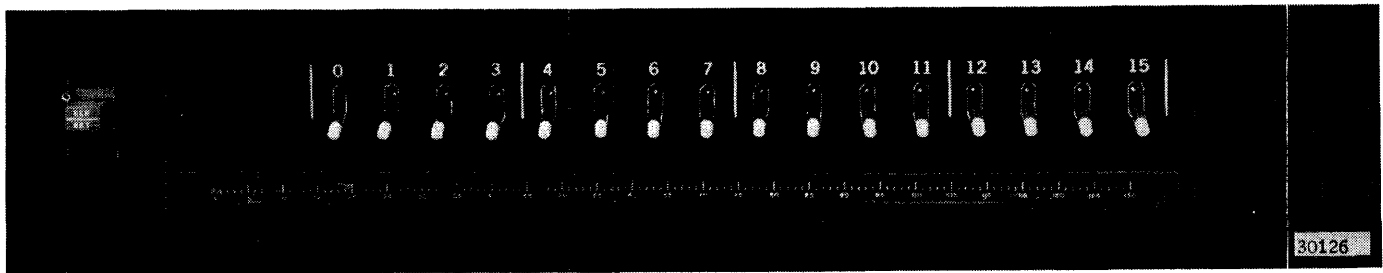

The 16 Console Entry Switches are used to enter data, instructions and addresses. Each switch is directly related to a bit position of a core storage word.

These switches are used with the mode switch on

the display panel and the control switches on the console keyboard.

To enter data from the bit switches under program operation, the console/keyboard switch must be in the console position.

Operator Controls: Console Display Panel

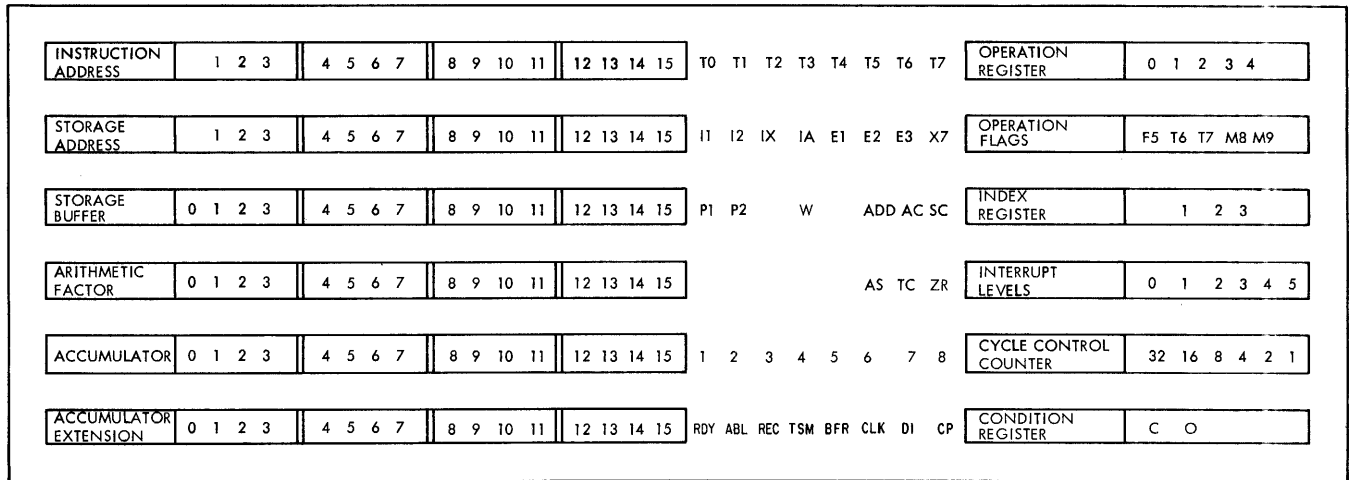

16165A

The Instruction Address Indicator represents the status of the 15 bits in the instruction address register. The instruction address register holds the address of the next sequential instruction.

The Storage Address Indicator represents the status of the 15 bits in the storage address register.

The storage address register contains the address of the last reference to a core storage word.

The Storage Buffer Indicator represents the status of the 16 bits in the storage buffer register.

The storage buffer register is the buffer between the central processing unit and core storage. Each word of data transferred into or transferred out of core storage passes through the storage buffer register.

The Arithmetic Factor Indicator represents the status of the 16 bits in the arithmetic factor register.

The arithmetic factor register holds one of the two operands during arithmetic and logical operations.

The Accumulator Indicator represents the status of the 16 bits in the accumulator register.

Data can be loaded into the accumulator register from core storage; conversely, data can be stored in core storage from the accumulator register. Data in the register can also be shifted to the right or to the left and can be manipulated by arithmetic and logical instructions. The accumulator register contains the binary number or expression resulting from an arithmetic or logical operation.

Error conditions, which are generally not-ready conditions or FORTRAN pause conditions, are indicated by the accumulator indicator.

The Accumulator Extension Indicator represents the status of the 16 bits in the accumulator extension register. The accumulator extension register and the accumulator register are used as a 32-bit register. The 16-bit accumulator extension register is the low-order extension of the accumulator register. The accumulator extension register receives the data shifted to the right by the accumulator register or by a load double command code. The accumulator extension register is also used for multiplication and division operations and double-word arithmetic.

T0 through T7 Indicators represent the last clock step completed.

I1, I2, IX, IA, E1, E2, and E3 Cycle Indicators indicate the type of machine cycle in process when in single step mode. They indicate the machine cycle just completed when in any other mode.

The X7 Indicator turns on when the cycle-steal clock is in X7; that is, stopped.

The P1 and P2 Indicators indicate the parity of the storage buffer register. P1 is on when bits 0-7 contain an even number of bits, and P2 is on when bits 8-15 contain an even number of bits.

The W (Wait) Indicator is on when the central processing unit is in a wait condition. The following conditions turn on the W indicator:

1. The machine executes a wait instruction or a FORTRAN pause.
2. The machine attempts to execute an operation code that is illegal, particularly a blank (b).

When a W condition is indicated, the central processing unit can be restarted at the next sequential instruction (after the wait instruction) by pressing the program start key.

The central processing unit is also restarted when an interrupt occurs. This restart is under control of the program and requires no operator intervention.

The requirements of the application being processed determine when the operator should press the program start key to resume program operation.

The ADD, AC, SC, AS, TC, and ZR Indicators indicate the status of the following functions: add, arithmetic control, shift control, accumulator sign, accumulator carry, and zero remainder.

1 through 8 Indicators are used by the customer engineer. Each lamp can be wired by a customer engineer to give a visual indication of any condition in the machine.

The next eight indicators are associated only with the Synchronous Communications Adapter.

The RDY (Ready) Indicator turns on when the data set is ready.

The ABL (Enable) Indicator turns on when the program has enabled the adapter to respond to a ring indicator signal from the data set.

The REC (Receive) Indicator turns on when the receive trigger of the adapter is on.

The TSM (Transmit Mode) Indicator turns on when the adapter is in the transmit mode.

The BFR (Buffer Loaded) Indicator turns on when the buffer contains data.

The CLK (Clock Running) Indicator turns on when the receive clock is running.

The DI (Data In) Indicator turns on when the receive data line from the data set is at a zero or space level.

The CP (Character Phase) Indicator turns on when the adapter is operating in character phase.

The Operation Register Indicator indicates the operation in process when in single step (SS) mode or single machine cycle (SMC) mode. The indicator indicates the operation just completed when in any other mode.

Error conditions in the operation register generally occur when (1) the machine has executed a wait condition, (2) a FORTRAN pause, or (3) an invalid instruction such as all blanks.

Illegal instructions are as follows:

00000	10110	00111	01010
01111	01011	10111	11111

The Operation Flags Indicator indicates the status of the format, tag, and modifier bits of the instruction shown in the operation register.

The Index Register Indicator shows which one of the three index registers is being used.

The Interrupt Levels Indicator shows the interrupt level being serviced. The level indicator that is on aids in identifying the device that is being serviced by the interrupt subroutine.

The following indicators aid in identifying 1130 system devices:

1. 0 - 1442 Card Punch, Model 5
- 1442 Card Read Punch, Models 6 and 7
2. 1 - 1132 Printer
Synchronous Communications Adapter
3. 2* - Disk Drive
4. 3* - 1627 Plotter, Models 1 and 2
2250 Display Unit, Model 4
5. 4* - 1055 Paper Tape Punch, Model 1
1134 Paper Tape Reader
1231 Optical Mark Page Reader, Model 1
1403 Printer, Models 6 and 7
1442 Card Punch, Model 5
1442 Card Read Punch, Models 6 and 7
2501 Card Reader
Console Interrupt Request Key
6. 5* - Program Stop Key
Console Mode Switch

The Cycle Control Counter Indicator represents the binary value contained in the shift counter.

The Condition Register Indicator represents the status of the carry indicator (C) and the overflow indicator (O).

*These interrupt levels may also have a Storage Access Channel (SAC) device.

Operator Controls: Console Function Switches and Lights

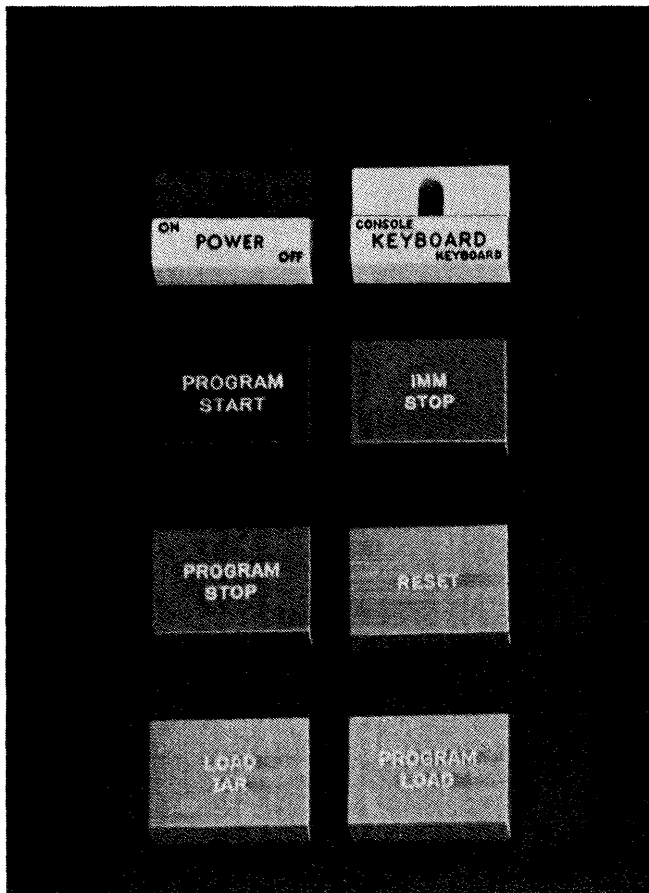

The Power On/Off Switch turns on the electrical power to the 1130 system.

The Keyboard Console/Keyboard Switch indicates (to the program) the desired source of the console input data -- either the keyboard or the console entry switches.

The Program Start Switch causes the 1131 to take one clock step or one machine cycle (and to continue taking additional cycles), depending on the setting of the console mode switch. Eight clock steps complete one machine cycle, and one or more machine cycles complete an instruction.

The IMM (Immediate) Stop Switch causes an immediate stop of the processor interrupt, although the input/output devices will finish their present cycle. Data from the devices may be lost if they are operating when the IMM stop key is pressed. A complete program restart is normally required.

The Reset Switch resets all input/output and machine registers, cycle and control triggers, and status indicators.

The Load IR (Instruction Register) Switch places the status of the 16 console entry switches in the instruction address register. The console mode switch must be set to LOAD.

The Program Load Switch loads the first card or paper tape record into core storage, beginning at 00000.

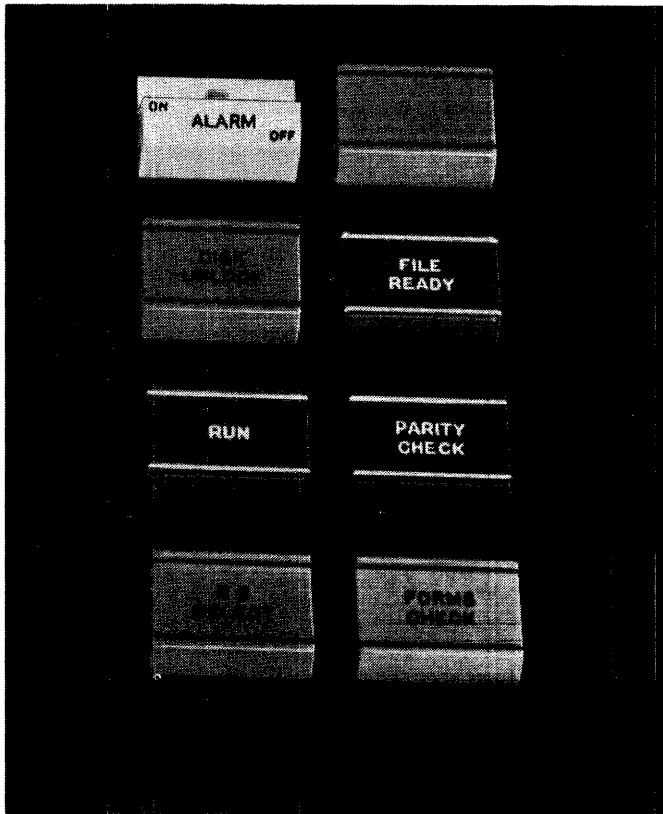

19100

The Alarm On/Off Switch turns off the Synchronous Communications Adapter (special feature) alarm in the 1131. The operator uses this switch to turn the alarm off only if the program should fail to turn it off.

The Disk Unlock Light turns on when the disk cartridge can be removed from the disk drive.

The File Ready Light turns on when the disk storage is available for reading and writing.

The Run Light turns on when the central processing unit is operating and the meter is running.

The Parity Check Light turns on when a parity error is detected in either half of a word read out of core storage.

The KB Select Light turns on when an instruction requests input data from the keyboard.

The Forms Check Light turns on when the last form is detected by the console printer forms contact.

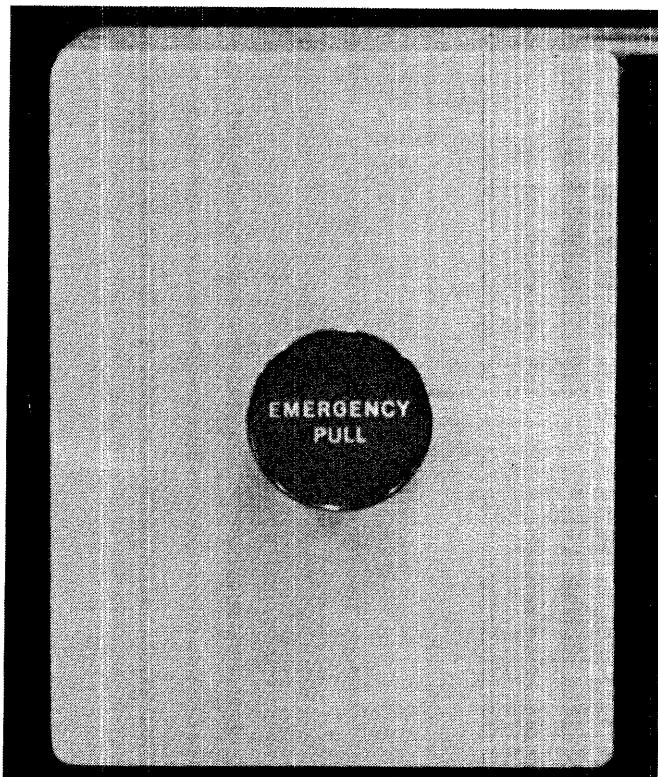

19098

The Emergency Pull Switch, as the name of the switch implies, should be initiated only under unusual circumstances. Once the emergency pull switch is pulled, it is mechanically locked so that system power cannot be brought up again until the customer engineer has reset this switch. All power -- including that to all on-line input/output units -- is dropped without regard to sequencing. Therefore, the contents of main storage may be partially destroyed during an emergency pull operation.

The system is protected by thermal overload switches. If the temperature of the operating environment is too high, these switches will drop system power. The customer engineer should be contacted whenever system power cannot be maintained.

Operator Controls: Console Mode Switch



19101

The SS (Single Step) Setting, with each depression and release of the start key, causes the 1131 clock to advance one step; for example, from T1 to T2.

The SMC (Single Memory Cycle) Setting, with each depression of the start key, causes the central processing unit to advance one machine cycle; for example, I1 to I2.

The INT RUN (Interrupt Run) Setting causes a level 5 interrupt after each mainline program instruction is completed. This setting is convenient for program trace routines.

The RUN (Program Run) Setting causes the 1131 to advance through its stored program when the start key is pressed.

The SI (Single Instruction) Setting causes the 1131 to interpret and execute a single instruction when the start key is pressed.

The DISP (Display Core Storage) Setting, after pressing the start key, displays (in the storage buffer register) the core storage word at the location specified by the address in the instruction address register and advances the instruction address register.

The LOAD (Load Core Storage) Setting, after pressing the start key, loads the data from the console entry switches into core storage at the location specified by the address in the instruction address register and advances the instruction address register.

Operator Controls: Single Disk Storage Panel

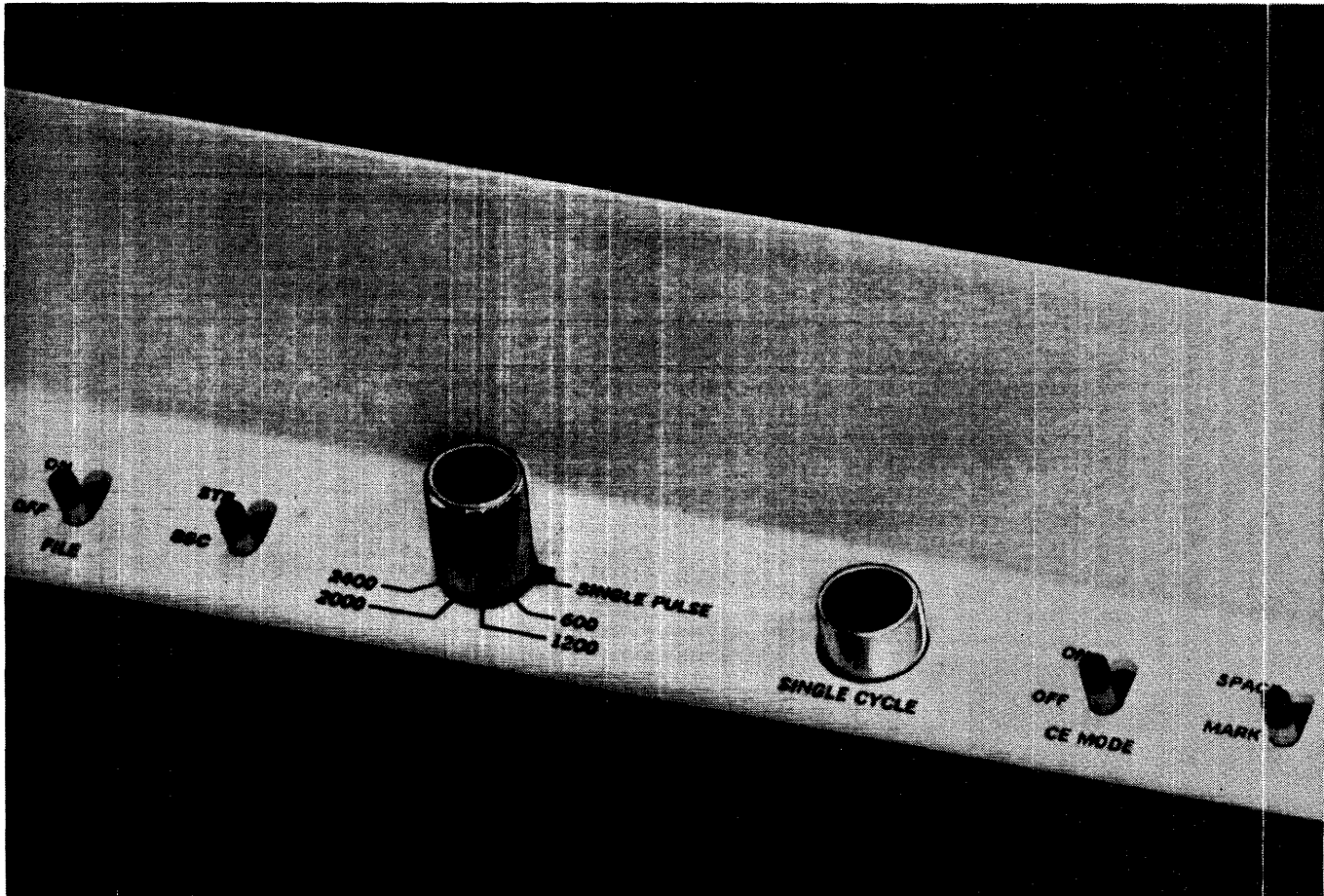

19103

The File On/Off Switch causes the disk drive to cycle up (start) or cycle down (stop). To cycle up means that the single disk storage is in ready status. The disk drive takes approximately 90 seconds to cycle up and approximately 40 seconds to cycle down.

The STR/BSC (Synchronous Transmit Receive/Binary Synchronous Communication) Toggle Switch is set to STR or to BSC to select the mode of communication.

The Speed Selection (Single Pulse, 600, 1200, 2000, and 2400) Rotary Switch is set to establish the number of bits per second that may be transmitted

or received. In actual practice, the switch setting is determined by the data set.

The Single Cycle Pushbutton Switch is used by the customer engineer to aid in maintaining the adapter.

The CE (Customer Engineer) Mode On/Off Toggle Switch is used by the customer engineer in maintaining the adapter. This switch must be turned off for normal adapter operations.

The Space/Mark Toggle Switch is effective only when the CE mode switch is on. It controls the flow of data to the read deserializer.

Operator Controls: Console Keyboard

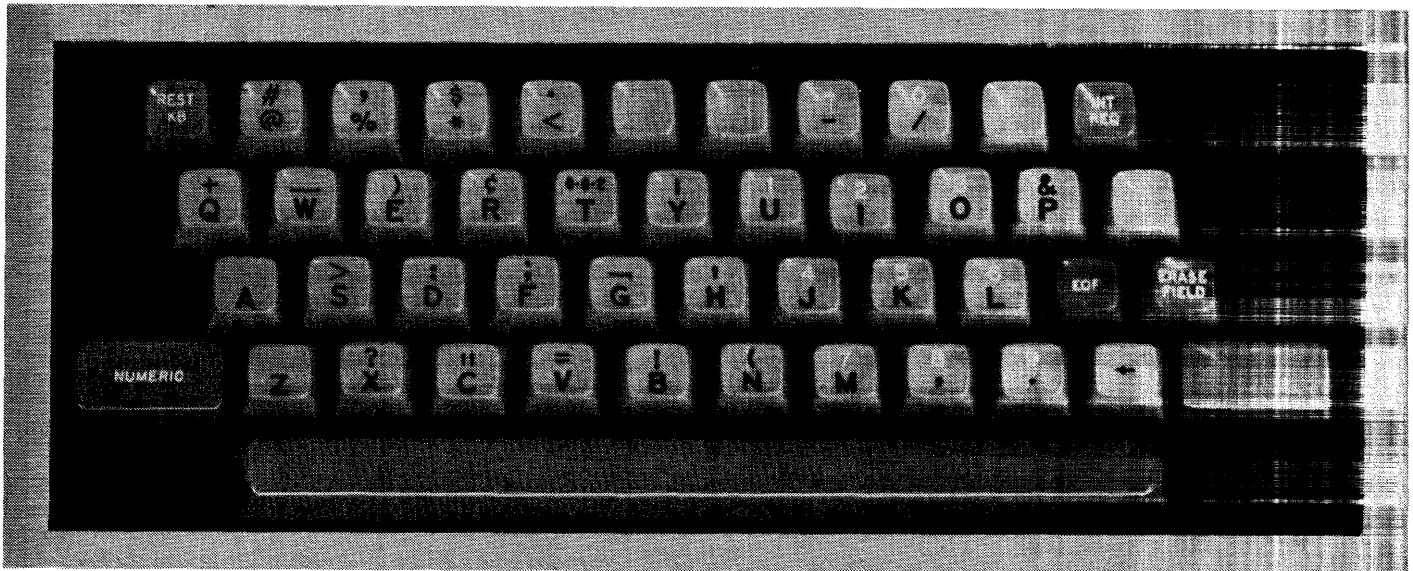

19253

The REST KB (Restore Keyboard) Key allows the operator to restore the keys if they should become locked.

The INT REQ (Interrupt Request) Key initiates a keyboard restore and causes an interrupt in the central processing unit.

The EOF (End of Field) Key places a word containing a 12 bit in core storage. The program determines from the analysis of this word that no further characters are to be sent in the message.

The Erase Field Key places a word containing a 14 bit into core storage. Analysis of this word allows

the program to determine that the message being entered is to be deleted and replaced by a corrected message.

The Numeric Key places the keyboard in the numeric mode. The numeric key must be held down continuously while entering numeric data.

The (←) Backspace Key places a word containing a 13 bit in core storage. Analysis of this word allows the program to determine that the last character received is to be replaced by the next character to be entered.

Readying the IBM 1130 Computing System

Most operator action will occur at the console of the 1130 system. This console, as well as three input/output devices -- the keyboard/console printer, the console entry switches, and a single disk storage drive -- are all located in or on the 1131 Central Processing Unit.

When the 1131 power switch is turned on, the following console operator panel lights will be on: DISK UNLOCK (no cartridge in single disk storage drive) and FORMS CHECK (if there is no paper in the console printer). If any other operator panel lights are on, press the reset key.

Readying the Console Printer

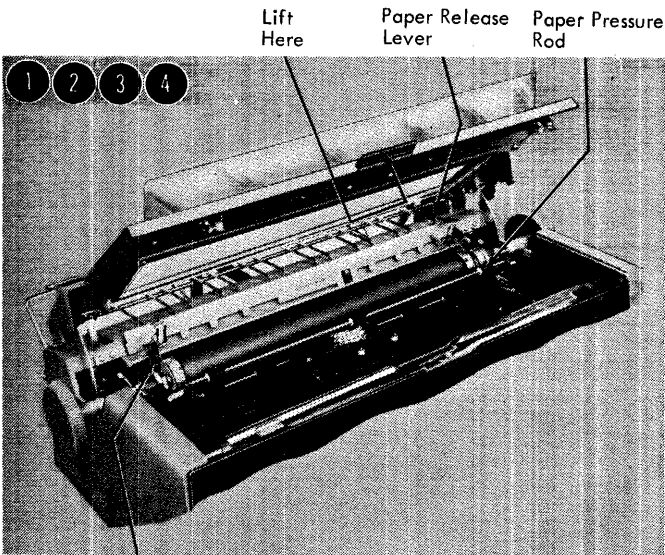

Platen Pin Feed Pressure Plate

19196

1. Open the console printer top cover.
2. Pull the paper pressure rod forward. If the paper is to be pin fed, this rod should remain in this position.
3. Lift up on the left and right platen pin feed pressure plates.
4. Set the paper release lever in the forward position. If the paper is to be pin fed, this lever should remain in this position.

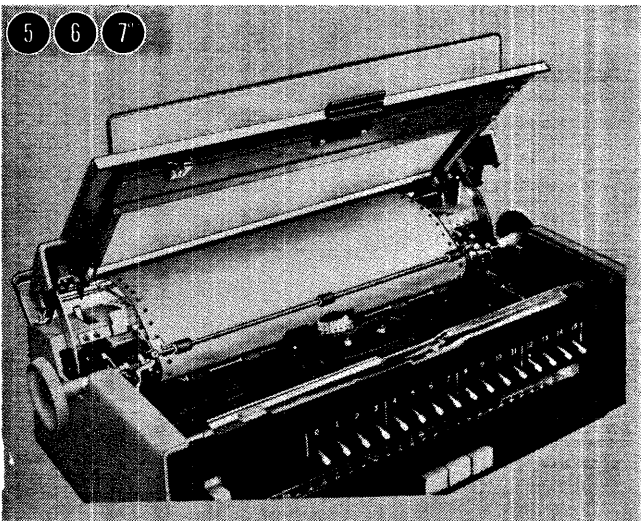

19196

5. Feed the paper in from the rear and guide it under the platen. Make sure that the paper lies over and closes the forms check microswitch. This closure will turn off the forms check light on the console operator panel.
6. Lay the paper back across the top of the console printer and guide the paper so that the holes line up with the pin feeds.
7. Close the pin feed pressure plates.

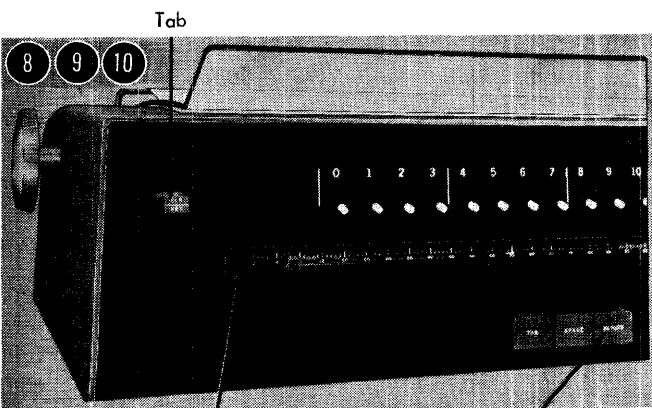

Margin Scale

Return

19200

8. Set the left and right margins. The margin settings can be read on the scale across the front of the unit.
9. Close the top cover.
10. Press RETURN. The console printer is now in ready status.

Readying the Disk Storage Drive

Pull
Here

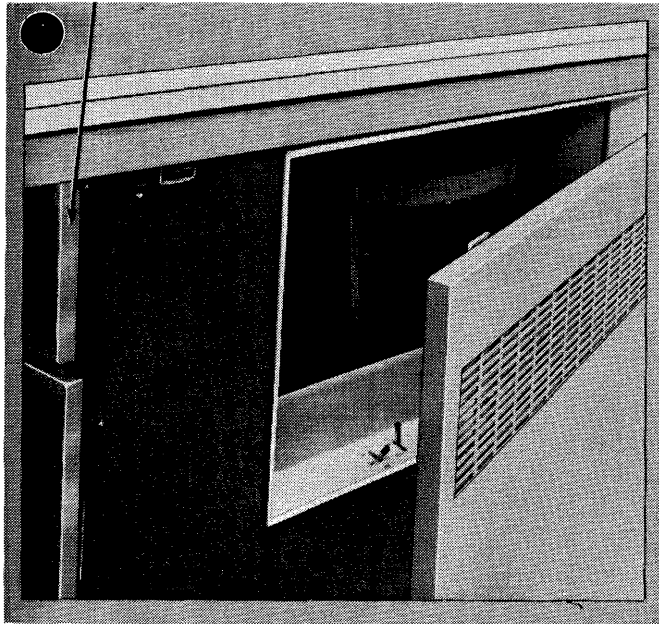

19199

1. Open the single disk storage access cover. The cover swings open to the right.

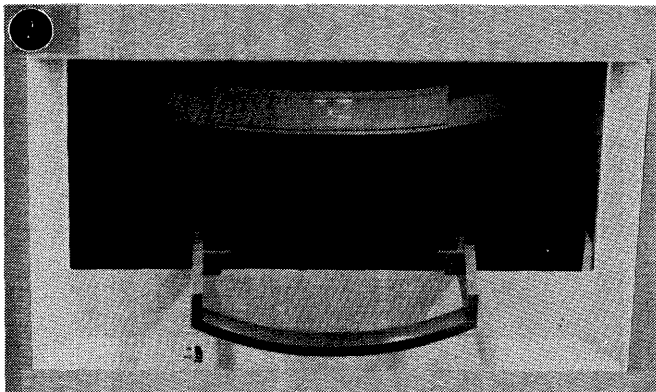

19110

2. Grasp the handle to the access release mechanism and pull out and down.

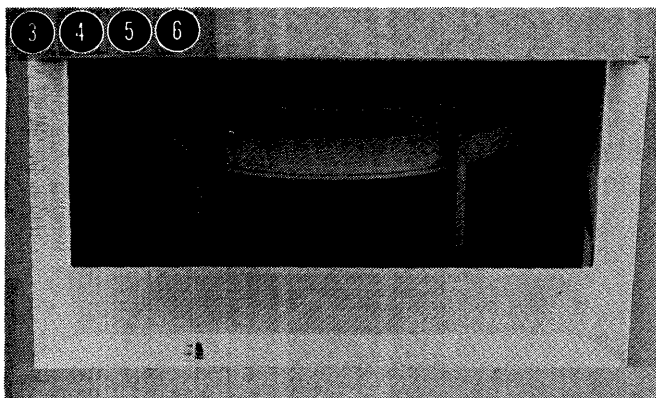

19109

3. Pick up the cartridge and, holding the cartridge with the IBM name toward you and on the left, insert the cartridge into the slot.
4. Raise the release handle to lock the cartridge into place when the cartridge is seated.
5. Turn the disk switch to the on position. As the disk starts to turn, the disk unlock light on the console operator panel will go out.
6. Close the access cover.

When the drive comes up to speed (approximately 90 seconds), the disk ready indicator on the console operator panel will turn on. The single disk storage drive is now in ready status.

Removing a Typing Element

Element Release Lever

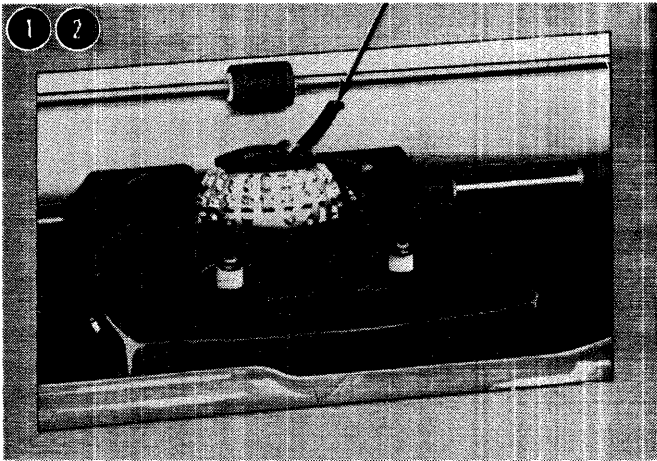

19204

1. Lift the front cover.
2. Lift the element release lever with your right thumb and forefinger until the lever clicks into the upright position.

Element Post

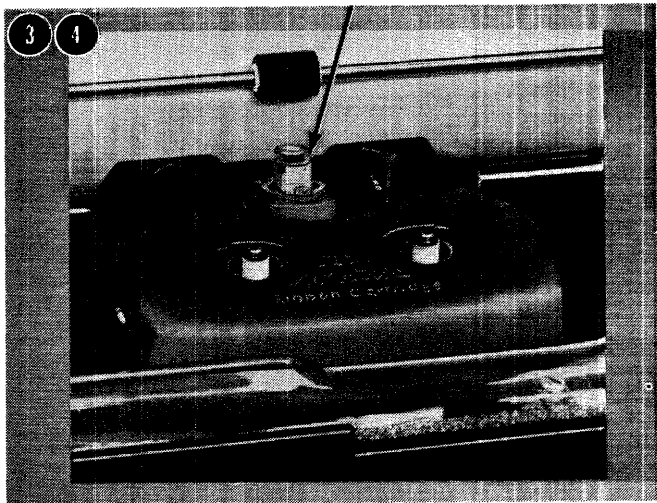

19205

3. Remove the element by grasping it by the element release lever and lifting it off the element post.
4. Close the cover.

Replacing a Typing Element

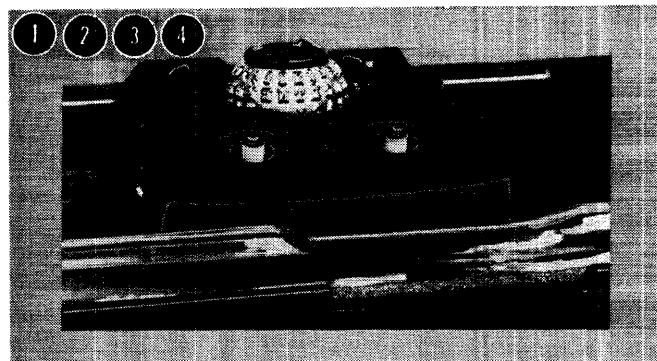

19206

1. Lift the front cover.
2. Grasp the element release lever with your thumb and index finger and place the typing element on the element post with the triangle facing the platen.
3. Slip the element into place on the element post and close the lever. Avoid using force.
4. Close the cover.

Removing a Fabric Ribbon Cartridge

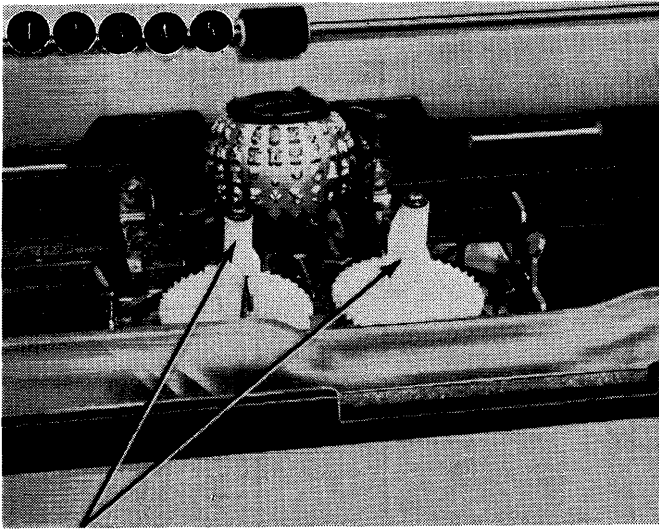

Ribbon Cartridge Spindles

19207

1. Lift the front cover.
2. Keep the paper bail against the platen.
3. Lift the cartridge upward and off the ribbon cartridge spindles.
4. Ease the ribbon out of the slots in the ribbon lifts.

To rewind excess ribbon, insert a pencil in either of the holes in the base of the cartridge and turn in the direction of the arrow.

5. Close the cover.

Installing a Fabric Ribbon Cartridge

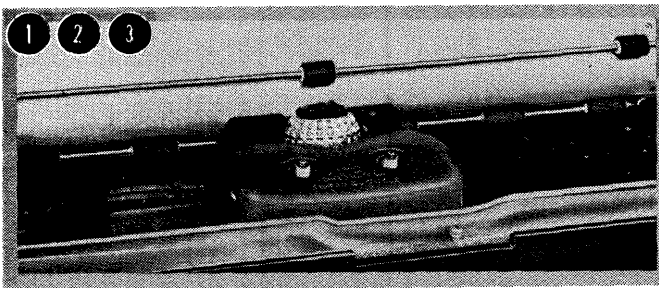

19208

1. Lift the front cover.
2. Keep the paper bail against the platen.
3. Draw ribbon in tight and position the cartridge in front of the ribbon lifts.

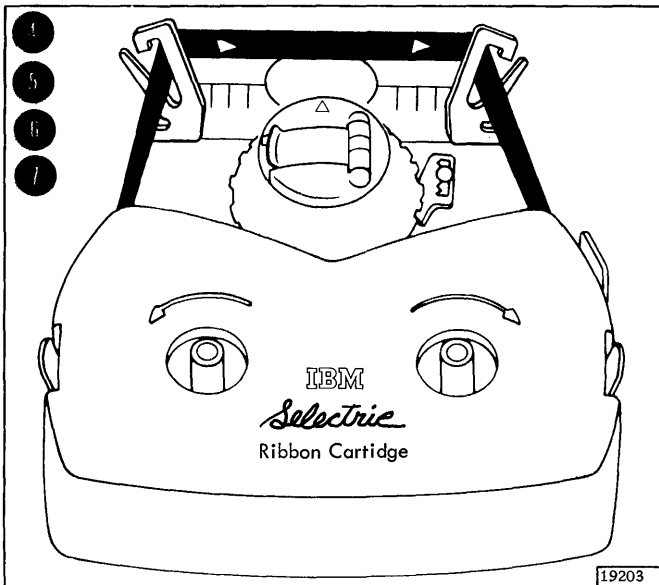

19203

4. Slide the ribbon through the right ribbon lift.
5. Slide the exposed ribbon down between the card holder and the element, and then through the left ribbon lift.
6. Place the cartridge on the two spindles and press down evenly and firmly.

To rewind excess ribbon, turn either spindle in the direction of the arrow.

7. Close the cover.

Operator Controls

Tape
Advance
Wheel

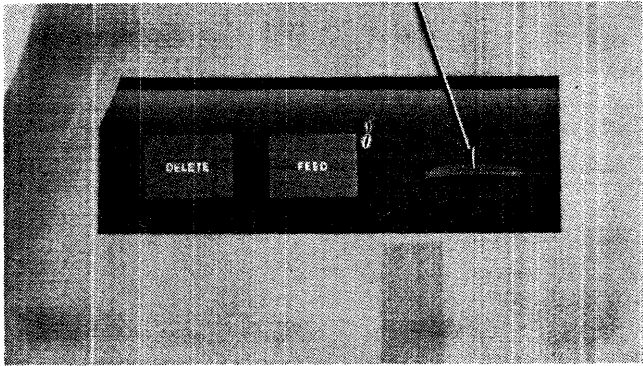

19097

The Delete Key advances the tape one position while simultaneously punching a delete code (seven punched channels) and a feed hole (the smallest hole). By simultaneously pressing and holding down the delete and feed keys, the operator can continuously punch delete codes.

The Feed Key steps the tape one position at a time, punching a feed hole at each step, as long as the key is held depressed.

The Tape Advance Wheel, when turned clockwise or counterclockwise, feeds the tape forward or backward through the punch mechanism without punching any holes. The feed mechanism does make indentations in the feed hole area of the tape, however.

Inserting Paper Tape

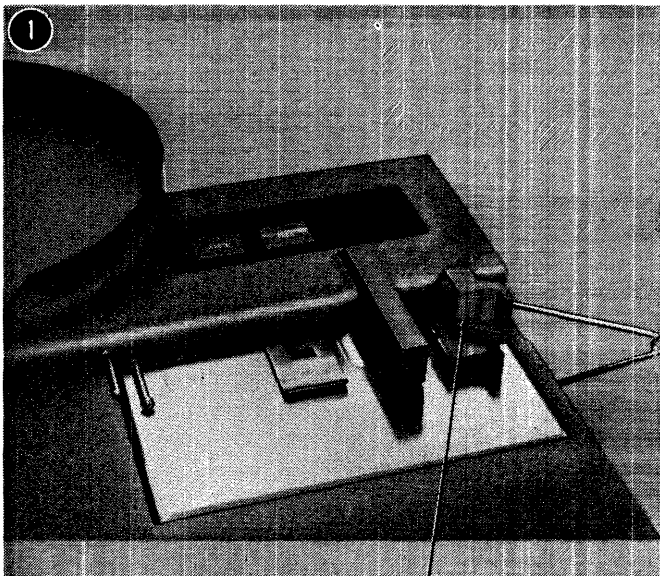

Tape
Pressure
Lever

19126

1. Lift the tape pressure lever up -- clockwise 90 degrees. If a document pressure lever (a special feature) is on the punch, lift the lever up -- counterclockwise 90 degrees. (The system power should be on.)

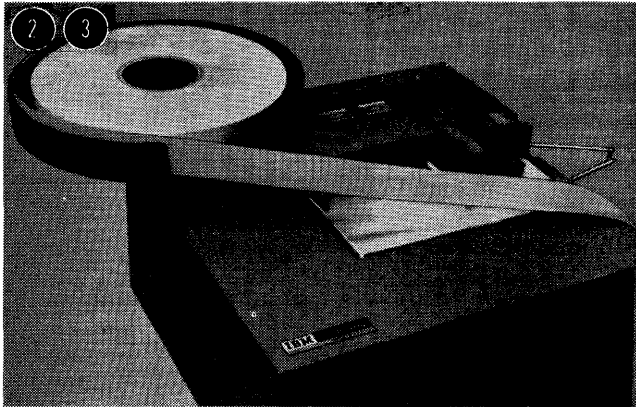

19127

2. Place a reel of blank tape on the tape supply reel. The tape supply reel should turn counterclockwise when the tape is pulled.
3. Pull the tape until about 30 inches extends beyond the tape supply pan.

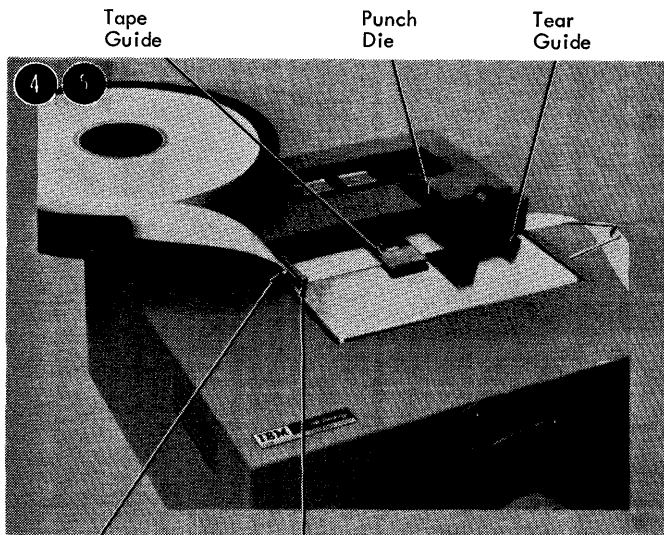

19128

4. Thread the leading edge of the blank tape (A) over the guide pin and (B) under the tape tension lever. The outside surface of the tape on the tape supply pan should be face up under the tape tension lever.
5. Slide the blank tape under (A) the tape guide (or, if applicable, under the document pressure lever), (B) the punch die (C), and the tear guide. If the punch has a take-up reel (a special feature) continue with the following steps. If the punch does not have a take-up reel, proceed to step 11.

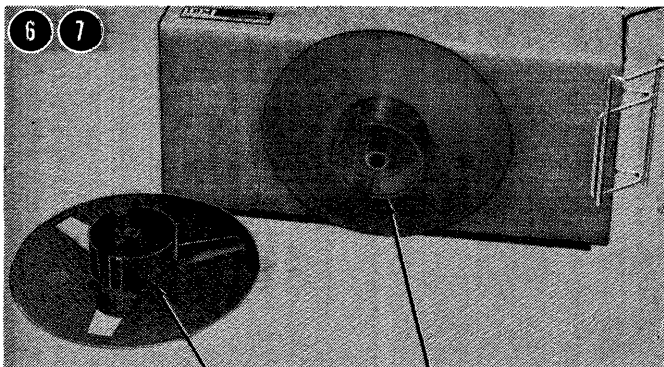

19129

6. Hold the inner cylinder of the take-up reel. Although the reel is free-running while the power is on, any slight hand pressure on the reel stops it without harming you.
7. (A) Grasp the outer reel; (B) turn it slightly counterclockwise; and (C) pull the outer cylinder of the reel toward you. When the reel separates, put the outer cylinder down and continue to hold the inner cylinder.

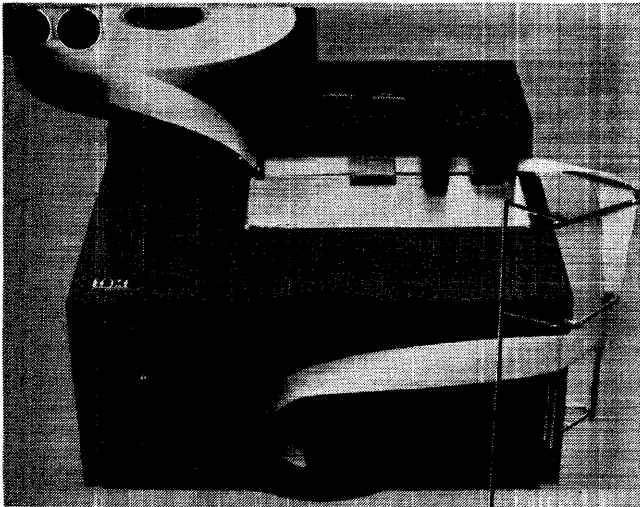

Paper Guides 19130

8. Thread the tape around the two guides on the right side of the punch.
9. Thread the tape onto the inner cylinder. (The outer surface of the tape should still be face up.)

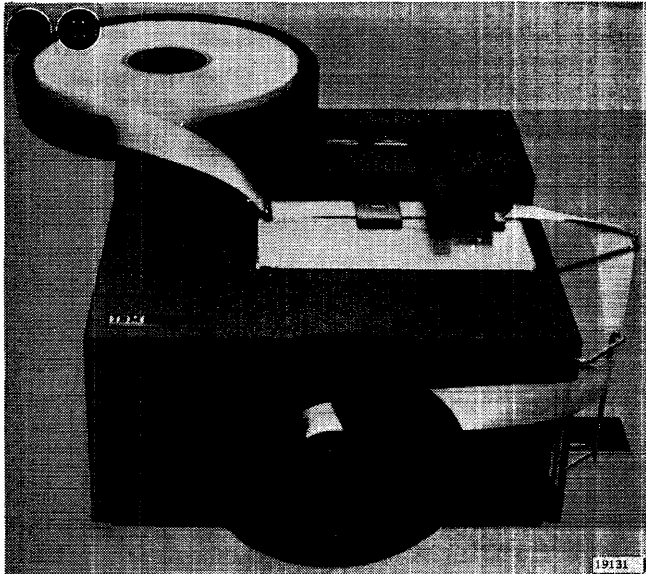

19131

10. Replace the outer cylinder, turning it slightly clockwise to lock it in place.
11. Lower the tape pressure lever back down -- counterclockwise 90 degrees. (If applicable, lower the document pressure lever.)

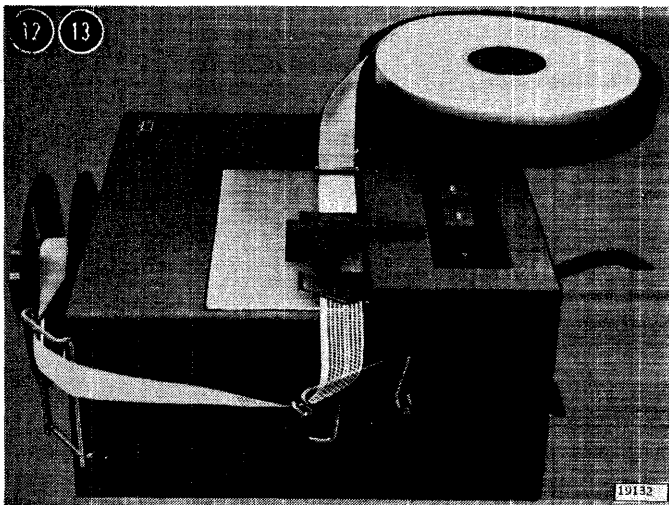

19132

12. Press and hold the feed key until 4 to 6 inches of tape has been punched. (Feed holes are punched in the tape; also, the tape is aligned so that subsequent punching will be correctly registered and so that a good splice can be made if necessary.)
13. Verify that the vertical columns of punched holes in the tape are evenly spaced. (If not, press and hold the feed key until the holes are evenly spaced.

The 1055 is now in ready status.

Emptying the Chad Box

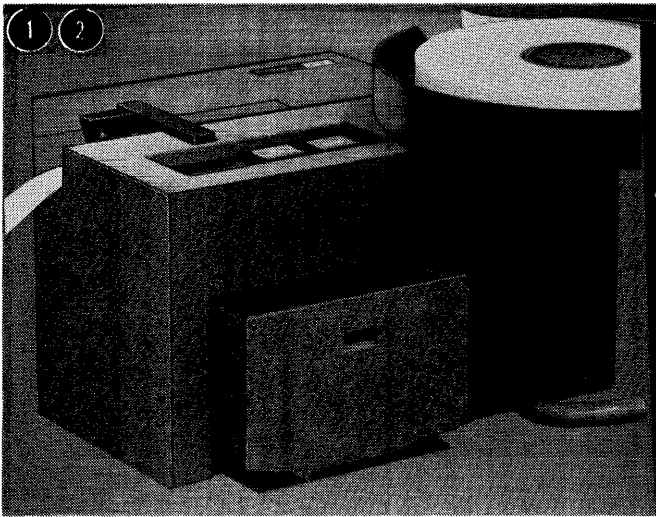

1. Turn the 1055 so that the rear is easily accessible.
2. Pull the chad box outward and empty it.

Checking Not-Ready Conditions

When IBM-supplied programming systems are used to operate the 1055, 3000 (hexadecimal) will appear in the accumulator indicator on the 1131 console display panel to indicate that one of the four not-ready conditions exists. To continue a program after a not-ready condition has occurred, correct the not-ready condition and press PROGRAM START on the 1131 console keyboard.

The Tape Presence Contact signals the central processing unit when the punch runs out of tape.

The Tape Tension Lever Contact signals the central processing unit if a strain is placed on the tape as it feeds from the spool.

The Tape Pressure Lever Contact signals the central processing unit if the lever is not down or does not hold the tape against the feed wheel.

The Document Pressure Lever Contact signals the central processing unit if the lever is not down.

Splicing Tape

Tape splicing should be done with a commercial punched tape splicer. The outstanding features of the com-

mercial splicer are that splices can be made in punched tape without reperfoming and without loss of data.

Operator Controls

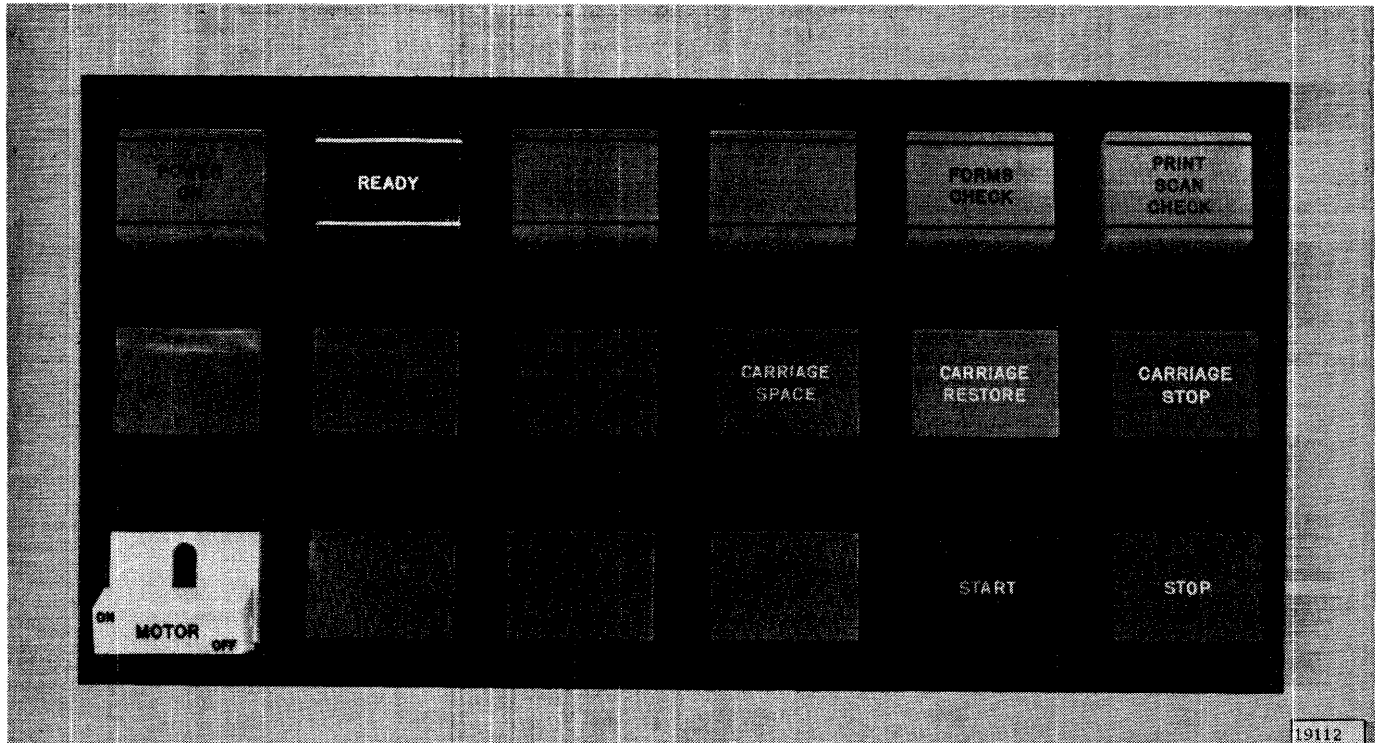

The Power On Light (frosted) glows when the 1132 receives electrical power.

The Ready Light (green) glows when the 1132 is prepared to print. Two conditions must be satisfied before this light will glow:

1. Electrical power on.
2. Start key pressed. To turn the ready light off, press STOP.

The Forms Check Light (amber) turns on when approximately 14 (vertical) inches of paper remains in the carriage or when the paper is improperly installed.

The Print Scan Check Light (amber) indicates an incomplete print scan. The print scan check light turns off automatically when the central processing unit senses the condition.

The Carriage Space Key (blue) advances the paper forms one vertical (line) space.

The carriage space key only operates when the printer is not in run status. Run status is the time that the 1132 is in its print cycle.

The Carriage Restore Key (blue) starts a carriage skip. Skipping stops automatically when the printer senses a punch in channel 1 of the carriage control tape. The paper forms and carriage control tape move synchronously when the clutch is engaged (in).

The carriage restore key operates only when the printer is not in run status.

The Carriage Stop Key (red) halts carriage operations and turns the ready light off.

The Motor On/Off Switch (white), when pushed upward to ON, starts the print wheel drive motor. This

switch should be set to OFF when changing the ribbon or when the printer is not in use.

The Start Key (green) puts the 1132 in ready status and turns on the ready light if electrical power is on.

The Stop Key (red) terminates the ready status of the 1132 printer.

Other Unmarked Lights and Keys are not used.

Manual Controls

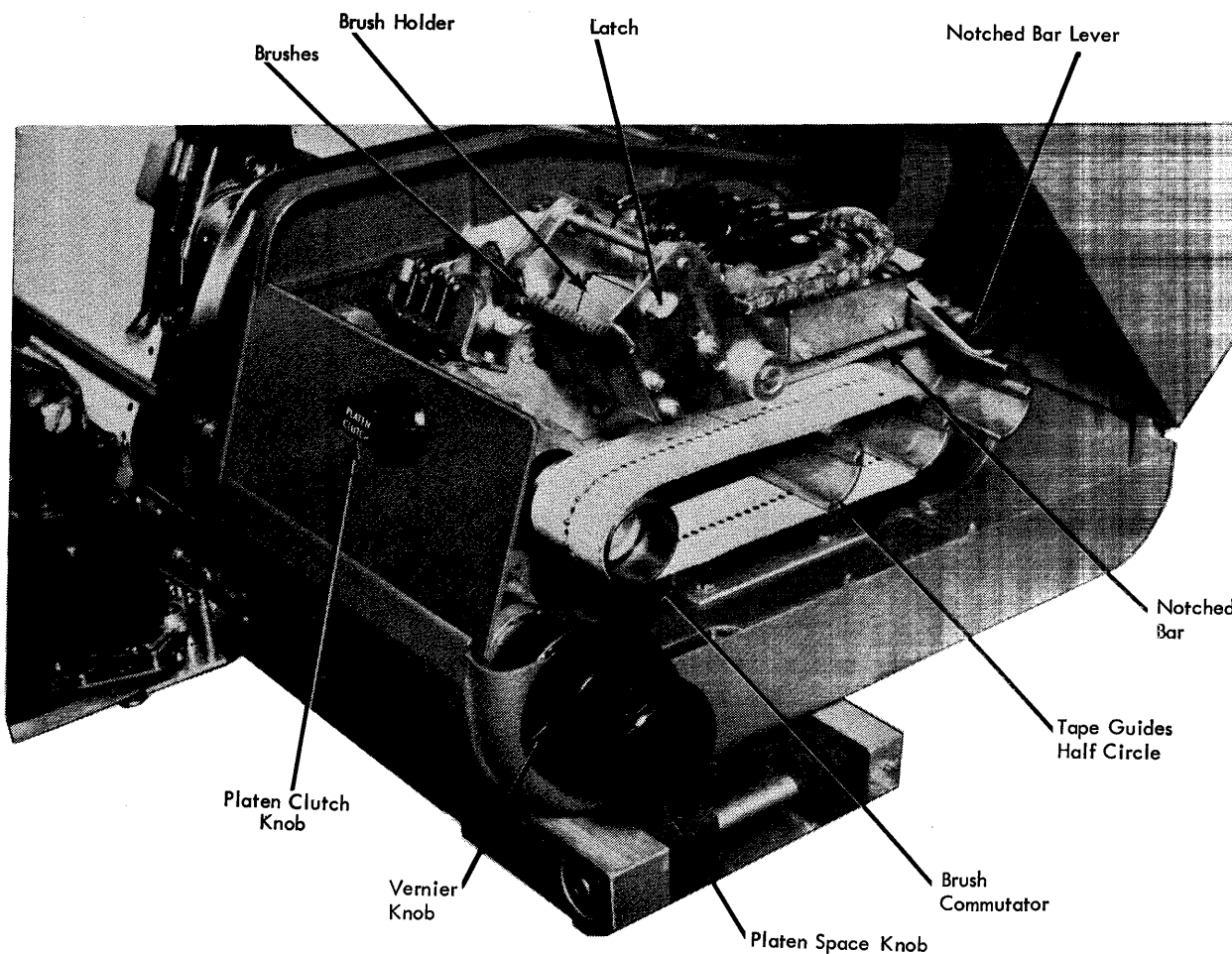

23074A

The Platen Clutch Knob disconnects the platen from the drive mechanism so that the platen may be positioned independently of the carriage tape mechanism. This knob has two settings: IN and OUT.

The Vernier Knob moves the form vertically less than one line space. When the knob is turned clockwise, the printing is placed higher on the form.

When the knob is turned counterclockwise, the printing is placed lower on the form. In either case, the carriage tape is not affected, and adjustments can be made while the platen is engaged (IN) and while the machine is in operation.

The Platen Space Knob moves the form vertically line by line. The platen clutch must be on OUT.

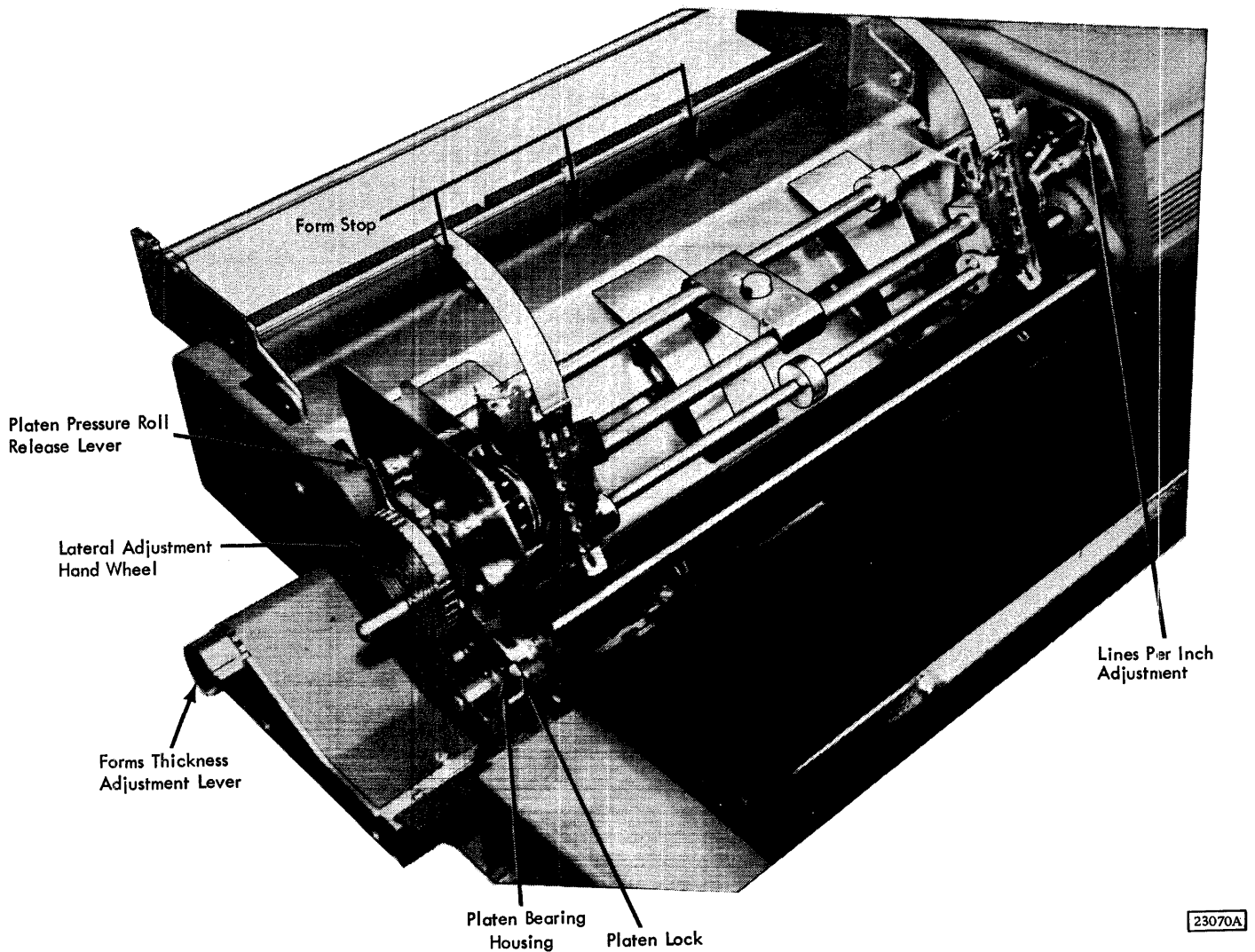

The Forms Thickness Adjustment Lever moves the entire carriage and platen away from its normal position in relation to the printwheels. This movement provides additional clearance between the platen and the printwheels when forms of increased thickness are used.

The Platen Pressure Roll Release Lever releases the pressure holding a form in the platen when inserting

new forms or when repositioning a form. The pressure release lever should always be in the released position (back) when the forms tractor is being used.

The Lateral Adjustment Handwheel moves the carriage horizontally.

The Lines Per Inch Adjustment regulates the 1132 for six- or eight-lines-per-inch vertical spacing.

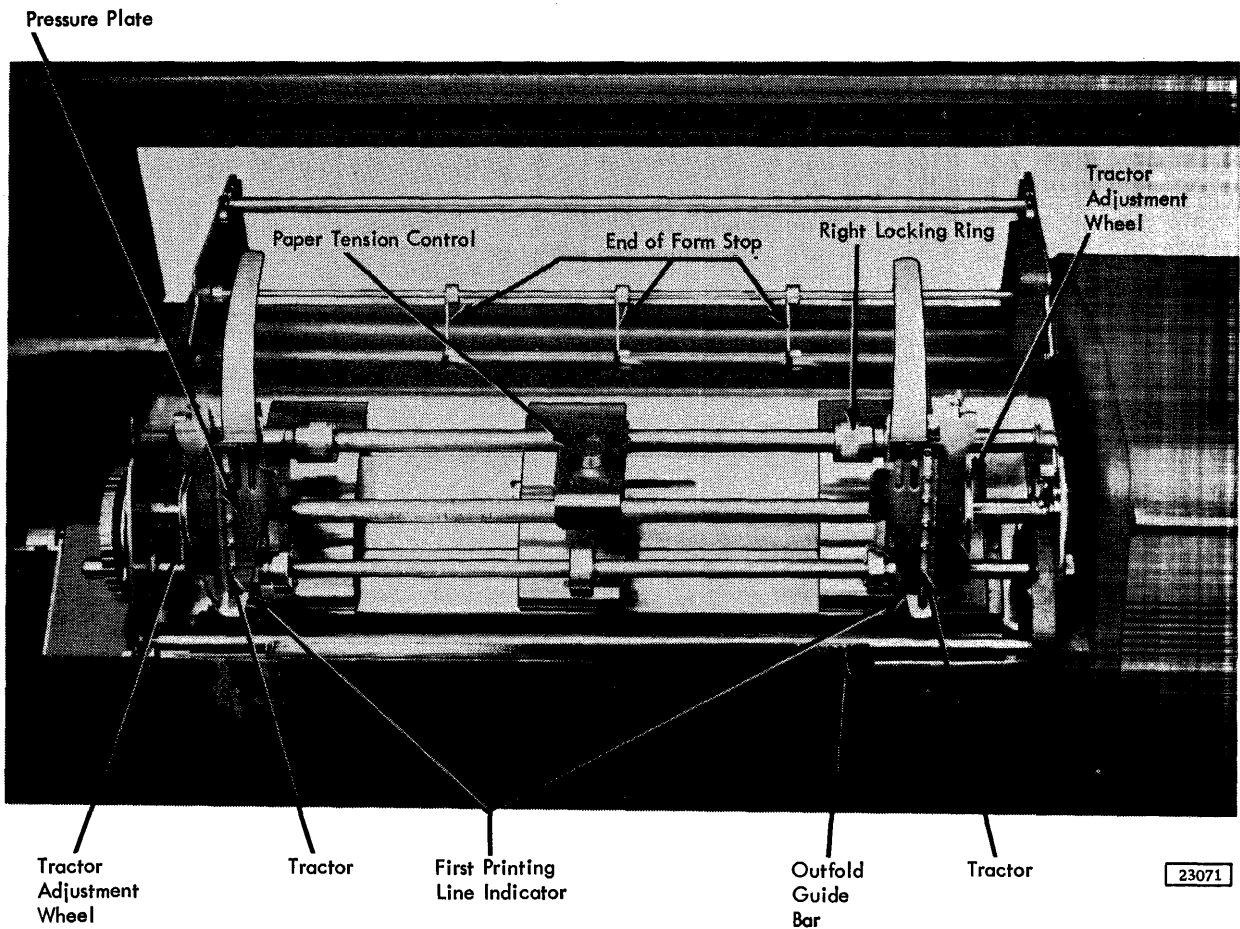

Inserting a Carriage Control Tape

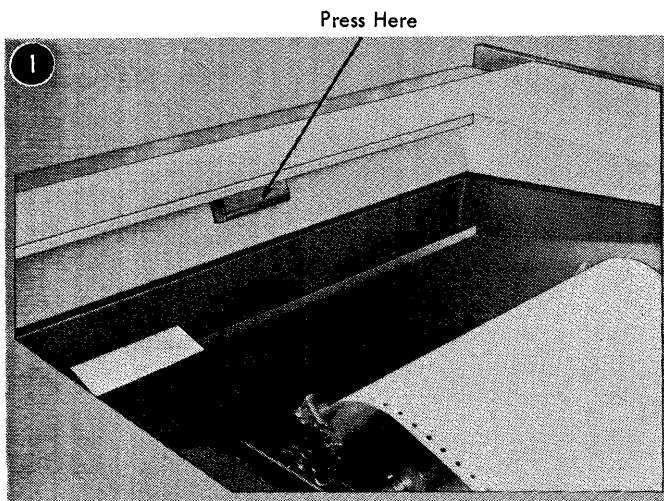

1. Raise the printer cover.

Note: See "Appendix A. Carriage Control Tape."

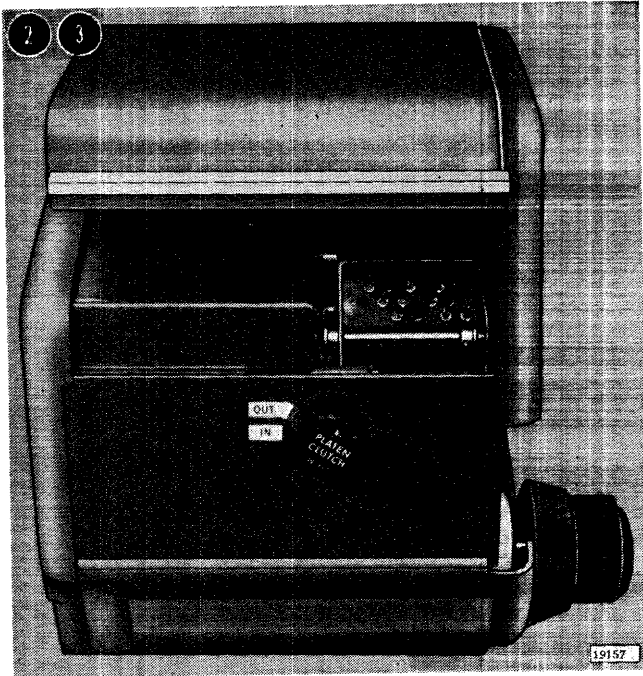

2. Turn the platen clutch knob to OUT.
3. Raise the carriage cover.

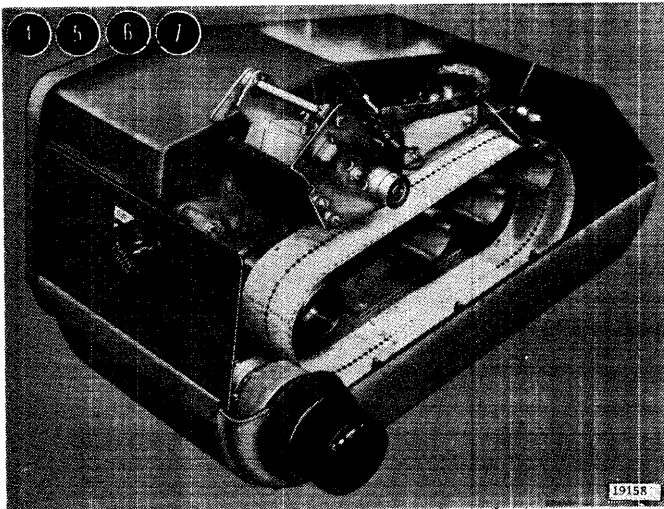

4. Raise the brush holder (by pulling the brush holder latch forward).
5. Hold the tape so that the printed captions are readable (channel 1 on the left).
6. Loop one end of the tape over the pin feed drive wheel so that the pins engage the center drive holes.
7. Place the opposite end of the tape over the nearest half-circle guide.

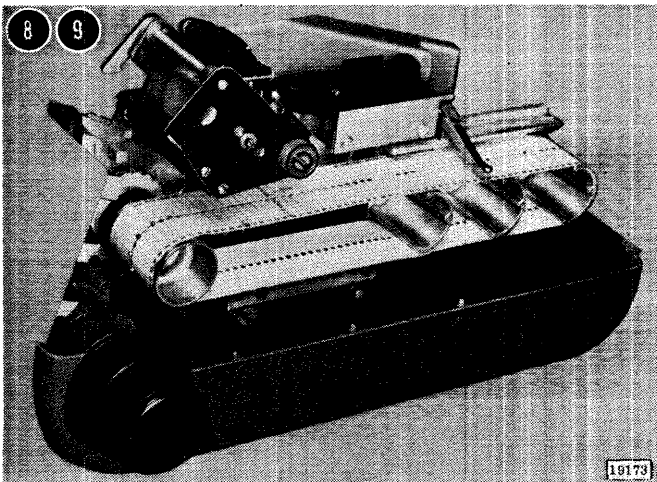

8. Remove the excess slack from the tape by lifting the notched bar lever, moving it toward the rear of the carriage. When the top and bottom portions of the loop are pressed together, the tape should give slightly. Do not fit the tape too tightly or the pin feed holes will be damaged.
9. Lower the brush holder until it locks.

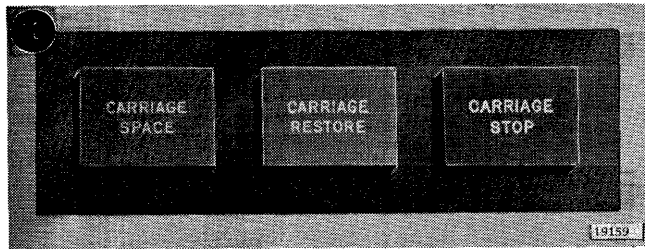

10. Press the carriage restore key to bring the tape to its home position.

Note: Use the vernier knob and the first printing line indicators to align the forms.

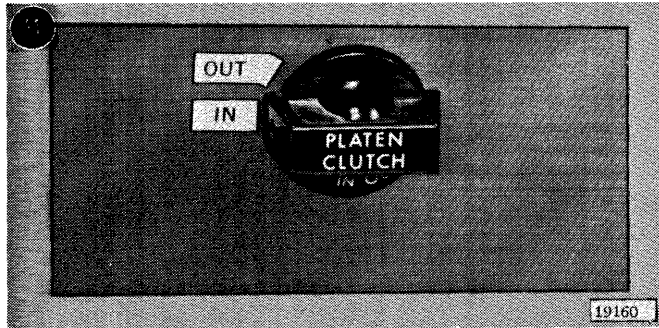

11. Turn the platen clutch knob to IN.
The carriage is now ready to operate.

Installing Forms Tractor

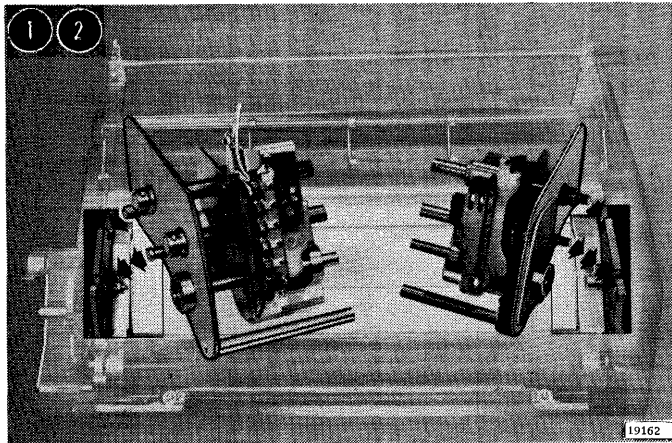

1. Position the paper guides (on the bed of the carriage) to the left and right sides of the carriage.
2. Hook the rear pins of the tractor in position.

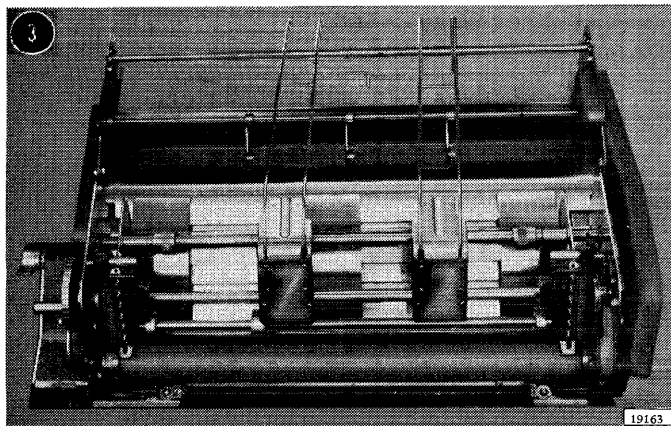

3. Lower the front of the tractor.

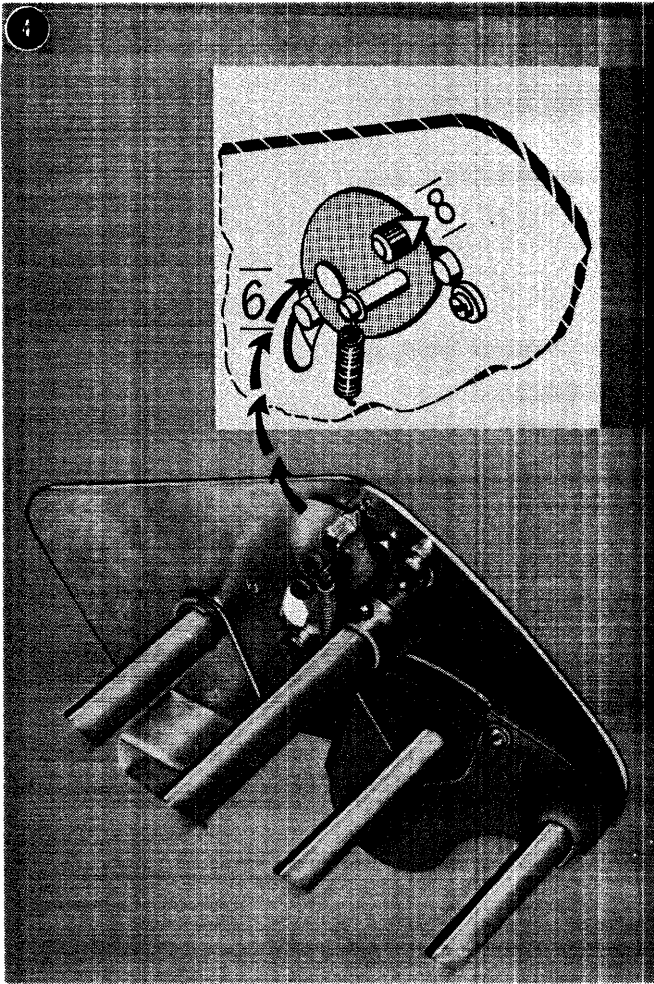

19164

4. Move the shift cam pointer to the desired setting (six or eight lines per inch). Six lines per inch is the normal setting.

If the printer is immovable between the lines, a tooth-on-tooth condition exists between the platen gear and the forms tractor drive gear. In this case, move the shift cam to release the pressure on the drive gear and turn the platen slightly (platen clutch out) to allow the teeth to engage fully.

Inserting Forms

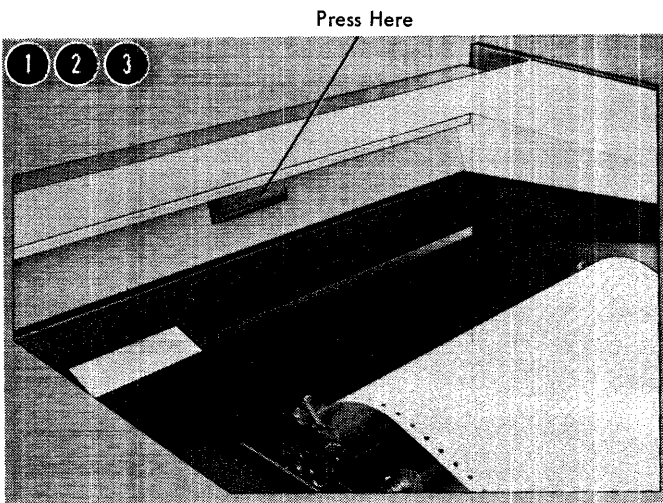

19201

1. Raise the top cover.
2. Turn the platen clutch to OUT.
3. Turn the platen space knob to make sure that the platen and the forms tractor move freely.

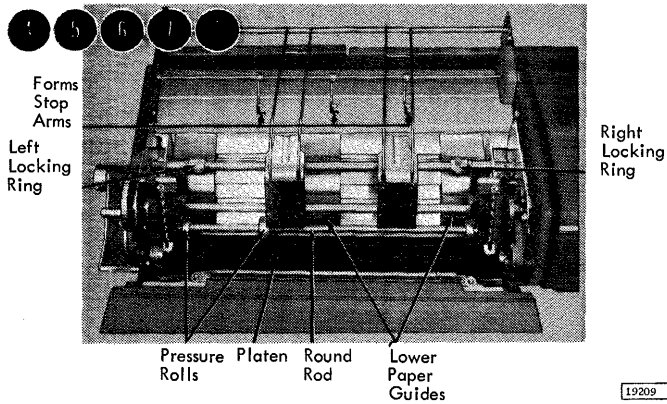

4. Loosen the left and right locking rings.
5. Move the lower paper guide to the left of the first printing position.
6. Tighten the left locking ring.
7. Pass the forms under the forms stop arms, over the lower paper guides, under the round rod, and then into the pressure rolls and platens.
8. Position the right paper guide. Allow a slight clearance so the forms slide freely between both guides. (The paper tension control is adjustable and exerts a slight pressure on the paper as it feeds through the forms tractor.)

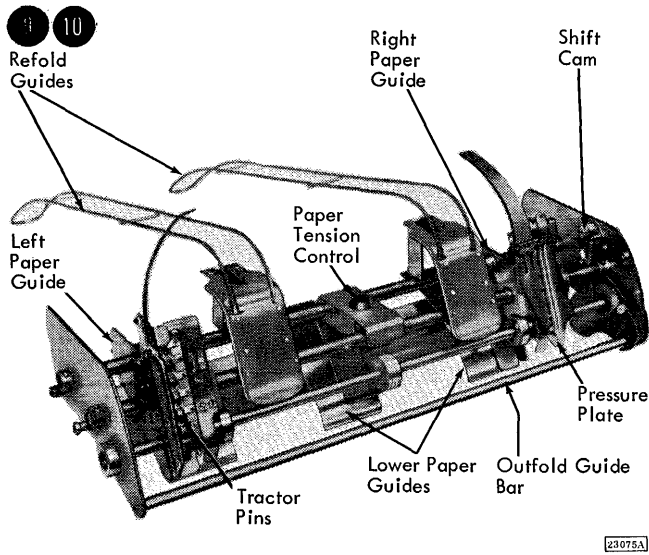

9. Remove the spring-loaded outfold guide bar.
10. Pull the platen pressure roll release lever forward and turn the platen space knob until the end of the form can be grasped.

Platen Pressure Roll Release Lever Left Hinged Pressure Plate

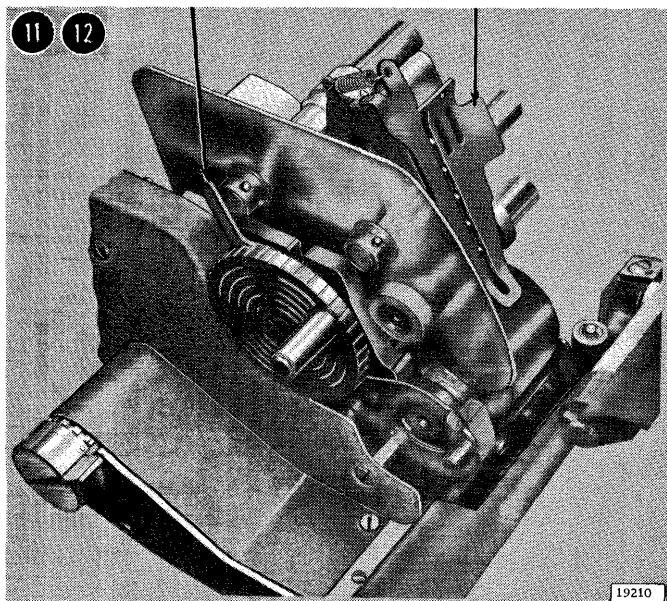

11. Move the right and left hinged pressure plates away from the tractor pins.
12. Operate the platen pressure roll release lever to free the form.

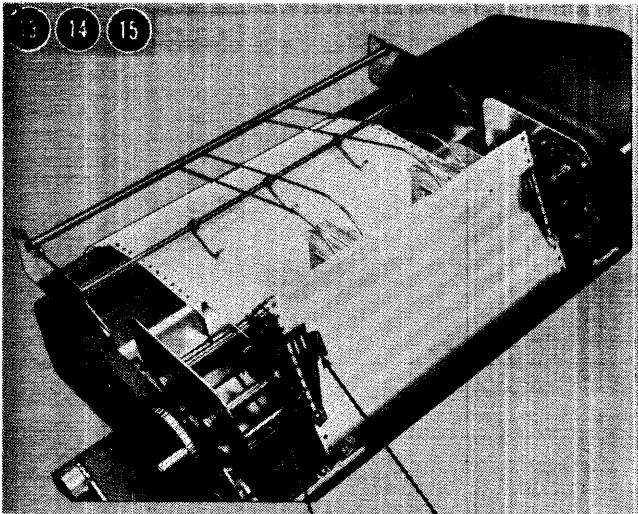

Feed Pins Pen Feed Pressure Plate 19211

13. Put the pinfeed holes of the form over the feed pins while holding the edge of the form.
14. Return the pin feed pressure plates to their lower position.
15. Replace the outfold guide bar. The outfold guide bar aids the feeding of forms.

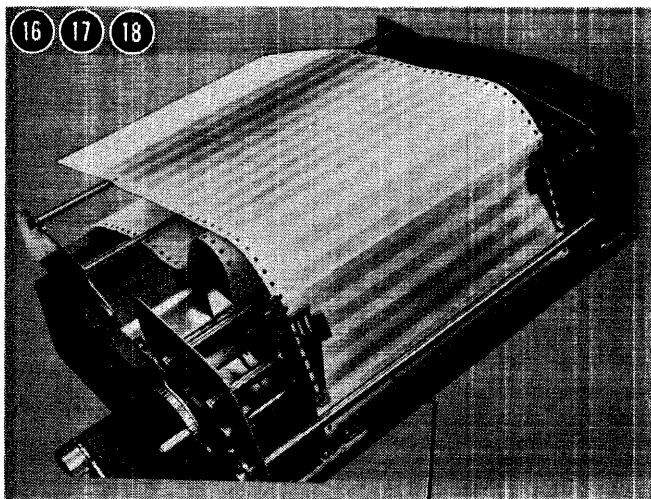

Outfold Guide Bar 19212

16. Using the platen space knob, set the form so that the first printing line of the form is even with the first printing line indicator mark on the lower part of the pin feed pressure plates.
17. Turn the form back 14 spaces if spacing is set for six lines per inch, or 19 spaces if set for eight lines per inch. Finer adjustments are made by using the vernier knob.
18. Restore the carriage (by pressing the carriage restore key) and turn the platen clutch to IN after inserting the control tape.

Replacing a Ribbon

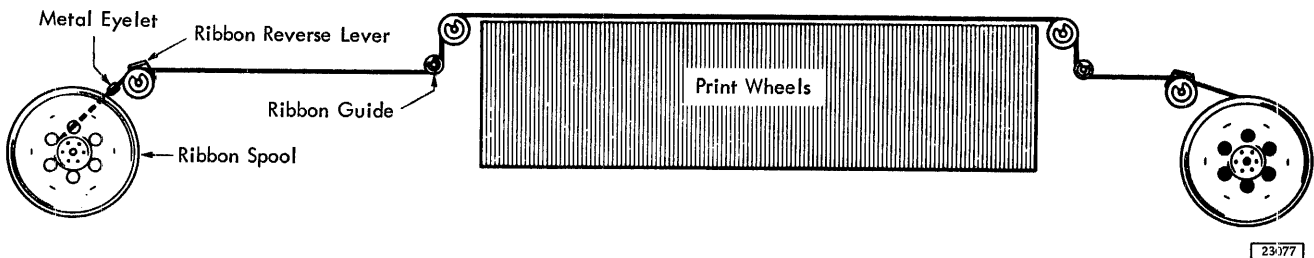

1. Turn motor on/off switch to OFF.
2. Wind ribbon onto one spool.
3. Remove both spools from the printer.
4. Keep empty spool and discard the full one.
5. Hook end of ribbon onto empty spool.
6. Replace ribbon as indicated in the ribbon-feed schematic.

Operator Controls

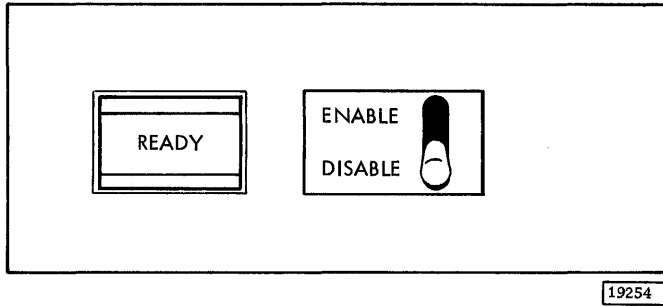

The Ready Light turns on when the 1133 is in the ready status.

The Enable/Disable Switch, when on ENABLE, starts the usage meter if both the 1133 is ready and the central processing unit is running. When the switch is on DISABLE, the usage meter stops. To change the position of the switch, the central processing unit must not be in a run condition.

Inserting Tape

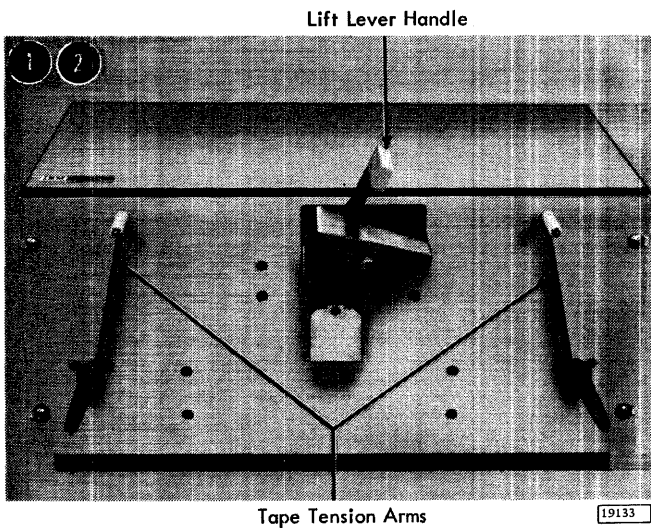

1. Put both tape tension arms up.
2. Raise the lift lever handle. As a result, the read head rises so that the capstan is clear.

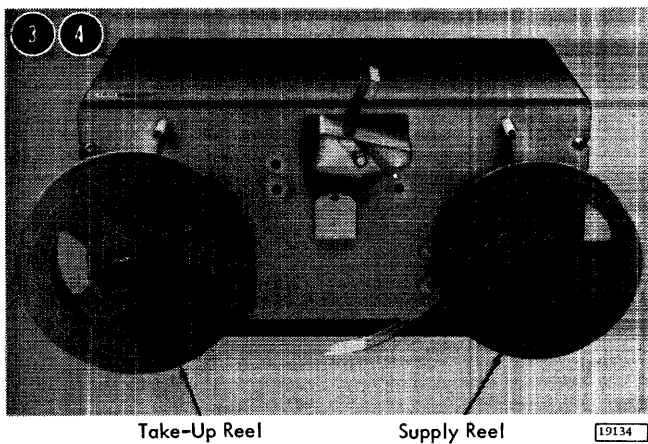

3. Put the supply reel (the reel containing the punched tape) on the right drive shaft and the take-up reel on the left drive shaft.
4. Lock the reels.

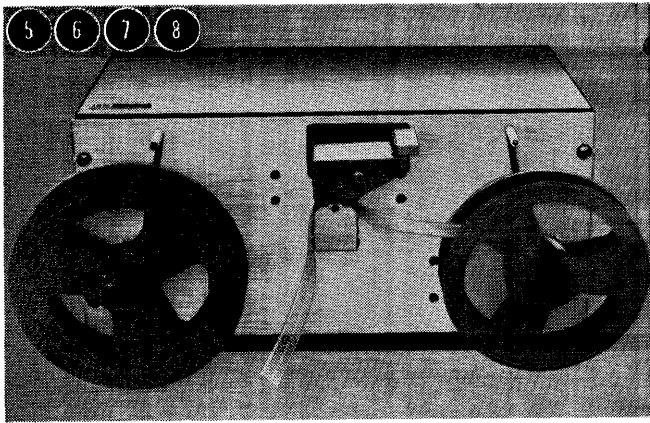

19135

5. Lay the tape across the read capstan so that the pins project through the sprocket holes and so that the lower three holes (excluding the feed holes) are on the near side.
6. Position the tape so that a delete code (seven punched channels) beyond the program identification punched in the leader is under the read starwheels.

When positioning a tape without a leader (or when starting in the middle of a tape), position the tape so that the first character position to be read is one position to the right of the read starwheels.

7. Hold the tape in position on the read capstan.
8. Push the lift lever handle down until it locks. The read starwheels now come in contact with the tape.

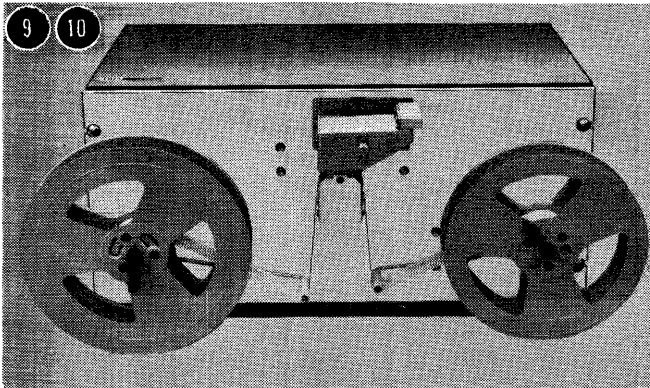

19136

9. Fasten and wind the tape leader to the take-up reel on the left drive shaft.
10. Let down the tape tension arms. Ascertain that the tape is beneath both tape tension arms.

The tape is now threaded, and the paper tape reader is ready for use.

Rewinding Tape

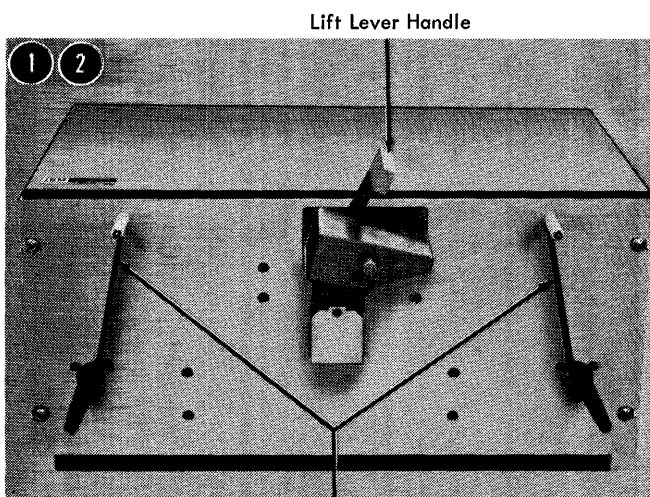

Tape Tension Arms

19133

1. Put both tape tension arms up.
2. Raise the lift lever handle counterclockwise approximately 75 degrees.

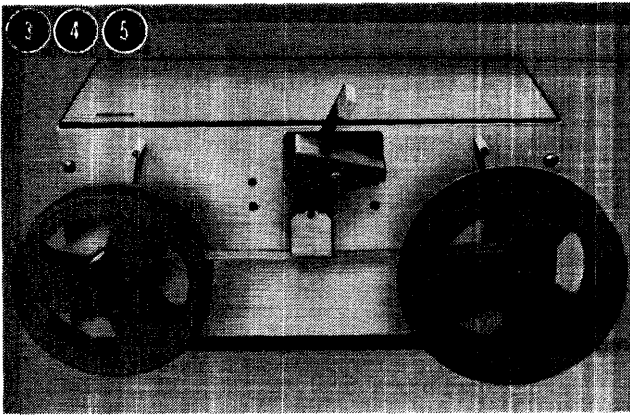

19137

3. Place the loaded reel on the left drive shaft.
4. Thread the loose edge of the tape to the take-up reel on the right drive shaft.

Both reels can be either the take-up reel or the supply reel. When the reels rotate counterclockwise, the reel on the left is the take-up reel, and the reel on the right is the supply reel. Contrarily, when the reels rotate clockwise, the reel on the right is the take-up reel, and the reel on the left is the supply reel.

5. Ascertain that the tape is beneath both tape tension arms and is removed from the read capstan.

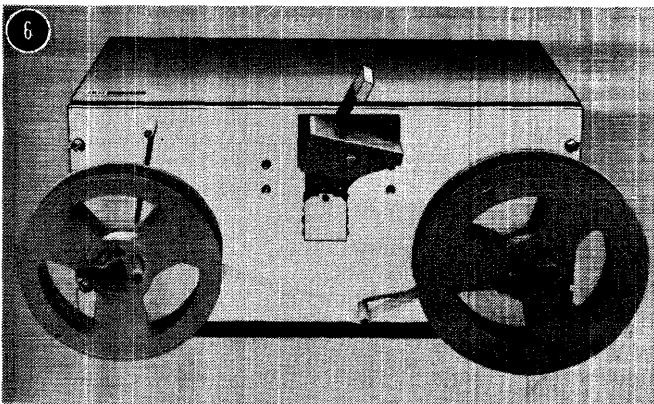

19136

6. Lower the right tape tension arm.

When an arm on either side is lowered, the reel on that particular side will turn. The reel on the left turns counterclockwise when the left tape tension arm is lowered, and the reel on the right turns clockwise when the right tape tension arm is lowered.

To stop the rewinding process, lift the right tape tension arm.

Checking a Not-Ready Condition

When IBM-supplied programming systems are used to operate the 1134, /3000 (hexadecimal) will appear in the accumulator indicator on the 1131 console display panel to indicate that a not-ready condition

exists. If a not-ready condition should exist, close the lift lever handle tightly, then press PROGRAM START on the 1131 console keyboard to continue program operation.

Operator Controls

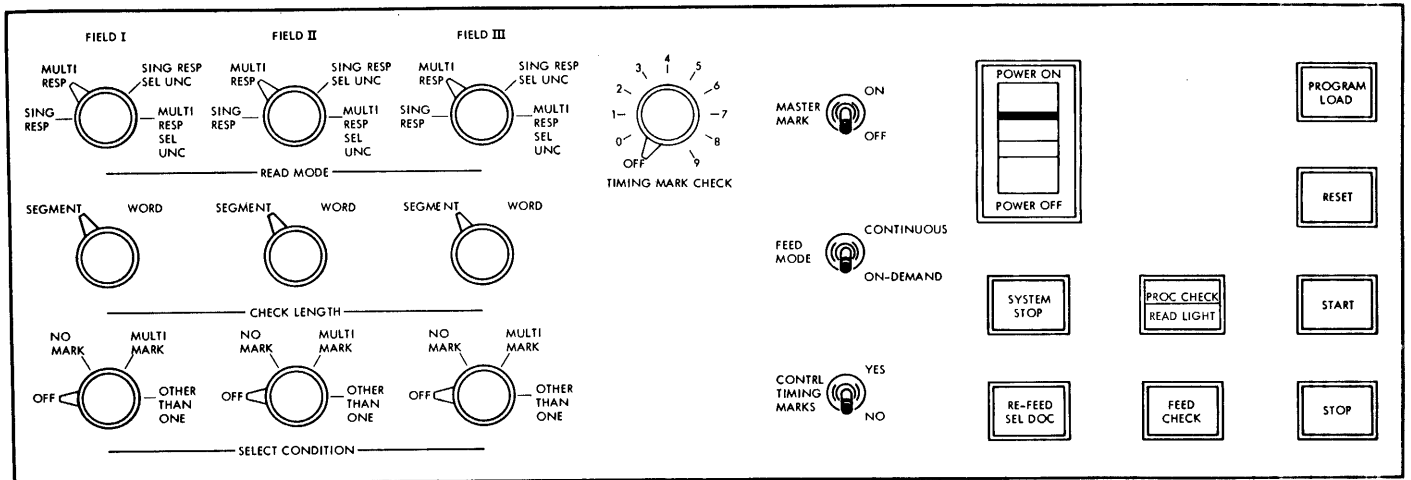

The Three Read Mode Switches, each associated with a set of field checking switches, determine the conditions of mark discrimination. Each read mode switch has four settings: SING RESP (single response), MULTI RESP (multiple response), SING RESP SEL UNC (single response select uncertainties), MULTI RESP SEL UNC (multiple response select uncertainties).

The Three Check Length Switches have two settings: SEGMENT and WORD. The setting defines the length of the item as it will be checked for each field. The segment setting will check the five positions of a segment; the word setting will check all ten positions of a word.

The Three Select Condition Switches have four settings: OFF, NO MARK, MULTI MARK, and OTHER THAN ONE. Each switch is associated with a check length switch and one of three fields. The settings represent the conditions in a given field under which a document will be directed to the select stacker.

The Timing Mark Check Switch is an 11-position rotary switch with settings numbered 0 through 9 and OFF. The switch is preset by the operator to match the units position count of timing marks on the data sheets to be processed. For example, if there were

106 timing marks on a document to be processed, the switch would be set at 6.

The Master Mark, a special feature, controls the capability of the 1231 to recognize a master mark on the right edge of the data sheet. When this switch is on, the recognition of a master mark causes a bit to be placed in the device status word for the 1231. By program analysis, this data can be placed in a separate data table in the central processing unit storage.

The Feed Mode Switch has two settings: ON-DEMAND and CONTINUOUS. When the switch is set to ON-DEMAND (the only setting used with the 1130 system), feeding is controlled from the system program. The next document will not feed until the contents of the delay line (from the previous document) are transferred to the computer.

The Control Timing Marks Switch enables the 1231 to eliminate the 75-millisecond delay associated with the timing-mark-checking feature. The switch has two settings: YES and NO. YES is used when the documents to be processed have the six extra control timing marks needed for the 1230 systems. NO is used when 100 or fewer control timing marks are on the document. The 75-millisecond delay can be ignored by programming when operating in this mode.

The Power On/Power Off Light turns on when the 1231 receives electrical power.

The System Stop Light turns on whenever the 1130 system stops.

Re-Feed SEL DOC (Refeed Selected Document) Light comes on when (1) a multi-mark is detected during the reading of the master-mark document, (2) when an uncertainty is detected during the reading of the program control sheet, and (3) when an uncertainty, without an accompanying dark mark, is detected during the reading of the master-mark sheet.

The PROC (Process) Check Light turns on to indicate one or more of the following conditions:

1. A parity error in storage logic.
2. The count of data sheet timing marks is not in agreement with the setting of the timing-mark switch.
3. Failure of processing unit to take data from the B register before the A register loaded new data into the B register.
4. A logic or delay line failure when (A) no control bits are loaded into the master line during the reading of a program control sheet, or (B) no data bits are loaded during the reading of a data sheet.

5. The number of timing marks on the detail data sheet does not equal at least the number of words programmed to be read by the program control sheet.

The Read Light turns on when a read head lamp burns out or is weak.

The Feed Check Light indicates a sheet jam, a mis-feed, a double-sheet feed, a full stacker, or an empty hopper. These conditions cause the 1231 to stop. Correct the condition and press RESET to turn the light off.

The Program Load Light turns on during the program load cycle. It clears the machine of previously stored data.

The Reset Key raises the hopper to the feed position and resets the electronic circuitry. Error conditions should be corrected before pressing the reset key.

The Start Key feeds the top sheet in the hopper if the program load key has been pressed. The start key places the 1231 in ready status. Document feeding from this point is controlled by the central processing unit.

The Stop Key halts document feeding and lowers the hopper plate.

Readying the 1231

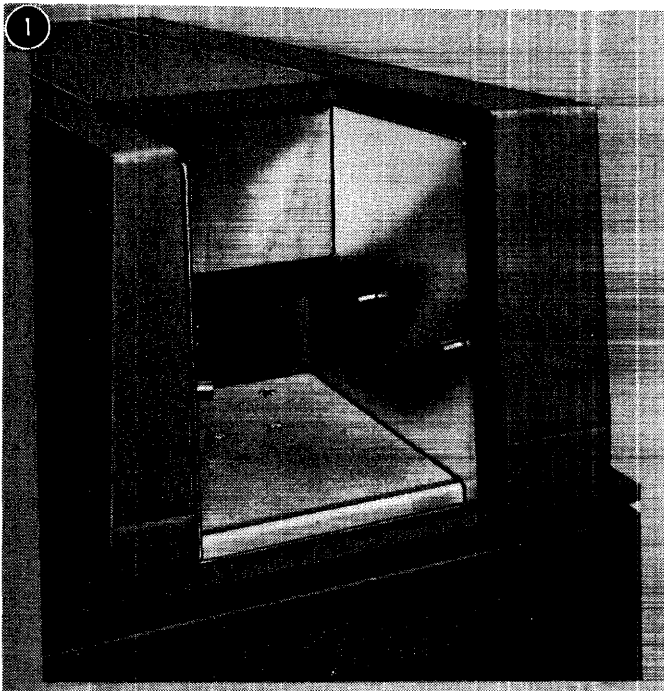

27103A

1. Place the data sheets in the hopper with the side to be read facing up and the top edge positioned to feed first.

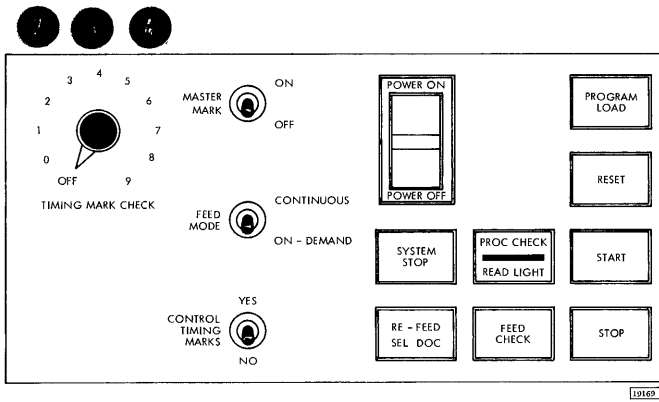

2. Set the feed mode switch to ON DEMAND.
3. Press PROGRAM LOAD to clear the delay line and condition the 1231 for program loading.
4. Press RESET to raise the hopper to the ready position. The reset light turns off and the start light turns on.

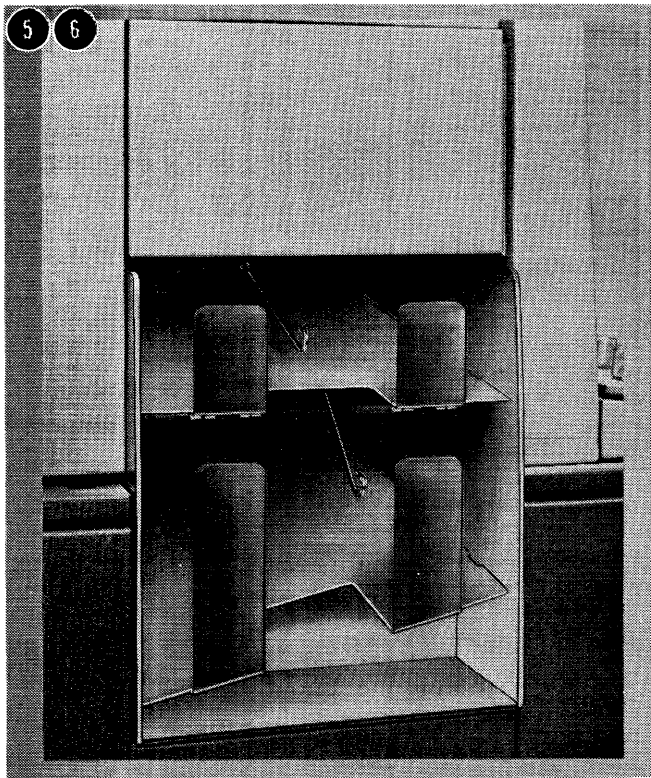

5. Press START. The first data sheet in the hopper is fed through the 1231, loading the delay line. The first data sheet is now in the stacker. The program load light turns off.
6. Press START to turn the start light off. When all lights are off on the 1231 operator's console (the system stop light may be on), the 1231 is in ready status.

Note: For more details on the 1231, refer to the IBM 1130 Functional Characteristics, Form A26-5881.

Operator Controls

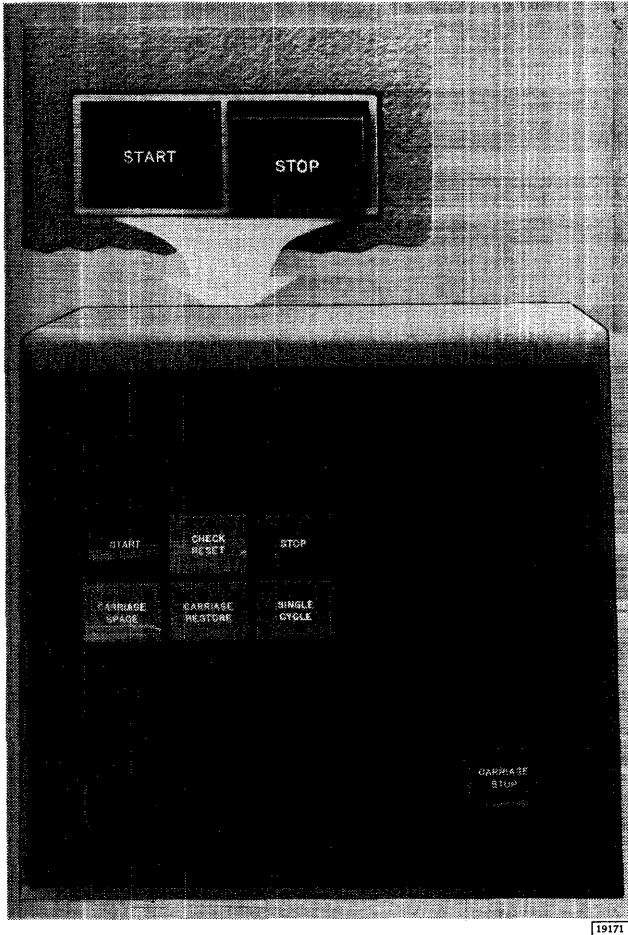

The Start Key (green) puts the printer in ready status and turns on the ready light if the electrical power is on and if the paper forms are in proper position. A duplicate start key is on the rear of the printer for convenience.

The Check Reset Key (blue) turns off lights indicating printer errors. Press the start key to restart system operation.

The Stop Key (red) terminates the ready status of the 1403. A duplicate stop key is on the rear of the printer for convenience.

The Carriage Space Key (blue) advances the paper form one vertical (line) space if the clutch is engaged.

This key is operative only when the printer is in not-ready status.

The Carriage Restore Key (blue) starts a carriage skip. Skipping stops automatically when the printer senses a punch in channel 1 of the carriage control tape. The paper forms and carriage control tape move synchronously when the clutch is engaged.

This key is operative only when the printer is in not-ready status.

The Print Ready Light turns on when the 1403 is prepared to print.

The Print Check Light indicates a parity error or an address error. A parity error occurs when the number of 1's in an array of binary digits is even. The print check light turns on when the 1403 buffer storage is addressed incorrectly (ring check).

The print check light may be reset by the program or by pressing the reset key. Press the start key to restart the system.

The End-of-Forms Light indicates last form. If an end-of-forms condition occurs during spacing within the last form in the printer, the printer operation continues automatically until the next skip to a new form occurs. When the last form is out, follow the procedures for inserting a new form and for determining the first print line.

The Forms Check Light indicates form-feed trouble in the forms tractor. The forms check light turns off when the trouble is corrected.

The SYNC Check Light turns on when the print chain is not in synchronization with the compare counter. If the check reset key is pressed, timing is automatically corrected and the light is turned off.

A synchronization check may result if the forms cart (located on the rear of the 1403) is not in contact with the grounding straps attached to the base of the machine.

The Carriage Stop Key (red) stops the carriage operation and turns on the forms check light. The forms may need to be realigned with the program, and the check reset key must be pressed to turn off the forms check light.

Manual Controls

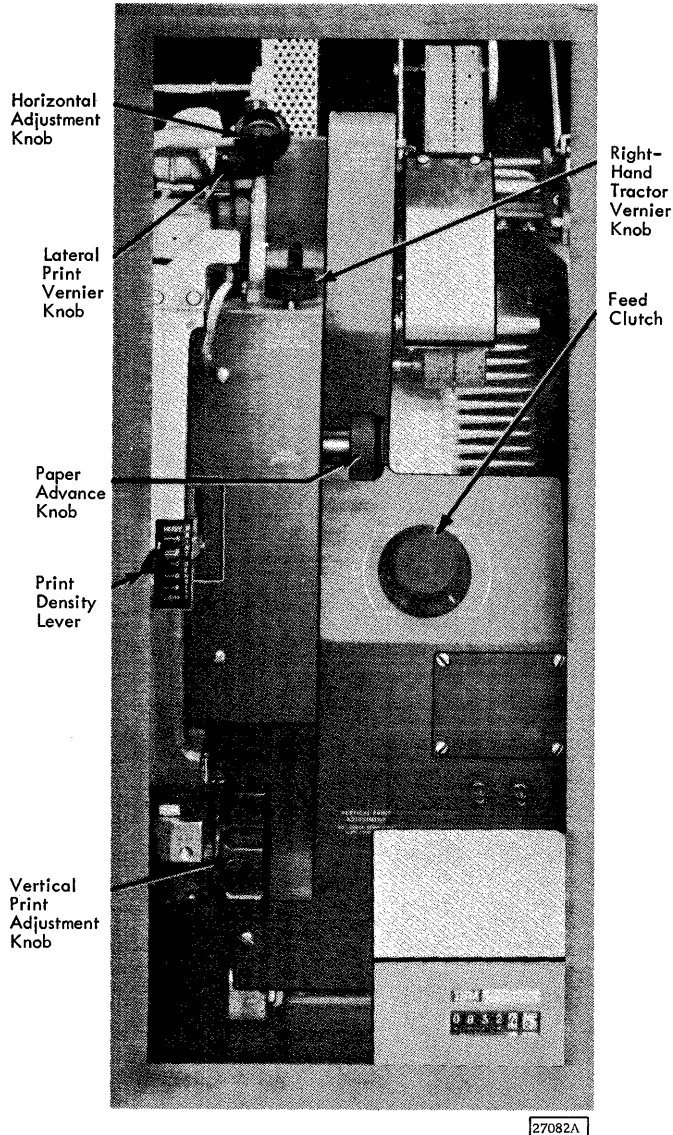

The Horizontal Adjustment Knob moves the printing mechanism horizontally (within a 2.4-inch travel limit). When the lever is raised, the print mechanism unlocks.

The Lateral Print Vernier Knob controls fine horizontal adjustments of the print mechanism. This knob is used with the horizontal adjustment.

The Right-Hand Tractor Vernier Knob controls fine paper tension adjustments (up to one-half inch).

The Paper Advance Knob positions the form vertically (when the feed clutch is disengaged).

The Print Density Lever controls print impression. Density controls are from A to E. When the lever is on A, the print impression is dark; on E, the print impression is light. Position C is the normal setting. To accommodate thick forms, the print density lever can move the type chain away from (or close to) the hammer unit.

The Feed Clutch controls the carriage-tape drive and form-feeding mechanism and selects six- or eight-lines-per-inch spacing. When the clutch is on NEUTRAL, automatic form feed cannot take place.

The Vertical Print Adjustment Knob controls fine vertical spacing. Adjusting this knob does not affect the carriage tape.

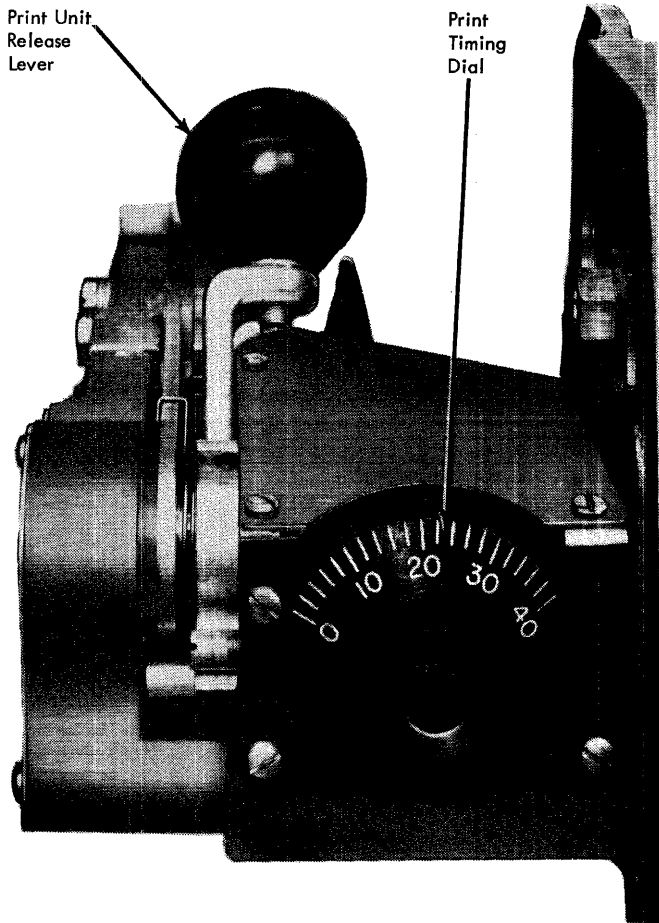

27083

The Print Unit Release Lever permits access to the form transport area.

The Print Timing Dial makes fine print-quality adjustments. The print timing dial chart, located on the ribbon cover, gives the proper setting for the timing dial.

		Form Thickness							
		0.003	0.006	0.009	0.012	0.015	0.018	0.021	0.024
Print Density	A	21	18	15	12	9	6	3	0
	B	25	22	19	16	13	10	7	4
	C	29	26	23	20	17	14	11	8
	D	33	30	27	24	21	18	15	12
	E	37	34	31	28	25	22	19	16

19193

For finer setting of the timing dial, turn the print timing dial clockwise until the left side of the printing seems cut off. Then rotate the dial counter-clockwise until the right side of the printing appears cut off. The optimum setting of the print timing dial is halfway between the two readings.

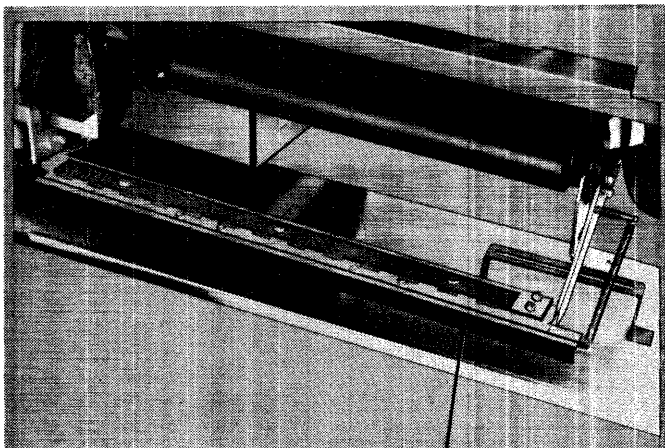

Acoustical Dampener 19194

The Acoustical Dampener is a nylon and bronze brush on the print unit frame, which drags on single-part forms to dampen the high-frequency vibration of the paper. The brush has hinges and therefore can be rotated. To prevent damage to single-part forms, rotate the brush away from the paper when the print unit is moved horizontally for alignment.

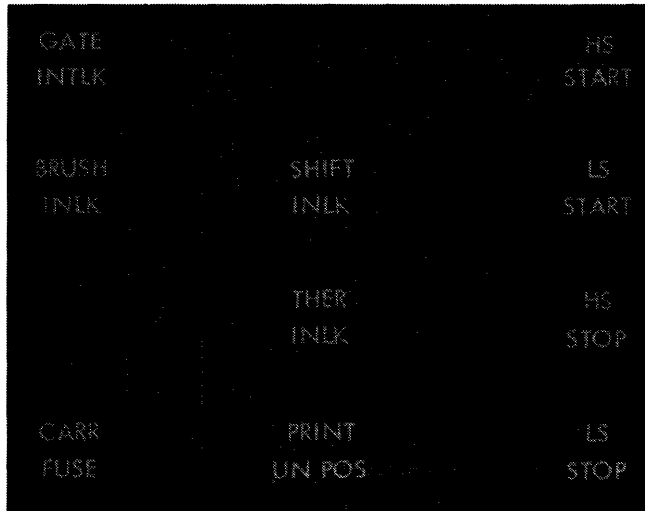

The Gate INTLK (Interlock) Light is turned on when the print unit is not locked in position.

The HS (High Speed) Start Light is not used.

The Brush INLK (Interlock) Light is on when the carriage tape brushes are not latched in position for operation.

The Shift INLK (Interlock) Light turns on to indicate that the manual feed clutch is not properly positioned.

The LS (Low Speed) Start Light turns on to indicate skip or line spacing has been initiated.

The THER (Thermal) INLK (Interlock) Light turns on to indicate that a terminal unit has caused a fuse to burn out. If it is on, the customer engineer should be notified.

The HS (High Speed) Stop Light is not used.

The CARR (Carriage) Fuse Light indicates that the carriage fuse has blown. If it is on, the customer engineer should be notified.

The Print UN (Unit) POS (Position) Light is not used.

The LS (Low Speed) Stop Light turns on to indicate that a skip stop has been initiated. It is on when the carriage is not in motion.

Inserting a Carriage Control Tape

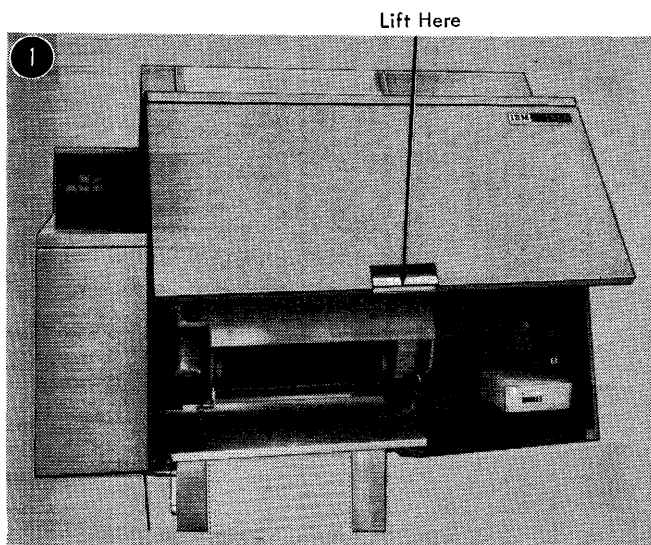

1. Raise the printer cover.

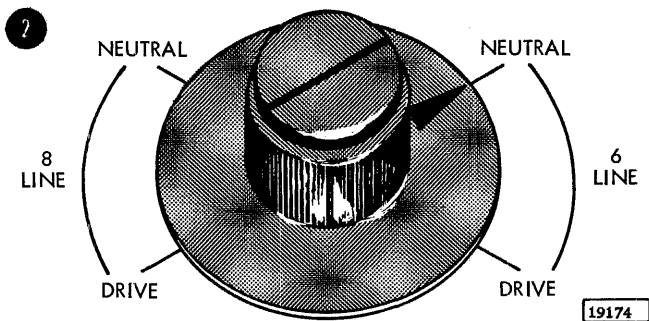

2. Turn the feed clutch to NEUTRAL.

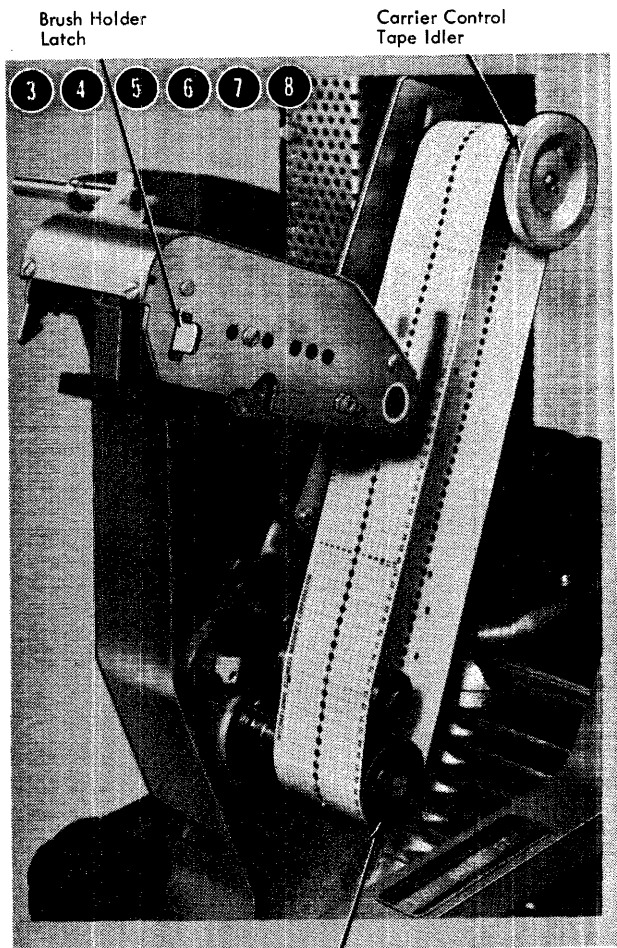

3. Raise the brush holder by pushing down on the brush holder latch.
4. Hold the tape so that the printed captions are readable (channel 1 on the left).
5. Loop one end of the tape over the pin feed drive wheel so that the pins engage the center drive holes.
6. Loop the other end of the tape around the adjustable carriage control tape idler.
7. Adjust the carriage control tape idler by loosening the locking knob and moving the idler in its track.

No noticeable slack should be in the tape, but the tape should not be under tension. Test the tape by pressing the sides of the loop together. The tape should give slightly. Do not fit the tape too tightly or the pin feed holes will be damaged. Be sure to retighten the locking knob on the idler.

8. Lower the brush holder until it locks.

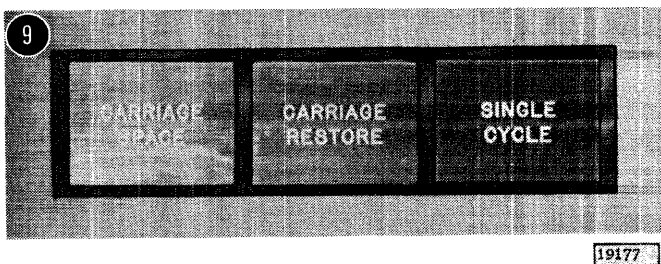

9. Press the carriage restore key to bring the tape to its home position.

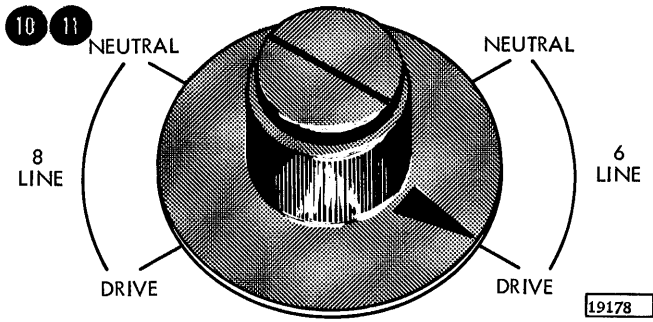

10. Set the feed clutch to DRIVE. Set it for either six or eight lines per inch, depending on the form to be printed. Six is the normal setting.
11. Close the printer cover.

Changing the Ribbon

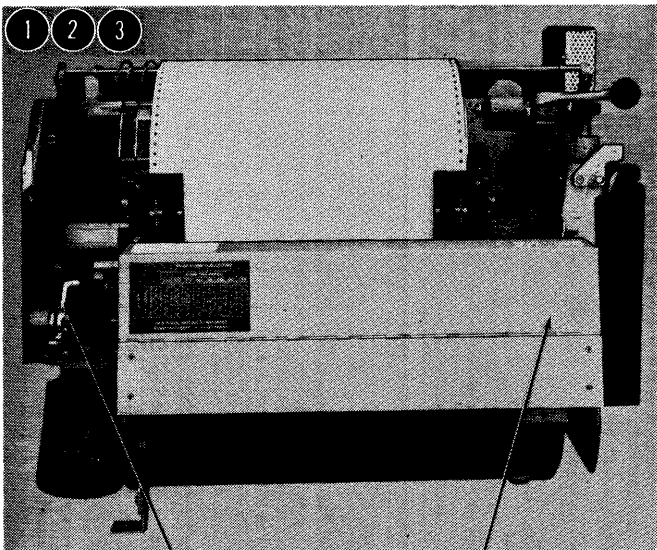

Print Unit
Release
Lever

Top
Ribbon
Cover

19179

1. Raise the printer cover.
2. Pull back the print unit release lever to unlock it, and swing the print unit outward.
3. Open the top ribbon cover.

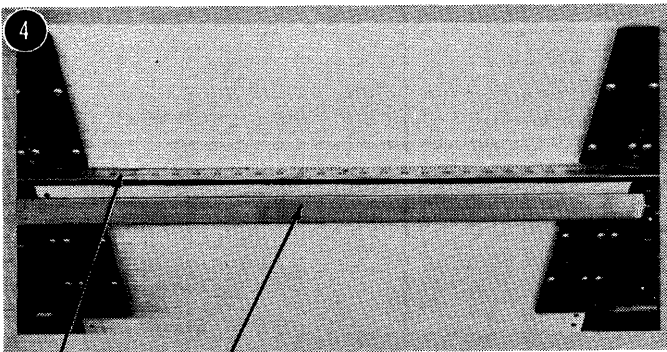

Print Line Indicator
Ribbon Shield

19180

4. Unlatch the print line indicator ribbon shield and swing it against the form.

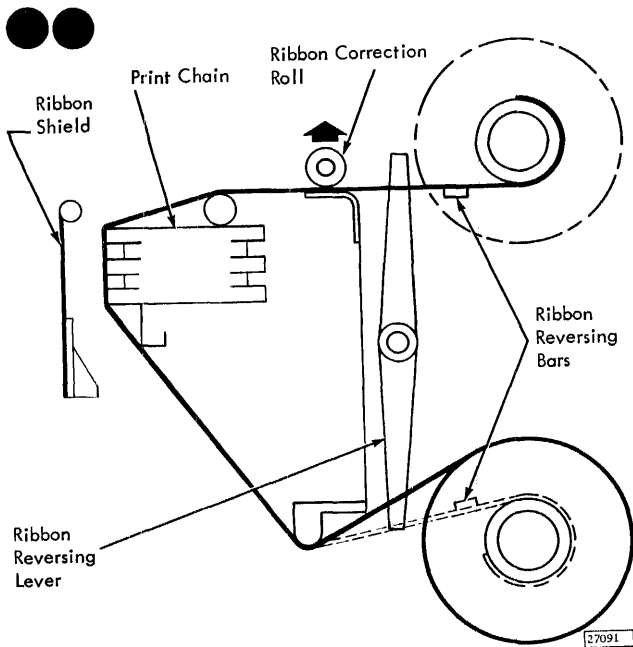

5. Push the top ribbon roll to the right (hinged side of print unit), lift out the left end of the ribbon roll, and remove the roll from the drive end of the mechanism.
6. Slip the ribbon from under the ribbon correction roller.

To remove the bottom roll, press the ribbon roll to the right, lower the left end of the ribbon roll, and remove it from the mechanism.

When replacing the ribbon in the machine, hand-tighten the ribbon to remove slack from the front of the printing mechanism.

Note: When installing a new ribbon in the printer, always load the full ribbon spool on the bottom spindle to ensure proper ribbon skew on the first winding of the ribbon.

Inserting Forms

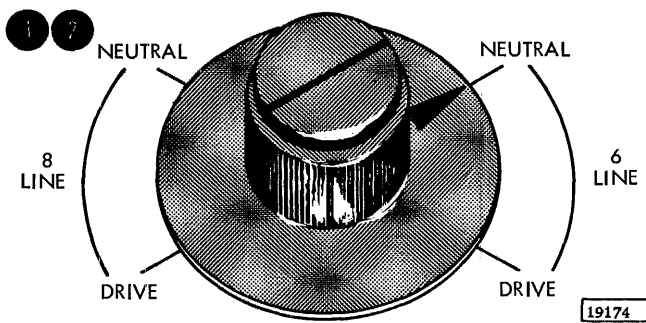

1. Raise the front cover of the printer.
2. Turn the feed clutch to NEUTRAL.

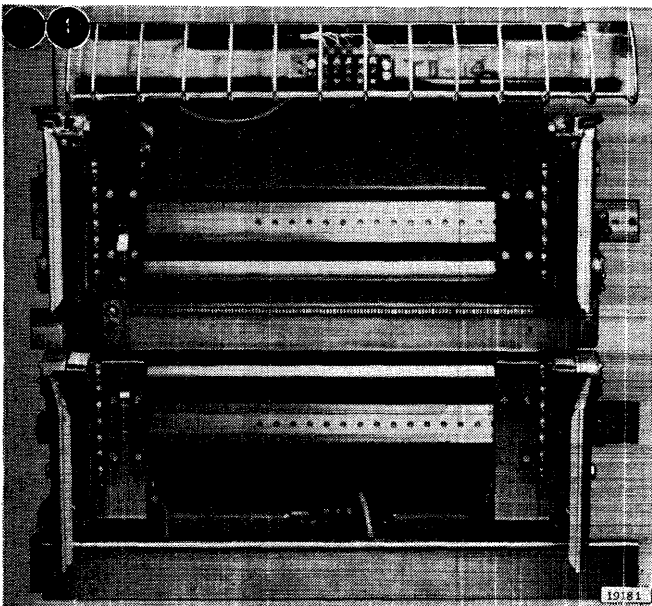

3. Pull back the print unit release lever to unlock it, and swing the print unit outward.
4. Set both of the left-hand forms tractors slightly to the left of the first printing position. Move these tractors until each one latches in its appropriate notch.

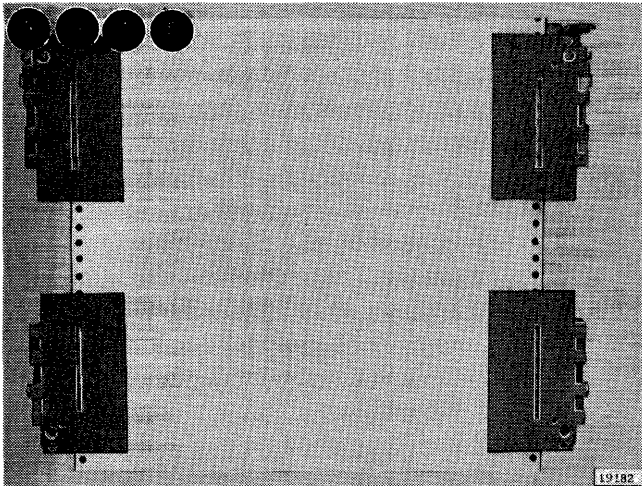

5. Open the left-hand tractor covers, place the forms over the pins, and close the covers.
6. Open both right-hand tractor covers.
7. Move the right-hand tractors to the desired location to line up the right side of the forms. Pull out the tractor pin-latch, and slide the tractor until the pin snaps into the appropriate position.
8. Place the forms over the tractor feed-pins and close the tractor covers.

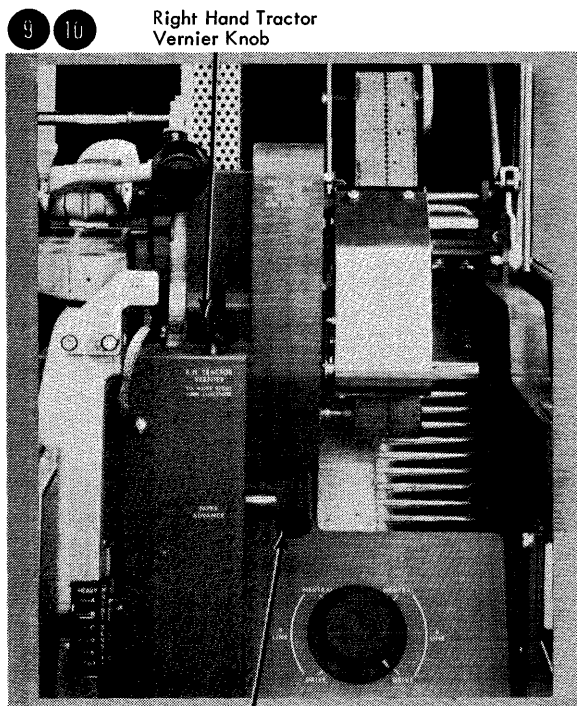

9 10 Right Hand Tractor Vernier Knob

Paper Advance Knob

9. Tighten the tension on the form, using the right-hand tractor vernier.
10. Turn the paper advance knob until the block, line, or area on which the first line of print is to occur is just visible above the ribbon guide bar (to position the form); align the desired hammer position to the form with the lateral print alignment lever and vernier; observe the relationship of the markings on the ribbon-guide-bar to the form; turn the paper advance knob backward three line spaces (if in six-line neutral) or four line spaces (if in eight-line neutral). The form is now properly positioned.

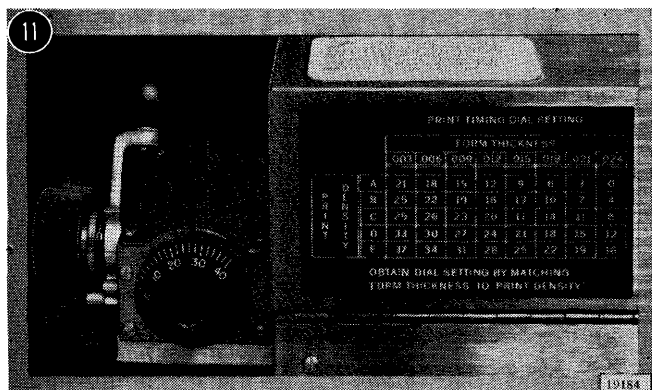

11. Close and lock the print unit. Be sure to push the print-unit release lever as far back as it will go.

Note: When the interlock is properly closed, the chain and ribbon motors start.



12. Press the carriage restore button to restore the carriage tape to the first printing position.

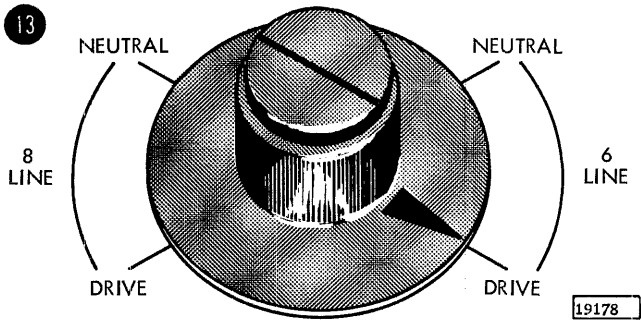

13. Set the feed clutch to DRIVE. Set it for either six or eight lines per inch, depending on the form to be printed.

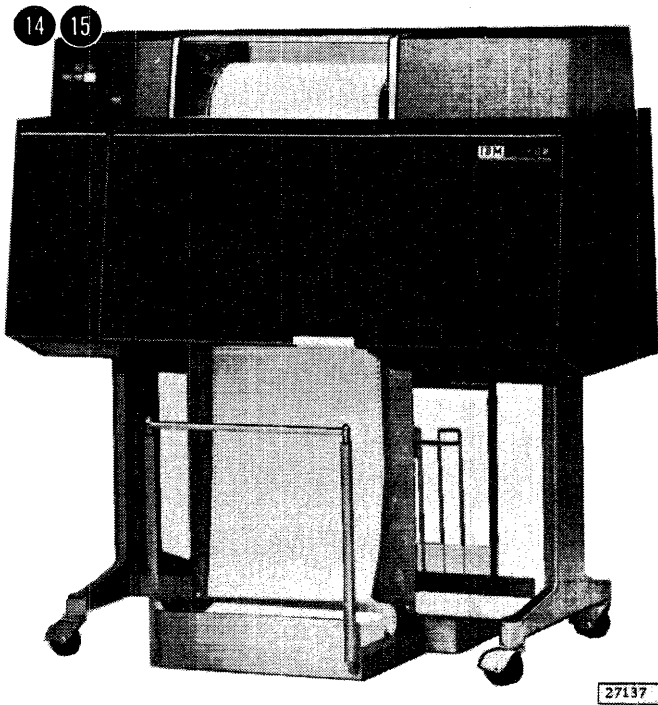

14. Close the cover of the printer.
15. Position the paper supply on the input paper cart so that the forms feed straight up into the machine.

Note: Paper guide control is on rear.

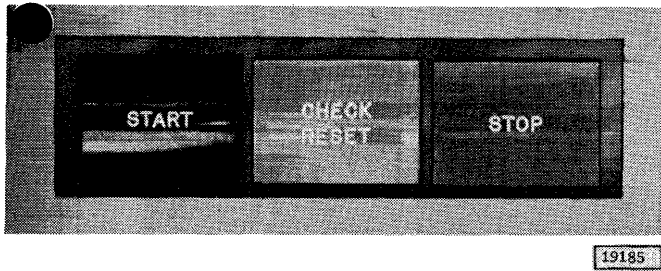

16. Press the reset pushbutton and then press the start pushbutton.

Note: When printing begins, operator attention is required behind the printer. The first form must be guided between the forms stacker guide and the machine. Then the first forms must be adjusted in the stacker so they fold flat. Stacking continues without additional operator attention if the stacker is properly adjusted beneath the stacker rolls.

Changing the Interchangeable Cartridge

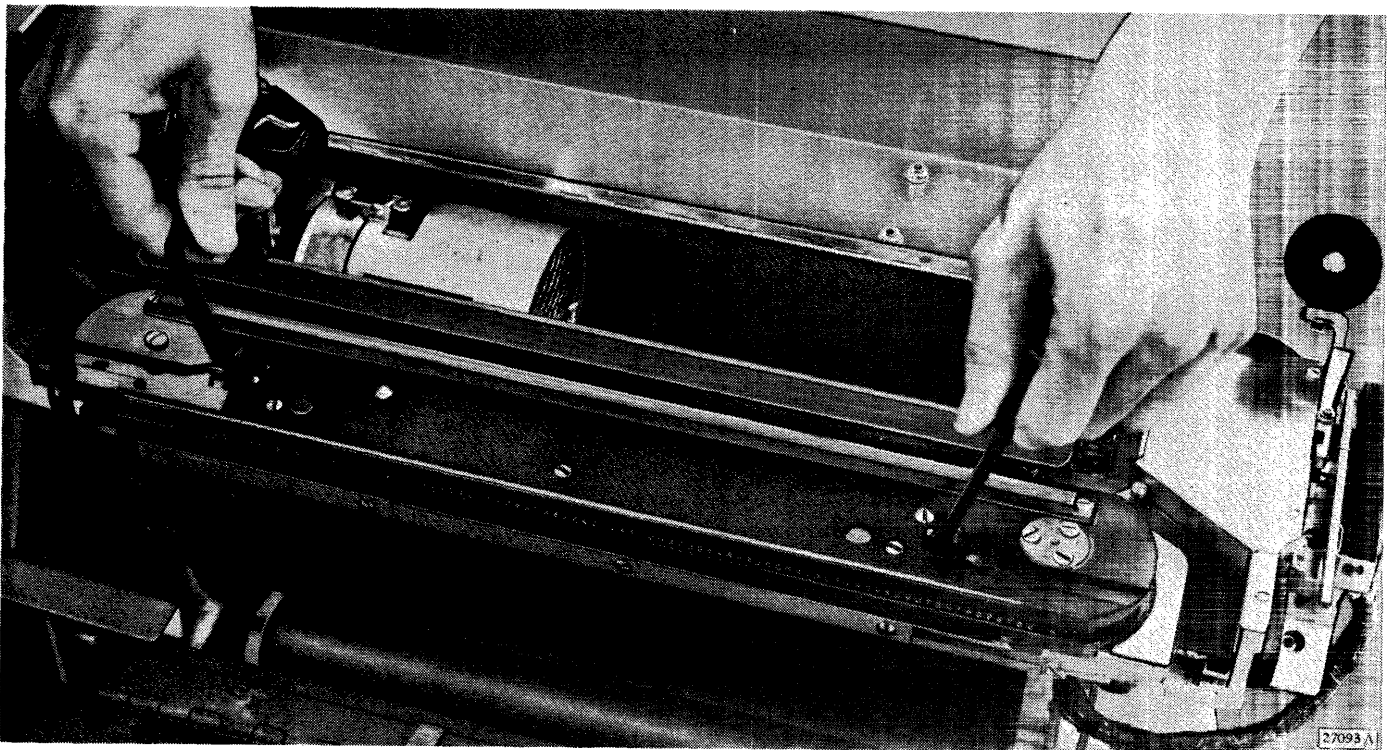

1. Raise the front cover of the printer.
2. Remove the ribbon, using the method described under "Changing the Ribbon."
3. Pivot the two handles on top of the cartridge to their vertical position. The cartridge unlocks and may be lifted from the print unit by the handles.
4. Using the special tool attached to the printer, turn the notched driver on the right side of the print unit until a screw is visible in the nearby open hole in the cover plate.
5. Again using the special tool, turn the drive gear in the new cartridge until the appropriate character on the specially marked slug is in line with the arrow engraved on the cartridge base. On all standard cartridges, the proper character is the digit 1 on the marked type slug.
6. Place the cartridge on its locating pins in the print unit.
7. Lock the cartridge in place by pivoting the handles down to their horizontal (original) position.
8. Replace the ribbon spool.
9. Close and lock the print unit.
10. Close the printer cover.

If any further adjustment is required to align the notch in the driver with the notch in the casting, complete this adjustment. This final adjustment is minor if the screw is properly positioned.

Operator Controls

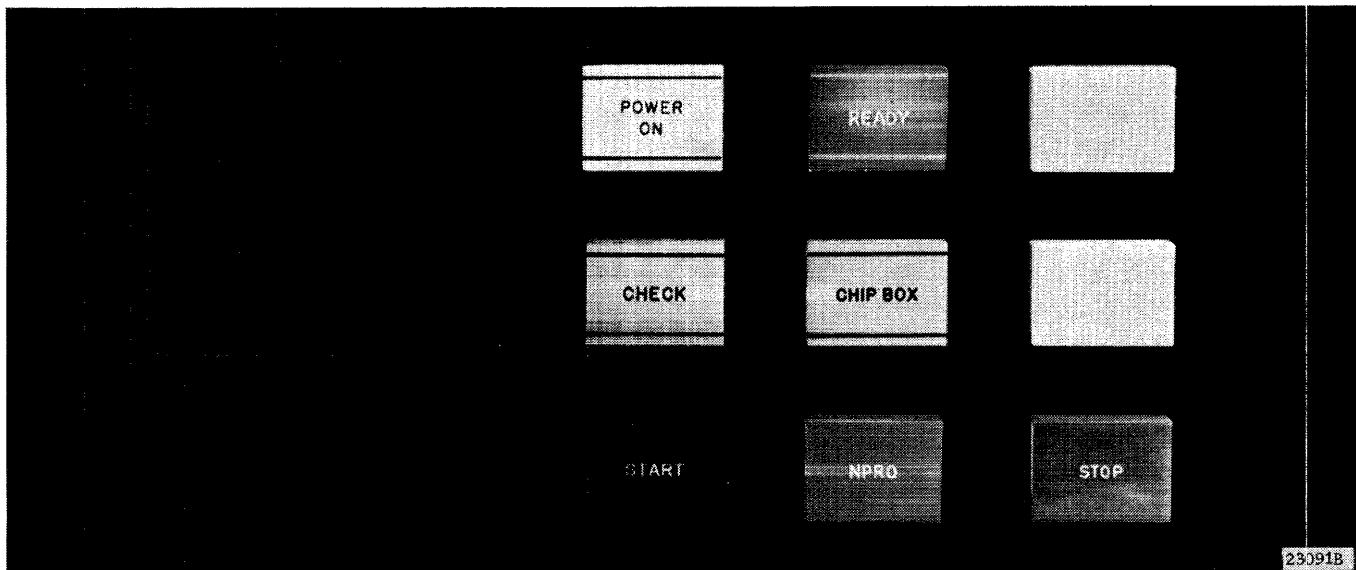

The HOPR (Hopper) Light indicates that a card was not fed from the hopper.

The Feed CLU (Clutch) Light glows when the clutch fails to latch, causing an extra feed cycle.

The Read REG (Register) Light turns on when a read check error occurs during a read cycle; that is, the two photocell readings of a column do not compare (models 6 and 7 only).

The Read STA (Station) Light turns on when a card is positioned incorrectly in the read station (models 6 and 7 only).

The Punch Light turns on when the image of the data to be punched and the echo of the punch magnets do not compare.

The Punch STA (Station) Light indicates that a card is out of position in the punch station.

The Overrun Light is not used.

The TRANS (Transport) Light turns on when a card is out of position in the card transport area between the punch station and stackers.

The Power On Light (frosted) turns on when the 1442 receives electrical power.

The Ready Light (green) turns on when the 1442 is prepared to accept instructions from the central processing unit. The following conditions must be satisfied before this light will turn on:

1. Power on.
2. Card registered at read station or punch station.
3. Cards in hopper, or 1442 in last card sequence routine.
4. Stacker not full.
5. Chip box, check, hopper, read STA, punch STA, TRANS, feed CLU lights off.

The ready light is turned off by the NPRO key, by the stop key, or by the operation that feeds the last card from the hopper.

The Check Light (amber) turns on when any of the seven condition lights turns on: HOPR, feed CLU, read REG, read STA, punch, punch STA, and TRANS. The check condition lights indicate the area or the cause of a check or both.

The Chip Box Light (amber) turns on when the chip box is full or is not in the machine. The chip box is located behind the left front cover.

The Start Key (green) performs the following functions:

1. Begins the initial run-in.
2. Restores the 1442 to ready status after manually stopping it.
3. Initiates the last card sequence.

For initial run-in, the start key places the card in position for reading or punching.

The NPRO (Non-Process Runout) Key ejects cards from the read-punch path without processing them and resets a check condition. The blue NPRO key operates only when the hopper is empty.

The Stop Key (red) terminates the ready status of the 1442.

Removing Jammed Cards

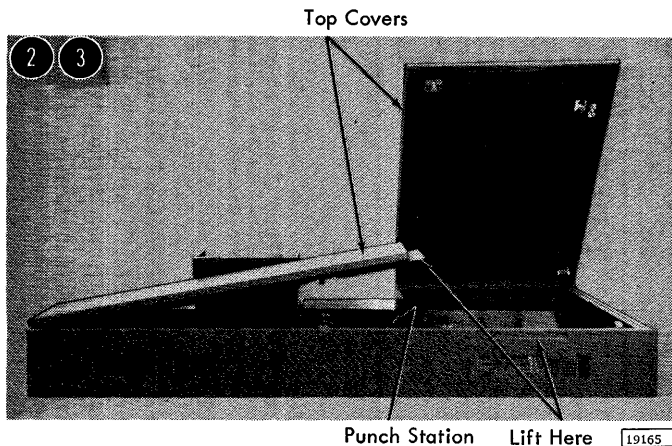
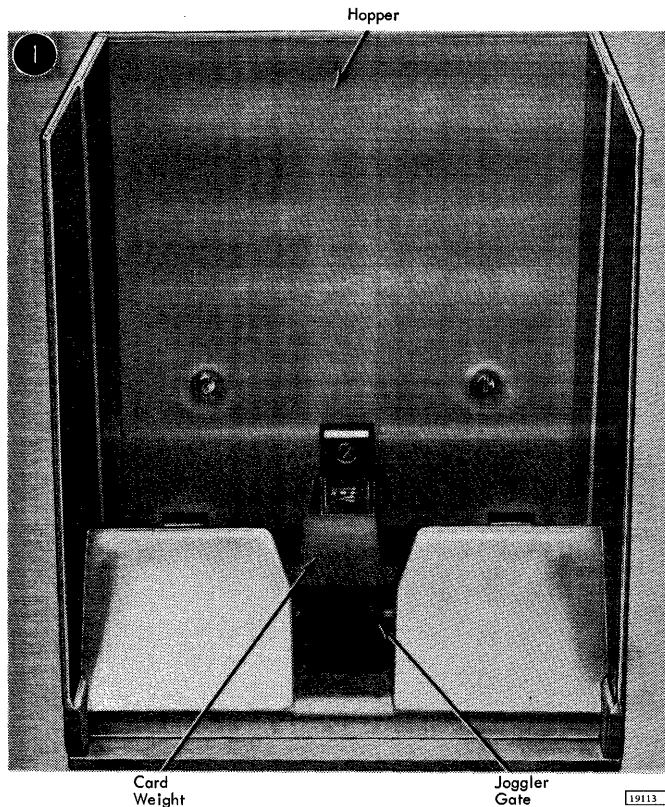

1. Remove the cards from the hopper.

2. Raise the two top covers.

Note: Raise the cover on the right first, then the cover on the left.

3. Locate the card jam. If the jam is not in the punch station, remove the jammed cards and proceed with steps 4 through 6. If the jam is in the punch station, proceed with step 7.

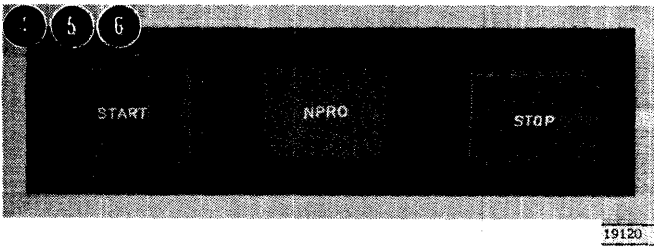

4. Press the NPRO key to run out any cards in the card feed or transport areas.
5. Replace the cards in the hopper.

Note: When placing cards onto the hopper, do not push cards on the bottom forward. To be safe, pull the bottom cards back about 1/8 inch.

6. Press the start key. The 1442 is again in the ready status.



Plastic Card Guides

Twist-type Fastener (one on both sides)

Rear Cover (partially shown)

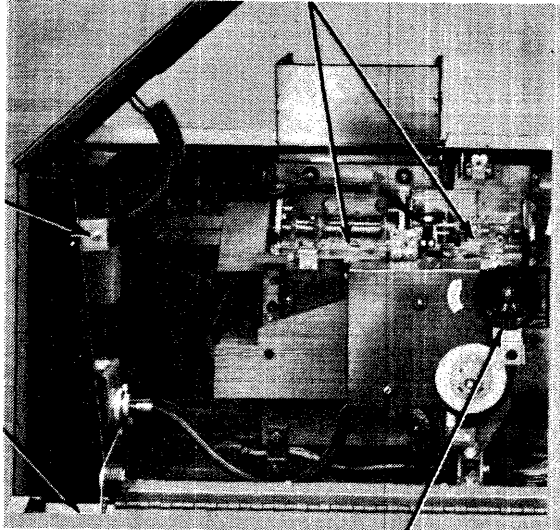

Handwheel

7. Turn the two twist-type fasteners on the inside of the rear cover counterclockwise.
8. Lower the rear cover.
9. Turn the punch unit handwheel clockwise at least one-half revolution (with the power on).

Lower Punch Guide

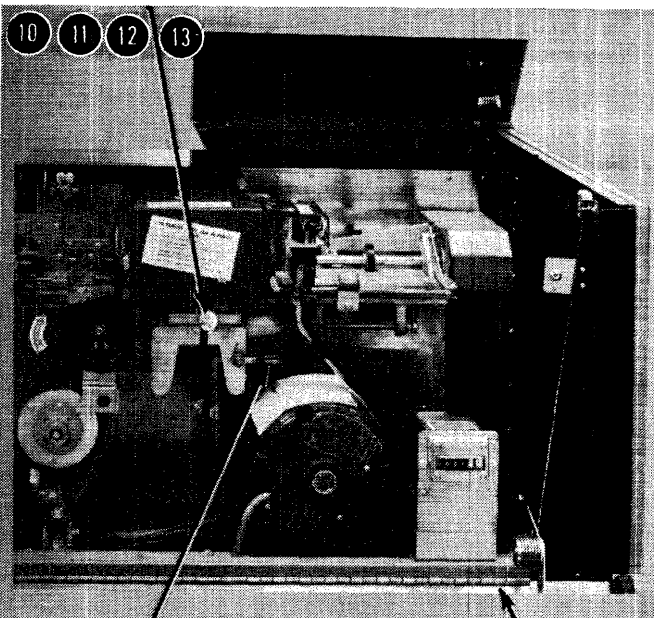

Punch Feed Release Lever

Rear Cover (partially shown) 19115

10. Push down on the punch feed release lever and pull out the card.

If the cards remain jammed, loosen the lower punch guide holding screw and remove the lower punch guide. If necessary, raise the two plastic card guides.

Caution

Do not use a card saw.

11. Replace the lower punch guide if it was removed.
12. Close the rear cover.
13. Close the two top covers.

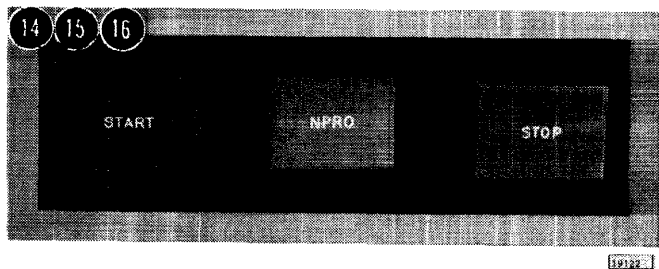

14. Press the NPRO key to reset the error condition.
15. Place one card in the hopper and feed it through with the start key and the NPRO key to make sure that the card patch is clear. If the card path is clear, place the remaining cards in the hopper.
16. Press the start key.
The 1442 is now ready to continue its operation.

Readying the 1442

1. Turn the system power on.
2. Press NPRO to turn off the HOPR light and to clear the card path. When the system is first powered up, the HOPR light comes on. If other lights are on, correct the conditions, and then press the NPRO key.
3. Place the cards to be processed in the hopper face down 9-edge first. Replace card weight.
4. Press START.
When the ready light turns on, the 1442 is in ready status.

Restarting the 1442

If a 1442 error occurs, the 1442 becomes not ready and remains in that condition until the operator intervenes. Unless the stop is caused by a full stacker (no indicator) or chip box indication, the 1442 card path must be cleared before proceeding. The 1442 error indicators and the position of the cards in the feed path should be used to determine which cards

must be placed back in the hopper.

A restart (or retry) consists of positioning the cards (that is, skipping the first card in the hopper, if necessary, on a read or feed operation) and reinitiating the function whenever the 1442 becomes ready.

Read errors do not apply to the 1442 model 5.

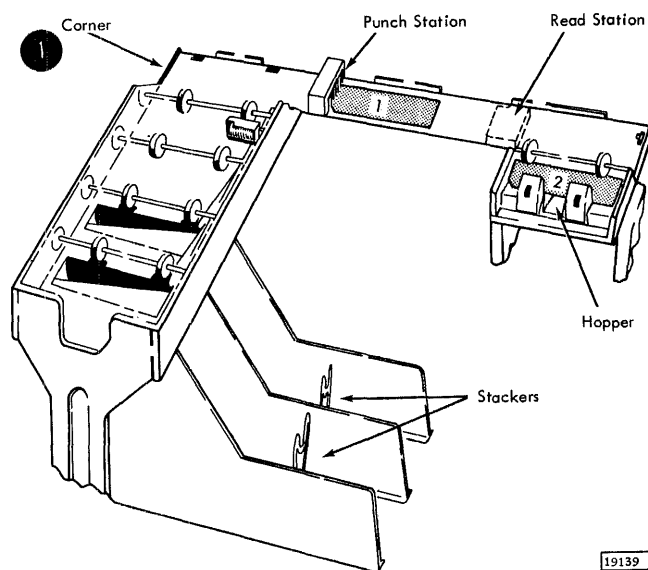

1. A Hopper Misfeed Error indicates that card 2 failed to pass properly from the hopper to the read station during the card 1 feed cycle.

Error Indicator: HOPR light on.

Operator Procedure: When program halts, press NPRO to eject card 1, place card 1 in hopper before card 2, and press START.

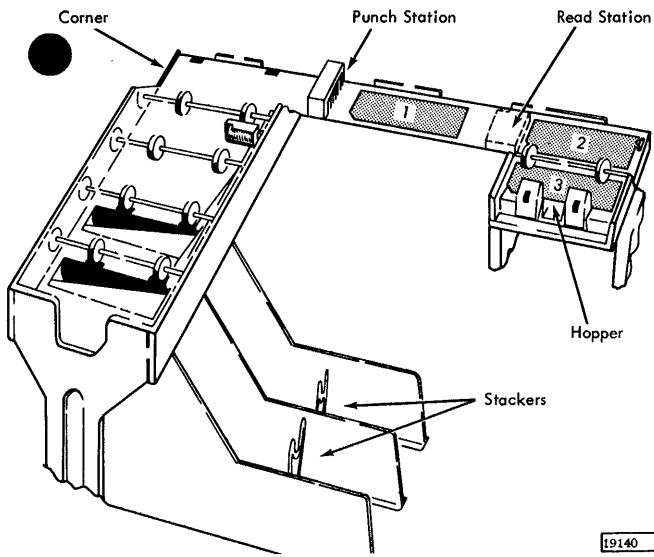

2. A Feed Check Error (punch station) indicates that card 1 is improperly positioned in the punch station at the completion of its feed cycle.

Error Indicator: PUNCH STA light on.

Operator Procedure: When program halts, empty hopper, clear 1442 card path, place cards 1 and 2 in hopper before card 3, and press START.

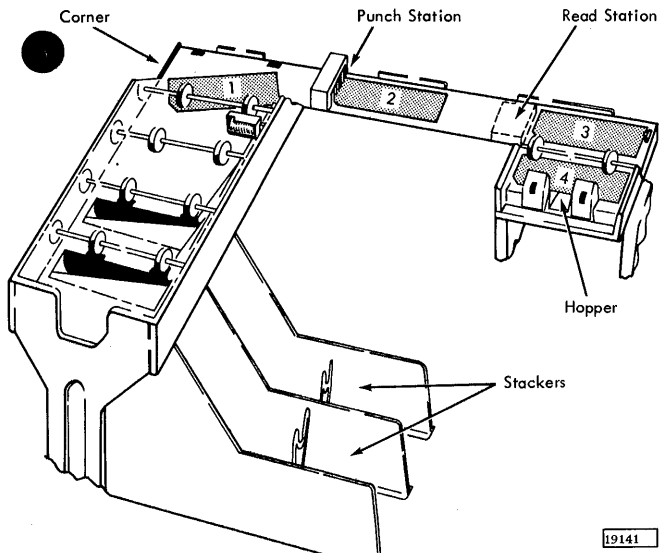

3. A Transport Error indicates that card 1 has jammed in the stacker during the feed cycle for card 2.

Error Indicator: TRANS light on.

Operator Procedure: When program halts, empty hopper, clear 1442 card path, place cards 2 and 3 in hopper before card 4, and press START.

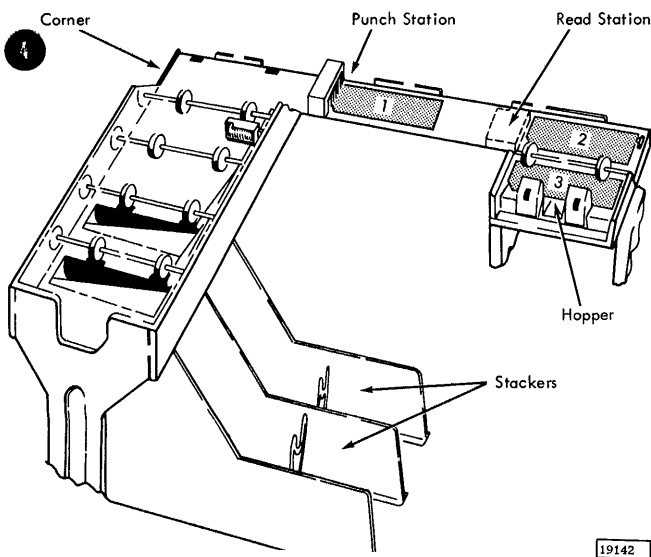

4. A Feed Cycle Error indicates that the 1442 took an unrequested feed cycle and, therefore, cards 1, 2, and 3 are each one station farther ahead in the 1442 card path than they should be.

Error Indicator: FEED CLU light on.

Operator Procedure: When program halts, empty hopper, press NPRO to eject cards 2 and 3, place cards 1, 2, and 3 in hopper before card 4, and press START.

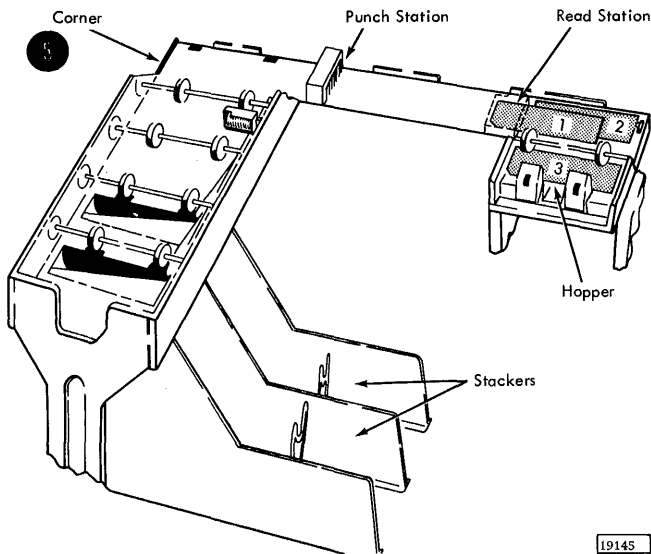

5. A Feed Check Error (read station) indicates that card 1 failed to eject from the read station during its feed cycle.

Error Indicator: READ STA light on.

Operator Procedure: When program halts, empty hopper, clear 1442 card path, place cards 1 and 2 in hopper before card 3, and press START.

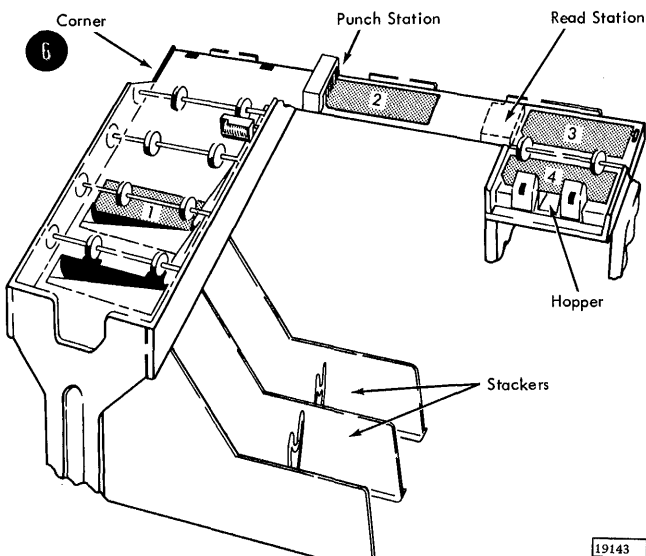

6. A Read Registration Error indicates incorrect card registration or a difference between the first and second reading of a column.

Error Indicator: READ REG light on.

Operator Procedure: See "A Feed Check (punch station)." Repeated failures of this type might indicate a machine malfunction.

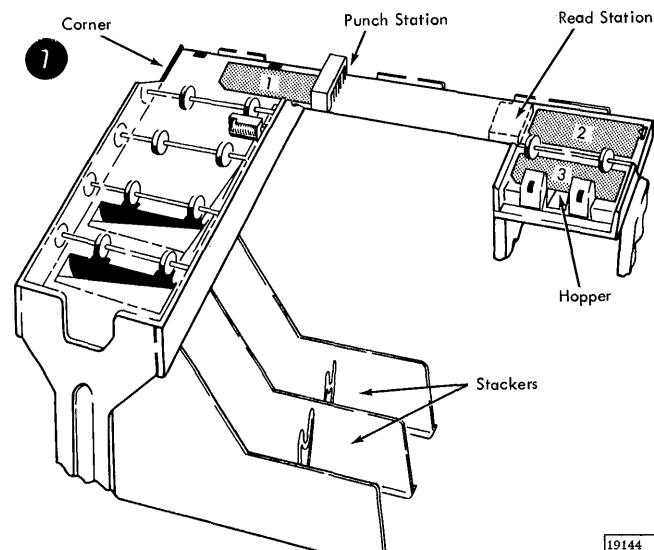

7. A Punch Check Error indicates an error in output punching.

Error Indicator: PUNCH light on.

Operator Procedure: When program halts, empty hopper, check card position and press NPRO to clear 1442 card path. If necessary, correct card 1 to prepunched state. Place card 1 (corrected) and card 2 in hopper before card 3, and press START.

IBM 1627 PLOTTER, MODELS 1 AND 2

Operator Controls

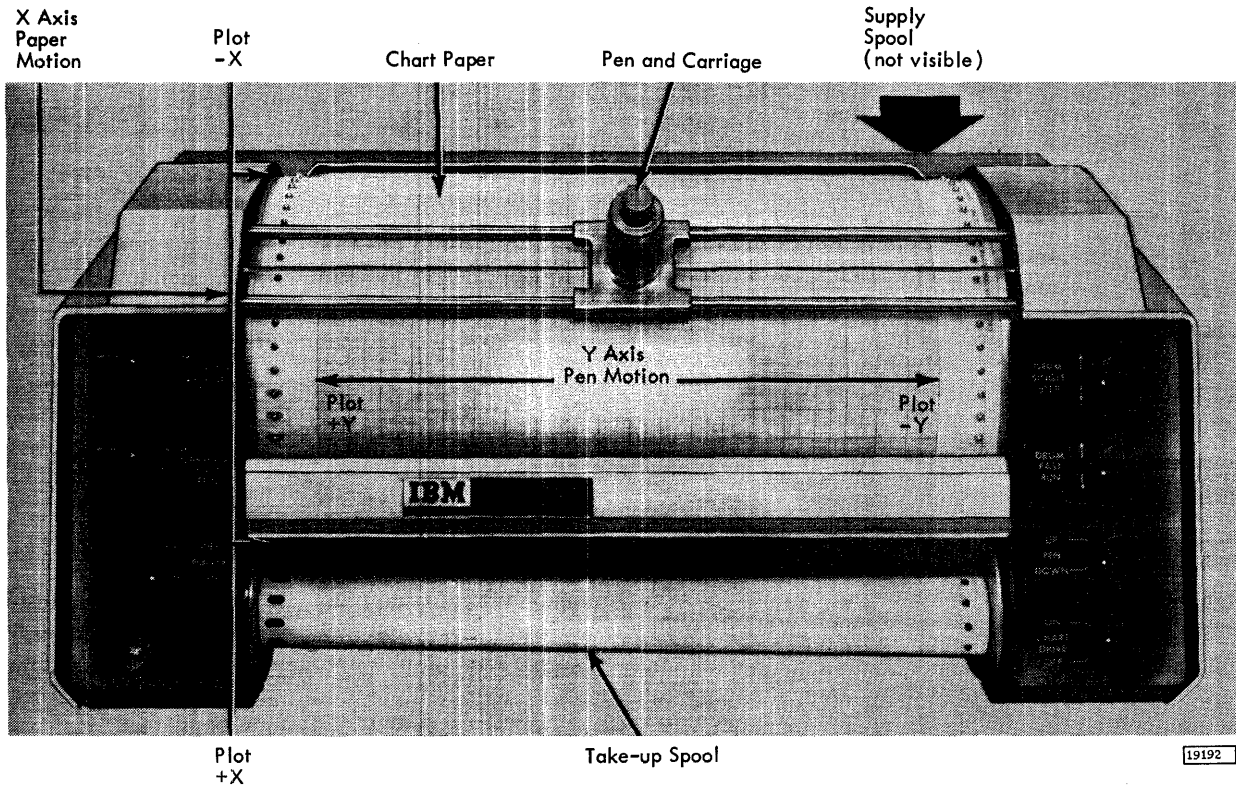

The Carriage Single Step Switch steps the pen carriage to the left or to the right in 1/100-inch increments. The carriage single step switch accurately aligns the carriage along the y-axis of the graph paper after the carriage has been positioned with the carriage fast run switch.

The Carriage Fast Run Switch steps the pen carriage rapidly to the left or to the right (120 steps per second). The carriage fast run switch can move the carriage to any desired area of a graph.

The Power On/Off Switch connects power from the central processing unit to the 1627. The power switch only operates when the central processing unit mainline power switch is on. No power-on delay is involved with the 1627 power switch; that is, the plotter can operate as soon as the switch is turned on.

The Power On Light glows when the 1627 receives electrical power.

The Drum Single Step Switch rotates (steps) the drum in 1/100-inch increments clockwise or counterclockwise along the x-axis. This switch is used with the carriage single step switch to accurately align the pen on a point or fixed coordinate on a graph after the carriage has been positioned with the drum fast run switch.

The Drum Fast Run Switch moves the drum rapidly clockwise or counterclockwise (120 steps per second). This switch is used with the carriage fast run switch to position the pen to any desired area of a graph.

The Pen Up/Down Switch raises or lowers the pen.

The Chart Drive On/Off Switch disables the front and rear chart drives. When the 1627 is recording on a sheet of graph paper, the chart drive switch should be off. When the 1627 is recording on a roll of paper, the chart drive switch should be on.

The Vernier Control Knob varies the size of the pen carriage increments on the 1627 model 2.

In this way, the pen traverse is adjusted to match the printed scale of the chart paper, which may vary in width because of high or low humidity. The vernier control knob is located at the left end of the drum above the switch panel. For work with non-scale paper, the control should be centered at the zero position.

Installing a Roll of Graph Paper

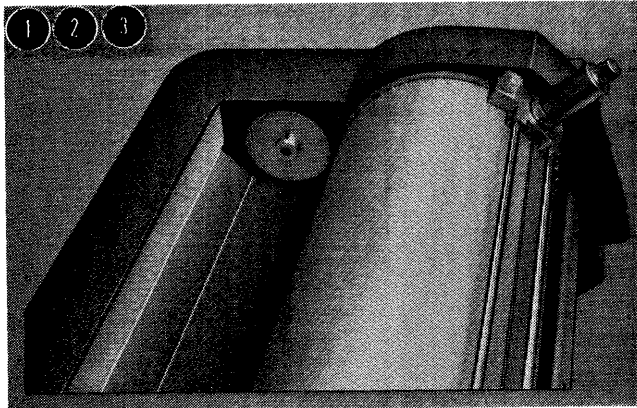

19154

1. Turn the power switch to OFF.
2. Loosen the knurled knob at the bottom of the pen holder and remove the pen assembly from the carriage.

Caution

Use care when handling the pen assembly. This assembly is manufactured to close tolerances for optimum performance.

3. Turn the right rear chart spool by hand until the drive key is pointing upward.

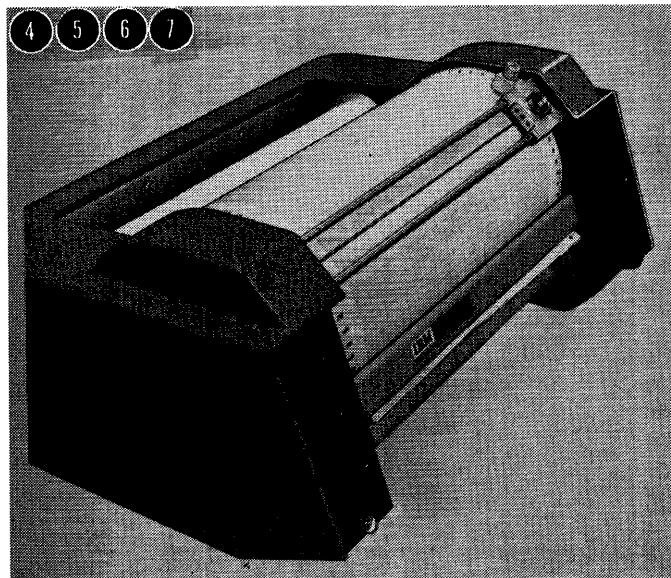

19189

4. Hold the roll of graph paper so that the key slot in the core is pointing upward.
5. Place the roll against the spring-loaded left rear idler (supply) spool and force the spool to the left.
6. Lower the paper roll and slide the right end onto the drive spool. Make certain that the drive key engages the key slot in the core.
7. Put a paper roll core on the two front spools below the drum, using the same procedure for installing the paper roll (steps 3-6).

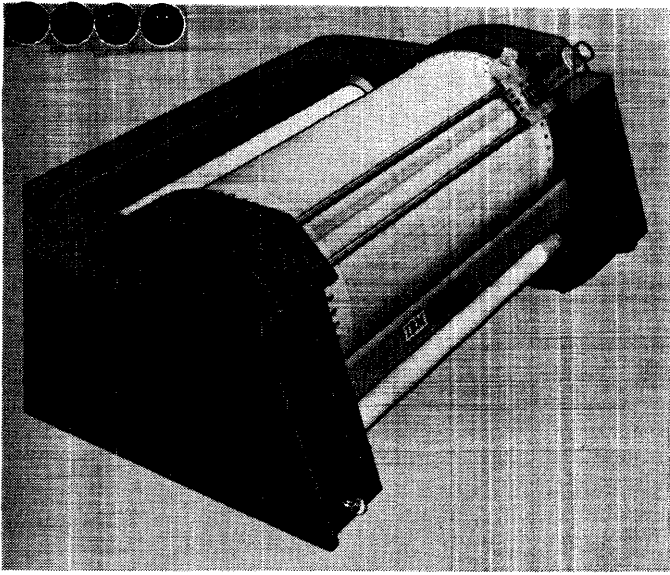

8. Pull approximately 18 inches of paper off the roll; slide the end under the carriage rods, behind the tearbar, and behind the core; and fasten the end of the paper to the front side of the core with two or three short pieces of cellophane tape.
9. Wind the paper onto the core -- one or two rotations. Be sure that the drum sprockets are properly meshed with the sprocket holes on both sides of the paper.
10. Install the pen assembly onto the carriage. (Reverse step 2.)

The pen is in a down position when the power is off; therefore, install the pen assembly onto the carriage over an area outside the "recording area."

11. Turn the power switch to ON.

The pen should rise when the power is turned on. If the pen does not rise when the power is turned on, turn the pen switch to DOWN, then to UP.

(Reverse the installation sequence to remove a roll of chart paper.)

Installing a Sheet of Graph Paper

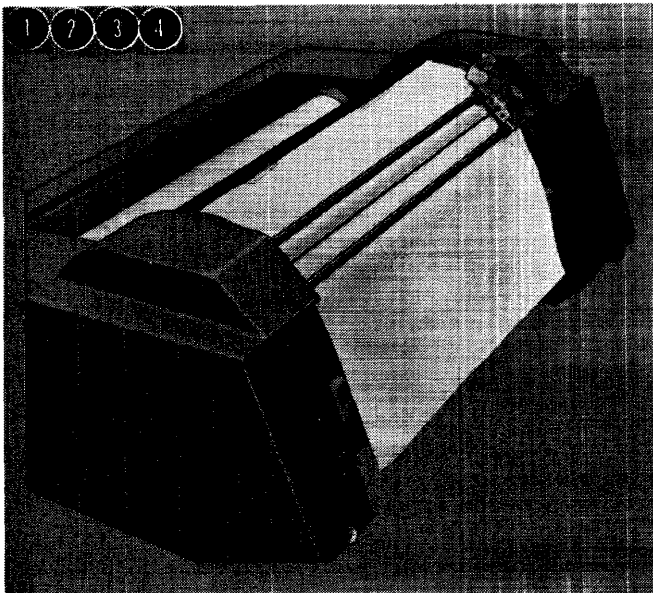

1. Turn the power switch to OFF.
2. Loosen the knurled knob at the bottom of the pen holder and remove the pen assembly from the carriage.

Caution

Use care when handling the pen assembly. This assembly is manufactured to close tolerances for optimum performance.

3. Slide the sheet of graph paper under the carriage rods onto the drum surface.
4. Attach the top edge of the paper to the drum with two or three short pieces of cellophane tape.

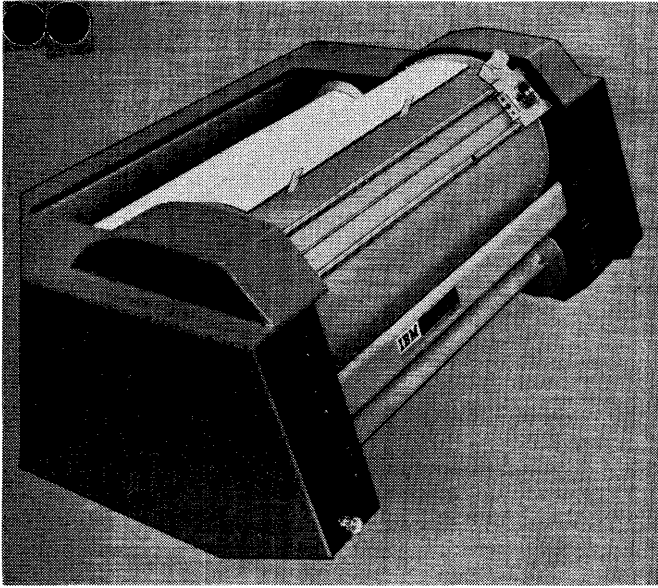

19152

5. Turn the drum upward by hand, keeping the paper smooth and flat against the drum surface.
6. Attach the bottom edge of the paper to the drum with two or three short pieces of cellophane tape.

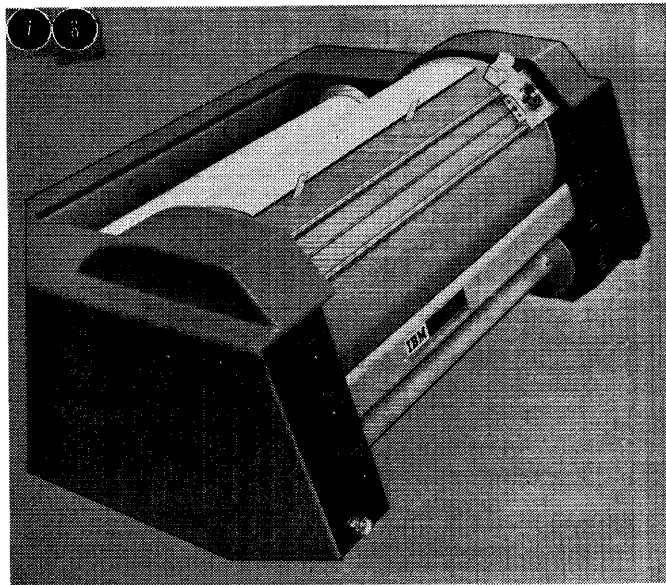

19153

7. Install the pen assembly onto the carriage. (Reverse step 2.)
8. Turn the power switch to ON.
Reverse the procedure to remove a sheet of graph paper. (If tape adhesive should remain on the drum surface, clean it with cloth and cleaning solvent.)

Assembling the Pen

1. Unscrew the cap from the holder.

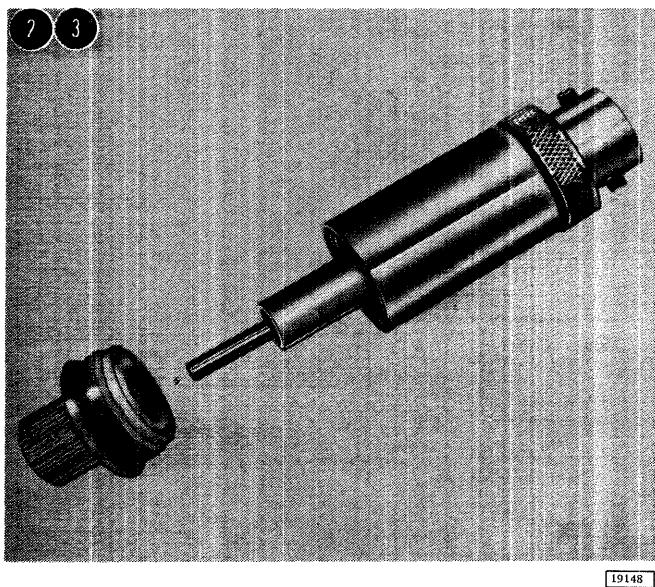
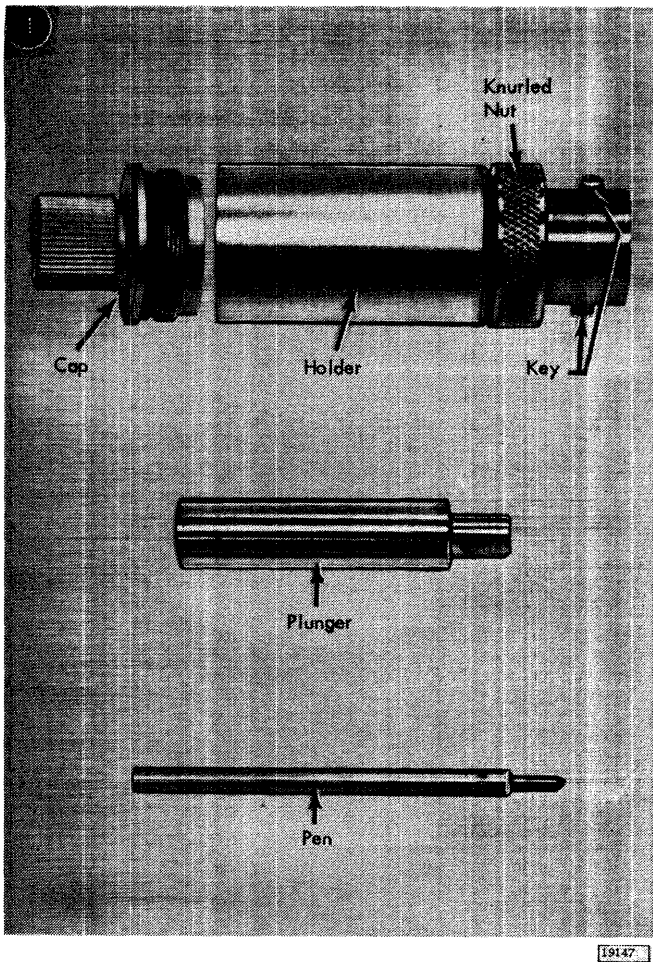

2. Insert the pen into the plunger.
3. Insert the pen and plunger into the holder.

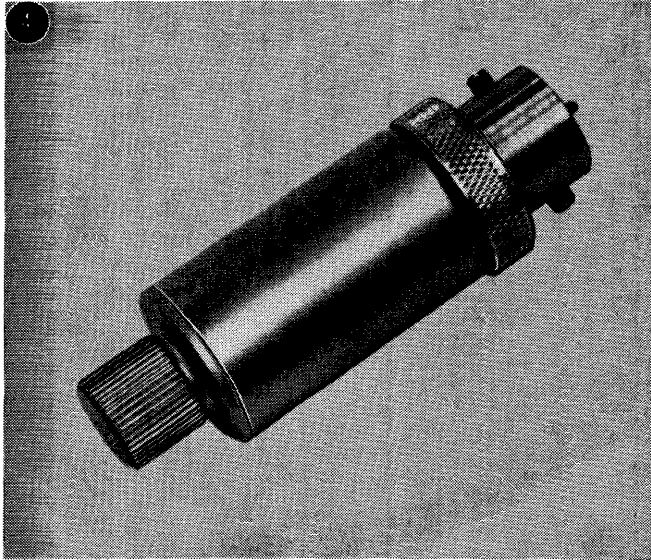

19146

4. Screw the cap onto the holder.

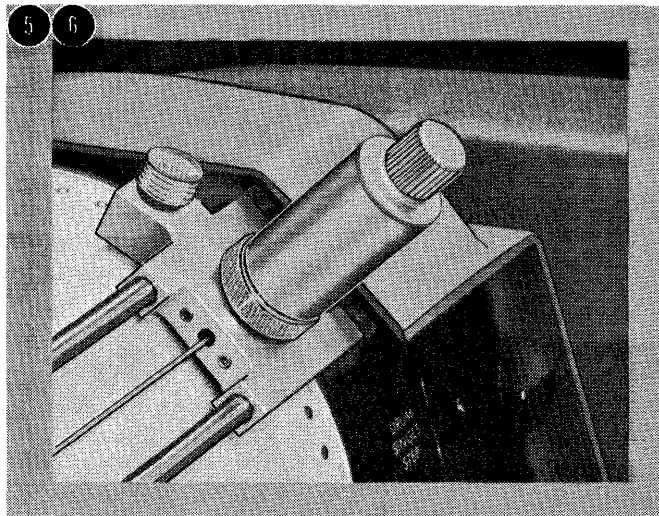

19191

5. Align the key on the holder with the key slots in the carriage and press the pen assembly into the pen mounting.
6. Tighten the knurled nut on the bottom of the holder.

The ball-point pens used with the 1627 may blot. Therefore, be sure to clean the pen tip after each hour of use. Since the ink in a pen only lasts for five to seven hours of writing, the pen should, perhaps, be replaced before plotting a critical project.

Caution

Use care when handling the pen assembly. This assembly is manufactured to close tolerances for optimum performance.

Checking the Plotter Operation

1. Install the graph paper and assemble and install the pen components.
2. Turn the power on/off and chart drive switches to ON.
3. Turn the pen switch to DOWN and the drum fast run switch to the up position. Verify that the pen traces a vertical line.
4. Turn the pen switch to UP and verify that the pen lifts off the surface of the paper.
5. Turn the pen switch to DOWN, and the drum fast run switch to the down position. Verify that the pen retraces the previously drawn line.
6. Turn the carriage fast run switch to the left position and verify that the pen traces a horizontal line. When the carriage reaches the edge of the paper, turn the carriage fast run switch to the right and verify that the pen retraces the horizontal line.

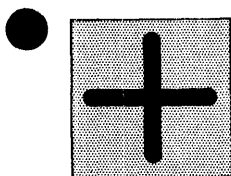

Step 1.

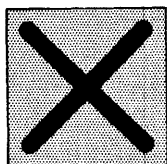

Step 2.

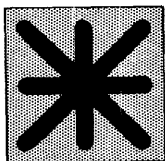

Final Result
Properly Aligned

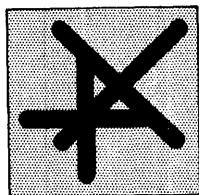

Final Result
Improperly Aligned

23089

7. Turn on the carriage single step switch and the drum single step switch alternately. Verify that both the carriage and the drum only move one step each time.

Note: It is useful to include a program checking routine within a program designed for plotter use. This routine is used for debugging the program initially and for checkout of the system at any time. The program check provides a graphic representation to replace the feedback checks used in other output units.

The logic of a program check is simple: (1) plot a plus symbol (+) at the start of the program (outside the graph area), and (2) return to this location at the end of the program to superimpose an X over the plus symbol. See example on the left.

Operator Controls



The Alphameric Keyboard has 44 character keys (space bar and null) for selecting 90 (upper- and lower-case) EBCDIC characters. The alphameric keyboard is under control of the central processing unit program.

The Shift Key, when pressed, permits the selection of any upper-case alphabetic character or any upper-case character identified on the dual-character keys. When the shift key is up, any lower-case alphabetic character or lower-case dual-character-key character can be selected.

The Lock Key holds the shift key in the down position.

The ALTN Coding Key allows the selection of NULL, END, or CANCEL. When pressed with any other key, this key generates a null code.

The Continue Key, when held down with a character or control key, enters a character or control code every regeneration cycle.

The End, Cancel, Advance, Backspace, and Jump Keys functions are under control of the central processing unit program.

The Programmed Function Keyboard contains 32 keys, 32 indicators, and eight switches which sense a code punched into the top edge of an overlay. The program defines the function of each key and indicator.

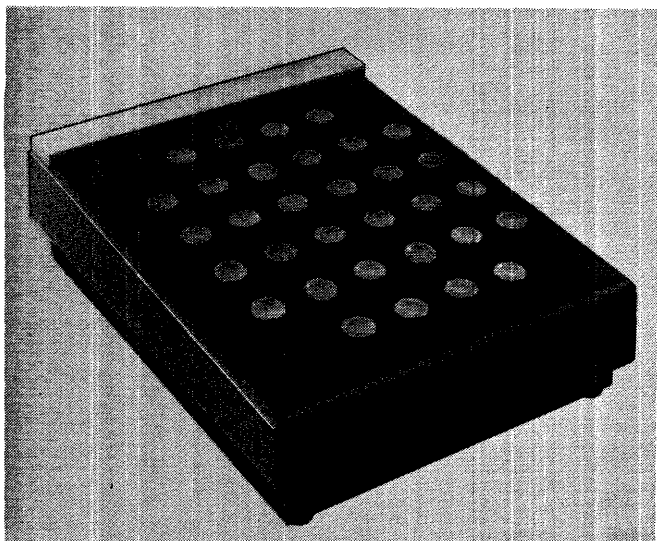

The Light Pen, a fiber-optic device, operates under control of the central processing unit program.

Two small beams of light projected by the light pen appear as two small dots on the cathode-ray tube faceplate. These dots assist the user in aiming the light pen by "bracketing" the image section that is within the light pen field of view.

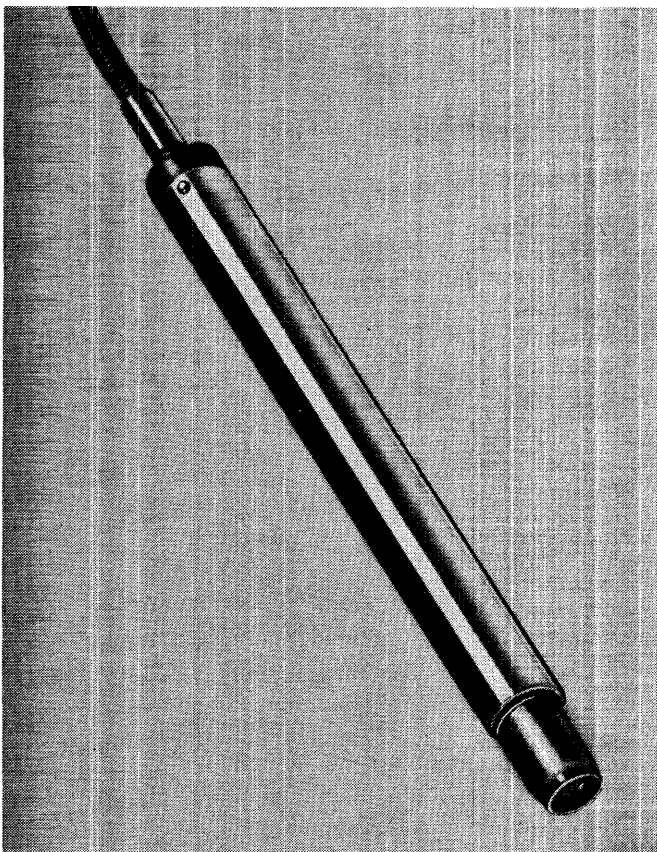

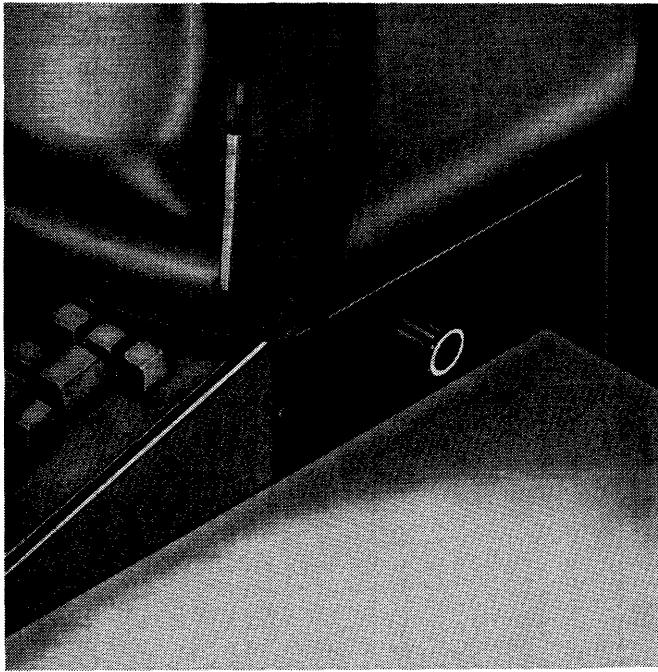

19156

The **Brightness Control** adjusts the light intensity of the overall display for a given regeneration rate. Improper adjustment of this control might result in faulty light pen operation.

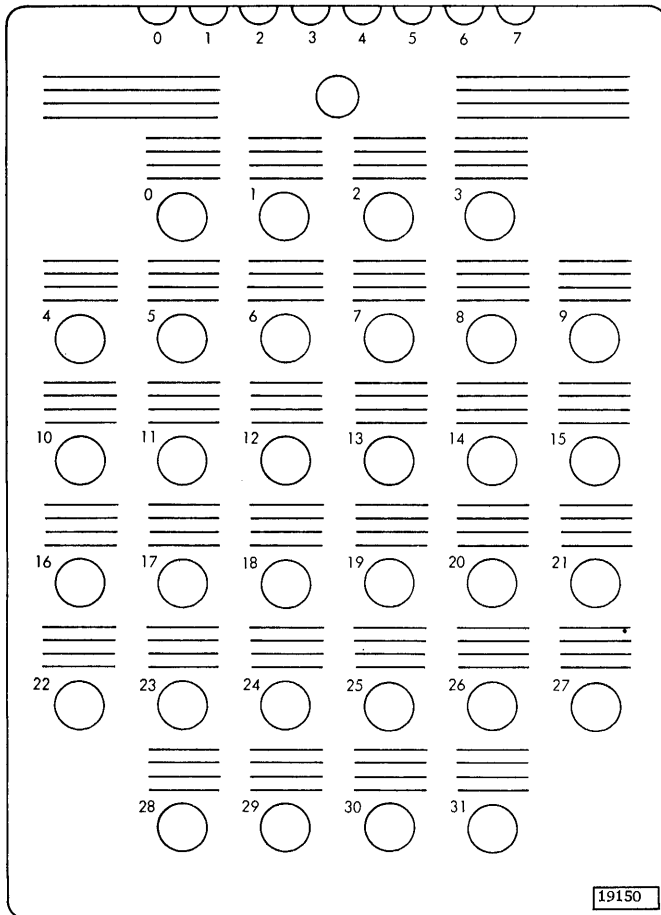

19150

The **Programmed Function Keyboard Overlay** identifies the function of the keys and indicators, both to the operator and to the central processing unit program. The circles on this overlay represent the holes through which the keys/indicators protrude. The number at the upper left of each circle is the code of the associated key/indicator. Overlays can be marked by typewriter, ball-point pen, or pencil. A clear lacquer spray is suggested for fixing the markings on the overlay (to prevent smudging).

Operator Controls



27157

The Start/Stop Switches cause the disk drive to cycle up (start) or cycle down (stop). To cycle up means that the 2310 enters ready status. The disk drives take approximately 90 seconds to cycle up and approximately 40 seconds to cycle down.

The Cartridge Unlocked Lights turn on when the 2315 Disk Cartridges unlock from the drives. The disk cartridge is locked into the drive whenever the disk is spinning. The operator should not try to remove the disk cartridge when the cartridge unlocked light is off.

The Disk Drive Numbers (1 and 2) and Heads Loaded Lights have two purposes: they identify disk drive units -- 1 for the upper drive and 2 for the lower drive -- and they indicate to the operator when the heads are loaded on the disk.

The Enable/Disable Switch, when on ENABLE, starts the usage meter if both the disk storage drive is ready and the central processing unit is running. When the switch is on DISABLE, the usage meter stops and the disk turns on a not-ready indicator. To change the position of the switch, the central processing unit must not be in a run condition.

Changing the Disk Storage Cartridge



Start/Stop Switches

Press here to open door

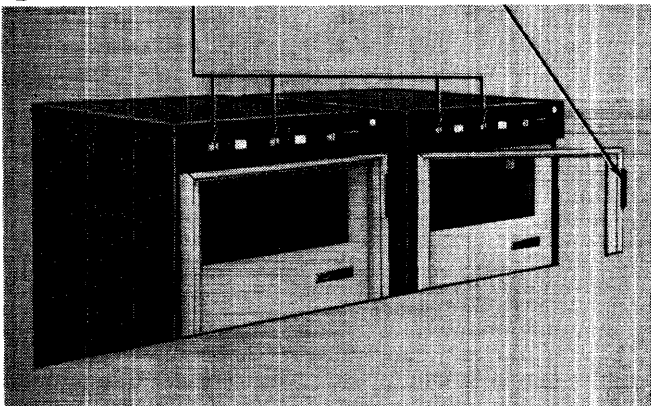

19186

1. Put the start/stop switch on STOP.
2. Open the 2310 door when the cartridge unlocked light comes on.

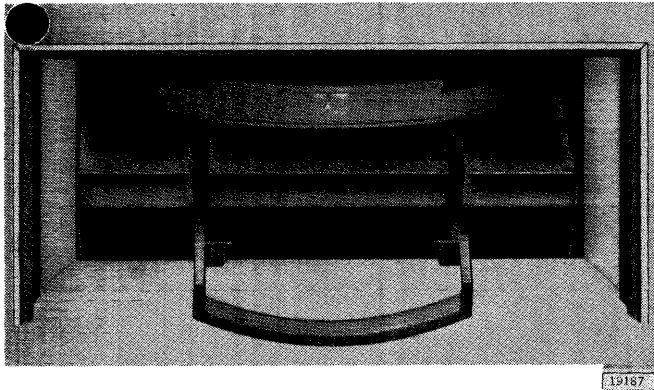

19187

3. Pull down the release/lock handle and remove the cartridge. (An interlock prevents removal of the cartridge until system power is on and the disk has stopped spinning.)

Close the cartridge door by pressing down on it. This step is important for two reasons: it creates a positive dust seal, and it immobilizes the disk in the cartridge.

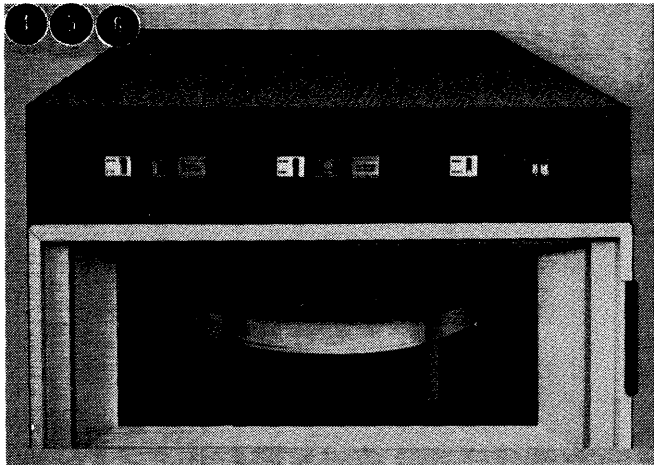

19188

4. Insert the cartridge into the aperture. The access mechanism read/write heads are automatically positioned as the cartridge is inserted.
5. Raise the access release/lock handle to lock the cartridge in place.
6. Close the 2310 door and put the start/stop switch on START.

An interlock prevents the motor from starting unless the cartridge is correctly inserted and the disk is in place. The disk reaches ready status in approximately 90 seconds.

Operator Controls

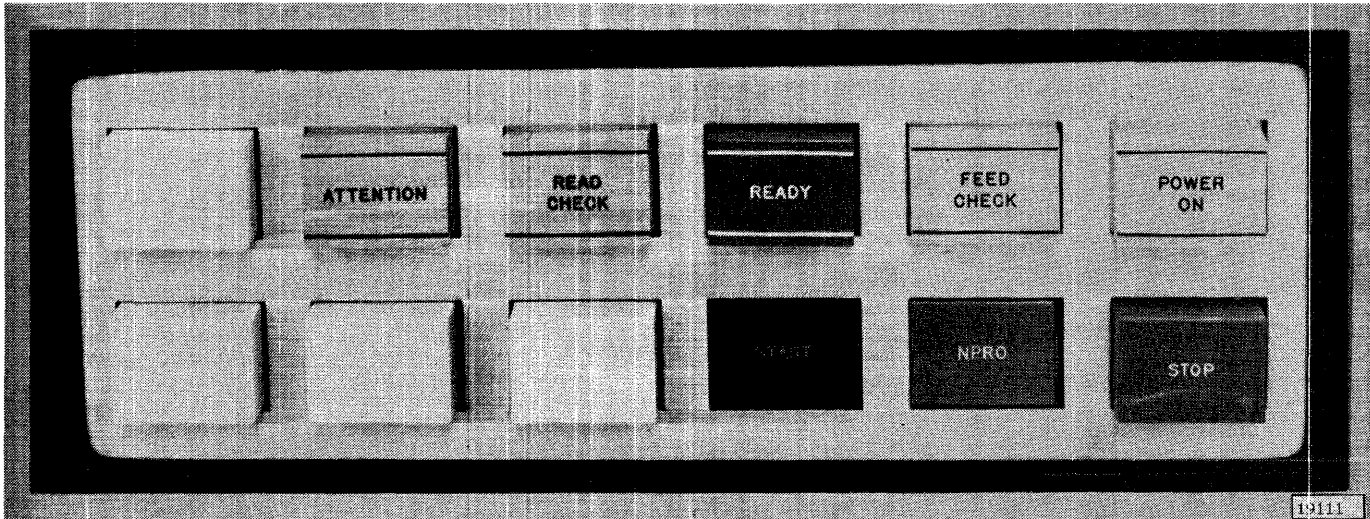

The Attention Light (amber) turns on when the stacker is full or when the top cover is open. The attention light turns off when the error condition is corrected.

When the attention light turns on, the ready light turns off.

The Read Check Light (frosted) indicates incorrect card registration or a difference between the first and second reading of a column.

To restart, empty the hopper, press NPRO, place the last two cards in the stacker ahead of the deck remaining to be read, place the deck remaining to be read back in the hopper, and press START.

The Ready Light (green) turns on when the 2501 is prepared to accept instructions from the central processing unit. The following conditions must be satisfied before the ready light will turn on:

1. Power on.
2. Cards in hopper, except during last-card sequences.
3. Card in preread station, except during last-card sequences.
4. Read check, feed check, and attention lights off.
5. Machine not halted with stop key.
6. Cards not being run out with the NPRO key.
7. Last card indicator not set.

The Feed Check Light (amber) indicates that a card is mispositioned in the feed path or that a card has failed to feed from the hopper.

To restart, empty the hopper and clear the 2501 card path. If a card is improperly positioned at the preread station (it has not been read), place this card ahead of the cards remaining to be read, place the deck back in the hopper, and press START.

The Power On Light (frosted) glows when the 2501 receives electrical power.

The Start Key (green) turns on the ready light if the electrical power is on. If no card is at the preread station, one card is fed to that position.

The NPRO (Non-Process Runout) Key ejects all cards in the card read path to the stacker without reading them. The blue NPRO key operates only when the hopper is empty and when the machine is clear of card jams.

The Stop Key (red) terminates the ready status of the 2501. If a card read operation is in progress, the operation is completed before the machine stops. The start key restarts the 2501.

Removing Jammed Cards

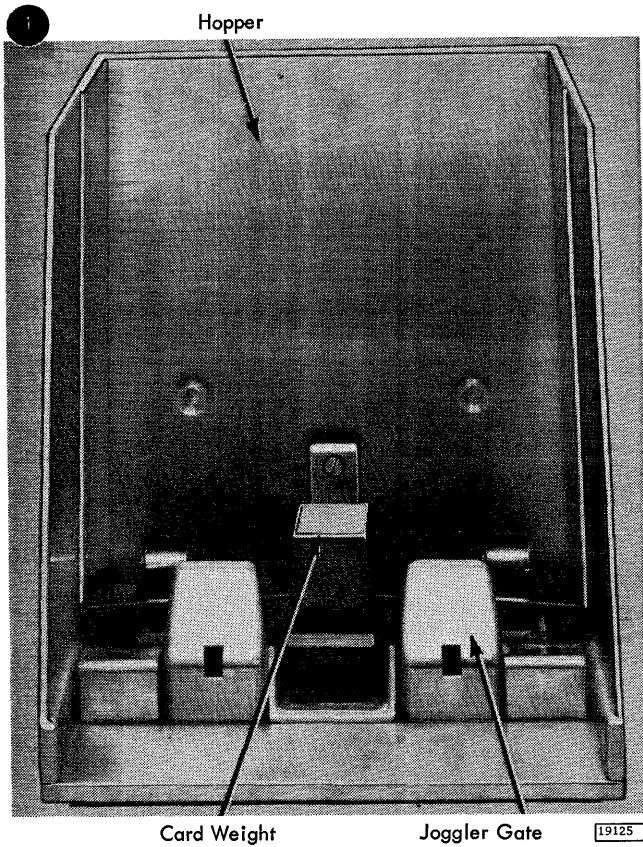

1. Remove the cards from the hopper.

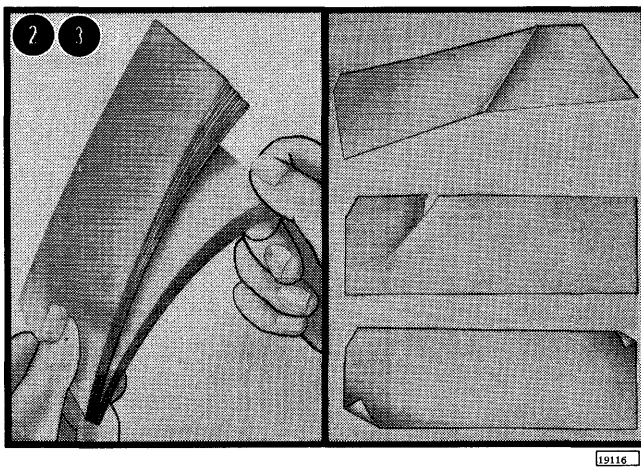

2. Fan the cards.
3. Replace creased or torn cards.

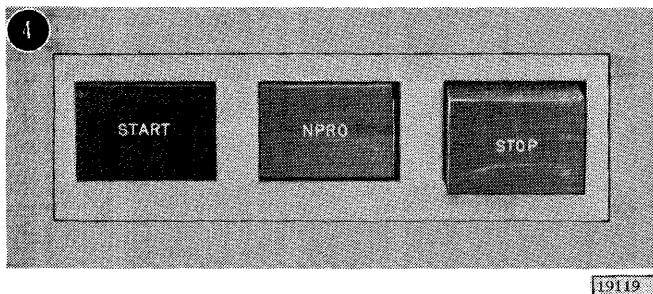

4. Press the NPRO key. If this procedure does not turn off the feed check light, proceed with step 5.

Lift here

Rear Top Cover

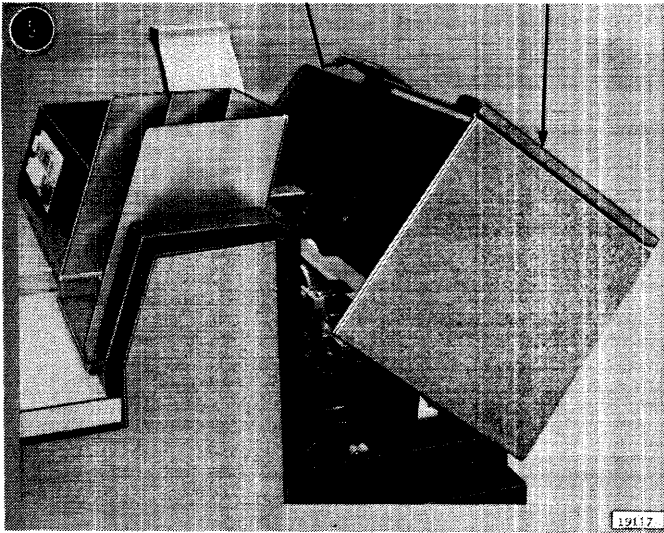

5. Raise the rear top cover.

Plastic Card Guide

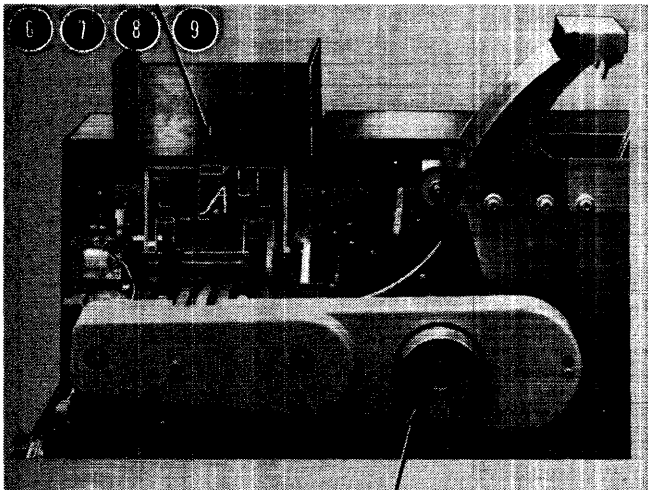

6. Turn the handwheel forward or backward to remove any card that is partially under the feed roll.
7. Raise the plastic card guide over the preread station, if necessary, to aid in removing the jammed card.
8. Close the plastic card guide.
9. Close the rear top cover.

Handwheel

19118

10. Press the NPRO key.
11. Press the start key. (The 2501 is now in ready status.)

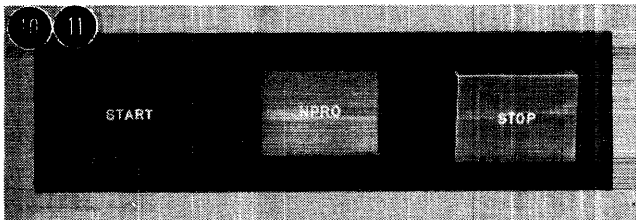

Readying the 2501

1. Turn system power on.
2. Press NPRO to clear the feed check condition.
When system power is turned on, a feed check automatically results in the 2501.

3. Load the hopper with cards -- face down, 9-edge first. Replace card weight.
4. Press START.
The 2501 is now in ready status.

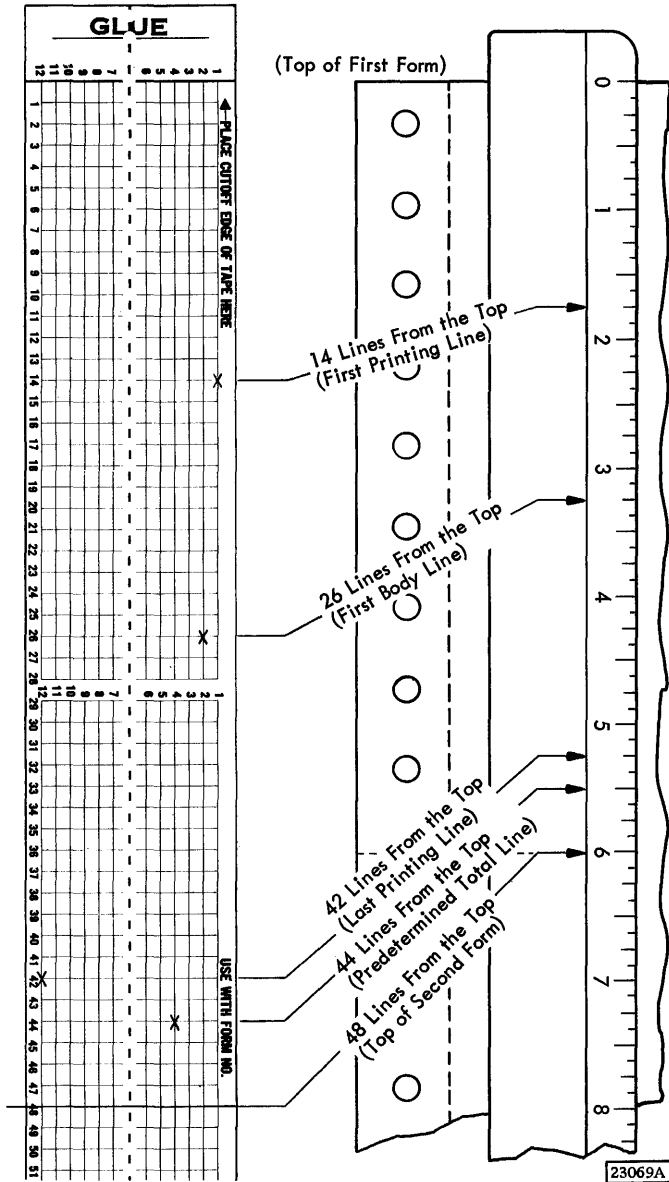

A carriage control tape has 12 vertical channels, numbered 1 through 12 from right to left. When designated by the program, channels 1 through 6 stop the form on specific printing lines, and channels 9 and 12 sense the location of the form for overflow. Channels 7, 8, 10, and 11 are not used. Channel 1 is normally used for the first printing line of a form. If channel 1 is used, the carriage automatically skips to this channel as a home position when the carriage restore key is pressed.

Although the carriage control tape is designed for six-lines-per-inch spacing, it can control eight-lines-per-inch spacing. Each 1/6-inch line on the tape represents each 1/8-inch line on the form, or each line on the tape represents one line on the form. Therefore, in planning a tape for an eight-lines-per-inch document, count to each corresponding position on the form and on the tape rather than aligning the tape next to the form. Since a maximum of 132 tape lines is usable, six-lines-per-inch spacing accommodates one or more forms totaling 22 inches, or eight-lines-per-inch spacing accommodates one or more forms totaling 16-1/2 inches.

Prepunched, round feed holes are in the center of the tape for the pin feed drive on the tape sensing mechanism.

Marking the Tape for Punching

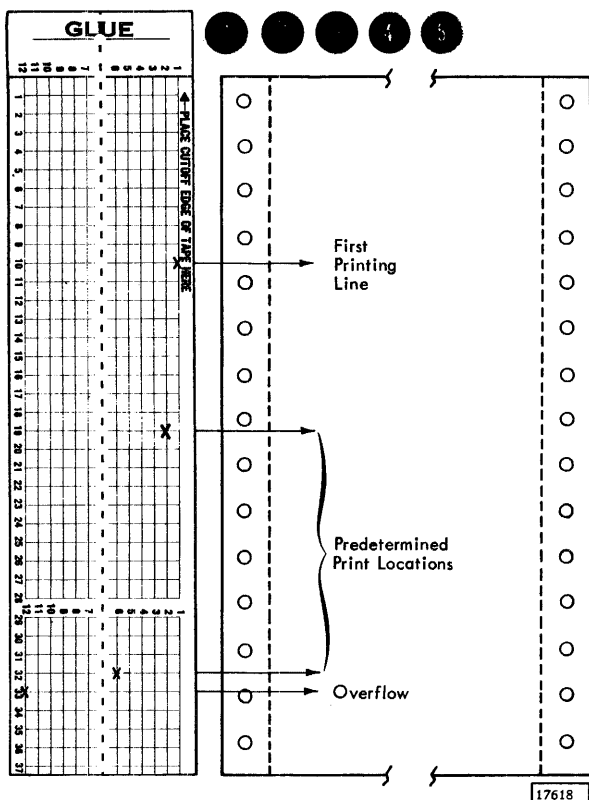

1. Lay the tape next to the left edge of the form, with the line immediately under the glue portion even with the top edge of the form.
2. Mark tape channel 1 on the line that corresponds to the first printing line on the form.
3. Mark one tape channel for each of the additional skip stops required. The tape should never be punched in more than one channel on the same line. Also (for efficiency), holes in the same channel should be at least two lines apart on the 1403 and four lines apart on the 1132.
4. Mark channel 9 and 12 for the last printing line on the form if an overflow is required.
5. Repeat steps 2 through 4 for as many additional forms as will fit in the 132 line spaces usable on the tape. When the tape controls several forms in one revolution through the carriage, the life of the tape increases.

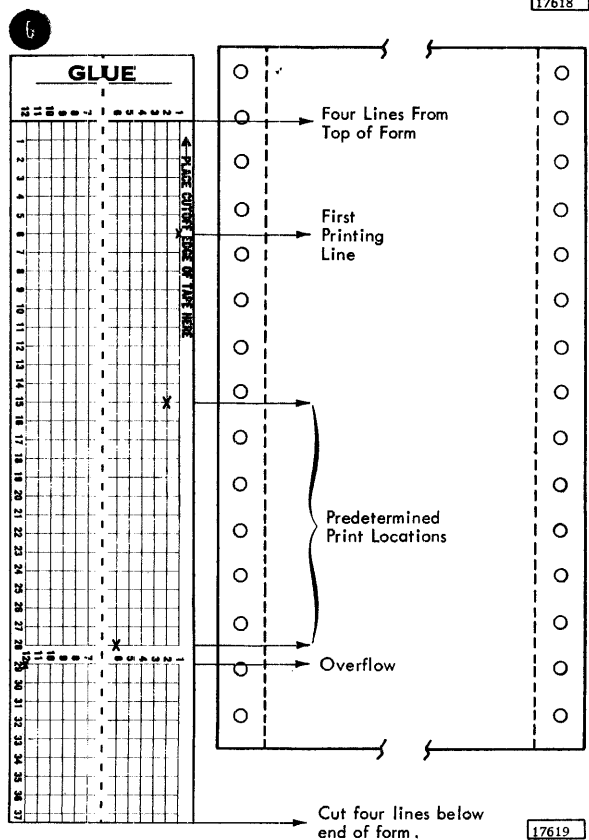

6. Mark the tape for cutting on the line corresponding to the bottom edge of the last form. The cut edge should be at least four lines from the last punched hole in the tape because the last half-inch of the tape overlaps the glue section when the two ends are joined.

Note: If it is necessary to punch a hole lower than four lines from the bottom of the form, place the tape so that the top line of the tape is four lines lower than the top edge of the form, and then mark the channels. To compensate for this low placement, cut the tape four lines lower than the bottom edge of the last form.

Punching the Tape

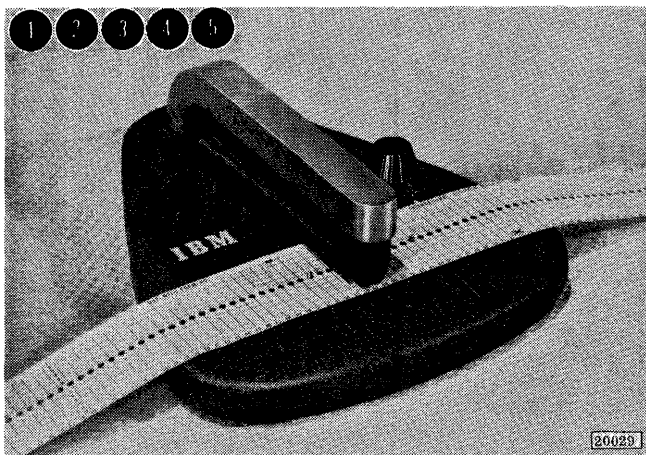

1. Insert the tape in the punch.
2. Position the horizontal line to be punched over the guide line on the base of the punch.
3. Place the center feed holes over the pins that project from the base.
4. Move the indicator slide until it points to the channel to be punched.
5. Press the top of the punch at the back. Doing so cuts a rectangular hole at the intersection of the vertical (channel) and horizontal lines.

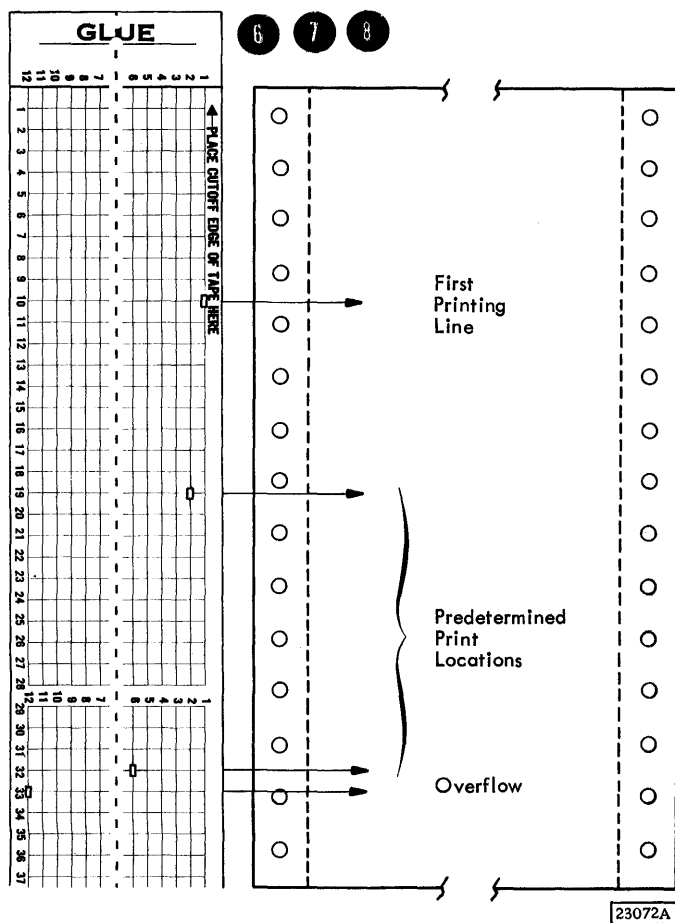

6. Repeat steps 1 through 3 for each mark on the tape.
7. Cut the tape on the line marked for the bottom edge of the last form.
8. Loop the tape and glue the bottom end to the top section, marked "glue". Be sure that the bottom edge lines up with the first line and that the center feed holes coincide.

APPENDIX B. USING THE MACHINE COVERS FOR SAFETY

In addition to improving appearance, the covers of IBM machines have been designed to safeguard personnel against possible injury during operation. While some hazards (such as moving mechanical parts) are obvious, others are not. Electrical potentials and acoustical noise are in the latter category.

While IBM maintains vigorous attention to safety on all of its machines, the effectiveness of safeguards is decreased by failure to keep the covers closed when running.

The frames of all IBM equipment have been made electrically safe by recommended grounding

practices, and the covers have been designed to reduce noise below any possible hearing damage level. Operation with the covers open, however, causes needless exposure to these unseen hazards. Because of this fact, IBM strongly recommends that all personnel associated with the equipment follow the simple safety-first procedure of keeping the covers closed whenever the machine is operating. In addition to the safety aspects of this procedure, the visual and aural environments of the installation are significantly enhanced.

APPENDIX C. RELATED LITERATURE

1. Disk Pack and Cartridge Handling Procedures, A26-5756.

This manual provides suggested operating and handling procedures for this unique data processing device.

2. 1130 Bibliography, A26-5916.

This three-part bibliography indexes and abstracts basic reference literature for planning, installing, programming, and operating the IBM 1130 Computing System.

3. 1130 Card/Paper Tape Programming Systems -- Operator's Guide, C26-3629.

This publication provides the information necessary to operate the IBM 1130 card and paper tape programming systems: FORTRAN compiler, assembler and compressor, subroutine library, and utility programs. Primarily intended for the machine operator, the manual describes the loading and restarting procedures for the programming systems in detail.

4. 1130 Component Description -- 2250 Display Unit, Model 4, A26-2723.

This publication contains detailed information about the IBM 2250 Display Unit, Model 4, programming, operations, and special features. The material is presented with the assumption that the reader has read the IBM 1130 Functional Characteristics, Form A26-5881.

5. 1130 Disk Monitor System -- Reference Manual, C26-3750.

This publication describes the 1130 disk monitor, a combined operating and programming system.

6. 1130 Disk Monitor System, Version 2, Programming and Operator's Guide, C26-3717.

This manual contains the operating and maintenance procedures for the IBM 1130 Disk Monitor System, Version 2. An introductory section acquaints the user with the IBM 1130 system. A section on programming tips and techniques assists the user in utilizing the monitor system.

7. 1130 Functional Characteristics, A26-5881.

This manual provides basic programming and operating information for the 1130 Computing System. The functional aspects of the system are explained in detail, and the operational characteristics are described in terms of program instructions, input/output operations, and central processing unit console displays and functions. Intended as a reference manual, the material presented assumes some prior knowledge of stored-program computers.

8. 1130 System Summary, A26-5917.

The System Summary presents a brief introduction to the IBM 1130 Computing System, including system concepts, components, and programming systems. Intended as a general overall picture of the 1130, the manual helps the reader gain a basic understanding of the system and its use.

9. 2501 Card Reader, Models A1 and A2 -- Component Description and Operating Procedures, A26-5892.

The operating principles and features of the IBM 2501 Models A1 and A2, as used with System/360 Model 20 Data Processing System or with the IBM 1130 Computing System, are described in this publication. Descriptions of keys, lights, program indicators, program instructions, and machine timings are included. Operator procedures are also described.

A

Accumulator: A register in which the result of an arithmetic or logical operation is formed.

Address:

1. An identification, as represented by a name, label, or number, for a register, location in storage, or other data source or destination.
2. Loosely, any part of an instruction that specifies the location of an operand for the instruction.

Address Register: A register that stores an address.

Alphameric:

1. A generic term for alphabetic letters, numerical digits, and special characters that are machine-processable.
2. A contraction of alphabetic-numeric.

Array: An arrangement or pattern of items.

Assemble: To prepare an object language program from a symbolic language program by substituting machine operation codes for symbolic operation codes and absolute or relocatable addresses for symbolic addresses.

Assembler: A program that assembles. See assemble.

Asynchronous: Pertaining to a lack of time coincidence in a set of repeated events. This term is applied to a computer to indicate that the execution of one operation is dependent on a signal that the previous operation is completed.

B

Backspace: To move one unit in the reverse or backward direction as opposed to moving one unit in the forward direction; e.g., to move back one record or file on an I/O device.

Binary:

1. Pertaining to a characteristic or property involving a selection, choice or condition in which there are two possibilities.
2. Pertaining to the number representation system with a base of 2.

Binary Code: A code that makes use of exactly two distinct characters, usually 0 and 1.

Binary Coded Character: One element of a notation system for representing alphameric characters such as decimal digits, alphabetic letters, punctuation marks, etc., by a fixed number of consecutive binary digits.

Binary Digit: A character used to represent one of the integers smaller than the radix 2.

Bit: An abbreviation of binary digit. See binary digit.

Blank Character: A character used to produce a character space on an output medium.

C

Card:

1. A machine-processable information storage medium of special-quality paper stock, generally 7-3/8 x 3-1/4 inches.
2. An internal pluggable unit for printed-circuits wiring and components.

Card Code: The combinations of punched holes that represent characters (letters, digits, etc.) in a punched card.

Card Column: One of the vertical lines of punching positions on a punched card.

Card Hopper: A mechanism which holds cards preparatory to feeding.

Card Image: A one-to-one representation of the contents of a punched card; e.g., a matrix in which a 1 represents a punch and a 0 represents the absence of a punch.

Card Punch: A device to record information in cards by punching holes in the cards to represent letters, digits, and special characters.

Card Reader: A device that senses and translates into internal form the holes in punched cards.

Card Row: One of the horizontal lines of punching positions on a punched card.

Card Stacker: A mechanism that stacks cards in a pocket after they pass through a machine.

Carriage Return: The operation that causes printing to be returned to the left margin with or without line advance.

Cathode-Ray Tube: A vacuum tube used as a storage or a visual display device.

Central Processing Unit: The unit of a computing system that contains the circuits that control and perform the execution of instructions.

Chad: That piece of material removed in punching a hole in perforated tape.

Chadded Tape: Perforated tape with the chad completely removed.

Chadless Paper Tape: A paper tape with the holes partially punched. It is commonly used in teletype operations and when printing is to be done on the surface of the tape as it is punched.

Chain Printer: A high-speed printer in which the type slugs are carried by the links of a revolving chain.

Channel:

1. A path along which signals can be sent; e.g., data channel, output channel.
2. The portion of a storage medium that is accessible to a given reading station; e.g., track, band.
3. A unit that controls the operation of one or more I/O units.

Character: One of a set of elementary signals that may include decimal digits 0 through 9, the letters A through Z, punctuation marks and any other symbols acceptable to a computer for reading, writing, or storing.

Character Printer: A printer in which only a single character is composed and determined within the device prior to printing.

Character Reader: An input device which reads printed characters directly from a document.

Character Recognition: The act of reading, identifying, and decoding a printed character by optical or other means.

Character Set: A list of characters acceptable for coding to a specific computer or input/output device.

Check:

1. To examine or test for accuracy or for precision.
2. An error.

Chip: That piece of card removed in punching a hole.

Clock:

1. A device that generates periodic signals used for synchronization.
2. A device that measures and indicates time.

Code:

1. The assignment of meaning to a character or group of characters; e.g., an alphabet.
2. A label to identify a routine, location, operator, operand, name, etc.
3. A machine-language program.

Column:

1. A vertical arrangement of characters or other expressions.
2. Loosely, a digit place.

Command: An instruction in machine language.

Communication: The process of transferring information from one point, person, or equipment to another.

Compile: To prepare an object language program from a program written in another programming language by performing the usual functions of an assembler and also making use of the overall logical structure of the program or generating more than one machine instruction for each symbolic statement, or both.

Compiler: A program that compiles. See compile.

Component: A basic part. An element.

Computer:

1. A device capable of solving problems by accepting data, performing prescribed operations on the data, and supplying the results of these operations. Three types of computers are calculator, digital computer, and analog computer.
2. In information processing, usually an automatic stored-program computer.

Computer Instruction: A machine instruction for a specific computer.

Computer Program: A plan or routine for solving a problem on a computer. Contrasted with such terms as fiscal program, military program, and development program.

Computing: A generic term for all mathematical and logical operations carried out according to precise rules of procedure.

Console: That part of a computer which is used for communication between the operator or service engineer and the computer.

Core Storage: A form of high-speed storage using magnetic cores.

CPU: See central processing unit.

Cycle:

1. An interval of space or time in which one set of events or phenomena is completed.
2. Any set of operations that is repeated regularly in the same sequence. The operations may be subject to variations of each repetition.

Cycle Steal: The ability of a central processing unit or processor-controller to delay the execution of a program to allow communication of an input/output device with core storage without changing the logical condition of the central processing unit or processor-controller.

D

Data: Any representation, such as characters or analog quantities, to which meaning might be assigned.

Data Processing: A systematic sequence of operations performed on data.

Data Processing System: A network of machine components capable of accepting information, processing it according to a plan, and producing the desired results.

Device:

1. That which is devised, invented or formed by design.
2. A mechanical contrivance or appliance.

Digit: One of the ideographic characters 0, 1 . . . 9 used to designate a quantity smaller than N for a base N number system.

Disable:

1. Suppression of an interrupt feature.
2. Render inoperative.

Disk: A physical element of disk storage.

Disk Storage: A storage device which uses magnetic recording on flat rotating disks.

Display: A visual presentation of data.

Display Tube: A tube, usually a cathode-ray tube, used to display data.

Document: A medium and the information recorded on it for human use; e.g., a report sheet, pages in a book, etc.

Drum Storage: A storage device that uses magnetic recording on a rotating cylinder. A type of addressable storage associated with some computers.

E

Echo Check: A method of checking the accuracy of transmission of data in which the received data is returned to the sending end for comparison with the original data.

Enable:

1. Restoration of a suppressed interrupt feature.
2. To permit.

Error:

1. A general term to indicate that a data value is not correct or that a machine component is malfunctioning.
2. A specific term for the amount of loss in precision.

Execute: To carry out an instruction or perform a routine.

F

Feed Holes: Holes punched in a tape to enable it to be driven by a sprocket wheel.

Fixed Point: Pertaining to a number system in which the location of the point is fixed with respect to one end of the numerals, according to some convention.

FORTTRAN (formula translating system):

1. A data processing language that closely resembles mathematical language.
2. Pertaining to a computer program that translates a FORTRAN language program into a machine-language program.

H

Hexadecimal Number System: A number system using the equivalent of the decimal number 16 as a base.

Hopper: A device that holds cards and makes them available to a card feed mechanism. Synonymous with input magazine. Contrast with card stacker.

I

Image: An exact logical duplicate stored in a different medium.

Index Register: A register whose content is added to or subtracted from the operand address prior to or during the execution of an instruction.

Input:

1. The data to be processed.
2. The state or sequence of states occurring on a specified input channel.
3. The device or collective set of devices used for bringing data into another device.
4. A channel for impressing a state on a device or logic element.
5. The process of transferring data from an external storage to an internal storage.
6. Pertaining to any entities such as are cited above.

Input/Output:

1. Commonly called I/O, a general term for the equipment used to communicate with a computer.
2. The data involved in such communication.
3. The media carrying the data for input/output.

Instruction: A statement that specifies an operation and the values or locations of all operands. In this

context, the term instruction is preferable to the terms command or order, which are sometimes used as synonyms. Command should be reserved for electronic signals. Order should be reserved for sequence, interpolation, and related usage. Both command and order have important military applications.

Instruction Register: A register that stores an instruction for execution.

Interface:

1. A shared boundary.
2. A shared boundary connecting logic between devices.

Interrupt:

1. A break in the normal flow of a system or routine such that the flow can be resumed from that point at a later time. An interrupt is usually caused by a signal from an external source.
2. To cause an interrupt.

I/O: See input/output.

K

Key:

1. That part of a word, record, file, etc., by which it is identified or controlled.
2. To code information.
3. A controlling switch.

Keyboard: A device for the encoding of data by key depression that causes the generation of the selected code element.

Keypunch: A keyboard-operated device that punches holes in a card to represent data.

L

Language:

1. A defined set of characters that are used to form symbols words, etc., and the rules for combining these into meaningful communication; e.g., English, French, ALGOL, FORTRAN, or COBOL.
2. A combination of a vocabulary and rules of syntax.

Letter: An alphabetic character used for the representation of sounds in a spoken language.

Line Printer: A printer in which an entire line of characters is composed and determined within the device prior to printing.

Load: To place data into internal storage.

Logic: The science which deals with the basic principles and applications of truth tables, switching, gating, machine diagrams, electronics, etc.

Logical Instruction: An instruction that carries out a logical operation, such as AND, OR, or NOR.

M

Machine Instruction: An instruction that the particular machine can recognize and execute.

Machine Language: A language that is used directly by a given machine.

Machine Operator: The person who manually controls a machine.

Manual Operation: Processing of data in a system by direct manual techniques.

Microsecond: One millionth of a second.

Millimicrosecond: See nanosecond.

Millisecond: One thousandth of a second.

Monitor: To control the operation of several unrelated routines and machine runs so that the compute and computer time are used advantageously.

Multiplexing: The interleaved or simultaneous transmission of two or more messages for a single channel.

Mylar: A DuPont trademark for polyester film often used as a base for magnetically coated or perforated information media.

N

Nanosecond: One thousand millionth of a second.

O

Off-Line: Pertaining to peripheral equipment or devices not in direct communication with the central processing unit of a computer.

On-Line: Pertaining to peripheral equipment or devices in direct communication with the central processing unit of a computer.

Operating System: An organized collection of techniques and procedures for operating a computer.

Operation:

1. A defined action; namely, the act of obtaining a result from one or more operands in accordance with a rule that completely specifies the result for any permissible combination of operands.
2. The set of such acts specified by such a rule or the rule itself.
3. The act specified by a single computer instruction.
4. A program step undertaken or executed by a computer; e.g., addition, multiplication, extraction, comparison, shift, or transfer. The operation is usually specified by the operation part of an instruction.
5. The event or specific action performed by a logic element.

Operator:

1. In the description of a process, that which indicates the action to be performed on operands.
2. A person who operates a machine.

Optical Scanning: A technique for machine recognition of characters by their images.

Output:

1. That data that has been processed.
2. The state or sequence of states occurring on a specified output channel.
3. The device or collective set of devices used for taking data out of a device.
4. A channel for expressing a state on a device or logic element.
5. The process of transferring data from an internal storage to an external storage.
6. Pertaining to any entities such as are cited above.

Overflow:

1. That portion of data that exceeds the capacity of the allocated unit of storage.
2. Pertaining to the generation of overflow as in 1.

Overlay: The technique of repeatedly using the same blocks of storage during different stages of a problem.

e.g., when one routine is no longer needed in internal storage, another routine can replace all or part of that storage.

P

Paper Tape Reader: A device which senses and translates the holes in perforated tape into internal form.

Parity Check: A check which tests whether the number of 1's (or 0's) in an array or binary digits is odd or even.

Perforated: A more suitable word to use in combination with paper tape than the word punched; e.g., perforated tape includes punched paper tape.

Pinfeed Platen: A cylindrical platen which drives the paper by means of integral rings of pins engaging perforated holes, rather than pressure.

Platen: A backing, commonly cylindrical, against which printing mechanisms strike to produce an impression.

Plot: To map or diagram, to connect the point-by-point coordinate values.

Print Wheel: A single element providing the character set at one printing position of a wheel printer.

Printer: A device which expresses coded characters as hard copy.

Program:

1. The plan for the solution of a problem, including data gathering, processing and reporting.
2. A group of related routines which solves a given problem.
3. To plan the method of attack for a defined problem.

Programmer: One who prepares programs for a computer.

Programming: The art of reducing the plan for the solution of a problem to machine-sensible instructions.

Programming Language: A language used to prepare computer programs.

Punched Card:

1. A card punched with a pattern of holes to represent data.
2. A card as in 1, before being punched.

Punched Tape: A tape on which a pattern of holes or cuts is used to represent data.

R

Radix: A quantity whose successive integral powers are the implicit multipliers of the sequence of integers that represent a number. For example, if the base is 5, then 1432 is 1 times 5 to the 3 plus 4 times 5 to the 2 plus 3 times 5 to the 1 plus 2 times 5 to the 0 which is equivalent to 242 in the decimal representation system.

Random Access: Pertaining to the process of obtaining data from, or placing data into, storage when there is no sequential relation governing the access time to successive storage locations.

Read:

1. To transcribe information from an input device to internal or auxiliary storage.
2. To acquire data from a source.

Reader: A device which converts information in one form of storage to information in another form of storage.

Register: A device capable of storing a specified amount of data, such as one word.

Reset:

1. To restore a storage device to a prescribed initial state, not necessarily that denoting 0's
2. To place a binary cell into the 0 state.

Restart: To return to a previous point in a program and resume operation from that point.

Run: A single, continuous performance of a computer or device.

S

Single-Step: Pertaining to a method of operating a computer in which each step is performed in response to a single manual operation.

Space:

1. A place intended for the storage of data; e.g., a place on printed page or a location in a storage medium.
2. A basic unit of area on a record, i.e., an area that may not contain more than one printed character.
3. One or more blanks.
4. To move from one place to another according to a prescribed format; e.g., to move horizontally to the right on a printed page or vertically down a page.

Stacker: See card stacker.

Statement: In computer programming, a meaningful expression or generalized instruction in a source language.

Storage:

1. Pertaining to a device into which data can be entered and from which it can be retrieved at a later time.
2. Loosely, any device that can store data.

Storage Capacity: The amount of data that can be contained in a storage device.

Storage Device: A device into which data can be inserted, in which it can be retained, and from which it can be retrieved.

Storage Register: A device for holding a unit of information.

System:

1. A collection of consecutive operations and procedures required to accomplish a specific objective.
2. An assembly of objects united to form a functional unit.

T

Tape: A linear medium for storing information that can be used as input or output to a computer; e.g., magnetic tape.

Tape-Controlled Carriage: An automatic paper-feeding carriage controlled by a punched paper tape.

V

Validity Check: A check for accuracy of character representation.

Vector: A line denoting magnitude and direction, as contrasted with a scalar, denoting magnitude only.

ABL (Enable) Indicator (1131)	14
Accumulator Extension Indicator (1131)	13
Accumulator Indicator (1131)	13
Acoustical Dampener (1403)	46
Acoustical Noise	78
AC Indicator (1131)	14
ADD Indicators	14
Advance Key (2254)	67
AS Indicator (1131)	14
Alarm On/Off Switch (1131)	16
All Input/Output Devices	3
Alphameric Keyboard (2250)	67
ALTN Coding Key (2250)	67
Arithmetic and Logical Instructions	4
Arithmetic Factor Indicator (1131)	13
Assembler	1
Assembling the Pen (1627)	64
Attention Light (2501)	72
Backspace Key (1131)	19
Backspace Key (2250)	67
BFR (Buffer Loaded) Indicator (1131)	14
Bibliography	79
Blank Forms	2
Brightness Control (2250)	69
Brush Commutator (1132)	29
Brush Holder (1132)	29
Brush INLK (Interlock) Light (1403)	47
Brushes (1132)	29
Cancel Key (2250)	67
Cap (1627)	64
Card Punch Operators	1
Card Punch, Model 5, 1442	7, 54
Card Read Punch, Models 6 and 7, 1442	2, 8, 54
Card Reader, 2501	72
Card Weight	55, 73
CARR (Carriage) Fuse Light (1403)	47
Carriage Control Tape	75
Eight-Lines-Per-Inch Spacing	75
Marking	76
Punching	77
Six-Lines-Per-Inch Spacing	75
Carriage	
Fast Run Switch (1627)	60
Restore Key (1132)	28
Single Step Switch (1627)	60
Space Key (1132)	28
Stop Key (1132)	28
Stop Key (1403)	44
Cartridge Spindles (1131)	23
Cartridge Unlocked Lights (2310)	70
CE (Customer Engineer) Mode On/Off Toggle Switch (1131)	18
Central Processing Unit, 1131	2, 3, 4, 12
Changing the Disk Storage Cartridge (2310)	70
Changing the Interchangeable Cartridge (1403)	53
Changing the Ribbon (1403)	49
Chart Drive On/Off Switch (1627)	61
Chart Paper (1627)	60
Check Light (1442)	54
Check Sheet, 1130 Console	80
Checking A Not-Ready Condition (1134)	40
Checking Not-Ready Conditions (1055)	27
Checking the Plotter Operation (1627)	65
Chip Box Light (1442)	54
CLK (Clock Running) Indicator (1131)	14
Collators	2
Compiler	1
Compilers	2
Computing System, 1130	3
Condition Register Indicator (1131)	14
Console	
Check Sheet	80
Control Panel	2
Display Panel (1131)	13
Entry Switches (1131)	12
Function Switches and Lights (1131)	15
Keyboard (1131)	19
Mode Switch (1131)	17
Typewriter (1131)	2
Continue Key (2250)	67
Control Program	2
Control Timing Marks Switch (1231)	41
Counters	4
Covers	78
CP (Character Phase) Indicator (1131)	14
Cycle Control Counter Indicator (1131)	14
Daily Schedule	1
Data Entry	4
Delete Key (1055)	24
DI (Data In) Indicator (1131)	14
Disk Cartridge, 2315	4, 70
Disk Storage, 2310	4, 10, 11, 70
Disk Units	2
Disk Unlock Light (1131)	16
Display Storage (1131)	17
Display Unit (See 2250)	67
Drum Fast Run Switch (1627)	60
Drum Single Step Switch (1627)	60
Electrical Potentials	78
Element Post (1131)	22
Element Release Lever (1131)	22
Emergency Pull Switch (1131)	16
Emptying the Chad Box (1055)	27
Enable/Disable Switch (1133)	37

Enable/Disable Switch (2310) 70
 Enable Indicator (1131) 14
 End-of-Field Key (1131) 19
 End-of-Form Stop (1132) 31
 End-of-Forms Light (1403) 44
 End Key (2250) 67
 Erase Field Key (1131) 19
 Error Detection 2
 Error Messages 1
 External Documents 3
 E1 Cycle Indicator (1131) 13
 E2 Cycle Indicator (1131) 13
 E3 Cycle Indicator (1131) 13

Feed
 Check Error (1442) 58, 59
 Check Light (1231) 42
 Check Light (2501) 72
 CLU (Clutch) Light (1231) 54
 Clutch (1403) 45, 48
 Cycle Error (1442) 58
 Key (1055) 24
 Mode Switch (1231) 41
 Pins (1132) 36
 Punch Check (1442) 59
 Read Registration (1442) 59
 Transport (1442) 58
 File On/Off Switch (1131) 18
 File Ready Light (1131) 16
 Fixed-Point Binary Form 4
 Forms Check Light (1131) 16
 Forms Check Light (1132) 28
 Forms Check Light (1403) 44
 Forms, Inserting (1132) 34
 Forms, Inserting (1403) 50
 Forms Stop Arms (1132) 35
 Forms Thickness Adjustment Lever (1132) 30
 Forms Tractor, Installing (1132)
 FORTRAN Pause 14

Gate INTLK (Interlock) Light (1403) 47
 Glossary 81
 Grounding 78
 Guide Pin (1055) 25

Handwheel (1442) 56
 Handwheel (2501) 74
 Heads Loaded Lights (2310) 70
 Holder (1627) 64
 Hopper (1442) 58
 Hopper (2501) 73
 Hopper Misfeed Error (1442) 57
 HOPR (Hopper) Light (1442) 54
 HS (High Speed) Start Light (1403) 47
 HS (High Speed) Stop Light (1403) 47

IBM-Supplied Programs 2
 IMM (Immediate) Stop Switch (1131) 15
 Index Register Indicator (1131) 14

Index Registers (1131) 4
 Indicators, P1 and P2 (1131) 13
 Inner Cylinder (1055) 25
 Input/Output 4
 Devices 2
 Interrupts 3
 Operations 2, 3

Inserting
 Carriage Control Tape (1132) 31
 Carriage Control Tape (1403) 47
 Forms (1442) 50
 Forms (1132) 34
 Paper Tape (1055) 24
 Tape (1134) 38

Installing
 Fabric Ribbon Cartridge (1131) 23
 Forms Tractor (1132) 33
 Roll of Graph Paper (1627) 61
 Sheet of Graph Paper (1627) 62
 Instruction Address Indicator (1131) 13
 Instructions 4
 Interchangeable Cartridge, Installing (1403) 53
 Interrupt Levels Indicator (1131) 14
 Interrupt Request Key (1131) 19
 Interrupt Run Setting (1131) 17
 IA Cycle Indicator (1131) 13
 IX Cycle Indicator (1131) 13
 I1 Cycle Indicator (1131) 13
 I2 Cycle Indicator (1131) 13

Jammed Cards, Removing (1442) 55
 Joggler Gate 55, 73
 Jump Key (2250) 67

KB Select Light (1131) 16
 Key (1627) 64
 Keyboard 4
 Keyboard Console/Keyboard Switch (1131) 15
 Keyboard/Printer Console 4
 Keyboard, Alphameric (2250) 67
 Keyboard, Console (1131) 19
 Knurled Nut (1627) 64

Latch (1132) 29
 Lateral Adjustment Hand Wheel (1132) 30
 Lateral Print Vernier Knob (1403) 45
 Left Hinged Pressure Plate (1132) 35
 Left Locking Ring (1132) 35
 Left Paper Guide (1132) 35
 Lift Lever Handle (1134) 38
 Light Pen (2250) 68
 Lines per Inch Adjustment (1132) 30
 Literature, Related 79
 Load and Store 4
 Load IR (Instruction Register) Switch (1131) 15
 Load Storage (1131) 17
 Lock Key (2250) 67
 Lower Paper Guides (1132) 35
 Lower Punch Guide (1442) 56

Machine Covers 78
Main Storage 4
Manual Controls (1132) 29
Manual Controls (1403) 45
Margin Scale (1131) 20
Master Mark (1231) 41
Metal Eyelet (1132) 36
Multi Mark Setting (1231) 41
Motor On/Off Switch (1132) 28
Multiple Response Switch
Multiple Response Select Uncertainties 41
Multiplex Control Enclosure, 1133 5, 37

No Mark Setting (1231) 41
Notched Bar (1132) 29
Notched Bar Lever (1132) 29
NPRO (Non-Process Runout) Key (2501) 72
NPRO (Non-Process Runout) Key (1442) 55
Number Key (1131) 19

Object Programs 2
Off-Line 2, 4
Off-Setting (1231) 41
On-Line 2, 4
Operation Flags Indicator 14
Operation Register Indicator 14
Operations Manager 1
Operator 1, 2
Optical Mark Page Reader (See 1231) 41
Other Than One Setting (1231) 41
Outer Cylinder (1055) 25
Outfold Guide Bar (1132) 31, 35, 36
Overrun Light (1442) 54

Paper Advance Knob (1403) 45, 51
Paper Pressure Rod (1131) 20
Paper Release Lever (1131) 20
Paper Tape 3
Paper Tape Punch (See Also 1055) 5, 24
Paper Tape Reader, 1134 (See Also 1134) 6, 38
Paper Tension Control (1132) 31, 35
Parity Check Light (1131) 16
Pen (1627) 64
Pen Up/Down Switch (1627) 60
Plastic Card Guide (1442) 56
Plastic Card Guide (2501) 74
Platen Bearing Housing (1132) 30
Platen Clutch Knob (1132) 29
Platen Lock (1132) 30
Platen Pin Feed Pressure Plate (1131) 20
Platen Pressure Roll Release Lever (1132) 30, 35
Platen Space Knob 29
Plotter (See 1627)
Plunger (1627) 64
Power On Light
 1132 28
 1442 54
 1627 60
 2501 72
Power On/Off Switch (1627) 60
Power On/Off Switch (1131) 15
Power On/Power Off Light (1231) 42
Pressure Plate 31, 35
Pressure Platen Rolls (1132) 35
Print
 Check Light (1403) 44
 Density Lever (1403) 45
 Line Indicator (1403) 49
 Scan Check Light (1132) 28
 Timing Dial 46
 UN POS Light 47
 Unit Release Lever 46, 49
 Wheels 36
Printer, 1403 (See Also 1403) 2, 44
Printer, 1132 (See Also 1132) 2, 5, 6
PROC (Process) Check Light (1231) 42
Program 1
 Control 4
 Load Light (1231) 42
 Load Switch (1131) 15
 Run Setting (1131) 17
 Start Switch (1131) 15
Programmed Function Keyboard (2250) 68
Programmed Function Keyboard Overlay (2250) 69
Programmer 1
Programming System 2
Punch Check Error (1442) 59
Punch Die (1055) 25
Punch Feed Release Lever (1442) 56
Punch Station (1442) 55, 58
Punched Cards 3
P1 and P2 Indicators (1131) 13

RDY (Ready) Indicator (1131) 14
Re-Feed SEL DOC (Refeed Selected Document) Light (1231) 42
Read
 Capstan (1134) 38
 Light (1231) 42
 Mode Switches (1231) 41
 REG (Registration) Light (1442) 54
 Registration Error (1442) 59
 Station (1442) 58
Ready Light (1133) 37
Ready Light (1442) 54
Ready Light (2501) 72
Readying The
 Console Printer (1131) 20
 Disk Storage Drive (1131) 21
 IBM 1130 Computing System 19
 1231 42
 1442 57
 2501 74
REC (Receive) Indicator (1131) 14
Registers 4
Related Literature 79
Removing A Fabric Ribbon Cartridge (1131) 23
Removing A Typing Element (1131) 22
Removing Jammed Cards (1442) 55
Removing Jammed Cards (2501) 73

Replacing A Ribbon (1132) 36
 Replacing A Typing Element (1131) 22
 Reproducurs 2
 Reset Switch (1131) 15
 Restarting The 1442 57
 Restore Keyboard (1131) 19
 Return (1131) 20
 Rewinding Tape (1134) 39
 Ribbon
 Cartridge (1131) 23
 Correction Roll (1403) 50
 Changing A (1403) 49
 Guide (1132) 36
 Replacing A (1132) 36
 Reverse Lever (1132) 36
 Reversing Bars (1403) 50
 Reversing Lever (1403) 50
 Shield (1403) 50
 Spool (1132) 36
 Right Locking Ring (1132) 31, 35
 Right Paper Guide (1132) 35
 Right-Hand Tractor Vernier Knob (1403) 45, 51
 Round Rod (1132) 35
 Run Book 1
 Run Light (1131) 16

 Safety 78
 SC Indicator (1131) 14
 Segment Setting (1231) 41
 Shift Key (2250) 67
 SING RESP Switch (1231) 41
 Single Cycle Pushbutton Switch (1131) 18
 Single Disk Storage Panel (1131) 18
 Single Instruction Setting (1131) 17
 Single Memory Cycle Setting (1131) 17
 Single Response Select Uncertainties (1231) 41
 Single Step Setting (1131) 17
 Single-Disk Storage Drive 4
 Single-Word or Double-Word Instruction 4
 Sorters 2
 Source Program Deck 1
 Source Programs 2
 Space/Mark Toggle Switch (1131) 18
 Splicing Tape (1055) 27
 Stackers (1442) 58
 Start Key
 1132 29
 1403 44
 1442 54
 2501 72
 Stop Key (1132) 29
 Stop Key (1442) 55
 Stop Key (2501) 72
 Storage Access Channel 4, 14
 Storage Address Indicator (1131) 13
 Storage Buffer Indicator (1131) 13
 STR/BSC (Sync Trans Rec/Binary Sync Comm)
 Toggle Switch (1131) 18
 Supply Reel (1134) 38
 Supply Spool (1627) 60

 Sync Check Light (1403) 44
 System Stop Light (1403) 42
 Systems Analyst 1

 Tab (1131) 20
 Take-up Reel (1134) 38
 Take-up Spool (1627) 60
 Tape
 Guide (1055) 25
 Guides Half Circle (1132) 29
 Pressure Lever (1055) 24
 Tension Lever (1055) 25
 Tear Guide (1055) 25
 TC Indicator (1131) 14
 THER (Thermal) INLK (Interlock) Light (1403) 47
 Timing Mark Check Switch (1231) 41
 Top Ribbon Cover (1403) 49
 Tractor (1132) 31
 Tractor Adjustment Wheel (1132) 31
 Tractor Pins (1132) 35
 TRANS (Transport) Light (1442) 54
 Transport Error (1442) 58
 TSM (Transmit Mode) Indicator (1131) 14
 T0 through T7 Indicators (1131) 13

 Unmarked Lights and Keys (1132) 29

 Vernier Control Knob (1627) 61
 Vernier Knob (1132) 29
 Vertical Print Adjustment Knob (1403) 45

 W (Wait) Indicator (1131) 13

 X7 Indicator (1131) 13

 ZR Indicator (1131) 14
 1 through 8 Indicators (1131) 14

 1055 Paper Tape Punch, Model 1 5, 24
 Chad Box, Emptying The 27
 Checking Not-Ready Conditions 27
 Delete Key 24
 Emptying the Chad Box 27
 Feed Key 24
 Guide Pin 25
 Inner Cylinder 25
 Inserting Paper Tape 24
 Not-Ready Conditions, Checking 27
 Outer Cylinder 25
 Paper Tape, Inserting 24
 Punch Die 25
 Splicing Tape 27
 Tape Advance Wheel 24
 Tape Guide 25
 Tape Pressure Lever 24
 Tape Tension Lever 25

1055 Paper Tape Punch, Model 1 (Continued)

Tape, Splicing 27
Tear Guide 25

1130 Computing System 3, 19

1130 Console Check Sheet 80

1131 Central Processing Unit 4, 12

ABL (Enable) Indicator 14
AC Indicator 14
Accumulator Extension Indicator 13
Accumulator Indicator 13
ADD Indicator 14
Alarm On/Off Switch 16
Arithmetic Factor Indicator 13
AS Indicator 14
Backspace Key 19
BFR (Buffer Loaded) Indicator 14
CE (Customer Engineer) Mode On/Off Toggle Switch 18
CLK (Clock Running) Indicator 14
Condition Register Indicator 14
Console Display Panel 13
Console Entry Switches 12
Console Function Switches and Lights 15
Console Keyboard 18
Console Mode Switch 17
Console Printer, Readyng The 20
CP (Character Phase) Indicator 14
Customer Engineer Mode On/Off Toggle Switch 18
Cycle Control Counter Indicator 14
DI (Data In) Indicator 14
Disk Storage Drive, Readyng The 21
Disk Unlock Light 16
Display Core Storage 17
Element Post 22
Element Release Lever 22
Emergency Pull Switch 16
EOF (End of Field) Key 19
Erase Field Key 19
E1 Cycle Indicator 13
E2 Cycle Indicator 13
E3 Cycle Indicator 13
Fabric Ribbon Cartridge, Installing A 23
Fabric Ribbon Cartridge, Removing A 23
File On/Off Switch 18
File Ready Light 16
Forms Check Light 16
FORTRAN Pause 14
IMM (Immediate) Stop Switch 15
Index Register Indicator 14
Installing a Fabric Ribbon Cartridge 23
Instruction Address Indicator 13
INT REQ 19
Interrupt Levels Indicator 14
Interrupt Request Key 19
Interrupt Run Setting 17
IX Cycle Indicator 13
I1 Cycle Indicator 13
I2 Cycle Indicator 13
KB Select Light 16

1131 Central Processing Unit (Continued)

Keyboard Console/Keyboard Switch 15
Load Core Storage 17
Load IR (Instruction Register) Switch 15
Margin Scale 20
NUM (Number) Key 19
Operation Flags Indicator 14
Operation Register Indicator 14
Paper Pressure Rod 20
Paper Release Lever 20
Parity Check Light 16
Platen Pin Feed Pressure Plate 20
Power On/Off Switch 15
Program Load Switch 15
Program Run Setting 17
Program Start Switch 15
P1 Indicator 13
P2 Indicator 13
RDY (Ready) Indicator 14
Readyng the Console Printer 20
Readyng the Disk Storage Drive 21
REC (Receive) Indicator 14
Removing A Fabric Ribbon Cartridge 23
Removing A Typing Element 22
Replacing A Typing Element 22
Reset Switch 15
REST KB (Restore Keyboard) Key 19
Return 20
Ribbon Cartridge 23
Ribbon Cartridge Spindles 23
Run Light 16
SC Indicator 14
Single Cycle Pushbutton Switch 18
Single Disk Storage Panel 18
Single Instruction Setting 17
Single Memory Cycle Setting 17
Single Step Setting 17
Space/Mark Toggle Switch 18
Speed Selection Rotary Switch 18
Storage Address Indicator 13
Storage Buffer Indicator 13
STR/BSC (Sync Trans Rec/Binary Sync Com)
Toggle Switch 18
Tab 20
TC Indicator 14
TSM (Transmit) Mode Indicator 14
Typing Element, Removing A 22
Typing Element, Replacing A 22
T0 through T7 Indicators 13
W (Wait) Indicator 13
X7 Indicator 13
ZR Indicators 14
1 through 8 Indicators 14

1131 Central Processing Unit 3

1132 Printer 5, 6, 28

Brush Commutator 29
Brush Holder 29
Brushes 29
Carriage Control Tape, Inserting A 31
Carriage Restore Key 28

1132 Printer (Continued)

- Carriage Space Key 28
- Carriage Stop Key 28
- End of Form Stop 31
- Feed Pins 36
- First Printing Line Indicator 31
- Forms Check Light 28
- Forms, Inserting 34
- Forms Stop Arms 35
- Forms Thickness Adjustment Lever 30
- Forms Tractor, Installing 33
- Inserting a Carriage Control Tape 31
- Inserting Forms 34
- Latch 29
- Lateral Adjustment Handwheel 30
- Left Hinged Pressure Plate 35
- Left Locking Ring 35
- Left Paper Guide 35
- Lines per Inch Adjustment 30
- Lower Paper Guides 35
- Manual Controls 29
- Metal Eyelet 36
- Motor On/Off Switch 28
- Notched Bar 29
- Notched Bar Lever 29
- Outfold Guide Bar 31, 35, 36
- Paper Tension Control 31, 35
- Pen Feed Pressure Plate 36
- Platen Bearing Housing 30
- Platen Clutch Knob 29
- Platen Lock 30
- Platen Pressure Roll Release Lever 30, 35
- Platen Space Knob 29
- Power On Light 28
- Pressure Plate 31, 35
- Pressure Platen Rolls 35
- Print Scan Check Light 28
- Print Wheels 36
- Ready Light 28
- Refold Guides 35
- Ribbon
 - Guide 36
 - Replacing 36
 - Reverse Lever 36
 - Spool 36
- Right Locking Ring 31, 35
- Right Paper Guide 35
- Round Rod 35
- Shift Cam 35
- Start Key 29
- Stop Key 29
- Tape Guides Half Circle 29
- Tractor 31
- Tractor Adjustment Wheel 31
- Tractor Pins 35
- Unmarked Lights and Keys 29
- Vernier Knob 29

1133 Multiplex Control Enclosure 5, 37

- Enable/Disable Switch 37
- Ready Light 37

1134 Paper Tape Reader, Models 1 and 2 6, 38

- Capstan, Read 38
- Checking a Not-Ready Condition 40
- Inserting Tape 38
- Lift Lever Handle 38
- Not-Ready Condition, Checking A 40
- Read Capstan 38
- Rewinding Tape 39
- Supply Reel 38
- Take-up Reel 38
- Tape, Inserting 38
- Tape, Rewinding 39
- Tape, Tension Arms 38

1231 Optical Mark Page Reader, Model 1 6, 41

- Check Length Switches 41
- Control Timing Marks Switch 41
- Feed Check Light 42
- Feed Mode Switch 41
- Master Mark Switch 41
- MULTI Mark Switch 41
- MULTI RESP (Multiple Response) Switch 41
- Multiple Response Select Uncertainties 41
- NO MARK Switch 41
- Off Switch 41
- Other Than One 41
- Power On/Power Off Light 42
- PROC (Process) Check Light 42
- Program Load Light 42
- Re-Feed SEL DOC 42
- Read Light 42
- Read Mode Switches 41
- Readying The 1231 42
- Refeed Selected Document Light 42
- Reset Key 42
- Segment Setting 41
- SING RESP (Single Response) Switch 41
- Single Response Select Uncertainties Switch 41
- Start Key 42
- Stop Key 42
- System Stop Light 42
- Timing Mark Check Switch 41
- Word Setting 41
- 1231, Readying The 42

1403 Printer, Models 6 and 7 4, 44

- Acoustical Dampener 46
- Brush Holder Patch 48
- Brush INLK Light 47
- Carriage Control Tape, Inserting 47
- Carriage Fuse Light 47
- Carriage Restore Key 44
- Carriage Space Key 44
- Carriage Stop Key 44
- Carrier Control Idler 48
- Check Reset Key 44
- Clutch, Feed 45, 48
- End-of-Forms Light 44
- Feed Clutch 45, 48

1403 Printer, Models 6 and 7 (Continued)

Forms Check Light 44
 Gate INTLK Light 47
 HS (High Speed) Start Light 47
 HS (High Speed) Stop Light 47
 Horizontal Adjustment Knob 45
 Inserting Forms 50
 Interchangeable Cartridge, Changing 53
 Interlock Lights 47
 Lateral Print Vernier Knob 45
 Lever, Print Density 45
 Lever, Print Unit Release 46
 LS (Low Speed) Start Light 47
 Manual Controls, 1403 45
 Paper Advance Knob 45,51
 Print Chain 50
 Print Check Light 44
 Print Density Lever 45
 Print Line Indicator 49
 Print Ready Light 44
 Print Timing Dial 46
 Print UN (Unit) POS (Position) Light 47
 Print Unit Release Lever 46,49
 Ribbon, Changing 49
 Ribbon Correction Roll 50
 Ribbon Reversing Bars 50
 Ribbon Reversing Lever 50
 Ribbon Shield 49,50
 Right-Hand Tractor Vernier Knob 45,51
 Shift INLK Light 47
 Start Key 44
 Stop Key 44
 Sync Check Light 44
 THER (Thermal) INLK (Interlock) Light 47
 Top Ribbon Cover 49
 Vertical Print Adjustment Knob 45

1442 Card Read Punch, Models 5, 6, and 7 8,54

Card Capacity 8
 Card Guides 56
 Check Light 54
 Chip Box Light 54
 Errors
 Feed Check 58,59
 Feed Cycle 58
 Hopper 57
 Punch Check 59
 Read Registration 59
 Transport 58
 Feed Check Error 58,59
 Feed CLU (Clutch), Light 54
 Feed Cycle Error 58
 Handwheel 56
 Hopper 58
 Hopper Misfeed Error 57
 HOPR (Hopper) Light 54
 Jammed Card Removal 55
 Lower Punch Guide 56
 Machine Speeds 8
 Non-Process Runout Key 55
 NPRO 55
 Overrun Light 54
 Plastic Card Guides 56

1442 Card Read Punch, Models 5, 6, and 7 (Continued)

Power On Light 54
 Punch Check Error 59
 Punch Feed Release Lever 56
 Punch Guide, Lower 56
 Punch Station 55,58
 Read REG (Register) Light 54
 Read Registration Error 59
 Read STA (Station) Light 54
 Read Station 57,58,59
 Ready Light 54
 Readyng the 1442 57
 Restarting the 1442 57
 Setup, Machine 8
 Speeds, Machine 8
 Stackers 57,58,59
 Start Key 55
 (Station) Light, Read STA 54
 Stop Key 55
 TRANS (Transport) Light 54
 Transport Error 58
 1442, Readyng The 57
 1442, Restarting The 57

1627 Plotter, Models 1 and 2 8,9,60

Assembling The Pen 64
 Cap 64
 Carriage Fast Run Switch 60
 Carriage Single Step Switch 60
 Characteristics 9
 Chart Drive On/Off Switch 61
 Chart Paper 60
 Checking The Plotter Operation 65
 Drum Fast Run Switch 60
 Drum Single Step Switch 60
 Graph Paper, Installing 61,62
 Holder 64
 Installing a Roll of Graph Paper 61
 Installing a Sheet of Graph Paper 62
 Key 64
 Knurled Nut 64
 Paper, Chart 60
 Paper, Graph 61
 Pen 64
 Pen Up/Down Switch 60
 Pen, Assembling The 64
 Plotter Operation 65
 Plotter Operation, Checking The 65
 Plunger 64
 Power On Light 60
 Power On/Off Switch 60
 Supply Spool 60
 Take-Up Spool 60
 Vernier Control Knob 61

2250 Display Unit, Model 4 9,67

Advance Key 67
 Alphameric Keyboard 67
 ALTN Coding Key 67
 Backspace Key 67
 Brightness Control 69
 Cancel Key 67

2250 Display Unit, Model 4 (Continued)

Continue Key 67
Characteristics 9
End Key 67
Function Keyboard, Programmed 68
Jump Key 67
Keyboard Overlay, Programmed Function 69
Keyboard, Alphameric 67
Keyboard, Programmed Function 68
Light Pen 68
Lock Key 67
Overlay, Programmed Function Keyboard 69
Programmed Function Keyboard Overlay 69
Shift Key 67

2310 Disk Storage 4, 10, 11, 70

Cartridge Unlocked Lights 70
Changing The Cartridge 70
Enable/Disable Switch 70
Heads Loaded Lights 70
Lights, Cartridge Unlocked 70
Start/Stop Switches 70

2315 Disk Cartridge 4

2501 Card Reader 11, 72
Attention Light 72
Card Weight 73
Characteristics 11
Feed Check Light 72
Handwheel 74
Hopper 73
Jammed Cards, Removing 73
Joggler Gate 73
Non-Process Runout Key 72
NPRO 72
Plastic Card Guide 74
Power On Light 72
Read Check Light 72
Ready Light 72
Readying The 2501 74
Removing Jammed Cards 73
Start Key 72
Stop Key 72



International Business Machines Corporation
Data Processing Division
112 East Post Road, White Plains, N.Y. 10601
[USA Only]

IBM World Trade Corporation
821 United Nations Plaza, New York, New York 10017
[International]

READER'S COMMENT FORM

1130 Operating
Procedures

Form A26-5717-0

- How did you use this publication?

As a reference source
As a classroom text
As.....

- Based on your own experience, rate this publication...

As a reference source:
Very Good Fair Poor Very
Good Poor
As a text:
Very Good Fair Poor Very
Good Poor

- What is your occupation?

- We would appreciate your other comments; please give specific page and line references where appropriate. If you wish a reply, be sure to include your name and address.

● Thank you for your cooperation. No postage necessary if mailed in the U.S. A.

YOUR COMMENTS PLEASE . . .

This SRL bulletin is one of a series which serves as a reference source for systems analysts, programmers and operators of IBM systems. Your answers to the questions on the back of this form, together with your comments, will help us produce better publications for your use. Each reply will be carefully reviewed by the persons responsible for writing and publishing this material. All comments and suggestions become the property of IBM.

Please note: Requests for copies of publications and for assistance in utilizing your IBM system should be directed to your IBM representative or to the IBM sales office serving your locality.

fold

fold

FIRST CLASS
PERMIT NO. 2078
SAN JOSE, CALIF.

BUSINESS REPLY MAIL
NO POSTAGE STAMP NECESSARY IF MAILED IN U. S. A.

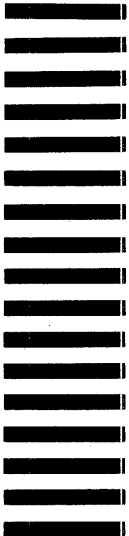

POSTAGE WILL BE PAID BY . . .

IBM Corporation
Monterey & Cottle Rds.
San Jose, California
95114

Attention: Product Publications, Dept. 455

fold

fold



International Business Machines Corporation
Data Processing Division
112 East Post Road, White Plains, N.Y. 10601
[USA Only]

IBM World Trade Corporation
821 United Nations Plaza, New York, New York 10017
[International]