

Pascal 3.1 Workstation System

Vol. I: Main Command Level and Subsystems

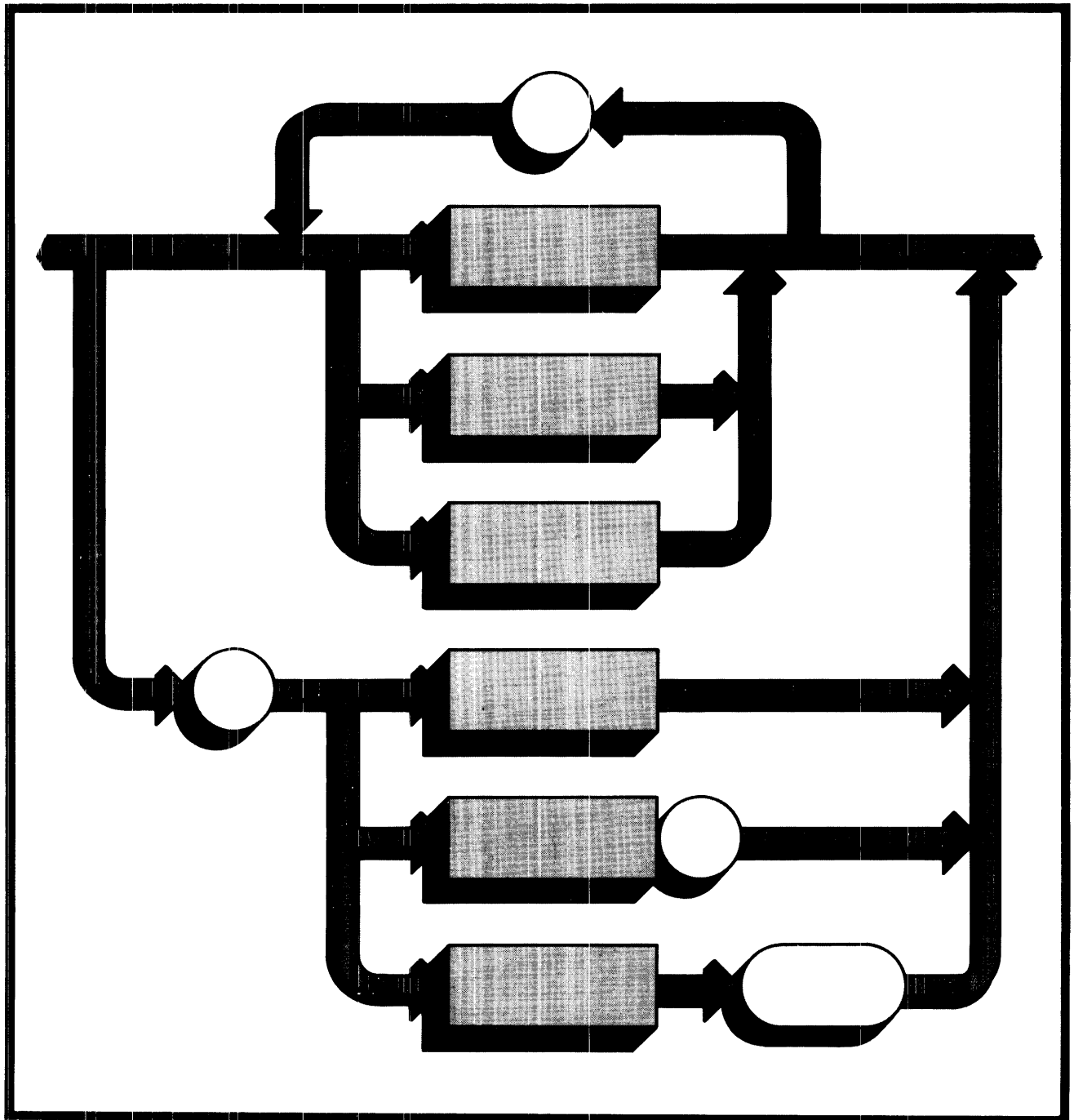

Pascal 3.1 Workstation System

Vol. I: Main Command Level and Subsystems

for the HP 9000 Series 200/300 Computers

Manual Reorder No. 98615-90022

© Copyright 1985, Hewlett-Packard Company.

This document contains proprietary information which is protected by copyright. All rights are reserved. No part of this document may be photocopied, reproduced or translated to another language without the prior written consent of Hewlett-Packard Company. The information contained in this document is subject to change without notice.

Use of this manual and flexible disc(s) or tape cartridge(s) supplied for this pack is restricted to this product only. Additional copies of the programs can be made for security and back-up purposes only. Resale of the programs in their present form or with alterations, is expressly prohibited.

Restricted Rights Legend

Use, duplication, or disclosure by the Government is subject to restrictions as set forth in paragraph (b)(3)(B) of the Rights in Technical Data and Software clause in DAR 7-104.9(a).



Hewlett-Packard Company

3404 East Harmony Road, Fort Collins, Colorado 80525

Printing History

New editions of this manual will incorporate all material updated since the previous edition. Update packages may be issued between editions and contain replacement and additional pages to be merged into the manual by the user. Each updated page will be indicated by a revision date at the bottom of the page. A vertical bar in the margin indicates the changes on each page. Note that pages which are rearranged due to changes on a previous page are not considered revised.

The manual printing date and part number indicate its current edition. The printing date changes when a new edition is printed. (Minor corrections and updates which are incorporated at reprint do not cause the date to change.) The manual part number changes when extensive technical changes are incorporated.

May 1985...Edition 1

NOTICE

The information contained in this document is subject to change without notice.

HEWLETT-PACKARD MAKES NO WARRANTY OF ANY KIND WITH REGARD TO THIS MANUAL, INCLUDING, BUT NOT LIMITED TO, THE IMPLIED WARRANTIES OF MERCHANTABILITY AND FITNESS FOR A PARTICULAR PURPOSE. Hewlett-Packard shall not be liable for errors contained herein or direct, indirect, special, incidental or consequential damages in connection with the furnishing, performance, or use of this material.

WARRANTY

A copy of the specific warranty terms applicable to your Hewlett-Packard product and replacement parts can be obtained from your local Sales and Service Office.

Table of Contents

Chapter 1: Manual Overview	1
Introduction	1
Before Reading this Manual	1
Preview of Chapters in Volume I	2
Preview of Chapters in Volume II	3
 Chapter 2: The Main Command Level	 5
Introduction	5
Main Command Prompt	5
Main Command Quick Reference	6
Main Command Reference	7
eXecute	8
Initialize	9
Memory volume	10
New sysvol	12
Permanent	13
Run	14
Stream	15
User restart	18
Version	19
What	21
 Chapter 3: File System	 23
Introduction	23
Primary Vs. Secondary Storage	23
Pascal Volumes	24
Volumes	24
Logical Units	25
The System Volume and Default Volume	26
Files	27
File Naming Conventions	28
File Specifications and File Names	28
Syntax of File Names	31
File Types Derived from File Names	31
File names (LIF)	32
File Names (Workstation 1.0 Directory)	33
File Names (SRM System)	33
File Size Specification	33
Several Directory Organizations Allowed	34
File Name Suffixes and File Types	34
Suppressing the Suffix	35
Translating Files from One Data Type to Another	36

Wildcards	37
File Names to Avoid	39
Allowable File Names	39
File Name Length	40
No Room on Volume	40
The Shared Resource Management System	41
Hierarchical directories	41
Notation	42
SRM Units and Volumes	42
Moving Up and Down the Hierarchy	43
Default Volume Vs Current Working Directory	45
SRM Concurrent File Access	46
SRM Access Rights	46
Chapter 4: The Editor	47
Introduction	47
Entering the Editor	48
Creating a Text File	49
The Editor Prompt	49
A Sample Editor Session	50
Creating Text	50
Storing your File and Returning to the Editor	51
Copying Text from Other Files	52
Confirming or Aborting Commands	53
Moving the Cursor	54
Deleting Text	55
Recovering Deleted Text	56
Moving and Duplicating Text	56
Changing and Altering Text	57
Formatting Text	62
Exiting the Editor and Saving the File	66
Making a Backup Copy	67
A Closer Look	68
The Cursor	68
The Anchor	68
The Screen as a Window into a File	68
Memory and File Sizes	69
Structure of Text Files	70
Using Workfiles in the Editor	70
Stream Files and the ANYCHAR Key	71
I/O Errors (Entering and Exiting the Editor)	71
Editor Commands	72
Editor Command Summary	72
Command Syntax and Semantics	73
Adjust	74
Copy	76
Delete	78
Equals (=)	80

Find	81
Insert	84
Jump	87
Margin	88
Page	89
Quit	90
Replace	92
Set	95
Verify	99
eXchange	100
Zap	102
Chapter 5: The Filer	103
Introduction	103
Entering the Filer	104
The Filer Prompt	104
Filer Operations	105
A Sample Filer Session	105
Finding Out What Devices are Accessible	105
The Default and System Volumes	106
Changing the Default Volume	106
The System Volume	107
Listing a Directory	108
Getting a More Detailed Listing	109
A Few Words About Wildcards	111
Translating Text Files	111
Sending File Listings to the Printer and Screen	112
Copying Entire Volumes: Backup Copies	113
Creating a Directory	115
Copying Files from Volume to Volume	116
Renaming Files and Volumes	119
Removing Files	120
Leaving the Filer	121
The System Workfile (A Convenient Scratchpad)	121
Filer Commands	122
Filer Command Summary	122
Command Syntax and Semantics	123
Access	126
Bad sector	128
Change	129
Duplicate_link	131
Extended directory	132
Filecopy	135
Get	139
Krunch	140
List directory	142
Make	144
New	146

Prefix	147
Quit	149
Remove	150
Save	152
Translate	153
Unit directory	155
Volumes	157
What	158
Zero	159
Chapter 6: Pascal Compiler	161
Introduction	161
Steps In Program Development	162
Prepare the Source Program	162
Invoke the Compiler	162
Handling Syntax Errors	163
Interpreting the Compilation Listing	164
Running the Compiled Program	165
Using a Workfile	165
Debugging	166
Modules	167
Module Structure	167
Developing and Testing a Module	170
An Illustration	172
Compiling a Module Separately	172
How the Compiler Finds Library Modules	173
How the Loader Finds Library Modules	175
A Subtle Point	176
\$INCLUDE Files	176
Miscellaneous	176
What Can Go Wrong?	177
Can't Run the Compiler	177
Errors 900 thru 908	177
Errors When Importing Library Modules	178
Not Enough Memory	178
Insufficient Space for Global Variables	178
Errors 403 thru 409	178
Compiler Options	179
ALIAS	180
ALLOW_PACKED	181
ANSI	182
CALLABS	183
CODE	184
CODE_OFFSETS	185
COPYRIGHT	186
DEBUG	187
DEF	188
FLOAT_HDW	189

HEAP_DISPOSE	190
IF	191
INCLUDE	192
IOCHECK	193
LINENUM	194
LINES	195
LIST	196
OVFLCHECK	197
PAGE	198
PAGEWIDTH	199
PARTIAL_EVAL	200
RANGE	201
REF	202
SAVE_CONST	203
SEARCH	204
SEARCH_SIZE	205
STACKCHECK	206
SWITCH_STRPOS	207
SYSPROG	208
TABLES	209
UCSD	210
WARN	211
How Pascal Programs Use the Stack	212
The Pascal Stack	212
Global Variables	212
Procedure Calls	213
Function Calls	214
Parameter Passing Mechanisms	214
Function Results	215
Chapter 7: The Assembler	221
Introduction	221
Operating the Assembler	222
Invoking the Assembler	222
Source File Specification	222
Listing File Information	222
Object File Specification	223
Interpreting the Listing	224
The Programming System	225
The IMPORT Text	226
The DEF Table	226
The EXT Table	227
Declaring the Module Name	228
Passing Parameters	228
Declaring Global Variables	229
Referencing Global Variables	229
Referencing Other Module's Globals	230
Local Variables	230

Module Initialization	233
Error Recovery	233
Exception Coding	235
Returning to Pascal	235
Declaring External Procedures	236
Instruction Syntax	237
General Syntax	237
Line Labels	238
Opcodes	239
Operands	241
Addressing Modes	245
Comments and Comment Lines	247
MC68881 Floating Point Co-processor Support	249
Assembler Support of the Co-processor	249
Assembler Pseudo-Op Reference	250
COM	250
DC	251
DECIMAL	251
DEF	252
DS	252
END	253
EQU	253
INCLUDE	253
LLEN	254
LIST	254
LMODE	255
LPRINT	255
MNAME	256
NOLIST	256
NOOBJ	257
NOSYMS	257
ORG	258
PAGE	258
REFA	259
REFR	259
RMODE	260
RORG	260
SMODE	261
SPC	261
SPRINT	261
SRC	262
START	262
TTL	262
The Examples	263
The Sample Pascal Programs	263
The Sample Pascal Module	264
The Disassembly of the Module	265
The Assembly Language Module	267

Chapter 8: The Librarian	271
Introduction	271
Prerequisites	271
Library Overview	272
Modules and Libraries	272
What the Librarian Does	272
Example Modules	273
Compiling and Running the Example Program	275
Entering the Librarian	278
Setting Up Mass Storage	279
Creating Libraries of Object Modules	280
Adding Modules to the System Library	280
Making Your Own Library	282
Linking Object Files Together	283
Getting Detailed Object File Information	286
The Text and Table Commands	287
The Unassemble Commands	288
Creating a New Boot File	292
Librarian Command Reference	293
Glossary of Object Code Terminology	296
DEF Table (Definition Symbol Table)	296
DEFINE SOURCE	296
EXT Table (External Symbol Table)	297
EXPORT	298
Flags	298
General Value or Address Record (GVR)	299
IMPLEMENT	299
IMPORT	299
LIBRARIAN	299
Library	300
LIBRARY	300
Object File	300
Object Module	300
Pascal Module	300
REF Tables	301
Reference Pointer	301
System Library	302
Text Record	302
Chapter 9: The Debugger	303
Introduction	303
Is the Debugger Loaded?	303
A Sample Session	304
The Example Program	304
Please Participate	305
Loading the Debugger	305
A Note about Key Notations	306
Is the Debugger Installed?	307

Invoking the Debugger	307
The Debugger Command Screen	308
Single-Stepping a Program	309
Slow Program Execution	309
Returning to the Debugger Command Screen	309
Toggling Between Screens	309
Screen Dumps	310
A Look at the Queue	310
Displaying Data	310
Controlling Execution with Breakpoints	313
The Pause Function and Breakpoints	316
Executing a Number of Statements	316
Tracing Program Flow through Procedures	317
A Look at the Stack Frame	318
Examining Variables	318
Examining Consecutive Memory Locations	320
Formats for Structured Variables	321
Changing Memory Contents	322
Static and Dynamic Links	323
Exception Trapping	324
Generating Escapes	325
A Note about Assembly Language Programs	325
Debugger Keyboard	327
A Note about Key Notations	327
Is the Debugger Installed?	327
Calling the Debugger from the Main Command Level	328
Step Modes	328
Command Mode	328
Debugger Command Summary	331
Breakpoint Commands	331
Call Command	331
Display Commands	331
Dump Commands	331
Escape Code Commands	331
Format Commands	331
Go Commands	331
IF, ELSE, and END Commands	332
Open Memory Commands	332
Procedure Commands	332
Queue Commands	332
Register Operations	332
Softkey Commands	332
System Boot Command	332
Trace Commands	332
Walk Procedure Links Commands	332
Debugger Command Reference	333
Debugger Expressions	333
Multiple Commands on a Line	334

Breakpoint Commands.....	335
B.....	335
BA.....	335
BC.....	336
BD.....	336
BS.....	337
The Call Command.....	338
Display Command.....	339
D.....	339
Dump Commands.....	341
DA.....	341
DG.....	341
Escape Code Commands.....	342
EC.....	342
ET.....	342
ETC.....	343
ETN.....	343
Format Commands.....	344
FB.....	344
FH.....	344
FI.....	344
FO.....	344
FU.....	344
Go Commands.....	345
G.....	345
GF.....	345
GT.....	346
GTF.....	346
IF, ELSE, and END Commands.....	347
Open Memory Commands.....	349
OL, OW, OB.....	349
Semantics.....	349
Procedure Commands.....	350
PN.....	350
PX.....	350
Queue Commands.....	351
Q.....	351
QE.....	351
QS.....	351
Softkey Commands.....	352
“K0” thru “K9”.....	352
Register Operations.....	353
System Boot.....	353
Trace Commands.....	354
T.....	354
TD.....	354
TQ.....	354
TT.....	355

Walking the Procedure Links.....	356
WD.....	356
WR.....	356
WS.....	356
Technical Reference	357
System History	358
Pascal 1.0	358
Pascal 2.0 and 2.1	359
Pascal 3.0	362
Pascal 3.01	366
Pascal 3.1	367
File Interchange Between Pascal and BASIC	371
Module Names Used by the Operating System	373
Physical Memory Map	375
Full 16 Megabyte Addressing Range	375
A Hypothetical RAM Configuration	376
The Overall Memory Map.....	377
Memory Mapped I/O	378
External I/O.....	378
Internal I/O	379
The Software Memory Map.....	381
Character Sets	383
U.S. ASCII Character Set	384
U.S. ASCII Character Set	385
U.S./European Display Characters	386
U.S./European Display Characters	387
U.S./European Display Characters	388
U.S./European Display Characters	390
U.S./European Display Characters	391
Katakana Display Characters.....	392
Katakana Display Characters.....	393
Monochrome Highlight Characters.....	394
Color Highlight Characters.....	394
Command Summaries	395
Main Command Level Summary	395
Editor Command Summary.....	396
Filer Command Summary	397
Librarian Command Summary.....	398
Debugger Command Summary	399
Glossary	401

Error Messages	407
Unreported Errors	407
Boot-Time Errors	408
Run-Time Errors	408
I/O System Errors	409
I/O Library Errors	410
Graphics Errors	411
Loader/SEGMENTER Errors	412
SEGMENTER Errors	412
Loader Boot-Time Errors	412
Pascal Compiler Errors	413
ANSI/ISO Pascal Errors	413
Compiler Options	414
Implementation Restrictions	415
Non-ISO Language Features	415
Assembler Errors	417
Error Messages	417
Debugger Error Messages/Conditions	419
Subject Index	421

Manual Overview

Chapter
1

Introduction

This is Volume I of a two-volume manual that describes using the Pascal 3.1 Workstation System. It shows how to use the Main Command Level and the subsystems of the Pascal Workstation “environment” – the Editor, Filer, Compiler, Assembler, Librarian, and Debugger – and how they interact to provide you with a powerful Pascal program development tool.

Volume II focuses on programming and configuration of the system.

Before Reading this Manual

Here are the manuals that you should have read *before* reading this manual.

Documentation Guide

This guide describes each manual in the documentation set. It will help you to learn where the various parts of the system are described.

Computer Installation Guides

You should have already set up your computer hardware according to the instructions in the *Installation Guide* for your particular computer.

Peripheral Installation Guide

If you have peripheral devices, such as disc drives and printers, you should have set them up according to the instructions given in this manual. It contains pertinent information taken from each supported peripheral’s installation/operating manual.

Pascal User’s Guide

You should have booted the Pascal system according to the instructions in the *Pascal User’s Guide*. This manual also describes the software configuration required for various peripheral devices.

You may have also followed along with the examples to learn how to begin using the system to enter and compile a few simple Pascal programs, although that is not mandatory due to similar coverage in this manual.

The Pascal Textbook

If you are not familiar with the Pascal language, you may want to first read or scan *An Introduction to Programming and Problem Solving with Pascal* (included in the manual set sent with your system).

Volume II: Programming and Configuration Topics

The second volume of this manual is similar to the Pascal textbook described in the last paragraph, but it presents programming techniques that are specific to the Workstation Pascal programming language; i.e., the extensions to “standard” Pascal that are provided by the Workstation. As with the Pascal textbook mentioned above, you may want to read or scan Volume II of this manual before delving too deeply into this volume.

Previous Workstation Pascal Manuals

If you are familiar with the documentation for earlier versions of the Pascal Workstation System, you may be happy to know that this manual is a later edition of the *Pascal User's Manual*. However, this manual describes only Version 3.1 of the Pascal Workstation system.

Note

The main text of this manual does not generally discuss earlier versions of the system; however, the “System History” section of the “Technical Reference” appendix of this manual will help you if you are upgrading from an earlier version of the Workstation Pascal System.

Other Manuals

This manual does not generally assume that you are familiar with any of the other languages and systems available for this series of HP computers, although references are occasionally made to some of these other languages where appropriate (such as BASIC).

Previews of Chapters in Volume I

Here are brief previews of the contents of each of the remaining chapters of this manual.

Chapter 2: The Main Command Level

This chapter describes the commands available in the “Main Level” of the Workstation System.

Chapter 3: The File System

This chapter introduces you to the Workstation File System. It describes how the logical units and volumes are organized. However, it does not describe access of files from Pascal programs, which is covered in the subsequent “Programming with Files” chapter.

Chapter 4: The Editor

A program usually starts out as an idea. The Editor's function is to provide a useful environment for the translation of thoughts into actual programs or documents. This chapter fully explains the features of the Pascal Workstation Editor.

Chapter 5: The Filer

The Filer is used to store, load, copy, translate and perform other file-related utility operations. This chapter details performing these operations with the Filer.

Chapter 6: The Pascal Compiler

Once a program has been written with the Editor, this source code must be compiled into object code before it can be executed. This chapter explains the operation of the Compiler and the options that can be used to modify its operation. The chapter also describes the modular programming capability, which is one of the most powerful features of this system.

Chapter 7: The Assembler

This chapter introduces you to the Assembler, which converts programs written in assembly language – a humanly understandable version of the microprocessor’s machine language – into object code for the MC68000 family of processors used in these HP computers.

Chapter 8: The Librarian

This chapter covers using the Librarian. In the system are libraries of object-code modules: some consist of device-drivers, while others consist of useful procedures for such applications as I/O and graphics. You can also design your own modules. The Librarian’s function is to manage libraries of Pascal and Assembler object modules.

Chapter 9: The Debugger

We all wish that a program would run perfectly the first time. Unfortunately, there is little evidence in real life to support that fantasy. The next best thing is to have some good tools to help you debug your programs. This chapter explains the debugging features available with this system.

Technical Reference Appendix

This appendix contains the following information:

- A history of the Pascal system, which includes descriptions of the differences between the 3.1 and previous versions of the Workstation system.
- A list of module names used by the 3.1 system.
- Software memory map.
- Tables of available display characters.

Command Summaries

This appendix contains a summary of commands for each of the Pascal subsystems.

Glossary

Knowing what technical terms mean is always useful.

Error Messages

This appendix contains the complete listings of all error messages for the Pascal System and its various subsystems.

Index

This section contains an index to the topics in both volumes of this manual.

Previews of Chapters in Volume II

Here are brief previews of the contents of each of the chapters in the second volume of this book.

Chapter 10: Overview of Workstation Software Features

This chapter gives a brief introduction to Workstation Pascal language and library features. It also tells where various software features are described in the Workstation Pascal documentation set.

Chapter 11: Data Types and Structures

This chapter describes the types of data available in the Workstation Pascal language. It also briefly describes some of the data types and structures that are not available with standard Pascal.

Chapter 12: Program Flow

This chapter describes the features of this system which allow you to alter the flow of a program.

Chapter 13: Numeric Computation

This chapter describes the standard Pascal numeric data types and how they are implemented in this Pascal language. It then shows several examples of useful techniques for dealing with angles, rounding, logarithms, number-base conversion, calendars, and pseudo-random numbers.

Chapter 14: String Manipulation

This chapter describes how to use the HP Pascal type `string`, as well as using the associated string functions and procedures.

Chapter 15: Programming with Files

This chapter describes general uses of files, as well as many Workstation-specific file access techniques.

Chapter 16: Dynamic Variables and Heap Management

This chapter describes how to create and use dynamic variables, as well as how to reclaim the memory used for these temporary variables.

Chapter 17: Error Trapping and Simulation

This chapter describes how to programmatically handle, and possibly correct, errors before they halt the execution of your programs. It also shows how to simulate errors in order to debug the error-handling portions of your programs.

Chapter 18: Special Configurations

This chapter describes how to set up “non-standard” configurations. It first gives background information regarding how the system boots and configures itself, and then it describes the steps required to set up several configurations.

Chapter 19: Non-Disc Mass Storage

Several “non-disc” types of mass storage devices are available on the Pascal Workstation: EPROM (Erasable Programmable Read-Only Memory) cards, Magnetic Bubble Memory cards, and DC600 tape cartridge drives. Configuring and using these devices is described in this chapter.

Chapter 20: Compatibility and Porting

This chapter describes the approaches available for running existing Pascal 3.0 software on new Series 300 computers with the Pascal 3.1 system.

Error Messages

This appendix is an abbreviation of the lengthier appendix given in Volume I. This listing of errors fits on a single sheet of paper, which you may find handy to remove from the manual and place in a more convenient place.

Index

This volume also has an index to the topics in both volumes of this manual.

The Main Command Level

Chapter

2

Introduction

The Main Command Level is the central point of reference for the operating system. It is “where you are” after booting the system and entering the time and date.

All the Main Command Level commands are listed in the subsequent Quick Reference. However, this chapter focuses mainly on those Main Command Level operations which do *not* call subsystems (such as the Editor, Filer, Compiler, etc.); the subsystems are each described in later chapters of this manual.

Main Command Prompt

The Main Command Level consists of two prompt lines, only one of which is displayed at one time. Press the key to toggle between them.

```
Command: Compiler Filer Editor Initialize Librarian Run eXecute Version ?
```

```
Command: Assembler Debusser Memvol Newsysvol Permanent Stream User What ?
```

The uppercase letters in the prompt lines indicate which key to press to start the operation.

All of the operations are available regardless of which prompt is being displayed.

The prompts are abbreviated on the 50 column display of the Model 226.

```
Command: Cmplr Edit File Init Libr Run Xcut Ver ?
```

```
Command: Asm Dbs Memv New Perm Stream User What ?
```

Note

This manual describes many keyboard operations. Since you can have one of three different keyboards, this manual generally describes the keystrokes required on all three keyboards.

For instance, on the HP 46020A keyboards, there are both and keys, while on the HP 98203A and 98203B keyboards, there is only an key. When you are directed in this manual to press one of these keys, the text will usually say: “Press the or key.”

Another common example is the key on the 46020 and the key on the 98203 keyboards. When you are directed to press one of these keys, the text will say: “Press the () key.” (The second key noted in parentheses is the 98203 key.)

Descriptions of each keyboard and key-correspondence tables are given in the *Pascal User's Guide*.

Main Command Quick Reference

Command	Description
Compiler	Calls the Compiler to translate Pascal source code into object code.
Editor	Calls the Editor for creating or editing a source program or textual document.
Filer	Calls the Filer for management of the File System.
Initialize	Initializes the File System (but not discs).
Librarian	Calls the Librarian for managing, linking, or unassembling object-code files.
Run	Runs the workfile (compiling it if needed) or the last program compiled since power-up. If there is no workfile, Run operates like eXecute.
eXecute	Asks for a code file and runs it.
Version	Allows setting the time and date, and displays all the current system version information.
Assembler	Calls the Assembler to translate an Assembler language source program into object code.
Debugger	Runs a program under control of the Debugger.
Memory volume	Sets up a memory resident mass storage volume for fast access.
New sysvol	Asks for a volume to be designated as the system volume.
Permanent	Asks for a code file to be permanently loaded into memory for execution without disc loading each time.
Stream	Asks for a stream file whose characters are interpreted as keyboard input until there are no more left.
User restart	Restarts the last program or subsystem that was run.
What	Displays the system file table and allows you to change the system files or system and default volumes.

Main Command Reference

Each command in this section contains a description and a syntax diagram. The syntax diagrams contain rounded and rectangular boxes. Elements in rounded boxes should be interpreted as literals. An example is as follows:



This notation indicates that you must literally type a  as part of the command.

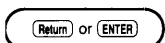

The  or  indicates that you can press either key.



Elements in rectangular boxes are non-literal descriptions of command parameters. An example is as follows:

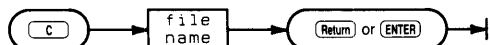

This notation indicates that you must supply the actual file name as part of the command.

An example of a complete command is as follows:



If, for example, this was the Compiler command syntax diagram, it would mean that you must type  to run the Compiler, then type the name of the file to be compiled, and enter the file name with either the  or the  key.

eXecute

The eXecute command runs a specified code file.



Item	Description/Default	Range Restrictions
file specification	literal	Any legal file specification (see the File System chapter)

Semantics

The file you specify should be previously compiled or assembled and ready to run. It is not necessary to include the `.CODE` suffix in the file name; it is automatically appended to the file name if not included. If the actual file name does not contain a `.CODE` suffix, you will need to terminate the file specification with a period to suppress this suffix.

If the specified code file imports other modules, those modules must be contained in the file being executed, in the current System Library (which must be on-line), or they must be Permanently loaded (by using the Permanent command at the Main Level). You can use the What command to see which file is designated as the current System Library, and to change it if desired.

Initialize

The Initialize operation updates Unit Table entries for all units that are currently on-line. (It does not initialize mass storage media; that function is performed by using the MEDIAINIT utility program. See the *Pascal User's Guide* for further details.)



Semantics

The Unit Table contains a record for each of 50 possible logical units available to the File System. The assignment of unit numbers to physical devices (auto-configuration) is performed by the TABLE program at power-up. Each record contains the “device address vector” of the physical device which corresponds to that logical unit number. The computer then looks at the physical location indicated by the device address vector to see if the device is on-line. If it is, that fact is marked in the record for that unit, along with the volume name (if media is currently installed in the device). Afterwards, the computer only looks at the Unit Table to see if a particular device is on-line; it does not check the actual device. (See the Booting Process section of the Special Configurations chapter for further details of how the TABLE program works.)

When a device is added to your system after the computer has been powered-up, you will usually need to execute `BOOT:TABLE` or power-up the system again in order for the device to be recognized. However, the Initialize command may in some cases be sufficient to get the system to recognize the new device.

Initialize also performs a device clear for all on-line devices and causes the system to forget the last loaded file (the User command can't reload the last program). The Initialize operation also causes all temporary files to be removed from each volume the next time a file is opened on the volume.

The volumes `CONSOLE: (Unit #2)` and `PRINTER: (Unit #6)` are special cases; these volumes are always assumed to be on-line. Thus, the system may “hang” if either of them is off-line.

Memory volume

The Memory volume command creates a mass storage volume in memory.

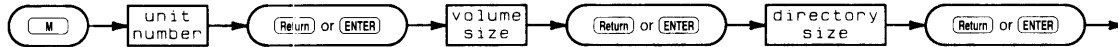

Item	Description/Default	Range Restrictions
unit number	integer	7 thru 50
volume size	integer indicating the number of 512-byte blocks	≥1
directory size	integer indicating the maximum number of files in the volume	≥1

Semantics

The Memvol command gives you the capability for very fast mass storage operations.

When the Memvol command is given, you are prompted for a unit number. This number corresponds to an entry in the Unit Table. Don't give a unit number which is already in use. The Volumes command in the Filer subsystem shows which unit numbers are currently used. For most applications 50 is the recommended unit number to use for your first memory volume.

You are then prompted for the number of (512-byte) blocks needed for the memory volume. Try to estimate conservatively the amount of memory you want reserved for the memory volume because it cannot be returned for general purpose use without turning off the computer. On the other hand, if you don't specify enough space, you have to create another larger volume.

Memory volumes are useful for program development where a lot of mass storage I/O (editing and compiling) is involved. Reserve enough space on the memory volume for both the source file, the object code file, and 40 extra blocks for the Compiler's temporary files. A good rule of thumb is:

$$\text{size_of_volume} = \text{size_of_source_file (in 512-byte blocks)} * 4 + 40$$

If you are transferring a source file from disc (as opposed to starting from scratch) you can determine its size by getting a directory listing of the volume that contains it. However, note that different directories return the file size in different units.

- LIF directories use 256-byte "blocks"
- WS1.0 directories use 512-byte "blocks"
- SRM directories use 1-byte "blocks"

Note that the default directory access method (DAM) for memory volumes is LIF; this DAM is the primary DAM specified in the TABLE program. See the Special Configurations chapter for further details about changing the primary DAM.

You are then prompted to give the number of directory entries you need for this memory volume.

```
Number of directory entries ?
```

Type the number you think you'll need and press **Enter**.

You can refer to your memory volume by its unit number. For example:

```
#50:
```

Alternately, you can refer to it by its given volume name, which is initially RAM:. For example:

```
RAM:
```

If you plan to use more than one memory volume, use the Filer's Change command to give each memory volume a unique name.

Here is a method for setting up an extremely fast program development environment.

1. Create a RAM: volume and specify it as the system volume using the Newsysvol command.
Specify RAM: as the default volume using the Main Command Level's What command or the Filer's Prefix command.
2. Permanently load the Editor and Compiler using the Permanent command.
3. Go into the Editor and write your program.
4. When you're ready to leave the Editor, use the Update option to create a workfile. The system puts the workfile on the fast RAM system volume.
5. Press **R**.

Your file will automatically be compiled. If it compiles with no errors, it will be run. If it contains errors, you will have the option of returning to the Editor.

Note

Since memory volumes are volatile, don't forget to save the files in the memory volume on a disc before turning off the computer.

New sysvol

The New sysvol command specifies a new system volume and updates the operating system file table accordingly.

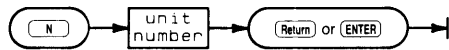

Item	Description/Default	Range Restrictions
unit number	integer	1 thru 50

Semantics

The system file table is used in locating operating system files. It contains the volume and file names of system files (EDITOR, FILER, etc.). When you press a key at the Main Command Level that invokes one of these subsystems (such as), the system attempts to load the corresponding file indicated in the system file table (here, the EDITOR file).

You can use this command to specify a new system volume. The first step in this operation prompts you for a unit number. The device corresponding to the specified unit number is considered to be the new system volume, and serves as a starting point in the search for the system files: ASSEMBLER, COMPILER, EDITOR, FILER, LIBRARIAN, LIBRARY, and the work file. If any of these system files are not found, the Unit Table is used in a sequential search for the rest of them. As each file is found, the name of the volume on which it is found is prepended to the file name (for instance, SYSVOL:LIBRARY), and the complete file specification is placed in the file table. If any system file is not found in this search, the operating system assumes that it will find the file on the flexible disc volume on which it was delivered (for instance, ACCESS:EDITOR).

Use the Main Command Level's What command to see the resultant system file table.

Permanent

The Permanent command loads a program permanently into memory.

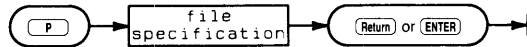

Item	Description/Default	Range Restrictions
file specification	literal	Any legal file specification (see the File System chapter)

Semantics

The Permanent command can be used to load a user program, a system program (Editor, Compiler etc.), or a module that is needed by a program. This code file is then ready to execute immediately when the command is given. A “P-loaded” (Permanently loaded) program does not have to be loaded from disc each time it is run.

After you give the Permanent command, you are prompted for the name of the file which contains the module or program. You need not include the `.CODE` suffix; if you don't include one, the suffix will be appended to the file name. If the file to be P-loaded does not have a `.CODE` suffix, end the file specification with a period to suppress the suffix from being appended to the file name automatically.

Several programs may be P-loaded in memory. The operating system keeps track of which programs have been P-loaded. When you give a command to run a program, the operating system checks to see if it has been P-loaded; if so, it is executed immediately. If not, it is loaded from disc and then executed; after execution, the memory used by the program is reclaimed.

An object module which is imported by a program must be in the object file that contains the program, in a file previously P-loaded, or contained in the current System Library (which must be on-line).

A program or module's global variables are zeroed only when it is loaded, not each time the program is run. However, note that neither local variables nor dynamic variables are zeroed.

Note

The volume name is not retained when a file is P-loaded. Attempting to execute a file of the same name but on a different volume will still result in the P-loaded file being executed.

For SRM users, do not use a directory path name to execute a P-loaded file.

Run

The Run operation causes the workfile or last compiled program to be executed.

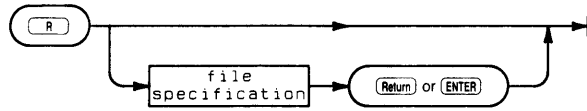

Item	Description/Default	Range Restrictions
file specification	literal	Any legal file specification (see the File System chapter)

Semantics

When the Run command is given, the operating system checks to see if there is a workfile. If there is a CODE workfile, it is executed; if not, the most recently compiled or assembled file is executed. If there is a TEXT workfile but no CODE workfile, the TEXT workfile is first compiled (with the system compiler) to a CODE file and then the CODE file is executed. If there is no workfile or previously compiled program, the command operates like the eXecute command and you are prompted for a file specification.

Stream

The Stream command “executes” a file of ASCII characters as if they were being typed from the keyboard.



Item	Description/Default	Range Restrictions
file specification	literal	Any legal file specification (see the File System chapter)

Semantics

A command stream or stream file is a file that is interpreted as input to the Main Command Level and/or its subsystems in place of keyboard input. The Stream operation causes a file to be interpreted. Therefore, a stream file is useful for executing a sequence of commonly used commands without requiring any operator intervention.

A stream file is created with the Editor and may be of type “.TEXT”, “.ASC” or Data. If you do not specify a suffix, a “.TEXT” is automatically appended to the file name; if the name of the file to be streamed does not have a suffix, add a trailing period to the file name to suppress the suffix.

In order to generate a valid sequence of keystrokes, you should first run through the desired sequence while noting the keystrokes entered. Note particularly the occurrences or absences of the **Return** or **Enter** key. Then enter the same keystrokes in your stream file. If, during an Editor or Filer command sequence, you encounter an unpredictable question that has a (Y/N) or (R/O/N) question associated with it, do not answer the question in the stream file. These kinds of questions are answered automatically as the file is streamed. (Y/N) questions (Yes/No) are answered “Y”. (R/O/N) questions (Remove/Overwrite/Neither) are automatically answered “R”.

After all the characters in a stream file have been interpreted, control is returned to the keyboard.

Comments

Stream files may contain comments. A line beginning with an asterisk (*) will be interpreted as a comment if it occurs at the Main Command Level. (Comments cannot be embedded among commands for subsystems or user programs.) When the command interpreter encounters one or more comment lines while streaming, they are displayed briefly on the screen, thus allowing the process to be monitored.

Immediate Execute Keys

If it is necessary to use keys that also act as immediate-execute commands in the Editor, such as **Select** (**EXECUTE**) or **Backspace**, use the following key sequences to generate those keystrokes.

Immediate-Execute Key	Generate with these Keys
Return	CTRL - Select M
Select	CTRL - Select C
Backspace	CTRL - Select H
Tab	CTRL - Select I
Clear display	CTRL - Select L
Left arrow	CTRL - Select H
Right arrow	CTRL - Select <
Up arrow	CTRL - Select ?
Down arrow	CTRL - Select J

If you have a 98203 keyboard, substitute **EXECUTE** or **EXEC** for **Select** in the preceding table.

Prompts for Keyboard Input

A stream file can be made to display a prompt on the console and then wait for an input string from the keyboard. The input string is assigned to a variable in the stream file. When the variable is encountered during streaming, the string is used in its place.

This input prompting must appear in the stream file *before all* of the commands or comments. Up to 36 prompts are allowed. They are denoted with an “=” as the first character on a line.

To prompt for an input string, place an equal sign, followed by a single alphanumeric character variable name (uppercase and lowercase letters used for variables are treated as equal), followed by the prompt text. For example:

```
=f What is the name of the file to be P-loaded ?
```

When the file name is typed in response to the prompt, it is stored in the specified variable, in this case the variable named f.

After the input prompting, begin entering the commands in the stream file. When you want the input string to be given to the operating system, use the variable preceded by “@”. For example, the following characters are a command stream:

```
P@f
```

The command is the Permanent load command with a file name parameter indicating which file is to be P-loaded. The file whose name was given in response to the above prompt is then P-loaded.

Disabling the Prompt Feature

If the stream file name contains a [*] specifier, the ability to prompt for keyboard input is disabled.

(Normally when a file is Streamed, the file is copied to the file named STREAM on the current system volume; during this copy, prompts are displayed and @ variables assigned values input from the keyboard by the computer operator. After all variables have been assigned, the file is read as keystrokes; in other words, *STREAM is the file that is actually streamed. The [*] suppresses the normal processing of the prompts and input variables, as the keys are read directly from the specified file.)

Stream Files on Read-Only Devices

It is the disabled-prompt mechanism (see preceding discussion) that allows the use of stream files stored on read-only mass storage, such as EPROM, and the use of read-only devices as system volumes. This mechanism is also used to process the AUTOKEYS stream file, if found during the boot process when the AUTOSTART stream file is not present. For examples of AUTOSTART and AUTOKEYS stream files, see the discussions in the *Pascal User's Guide* and in the Special Configurations chapter of this manual.

User restart

The User restart command causes the last program that was run to be rerun.



Semantics

Included in the meaning of “program” are user programs and operating system programs such as Editor, Filer, Compiler, etc.

Global variables are zeroed at the time a program is loaded, not each time a program is rerun. However, note that neither local variables nor dynamic variables are zeroed.

The Version Prompt

```
New system date ?  
  
System date is          1-Jun-84  
Clock time is          14:14:50  
  
Workstation             Rev.  3.0  15-Apr-84  
  
Available Global Space 57960 bytes  
Total Available Memory 191042 bytes  
  
System volume:  SYSVOL:  
Default volume:  SYSVOL:  
  
Copyright 1984 Hewlett-Packard Company.  
All rights are reserved. Copying or other  
reproduction of this program except for archival  
purposes is prohibited without the prior  
written consent of Hewlett-Packard Company.
```

For more details on "Global Space", see the Compiler chapter.

What

The What command displays the “system file table” and allows you to specify new file specifications for the system files.

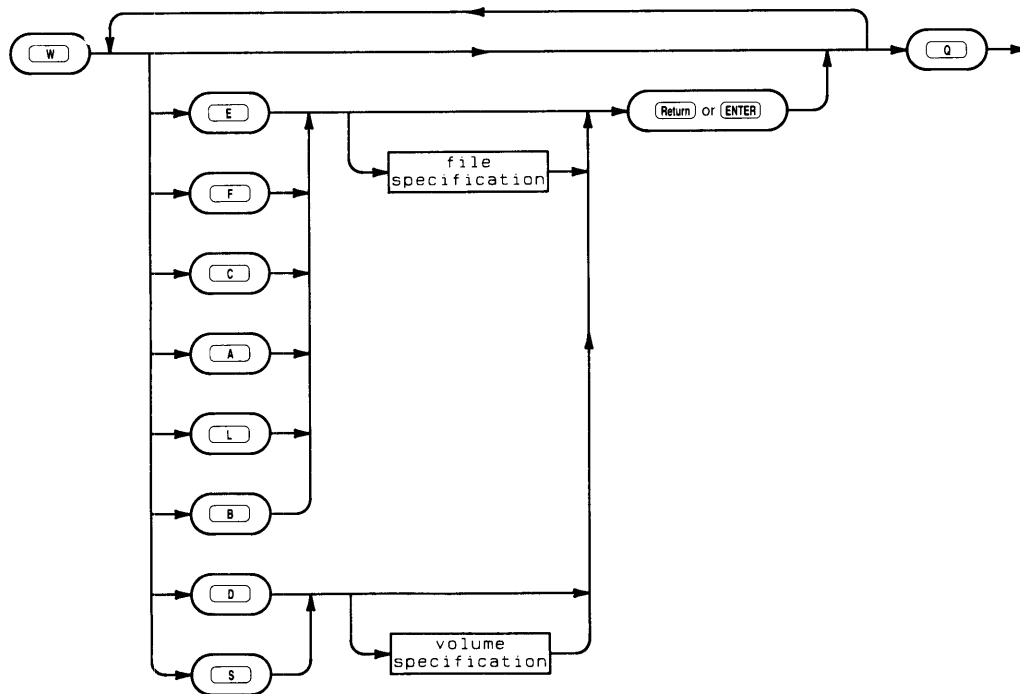

Item	Description/Default	Range Restrictions
file specification	literal	any legal file specification (see the File System chapter)
volume specification	literal	any legal volume specification (see the File System chapter)

Semantics

The system file table contains file specifications that are used by the operating system when locating system files (Assembler, Compiler, Editor, Filer, Librarian, Library, and Default and System volumes). The What command displays the system file table; a typical example is shown below.

The What Display

```

Assembler Compiler Editor Filer Librarian
liBrary System volume Default volume Quit

ASSEMBLER   SYSVOL:ASSEMBLER
COMPILER    SYSVOL:COMPILER
EDITOR      SYSVOL:EDITOR
FILER       SYSVOL:FILER
LIBRARIAN   SYSVOL:LIBRARIAN
LIBRARY     SYSVOL:LIBRARY

* System volume:  SYSVOL:
: Default volume: SYSVOL:

```

Typing one of the uppercase letters at the top of the menu allows you to change the corresponding file specification for that system file.

Note

When specifying a system file name that does not have a .CODE suffix, use a period at the end of the file name to prevent a .CODE suffix from being appended to the file name.

With this command, it is possible to do such things as specify a file other than LIBRARY as the System Library or your custom graphics editor as the System Editor. In the case of your custom editor, you need only press to invoke it.

Specifying a logical unit number, such as #3:, as the Default volume allows *any* disc media in a unit with removable media to be the desired volume. To subsequently specify any volume in the default unit, only the file name need be specified. To accomplish this, make sure that the drive door is open, type for a Default volume change, and then type the following:

#3:

The File System

Chapter

3

Introduction

This chapter introduces you to the Workstation Pascal File System. The File System organizes and accesses information which is stored on mass storage devices. Even if you are an experienced programmer, you should read this material because it will help you understand the features of your Pascal workstation.

Primary vs. Secondary Storage

Your computer has built into it a substantial amount of very high speed memory called Random Access Memory, or **RAM**. This memory is called **primary storage** to distinguish it from external mass storage, also called **secondary storage**. Normally, data processed by the computer must first be placed in internal memory. (The term “data” is used broadly to mean any information processed by the computer, so programs are data, too.)

RAM has three important characteristics:

- RAM is very fast: Some data items can be stored or retrieved from RAM in less than a millionth of a second.
- RAM is volatile: Data in RAM is lost when the computer is powered off.
- It is expensive compared to alternative, slower forms of data storage, such as discs or magnetic tape.

Information not immediately needed by the computer is kept in secondary storage. Some important characteristics of magnetic discs are listed below:

- Data access is slow compared to RAM, often as much as ten thousand times slower.
- The data is relatively permanent; that is, it is available until erased.
- Magnetic storage is inexpensive compared to RAM.
- Magnetic media are often removable and replaceable, providing an almost unlimited amount of long-term storage.

Pascal Volumes

Let's take an exploratory trip, using the computer itself to investigate the file system. You should already know how to load the Pascal Language system, and be aware of its various subsystems, such as the Editor and Filer.

To begin our journey, begin at the Main Command and load the Filer subsystem by pressing:

F

The Filer is located on the Pascal disc labelled **ACCESS:**. When the Filer's prompt line appears, execute the Volumes command by pressing:

V

The various disc drives connected to your computer will be accessed and then you will see a display similar to the following:

```
Volumes on-line:
 1  CONSOLE:   This is your workstation's CRT display.
 2  SYSTEM:   This is your workstation's keyboard.
 3  * BOOT:    BOOT: disc is in right-hand drive (of 9836).
 4  * WRKING:  Initialized disc with volume name WRKING:
 6  PRINTER:  Printer is connected to built-in HP-IB.
11  * SYSVOL:  The * indicates the system volume.
12  * MYVOL:   (Volumes 11 through 14 are examples of a
13  * MASTER:  possible HP 9133A disc drive configuration.)
14  * V14:
50  * RAM:     Ram volume made with Memory Volume command.
Prefix is - MYVOL: MYVOL: is current prefix volume.
```

Precisely what will be displayed depends on what peripherals are connected to your computer and what discs are currently installed in the disc peripherals. Note how your display appears. You may want to change some of the discs in your systems disc drives or turn off a peripheral and see how that changes the display.

Volumes

The word "volume" was chosen by analogy to a book. Volume denotes a logical entity in which a substantial amount of information can be stored. For instance, a flexible disc is a volume. Volumes have names by which we may refer to them. The display above shows what volumes are currently accessible to the file system on my system.

Notice that each volume name is followed by a colon. This convention is used throughout the Pascal system. The colon is a delimiter or punctuation mark which separates the volume name from further information used to designate data within the volume.

A single large disc may contain more than one volume, as a shelf can hold more than one book. Flexible discs contain a single volume. For flexible discs we may use the volume name as the disc drive's name. By that I mean, if we refer to the volume **BOOT:** by name, the computer will find it in whichever drive it is located.

Note

Because the file system works with named volumes, it is very important not to have more than one volume of a given name on-line at one time. The file system may destroy data by using one volume when you meant the other.

You can see that some of the volume names don't correspond to any disc device at all. Actually the file system has a name for each input/output device. `SYSTEM:` is the name of the keyboard volume, `CONSOLE:` is the name of the CRT, and `PRINTER:` is the name of the system hard copy device. We will have more to say about these non-disc volumes later.

Logical Units

The numbers in the column to the left of the Volume names displayed above are called "logical unit numbers" or simply "units". The volume name denotes a particular disc, while the unit number denotes a particular location for a volume. In the case of flexible discs, the unit number corresponds to a physical disc drive. In the case of a large fixed disc which is divided into several logical volumes, each logical unit represents a portion of the disc surface which is treated as if it were a separate physical disc drive.

To refer to a unit instead of a volume, use a # followed by the unit number. For instance `#3:` and `BOOT:` both refer to the same volume as long as `BOOT:` is installed in the right-hand disc drive of a Model 226 or Model 236 computer.

Drive Numbers vs. Unit Numbers

Since a single machine can contain two or more drives, you need to be able to distinguish between them. If you read the machine's manual, you will find that the drives are differentiated by *drive number*. For instance, the right-hand floppy drive in a 9836 is drive number 0, while the left-hand drive is drive number 1. The File System distinguishes between them by assigning each a unique *logical unit number*. In the case of the 9836, these drives are normally assigned unit numbers 3 and 4, respectively. With external dual floppy drives, drive 0 is usually the left-hand drive, while drive 1 is the right-hand drive. And with hard disc drives, there can be several drive numbers. Don't be alarmed, however, because the system takes care of the correspondence between drive numbers and unit numbers for you. In addition, this manual refers almost solely to logical unit numbers, not drive numbers. Drive numbers were mentioned so that you would realize that they are not the same as unit numbers.

Blocked and Unblocked Units

Some of the units are displayed with # or * between the unit number and the volume name. These are blocked units. Blocked units are memory devices that are divided into sectors (blocks) and have directories describing their contents.

We aren't yet ready to talk about the data stored in a volume, but you probably won't be surprised to learn that it is organized into groups called "files", which are like chapters in a book. The directory of a blocked volume is essentially a table of contents.

The other units are unblocked or "byte stream" devices (such as the printer, keyboard, and CRT). Unblocked devices process information one character at a time and do not have directories.

The System Volume and Default Volume

Although your workstation can deal with many volumes (up to 50 on-line at once), there are two volumes which are referred to so frequently that special abbreviations have been provided to name them. They are the *system volume* and the *default volume*.

The System Volume

The system volume is used by the Operating System to store its own private files and records. Since the Operating System is always overseeing your computer's operation, the system volume needs to be accessible practically all of the time. The abbreviated name for the system volume is * (asterisk), which appears next to the system volume in the Volumes command's display. The asterisk need not be followed by a colon, since it is distinctive. Thus for the Volume display shown previously, these notations all denote the system volume:

```
*
* :
SYSVOL :
#11 :
```

Here are some of the ways the operating system uses the system volume:

- When the Operating System is loaded and begins to function, it looks on the system volume for subsystem programs such as the Editor, Filer and Compiler. If these subsystem programs are on other volumes, the Operating System will still find them.
- When the Operating System first begins to function, it looks on the system volume to find the system date. The system date is put on all files as they are created to help in maintaining file organization. If you change the system date, the new date gets written on the system volume.
- During processing of a stream file, data may be temporarily stored on the system volume. A stream file is a pre-recorded sequence of keystrokes which are treated as if they came directly from the keyboard.
- If you create an anonymous file (see the Programming With Files section), it will be stored on the system volume. An anonymous file is a file created by a program, used by the program, and then destroyed when the program ends. While the program is in existence, the anonymous file is for all purposes a real file.
- If you use a work file during development of a program, it will be stored on the system volume.
- If you use an AUTOSTART or AUTOKEYS file, it must be stored on the system volume.

The Default (Prefix) Volume

The other special volume is the default volume. This volume is sometime called the prefix volume. In many applications it is most convenient to have the frequently needed files together in a single volume. If these files are being accessed frequently, it is tedious to constantly type the volume name or unit number. You can instead tell the system that when no volume name is specified, the one to use is the default volume. You specify the default volume by using the Filer's Prefix command.

The preceding Volumes display indicates “Prefix is - MYVOL:”. This means that MYVOL: is the default volume. The default volume can be specified in two ways. If a colon separator appears with no volume name before it, the default volume is assumed. If a file name is given with no volume name before it, the default volume is assumed.

Use the Filer’s Prefix command to set the default volume name:

```

P
Prefix to what directory?
SYSVOL: Return or ENTER
Prefix is SYSVOL:

```

The default volume and the system volume can be the same volume. In fact, except for single drive configurations, the default condition you received from the factory has SYSVOL: as both the default and system volume.

If a unit specified by unit number (e.g. #3:) in a Prefix command does not contain a disc when the Prefix command is executed, that unit becomes the default volume. That means that the current disc in that drive, no matter which disc is the current disc, is the default disc as long as it is in the drive.

You can also set the default volume name using the **What command** of the Main Command Level. The What command is more powerful than the Prefix command because What allows you to specify a new system volume, as well as the name and location of each of the system files (Filer, Editor, Library, etc). For further information on the What command, see the “Main Command Level” chapter of this manual.

Files

Information within a blocked volume is further organized into **files**. A file is a collection of related information, having a name by which it is identified during the file operations. Since a volume usually contains many files, within the volume there is also a directory, or “table of contents,” telling the name of each file, how big it is, what sectors it occupies on the disc, and (roughly) what sort of data it contains.

Files are created by computer programs – either system programs (such as the Editor, Filer and Compiler,) or user application programs.

For example, when you save a Pascal program written with the Editor, the program is saved with the specified file name in either the current default volume or the specified volume. When that same program is compiled, the object code is stored in another file. When the object code program is executed, it may create more files.

You can use the Filer to list the files in a volume. For instance, to see what is in the default volume of our example system, type:

```

L

```

to invoke the Filer’s List directory command. The Filer responds with:

```

List what directory?

```

When a volume is **not** specified, the default volume is assumed. To specify the default directory, type in:

or

Assuming the configuration shown on previous page, you could have done the same job by typing:

SYSVOL: or

The listing of the default volume's directory is shown below.

```

SYSVOL:                               Directory type= LIF level 1
created 9-Aug-82 21.13.37  block size=256
changed 9-Aug-82 21.13.37  Storage order
...file name...      # blks  # bytes last chng

TAPEBKUP.CODE        54      13824 28-Oct-82
FILEINTRO.TEXT       64      16384 28-Oct-82
FILEINTRO.ASC        73      18688 28-Oct-82
DATAFILE             10       2560 28-Oct-82
FILES shown=4 allocated=4 unallocated=76
BLOCKS (256 bytes) used=201 unused=4499 largest space=4493

```

File Naming Conventions

The definition of HP Pascal tries to minimize the work of moving Pascal programs from one operating system to another by requiring the use of string values to specify the names of files and certain other information such as passwords and access rights.

In Pascal 2.0 and later versions, the allowable syntax of a file name depends on the type of directory in which the file resides. The underlying file support is structured to allow programs to work properly regardless of the directory organization(s) being used, but the syntax of file names is defined by the type of directory on the volume.

File Specifications and File Names

There is a difference between a file specification and a file name. A file name is a character string which is the external identifier by which a file is designated in a disc directory. A file specification is a character string which consists of the file name and several other optional items: volume_id, directory_path, passwords, and size_specifier. Not all of these items are allowed by every Directory Access Method or under all circumstances; for instance, directory paths and passwords are only used with the Shared Resource Management System's hierarchical directory organization.

Syntax of a File Specification

The syntax of a legal file specification is given by the following diagram:

```
file_specification ::= [volume_id] [directory_path] file_name [“[‘size_spec’]”]
                    ::= volume_id
```

In this notation, items between square brackets [and] are optional; quoted items appear literally. The definition just given means that a file_spec (file specification) may appear in one of two forms. The first form consists of an optional volume_id followed by a colon, then an optional directory_path, then a file_name which is not optional, then an optional size_spec. The second form consists just of a volume_id.

Examples of the first form are as follows:

```
File_x
A49ZB[10]
#4:LIBRARY,
BOOT:SYSTEM_P
#45:SYSTEM21/FILER
*EDITOR,
```

Examples of the second form are as follows:

```
BOOT:
#3:
*
:
#45:SYSTEM21/TOOLS
#45:
```

Syntax of a Volume Identifier

The volume_id selects one of up to 50 logical units known to the file system. If no volume_id is present, the volume used is the “default volume” selected by the Filer’s Prefix command. Otherwise, the volume is specified in one of two ways:

```
volume_id ::= “#” integer [ password ] “:”
           ::= name [ password ] “:”
```

In the first case, the integer is a two-digit number from one to fifty; for example, #23: is a volume_id. In the second case, the name is a sequence of characters. The length of the name and allowable characters depend on the particular directory organization used by the logical unit. For mass storage devices, the volume name is actually stored on the disc itself so it can be identified whenever it is inserted into a drive. For devices which have no directory, such as printers, the volume name is an arbitrary one supplied by the TABLE configuration program at boot-up time.

Example volume_ids of the second form are MYSYS: and PRINTER: Volume_ids may be 6 characters long in LIF directories, 7 characters long in Workstation 1.0 (UCSD-compatible) directories, and 16 characters long in SRM directories. LIF and SRM allow lowercase letters, while WS1.0 and unblocked devices ignore letter case. WS1.0 converts all characters to uppercase automatically.

In the case of a logical unit connected to a Shared Resource Management System, the volume_id takes a special meaning. The notation #5: refers to the current working directory of unit number five; the notation #5:/ refers to the root directory of the SRM with which unit number five is associated. The current working directory for any SRM volume is selected by the Filer's Prefix or Unit commands, or the What command of the Main Command level.

On the other hand, if the logical unit does not have a hierarchical directory, then the two volume_id notations (e.g., #11: and SYSVOL:) have the same meaning. This is the case for all local mass storage devices.

Syntax of a Directory Path (SRM)

Directory paths are only allowed when specifying files on SRM logical units. The syntax for a directory_path is:

```
directory_path ::= [ "/" ] { directory_name [password] "/" }
```

```
password ::= "<" word ">"
```

```
directory_name ::= file_name
                 ::= "."
                 ::= ".."
```

The use of curly braces "{" and "}" indicates that the information between them may occur zero or more times. As you can see, there are two special directory names allowed with the SRM. The name "." (a single period) refers to the current directory somewhere along a path to a file of an SRM logical unit. The name ".." refers to the parent of the current directory. Other file names occurring in a directory path are directories along the path to the one which contains the file being specified.

Passwords are sequences of up to 16 characters, which govern the access rights to a file or directory. They are given to a file either at creation time or by use of the Filer's Access command.

Note that a directory path doesn't appear by itself; it appears as part of a file specification, with the file name after the directory path. Examples of directory paths are:

/.<PASS1>/	Denotes root, using password "PASS1".
/USERS/ROGER/	Denotes directory ROGER in USERS, which is in root directory.
HERE/THERE/	Denotes directory THERE, found in HERE.
../THERE<PASS2>/	Directory THERE, found in the parent of the current working directory.

A directory path together with a volume_id might appear as follows:

```
#5:/WORKSTATIONS/SYSTEM13/
```

Occasionally there is need for a volume password, which is a case not covered by the above syntax. You may use either of the following forms:

```
#5<volpassword>:/dirname1/dirname2/filename
#5:<volpassword>/dirname1/dirname2/filename
```

That is, the volume password may either immediately precede or follow the colon separator.

Syntax of File Names

To the Pascal Workstation System, a file name is just a sequence of characters. The Directory Access Methods allow all printable characters. However, the following characters have significance either in Filer commands or in the overall specification of files under various Directory Access Methods (such as directory paths in hierarchical directories), and therefore should be avoided in file names:

- sharp ‘#’
- asterisk ‘*’
- comma ‘,’
- colon ‘:’
- equals ‘=’
- question mark ‘?’
- left bracket ‘[’
- right bracket ‘]’
- dollar sign ‘\$’
- less than ‘<’
- greater than ‘>’

Control characters (ASCII ordinal value less than 32) and blanks are removed by the File System before the name is ever presented to any Directory Access Method.

File Types Derived from File Names

The type of a file is determined when it is created, and is derived from a suffix (the last characters of the file name). Once the file type is determined, a type code is recorded in the directory, and changing the file name won’t change its type.

Suffix	File type
.ASC	LIF ASCII text file
.TEXT	WS 1.0 / UCSD compatible text file
.CODE	Pascal 2.0 object code
.BAD	File covering bad area of disc
.SYSTEM	Boot image file
No Suffix	“Data” file

File Names (LIF)

The LIF Directory Access Method (DAM) generally allows any ASCII character to be used in a file name. This is contrary to the HP LIF Standard, which states that file names must be composed only of upper-case letters, digits, and the underscore ‘_’ character. Note that upper and lower case letters are distinct. File names stored in LIF directories are always exactly 10 characters.

The LIF DAM recognizes only upper case suffixes.

The 10-character file name length would be a very severe restriction when four or five characters are required for a suffix. To ease this problem, the LIF DAM performs a transformation on the file name which compresses the suffix if one is present. The transformation occurs automatically when a LIF directory entry is made, and it is reversed automatically before the file name is ever presented to any program or to the user.

This process is usually completely transparent to the Pascal user, although its effects may be seen when a LIF directory is examined from the BASIC language system. It sounds complicated and dangerous, but in practice it is very smooth. Most people would never notice it if they weren’t told.

Here is how the LIF DAM changes a name before putting it into the directory.

1. Look for a standard suffix (for example, “.ASC”).
 - a. If a suffix is found, the suffix characters are removed from the name, leaving a trailing period. If this name is longer than 10 characters, including the period, then an error is reported.
 - b. If no suffix is found, and the file name contains less than 10 characters, the file is assumed to be a Data file and the name is put into the directory unchanged. If no suffix is found, but the file name is exactly 10 characters in length and the last character is an A, B, C, S, or T, then an error is reported.
2. If the file is not a Data file and no error has been reported, the dot is replaced by the first letter of the suffix; for instance, the .ASC suffix is replaced by A. If the name is now less than 10 characters long, it is extended to a length of 10 characters by appending underscore characters (_) to the name.

Using this algorithm, we would have the following examples:

File name	Translated name
‘A.ASC’	‘AA_ _ _ _ _ _ _ _ _ _’
‘charlie’	‘charlie ’
‘123456789.TEXT’	‘123456789T’
‘GollyGeeeT’	rejected because it would be confused with transformation of ‘GollyGeee.TEXT’

The reverse transformation is fairly obvious:

1. If the 10th character is a blank, do nothing; otherwise,
2. Remove all trailing underscores.
3. Compare the last non-underscore to the first letter of each valid suffix. If a match is found, remove that letter from the file name and append a dot '.' followed by the full suffix.
4. If no suffix match is found, use the original file name.

File Names (Workstation 1.0 Directory)

The Workstation 1.0 (UCSD compatible) DAM allows file names of up to 15 characters including the suffix. Any lower-case letters are transformed to upper-case, so that 'a.text' and 'A.TEXT' denote the same file.

File Names (SRM System)

The SRM itself allows almost any file name. The Pascal system removes blanks and control characters from file names.

However, the Pascal SRM Directory Access Method takes the "<" character to denote the beginning of a password. All characters up to the next ">" character are part of the password, so that <<<<<<<<> is a (poorly chosen) password. Passwords may be up to 16 characters long.

File Size Specification

The last, optional part of a file specification is the file size specifier. If present, its syntax is

```
size_spec ::= “[” integer “]”
           ::= “[*]”
```

This specification only takes effect if a new file is being created with REWRITE, OPEN, APPEND or APPEND with OPEN. If the file already exists, the file system tries to make it at least the size specified. The size is ignored for RESET.

In the first form, the integer gives the number of 512-byte blocks to be allocated to the file. For instance [100] would cause allocation of 51 200 bytes.

The second form [*] specifies that the file is to be allocated either (half of the largest free space) or (the second largest free space), whichever is larger.

If no size specifier is present when space for a new file is being allocated, the largest free area is assigned to the file.

For files stored in the SRM, the first extent allocated to the file will be contiguous and of the size specified if possible.

Several Directory Organizations Allowed

HP LIF (Logical Interchange Format) is the default directory format used by your Pascal Language System. There are many (mutually incompatible) ways to organize files and directories on a disc. LIF is an HP standard disc organization used to transport files between computers made by Hewlett Packard Company. The HP Series 200 BASIC Language System also supports the LIF directory structure on your Series 200 computers.

In addition, your Pascal workstation understands two other disc directory organizations. The WS1.0 format was the primary disc directory format used by the Pascal 1.0 Language System. Your Pascal workstation also supports the hierarchical directory structure used by the Shared Resource Management System. The SRM and hierarchical directories are discussed as a separate topic later in this section. The WS1.0 format is compatible with the widely used UCSD* Pascal system.

File Name Suffixes and File Types

Here are four examples of legal file names:

```
FILEINTRO.ASC
FILEINTRO.TEXT
TAPEBKUP.CODE
DATAFILE
```

The first three file names have a suffix. This suffix is part of the file name, so `FILEINTRO.ASC` and `FILEINTRO.TEXT` are different files. The suffix was appended to specify the file type when the file was created. The file type is stored in the directory along with the file name. Thus, the file type would *not* be changed if you later changed the file name by removing or modifying the suffix. You can see the file type of each file by listing the directory using the Filer's Extended Directory List command.

The suffixes recognized by the Pascal 2.0 File System (and later versions) are shown below:

- .ASC These files are HP Logical Interchange Format (LIF) ASCII files. It is intended to be the method for interchanging data files among various HP computers. Information stored in a .ASC file is stored as individual logical records. Each record has a two-byte length header and contains an even number of bytes. (A pad character is added, if necessary, to make an even number of bytes.)
- .TEXT Text files are the default type of file produced by the Editor. They follow the WS1.0 (UCSD-compatible) format. .TEXT files consist of a 1024-byte header containing Editor environment information, followed by compacted text in 1024-byte pages. Each line of information with more than one leading blank begins with a Data Link Escape control character (DLE, ASCII code 16). This character is followed by a one-byte "indentation" code; its binary value is calculated by adding 32 to the number of initial blank characters in the line. (Lines with zero or one leading blank merely put the actual line there; there is no DLE/leading blanks compression.) Each line is then terminated by a Carriage-Return control character (ASCII code 13). If a line will not fit at the end of a 1024-byte page, then the whole line is moved to the beginning of the next page, and the remainder of the previous page is padded with ASCII nulls (`chr(0)`).

<code>.CODE</code>	A <code>.CODE</code> file is the object code produced by the Compiler, Assembler, or Librarian. This file is also called a library.
<code>.SYSTEM</code>	A <code>.SYSTEM</code> file is a special file recognized by the Boot ROM as a file containing an operating system (a “system Boot file”).
<code>.BAD</code>	A <code>.BAD</code> file is used as a permanently cover failed disc sectors. Use the Filer’s Make command to make a file of type <code>.BAD</code> over the defective sector of the disc media. This type of file should only be used as an emergency measure, until the defective disc can be replaced.
<code><no suffix></code>	A file whose name at the time of creation does not end in one of these suffixes is said to be of type <code>Data</code> .

The Pascal operating system utility programs (e.g., Editor, Filer), in many circumstances, automatically append the appropriate default suffix to a file’s name. (Note that the only time the Filer appends a suffix is in the `Get` and `Save` commands.) For instance, when loading a file into the Editor, just type the file name without a suffix. The Editor assumes that in normal circumstances you will want to edit a `.TEXT` file and will automatically add the suffix. Of course, if you wish or need to specify a suffix, you may. For instance, if you want the Editor to load another type of file, then the correct suffix must be specified. If the file has no suffix, place a period at the end of the file name. The period stops the Editor from adding the `.TEXT` suffix. If you try to specify a file type that the subsystem can’t work with, such as a `.CODE` file in the Editor, you may get various kinds of probably undesirable results. In this example, depending on how you access the file and the mass storage device used, you could get an error message reading “Illegal I/O request”, a “No workfile found” message, or myriad empty lines.

Automatic suffixing is very convenient. For instance, you might write a program with the Editor and call the output file `WORK`. The Editor automatically appends `.TEXT`. When you use the Compiler to compile `WORK`, the compiler automatically appends `.TEXT` to the source file name, and `.CODE` to the output file name. Although there are two files, you only need to remember one name. To execute `WORK.CODE`, you need only type the following (from the Main Command Level):

`Select` `WORK` `Return`
 or
`EXECUTE` `WORK` `ENTER`

Suppressing the Suffix

On the other hand, you may wish a file name which has no suffix. You can suppress the automatic appending of a suffix by typing a period as the last character in the file name. For instance, to create a file of type `Data` with the name `AFILE`, just tell the Editor to save your file as “`AFILE.`”. The period suppresses the default `.TEXT` suffix and implicitly directs the Editor to create a file of type `Data`. Likewise, the Librarian and Compiler will automatically append `.TEXT` or `.CODE` to file names unless you tell them not to with the period.

System programs like the Editor don't have the .CODE suffix attached to their file names. This protects them against accidental destruction by a wildcard purge operation on all .CODE files. If you wish to permanently load a system program (which have no suffix) into memory with the Permanent command, then you must append a dot to the file name. For example, to load the Editor, type:

```

 EDITOR. 
or
 EDITOR. 

```

Without the period, the system would try to load EDITOR.CODE, which is not what you want.

Translating Files from One Type to Another

Sometimes you may want to translate the contents of a file from one file type to another. For instance, you may have a file of type .TEXT, created by the Editor, and wish to read it with the BASIC system. BASIC understands the LIF ASCII (.ASC) format, but not the .TEXT format. You can use the Filer's Translate command in this situation. A typical dialogue would be:

```

Translate what file?
EXAMPLE.TEXT  or 
Translate to what?
EXAMPLE.ASC  or 

```

For Translate to make sense, the source file must contain data that is textual in nature; attempting to translate a .CODE file, for example, would not make sense.

Translating Text Files to the Printer

Another situation where translation is required is to move a file from a disc volume to the printer. The file may be a .TEXT, .ASC or DATA file. The way such files are stored on the disc is not compatible with unblocked devices (such as the printer), so you must use the Translate command. Just type in:

```

Translate what file?
WORK.TEXT  or 
Translate to what?
PRINTER:  or 

```

This example illustrates several points. First, in the Filer environment you must always specify the complete file name including the suffix. Second, to send a file to a device like the printer which has no directory, there is no point in specifying a file name. Just use the volume name. Had you specified a file name after PRINTER: the Filer would have given you an error message.

Wildcards

In the Filer environment you can specify a particular file or set of files by giving a pattern which identifies the files you want. These patterns include special characters called **wildcards**.

For example, we can use the wildcard = (equal sign) to list a subset of the file using the Filers List Directory command. From the Filer subsystem, press:

L

The computer responds with:

List what directory?

Respond with:

FILE= **Return** or **ENTER**

FILE= uses the equal sign wild card to specify all files whose names begin with FILE and end with any sequence of characters. Using our example system, this command sequence would produce:

```

SYSVOL:          Directory type= LIF level 1
created  9-Aug-82 21.13.37 block size=256
changed  9-Aug-82 21.13.37 Storage order
...file name...  # blks   # bytes  last chng

FILEINTRO.TEXT          64       16384 28-Oct-82
FILEINTRO.ASC           73       18688 28-Oct-82
FILES shown=2 allocated=4 unallocated=76
BLOCKS (256 bytes) used=201 unused=4499 largest space=4493

```

Notice what happened here. The Filer recognized that the response to the prompt, "List what directory?", specified not just a volume name but a set of files within that volume.

More than one wild card may appear in a single file specification given to the Filer, allowing you to easily describe some rather complex operations. For instance, you can copy all the files on unit #13 whose names contain the characters INT to the system volume by means of this command sequence:

```

F
Filecopy what file?
#13:=INT= Return or ENTER
Filecopy to what?
*$ Return or ENTER

```

This example uses the destination wildcard “\$”, which means “use the same name as the source file had”. The command locates each file on unit #13 whose name matches the pattern, and writes a new copy with the same file name on the system volume. Remember that * is shorthand for the name of the system volume.

You can use “?” as a wild card instead of “=”. Question mark works like equals, except that for each file whose name matches the specification, the Filer will ask if you want to perform the operation. For example, to have the Filer change each file name on the default volume beginning with FILE into a file name beginning with WORK, type in:

```

C
Change what file?
FILE? Return or ENTER
Change to what?
WORK= Return or ENTER

```

This would for example turn FILE_ONE.TEXT into WORK_ONE.TEXT. Each time the specification is met, the Filer will present what it has found and ask if the process should be completed for the entry. Answer with Y for yes or N for no each time you’re asked.

File Names to Avoid

The file system won't prevent you from creating file names containing wildcard characters, but you'll be sorry if you do. The Filer will think such file names are wildcard specifications instead of simple file names. For instance if you created a file called `=.TEXT`, then used the Filer sequence:

```

  R
Remove what file?
=.TEXT Return or ENTER

```

the Filer would remove every file whose name ends in `.TEXT` in the default volume!

Should you ever accidentally create a file with a wildcard in its name in volume `VOLNAM`, you can get rid of it this way:

```

  R
Remove what file?
VOLNAM:? Return or ENTER

```

This will cause the Filer to offer to remove each file in the directory `VOLNAM:.` You can then remove the problem file, and retain the other files.

Allowable File Names

What file names are allowable depends on the type of directory used on the volume in which the file resides. In other words, the directory organization makes the file name rules. The exact rules for file names are given in the section Programming with files in this chapter. Here is a summary of the rules.

It is wise to choose names consisting of alphabetic letters and digits; if you want a punctuation mark within a file name, a hyphen, an underscore, or period is acceptable. Blanks are removed from file names.

In LIF directories and SRM directories, upper and lower case letters are distinct; "CHARLIE" is not the same file as "Charlie". In WS1.0 directories lower-case letters in a file name will automatically be converted to upper-case. This exception makes it easier to use wildcards to move files from one type of directory to another. Only upper case suffixes are allowed in LIF directories. Lower case suffixes in LIF directories will cause an error.

Don't use the following characters:

"\$", "?", "="	Filer wildcard characters.
"*", ":", "#"	Used in specifying volumes.
"/", "<", ">"	Have special meaning with the Shared Resource Manager.
"[", "]"	Used to specify the size of a file when it is created.
control characters	Control characters are automatically removed from file names.
" "	Blanks are removed from file names.

File Name Length

In LIF directories, file names (without suffix) are limited to 9 characters. If the last character in the file name is **not** an A, B, C, S, or T, then 10 characters can be used. If a suffix is present, up to 9 characters may precede the dot and suffix.

In WS1.0 directories, file names may be up to 15 characters **including** the suffix.

In SRM directories, file names may be up to 16 characters **including** the suffix.

No Room on Volume

Obviously there is a limited amount of space in a disc volume. When there is no room on a volume to create a new file, the system will report an I/O error.

You may be able to solve this problem by using the Filer's Krunch command. This command consolidates all of the volumes free space by moving all of the files on a volume to the front of the volume

Both the LIF and WS1.0 directory organizations are designed for "contiguous file space allocation". This means that when space is reserved for a file, the disc sectors set aside have sequential numbers. For instance a file requiring 3 sectors might get sectors 26, 27 and 28; or 31, 32 and 33. Files would **not** be allocated sectors 13, 56 and 2, because those sectors are not logically adjacent. To go back to the analogy with file folders in a drawer, if you had a file too big for one folder you might put it in two or three folders; but you'd want store them next to each other, not in random places in the drawer.

When a file is purged, all of its sectors are again available for use by another file. As files are created and purged, the disc space usage will develop "holes" of free space between valid files. This is called "fragmentation". It's possible for a considerable amount of free space to exist in the volume, yet be unusable because it is in pieces too small to use. Since files tend to be small compared to the total space on a volume, this problem usually occurs when the volume has relatively little free space left.

To see how fragmented your volume is, use the Filer's Extended Directory List command. This command lists both the files and the empty space on the volume.

The Shared Resource Management System

The concepts presented so far have all been applied to local mass storage devices. The same concepts extend naturally to deal with shared mass storage.

The Shared Resource Management System (SRM) allows several workstations (computers) to be connected into a network that allows sharing of files and resources. This network is controlled by a system controller. Since files can now be shared between several users, a new directory structure is needed. Setting up the SRM system is not described in this manual; see the SRM documentation for that information. Configuring your workstation to access an SRM system is described in the Special Configurations chapter.

Hierarchical directories

The Shared Resource Management System uses a hierarchical directory structure to organize its files. This directory structure is a multi-way tree data structure. That is, the first, or top directory in the structure is called the **root directory**. Subordinate to the root directory are other directories which, in turn, may have further subordinate directories. Each directory may contain files or other directories. When a directory contains only files, it is called a **leaf directory**. All files can be called **leaf files**. The drawing below shows a hierarchical directory structure.

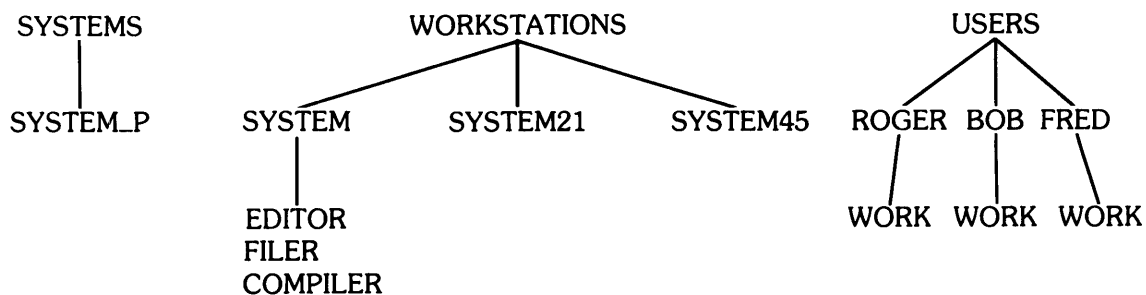

The directory SYSTEMS is a special directory used by the BOOT ROM, version 3.0 or newer, to automatically load operating or language systems.

The directory USERS has three subordinate directories: ROGER, BOB, and FRED. Each subordinate directory has a single file called WORK. Each file and directory is uniquely specified by the list of directories from the root to the file. That means several files of the same file name can exist without confusion if they are in different locations in the directory structure.

To save space, the Filer's Duplicate Link command can be used to link a file into a directory other than its original location. This allows you to have access to a file, such as the Compiler or Editor, without making an extra, unnecessary copy. See the Filer Chapter of this manual for more information.

Once a duplicate link has been set up, if the directory is purged, what happens to the link? Only the purged directory loses access to the file. All other directories with links to the file can still find it. The disc space allocated to the file is only reclaimed when no directories have links to it.

Notation

Hierarchical directories are a simple concept, but we need some specialized words and notation to talk about them.

The directory at the top of the hierarchy is called the “root” directory. If we want to refer to a file or directory which is immediately under the root, for instance WORKSTATIONS in the illustration above, we would write

```
/WORKSTATIONS
```

This is read as “slash WORKSTATIONS” or “stroke WORKSTATIONS”. The / indicates the root directory.

To go further down the hierarchy, for instance to SYSTEMS under WORKSTATIONS, write

```
/WORKSTATIONS/SYSTEM
```

and for another level yet

```
/WORKSTATIONS/SYSTEM/COMPILER
```

As you can see, to specify a file, the list of directories from either the root directory or the current working directory to the target file must be specified. The list is delimited with a /.

Such a sequence of strokes and filenames is called a directory path, since it indicates the path one must follow down the hierarchy to get to a particular file.

SRM Units and Volumes

A workstation connected to an SRM normally has units #5: and #45: set up for SRM access. The use of two units is in keeping with the idea that there are usually two special volumes (the system volume and the default volume) through which most file accesses occur.

If the workstation is booted from SRM, unit #45: will automatically be configured to be the system volume and unit number #5: will be available for use as the default volume. If there is local mass storage, the system volume can be any volume you desire. To set these volumes, use the What command from the Main Command Prompt.

Here is how the Filer's Volumes display might look right after booting up a workstation connected to the SRM and having no local mass storage:

```
Volumes on-line:
 1  CONSOLE:
 2  SYSTEM:
 5  # SRM:
 6  PRINTER:
45  * SYSTEM45:
Prefix is - SRM:
```

You can see that the system starts out with #5: as the default volume and #45: as the system volume.

Where do the names SRM: and SYSTEM45: come from? They are actually the names of particular directories in the SRM's hierarchy. In this example, the name of the SRM volume is SRM, and the workstation we are using is at node address 45. Since there is a directory SYSTEM45, it is selected as the system volume. All of this selecting is done by the TABLE program as it automatically configures the system each time you boot.

If you need to specify the SRM volume's password, you can do it by using this syntax:

```
SRM:/.<Password>
```

The SRM volume password is also the SRM root directory's password. That is, they specify the same thing.

Moving Up and Down the Hierarchy

It would be tedious to type a directory path every time you wanted to access a file. To avoid this, you can specify the **current working directory** using the Filer's Unit Directory command. The current working directory can be used as the "root" to specify subordinate files.

```
U
Set unit to what directory?
#5:/USERS/ROGER Return or ENTER
```

Once you have done this, unit #5: is in effect a volume named ROGER: which contains all the files under directory ROGER in the hierarchy. It's as if you had inserted a disc called ROGER: in a disc drive. If you now command the Filer with:

```
L
List what directory?
ROGER: Return or ENTER
```

it will list all the files in subdirectory ROGER:. You could also use the sequence:

```
L
List what directory?
#5: Return or ENTER
```

since directory ROGER: was installed in #5: by the Filer's Unit Directory command.

Suppose that under ROGER is another directory named MYSTUFF which contains more files. To list the files in MYSTUFF, use the sequence

```
L
List what directory?
ROGER:MYSTUFF Return or ENTER
```

The Filer will realize that MYSTUFF under volume ROGER is itself a directory, and list its contents. If MYSTUFF were not a directory, it would simply be listed as a file in directory ROGER.

You can move the current working directory still farther down the hierarchy in the obvious way. For instance to make MYSTUFF the current directory of #5:

```

U
Set unit to what directory?
#5:MYSTUFF Return or ENTER

```

There was no need to specify the entire pathname from the root, because MYSTUFF was already accessible as a file within volume ROGER.

A special notation is provided to move up the hierarchy. Two periods can be used to denote the “parent” directory of a file. For instance, after moving down to MYSTUFF, unit #5: could be moved back up to the parent directory ROGER by:

```

U
Set unit to what directory?
#5:.. Return or ENTER

```

To go up two levels, use the double-period twice, separated by a slash:

```

U
Set unit to what directory?
#5:../.. Return or ENTER

```

This can be executed all the way up to the root directory. Of course, if you want to get all the way to the top, it is easier to go there directly, using a stroke as the “name” of the root directory. For instance, while #5: is assigned to MYSTUFF you could list all the files in the root directory with the command sequence

```

L
List what directory?
#5:/ Return or ENTER

```

Default Volume vs. Current Working Directory

The current working directory concept is different from the default volume concept. Specifying a current working directory is like installing a disc into a drive unit. Specifying a default volume simply tells the file system what volume name to use when none is specified with a file name.

The two concepts can come together in the Filer's Prefix command. For instance, typing:

```

P
Prefix to what directory?
#5: /USERS/BIG_USER Return or ENTER

```

has two effects since #5: is an SRM unit. The current working directory of #5: is set to /USERS/BIG_USER, and the default volume name is set to BIG_USER. If we now type:

```

U
Set unit to what directory?
#5:.. Return or ENTER

```

the current working directory of #5: becomes USERS (the parent of BIG_USER). However the default volume name is still BIG_USER. So the command

```

L
List what directory?
: Return or ENTER

```

will fail with the message that BIG_USER is not on-line!

The same sort of mistake is commonly made with the system volume. Suppose the current working directory of #45: is SYSTEM45, and the COMPILER, EDITOR and other system files are under SYSTEMS. If the current working directory of #45: is changed, the Operating System won't be able to find the system programs since it thinks of them as SYSTEM45:COMPILER and so on. If this happens, you need to get into the Filer and restore the current working directory of #45:. How can you do so if the Filer is no longer on-line? You will need to execute the Filer by name, specifying a path all the way down from the root to wherever it is:

```

Select (EXECUTE)
Execute what file?
#45: /WORKSTATIONS/SYSTEM/FILER. Return or ENTER

```

Note the dot after the Filer's name. You don't want the system to append .CODE in this case.

SRM Concurrent File Access

The SRM system also provides the capability of several users concurrently accessing “shared” files. For further information on this capability, see the “Programming with Files” chapter of this manual.

SRM Access Rights

You can restrict the use of SRM files with special “access right” password-protection scheme. For further information on this capability, see the “Programming with Files” chapter of this manual. Also see the Access command description in the “Filer” chapter for more information on assigning and removing SRM passwords with the Filer.

The Editor

Chapter
4

Introduction

This chapter introduces the features of the Workstation Pascal Editor. The Editor enables you to create, change, store, and retrieve text files, which may be either programs or other textual documents. Like other parts of the system, the Editor has visual reminders (prompts) and uses single-keystroke commands.

The Editor is a cursor-based screen editor. The cursor, normally shown on the screen as a blinking underline character, shows where subsequent characters will be inserted into the text. You can rapidly access any part of the text file by moving the cursor to the desired location.

The programs and documents created by the Editor are usually stored as text (.TEXT-suffix) files, but can also be stored as ASCII (.ASC-suffix) or data (no suffix) files.

This chapter has four main sections:

- The first two sections, “Entering the Editor” and “A Sample Editor Session,” demonstrate how to enter and use the Editor by leading you through writing a short Pascal program.
- The next section, “A Closer Look,” presents more detailed information about the Editor.
- The last section, “Editor Commands,” contains an overview and summary of all the Editor commands, as well as a syntactic and semantic description of each command, in alphabetical order.

Once familiar with the Editor, you can use the overview/summary of the Editor commands for quick reference.

Entering the Editor

It is assumed that the Pascal System is already “up and running”.

```
Command: Compiler Editor Filer Initialize Librarian Run eXecute Version ?
```

This prompt tells you that you are at the system’s Main Command Level – the level from which all the Pascal subsystems (Compiler, Editor, Filer, etc.) are entered. Entry to any subsystem is accomplished by typing the first character of the name of the subsystem you wish to enter.

Note

If you have a system workfile (created in a previous Editor session or in the Filer subsystem), first go into the Filer and use the Save, New and Quit commands to store and release the workfile. Then exit the Filer subsystem.

When the system is delivered to you, the Editor is on the disc labeled “ACCESS:” and is named:

```
ACCESS:EDITOR
```

Now press the key. You can use uppercase or lowercase: the computer treats both exactly the same while at the Main Command Level. If the Editor code file is on-line, the screen clears and displays:

```
Loading 'ACCESS:EDITOR'
```

If you copy the Editor code file to another disc, which has a different volume name, you should tell the operating system where to look for the Editor. (See the What command in Chapter 1)

Creating a Text File

When you enter the Editor, the following prompt is displayed.

```

Editor [Rev. 3.0 15-APR-84]

Copyright 1982 Hewlett-Packard Company.
All rights reserved.

No workfile found.
File? (<ent> for new file, <stop> exits)
:

```

This tells you that you are entering the Editor without a system workfile and requests a file name. Respond by pressing the **Return** or **ENTER** key to instruct the Editor to create a new text file for your use. The file will be named later when leaving the Editor.

The Editor can also be directly entered from the Compiler subsystem. This is covered in the Compiler chapter.

The Editor Prompt

The screen clears again and displays the Editor prompt on the top line:

```
>Edit: Adjst  Cpy  Dlete  Find  Insrt  JMP  RPlace  Quit  Xchns  Zap ?
```

You are now in the Pascal Editor with a new file. The Editor prompt shows the most common commands used in the Editor. This is called a “prompt” because it prompts you to take some action, i.e., give the Editor a command.

The first character of the prompt line (> or <) indicates the direction of cursor movement (i.e., the way the cursor moves when **TAB**, **Return** or **ENTER** keys, or the space bar is pressed). When the “>” character is displayed, the cursor will move “forward” in the text. Similarly, when the “<” character is displayed, the cursor will move “backwards” in text. Pressing **>**, **.**, or **+** will set forward direction, while **<**, **,**, or **-** will set reverse direction.

The character indicates the direction that searches take place in the Find and Replace commands, also the Delete and Page commands.

The prompt line shows a partial list of commands available in the Editor. To see the rest of the commands, type **?**. The screen shows the Editor’s alternate prompt:

```
>Edit: Marsin Page Set environment Verify ? [3.0]
```

This alternate prompt also shows the revision number of the Editor enclosed in brackets. Type **[?]** again and the main Editor prompt reappears.

All of the commands in the Editor are initiated by typing a single key corresponding to the first character of the command shown in the Editor prompt. Again it does not matter whether the character is uppercase or lowercase — the Editor accepts either one. Now that you are in the Editor and understand something about the Editor prompt, let us begin the sample Editor session.

A Sample Editor Session

Feel free to skim this section if you are familiar with screen oriented editors. You may even prefer to try out the Editor commands on your own. If you choose to experiment with the Editor commands, do not use any files you cannot afford to lose.

If you are still reading, step through the following examples on your machine. Doing the examples will help you learn faster than just reading about them.

Creating Text

The most direct way to generate text is with the Insert command. Initiate the Insert command by pressing **[I]** and the screen responds with the following prompt:

```
>Insert: Text <bs>, <clr ln>   [<sel> accepts, <sh-sel> escapes]
```

While in the Insert command, any of the regular character-entry keys (the main keyboard) or the numeric pad keys (on the right) may be used. With a few exceptions, using the key clusters on the top of your keyboard or **[CTRL]** key sequences is not advised. (Most of these keys generate a question mark (?) while in the Insert command. Others have results which may surprise you). Use **[CTRL]** key sequences only if you are working with Stream files. (See Chapter 1 for details on the use of Stream files). The exceptions are the cursor control keys, **[BACK SPACE]**, **[CLR LN]**, **[ANY CHAR]** and **[DUMP ALPHA]** (which sends a copy of the screen image to your printer).

Let's start typing in a Pascal program now. Press **[Return]** or **[ENTER]** and then type the text shown in the following display. If you make a mistake, use **[BACK SPACE]** to move the cursor backward and then type the correction. You can use **[CLR LN]** to delete the most recently inserted line. Prompts in the Editor always show actual key options in the form of a key abbreviation shown in (<) and (>) symbols.

The word "binary" is misspelled in the display; leave it that way for now.

Notice that when you press **[Return]** or **[ENTER]** after typing the first line, the cursor returns to column one (the column that the "P" in PROGRAM is in). To type the second line, use **[TAB]** to indent the comment enclosed in the braces. The next time you press **[Return]** or **[ENTER]** the cursor automatically returns to the indented position created in the previous line. This indenting feature proves handy when writing Pascal programs as it adds visual clarity to the code.

```

>Insert: Text <bs>, <clr ln>    [<sel> accepts, <sh-sel> escapes]

PROGRAM Binery_search(INPUT,OUTPUT);
  {This program does a binary search
   on an array of characters to find a
   "key" character input by the user.}

```

The display above shows what your screen should look like after the first few lines are typed. To move the cursor back to column one for the next line, press and hold **BACK SPACE**. The keyboard automatically “repeats” any key that remains pressed.

```

>Insert: Text <bs>, <clr ln>    [<sel> accepts, <sh-sel> escapes]

PROGRAM Binery_search(INPUT,OUTPUT);
  {This program does a binary search
   on an array of characters to find a
   "key" character input by the user.}

VAR
    done : BOOLEAN;
    key  : CHAR;
    alpha : ARRAY [1..26] of CHAR;
    loop, top, mid, btm : INTEGER;

```

When your screen looks like the display above, press **Select** (**EXECUTE**) to complete the insertion. The screen displays the Editor prompt along with the text you inserted. Next we will save this program fragment on the disc and then return to create more text.

Storing Your File and Returning to the Editor

This section shows how to save a file on a disc and then return to the Editor. It is a good idea to do this periodically when writing and editing large text files. Although power outages occur infrequently, it can be devastating to lose an entire session of work. Occasional updating of your file secures your work against this possibility.

Press **Q** to initiate the Quit command. The screen clears and displays:

```

>Quit:
  Update the workfile and leave
  Exit without updating
  Return to the editor without updating
  Write to a file name and return

```

Before typing anything, find the disc labeled **DOC :** and insert it in your disc drive in place of the disc labeled **ACCESS :**. Now press **W** and the screen displays:

```

>Quit:
  Name of output file (<ent> to return) -->

```

The prompt is requesting a file specification. Respond by typing `DOC:BINSEARCH` followed by **Return** or **ENTER**. The screen now displays:

```
>Quit:
Writing..
Your file is 275 bytes long.
Exit from or Return to the editor?
```

The exact number of bytes may differ with what is indicated in the line above.

Now press **R**. The screen fills with your text and the cursor is positioned where it was when you initiated the Quit command.

Copying Text from Other Files

The Insert command is the most common way of creating text but other commands are available. The Copy command allows you to copy specified text from another file.

On the `DOC:` disc is a text file called `BINDOC.TEXT` which you are going to copy into your current text file. Position the cursor by pressing **J** and then **E** (for Jump to End). This command sequence moves the cursor to the end of your text file. (More on the Jump command later). Now press **C** and your screen displays:

```
>Copy: Buffer File <sh-sel>
```

The Buffer option is demonstrated along with the Delete command later in this section. Now press **F** (to Copy from a File) and the new prompt appears:

```
>Copy: File[marker,marker] ?
```

The system is requesting a file specification. Type `DOC:BINDOC` and press **Return** or **ENTER**. The `.TEXT` part of the file name does not have to be typed; it is automatically supplied by the Editor. The volume name, `DOC:`, had to be specified because otherwise the Editor would look for the file on `ACCESS:`, the default volume. See Chapter 2 for further information on the default volume.

The entire file `DOC:BINDOC.TEXT` has been copied into your current text file in memory. The copy always occurs at the cursor position. This is why you moved the cursor to the end of the file before the copy. The screen now appears as follows:

```

>Edit: Adjst Cpy Dlete Find Insrt Jmp Rplace Quit Xchns Zap ?

PROGRAM Binery_search(INPUT,OUTPUT);
  {This program does a binery search
  on an array of characters to find a
  "key" character input by the user.}

VAR      done : BOOLEAN;
         key  : CHAR;
         alpha : ARRAY [1..26] of CHAR;
  loop, top, mid, btm : INTEGER;

BEGIN {Binery_search}
done:=FALSE; btm:=0; top:=26; {initialize}
FOR loop:=1 TO top DO alpha[loop]:=CHR(loop+64);
WRITELN('Type uppercase character for a key');
READ(key); WRITELN;
WHILE NOT done DO
BEGIN   {This is the actual binery search}
  mid:= ROUND((top + btm)/2);
  IF key = alpha[mid] THEN done:= TRUE
  ELSE IF key < alpha[mid] THEN top:=mid
  ELSE btm:=mid;
  IF top=btm THEN BEGIN

```

To Copy only part of a file, a beginning and ending marker are specified. These markers must have been previously set in the text file being copied. (See the Set command in the "Editor Commands" section of this chapter for further information on setting markers). Now that you have your screen full of text, let's look at the general pattern of leaving an Editor command and some ways to move the cursor.

Confirming or Aborting Commands

The **Select** (**EXECUTE**) key tells the Editor to accept all of the insertions or changes you have made in the text file. The cursor remains where it was when you pressed **Select**. Conversely, holding down the **SHIFT** key while pressing **Select** (shown as **SHIFT**-**Select**) tells the Editor to ignore all of the changes made since initiating the command and leaves the cursor where it was when the command was initiated. (The **ESC** key also performs this function on keyboards so equipped.) Both key sequences (**Select** and **SHIFT**-**Select**) return you to the main Editor prompt.

The changes are stored in the computer's internal read/write memory but are not made permanent on a mass storage medium until you exit the Editor and use one of the options that writes the information to a file.

Not all commands let you abort changes with **SHIFT**-**Select** and not all require **Select** for acceptance. For instance, the Copy from buffer command is accomplished by simply pressing **C** **B**. The text is copied and the Editor's prompt appears with no other action on your part. The specifics of how each command uses these keys is discussed as each command is presented.

Moving the Cursor

Now that you have some text on the screen, experiment with positioning the cursor. The arrow keys, the **Return** and **ENTER** keys, the **Tab** key, the space bar, the mouse, and the cursor wheel (also called the knob) all move the cursor. The wheel normally moves the cursor left or right, depending on which direction you turn it. If you hold down the **Shift** key while turning the wheel, the cursor moves up or down while remaining in the same column position.

An integer in the range 1 to 9999 can be used as a "repeat factor" before all of the cursor control keys and some of the Editor commands. (Repeat factors must be in the range 1 to 4095 for use with the **TAB** key). The result will be the same as if you had pressed the key that many times. For instance, typing the number 42 and then pressing the space bar causes the cursor to move 42 characters in the current direction.

The Jump Command offers another means of cursor positioning. Press **J** and the top of your screen displays:

```
>JUMP: Begin End Marker <sh-sel>

PROGRAM Binary_search(INPUT,OUTPUT);
  {This program does a binary search
   on an array of characters to find a
   "Key" character input by the user.}
```

Typing **B** causes the cursor to jump to the beginning of the file, in this case directly above the (P) in PROGRAM, and the Editor's main prompt reappears. Now press **J** then **E** and the cursor moves to the end of your text file as shown in this partial display:

```
IF key = alpha[mid] THEN done:= TRUE
ELSE IF key < alpha[mid] THEN top:=mid
ELSE btm:=mid;
IF top=btm THEN BEGIN
  done:=TRUE; mid:= -1;
  END;
END;
IF mid>0 THEN
  WRITELN('Key -',key,'- is in position ',mid:2)
ELSE WRITELN('Key -',key,'- was not found');
END._
```

You can also Jump to previously set markers (see the Set command in the "Editor Commands" section) by typing **J** **M** followed by a marker name.

The beginning and end of a file are simply the first and last characters in the current text file. In this case, the position directly above the (P) in PROGRAM and the space following the final word END, are the first and last characters, respectively. The Editor adjusts these internal pointers automatically as the text file is changed.

The Page command lets you move through a file one screen (23 lines) at a time. It is roughly equivalent to using a repeat factor of 23 with or depending on the direction shown in the prompt. If the cursor is not at the end of the file, press . Now type < to change from the forward to the backward direction and press (for Page). The top half of your screen now looks like:

```

<Edit: Adjst Cpy Dlete Find Insrt Jmp Rplace Quit Xchns Zap ?
PROGRAM Binery_search(INPUT,OUTPUT);
  {This program does a binary search
   on an array of characters to find a
   "key" character input by the user.}

VAR
    done : BOOLEAN;
    key : CHAR;
    alpha : ARRAY [1..26] of CHAR;
    loop, top, mid, btm : INTEGER;

BEGIN {Binery_search}
  done:=FALSE; btm:=0; top:=26; {initialize}

```

Notice that the cursor is positioned at the VAR declaration in the program which is 23 lines from the end of the file. Since the cursor movement direction is still backward, type > to change it to forward. The Page command is especially handy when moving through a large file.

Deleting Text

Now position the cursor under the first bracket on the second line of the program and press . This initiates the Delete command. Moving the cursor removes text from the file. To restore the text, use any cursor control key which moves the cursor back over the area where text has been removed. The key and the cursor wheel work well for this.

Upon pressing , the screen displays:

```

>Delete: < > <Moving commands> [<sel> deletes, <sh-sel> aborts]
PROGRAM Binery_search(INPUT,OUTPUT);
  {This program does a binary search
   on an array of characters to find a
   "key" character input by the user.}

VAR
    done : BOOLEAN;
    key : CHAR;
    alpha : ARRAY [1..26] of CHAR;
    loop, top, mid, btm : INTEGER;

```

First make sure the direction is forward (>) as shown above and then type 4 followed by **(Return)** or **(ENTER)**. This uses a repeat factor and moves the cursor 4 lines, deleting text as it goes. (The deleted text is temporarily stored in the copy buffer). Now press **(Select)** (**(EXECUTE)**) and the screen displays:

```
>Edit: Adjst Cpy Dlete Find Insrt Jmp Rplace Quit Xchns Zap ?
PROGRAM Binery_search(INPUT,OUTPUT);
VAR
    done : BOOLEAN;
    key : CHAR;
    alpha : ARRAY [1..26] of CHAR;
loop, top, mid, btm : INTEGER;
```

Before typing any other keys or moving the cursor, press **(C)** then **(B)**. This takes the information stored in the copy buffer and copies it into the text file beginning at the current position of the cursor. Since the Delete command just filled the buffer with the text that was removed, the Copy from Buffer command simply returns the screen to its state before the Delete command was entered.

The top of the screen should now display:

```
>Edit: Adjst Cpy Dlete Find Insrt Jmp Rplace Quit Xchns Zap ?
PROGRAM Binery_search(INPUT,OUTPUT);
    {This program does a binery search
    on an array of characters to find a
    "key" character input by the user.}
VAR
    done : BOOLEAN;
    key : CHAR;
    alpha : ARRAY [1..26] of CHAR;
loop, top, mid, btm : INTEGER;
```

Recovering Deleted Text

As the example shows, even if you complete the Delete command using **(Select)** (**(EXECUTE)**) instead of **(SHIFT)**-**(Select)**, you can still change your mind and recover that text using the Copy (from buffer) command. Take care not to wait too long or depend on this too heavily as there are other commands which alter the contents of the buffer. None of the cursor movements alter the buffer in any way.

Moving and Duplicating Text

The sequence of the Delete and Copy (from buffer) commands provide a convenient way of moving text to different parts of the file. For instance, in the operation just completed above, any of the cursor control keys could have been used to reposition the cursor after the deletion occurred and before the Copy from the buffer was executed.

The buffer is "filled" with the text affected by the Delete command and by the Insert and Zap commands. Doing a Copy from buffer sequence does not change the contents of the buffer. This feature lets you copy the same text in numerous places.

Whether the Delete command was completed with the **Shift** **Select** (**EXECUTE**) or **Select** (**SHIFT**)-**EXECUTE** sequence makes no difference to the copy buffer. What this means in practical terms is that the Delete command allows you to fill the buffer without affecting your original text.

So if you want to duplicate the text instead of moving it to a different location, use the sequence:

1. Press **D** to initiate the Delete command.
2. Cause some cursor movement. This deletes text and stores it in the copy buffer.
3. Press **SHIFT**-**Select** to recover the text that was just deleted.
4. Reposition the cursor to where you want to duplicate the text.
5. Press **C** **B** to execute the actual copy at the new cursor position.

Changing and Altering Text

Mistakes or necessary changes in a program or text file are not always obvious when creating text. The Editor features commands which allow you to go back and make changes when needed. These are the Replace and eXchange commands and the Delete/Insert sequence. These will be demonstrated by making corrections to the sample program text.

Press **J** **B** to move the cursor to the beginning of the file and then type 5 and press **R** to initiate the Replace command. The prompt at the top of the screen appears:

```
>Repl[5]: L U <tar#><sub>=>
```

Press **L** and **V** to tell the Editor that you are going to give it a Literal string and that you want to operate in the Verify mode. A Literal string may occur as a word or as part of a word. The alternative is a Token string which must occur as a word. The Verify mode makes the changes one at a time after asking you if you want this occurrence replaced. Now type:

```
/inery//inary/
```

The slashes are used to delimit the target and substitution strings. Any non-alphanumeric or non-control characters can be used as delimiters. This is necessary when the slash is part of the search string or replacement string. Notice also that “inery” is specified instead of “binery”. This is because two occurrences of the word are “Binery”. The two words are unequal.

After you type the final delimiter, the screen clears and displays:

```
>Repl[5]: <sh-sel> aborts,R replaces,' ' doesn't
PROGRAM Binery_search(INPUT,OUTPUT);
  {This Program does a binery search
  on an array of characters to find a
  "Key" character input by the user.}
```

The cursor is positioned behind the first occurrence of the string `in e r y`. Now press and watch what happens:

```
>Rpl[4]: <sh-sel> aborts,R replaces,' ' doesn't
PROGRAM Binary_search(INPUT,OUTPUT);
  {This program does a binary_search
   on an array of characters to find a
   "key" character input by the user.}

VAR      done : BOOLEAN;
         key  : CHAR;
         alpha : ARRAY [1..26] of CHAR;
loop, top, mid, btm : INTEGER;

BEGIN {Binary_search}
done:=FALSE; btm:=0; top:=26; {initialize}
FOR loop:=1 TO top DO alpha[loop]:=CHR(loop+64);
WRITELN('Type uppercase character for a key');
READ(key); WRITELN;
WHILE NOT done DO
BEGIN   {This is the actual binary search}
  mid:= ROUND((top + btm)/2);
  IF key = alpha[mid] THEN done:= TRUE
  ELSE IF key < alpha[mid] THEN top:=mid
  ELSE btm:=mid;
  IF top=btm THEN BEGIN
```

The first string in `ery` has been replaced with `inary`, the cursor is now positioned behind the second occurrence of the target string and the prompt shows that you can make four more replacements. Press the space bar (represented by ' ' in the prompt) to leave the string unchanged and the screen now displays:

```
>Rpl[3]: <sh-sel> aborts,R replaces,' ' doesn't
PROGRAM Binary_search(INPUT,OUTPUT);
  {This program does a binary search
  on an array of characters to find a
  "key" character input by the user.}

VAR
    done : BOOLEAN;
    key : CHAR;
    alpha : ARRAY [1..26] of CHAR;
    loop, top, mid, btm : INTEGER;

BEGIN {Binary_search}
  done:=FALSE; btm:=0; top:=26; {initialize}
  FOR loop:=1 TO top DO alpha[loop]:=CHR(loop+64);
  WRITELN('Type uppercase character for a key');
  READ(key); WRITELN;
  WHILE NOT done DO
  BEGIN {This is the actual binary search}
```

The cursor is now behind the occurrence of `Binary` following the `BEGIN` statement. Press **R** to replace this one and then press it again to replace the last occurrence of `binary`. The screen now displays:

```
>ERROR: Pattern not found. <space> continues.

PROGRAM Binary_search(INPUT,OUTPUT);
  {This program does a binary search
  on an array of characters to find a
  "key" character input by the user.}

VAR      done : BOOLEAN;
         key  : CHAR;
         alpha : ARRAY [1..26] of CHAR;
  loop, top, mid, btm : INTEGER;

BEGIN {Binary_search}
  done:=FALSE; btm:=0; top:=26; {initialize}
  FOR loop:=1 TO top DO alpha[loop]:=CHR(loop+64);
  WRITELN('Type uppercase character for a key');
  READ(key); WRITELN;
  WHILE NOT done DO
  BEGIN {This is the actual binary_search}
    mid:= ROUND((top + btm)/2);
    IF key = alpha[mid] THEN done:= TRUE
    ELSE IF key < alpha[mid] THEN top:=mid
    ELSE btm:=mid;
    IF top=btm THEN BEGIN
```

The prompt at the top of the screen tells you that the Editor could not find any more occurrences of the specified string in the file. The cursor is positioned at the final occurrence of the string but it has not yet been changed. Press the space bar and the Editor prompt reappears, the final occurrence of the string gets replaced and the cursor remains at the same place on the screen.

To correct the spelling of `binary` (which was intentionally skipped), use the `eXchange` command. Move the cursor to the `e` in `binary` in the second line of your program. Now press **X** and the screen shows:

```
>Xchange: Text <bs> <sh-sel> aborts <sel> accepts

PROGRAM Binary_search(INPUT,OUTPUT);
  {This program does a binary search
  on an array of characters to find a
  "key" character input by the user.}
```

Type the letter `a` and then press **Select** (**EXECUTE**). Pressing **Select** confirms changes made in `eXchange` and returns the Editor prompt. That's all there is to the `eXchange` command.

You should always position the cursor before initiating eXchange because this command cannot cross line boundaries; you can only make eXchanges on the line where the cursor is located.

The eXchange command is handy but the combination of the Insert and Delete commands is often a more effective way to change text. For example, to clarify the program by adding comments, position the cursor at the comment following the second BEGIN, press **D**, and press **TAB** once. The screen displays:

```

>Delete: < > <Moving commands> [<sel> deletes, <sh-sel> aborts]

PROGRAM Binary_search(INPUT,OUTPUT);
  {This program does a binary search
   on an array of characters to find a
   "key" character input by the user.}

VAR      done : BOOLEAN;
          key  : CHAR;
          alpha : ARRAY [1..26] of CHAR;
  loop, top, mid, btm : INTEGER;

BEGIN {Binary_search}
done:=FALSE; btm:=0; top:=26; {initialize}
FOR loop:=1 TO top DO alpha[loop]:=CHR(loop+64);
WRITELN('Type uppercase character for a key');
READ(key); WRITELN;
WHILE NOT done DO
  BEGIN { the actual binary search}
    mid:= ROUND((top + btm)/2);
    IF key = alpha[mid] THEN done:= TRUE
    ELSE IF key < alpha[mid] THEN top:=mid
    ELSE btm:=mid;
    IF top=btm THEN BEGIN

```

Using a combination of **TAB** and the space bar, delete everything between the two brackets and press **Select** (**EXECUTE**). Part of the screen looks like:

```

      :
      :
      :
WHILE NOT done DO
BEGIN      { }
mid:= ROUND((top + btm)/2);
      :
      :

```

Experiment with the Adjust command by pressing **L**, **R**, or **C**. These options move text to the left, right, or center. The values used to shift the text are the Left and Right margins of the environment (discussed below). Any of the cursor arrow keys as well as **BACK SPACE** and the cursor wheel can be used to Adjust text. Now return the line to its original position and press **Select**. Repeat factors are available for use with the Adjust command so that many lines of text can be shifted at one time.

Note

Think twice before using Adjust with large repeat factors. This is because **SHIFT**-**Select** (**SHIFT**-**EXECUTE**), which usually aborts all changes made by a command, is not available for exiting the Adjust command. Therefore, to recover the original format of your text, you would have to Adjust it again.

Now that the line is in its original place, press **A** (to initiate Adjust), type 3 **→** (to indent the text three spaces to the right), and then type 6 and press **↓**. Watch what happens: the cursor moves down six lines and shifts each line three spaces to the right. Thus, the Adjust command is useful for indenting entire blocks of text in a Pascal program.

The screen now looks like:

```
>Adjust: Ljust Rjust Center <arrow Keys> [<sel> to leave]
done:=FALSE; btm:=0; top:=26; {initialize}
FOR loop:=1 TO top DO alpha[loop]:=CHR(loop+64);
WRITELN('Type uppercase character for a Key');
READ(Key); WRITELN;
WHILE NOT done DO
BEGIN
    {This routine compares key to
    middle. A new top or bottom is chosen
    and a new middle computed. The loop
    continues until either Key = middle or
    the array is exhausted.}
    mid:= ROUND((top + btm)/2);
    IF Key = alpha[mid] THEN done:= TRUE
    ELSE IF Key < alpha[mid] THEN top:=mid
    ELSE btm:=mid;
    IF top=btm THEN BEGIN
        done:=TRUE; mid:= -1;
    END;
END;
IF mid>0 THEN
WRITELN('Key -',Key,'- is in position ',mid:2)
ELSE WRITELN('Key -',Key,'- was not found');
END.
```

Press **Select** (**EXECUTE**) to terminate the Adjust command. If you wish to make adjustments in other parts of your text file, exit the Adjust command using **Select** before moving the cursor from one area to another. Otherwise you may make unwanted adjustments to your text.

The Margin command lets you margin and fill your text according to a predefined “environment”. Margin operates on the paragraph where the cursor is located when **M** is pressed. A paragraph is any text delimited by any combination of blank lines, lines whose first non-blank character is the “command character” (see the Set environment command in the section “Editor Commands”), or the beginning or end of a file. The Margin command is executed completely by pressing **M**; no parameters or options are available.

Entering the Editor without a workfile or a named file (as you did earlier in this session) automatically sets (or defaults) the environment to the “program” environment. This environment is optimized for writing programs. When the Editor is entered with either a file name or a workfile, the environment associated with that file is the current environment.

You can alter the environment at any time using the Set (Environment) command. Once you have altered or redefined the environment and saved a text file on a mass storage medium, that environment is stored along with the text file and is used whenever the Editor is entered with that file.

Since you entered the Editor without a file, your current environment is the Editor’s “program” environment (the default supplied by the system). The Filling option of this environment is set to false (which disables the Margin command) so, if you press **M**, the screen displays:

```
>ERROR: Wrong environment <space> continues.
```

If Filling had been set True (with Auto-indent False), the Margin command would fill and Margin your program like this:

```
PROGRAM Binary_search(INPUT,OUTPUT); {This program does a binary
search on an array of characters to find a "Key" character input by
the user.} VAR done : BOOLEAN; key : CHAR; alpha : ARRAY [1..26] of
CHAR; loop, top, mid, btm : INTEGER; BEGIN {Binary_search}
done:=FALSE; btm:=0; top:=26; {initialize} FOR loop:=1 TO top DO
alpha[loop]:=CHR(loop+64); WRITELN('Type uppercase character for a
key'); READ(key); WRITELN; WHILE NOT done DO BEGIN {This routine
compares key to middle. A new top or bottom is chosen and a new
middle computed. The loop continues until either key = middle or
the array is exhausted.} mid:= ROUND((top + btm)/2); IF key =
alpha[mid] THEN done:= TRUE ELSE IF key < alpha[mid] THEN top:=mid
ELSE btm:=mid; IF top=btm THEN BEGIN done:=TRUE; mid:= -1; END;
END; IF mid > 0 THEN WRITELN('Key - ',key,' - is in position ',mid:2)
ELSE WRITELN('key - ',key,' - was not found'); END.
```

The previous display gives you some idea of how important it is to know what your environment settings are before using the Margin command. The only recovery from this operation is to use a combination of the Adjust and Insert commands to rebuild the text. If you have a copy of the original file available, you can exit the Editor without updating the file and reenter it with the old copy.

Note

The Insert command has effects similar to those of the Margin command when the Filling option of the environment is set to True and Auto-indent is False. Any time you do an Insert and confirm the operation by pressing **Select** (**EXECUTE**), both the inserted text and all the text that follows the insertion in that same paragraph are automatically margined.

The Margin takes place according to the Left and Right margin settings of the environment. If you begin an insertion and are not sure of the environment settings, press **SHIFT**-**Select** (**SHIFT**-**EXECUTE**) to exit the Insert command. This way, even if Filling is true, your text will not be margined. Then press **S** **E** to look at the environment settings.

When writing programs, your use of the environment and the Margin command will probably be more limited than when writing other kinds of text. To see how the program environment is configured, press **S** **E** (for Set Environment). The screen displays the default environment:

```

>Environment: {options} <sel> or <sp> leaves
  Auto indent   True
  Filling       False
  Left margin   0
  Right margin  78
  Para margin   5
  Command ch    ^
  Token def     True
  Ignore case   False
  Zap markers
275 bytes used, 348909 available.

Patterns:
  <target>= 'inery', <subst>= 'inary'

Markers:
  TOP          FIX

File BINSEARCH.TEXT
Date Created: 10-11-82   Last Used: 10-11-82

```

Press the space bar to exit the environment display and the Editor prompt reappears along with your text. The cursor is at the position it was when the Set command was entered.

Exiting the Editor and Saving the File

Now that you have finished writing and editing the program, exit the Editor by pressing **Q** (for Quit). Make sure that the disc named **DOC:** is in the same disc drive you have been using. The screen displays:

```
>Quit:
  Update the workfile and leave
  Exit without updating
  Return to the editor without updating
  Write to a file name and return
  Save as file new file BINSEARCH.TEXT
  Overwrite as file BINSEARCH.TEXT
```

Respond by pressing **S** for Save. If you are on an SRM system, you would use the Overwrite option. The Overwrite option allows all duplicate links and passwords to a text file to remain accurate after a file has been modified. More information on these options is given in the command reference under the Quit command.

```
>Quit:
Writing..
Your file is 1009 bytes long.
Exit from or Return to the editor?
```

Your program text has been written to your disc and is accessible under the name **BINSEARCH.TEXT** on the volume **DOC:**.

If you are creating a file for use with another language system, such as BASIC or HPL, the file should be stored as an ASCII type file on a disc with a LIF directory. To accomplish that, use the Write option and name the file:

```
DOC:BINSEARCH.ASC
```

On a LIF directory, the Pascal system codes all the file names that end in a standard suffix. The coding scheme removes the period, appends the first character of the suffix to the file name, and pads the file name to ten characters with “_” (underscore characters). This allows you to specify file names up to 15 characters. They are encoded to the maximum ten characters for the LIF directory. The file system encodes the above file name to:

```
BINSEARCHA
```

In this case, the first character of the suffix is the tenth character so no “_” characters were added. This coding mechanism is invisible as long as you are using the Pascal system. When you catalogue your disc with other language systems, the coded version of the file name is observed.

Making a Backup Copy

The most direct way to make a backup copy of your file is to press **R** (to return to the Editor) and then press **Q** (to initiate the Quit command). Each time you Quit the editor, you can make another copy of the file currently in the Editor.

Press **W** for the Write option, type in a name for your backup copy such as `DOC:BINBKP` and press **Return** or **ENTER**. If you have another disc handy, replace the `DOC:` volume with it, specify the name of the new volume along with a file name and press **Return** or **ENTER**. Remember the ten character limit for file names. After pressing **Return** or **ENTER**, the screen displays:

```
>Quit:
Writing..
Your file is 1008 bytes long.
Exit from or Return to the editor?
```

There are now two identical files on your disc(s) of the binary search program. Now press **E** (for the Exit option) and you will be returned to the Main Command Prompt:

```
Command: Compiler Editor Filer Initialize Librarian Run eXecute Version ?
```

All the Editor commands covered here are explained in further detail in the “Editor Commands” section. Less commonly used commands not presented in this sample session can also be found there.

A Closer Look

This section contains details about how the Editor works and includes information on the cursor, the screen, memory and file sizes and how the Editor allocates space for text files on a storage medium. The section also presents information on using workfiles in the Editor, on Stream files and on I/O errors that may occur when entering and exiting the Editor.

The Cursor

The cursor (the flashing underline symbol on the screen) is a reference point for all of the Editor's commands. The action associated with most commands occurs at the cursor position. Commands that perform actions on lines or paragraphs act upon the line or paragraph where the cursor is currently located.

You have complete control over the cursor through the arrow keys, the and or keys, the space bar, the mouse, and the cursor wheel (also called the knob). The screen cursor's position determines where the Editor will act upon the text, thus reflecting the internal cursor's position (in the computer's memory).

The Anchor

You can also use the Zap command to delete text. With this command, all text between the current cursor position and the "anchor" is deleted. The anchor is set at the position of the latest Adjust, Find, Insert, or Replace command. (You can also find the position of the anchor by pressing =.)

If more than a line of text is to be deleted, you will be warned as follows:
 >WARNING! Zap more than 80 chars? (y/n) Press to confirm the Zap operation; press (or space bar, etc.) to abort the Zap.

The Screen as a Window into a File

Text files are often too large to be shown all at once on the computer's screen (CRT), so the Editor uses the screen as a "window" which shows a portion of a file. Depending on which machine you have, your CRT can display lines of text that are either 49 or 79 characters long while in the Editor. If a line's length is greater than your display area, the Editor puts an exclamation point (!) in the last column to inform you that the entire line is not shown.

The screen is capable of displaying 25 lines of characters at a time. The Editor displays only 23 lines of text from a file since the top line is reserved for the system's prompt and the bottom line is reserved for the "type ahead" line. The type ahead line displays any characters input from the keyboard which have not yet been processed by the system. One other item is displayed in the lower right corner of the screen. This is a system status display or "runlight."

The screen generally displays the cursor and the text surrounding it. (The Set environment command is an exception to this). This means that you can move the window up and down through your text file by moving the cursor. Whether the text is on or off the screen, it resides in the computer's read/write memory and is easily accessed using either the cursor control keys or the various editing commands which reposition the window. When an Editor command operates on a portion of text it displays as much of that text as possible on the screen.

Memory and File Sizes

When the Editor is entered, the current text file is stored in the computer's read/write memory. All changes that occur to a text file (including text creation) take place in this memory and only become permanent when the Editor is exited and the contents of the text file are written from memory to a mass storage medium such as a flexible disc.

The maximum size of the text files that can be accessed or created by the Editor depend on the memory configuration of your system. This size can easily be determined using the Set (environment) command. The two environment headings, "bytes used" and "available", should be added together. The sum equals the maximum size (in bytes) of the text files which can be handled by the Editor.

If your text file approaches the maximum size while you are doing an insertion, the Editor displays the following message:

```
>ERROR: Finish the insertion <space> continues.
```

This tells you that you are nearing the Editor's memory limits. If, after finishing the insertion, you attempt to initiate the Insert command again, the Editor informs you:

```
>ERROR: No room to insert. <space> continues.
```

Here is procedure to help you work around the Editor memory limits (whatever they may be on your machine):

1. Set a marker toward the end of your original file (to be used later).
2. Quit the Editor, Save the original file, and Exit the Editor completely (in order to reenter with a new file).
3. Reenter the Editor and press **Return** or **ENTER** (to create a new file).
4. Using the Copy from file command, specify your original file and your marker as follows: FILENAME[MARK,] and press **Return** or **ENTER**. The name of your file and marker will be different; this just shows you the general form. Notice that a second marker was not specified so that the copy takes place from the marker's location to the end of the original file.
5. Now, press **J** then **E** (to Jump to the end of your new file).
6. Press **I** (to initiate the Insert command).

Now you can continue inserting your text in your new file without too much loss of continuity. You may want to go back to your original file and delete the text that was copied into your new file so that it will not exist in both files.

Structure of Text Files

The Editor can read and write three types of files. The predominant file type is TEXT. The others are DATA and ASCII. TEXT files contain ASCII characters and are structured in a particular way.

In every text file, the first two blocks (or 1024 bytes) are reserved for information about the environment settings, the locations of markers in the file and other information the Editor needs to work with that file. Since the Editor allocates mass storage in two block increments, text files always contain an even number of blocks. Also, because the Editor reserves the first two blocks for file information, a file with only a single character will take up 4 blocks of storage space on a mass medium.

It is possible to create a text file that does not have `.TEXT` appended to the end of the file name. If, when exiting the Editor and specifying a file name using the `Write as ...` option, you place a period (.) at the end of the file name, the Editor will not append `.TEXT` to the file name. The file will appear to be a data file on the directory for the mass storage medium. (See the chapter on the Filer for more details on file types and the directory).

If you want to access this file with the Editor, you must specify the file name followed by a period when entering the Editor. If you do not use the trailing period, the Editor appends `.TEXT` to the name you type in and looks for a file with that name on the mass storage medium.

For example, suppose when exiting the Editor you answer the prompt for a file name with `DUX.` Notice the period following the name. The Editor saves the file with the name `DUX` (it strips off the period) and does not append the `.TEXT` suffix. If you enter the Editor and want that file, you must specify `DUX.` If you instead specify `DUX` (i.e., leave out the period), the Editor appends `.TEXT` to the name you typed and looks for a file with the name `DUX.TEXT`. It may even find a file with that name, but it will be a different file than the one saved by specifying `DUX.`

ASCII files are structured differently. ASCII files on LIF discs are compatible with the BASIC and HPL language systems that run on your computer. ASCII files are created by writing to a file whose name ends in the suffix:

`.ASC`

When writing ASCII files, the Editor's environment information is lost.

Using Workfiles in the Editor

A workfile in the Editor is used as a "scratchpad" version of a text file. The workfile is useful because it is the default file in the Editor (as well as in many of the Pascal subsystems). Chapter 2 contains information about using workfiles in all the subsystems; only Editor-related workfiles are covered here.

There are two ways to enter the Editor: from the Main Command Level or from the Compiler subsystem (after the Compiler finds an error in the text file it is compiling). When entering from the Compiler, the text file being used is automatically read in. When entering the Editor from the main level, the system automatically looks for a workfile and, if it finds one, reads the contents of the file into the computer's memory. If the Editor does not find a workfile, it prompts you for a file name.

Exiting the Editor (using the Quit command) gives you the option of Updating the workfile. If the Editor was entered with a workfile (or if the Update option was used earlier in the same editing session), the Editor writes the contents of the text file in memory to the file called *WORK.TEXT on the system volume. When you are through with all your editing, it is a good idea to enter the Filer subsystem and Save the workfile.

Stream Files and the **ANY CHAR** Key

Stream files (covered in Chapter 1) can be created by the Editor to simulate a "batch" mode in which the computer executes the commands in the Stream file as if they were coming from the keyboard. The **ANY CHAR** key is useful in this regard. It can be used to generate characters which may not otherwise be attainable by regular keystrokes. For further information on the **ANY CHAR** key and Stream files, see Chapter 1.

I/O Errors (Entering and Exiting the Editor)

There are two general types of errors that can occur when entering the Editor. The first type of error is generated by the system when it cannot find the volume or file which you specified. The solution to this is to make sure that the proper volume is on-line. This type of error also occurs when a workfile exists but the Editor cannot find it because the medium containing that file is no longer on-line. When the Editor encounters this situation, it informs you that the workfile has been "lost" and then prompts you for a filename.

The second type of error possible while entering the Editor is a memory overflow condition. This happens only if the text file being read was created on a machine with more memory than the machine currently being used. Note that this condition is met if you use the Permanent command (at the Main Command Level — see Chapter 1) to load something into memory that was not there when you created the text file. Your machine now has less available memory so the space for text files is smaller.

When a memory overflow occurs while reading in the file, the Editor lets you continue the entry process even though the entire file has not been read into memory. However, upon exiting the Editor, the Save option is no longer available. This safeguard keeps you from accidentally overwriting your original file.

When exiting the Editor, a number of different errors are possible. If the Editor detects an error while writing the contents of the text in the computer's memory to a mass storage medium, it will display a self-explanatory error message.

Editor Commands

This section contains a brief overview and summary of all the Editor commands and a complete alphabetized description of the syntax and semantics of all the Pascal Editor commands and options.

Editor Command Summary

Text Modifying Commands

Copy – Insert text from the copy buffer or an external file in front of the current cursor location.

Delete – Remove text from the current cursor location to the location of the cursor when **Select** (**EXECUTE**) is pressed.

Insert – Inserts text in front of the current cursor location.

Replace – Replace the specified target string with the specified substitute string.

eXchange – Replace the text at the cursor with text typed from the keyboard, on a character-by-character basis.

Zap – Delete all text between the anchor and the current cursor location. (The anchor is set at the location of the latest Adjust, Find, Insert, or Replace command.)

Text Formatting Commands

Adjust – Adjust the column in which a line (or lines) start.

Margin – Format the paragraph the cursor is located to the margins in the current environment.

Miscellaneous Commands

Quit – Leave the Editor in an orderly manner. Provides various ways for saving the text currently in memory.

STOP (**SHIFT**-**CLR I/O**) – terminates the Editor subsystem, but the text is lost.

Set – Modify the environment or set markers in the text.

Verify – Update the displayed text to reflect the text stored in memory.

Cursor Keys

TAB – Move cursor to next tab position (fixed tabs) in the current direction.

Return or **ENTER** – Move cursor in current direction to the leftmost character in the next line.

Space Bar – Move cursor one character in the current direction.

Arrow Keys – Move cursor in the direction specified by the key.

Cursor Wheel – Moves the cursor like the arrow keys. Without **SHIFT**, works like right and left arrows; with **SHIFT**, works like the up and down arrows.

Cursor Positioning Commands

= – Typing **=** positions the cursor at the anchor. (The anchor is set at the location of the latest Adjust, Find, Insert, or Replace command.)

Find – Position the cursor after the specified target string.

Jump – Position the cursor at the beginning, the end, or the specified marker.

Page – Position the cursor ± 23 lines from the current location.

Command Syntax and Semantics

The Editor commands are presented in alphabetical order and described in a variety of formats to make them more useful to you. Each command's explanation includes: the command's name, a brief functional description, a diagram showing its legal syntax, the command's prompt (if any) and text which discusses using the command. Each of the command's options are also covered and some have examples to show the proper use of these options.

Alphabetical Listing of Editor Commands

- Adjust
- Copy
- Delete
- Equals (=)
- Find
- Insert
- Jump
- Margin
- Page
- Quit
- Replace
- Set
- Verify
- eXchange
- Zap

ADJUST

Adjust horizontally shifts the starting column of one or more lines of text.

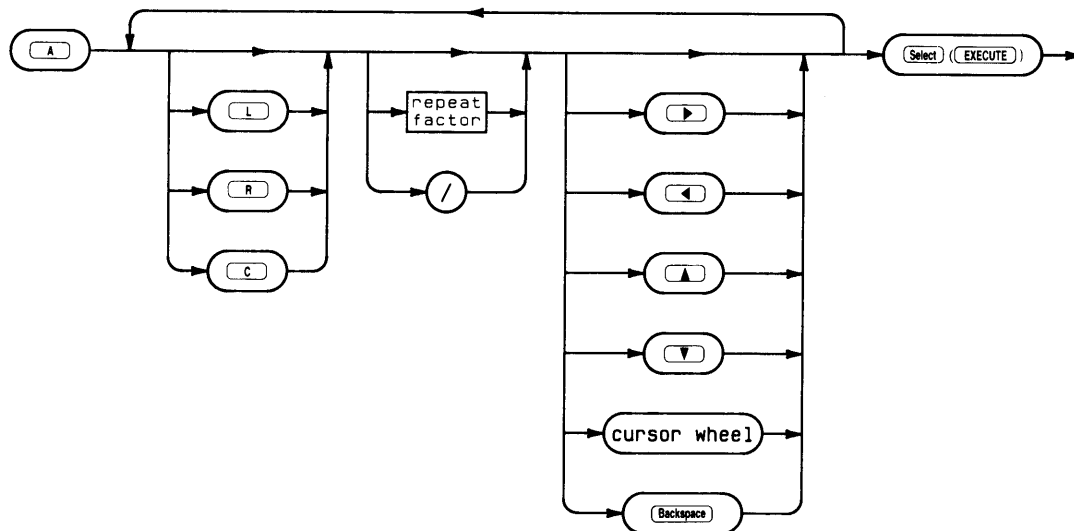

Item	Description/Default	Range Restrictions
repeat factor	integer numeric constant	1 thru 9999

Semantics

The Adjust prompt:

```
>Adjust: LJust RJust Center <arrow keys> [<exc> to leave]
```

The Adjust command provides a means of formatting text and enables you to make text more readable. Adjust uses the line position of the cursor when the command is entered as a starting point. A line-oriented command, Adjust lets you shift an entire line of text to the left or right using the `→`, `←`, `BACK SPACE`, or cursor wheel. Repeat factors can be used with these keys to shift the text. For example, pressing 7 `→` results in the line shifting 7 spaces to the right.

Pressing `A` (for Adjust) and then `L`, `R` or `C` moves the line to the left margin, right margin or centers the line between the two margins. The margins used by these options are the Right and Left margins currently set in the environment (see Set command).

Typing a repeat factor and `↑` or `↓` causes that number of lines to be adjusted the same amount as the accumulated adjustments at that point. The slash (/) functions as an infinite repeat factor and can be used with `↑` and `↓`. It causes adjustments to be made from the current line to either the beginning or the end of the text file, respectively. For example, pressing `C` / `↓` causes all the text between the current cursor position and the end of the file to be Centered according to the current margins.

Note

Take care when using large repeat factors or the slash (/) character when adjusting text. This is because the effects of the Adjust command cannot be aborted. Whatever adjustments are made become permanent unless the Adjust command is used again.

Adjust also sets the anchor used by the Zap command. Pressing = (the Equals command) moves the cursor to the position of the last Adjust unless the anchor has been reset by either a Find, Insert, or Replace command.

Leave the Adjust command by pressing **Select** (**EXECUTE**). The system stores the adjusted text in the computer's memory and the Editor prompt reappears.

COPY

Copy inserts text from a specified file or from the copy buffer.

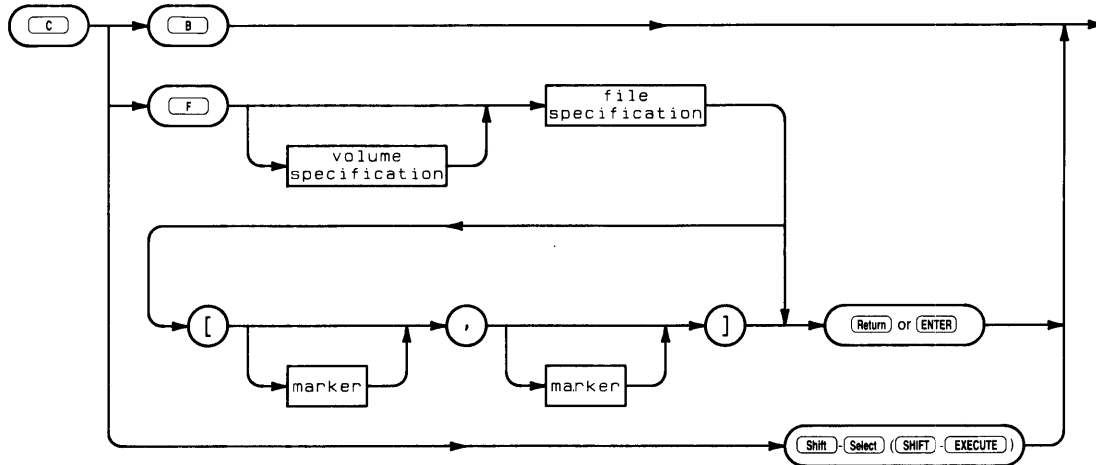

Item	Description/Default	Range Restrictions
volume name	literal	any valid volume name.
file name	literal	any valid text file; do not enter .TEXT suffix.
marker	literal	1 to 8 ASCII characters excluding CHR (0) thru CHR (31) and CHR (127).

Semantics

The Copy prompt:

```
>COPY: Buffer File <sh-sel>
```

The Copy command provides a way of moving or duplicating text in a file and copying text from another file. These are the Buffer and File options. Pressing **C** (for Copy) and **B** (for Buffer) results in the contents of the copy buffer being written to your current text at the cursor position when the command was entered. The screen displays the new text and the Editor prompt.

The copy buffer is filled with the text involved in the most recent Delete, Insert or Zap command and its contents are cleared with the Margin command. Margin clears the copy buffer regardless of the settings in the environment. Doing a Copy (from a File) also clears the copy buffer. A subsequent Copy from Buffer command generates the message:

```
>ERROR: Invalid copy, <space> continues.
```

Any subsequent Delete, Insert or Zap refills the buffer (destroying its previous contents) and copying from a file clears the contents of the buffer. However, doing a Copy (from Buffer) does not alter the buffer's contents. Neither do any cursor control movements or commands. Therefore, you can make multiple copies of the same text in different locations by repeatedly positioning the cursor and pressing **C** **B**.

To Copy from a file, press **C** **F**. The screen displays:

```
>COPY: File [marker,marker] ?
```

The Editor is requesting a volume name, file name, and two marker names. The volume name may be omitted if the file in question is on the default volume. The volume (specified or default) must be on-line. Specification of the two previously set markers (see Set command) is optional but, if given, the marker names must be enclosed in square brackets and separated by a comma. Remember, only TEXT type files have markers.

If markers are specified, only the text between those two markers is copied. If no markers are specified, the entire file is copied. Only one marker has to be specified. If it is the first marker (i.e., followed by a comma), the text is copied from the marker position to the end of the specified file. If only the second marker is given (i.e., preceded by a comma), the text is copied from the beginning of the specified file to the position of the marker. The copy occurs at the cursor's position when the Copy command was entered. You can exit the command before all specifications are complete by pressing **SHIFT** - **Select**.

After typing the appropriate information and pressing **Return** or **ENTER**, the Editor displays:

```
>COPY...
```

This shows that the specified text is being copied into your current text. When the operation is complete, the Editor prompt reappears and the screen displays all or part of the text that was copied.

DELETE

Delete removes text from the current file.

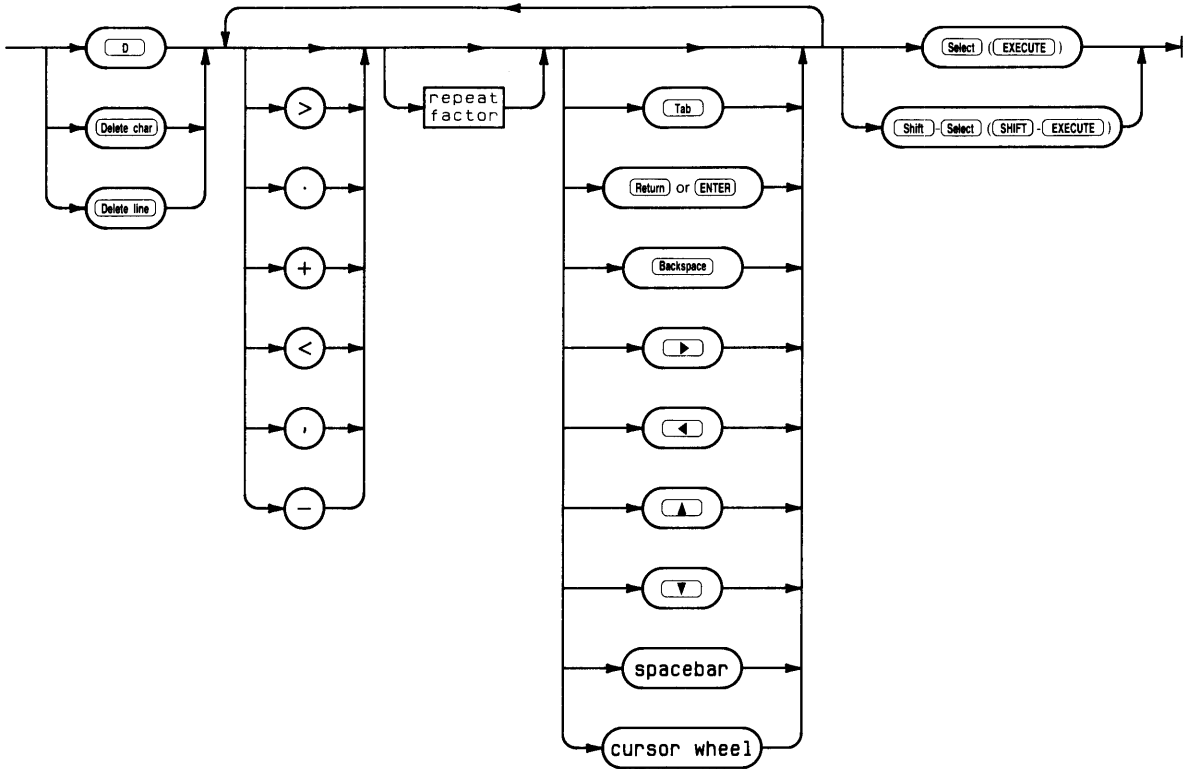

Item	Description/Default	Range Restrictions
repeat factor	integer numeric constant	1 thru 9999 (1 thru 4095 for TAB)

Semantics

The Delete prompt:

```
>Delete: < > <Moving commands> [<exc> deletes, <sh-exc> aborts]
```

The Delete command enables you to remove text and fills the copy buffer with the deleted text. Delete uses the cursor position when the command is entered as a starting point. Subsequent cursor movement by any cursor control key causes text to be removed between this point and the new cursor position. Text can be recovered by moving the cursor back toward the starting point.

Direction applies in the Delete command and is shown by (>) (forward) or (<) (backward) in the Delete prompt. If forward, movement occurs from the cursor toward the end of the file; if backwards, movement is from the cursor toward the beginning of the file. Movement generated with the **TAB**, **Return** or **ENTER**, and space bar takes place in the direction shown. Direction can be changed while in the Delete command by pressing > , or + (for forward) or < , or - (for backward).

Repeat factors are available within the Delete command. For example, pressing **D** (for Delete) and then 9 **Return** **ENTER** will remove 9 lines of text in the current direction starting at the cursor position.

Delete fills the copy buffer with the deleted text and thus provides a means of moving or duplicating text. See the example in the section "A Sample Editor Session".

To exit the Delete command press **Select** (**EXECUTE**) or **SHIFT**-**Select** (**SHIFT**-**EXECUTE**). **Select** confirms the deletion, returns the Editor prompt and displays the cursor at its position when **Select** was pressed. **SHIFT**-**Select** aborts all changes made since Delete was entered, returns the Editor prompt and displays the cursor at its position when Delete was entered.

Note that the copy buffer is filled by whatever is deleted; whether the command is exited with a **Select** or **SHIFT**-**Select** makes no difference to the copy buffer.

EQUALS (=)

EQUALS positions the cursor at the anchor's location.

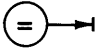

Semantics

The equals sign (=) is a cursor positioning command. It moves the cursor to the beginning of the most recent item Adjusted, Found, Inserted, or Replaced. Pressing = causes the cursor to jump to the location of this “anchor” and the Editor’s prompt is displayed. This is the anchor used by the Zap command.

FIND

Find moves the cursor to an occurrence of a specified string.

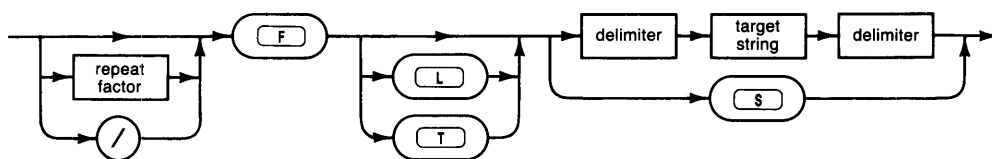

Item	Description/Default	Range Restrictions
repeat factor	integer numeric constant	1 thru 9999
delimiter	literal (see glossary)	any valid delimiter; must be used in matched pairs.
target string	literal	1 thru 128 characters

Semantics

The Find prompt:

```
>Find[1]: L <target>=>
or >Find[1]: T <target>=>
```

The prompt displayed depends on whether the “Token” definition in the Editor’s environment is set to true or false. If set to true, the first prompt is displayed; if false, the second is shown. These are explained below.

In its simplest form, the Find command is executed by pressing **F** and specifying a string surrounded by delimiters. Upon typing the final delimiter, the cursor is positioned at the end of the first occurrence of the specified string in the current direction.

The Find command moves the cursor and sets the anchor (used by Zap) at the location of the target string. In this context, a “string” is a contiguous series of non-control ASCII characters surrounded by delimiters. Delimiters are separators that signify to the Editor the beginning and end of the string such as the characters / ' , and > (more are listed in the glossary).

Avoid using a delimiter that appears in your string. Delimiters must be matched pairs; if you use \$ to signify the beginning of a string, you must use \$ to signify the end of the string. The maximum length of a target string is 128 characters.

The Find prompt shows the current direction. When searching for a string occurrence, Find looks for that string between the cursor position when the command was entered and either the end of the file (if direction is forward >) or the beginning of the file (if direction is backward <).

Repeat factors are available with the Find command but must be typed before the Find command is initiated. If a repeat factor is used, the Editor positions the cursor at the end of that occurrence of the string. For example, typing `B [F] /the/` results in the cursor being positioned at the end of the eighth occurrence of `the`. The slash (`/`) operates in a similar way but signifies the last occurrence of the specified string in the current direction. If no repeat factor or slash character is specified it defaults to the value 1 and the Editor attempts to find the first string occurrence. The Find prompt displays this value in square brackets.

After pressing `[F]`, the prompt on your screen contains either an L or T for “literal” or “token” modes. Literal and token are interdependent; if one option is shown as available, the other is automatically the default. If L is shown in the prompt and you want to use the token search mode, simply type in the target string surrounded by delimiters. The search will take place in the default mode (in this case, token). To do the same search in the literal mode, press `[L]` then type in the string as before. The Find command then searches for a literal form of the string.

A **literal string** is exactly that — a literal string of characters either isolated or imbedded in a word or paragraph. A **token string** is one which is isolated by delimiters. Delimiters in this context are any ASCII characters except numbers or alphabetic characters. Blanks are common delimiters in English text because they separate words.

To illustrate literal and token searches, the following example assumes the direction is forward (`>`) with the cursor located at or before the start of the sentence shown. In the sentence `That's my hat!`, a token search for `hat` moves the cursor behind the last word `hat` in the sentence whereas a literal search for `hat` moves the cursor behind the `hat` imbedded in `That's`.

The “**same**” option is another feature of the Find Command. Same refers to the most recent target string used in either the Find or Replace command. Suppose you typed the sequence `[F] [L] *galactic*`. After pressing the final delimiter (`*`), the Editor moves the cursor behind the first literal occurrence of the target string `galactic`. Then typing `[F] [L] [S]` results in the cursor moving behind the next literal occurrence of the same target.

When using the “same” option with the direction set backward (`<`), use a repeat factor of two before initiating the Find. Otherwise, the Editor finds the previous occurrence since it searches between the cursor’s current position and the beginning of the file.

Suppose after the first Find your screen displays:

```
<Edit: Adjst  Cpy  Dlete  Find  Insrt  Jmp  RPlace  Quit  Xchns  Zap ?
According to the galactic archives, the
intergalactic_cruisers continued their
explorations without regard for
```

If you press **F** **L** **S** to Find the same literal string, the cursor position on the screen does not change. To find the next occurrence, type 2 then press **F** **L** **S**. Since the direction is backwards and the Find command always positions the cursor behind the target string, using a repeat factor of 2 skips to the next effective occurrence of the literal `galactic`. Repeated searches in the forward (>) direction operate in a straightforward manner.

Note

If a Replace has been done since the last Find operation, the target string used by the “same” option is now the target specified in the Replace command.

Searches are sensitive to the case of the characters (upper and lower case) unless Ignore case and Token are set to True in the Environment. Type **S** and **E** to Set the Environment. Type **I** and **T** to set Ignore case to True. Type **T** and **T** if Token is not already True. After these two conditions are met, the Editor treats both the target string and each token string as uppercase.

Find is one of the commands that sets the anchor used in the Zap command and accessed by the Equals command.

SHIFT-**Select** (**SHIFT**-**EXECUTE**) can be used to abort the Find command before all specifications are complete. If **SHIFT**-**Select** is used, the target pattern used by the “same” option remains unchanged. **Select** cannot be used with the Find command. The command is executed immediately when the final delimiter (or **S** if “same” is used) is typed.

INSERT

Insert opens a window in the current file for the subsequent insertion of text.

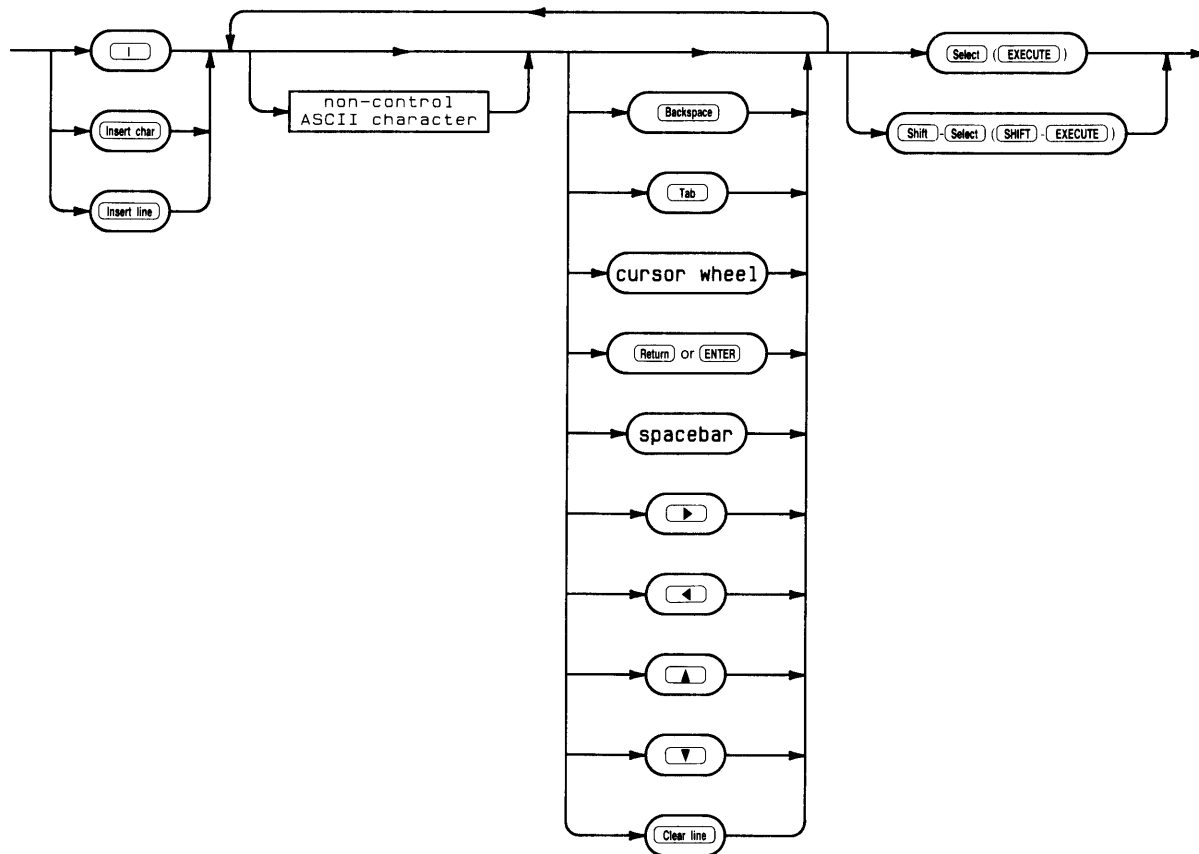

Item	Description/Default	Range Restrictions
non-control ASCII character	literal	Any valid ASCII character excluding: CHR (0) thru CHR (31) and CHR (127).

Semantics

The Insert prompt:

```
>Insert: Text <bs>, <clr ln> [<sel> accepts, <sh-sel> escapes]
```

The Insert command opens a window in the text file directly in front of the cursor position for text creation. When initiated (by pressing **I** or **INS CHR** or **INS LN**), the text from the cursor to the right edge of the screen is shifted to the right. Insertion always takes place directly in front of the cursor location when Insert was entered. Any sequence of non-control ASCII characters may be inserted and any cursor control key may be used. However, unless the movement generated by the cursor control keys is backward, they produce question marks (?) in the text. You can **BACK SPACE** to delete a character or press **CLR LN** to delete the most recently inserted line. **CLR LN** is available only after a line of text has been inserted. Backspacing past the point at which Insert was entered is not possible.

The way in which text insertion takes place depends on flags or parameters set in the Editor's environment. These flags have default values supplied by the Editor but can be changed with the Set command. The ones that concern you here are Filling and Auto indent. These two options generally have opposite values. Most of what you need to know about Filling and Auto indent can be summed up in one sentence: If you are writing program source text, set Filling to false and Auto indent to true; if writing regular text, set Filling to true and Auto indent to false.

Filling, when set true, performs both "wrap around" and "margin" functions. As inserted text approaches the Right margin (another environment option), the Editor attempts to fit the words on the current line. If a word would cause the line to extend beyond the right margin, it is automatically shifted to the next line (i.e., the system supplies a carriage return and a line feed). When the insertion is completed by pressing **Select** (**EXECUTE**), all text following the cursor in the current paragraph is margined. Margining adjusts the text to fit between the environment's margins and also compresses blanks in the text. You can have two blanks following the four characters: ? . : !. All other blanks are compressed into a single blank character.

Note that the Editor's definition of a paragraph is **ANY** text delimited by any combination of blank lines, lines having the Command character as the first non-blank character in a line, or the beginning and end of a text file. The Command character is yet another of the environment's options; see the Set command for more details.

Note

As the definition of a paragraph infers, the Editor does not distinguish tables from other kinds of text material. Any insertions within a table will result in the table being margined (i.e., collapsed) if Filling is set to true and the insertion is exited with **Select** (**EXECUTE**). Use the Set command to set Filling to False before inserting in a table or list. (**SHIFT**-**Select** will **NOT** restore the text to its original state after a paragraph has been margined).

If Filling is false, a beep is generated as you approach the end of the line, signaling you to press **Return** or **ENTER** the same way a bell on a typewriter does. If you continue to insert text past the last visible column on your screen, the Editor accepts the characters and shows you that they are outside of the display area by placing an exclamation point (!) in the final column. To access these characters, complete the insertion by pressing **Select** (**EXECUTE**), position the cursor before the last word on the line and press **I** followed by **Return** or **ENTER** to insert a carriage return.

If Auto indent is true, pressing **Return** or **ENTER** automatically places the cursor in the same starting column as the previous line. When Auto indent is false, the cursor is positioned according to either the Left or Paragraph margin in the environment.

If Insert is exited with **Select** (**EXECUTE**) (and Filling is true and Auto indent false), all text following the insertion in the same paragraph is margined according to the Right, Left and Paragraph margin values in the environment. Also, the entire insertion is stored in the copy buffer so you can copy the same text elsewhere if you wish. If Insert is exited with **SHIFT**-**Select** (regardless of the options set), all changes are aborted and the text and cursor appear as they did when the command was entered.

The Insert command sets the anchor (used by the Zap command) at the position where Insert was initiated. The anchor is set regardless of whether **Select** or **SHIFT**-**Select** is used to exit the command.

JUMP

The Jump command repositions the cursor.

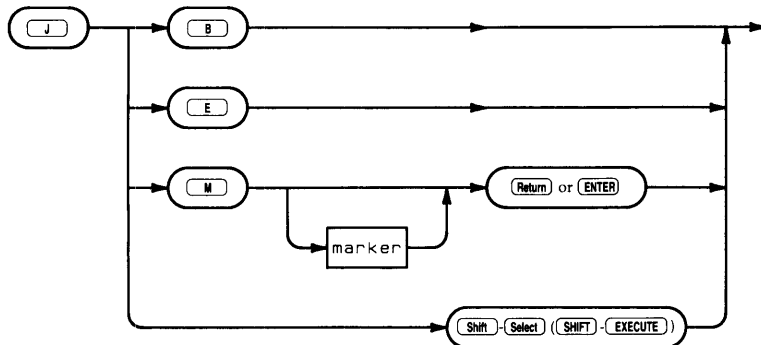

Item	Description	Range Restrictions
marker	literal	1 to 8 ASCII characters excluding: CHR (0) thru CHR (31) and CHR (127).

Semantics

The Jump prompt:

```
>JUMP: Begin End Marker <sh-sel>
```

The Jump command moves the cursor to the beginning or end of a text file or to a previously defined marker. The command has no other effects; it merely repositions the cursor. To Jump to the beginning of your file, press **J** **B**. To Jump to the end of your file, press **J** **E**.

You can also Jump to a marker by pressing **J** **M** and typing the name of any previously set marker in the file followed by **Return** or **ENTER**. Marker names are defined with the Set command. A legal marker name is any sequence of up to eight non-control ASCII characters (control characters are deleted by the system). They can actually be longer than this but the Editor only pays attention to the first 8 and truncates the rest.

Also, marker names are not case sensitive. The Editor converts all marker names to uppercase letters so they can be typed using any desired combination of uppercase and lowercase letters. There is a 10 marker limit per text file. See the Set command for more information on markers.

MARGIN

Margin formats all text in the current paragraph to fit the margins set in the environment.



Semantics

Margin is disabled and the system generates an error message unless the environment's Auto indent is false and Filling is true when the command is executed.



The Margin command provides a means of formatting paragraphs in your file. A paragraph is defined by the Editor to be **ANY** text delimited by any combination of blank lines, lines having the Command character as the first non-blank character in a line, or the beginning and end of a text file. See the Set command for details on the Command character.

Upon initiating Margin (by pressing ) , the Editor takes all the text in the current paragraph (the one where the cursor is) and forces it to fit within the Left, Right and Paragraph margin boundaries of the environment. After margining, the first line of the paragraph begins at the column specified by the Paragraph margin setting and the rest of the text conforms to the Left and Right margin settings. If a word would exceed the Right margin it is “wrapped around” to the next line.

Two blanks are allowed following the four characters: ? . : ! . All other blanks are compressed into a single blank character.

Since the Command character in the environment delimits a paragraph, you may want to use it as the first character in each line of tables or lists which you do not want margined. See the Set command for more information on the Command character.

Note

If a table or list fits the definition of a paragraph, the Margin command will definitely margin that text. Exiting the Insert command with  () also uses some of the Margin routine so be aware that these commands can potentially “collapse” a table or list.

The Margin command has no parameters and its effects cannot be aborted. When writing program text or tables, it is advised that Auto indent be set true, Filling be set false and the Paragraph margin be equal to the Left margin.

Note

The Margin command clears the contents of the copy buffer regardless of the settings of the Auto indent and Filling options.

QUIT

QUIT leaves the Editor with various exit options.

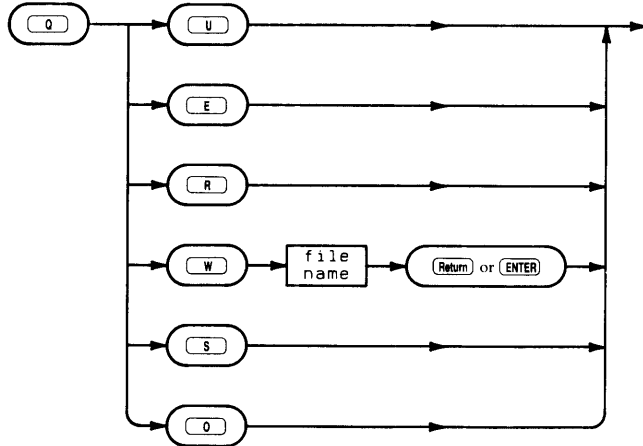

Semantics

```

>Quit:
  Update the workfile and leave
  Exit without updating
  Return to the editor without updating
  Write to a file name and return
  Save as file new file BINSEARCH.TEXT
  Overwrite as file BINSEARCH.TEXT
  
```

The Quit command allows you to exit the Editor and store your file on a mass storage medium. The last two quit options shown above are only available if the file existed before the editing session.

Quit is initiated by pressing from the Editor's prompt. Choose any of the options displayed by pressing the first letter of the option.

Pressing (for **Update**) results in the contents of the text in the computer's memory being written to a text file on the system volume under the name `WORK.TEXT`. This workfile may or may not be associated with another file name (see the Get and Save commands in the Filer chapter). After writing the file, the system reports the file's size (in number of bytes and blocks) and displays the main command prompt.

Pressing (for **Exit**) either immediately exits to the main level or displays:

```

Are you sure you want to exit without updating?
Type Yes to Exit without update
Type No to Return to Editor
  
```

This message is displayed only if changes have been made to the text file in the current editing session. If no changes have been made, the system immediately goes to the main level when is pressed. It also exits to the main level if you respond by pressing . Responding with returns you to the Editor.

Pressing **R** (for **Return**) returns you to Edit mode with the cursor located where it was when Quit was entered.

Pressing **W** (for **Write**) causes the system to prompt you for a file name. A complete file name is needed. If a volume ID is not given, the default volume is used. The volume PRINTER: may be specified. This results in the file being listed to the printer.

If you use the Write option and the file already exists, the Editor displays this prompt:

```
>Quit:
FILE.TEXT exists ...
  Rewrite then purge old
  Overwrite
  Purge old then rewrite
  None of the above
```

Rewrite then purge old is like the Save command. An attempt is made to write the new file before purging the old.

Overwrite removes the original file and then attempts to write the new version in its place. On SRM units, duplicate links and passwords will be preserved. On a disc, the file may not fit if the new version is larger than the old.

Purge old then rewrite removes the original file and then attempts to write the new file in the biggest space on the disc. This alternative gives you the best chance that there will be room for the new file.

Whether you “Overwrite” or “Purge old then rewrite”, the original copy of the file is gone and the only copy of the file is in the Editor’s memory. It is advisable to save it on another disc as soon as possible.

None of the above returns you to the Editor. You may Quit again and write the file with a different name.

Pressing **S** (for **Save**) results in the file being written to the original volume and file.

If you try to Save a file and you get the message:

```
>ERROR: No room on vol <space> continues.
```

Press the spacebar to continue. You could put in another disc with enough space, then Quit and Save it on the new disc. Alternatively, you can Quit and Overwrite the file.

Pressing **O** (for **Overwrite**) is designed for SRM systems. The Overwrite option allows all duplicate links and passwords to remain accurate. On a disc, Overwrite may not work if the file has been enlarged. If this happens, press the spacebar to continue, Quit and Save again. The previous Overwrite removed the original file. Now the Save will try to save the file in the largest space on the disc. If this does not work, you must put the file on another disc.

REPLACE

Replace does one or more substitutions of a specified string for another string.

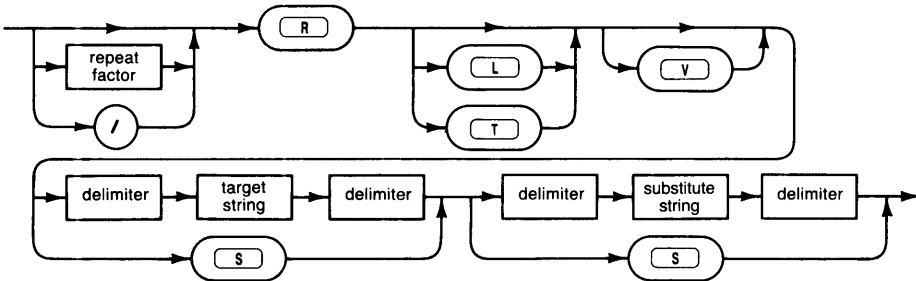

Item	Description/Default	Range Restrictions
repeat factor	integer numeric constant	1 thru 9999
delimiter	literal (see glossary)	any valid delimiter; must be used in matched pairs.
target string	literal	1 thru 128 characters
substitute string	literal	1 thru 128 characters

Semantics

The Replace prompt:

```
>Repl[1]: L  V  < t a r g >< s u b >=>
or >Repl[1]: T  V  < t a r g >< s u b >=>
```

The prompt displayed depends on whether the “Token” definition in the Editor’s environment is set to true or false. If true, the first prompt is displayed; if false, the second is shown. These are explained below.

The Replace command allows you to substitute one string for another in your text file. The anchor (used by the Zap command and accessed by the Equals command) is set at the location of the replacement. Replacements can be done to a single, all, or only certain occurrences of a string.

In its simplest form, the Replace command is executed by pressing **R** and specifying two strings — a target and substitute — each surrounded by delimiters. The target and substitute strings may be different sizes. Upon typing the final delimiter, the first occurrence of the target string is replaced by the substitute string and the cursor is positioned at the end of the substitution.

A target string (the one that you want replaced) must be supplied. A string is a contiguous series of non-control ASCII characters surrounded by delimiters. Delimiters signify the beginning and end of a string and are characters such as: / ' , and > (more are listed in the glossary).

A substitute string (what you want the target string changed to) must also be supplied with delimiters. The substitute may be an empty (null) string.

Avoid using a delimiter that appears within your string. Delimiters must be matched pairs, i.e., if you use `$` to signify the beginning of a string, you must use `$` to signify its end. The substitute string can have a different set of delimiters than the target string and the two strings may be of different sizes. The maximum length of either string is 128 characters.

After pressing , the prompt on your screen contains either an or for “literal” or “token” modes. Literal and token are interdependent; if one option is shown as available, the other is automatically the default. If is shown in the prompt and you want to use the token search mode, then type in the two strings and their delimiters. The replacement takes place in the default mode, in this case, token. To do the same replacement in the literal mode, press and type in both strings as before. The Replace command then searches for a literal form of the string.

A literal string is exactly that — a literal string of characters either isolated or imbedded in a word. **A token string** is usually a word (a string isolated by delimiters). Delimiters, in this context, are any ASCII characters except numbers or alphabetic characters — they do not have to be matched pairs. Blanks are the most common delimiters in English text because they separate words.

To illustrate literal and token replacements, the following example assumes the direction is forward (`>`) with the cursor located at or before the start of the sample sentence. In the sentence `That's my hat!`, a token replacement for `hat` with `umbrella` replaces the last word `hat` in the sentence with `umbrella` whereas a literal replacement would substitute `umbrella` for the `hat` imbedded in `That's` (resulting in `Tumbrella's my hat!`).

Direction applies in the Replace command and is shown by the first character in the command's prompt. If the direction is forward (`>`), the replacement occurs between the cursor position and the end of the file; if backward (`<`), between the cursor and the beginning of the file.

Repeat factors are available for the Replace command but must be typed before the command is initiated (before is pressed). A repeat factor causes that number of substitutions to be made. If not specified, the repeat factor defaults to 1. A slash character (`/`) may also be used to change all occurrences of the specified string in the current direction. The repeat factor (or slash character) is displayed in brackets `[]` in the command's prompt. The repeat factor works differently when the Verify option is used.

The Verify option lets you choose whether or not to make a particular replacement. The combination of a repeat factor with Verify allows you to replace only certain occurrences of a string in the file. For example, after pressing `2` and typing in the target and substitute strings, the Editor moves the cursor to the first occurrence of the target string and prompts:

```
>R[1][2]: <sh-exc> aborts,R replaces,' ' doesn't
```

To confirm the replacement, press **R**. To skip to the next replacement (if any), press the space bar. While using Verify, pressing **SHIFT-Select** (**SHIFT-EXECUTE**) aborts the operation and retains all replacements made up to that time.

The “**same**” option is available with Replace and refers to either the most recent target string (used in a Find or Replace) or the most recent substitute string (used only in Replace). Which string it signifies (target or substitute) depends on where it is used in the Replace command. To use “Same”, simply press **S** in place of the delimited string. If you type **S** followed by a delimited string, the most recent target is replaced with the specified string. If you type a delimited string followed by **S**, the specified target is replaced with the last substitute. Both strings may be specified by typing **S S**. The current assignments of the “same” patterns can be seen by pressing **S E** (see the Set command for more details).

Note

If a Find has been done since the last Replace, the target string used by the “same” option is now the target specified in the Find command.

The “**Ignore case**” option applies to the Replace command. Type **S** and **E** to Set the Environment. Type **I** and **T** to set Ignore case to True. Type **T** and **T** if Token is not already True. The target string and all **token** strings in the text are treated as upper case. When a match is found, the token string is replaced with the substitute string. The case of the substitute string is not affected by the Ignore case option.

The Replace command can be aborted before all specifications are complete by pressing **SHIFT-Select** (**SHIFT-EXECUTE**). (Subsequent use of the “same” option after aborting the Replace command may give you unwelcome results).

SET

Set defines markers and alters the environment in which your text operations occur.

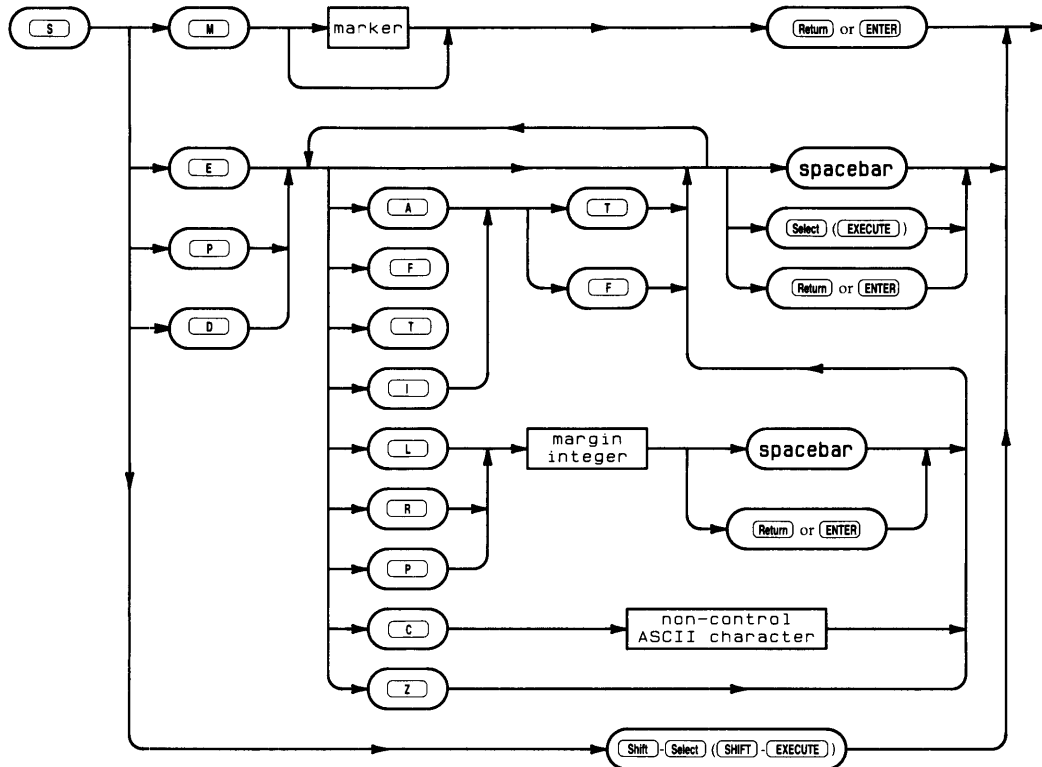

Item	Description/Default	Range Restrictions	Recommended Range
marker	literal	1 to 8 ASCII characters excluding CHR(0) thru CHR(31) and CHR(127)	-
margin integer	integer numeric constant	0 thru 9999; left margin must be less than right margin	0 thru 49 for 50-column displays; 0 thru 79 for 80-column displays
non-control ASCII character	literal	any valid ASCII character excluding CHR(0) thru CHR(31) and CHR(127)	-

Semantics

The Set prompt:

```
>Set: Env Mrk Prog Doc <sh-sel>
```

Set lets you define markers and various environment parameters. Markers are Set by moving the cursor to where you want the marker, pressing **S** **M** (for Set Marker) and typing in a marker name followed by **Return** or **ENTER**. A marker name is any sequence of up to eight non-control ASCII characters. The Editor accepts more than eight characters but truncates anything longer. All non-printing characters (those with an ASCII value of either 127 or in the range of 0 to 31) are deleted by the system. The Editor converts these names to uppercase so they can be typed in whatever form is convenient.

No more than ten markers can be set in a file. If you attempt to set more than ten, the Editor displays the markers in a numbered list and prompts you for the number of the marker you wish to replace. All markers can be removed by giving the Zap marker command. Markers are used with the Jump and Copy commands and their names are shown in the environment display. The locations of the markers are not shown so the use of meaningful marker names is advised.

Pressing **S** **E** (for Set Environment) displays the current environment and allows you to change the environment's parameters. When entering the Editor with a new file, the default environment is the Program environment which looks like:

```

>Environment: {options} <sel> or <sp> leaves
  Auto indent      True
  Filling          False
  Left margin     0
  Right margin    78
  Para margin     5
  Command ch      *
  Token def       True
  Ignore case     False
  Zap markers
  275 bytes used, 348909 available.

Patterns:
  <target>= 'inary', <subst>= 'inary'

Markers:
  TOP           FIX

File BINSEARCH.TEXT
Date Created: 10-11-82   Last Used: 10-11-82

```

Patterns and Markers are only shown if they have been set. The heading near the bottom displays a file name if the Editor is entered with a specified file. Whenever a file is saved on a mass storage medium, the current environment is saved with it and becomes the default environment when that file is used by the Editor.

The environment also displays how many bytes of memory have been used and how many are still available for use in the Editor. The total number of bytes (used and available) depends on the amount of memory in your machine.

To change a parameter in the environment, press the first letter in the parameter's name. The cursor is automatically positioned at the item to be changed and the new value must be typed. If the parameter needs a number (as in Left, Right and Paragraph margins), then the number must be followed by pressing **Return** or **ENTER** or the space bar. All other parameters accept a single character and return the cursor to the environment's prompt as soon as the character key is pressed.

Automatic indenting is a boolean (with either a true or false value) which affects the Insert and Margin commands. When inserting text with this item set true, pressing **Return** or **ENTER** automatically moves the cursor to the next line at the same starting column as the previous line. This indenting feature is useful when writing Pascal programs so it is set true for the Program (default) environment.

When Auto indent is true the Margin command is disabled. When Auto indent is false, pressing **Return** or **ENTER** places the cursor on the next line at either the Left margin or Paragraph margin (as currently defined in the environment).

Filling is another boolean value which affects the Insert and Margin commands. It usually has a value opposite that of Auto indent. When set true (and auto-indent is false), filling causes automatic "wrap around" of text. If a word is too long to fit on the current line (as defined by the Right margin value), it is carried or wrapped around to the next line and no carriage return (**Return** or **ENTER**) is necessary. Another effect of this parameter being set true is that an Insert completed by pressing **Select** (**EXECUTE**) causes all text following the insertion in that paragraph to be margined or filled according to the current values of the Left, Right and Paragraph margin settings. All blanks in the text are then compressed to a single blank (though two blanks are allowed following the characters: ? . ! :). The Margin command only works when Filling is set true and Auto indent is set false.

With Filling set false, the wrap around and margining functions are disabled. When approaching the end of a line, the system generates a "beep" to inform you that you need to press **Return** or **ENTER** to go to the next line. If you type past the display area of the screen, an exclamation point (!) is shown in the last column. The text, though not visible, is maintained in the computer's memory.

The Left margin may be set to any integer between 0 and 9999. Numbers longer than 4 digits are truncated by the system. The Left margin must be less than the Right margin setting or an error message is generated when you attempt to exit the environment.

The Right margin setting has the same numerical limitations as the Left margin. Unless you have a particular reason for doing so (like making full use of a 132 column printer), it is not a good idea to set this margin beyond the right column display limits of your screen because the text will not be visible.

The Paragraph margin can be set to any positive integer up to 4 digits. This setting determines the indentation that the first line in each “paragraph” will get. This occurs when Filling is set false (while inserting text) or when Margin is used. Note that a paragraph as defined by the Editor is any text surrounded by blank lines or by lines beginning with the Command character (discussed below). The beginning and end of a file will also delimit paragraphs.

The Command character can be any non-control ASCII character. If this character is the first non-blank character in a line, the Margin command treats the line as if it were blank. The line is not margined and it is considered to be the beginning or the end of a paragraph. The default Command character is the (^) character.

Token is a boolean used by the Find and Replace commands. When Token is set true, the default value for Find or Replace becomes token and the command’s prompt displays the literal option. (Token and literal refer to the type of target string searches that take place in these commands). Conversely, if Token is false, the default value for Find and Replace is literal and the command’s prompt displays token as an option.

The **Ignore case** command affects searches in the Find and Replace commands. If “Ignore case” is left as False, then “string” and “STRING” and “String” are not treated as equal. If “Ignore case” is set to True, they are treated as equal. This only works when the Environment’s **Token** mode is True or if you type a “T” before typing the target string.

The **Zap markers** command removes all markers from the file.

The environment display is left and the Editor’s main prompt returned by pressing **Return** or **ENTER**, **Select** (**EXECUTE**), or the space bar. The current environment settings are automatically saved with your file when the text is written to a disc or other mass storage medium.

Although there is only a single environment associated with a text file, the environment may be set to one of two predefined configurations: the **Program environment** (by pressing **S** **P**) and the **Document environment** (by pressing **S** **D**). These configurations optimize the various environment parameters for writing programs or regular (non-program and non-tabular) text, respectively. When either predefined environment is Set, the current environment is displayed and any of its parameters can be changed. If you want to change just one or two parameters, use **S** **E** to get into the existing environment.

Changes made to the environment cannot be aborted but the parameters may be changed as many times as desired.

VERIFY

Verify refreshes the screen display from memory.



Semantics

The Verify command has no options; it is executed immediately by pressing . Verify causes the Editor to refresh or update the current screen display from memory, move the current line (the one where the cursor is) to the middle of the screen, and display the Editor prompt. If the cursor is located in the first 23 lines of text when Verify is used, the line containing the cursor is not moved.

eXchange

eXchange replaces text character for character at the cursor position.

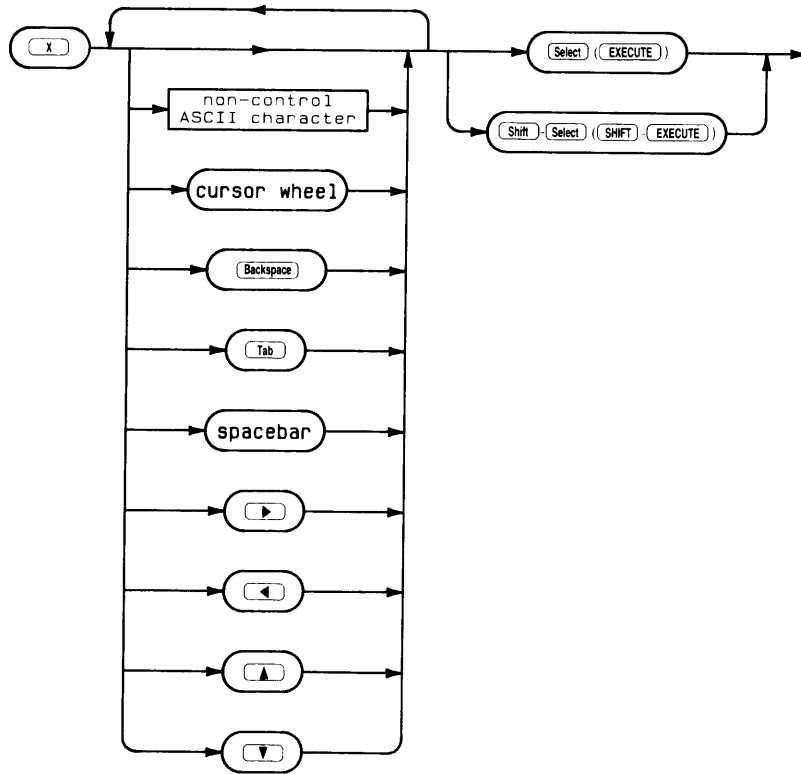

Item	Description/Default	Range Restrictions
non-control ASCII character	literal	any valid ASCII character excluding: CHR (0) thru CHR (31) and CHR (127).

Semantics

The eXchange prompt:

```
>Xchange: Text <bs> <sh-sel> aborts <sel> accepts
```

The eXchange command lets you exchange the text in a line on a character-for-character basis, beginning at the cursor position. Typing a character overwrites the character at the current cursor position and moves the cursor to the next character to the right. Using the horizontal cursor-positioning keys is also allowed: backspacing (such as with **Backspace**, **◀**, or cursor wheel) moves the cursor backwards and restores the original character; forwardspacing moves the cursor over the existing characters without changing them.

The exchange command operates only on the current line (i.e., the line where the cursor is located when the command is entered). Attempting to move the cursor vertically will generate question marks that overwrite the existing characters. Backspacing past the point at which eXchange was entered is not allowed.

Almost any ASCII character can be used in eXchange; however, use of control characters is not advised. Carriage returns cannot be entered, since you are not allowed to cross line boundaries while in the eXchange mode. Direction and repeat factors do not apply to this command.

eXchange is initiated by pressing **X** and is exited by pressing **Select** (**EXECUTE**) or **SHIFT**-**Select** (**SHIFT**-**EXECUTE**). **Select** confirms the exchanges, returns the Editor prompt, and displays the cursor at its position when **Select** was pressed. **SHIFT**-**Select** returns the copy of the text file in the computer's memory to its state before eXchange was entered, displays the Editor prompt and shows the cursor at its position when eXchange was entered.

Zap

Zap deletes text and fills the copy buffer with the deleted text.

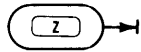

Semantics

The Zap command has no options; it is executed immediately by pressing **Z**. Zap deletes all text between the “anchor” and the current cursor position and stores it in the copy buffer. The anchor is located at the position in the text where the most recent Adjust, Find, Insert or Replace command was executed. (You can confirm the position of the anchor with the Equals command, which moves the cursor to the anchor).

If more than 80 characters are going to be Zapped, the Editor displays a prompt asking if you wish to Zap anyway. Also, if the Copy buffer is not large enough to store the deletion, a prompt asks if you wish to go ahead and Zap the text. (Use the Set environment command to see how much memory is available; the copy buffer shares this memory with that used to hold the text file in memory).

Recovery of the deleted text is achieved with the Copy (from buffer) command. Zap can also be used to move large chunks of text from one location to another within a file.

Note that the effects of Zap can be surprising since the anchor position is set by four different and commonly used commands (listed above). Therefore, it is a good practice to check the location of the anchor (using the Equals command) before executing a Zap.

<h1>The Filer</h1>	Chapter
	5

Introduction

This chapter documents the use of the Workstation Filer subsystem. The Filer lets you manipulate files in various ways, including creating, listing, duplicating, and deleting files. The Filer can handle files on devices with various directory structures and physical characteristics.

Before you read this chapter, you should read “The File System” chapter which defines basic concepts such as files, volumes, and directory organizations.

There are four main sections in this chapter.

- The first two demonstrate how to enter and use the Filer by leading you through a sample Filer session which uses the more common Filer commands.
- The next section, “A Closer Look,” presents detailed information about the Filer and its operation.
- The “Filer Commands” section contains an overview or summary of all the Filer commands (useful for quick reference once you are familiar with the Filer), and a semantic and syntactic description of each Filer command, presented in alphabetical order.

Any questions you have about commands covered in the sample session should be answered in the commands section.

Entering the Filer

If your system is not already “up and running”, refer to Chapter 1 for information on loading the Pascal System. The following prompt must appear on the top line of your screen before you can enter the Filer:

```
Command: Compiler Editor Filer Initialize Librarian Run eXecute Version ?
```

The prompt tells you that you are at the system’s Main Command Level — the level from which all the Pascal subsystems (Compiler, Editor, Filer, etc.) are entered. Entry is accomplished by typing the uppercase character of the subsystem you wish to enter (for instance, R for Run and X for eXecute).

Insert the disc labeled ACCESS: and press the key. You can use either uppercase or lowercase letters when typing commands at the Main Command Level. However, letter case is important when typing file names. The screen displays:

```
Loading 'ACCESS:FILER'
```

You can use the Permanent command (from the Main Command Level) to keep the FILER code file in memory if you wish. This will allow faster access to the Filer but uses more memory. Chapter 1 explains how to “permanently load” the Filer.

The Filer Prompt

The screen clears and displays the Filer prompt on the top line:

```
Filer: Change Get Ldir New Quit Remove Save Translate Vols What Access Udir ?
```

You are now in the Pascal Filer subsystem. The Filer prompt shows the most common commands used in the Filer and “prompts” you to give the subsystem a command.

The prompt shows only a partial list of the available commands; to see the others, type . The prompt line shows the Filer’s alternate prompt:

```
Filer: Bad-secs Ext-dir Krunch Make Prefix-vol Filecopy Duplicate Zero ? [3.0]
```

The alternate prompt displays the revision number of the Filer in brackets. Type again and the main Filer prompt reappears.

All Filer commands are initiated by typing a single key corresponding to the first character of the command shown in the Filer prompt. Uppercase and lowercase command characters are treated as equivalent by the Filer, so the keys may be typed in whatever form is convenient.

Filer operations can be aborted by typing **SHIFT-Select** (**SHIFT-EXECUTE**) when a single character is expected and **SHIFT-Select Return** or **ENTER** in place of a file specification.

Filer Operations

All of the commands in the Filer operate in one of two ways: the Filer either performs the operation immediately (when you press the letter key for that command) or it requests the information it needs to perform the operation and then does it. The request is generally for a volume specification or a file specification since all of the Filer's commands (except Quit) operate on volumes, directories and files.

A volume specification identifies a particular volume. This can be done by supplying any of the following: the name of the volume; its associated unit number; a colon (:) to specify the default volume; or an asterisk (*) to specify the system volume. A file specification consists of both a volume specification and a file name; it completely identifies a particular file. All file specifications include a volume specification even if by default. If the volume specification is omitted and only the file name is given, the Filer looks for a file of that name on the default volume.

A Sample Filer Session

Work through the following examples on your machine as you read through this section. Interacting with the computer will teach you more about the Filer than just reading the material.

Finding Out What Devices are Accessible

Now that you have the Filer prompt on the screen, press **V**. This initiates the Volumes command and the screen now displays the volumes or I/O units associated with the Pascal System. Here is a typical display (yours may vary slightly):

```
Volumes on-line:
1  CONSOLE:
2  SYSTEM:
3  # MYVOL:
4  # ACCESS:
5  # SRM_WORK:
6  PRINTER:
45 # SYSTEM04:
Prefix is - MYVOL:
```

For each volume, the display shows the logical unit number and the associated volume which are currently on-line. Volumes #5 and #45 are SRM volumes which you may or may not have.

The “#” beside units 3, 4 and 5 indicates that these are blocked devices. These are used for mass storage. The “*” beside unit 45 indicates that this is the system volume; also a blocked device. The system volume is used by the system during certain operations and should be left on-line at all time if possible. “Prefix is” indicates which is the default volume. The default volume is assumed when no volume identifier is given. The default volume can be changed using the Filer’s Prefix command and the Main Command Level’s What command.

The Default and System Volumes

At power-up, the system generally designates the highest performance mass storage device as the “system volume” because it needs a volume to work with occasionally. The system volume is denoted by an asterisk (*) in the Volumes command display and remains fixed unless the New system volume command or the What command is used at the Main Command Level.

The Prefix command, because it defines the default volume, lets you specify a particular volume where the Pascal System will look for files when you haven’t given a volume name or logical unit number. This is handy in the Filer as well as in other subsystems such as the Compiler or Editor.

The default volume can be indicated with the colon (:) character. For example, to list the directory of the default volume, press (for the List directory command) and answer the prompt by typing “:”. The Filer then displays the directory of the current default volume.

Changing the Default Volume

You can use the Volumes command (from the Main Command Level) to see what volume is the current default volume. It is listed under the heading `P r e f i x` in the Volumes display. You can also see what the current default volume is by pressing for the Prefix command. The screen displays:

```
Prefix to what directory ?
```

Respond by pressing or . The screen now displays the current default volume. Now press again and in response to the prompt, type `MOJO:`. The screen now displays:

```
Prefix is MOJO:
```

Now, whenever you want to specify a file or group of files on the `MOJO:` volume, you can just type the file name(s) and the Filer will assume that the file or files specified are on the volume `MOJO:`.

It is possible to set the default prefix to a flexible disc drive, regardless of the volume inside. This is done by typing:

```
#3:  or 
```

while the drive door is open.

The prefix command is used to set up a working directory on a Shared Resource Management system as well. If you had an SRM file named:

```
#5:USERS/JOE/PROJECT1/PROGRAMS/FILE
```

Initiate the Prefix command as usual and specify:

```
#5:/USERS/JOE/PROJECT1/PROGRAMS
```

This sets the SRM volume as the default volume and `USERS/JOE/PROJECT1/PROGRAMS` as the working directory on the SRM. If the previous working directory had been `PROJECT1`, then only `PROGRAMS` need be typed. Now you can specify the file with:

```
FILE
```

If you were to use the Prefix command again to set the default prefix to another volume (not on the same unit), the working directory and volume name for the unit remain `PROGRAMS`. You need only specify either of the following to get the same file.

```
#5:FILE
```

or

```
PROGRAMS:FILE
```

It is possible to change the working directory on an SRM unit without changing the default volume. Use the Filer's Unit directory command. Press and then give the directory name that you wish to become the working directory. If the new directory is in the existing working directory, just type the new directory name. If it is not, type the whole directory path as shown above in the Prefix example.

Note

Do not use the Prefix command on unit #45. This is the system volume and should not be altered.

The System Volume

The system volume can also be specified in a shorthand form using the "*" character. Suppose you want to specify the file named `LIBRARY` on the volume `SYSVOL:`. Assuming that `SYSVOL:` is the system volume and is currently in the disc drive associated with unit #3, you can specify a file on that volume by entering any one of the following three methods:

```
SYSVOL:LIBRARY
```

or

```
#3:LIBRARY
```

or

```
*LIBRARY
```

Of course you can make the specification even shorter by typing something like:

```
*=ARY
```

However, if you are doing a critical operation, be sure that there are no other files on the same volume which fit that file specification or use the ? wildcard instead. If a file named GARY existed on SYSVOL:, the operation would also be performed on it. Once again, **use wildcards judiciously**.

Listing a Directory

To find out what files are on the disc called ACCESS:, press **L** to initiate the List Directory command. The Filer prompts you to specify the volume whose directory is to be listed:

```
List what directory ?
```

Respond by typing ACCESS: and pressing **Return** or **ENTER**. Notice that the colon (:) is part of the volume specification. The screen now displays the directory (catalog) for ACCESS:. It looks similar to this display:

```
ACCESS:          Directory type= LIF level 1
created  8-Oct-82  3.47.54 block size=256
Storage order
...file name...  # blks    # bytes  last chng

FILER                218      55808  8-Oct-82
EDITOR               228      58368  8-Oct-82
LIBRARIAN            202      51712  8-Oct-82
MEDIAINIT.CODE       132      33792  8-Oct-82
TAPEBKUP.CODE        54       13824  8-Oct-82
FILES shown=5 allocated=5 unallocated=11
BLOCKS (256 bytes) used=834 unused=218 largest space=218
```

The name of the volume is displayed in the upper left-hand corner of the listing. To the right, the directory type is displayed. Pascal discs have Level 1 directories. Level 1 directories contain the date the directory was created and the size of the volume. Level 0 directories do not. Your directory listing should display the date the directory was created and the date it was changed as system volume, the size of the storage blocks, and whether the listing is in storage order or alphabetical order. The size of blocks on LIF volumes is 256 bytes (1 sector). The size of blocks on WS1.0 volumes is 512 bytes. The Shared Resource Management system does its accounting in 1-byte units. To have directories listed in alphabetical order, include [*] after the directory name. For example:

```
LIFDIR:[*]
```

The column entries for each file include: file name, number of blocks used for storage, the file size in bytes, and the date the file was created or changed.

The last two lines display additional directory information including how many more entries can fit in the directory. The size of a directory is specified when the disc is initialized.

Getting a More Detailed Listing

To get a more detailed listing of the directory on a disc, press **E** (for the Extended Directory command) and you will be prompted for a volume name as before. Respond by typing:

ACCESS: **Return** or **ENTER**

Your screen now displays:

```

ACCESS:          Directory type= LIF level 1
created 8-Oct-82 3.47.54 block size=256
Storage order
...file name.... # blks  # bytes  start blk ...last change...extension1
                  type  t-code ..directory info... ..create date... extension2
FILER            218     55808      4 8-Oct-82 3.48.6           0
                  Code  -5582
EDITOR           228     58368     222 8-Oct-82 3.48.18          0
                  Code  -5582
LIBRARIAN        202     51712     450 8-Oct-82 3.48.35          0
                  Code  -5582
MEDIAINIT.CODE  132     33792     652 8-Oct-82 3.48.44          0
                  Code  -5582
TAPEBKUP.CODE   54      13824     784 8-Oct-82 3.48.48          0
                  Code  -5582
< UNUSED >      218           838
FILES shown=5 allocated=5 unallocated=11
BLOCKS (256 bytes) used=834 unused=218 largest space=218

```

The Extended directory listing contains all the same information as the List directory listing with additional information. It also contains the number of the block where the file starts, the type as recognized by the file system, the type-code used by the directory system, SRM access information and two extension fields.

The “directory info” column shows the public access rights and the current file status for SRM files. (Because the listing above is not from an SRM volume, the column is empty.)

If one of the letters from the table below is missing, then the public access right associated with that letter has been removed.

<u>Letter</u>	<u>Access Right</u>
M	Manager
R	Read
W	Write
S	Search
P	Purgelink
C	Createlink

Public access rights on a file are established at one of two times. If a file is created by a program, the public access rights can be established when the file is opened. To do this, use the optional third parameter on the command used to open the file. The commands used to open files are Reset, Rewrite, Open and Append. The optional third parameter is explained in more detail in the File System chapter and in the HP Pascal Language Reference.

If a file already exists, the Filer's Access command can be used to establish or, if the Manager right has not been removed, change the public access rights.

The possible "current file status" are listed below and explained in the "File System" chapter.

CLOSED
SHARED
EXCLUSIVE
CORRUPT

The two extension fields are for LIF directories only. The other directories display a "- 1". For most LIF file types, extension1 contains a "0". For system files, it contains the start execution address. For data files, it contains the logical end-of-file. Extension2 contains the volume number in cases of multi-volume files. The Pascal system cannot create or read multi-volume files; the LIF DAM merely recognizes them. For single volume files, it contains a "1".

The above examples are the most common uses of the directory listing commands, but there are two other useful ways of using the command. One is to use a "wildcard" to specify a subset of files that you want listed. The other way is to send the listing to the printer or to a file instead of letting the listing default to the screen. Both methods are combined in the example below and are covered in detail in the "Filer Commands" section. Press again (to initiate the Extended Directory command) and answer the prompt for a volume specification as shown in the display:

```
List_ext what directory ? ACCESS:=.CODE,PRINTER:  or 
```

The ACCESS: volume should be on-line. Your specification tells the Filer you want a listing of all the files on the ACCESS: disc whose name ends in ".CODE". The "=" acts as a substitute for all combinations of characters in a file name. The ";" separates the source specification from the destination specification. The listing should only display the files whose names end with ".CODE". The EDITOR, FILER and LIBRARIAN are not listed because their names don't end in ".CODE".

A Few Words About Wildcards

Wildcards are powerful tools for executing Filer commands on related files. There are three wildcard characters.

? = \$

A wildcard is a substitute for an arbitrary portion of a file name. For example, if you wanted to list all the .CODE files on the EXAMP: volume, you could specify:

```
EXAMP:=*.CODE
```

The “=” stands for any combination of characters. If the file name ended with “.CODE”, that file would appear in the listing. If you wanted to remove some of the .TEXT files on the EXAMP: volume, you could specify:

```
EXAMP:?.TEXT
```

The “?” also stands for any combination of characters. However, the Filer will ask you, one at a time, if you want to remove each file that fits the specification. The “?” wildcard lets you verify operations before actually performing them. Unless you are absolutely certain about the effects of a command using the equals sign wildcard (=), its best to use the question mark — by far the safer of the two.

The “\$” character is a valid wildcard for destination file specifications. It indicates that the file is to retain its original name. If “\$” is used with other characters, it is used as part of the name.

Wildcards act as replacement strings in file names. Part of a file name can be given before or after the wildcard or both before and after. For example, two files named WILD.TEXT and WILD.CODE on the default volume could be specified by:

```
WILD? or WILD= or =LD.* or ?ILD=
```

Partial file names must be given in the order in which they appear in the file name.

Translating Text Files

The Pascal system supports several different types of “text” files. These files are usually created by the Editor and can be programs, documents, or data. When the file is stored on a disc, the internal representation (format) of the file is determined by the suffix appended to the file specifier. The different formats have different information in the file header and can have different end-of-line schemes. The Translate command can be used to convert from file type to another. The various file formats recognized by the Pascal system are TEXT, ASCII, and DATA. No suffix indicates a DATA file, a .TEXT suffix indicates a TEXT file and a .ASC suffix indicates an ASCII file.

To use the Translate command, press and see the prompt:

```
Translate what file ?
```

Respond with the name of your input file

```
MYVOL:MYFILE.TEXT
```

The Filer will then prompt:

```
Translate to what ?
```

Respond with the name of your output file

```
MYVOL:NEWFILE.ASC
```

The Filer will create an output file of a type corresponding to the suffix on the output file name (ASC in the example) and will read the text data from the input file, reformat the data to match the output file type, and write the data to the output file. This process may seem slow, but remember that the text is being reformatted.

Sending File Listings to the Printer and Screen

The Translate command is used to send files to the printer or to the screen. Logically, the printer and screen are just files of a different format.

Before using the Translate command, remove the volume ACCESS: and replace it with the volume DOC: (supplied with this manual set). Now use the Extended Directory command to display the contents of the DOC: volume. Press **E**, type in DOC: and press **Return** or **ENTER**. Your screen should display all the files on the documentation disc.

Press the space bar: this clears the screen of everything except the Filer prompt. Now press **T** to initiate the Translate command. The screen prompts you with:

```
Translate what file ?
```

Respond with DOC:BINDOC.TEXT and press **Return** or **ENTER**. The screen now prompts:

```
Translate what file ? DOC:BINDOC.TEXT  
Translate to what ?
```

Your first response includes both a volume specification and a file name and completely identifies the file you want to transfer. Now type PRINTER: and press **Return** or **ENTER**. The text file is translated to the printer as shown:

```
BEGIN {Binary_search}
  done:=FALSE; btm:=0; top:=26; {initialize}
  FOR loop:=1 TO top DO alpha[loop]:=CHR(loop+64);
  WRITELN('Type uppercase character for a key');
  READ(key); WRITELN;
  WHILE NOT done DO
    BEGIN {This is the actual binary search}
      mid:= ROUND((top + btm)/2);
      IF key = alpha[mid] THEN done:= TRUE
      ELSE IF key < alpha[mid] THEN top:=mid
      ELSE btm:=mid;
      IF top=btm THEN BEGIN
        done:=TRUE; mid:= -1;
      END;
    END;
  IF mid > 0 THEN
    WRITELN('Key -',key,'- is in position ',mid:2)
  ELSE WRITELN('key - ',key,' - was not found');
END.
```

The Filer shows you what operation it has just performed by displaying:

```
DOC:BINDOC.TEXT
```

```
==> PRINTER:
```

Since the operation is complete, the Filer again displays its prompt. Note that only files of type TEXT, ASCII or DATA should be sent to the printer. You can also Translate these files to the screen by using CONSOLE: in the destination specification instead of "PRINTER:". The file is displayed one screen at a time. Press the spacebar to move to the next screen; press **SHIFT**-**Select** (**SHIFT**-**EXECUTE**) to abort the operation.

If you are not sure if the file in question is a text file, use the Extended Directory command and look at the column in the display where the file types are shown.

Copying Entire Volumes: Backup Copies

The backup process described here is suitable for volume-to-volume copies if both volumes are the **same** size. For **different** size volumes, see Filecopy in the "Filer Commands" section.

Note

Using Filecopy to copy an entire volume will result in the loss of disc space if the source volume is *smaller* than the destination volume. To copy a volume to a larger one, Filecopy individual files.

You should still be at the Main Command Level and now have a blank initialized disc. We will use it for a volume-to-volume filecopy. Volume-to-volume filecopies do not require that a directory be present on the destination disc.

Insert ACCESS: in the disc drive. Press and the Filer gets loaded and displays its prompt:

```
Filer: Chanse Get Ldir New Quit Remove Save Translate Vols What Access Udir ?
```

Press for the Filecopy command and the screen shows:

```
Filecopy what file ?
```

Now type ACCESS: and press or . The screen displays:

```
Filecopy what file ? ACCESS:
Filecopy to what ?
```

You can specify a volume by specifying the logical unit number associated with the physical disc drive that it is in. Do this by typing #3: and pressing or . The Filer knows that ACCESS: is currently in the drive associated with unit #3 and figures that you want to transfer that volume to a different volume that will be inserted in the same drive. The Filer then reads as much of ACCESS: as it can into read/write memory and the screen displays:

```
Please mount DESTINATION in unit #3
'C' continues, <sh-exc> aborts
```

Now remove ACCESS:, replace it with the blank initialized disc, and press . Since no directory is on the initialized volume, the Filer simply copies the ACCESS: information that it read into memory onto the new disc. If there had been a directory named TESTER: on the destination volume, the Filer would have prompted:

```
Destroy directory of TESTER: ? (Y/N)
```

This precaution makes sure the information on the disc does not get destroyed if you change your mind or inserted the wrong disc. Answering with for "No" aborts the Filecopy operation and the Filer prompt returns. Answering with a for Yes lets the Filecopy take place and the contents of ACCESS: are written to the new disc. This operation destroys the directory (and, effectively, all information) that was previously on the destination disc.

In case your machine does not contain enough memory to read in the entire volume ACCESS:, the Filer prompts you to swap the source and destination discs as many times as necessary to complete the Filecopy operation. When the operation is complete the Filer prompt reappears.

If you have more than one disc drive you can accomplish the same task by specifying both the source and destination volumes with either a volume name (if it has one) or by the unit number associated with the drive it is in. This second method of doing volume-to-volume transfers is quicker — especially if the amount of memory in your machine is relatively small.

Note

Having two volumes with the same name on-line at one time is not advised. The Filer looks for volumes according to their volume names and may not be able to distinguish one from the other. Thus, the Filer may perform an action on one volume when you wanted the operation to affect the other volume. The Filer warns you whenever it detects that this condition exists. If you get a warning, either remove one of the volumes or use the Filer's Change command to change the name of one of the volumes.

Creating a Directory

In general, the Filer only works with volumes that already have directories. There are a few exceptions to this rule, such as volume-to-volume transfers where the directory from the source volume is copied onto the destination volume. Other exceptions are mentioned as they arise. The Filer's Zero command creates an empty directory on a new disc that has been initialized using the MEDIAINIT program, previously used discs, or on any other compatible type of mass storage device such as a hard disc or a volume stored in read/write memory. The Zero command, however, is not used to create directories on the Shared Resource Manager. This is done with the Filer's Make command because making an SRM directory really involves making a file of type "directory".

Your screen should now display the Filer prompt. Remove the current volume from the disc drive associated with unit number 3 and replace it with the second disc that you initialized. Now press **Z** to initiate the Zero command. The screen displays:

```
Zero directory (NOT valid for SRM type units) Zero what volume?
```

The request is for a volume specification. Answer with **#3:** and press **Return** or **ENTER**. The Filer now prompts:

```
Destroy V3: ? (Y/N)
```

This question is just a safety precaution so that you won't destroy a volume full of information by accident. "V3" is the name given to the directory by MEDIAINIT (if created on unit #3). Press **Y** for yes. The next prompt is:

```
Number of directory entries (8) ?
```

This is asking for the maximum number of files that will be listed in the directory. The number in the parentheses is the default that will be used if no value is given and is derived from the number in the existing directory. In most cases, 80 directory entries is a good choice.

The next prompt is:

```
Number of bytes (270336) ?
```

This is asking for the total size of the disc to be handled by the directory (the logical size of the volume). The number in the parentheses is derived from the number in the existing directory (if any) or from the unit table entry for that given unit. Press **Return** or **ENTER** to accept the default size for your disc.

The system now prompts you for a volume name. Volumes and volume name syntax for the different directory types are described in the File System chapter. Briefly, LIF directory names must be six characters or less; upper and lower case characters being distinct. WS1.0 directory names must be 7 characters or less and are always uppercased before being written in the directory. The Filer then confirms that the volume name is the one you wanted. The screen now appears:

```
Zero directory (NOT valid for SRM type units)
Zero what volume ? #3
Destroy ACCESS: ? (Y/N) Y
Number of directory entries (8) ? 80
Number of bytes (270336) ?
New directory name? NEWONE
NEWONE: correct ? (Y/N)
```

When you press **Y** to confirm the new volume name the Filer informs you that the volume with that name has been zeroed and the Filer's prompt appears. Your new volume is now ready for use.

Copying Files from Volume to Volume

The Filecopy command allows you to copy files from one volume to another or even to a different place on the same volume. The volumes can be separate discs, SRM directories or, in the case of a hard disc, multiple volumes on the same physical device.

Remove the current volume from drive #3 and insert the DOC: volume supplied with this document set. To copy a file from one volume to another, press **F** for Filecopy and respond to the prompt for a file specification with:

```
DOC:STREAM.TEXT
```

When the Filer prompts you for a destination, type in the specification shown below and press or .

```
Filecopy what file ? DOC:STREAM.TEXT
Filecopy to what ? #3:$
```

What happens here is similar to copying a volume from one disc to another using a single drive. The Filer reads the contents of DOC:STREAM.TEXT into memory and then displays the message:

```
Please mount DESTINATION in unit #3
'C' continues, <sh-exc> aborts
```

Take another disc and insert it in drive #3. Now that you have your new disc in drive #3, press to continue. The Filer writes the contents of the file that it temporarily stored in memory to the disc you just inserted and confirms that the Filecopy has taken place.

If you give a unit number (as above) or a different volume name which is not on-line, you must swap discs to complete the copy.

The wildcard (\$) is a feature to avoid repetitious typing and tells the Filer to give the destination file the same name as the original file — STREAM.TEXT.

When copying a file to a different volume, **always** include either a file name or the \$ character when you specify the destination. If you specify the name of a mass storage volume without a file name, the Filer prompts:

```
Destroy directory of SYSVOL: ?
```

Although the volume name may be different, if you answer with a , the Filer transfers the specified file to the destination volume, **destroying** the directory in the process, and rendering all previous information on that volume useless.

The next example demonstrates how to copy multiple files from one volume to another using the ? character as a wildcard. Press once again and respond to both the prompts as shown:

```
Filecopy what file ? DOC:MOD?TEXT
Filecopy to what ? MKWORK:$
```

This tells the Filer to copy all the files on the DOC: volume that begin with the characters “MOD” and end with the characters “TEXT” to the volume MKWORK:, giving each the same name it had on the DOC: disc. Before the Filer actually copies any files, however, it will verify with you that you actually want to copy each file that fits the specification. Respond to each prompt with a Y for “Yes.” As you answer each prompt affirmatively, the Filer copies the corresponding file to the destination (MKWORK:) volume. If you have a single-drive system, the Filer will prompt you to swap the discs as in the previous example.

It is worth mentioning that, although specifying a unit number is less typing than specifying a volume name, when you specify a unit number the Filer initially accesses the volume (disc) currently in the drive without regard to whether or not it was the one you intended. After the first access of a volume, the Filer associates a supplied unit number with the name of the volume found in that device. However, if you specify a volume name, the Filer only performs the command on that volume. If the volume you specified is not on-line the Filer will tell you so. Specifying the volume name is a good habit if you are doing a lot of disc “swapping”; this will insure that the Filer does not operate on a disc other than the one you intended to use.

In cases where the destination volume already contains a file with the same name as the file being copied, this prompt is displayed:

```
ANYVOL:XFILE
exists ... Remove, Overwrite, Neither ? (R/O/N)
```

You have the options:

- Remove — remove the original file first, then write the new file in the largest space available.
- Overwrite — replace the contents of the old file with the new information. The Overwrite option cannot be used to change the type of a file on SRM. Attempting to do so will result in the file contents being inconsistent with the file type.
- Neither — cancel the operation.

The Overwrite option allows you to put a file in the same starting location as the original. This is important to SRM users when duplicate links exist to a file. All links and passwords to the file are accurate when a file is updated because it is put in the same logical location. If you chose the Remove option, the original file would not actually be removed; only your link to it is removed. The other user’s directories are still linked to the original file.

Note

Be careful when using the Overwrite option on an SRM system. If the file specifier suffix (.TEXT, .ASC, or none) is not the same as the original file suffix, the contents of the file may become inaccessible.

Note

The Pascal Filer can also copy BDAT (BASIC Data: file type –5791) files produced by the HP BASIC workstation system. However, there are some side effects that occur when copying BDAT files from LIF to SRM directories, and vice versa. See the description of the Filecopy command in the “Filer Commands” section near the end of this chapter.

Renaming Files and Volumes

The Filer’s Change command allows you to rename files and volumes. (The one exception is that the root directory of the Shared Resource Manager cannot be renamed.) This command requires two specifications: the original name and the new name (the first name may include volume specification and pathname and passwords for SRM, but the second name **cannot**). Assuming that the volume MKWORK: is still on-line, press for Change and respond to the prompt as shown:

```
Change what file ? MKWORK:,MOJO:
```

The volume name is now “MOJO:”. To change the file STREAM.TEXT on the MOJO: volume to RIVER.TEXT you can either type out both names (separated by either a comma or a press of the or key) or use a wildcard as shown below:

```
Change what file ? STREAM=  
Change to what ? RIVER=
```

The Filer changes the file name as described. The wildcard was used as a substitute for the .TEXT part of both names. The only restriction on using wildcards with this command is that if you use a wildcard in one of the specifications, you must use it in the other. Because the strings or subsets represented by the wildcard are not always obvious, discretion is advised when using wildcards with the Change command.

When changing the name of a file of type TEXT or CODE, remember that parts of the Pascal System attempt to append the suffixes “.TEXT” or “.CODE” to the file you specify. You can get around this by specifying a file and adding a period (.) to the file name. This tells the system not to append the suffixes to the file name for which it searches.

Note

Excluding the Get command, the Filer makes no assumptions about suffixes and will treat a trailing period as part of the file name.

Removing Files

The Remove command is provided to delete files from a directory of a block structured volume. Suppose you have a volume on-line named NEWSTUF: containing the file POLYNOM.TEXT that you wish to delete. Press to initiate the Remove command and respond to the prompt as shown:

```
Remove what file ? NEWSTUF:POLYNOM.TEXT
```

Then press or . The Filer removes the specified file from the volume and reports:

```
NEWSTUF:POLYNOM.TEXT removed
```

The Filer prompt reappears as the message is displayed. As in many of the Filer's commands, the prompt requests a file specification. Wildcards can be used with the Remove command but should be used carefully. The question mark (?) wildcard provides an easy method for removing a TEXT and CODE file of the same name. It also lets you verify the operation (a good practice when purging files).

Suppose the same volume NEWSTUF: contains two files you wish to remove called IOTEST.TEXT and IOTEST.CODE. To remove these files answer the "Remove what file?" prompt with:

```
NEWSTUF:IOTEST?
```

and press or . The Filer responds with:

```
Remove IOTEST.TEXT ? (Y/N)
```

Reply with (for Yes) to remove the file. Reply with (for No) if you change your mind. Either reply results in the next prompt:

```
Remove IOTEST.TEXT ? (Y/N) Y
Remove IOTEST.CODE ? (Y/N)
```

Reply as before and the Filer responds with:

```
Remove IOTEST.TEXT ? (Y/N) Y
Remove IOTEST.CODE ? (Y/N) Y
Proceed with remove ? (Y/N)
```

This gives you one more chance to change your mind about the operation. The files are not actually removed from the volume's directory until you press . Pressing has the same effect as if you had never initiated the command (i.e., the directory remains unchanged and your files remain intact).

If you want to remove all of the files on a volume (for discs only; not SRM), the quickest way to do so is to execute the Zero command. This command wipes out the directory of a volume so that the volume may be re-used. See the description of the Zero command earlier in this section or in the “Filer Commands” section.

Leaving the Filer

Exit the Filer by pressing **Q** for Quit from the Filer prompt. You will immediately be returned to the Main Command Level. The Filer can also be exited with the **STOP** key. The **STOP** key waits for any current disc I/O to complete before it actually executes. This key can be used at any time — even while executing a Filer command. However this practice is not recommended since some commands may cause damage to your files if **STOP** is pressed while they are being accessed.

The System Workfile (A Convenient Scratchpad)

The Pascal System features a workfile which can be used in the Filer, Editor, Compiler and Assembler. Each subsystem that uses the workfile documents its use.

Think of the workfile as being analogous to a default volume. In some of the subsystems, you are not prompted for a file specification when entering the subsystem if a workfile of the appropriate type exists. For example, if the text version of a workfile exists when entering the Editor, the Editor never prompts you for a name of the text file to edit but reads in the workfile instead. As a matter of fact, before you can edit any other file, you will need to use the Filer’s New command (preceded by the Save command if you want to retain the file) to release the workfile. In the same manner, invoking the Pascal Compiler when the text version of a workfile exists results in that file automatically being compiled.

If the Filer’s Get command is used, the workfile is the TEXT/ASCII/DATA and/or CODE file specified in the command.

The Filer has four commands (Get, New, Save and What) which operate directly on the workfile. These are covered in the next section.

Filer Commands

This section contains a brief overview and summary of the Filer commands and a complete alphabetized description of the syntax and semantics of all the Pascal Filer commands and options.

Filer Command Summary

Volume Related Commands

Bad sectors – Scans a volume and searches for unreliable (bad) storage areas.

Extended Directory – Lists directory information about a specified volume or set of files.

Krunch – Consolidates all unused space on a volume in a single area by packing the existing files together. (Not valid for SRM)

List Directory – Lists directory information about a specified volume or set of files.

Prefix – Specifies a new default volume.

Volumes – Lists the volumes currently on line.

Udir – Sets the default unit directory. (SRM only)

Zero – Creates an empty directory on the specified volume. (Not valid for SRM)

Exit Commands

Quit – Provides an orderly exit from the filer.

STOP – Pressing the **STOP** key unconditionally exits the Filer Subsystem. The current I/O operation is completed before exiting.

File Related Commands

Access – Change the access rights (passwords) on a file or directory. (SRM only)

Change – Change the name of a file, set of files, or volume.

Duplicate link – Duplicates links to a file or set of files. (SRM only)

Filecopy – Copies a file, set of files, or a volume to a specified destination.

Make – Create a directory (SRM) or a file on a volume.

Remove – Remove a directory entry or a set of directory entries.

Translate – Translates text files of types TEXT, ASCII, and DATA to other text file representations or to unblocked volumes.

Workfile Related Commands

Get – Specifies a file as the workfile.

New – Specifies that no file is the current workfile.

Save – Saves the current workfile(s) with the specified name.

What – Lists the name and current state (saved or not saved) of the workfile(s).

Command Syntax and Semantics

The Filer commands are presented in alphabetical order. Each command's explanation includes: the command's name, a brief functional description, a diagram showing its legal syntax (See Chapter 1), the command's prompt (if any) and text which discusses using the command. Each command's options are also covered and some have examples to show the proper use of these options.

Several of the syntax diagrams on the following pages reference the the "volume only specifier" and the "complete file specifier" below. The "volume only specifier" is the syntax for commands that operate on volumes. The "complete file specifier" is the syntax for commands that operate on files. Volume only specifiers don't need the ":" except when a literal volume name is given. Then the name must end with a ":" to distinguish it from a file name. If no volume specifier is given, the default volume is assumed.

Alphabetical List of Filer Commands

- Access
- Bad sectors
- Change
- Duplicate
- Extended directory
- Filecopy
- Get
- Krunch
- List directory
- Make
- New
- Prefix
- Quit
- Remove
- Save
- Translate
- Unit directory
- Volumes
- What
- Zero

File Specification

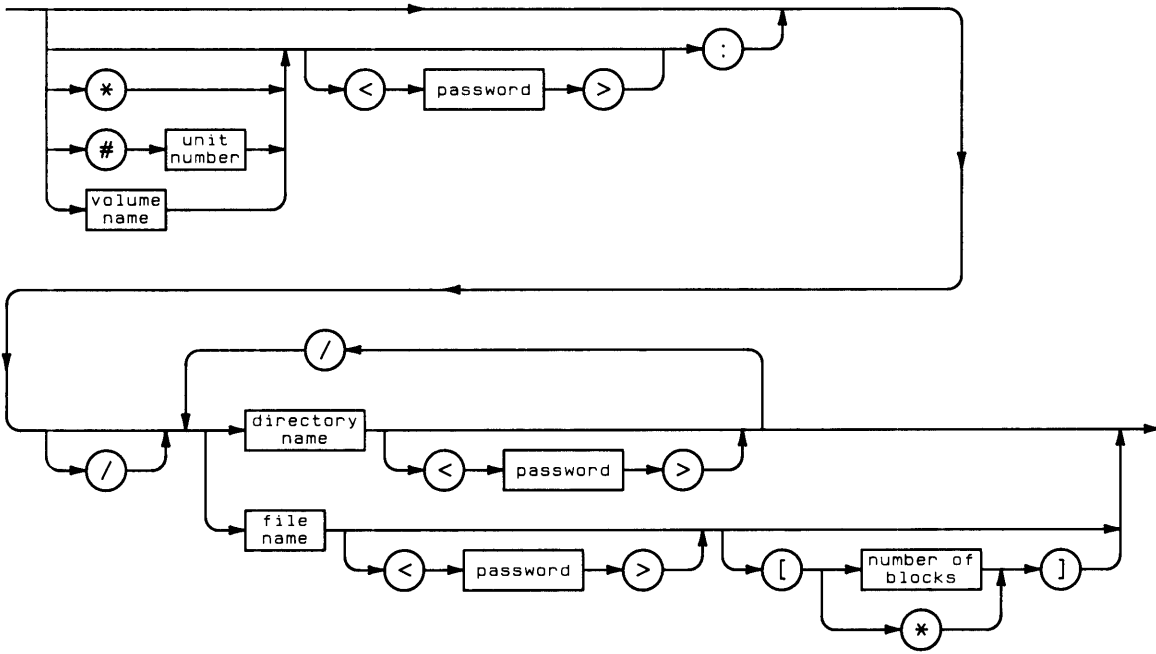

Item	Description/Default	Range Restrictions
unit number	integer; corresponding to an entry in the unit table	1 thru 50
volume name	literal	any legal volume name
password	literal	any legal password
directory name	literal	any legal SRM directory name
file name	literal	any legal file name
number of blocks	integer	any legal number of blocks

See Chapter 2 for legal names and values.

Volume Specification

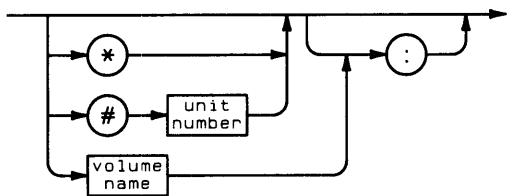

Item	Description/Default	Range Restrictions
unit number	integer; corresponding to an entry in the unit table	1 thru 50
volume name	literal	any legal volume name

Access

The Access command allows you to change public access rights on your files (SRM only).

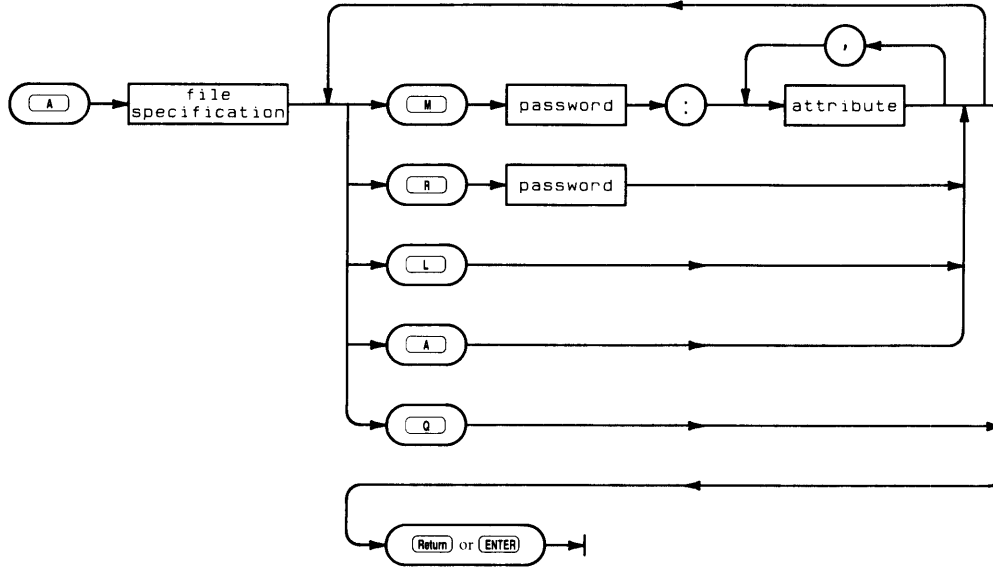

Item	Description/Default	Range Restrictions
file specification	literal	a legal SRM file specification
attribute	literal	MANAGER READ WRITE SEARCH PURGELINK CREATELINK ALL
password	literal	any legal password (See Chapter 2 for details)

Semantics

The Access prompt:

```
Access rights for what file ?
```

Type the file specification. If the file already has a Manager password, then you must include the password in the file specification. Access rights cannot be changed on open files or open working directories.

The next prompt:

```
Access: List, Make, Remove, Attributes, Quit ?
```

These are the possibilities. You can list the attribute passwords, make new ones or remove passwords. The Attributes option just lists the possible attributes for your help. Quit returns you to the Filer prompt.

Bad sector

The Bad sector command scans a mass storage medium for errors.

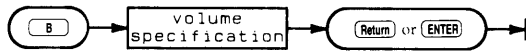

Item	Description/Default	Range Restrictions
volume specification	literal	(See the beginning of this section)

Semantics

The Bad sector prompt:

```
Bad sector scan of what directory ?
```

The Bad sector command allows you to check a mass storage medium to find out if each block (sector) is readable. A flexible disc may become unreliable after damage or excessive wear.

Press **B** to initiate the command and answer the prompt with a volume only specifier. The Filer then displays a message indicating that it is scanning the volume from block 0 to the end of the volume. The Filer does a read operation on each sector and does a CRC error check on the results. If the CRC results are normal, that sector is considered to be good; if not, the Filer lists the sector number.

If you find a bad sector in a file, you may wish to use the Filer to change the file type (suffix) to `.BAD`. (You did make a back-up copy didn't you?) The BAD file will not be moved in a Krunch operation. A large number of bad sectors indicates a worn-out medium. The medium should only be used if you are willing to risk losing information on that volume.

Change

The Change command lets you rename files, directories and volumes.

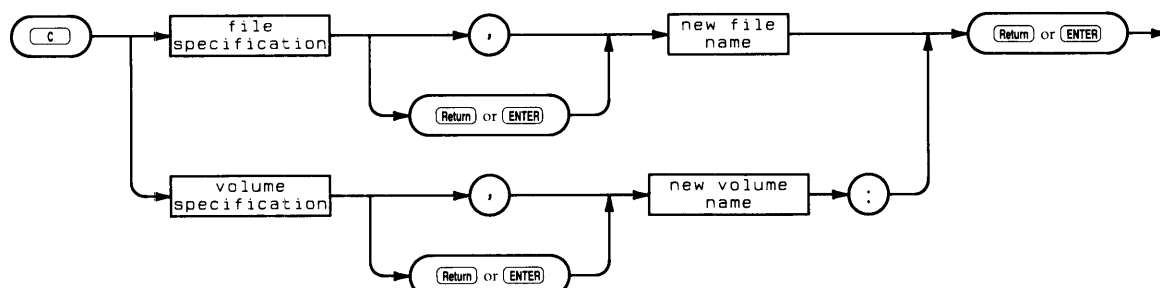

Item	Description/Default	Range Restrictions
file specification	literal	(See the beginning of this section)
volume specification	literal	(See the beginning of this section)
new file name	literal	any valid file name
new volume name	literal	(See the beginning of this section)

Semantics

The Change prompt:

```
Change what file?
```

The Change command requires two specifications: the original volume or file specification and the new one. The two specifications can be separated by either a comma or a carriage return. If you are changing the name of a volume, any legal volume ID can be used for both specifications.

To change the name of a file, use any legal volume ID in the first specification and only the new file name in the second specification. The Filer is intelligent enough to know that the file whose name you are changing resides on the volume identified in the first specification. After the Filer has finished changing the name and updating the directory it reports the name changes it has made.

Because many of the Pascal subsystems append the string `.TEXT` or `.CODE` to a file name given in response to a prompt, it is a good idea to retain these parts of a file name when making a change.

Wildcards (the `*` and `?` characters) may be used in the Change command. If a wildcard is used in the first specification, it must also be used in the second one. The subset string that is replaced by the wildcard in the second specification (the new name) is the same as the string it stands for in the first specification.

Suppose you have a volume named `BUGS:` with the following files:

```
WHATISIT.TEXT  
WHOISIT.TEXT  
WHYISIT.TEXT
```

Specifying `BUGS:WH=TEXT,FO=FA` in response to the Change prompt results in the following messages being reported by the Filer:

```
BUGS:WHATISIT.TEXT  changed to FOATISIT,FA  
BUGS:WHOISIT.TEXT  changed to FOOISIT,FA  
BUGS:WHYISIT.TEXT  changed to FOYISIT,FA
```

Here is another example using the original files shown above on the `BUGS:` volume. Specifying `BUGS:WH=,TEXT,=` results in:

```
BUGS:WHATISIT.TEXT  changed to  ATISIT  
BUGS:WHOISIT.TEXT  changed to  OISIT  
BUGS:WHYISIT.TEXT  changed to  YISIT
```

You may wish to create some empty files using the `Make` command and experiment with them before using wildcards extensively. Until you get used to them, the effects of wildcards are not always obvious.

Note

Using the `Change` command to “change” a file name to the same name results in the file being removed.

Note

The `Change` command does **not** change the file type.

Duplicate_link

The Duplicate_link command establishes a new pointer to a file (SRM only).

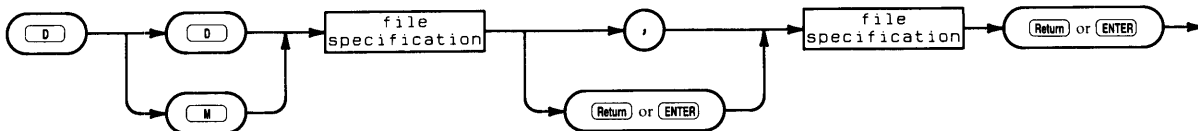

Item	Description/Default	Range Restrictions
file specification	literal	(See the beginning of this section)

Semantics

The Duplicate link prompt:

```
Duplicate link (valid only for SRM type units)
Duplicate or Move ? (D/M)
```

Do you want the original pointer to the file removed after the duplicate link is established? If you do, type M — if not, type D .

The next prompt:

```
Dup_link what file ?
```

Type the SRM file specification (including the password if the CREATELINK capability has one).

```
Dup_link to what ?
```

Type the new file specification. Wildcards can be used in the specification. This puts a link to the file in a second directory. If the Move option was requested, the original link is then removed.

If the file is referenced from two or more directories, the file is physically removed from the disc only when all links to the file have been removed.

You should be aware that new CODE files generated by the Compiler, Assembler and Librarian to replace older versions are not written in the same space (unless Overwritten). If several directories have duplicate links to the same CODE file and the CODE file is recompiled, only one directory has an accurate link to the new CODE file. Other users must use the Duplicate link command to become linked to the new CODE file.

Note

Using the Duplicate_link command to “duplicate link” a file to the same file results in the file being removed.

The Duplicate_link command cannot duplicate links or move files which are on different physical volumes.

Extended directory

The Extended directory command lists the directory of a blocked volume or a set of files in the volume.

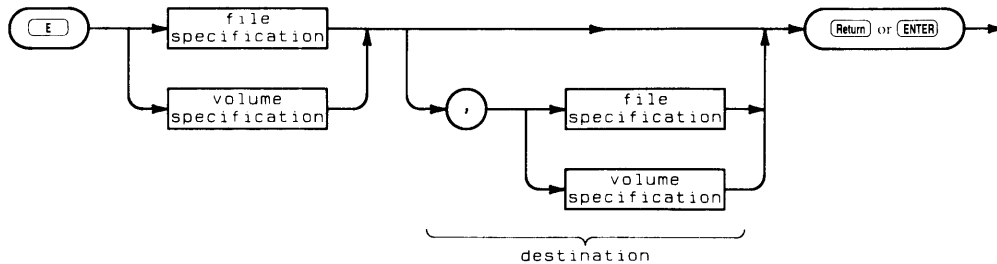

Item	Description/Default	Range Restrictions
file specification	literal	(See the beginning of this section)
volume specification	literal	(See the beginning of this section)

Semantics

The Extended directory prompt:

```
List_ext what directory ?
```

The Extended directory command requires a legal volume ID or a file specification. Results can be listed to the PRINTER: or to a text file if specified and separated from the first specification by a comma. If no destination is specified the listing defaults to the CONSOLE. Wildcards are available to identify subsets of files on the volume.

In the listing, the name of the volume is displayed in the upper left-hand corner. To the right, the directory type is displayed. Pascal discs have Level 1 directories. Level 1 directories contain the creation date and volume size information. Level 0 directories (created on other systems) do not. Your directory listing should display the date the directory was created and the date it was changed as system volume, the size of the storage blocks, and whether the listing is in storage order or alphabetical order. The size of blocks on LIF volumes is 256 bytes. The size of blocks on WS1.0 volumes is 512 bytes. The Shared Resource Management system uses single byte "blocks".

To have directories listed in alphabetical order, include [*] after the directory name. For example:

```
MYDIR:[*]
```

The column entries for each file include: file name, number of blocks used for storage, the file size in bytes, the number of the block where the file starts, the date the file was changed, the type as recognized by the file system, the type-code used by the directory system, SRM access information, the date the file was created and two extension fields.

The SRM access information column comes under the heading “directory info”. It contains codes which show the public access rights:

M	Manager
R	Read
W	Write
S	Search
P	Purgelink
C	Createlink

And the current file status:

```
CLOSED
SHARED
EXCLUSIVE
CORRUPT
```

CLOSED, SHARED and EXCLUSIVE are file status that are associated with SRM systems and are explained in detail in Chapter 2. If a file is ever marked CORRUPT, your Shared Resource Manager has a problem. Stop your operation and notify the person responsible for your SRM. He should restore the SRM to a usable state.)

The last two lines display additional directory information including how many more entries can fit in the directory. The size of a directory is specified when the disc is initialized.

The results can be listed to a printer or a file if you so specify. The destination of the listing is separated from the volume ID or file specification being listed by a comma and, if no destination is specified, the listing defaults to the screen. Wildcards are available to specify groups or subsets of files on a mass storage medium.

For example, assuming that SYSVOL: (the system volume) is in the disc drive associated with logical unit #3, a listing of all the CODE files on that volume could be sent to the printer by specifying any of the following in response to the Extended directory prompt:

```
#3:=CODE,#6: specifies volume residing in unit #3; listing to logical unit #6: (the
PRINTER: volume)

*=CODE,PRINTER: specifies system volume; listing to the PRINTER. Without the colon,
the listing would be sent to a DATA file named “PRINTER” on the
default volume.

SYSVOL:=CODE,#6 specifies SYSVOL: volume; listing to unit #6.
```

In all cases the “=CODE” string refers to all files whose names end in CODE on the specified volume and the listing is sent to the printer.

Listings can also be sent to a file. Use a destination parameter after the the source parameter (separated by a “,”) as in the above PRINTER: example. Give a complete file specification. Use the appropriate suffix in the file name. Otherwise, a file of type DATA is produced. For example:

```
List what directory ? #3:,SYSVOL:LIST.TEXT
```

or

```
List what directory ? #3:,SYSVOL:LIST.ASC
```

Filecopy

The Filecopy command copies a specified file, set of files or volume to the specified destination.

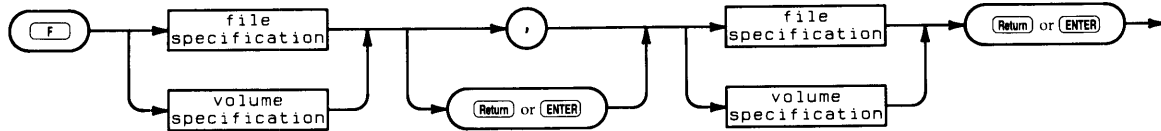

Item	Description/Default	Range Restrictions
file specification	literal	(See the beginning of this section)
volume specification	literal	(See the beginning of this section)

Semantics

The Filecopy prompt:

```
Filecopy what file ?
```

The Filecopy command is initiated by pressing **F** and requires two specifications — a source and a destination separated by either a comma (,) or **Return** or **ENTER**. The source volume must be on-line. The destination volume does not have to be on-line.

Copying Files

When copying files, you will need to enter two file specifications, separated by either a comma or the **Return** key. The first is the existing file, and the second is the name of the duplicate file.

Wildcards may be used to specify sets of files. If the equals (=) wildcard is used, the copy is not confirmed before taking place. Also, note that if the equals wildcard is used alone (i.e., without any qualifying strings) then the Filer copies every file on the specified volume. If the question mark wildcard is used, you are asked to verify the transfer of each file meeting the wildcard specification before the Filecopy takes place. Thus, using the wildcard allows you more flexibility and control over the process.

The dollar sign character (\$) may be used in the destination specification to indicate that the file(s) will have the same name (or names) as the source file(s). For example, assuming that there are a number of TEXT files on the volume TRIG: and that a second volume named MATH: exists,

```
TRIG:=TEXT,MATH:$
```

This results in all the files on the TRIG: volume whose file names end with the string TEXT being copied to the volume MATH: and given the same name as they have on the TRIG: volume.

Be sure to use either a file name or the \$ character when specifying a destination volume. If, in the example above, the destination volume was specified as MATH: instead of MATH:\$, the Filer would respond:

```
Destroy directory of MATH: ?
```

If you respond with Y , the directory of that volume gets overwritten. Pressing N aborts the Filecopy command and returns the Filer prompt.

On a system with a single disc drive, the Filecopy command proceeds by reading the specified file or files into memory, prompting you to remove that volume and insert the destination volume, and then writing the file(s) in memory to the destination volume. Depending on the amount of memory in your computer and the amount of material being copied, you may have to swap discs more than once.

Note

When using the Filecopy command with a single disc drive, wait for the Filer's prompt before removing the source volume and replacing it with the destination volume. Failure to follow this guideline may result in the loss of information from the source volume.

A size specification may be used in the destination description. For example, specifying:

```
SYSVOL:FILE,OTHERVOL:FILE[35]
```

would result in the file being written to the first available area on OTHERVOL: that was at least 35 blocks in size.

Copying BASIC BDAT Files

The Pascal Filer can also copy BDAT (BASIC Data: file type – 5791) files produced by HP BASIC Workstation Systems. When copying BDAT files from one LIF volume to another LIF volume, or from one SRM volume to another SRM volume, an exact duplicate of the file is made just as with Filecopy of other file types. However, the file size changes when BDAT files on LIF volumes are copied to SRM volumes, and vice versa. This change is due to these factors:

- On volumes with LIF directories, BDAT files contain a special “system sector” (256 bytes) which describes the file: logical end-of-file pointer, and number of defined records in the file. This sector is at the *beginning of the data portion* of the file on LIF volumes, because there is not room for the information in LIF directories.
- On volumes with SRM directories, BDAT files also have *some* of this “system” information (only the logical end-of-file pointer). However, it is not in the data portion of the file; instead it is in the parent directory, which has room for the information.

Therefore when using Filecopy to copy a BDAT file from from a LIF to an SRM volume, some of the “system sector” at the beginning of the LIF BDAT file is moved to the SRM directory. The file size, as shown in a Filer directory listing, consequently decreases. Part of this decrease may also be due to the fact that the SRM system keeps track of how many bytes were *actually* written into the file, and only allocates enough sectors for them. (The BASIC system, on the other hand, allocates as many sectors for LIF BDAT files as indicated by the “number of records” and “record size” parameters in the CREATE BDAT statement.)

Also, when using BASIC's CAT statement to list the SRM directory, the number of logical records (“RECS/FILE”) may change due to the fact that BASIC calculates this number by dividing the physical file size by the logical record size (“BYTES/REC”).

Conversely, when using Filecopy to copy BDAT files from SRM to LIF volumes, the logical end-of-file information is moved from the SRM directory to the BDAT "system sector" at the beginning of the data portion of the file. The file size, as shown in a Filer directory listing, may increase due to the movement of this information.

When accessing BDAT files on LIF volumes with a Pascal program, it is important to note that the first sector (256 bytes) of data in the file is the "system sector." You will usually ignore this information (unless your program knows how to use it), using only the data in the second through the last sectors of the file.

Copying Volumes

To make a back-up copy of an entire volume, use the Filecopy command. Simply type in the source volume ID and the destination volume ID. The destination volume must be initialized but does not have to be Zeroed (the directory gets copied from the source volume). The Filer will ask you if you want the directory destroyed. A volume-to-volume copy makes an **exact** copy of the source volume on the destination volume.

Note that having two volumes with the same name on-line at one time is **not** advised. The Filer looks for volumes according to their volume names and may not be able to distinguish one from the other. Thus, the Filer may perform an action on one volume when you wanted the operation to affect the other volume. The Filer warns you whenever this condition exists. If you get a warning, either remove one of the volumes or use the Filer's Change command to change the name of one of the volumes.

You can copy files on one volume to a volume of a different size but you should not use volume IDs alone to do this. If the source volume is larger than the destination volume, the Filer refuses to execute the Filecopy. If the source is smaller than the destination, the destination volume ends up the same size as the source when the operation is through so you lose storage space. Remember? It makes an exact duplicate of the source.

The best way to handle copies between different size volumes is to use one of the wildcards. Use the equals wildcard (=) if the destination is larger than the source and the question mark wildcard (?) if the destination is smaller than the source. In the latter case you have to be selective in your copies since there is not enough space for all of the files.

When the Filecopy command has finished its task, the screen displays what file(s) or volume has been copied and the Filer prompt appears. The Filecopy command can be aborted before all specifications are complete by pressing **(Return)** or **(ENTER)** in response to the prompt.

In cases where the destination volume already contains a file with the same name as the file being copied, this prompt is displayed:

```
ANYVOL:XFILE
exists ... Remove, Overwrite, Neither ? (R/O/N)
```

You have the options:

- **Remove:** remove the file before proceeding with the copy operation.
- **Overwrite:** replace the contents of the old file with the new information. The Overwrite option cannot be used to change the type of a file on SRM. Attempting to do so will result in the file contents being inconsistent with the file type.
- **Neither:** cancel the operation.

The Overwrite option allows you to put a file in the same starting location as the original. This is important to SRM users when duplicate links exist to a file. All links and passwords to the file are accurate when a file is updated because it is put in the same logical location. If you chose the Remove option, the original file would not actually be removed; only your link to it is removed. The other users are still linked to the original file.

Note

Using the Filecopy command to “copy” a file name to the same name on the same volume results in the file being removed.

Note

The Filecopy command does **not** change the file type.

Note

Overwrite of a file of type SYSTM is not recommended because the start execution address cannot be changed in an existing SYSTM file.

Get

The Get command associates a specified file as the current workfile.



Item	Description/Default	Range Restrictions
file specification	literal	(See the beginning of this section)

Semantics

The Get prompt:

```
Get what file ?
```

The Get command is initiated by pressing **G** and prompts you for a file specification. If a workfile currently exists when the Get command is executed, you are asked if you want to release that file before being allowed to specify a new workfile. Upon receiving the specification, the Filer finds the file (or files) and associates that name with the current workfile. Subsequent operations on the workfile use the specified name. The workfile is generally named *WORK.TEXT and/or *WORK.CODE.

The Get operation assumes that the text version of the specified file has a .TEXT suffix. If the text version is ASCII, you must include the .ASC suffix. If the text version is DATA, you must include a "." at the end of the file name (to prevent the appending of the .TEXT suffix).

The operating system notes that either a text or code or both versions of the workfile exist. Workfiles can only be of type TEXT/ASCII/DATA or of type CODE. If both text and code versions of the specified file exist, both are associated with the workfile; if only one exists, the association is made with that file. The Filer reports one of three things: either a text or code file has been loaded, both have been loaded or the file cannot be found on the specified volume.

The Filer is not the only Pascal subsystem where a workfile can be created. The Compiler, Assembler and Editor subsystems also create workfiles. Once a workfile exists, it is treated as the default file in many of the subsystems. A workfile is "released" by the Filer's New command.

Krunch

The Krunch command moves all files on a block structured volume so that all the unused storage space is at the end of the volume.

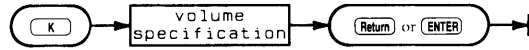

Item	Description/Default	Range Restrictions
volume specification	literal	(See the beginning of this section)

Semantics

The Krunch prompt:

```
Crunch what directory ?
```

If there is the slightest question about the reliability of the medium you are using (because of excessive wear or damage), use the Bad sector command to do a scan of the sector on the volume **before** initiating Krunch. If a bad sector is found, use the Filer's Make command to make a file of type .BAD over the bad sectors. Krunch does not move files of type .BAD. Moving files onto an unreliable area of storage is a good way to lose a file.

The Krunch command is initiated by pressing and it prompts you for a volume ID. After you respond with a legal volume ID of an on-line block structured volume, it prompts:

```
Crunch directory MKWORK: ? (Y/N)
```

Where MKWORK: is whatever volume you specified. Typing for Yes lets the command continue; for No returns the Filer prompt. The Krunch command executes a sensitive operation -- that of moving all the files forward on the disc by reading the files into memory and then writing them back out on the disc in such a manner so as to make all the unused space on the volume contiguous at the end of the disc.

Note

UNDER NO CIRCUMSTANCES SHOULD YOU ATTEMPT TO INTERRUPT THE KRUNCH OPERATION ONCE IT HAS BEGUN. You are risking your directory and thus, all the information contained on that medium if you do so. Do not touch the power switch, the door on the disc drive or attempt to use the keyboard while a Krunch is occurring.

This process becomes necessary when, after repetitive reading and writing to the disc, the available storage space becomes highly fragmented. The situation can exist where you have 100 blocks available on the disc but because they are all in 10 or 15 block chunks, there is not enough contiguous storage space for the system to write a 20 block file to the disc.

The Krunch command is extremely useful and using it should not worry you. However, because it alters the directory (which maps where the information on the disc resides), it is one of the quickest ways to wipe out a volume. The precautions outlined above should help you avoid any problems while using the command.

The Krunch command does nothing on SRM units.

List directory

The List directory command lists directory information about a block structured volume or one of its subsets.

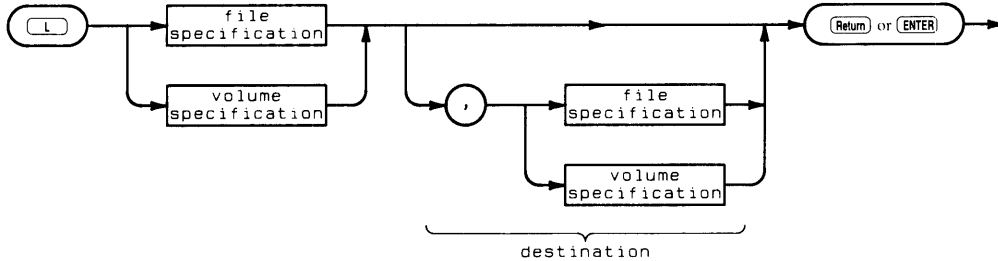

Item	Description/Default	Range Restrictions
file specification	literal	(See the beginning of this section)
volume specification	literal	(See the beginning of this section)

Semantics

The List directory prompt:

```
List what directory ?
```

The List directory command requires a legal volume or file specification. Results can be listed to the PRINTER: or to a text file if specified and separated from the first specification by a comma. If no destination is specified the listing defaults to the CONSOLE. Wildcards are available to identify subsets of files on the volume.

In the listing, the name of the volume is displayed in the upper left-hand corner. To the right, the directory type is displayed. Pascal discs have Level 1 directories. Level 1 directories contain directory-create and volume size information. Level 0 directories (created on other systems) do not. Your directory listing should display the date the directory was created and the date it was changed as system volume, the size of the storage blocks, and whether the listing is in storage order or alphabetical order. The size of blocks on LIF volumes is 256 bytes. The size of blocks on WS1.0 volumes is 512 bytes. The Shared Resource Management system uses single byte "blocks".

To have directories listed in alphabetical order, include [*] after the directory name. For example:

```
MYDIR:[*]
```

The column entries for each file include: file name, number of blocks used for storage, the file size in bytes, and the date the file was created or changed.

The last two lines display additional directory information including how many more entries can fit in the directory. The size of a directory is specified when the disc is initialized. You need one 256 byte block for each eight directory entries.

For example, initiating the command by pressing **L**, specifying ACCESS: and pressing **Return** or **ENTER** results in the following listing appearing on the screen:

```
ACCESS:          Directory type= LIF level 1
created 20-Sep-82 13.57.17 block size=256
Storage order
...file name...  # blks   # bytes  last chng

FILER           218      55808 20-Sep-82
EDITOR          224      57344 20-Sep-82
LIBRARIAN       202      51712 20-Sep-82
MEDIAINIT.CODE 132      33792 20-Sep-82
TAPEBKUP.CODE   54       13824 20-Sep-82
FILES shown=5  allocated=5  unallocated=3
BLOCKS (256 bytes) used=830 unused=223 largest space=223
```

The Extended Directory command gives more information about the files and unused areas on the volume.

Make

The Make command creates files and directories.

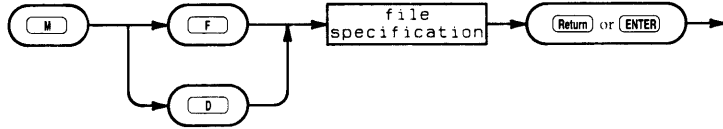

Item	Description/Default	Range Restrictions
file specification	literal	(See the beginning of this section)

Semantics

The Make prompt:

```
Make File or Directory ? (F/D)
```

The Make command is useful primarily in two ways. Files can be made when you need to reserve physical space on a disc, and directories can be made on an SRM system.

The Make command is **not** required to create files to be used by the various Pascal subsystems. It reserves space only; it in no way initializes or changes the contents of the space. In the Pascal System, each subsystem lets you either create or specify any files you need. Users of HP BASIC may quite naturally think that the same function is served by this command as the CREATE command in BASIC (where you must create a file before using it). Thus the distinction between these similar sounding commands is drawn here.

The Make command requires at least a file specification (which includes a volume ID by definition) and accepts an optional size specification. If the (positive integer) size is given, it must follow the file specification on the same line and be enclosed in square brackets. The Filer then creates a file with the specified name and of the specified size on the first area of the volume that has a large enough area of contiguous storage space to meet the size requirements.

When using a size specification to make a file, you must be aware that the size is specified in “number of blocks”. The size of all “Make” blocks is 512 bytes — regardless of the directory type. A LIF directory considers a 256 byte sector to be a block. The WS1.0 directory considers a block to be 512 bytes. So if you make a file on a LIF volume and specify 500 blocks, it will show up in the directory as 1000 blocks.

For example, assume that there is a volume named MKWORK: on-line that has at least 22 blocks of contiguous and unused space available. Press to initiate Make, specifying:

```
MKWORK : DUX , TEXT [ 22 ]  or 
```

This results in a file named DUX.TEXT being created on the first available area with 22 blocks of the volume MKWORK: and the Filer reporting the following:

```
MKWORK:DUX.TEXT made
```

A subsequent listing of the directory (using the List directory or Extended directory commands) will show a file of the same name with a 22 block size (on WS1.0 directories).

The size specification may be omitted in which case the Filer creates the specified file using the largest unused area on the disc (i.e., the largest contiguous storage space on the disc will be allocated to the file). It is recommended that you specify the size you want the file to be.

There are two special cases of size specification worth knowing about. The first is the number zero enclosed in brackets [0] which is the same as omitting the size specification altogether — the Filer uses the largest space available. The second case is the asterisk character enclosed in brackets [*] which tells the Filer to make the file's size either the second largest area on the disc or half of the largest area, whichever is greater.

The Make command is useful if you must rebuild a file that was lost on a disc.

1. You must know its size and where it was located.
2. Then make TEMP files (e.g., TEMP1, TEMP2, etc.) over all the unused spaces on the disc that are as large or larger than the file you'll be making.
3. Then make a file of the proper type over the lost file to recover it.
4. Finally, use the Filer's Remove command to remove all the TEMP files.

An Extended directory listing can help you determine the location and size of unused areas on the disc.

The above technique will not recapture lost files on SRM systems. However, the Make command is used to create directories on an SRM system. For example:

```
Make File or Directory ? (F/D)
```

Answer the first question by typing and specify where you want the directory located and what is its name. The directory path tells where you want it and its name is the name on the end of the path. For example, if you had an SRM directory:

```
#5:USERS/JOE/PROJECT1
```

If you wanted to create a directory for Project 1's DATA files, you should type:

```
#5:USERS/JOE/PROJECT1/DATA
```

The DATA directory is created in the PROJECT1 directory.

New

The New command releases or clears the workfile area.



Semantics

The New command requires no specifications. Upon pressing to initiate the command, it clears the workfile unless the workfile has been updated since the last Save command. If this is the case, the prompt appears:

```
Throw away current workfile? (Y/N)
```

Responding by pressing for No allows you to use the Save command to write the file to a volume; for Yes clears the current workfile area. When the Filer executes the New command, it will respond with:

```
Workfile cleared
```

You can check the status of the workfile before using New with the What command. The What command gives you the name and status (saved or not) of the current workfile.

Do not confuse the Filer's New command with the New system volume command at the Main Command Level — the two commands are different and perform separate functions.

Prefix

The Prefix command changes the default volume to the one specified.

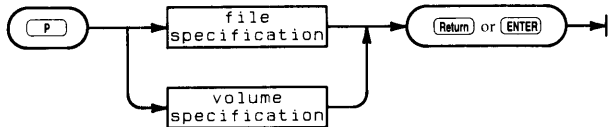

Item	Description/Default	Range Restrictions
file specification	literal	for SRM only (See the beginning of this section)
volume specification	literal	(See the beginning of this section)

Semantics

The Prefix prompt:

```
Prefix to what directory ?
```

The Prefix command is initiated by pressing **P** and requires a volume ID. The command allows you to specify a new default volume — the one where the Filer searches for file specifications when a volume name is not specified. The volume must be block structured (one used for mass storage) but does not have to be on-line. The current prefix (i.e., default) volume can be obtained by responding to the Prefix prompt with a colon (:). (The Volumes command may also be used).

When the command executes, the screen displays the message:

```
Prefix is MKWORK:
```

Where MKWORK: is the name of the current default prefix. The Prefix command saves keystrokes if you are doing a lot of file accessing on a particular volume.

Filer commands which request a volume ID may be answered with the colon character (:) which specifies the current default volume.

It is possible to set the default prefix to a flexible disc drive, regardless of the volume inside. This is done by typing the following while the drive door is open.

```
#3: Return or ENTER
```

The prefix command is used to set up a working directory on a Shared Resource Management system as well. If you had an SRM file named:

```
#5:USERS/JOE/PROJECT1/PROGRAMS/FILE
```

Initiate the Prefix command as usual and specify:

```
#5:USERS/JOE/PROJECT1/PROGRAMS
```

This sets the SRM volume as the default volume (with volume name of PROGRAMS) and USERS/JOE/PROJECT1/PROGRAMS as the working directory on the SRM. Now you can specify the file with:

```
FILE
```

If you were to use the Prefix command again to set the default prefix to another volume (not on the same unit), the working directory and volume name for the unit remain PROGRAMS. You need only specify:

```
#5:FILE
```

or

```
PROGRAMS:FILE
```

Either will get the same file.

Note

Do not use the Prefix command on unit #45. This is the system volume and should not be altered.

It is possible to change the working directory on an SRM unit without changing the default volume. Use the Filer's Unit directory command. Press and then give the directory name that you wish to become the working directory. If the new directory is in the existing working directory, just type the new directory name. If it is not, type the whole directory path as shown above in the Prefix example.

Quit

The Quit command exits the Filer subsystem and returns control to the Main Command Level.

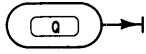

Semantics

The Quit command has no parameters and no specifications of any type are needed. Pressing exits you from the Filer and the Main Command Prompt is displayed on the screen.

Remove

The Remove command purges specified files from the directory.

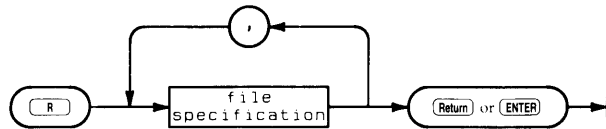

Item	Description/Default	Range Restrictions
file specification	literal	(See the beginning of this section)

Semantics

The Remove prompt:

```
Remove what file ?
```

The Remove command is initiated by pressing and requires a file specification. The command removes the specified file from the directory, updates the directory and reports the action it has performed. Wildcards may be used to specify a subset of files to be removed. If the equals wildcard (=) is used in the file specification, the Filer reports the specified file or files and then prompts:

```
Proceed with remove ? (Y/N)
```

This is the last chance you have to change your mind about the removal. Pressing for No aborts the operation and no files are removed. Pressing for Yes removes those files meeting the wildcard specification from the directory. The process is not always reversible. However, the Make command can sometimes be used to recover a removed file.

Note

The Filer considers the file specification = to specify ALL the files on the default volume and MKWORK: = to specify ALL the files on the MKWORK: volume. If you use the wildcard in this form and respond to the Filer's prompt (Proceed with remove ? (Y/N)) with a for Yes, every file on the directory of the specified volume is removed. Responding with a for No aborts the operation. Wildcards can be hazardous to your files — watch the prompts.

Specifying a single file (of an on-line volume of course) in response to the Remove prompt results in the removal of that file from the directory and a report that the file has been removed. Once the or key is pressed following the file specification (unless wildcards are used), that file is gone.

While the use of the equals wildcard (=) results in being prompted for whether or not you want the directory updated, the question mark wildcard (?) acts slightly differently. It allows you to be more selective in your removal. Given the volume PROCESS: containing the files:

```
NOVMEMO.TEXT  
MARKLTR.TEXT  
PARSER.TEXT  
PARSER.CODE  
GARBAGE.TEXT
```

The specification PROCESS:?TEXT in response to the Remove prompt results in the screen clearing and the following message appearing.

```
Remove NOVMEMO.TEXT ? (Y/N)
```

Answering with either a Y or N results in the next prompt appearing below the first:

```
Remove MARKLTR.TEXT ? (Y/N)
```

The process continues until you have been prompted for all the TEXT files on the PROCESS: volume and then the final prompt appears:

```
Proceed with remove ? (Y/N)
```

You may respond with either a Y (for Yes) or N (for No). The files are not actually removed until this prompt is answered with a Y. The ? wildcard thus allows you to be both selective and relatively safe about your file removals.

The Remove operation treats SRM directories like files if they are empty. Remove is not allowed on non-empty SRM directories.

Save

The Save command saves the current workfile on the specified volume.

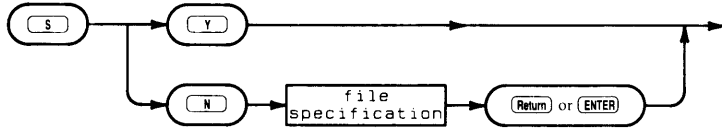

Item	Description/Default	Range Restrictions
file specification	literal	(See the beginning of this section)

Semantics

The Save command is initiated by pressing and may or may not require a file specification. If the workfile was never updated, it is automatically saved with the original name.

If the workfile was previously named using the Save command, or originally obtained using the Get command, then the Filer prompts:

```
Save as PREVIOUS.TEXT ? (Y/N)
```

Where PREVIOUS.TEXT is the name previously associated with the workfile. Responding with a for Yes results in either a CODE or TEXT file (or both, depending on what is in the workfile) of that name being removed and replaced with the current workfile.

If the workfile is not named, or if you answer , the Filer prompts:

```
Save as what file ?
```

When naming the file, the following conventions apply to the type of the file:

1. If a standard suffix is recognized, the workfile is either Filecopied, Translated or Changed (on the system volume) to the file name and type.
2. If no suffix is recognized, a .TEXT file is the default.
3. If no suffix, but a "." is found, the file type is DATA.
4. The .CODE file is created by removing the suffix (if there is one) and adding .CODE to the file name.

The Filer displays that the file is now saved.

To find out what the current name and state (saved or not) of the workfile is, use the What command.

Translate

The Translate command converts text files between the TEXT, ASCII, and DATA formats.

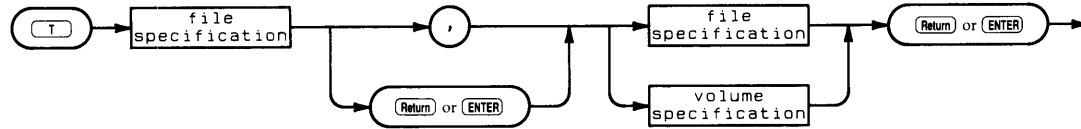

Item	Description/Default	Range Restrictions
file specification	literal	(See the beginning of this section)
volume specification	literal	(See the beginning of this section)

Semantics

The Translate prompt:

```
Translate what file ?
```

The Translate command is initiated by pressing **T** and requires two specifications — a source and a destination separated by either a comma (,) or a carriage return (press **Return** or **ENTER**). The source specification can be any block structured volume, any file or any group of files on a volume. The destination specified can be any of the above and may also be a non-block structured volume (i.e., the **PRINTER:** or **CONSOLE:**). Non-block structured volumes (like the **PRINTER:**) are assumed to be on-line.

Wildcards may be used to specify sets of files but if a wildcard is used in the source specification, either a wildcard or the **\$** character (discussed below) must be included for the destination. If the equals wildcard (=) is used, the translate is not confirmed before taking place. Also, note that if the = wildcard is used alone (i.e., without any qualifying strings such as **LIBR**, **TEXT**, etc.) then the Filer Translates every file on the specified volume. If the question mark wildcard (?) is used, you are asked to verify the translate of each file meeting the wildcard specification before the Translate takes place. Thus, using the ? wildcard allows you more flexibility and control over the process.

The dollar sign character (\$) may be used in the destination specification to indicate that the file(s) will have the same name (or names) as the source file(s). For example, assuming that there are a number of **TEXT** files on the volume **TRIG:** and that a second volume named **MATH:** exists,

```
TRIG:=TEXT,MATH:$
```

This results in all the files on the **TRIG:** volume whose file names end with the string **TEXT** being translated to the volume **MATH:** and given the same name as they have on the **TRIG:** volume.

On a system with a single disc drive, the Translate command proceeds by reading the specified file or files into memory, prompting you to remove that volume and insert the destination volume, and then writing the file(s) in memory to the destination volume. Depending on the amount of memory in your computer and the amount of material being translated, you may have to swap discs more than once.

Note

When using the Translate command with a single disc drive, wait for the Filer's prompt before removing the source volume and replacing it with the destination volume. Failure to follow this guideline may result in the loss of information from the source volume.

The Translate command allows the translating of files or groups of files to non-block structured devices like the `PRINTER :` and `CONSOLE :`. Only text (TEXT, ASCII, DATA) files should be sent to printers since other files are not generally human readable.

When the Translate command has finished its task, the screen displays what file(s) have been translated and the Filer prompt appears. The Translate command can be aborted before all specifications are given by pressing `(Return)` or `(ENTER)`.

In cases where the destination volume already contains a file with the same name as the file being Translated, this prompt is displayed:

```
ANYVOL:XFILE
exists ... Remove, Overwrite, Neither ? (R/O/N)
```

You have the options:

- **Remove:** remove the existing file before proceeding with the translation.
- **Overwrite:** replace the contents of the old file with the new information. The Overwrite option cannot be used to change the type of a file on SRM. Attempting to do so will result in the file contents being inconsistent with the file type.
- **Neither:** cancel the operation.

The Overwrite option allows you to put a file in the same starting location as the original. This is important to SRM users when duplicate links, passwords, etc. exist to a file. All links and passwords to the file are accurate when a file is updated because it is put in the same logical location. If you chose the Remove option, the original file would not actually be removed; only your link to it is removed. The other users are still linked to the original file.

Unit directory

The Unit directory command changes the volume name and working directory for an SRM unit.

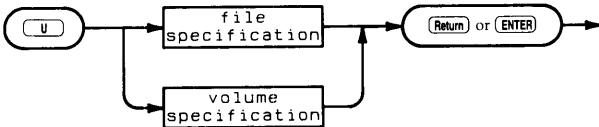

Item	Description/Default	Range Restrictions
file specification	literal	(See the beginning of this section)

Semantics

The Unit directory prompt:

```
Set unit to what directory ?
```

The Unit command changes the working directory on SRM units. The working directory and the volume name for SRM units are the same. The Prefix command performs the same operation but sets the default volume to the SRM volume. The Unit command does not.

To specify the working directory, you must start either from the existing working directory or from the root directory.

To get to the root, an SRM volume identifier must be given or the default is assumed. Follow the volume ID with "/". This positions you in the root directory.

From the working directory, you can continue down the tree structure from directory to directory or you can go back up the structure one directory at a time using “..” for the parent of the current directory.

For example, if the present working directory for unit #5 is:

```
USERS/JOE/PROJECT1/PROGRAMS
```

and you wanted the new working directory to be:

```
USERS/JOE/PROJECT5/DOCUMENTS
```

you can specify it in one of the following ways.

```
#5 : /USERS/JOE/PROJECT5/DOCUMENTS
```

or:

```
PROGRAMS : /USERS/JOE/PROJECT5/DOCUMENTS
```

or:

```
#5 : ../ ../PROJECT5/DOCUMENTS
```

or:

```
PROGRAMS : ../ ../PROJECT5/DOCUMENTS
```

Volumes

The Volumes command lists the volumes currently on-line.



Semantics

The Volumes command requires no specifications. Upon pressing  it displays the following information about all on-line volumes currently associated with the Pascal System: the logical unit number associated with a volume, whether the volume is the system (boot) volume, a block structured volume or a non-block structured volume, the volume's name, and the current Prefix or default volume.

This is a typical display generated by the Volumes command:

```
Volumes on-line:
 1   CONSOLE:
 2   SYSTEM:
 3 #  MINI3:
 4 #  MINI4:
 5 #  MY_SRM:
 6   PRINTER:
45 *  SYSTEM04:
Prefix is - MY_SRM:
```

The number on the far left is the logical unit number associated with the volume. The * character in the second column indicates the system volume which is always block structured. The # character indicates all other block structured volumes currently on-line. The remaining volumes (shown with no character in the second column) are non-block structured. The last line of the display shows the current default volume. It is where the system looks for a file when no volume has been specified.

The above configuration shows two 3.5 or 5.25-inch flexible disc drives associated with units #3 and #4 and two SRM volumes associated with units #5 and #45. Respectively, they are the working volume and system volume.

What

The What command displays the name and state (saved or not) of the workfile.



Semantics

The What command is initiated by pressing `W` and requires no other input. The command shows the name of the current workfile or indicates that it is not associated with a file name. It also shows whether or not the workfile has been saved since the last update to the file. If no workfile exists, the Filer responds with:

```
No workfile
```

Suppose you had two files named `INFRARED.TEXT` and `INFRARED.CODE` on the default or prefix volume. Assume that you used the Filer's Get command and specified `INFRARED` to associate the files with the workfile. If you then edited the `TEXT` version of that file (using the Pascal Editor), returned to the Filer and executed the What command, the screen would display:

```
Workfile is INFRARED (not saved)
```

because the workfile was changed since the last time a Save command was executed.

Saving the workfile does not change the fact that the workfile exists. It is still there. The New command is used to clear the workfile. Saving the workfile is not remembered between separate sessions of the Filer. If you Save the workfile during the current Filer session, a New command immediately clears the workfile. If you Save it, quit the Filer and then return to use the New command, the Filer will ask:

```
Throw away current workfile ? (Y/N)
```

even though you saved it during the previous Filer session and haven't updated it since.

Zero

The Zero command creates an empty directory on the specified volume. The Zero command is not allowed on SRM volumes. (See the Make command.)



Item	Description/Default	Range Restrictions
volume specification	literal	(See the beginning of this section)

Semantics

The Zero prompt:

```
Zero directory (NOT valid on SRM type units)
Zero what directory ?
```

The Zero command is initiated by pressing and requires the volume ID of a block structured volume. The volume must be formatted using the Pascal utility program `MEDIAINIT.CODE` supplied on the `ACCESS:` volume.

Since the Zero command creates a new empty directory on the volume, you will be prompted:

```
Destroy THISVOL: ? (Y/N)
```

Responding with a for No aborts the command and returns the Filer prompt.

If you answer , the next prompt is:

```
Number of directory entries (8) ?
```

The number in the parentheses is the number in the existing directory. Respond with or if that is the number you want. If there is no number in parentheses, or causes the default number for that directory type (80 for LIF; 77 for WS1.0) to be put on the disc.

The next prompt is:

```
Number of bytes (270336) ?
```

It is asking for the logical size of the disc (the extent to be managed by the directory). The number in the parenthesis is the number in the existing directory or the default for that disc. Press or to use the displayed number.

The next prompt is:

```
New volume name ?
```

The Filer is asking for a legal volume name. Volume name formats vary with different directory structures. LIF directories allow up to six characters with upper and lower case characters being distinct. WS1.0 directories allow up to seven characters and all are made upper case.

An answer of or aborts the Zero command.

After typing a volume name, the final prompt appears:

```
NEWSTUF: correct ?
```

Responding with aborts the Zero command. Responding with results in the message:

```
NEWSTUF: zeroed
```

Where `NEWSTUF:` is the name of the new volume. The Filer prompt reappears when the operation is complete.

Note

Because the file system works with volume names, a LIF volume whose name is all blanks (ASCII spaces) will not be recognized as a valid volume.

Pascal Compiler

Chapter

6

Introduction

This chapter describes the Workstation Pascal Compiler, another subsystem of the Workstation Pascal System. It shows how to use the Compiler to prepare Pascal source programs for execution on the Workstation System.

The Workstation Pascal Compiler supports a generous set of Pascal language features. They are briefly described in the “Overview of Workstation Software Features” chapter. Further details of the language features available on this system are referenced in that chapter.

Two slightly different compilers are shipped with the Workstation System:

- `COMPILER` produces object code for all the processors in the MC68000 processor family (because it generates only MC68000 instructions).
- `COMPILE20` produces machine-specific object code for the MC68020 processor (the MC68000 and MC68010 processors cannot execute these instructions).

Preparing a program for execution on this system is a simple process. First, produce source text file(s), usually with the Editor subsystem. Then use one of the two compiler subsystems to generate an output file of relocatable object code. This output file is ready to be linked and run with the Run command – normally there is no explicit link step.

Compilation speed depends on the storage medium where the source and object code reside. Using floppy discs, about 1600 lines per minute (lpm) is typical. If the files are memory-resident, the rate is around 4000 lpm. The Compiler’s speed contributes significantly to the interactive and crisp feeling of the Workstation Pascal environment.

The Compiler, supported by other subsystems, provides complete facilities for the creation, maintenance and use of software libraries. Modules of Pascal code can be compiled, stored in the System Library, and automatically accessed by any program which needs them. Compiled modules carry along a detailed specification of their interface which allows any other program or module to use the code or data structures they declare.

Steps In Program Development

This section will teach you by example the steps required to compile and run a simple program. You need to know how to use the Editor before you can proceed with this material. We begin at the Command level of the system, with no workfile present.

Prepare the Source Program

First we need a program to compile. Enter the following program using the Editor. The Compiler isn't particular about margins, so you can adjust the program to the left margin as you type. Try to preserve the indentation, to keep the program easily readable by mortals.

Notice that the word "end" is intentionally misspelled at the bottom of the program. Type it just as shown, so you can see how errors are handled.

When you leave the Editor (Quit command), you should specify that the output is to be Written to the file "HOWDY". Don't make a workfile (don't use the Update option).

```

Program howdy (input,output);
type
  color = (red,orange,yellow,green);
var
  hue: color;
  i: integer;

  Procedure show (c:color);
begin
  writeln(output,'Howdy! ',c);
  i := i+1;
end;

begin
  writeln(output); i := 0;
  for hue := red to green do
    show(hue);
end.

```

At this point, if you use the Filer to examine the directory of your default volume, you'll see the file "HOWDY.TEXT".

Invoke the Compiler

The Compiler is invoked by typing the **C** key when the system is at the Main Command Level. At the time you booted up, the system looked for the Compiler on all the mass storage volumes which were on-line. If the Compiler was found at that time, it is expected to still be in the same volume whenever it's needed. If the Compiler wasn't found, the system will try to run CMP:COMPILER (or the file specified with the last What command).

So if you press **C** and the system responds that it can't load the Compiler, you must **first** put the CMP: disc in a drive, **then** press **C** again.

It takes a few seconds for the Compiler to load from a floppy disc. Then it will ask you,

```

Compile what text ?

```

If you had to swap discs, you should remove the CMP: disc and put back the default volume. Now respond:

HOWDY or

The Compiler automatically appends the “.TEXT” suffix to the name you give; you need not do so yourself. Next you are asked,

Printer listing (l/y/n/e) ?

If you have no printer, you **must** answer for no listing or for a listing file. If you’ve got a printer, the response gets you a complete listing. Answering will get you a listing only of any errors which are detected. For the moment, let’s answer and get no listing. Finally the Compiler asks:

Output file (default is "HOWDY.CODE") ?

Respond to this by pressing or to accept the default.

As the Compiler runs, you can observe its progress through the source program. Each dot displayed represents five lines of the source text which have been scanned. Whenever the body (the “begin”) of a new procedure is reached, that procedure’s name is displayed on the screen along with an estimate (in square brackets) of how much memory is still available for the Compiler to use. The Compiler reads through an entire procedure body before generating any code; if you write very large procedures, you may notice the stream of dots hesitating momentarily at the ends of some of them.

When the misspelled word “emd” is encountered, the Compiler will beep and display the offending line. You now have three options: press the space bar to continue compiling, hold down and press () to terminate the compilation, or enter the Editor to fix the mistake. You should select “Edit” by pressing .

Note

The Editor must be Permanently loaded, or the volume containing the Editor must be on-line to use the option when exiting the Compiler.

Handling Syntax Errors

If the Compiler is printing a listing, it will report errors on the printout, rather than interactively, giving you an opportunity to edit the program. In this case, you must call the Editor yourself after the compilation is finished.

When the Compiler points out a syntax error, the place it indicates is not necessarily the place where the error occurred; rather, you are shown where the error was first **recognized**. An easy way to get extreme examples of this is to accidentally have unbalanced “begin” and “end” pairs in a deeply nested program. The imbalance may be **syntactically** (though not visually) undetectable until much later in the program. Compilers don’t see what you mean, only what you write.

The error message may not seem reasonable to you. For instance, your misspelled “end” looks to the Compiler like an undeclared identifier which may be the beginning of an assignment statement. The Compiler sees no similarity between “end” and “emd”.

When an error is detected, the Compiler tries to recover by making an assumption about what you meant. Frequently the assumption is wrong, which leads to further errors being reported in the vicinity of the first one. Sometimes the Compiler will try to recover by skipping text until it sees a keyword or other symbol it recognizes.

Back to the example: you elected to edit the program, so the Compiler terminated and the Editor is now invoked. The file containing the offending line is automatically brought in, and the cursor is placed where the error was reported. Simply fix the misspelling and quit the Editor, using the Save option to rewrite the corrected file under its original name, “HOWDY”.

Repeat the steps above to compile HOWDY again. If you have a printer, this time you should ask for a listing. If there are no other accidental errors, the compilation will succeed this time. Your printout should look like this:

```
Pascal [Rev 2.0 10/19/82] HOWDY.TEXT                      19-Oct-82 14:08:32 Page 1

 1:D          0 program howdy (input, output);
 2:D          1 type
 3:D          1   color = (red,orange,yellow,green);
 4:D          1 var
 5:D          -2 1   hue : color;
 6:D          -6 1   i : inteser;
 7:S
 8:D          1   procedure show (c:color);
 9:C          2   begin
10:C          2     writeln(output,'Howdy! ',c);
11:C          2     i := i+1;
12:C          2   end;
13:S
14:C          1 begin
15:C          1   writeln(outPut); i := 0;
16:C          1   for hue := red to green do
17:C          2     show(hue);
18:C          1 end.

No errors. No warnings.
```

Interpreting the Compilation Listing

The column of numbers at the left enumerates the lines. “D” next to the line number indicates the line is a declaration; “S” indicates the line was skipped altogether, either because it’s blank, or because it is entirely within a comment. “C” indicates the line is part of the body of a Pascal block.

The two numbers, -2 and -6, provide information about where the variables “hue” and “color” will be stored in memory. More detailed information about this can be requested by the \$TABLES\$ Compiler option.

The column of numbers immediately to the left of the program text shows how deep structures in the program are nested. This can be very useful when begin's and end's get out of balance. The main program is at level 1, with procedures nesting successively deeper. The structural nesting of complex statements such as for-loops, if's and with's is also counted.

Running the Compiled Program

If you use the Filer to look at the directory of your default volume, you'll see that there are two HOWDY files now: HOWDY.TEXT and HOWDY.CODE . Press the or key. The operating system remembers the name of the most recently compiled file. You'll see the message,

```
Loading 'HOWDY.CODE'
```

The program runs, producing this display on the screen:

```

Command: Compiler Editor Filer Initialize Librarian Run eXecute Version ?
Howdy!  RED
Howdy!  ORANGE
Howdy!  YELLOW
Howdy!  GREEN

```

You can also run the program by using the eXecute command: press the () or the key. Then when asked

```
Execute what file ?
```

answer

```
HOWDY  or 
```

Try it now. Actually, you can eXecute any program, not just the one you most recently compiled. Also, if you use the Run command when you haven't compiled any program, the behavior is as if you used the eXecute command.

Using a Workfile

The Compiler's behavior depends somewhat on whether you are compiling a workfile, or some other source file. If you use a workfile, you are asked fewer questions by the Compiler and Editor; in fact, while the workfile is present you can't compile or edit any other file! This kind of abbreviated behavior may be a blessing or a curse, depending on your needs.

Workfiles are most useful when you're writing a small program and you're in a hurry. In that case you'll appreciate the convenient reduction in keystrokes needed to compile and run the program. On the other hand, experienced programmers developing complex systems with many source files almost never use workfiles.

Workfiles are **not** particularly useful unless the Editor has been permanently loaded, or the volume containing the editor is on-line. This is particularly important in systems which have no external mass storage.

There are two ways to tell the system to use a workfile. You can create one by using the Update option when quitting the Editor; a workfile made this way will always be called WORK.TEXT, and it will be stored in the system volume. Alternatively, you can designate some existing file as the workfile by using the Filer's Get command. The Update option and the Get command are explained in the Editor and Filer chapters of this manual.

Let's make a workfile of HOWDY using the Editor. Press the **E** key, and answer that you want to edit HOWDY. Immediately use the Quit command, and select the option to Update the workfile. This makes a **copy** of your original source file (but not of the code file). Note that the system volume must be on-line at this point, since that is where the workfile is kept.

Now press **R**. If the Compiler isn't on-line, you will need to insert the CMP: or CMP20: disc into a drive first. If you swapped discs, then the Compiler is loaded and will say:

```
Mount *WORK.TEXT and press <space>
```

As you can see, the Compiler knows it's supposed to compile the workfile, and you must put your system volume back in the drive. If the Compiler was already on-line, only one question is asked after you press **R**:

```
Printer listing (l/y/n/e) ?
```

Probably you'll answer no. The program then compiles, producing WORK.CODE, and immediately runs.

To execute it again, just press **R**. It won't be recompiled unless you use change it with the Editor. If you aren't convinced it actually ran again (it happens pretty fast), press the space bar to clear the screen before running it again.

Debugging

The Debugger subsystem is described in detail in a later chapter of this manual.

Note

With Pascal 3.0 and later versions, the Debugger is not automatically loaded when the system is booted. You will need to load it if you want to use it. See the "Debugger" chapter for loading instructions.

Modules

A **module** is a program fragment which can be compiled independently and later used to complete otherwise incomplete programs. For example, you might want to define a “complex number” data type and some relevant functions, then use those definitions in several programs. This section introduces the concepts and facilities you will need to define, debug and use module libraries.

Modules, like almost everything else in Pascal, must have all their relevant features and characteristics declared before use. Diagrams precisely detailing the syntax of a module declaration can be found in the *HP Pascal Language Reference*; an informal presentation is more suitable for present purposes.

Module Structure

The four parts of a module are its heading, the import and export sections, and its implement part.

- The **heading** introduces the module and names it. The name is an ordinary Pascal identifier. Example:

```
module complexmath;
```

- The **import** part names all other modules on which the present one depends. One module depends on another if the dependent module makes use of things exported from the imported one: calling procedures, assigning to exported variables, or declaring variables of an exported type. The names are separated by commas and the list ends with a semicolon:

```
import complexmath, conversions;
```

There is no import part if the module is independent of all others.

- The **export** part defines the constants, types, variables, procedures and functions which this module will supply to any program or module importing it. Constants, types and variables are declared just as in a program or procedure block. Procedures and functions are presented as headings without bodies.

```
export
  const pi = 3.14159;
  type
    polar = record radius, theta: real end;
  var
    scalefactor: real;
    origin: polar;
  function makepolar (a: complex): polar;
  procedure setorigin (a: complex);
```

The export part may make use of things in turn exported from other modules listed in the import part, such as the type “complex”. Every module must have an export part.

- The **implement** part consists of the reserved word **IMPLEMENT**, followed by constant, type, variable, procedure and function declarations, followed by the word **END**. All the procedures and functions whose headings were in the export part must be present in their entirety in the implement part. The implement part may make use of things in turn exported from other modules listed in the import part.

A module does not have to export procedures or functions, it may be used simply to create data types. In such a case there will be nothing between the words **IMPLEMENT** and **END**.

A complete module, “complexmath”, is shown on the next page. It has no import part because it depends on no other modules. (The module is also on the **DOC: disc**; the source is called **CXMODULE.TEXT**.)

The import and export parts are said to define the module’s interface to other modules or programs. This interface is public: the information it contains is available to any imported of the module.

The implement part is said to be “private”, which means that everything between the words **IMPLEMENT** and **END** is hidden from importers. Anything declared here is unknown outside the module, except for procedures and functions whose headings were also included in the export part.

The private and public parts of the module are separated in this way so that its implement part can safely be changed without altering programs or other modules which import it. This independence of modules from programs is a key to developing software libraries. Another implication is that modules can only be dependent on other modules, not on programs. The reason is simply that there’s no way to import a program into a module (since programs have no export declarations).

It was stated at the outset that a module is a “fragment” of a program. To be more precise, a module is a set of global (outer level) declarations which can be compiled once, then bound into a program by an **IMPORT** declaration in that program.

```

1:D      0 module complexmath;
2:D      1 export
3:D      1   type
4:D      1     complex = record
5:D      1       re: real;
6:D      1       im: real;
7:D      1     end;
8:D      1   const
9:D      1     zero = complex [re:0.0,im:0.0];
10:S
11:D     1 function equal (a,b: complex): boolean;
12:D     1 function add   (a,b: complex): complex;
13:D     1 function mul    (a,b: complex): complex;
14:D     1 function dvd    (a,b: complex): complex;
15:D     1 function conj   (a: complex):  complex;
16:D     1 function mag    (a: complex):  real;
17:D     1 function scmul  (scale:real; a:complex): complex;
18:S
19:D     1 implement
20:D     1
21:D    -32 1 function equal (a,b: complex): boolean;
22:C     2   begin equal := (a.re=b.re) and (a.im=b.im) end;
23:S
24:D    -32 1 function add (a,b: complex): complex;
25:C     2   begin add.re := a.re+b.re; add.im := a.im+b.im end;
26:S
27:D    -32 1 function mul (a,b: complex): complex;
28:C     2   begin
29:C     2     mul.re := (a.re*b.re-a.im*b.im);
30:C     2     mul.im := (a.re*b.im+a.im*b.re);
31:C     2   end;
32:S
33:D    -32 1 function dvd (a,b: complex): complex;
34:D    -40 2 var denom: real;
35:C     2   begin
36:C     2     denom := sqrt(b.re)+sqrt(b.im);
37:C     2     if denom = 0.0 then halt(-5); (*divide by zero*)
38:C     2     dvd.re := (b.re*a.re + b.im*a.im) / denom;
39:C     2     dvd.im := (b.re*a.im - b.im*a.re) / denom;
40:C     2   end;
41:S
42:D    -16 1 function conj (a: complex): complex;
43:C     2   begin conj.re := a.re; conj.im := -a.im end;
44:S
45:D    -16 1 function mag (a:complex): real;
46:C     2   begin mag := sqrt(sqrt(a.re)+sqrt(a.im)) end;
47:S
48:D    -24 1 function scmul (scale:real; a:complex): complex;
49:C     2   begin
50:C     2     scmul.re := scale*a.re;
51:C     2     scmul.im := scale*a.im
52:C     2   end;
53:S
54:C     1 end. (*complexmath*)

```

No errors.

Developing and Testing a Module

The Workstation environment supports a structured approach to the development and testing of software modules. This is important because modules often become part of the system library, and many programs may depend on them. The usual steps in the development cycle are:

- Decide what the module will do – define its functionality. Write the interface part first, specifying what other modules will be needed and what things the module will export. Remember that when the finished module is imported into a program, only this interface will be “visible”. Figure out how a program will use the exported things to get the module to do its job.
- Decide how the module will be tested. Write a test program which will thoroughly exercise it.
- Write the implement part of the module. Embed the completed module in the test program, and compile the two together. Leave the module inside the program until you’re satisfied with the results.
- Extract the module from the test program. This can be done by using the Librarian to pull it out of the compiled test program, or by separating the module’s source text with the Editor and compiling it independently.
- Use the compiled module. It can be put in the current system library (which is normally the LIBRARY file), or left as a user library which is manually linked to dependent programs, or loaded into memory by the Permanent load command.

The following listing shows the source of CXMODULE embedded into the program called CX (also on the DOC: disc):

```
Pascal [Rev 2.0 10/19/82] CX0.TEXT                               19-Oct-82 09:15:51 Page 1

 1:D          0 Program cx (listing);
 2:S
 3:D          1 module complexmath;
 4:D          1 export
 5:D          1 type
 6:D          1     complex = record
 7:D          1         re: real;
 8:D          1         im: real;
 9:D          1     end;
10:D          1 const
11:D          1     zero = complex [re:0.0,im:0.0];
12:S
13:D          1 function equal (a,b: complex): boolean;
14:D          1 function add (a,b: complex): complex;
15:D          1 function mul (a,b: complex): complex;
16:D          1 function dvd (a,b: complex): complex;
17:D          1 function conj (a: complex): complex;
18:D          1 function mag (a: complex): real;
19:D          1 function scmul (scale:real; a:complex): complex;
20:S
21:D          1 implement
22:D          1
23:D          -32 1 function equal (a,b: complex): boolean;
24:C          2     begin equal := (a.re=b.re) and (a.im=b.im) end;
25:S
26:D          -32 1 function add (a,b: complex): complex;
27:C          2     begin add.re := a.re+b.re; add.im := a.im+b.im end;
28:S
29:D          -32 1 function mul (a,b: complex): complex;
30:C          2     begin
31:C          2         mul.re := (a.re*b.re-a.im*b.im);
32:C          2         mul.im := (a.re*b.im+a.im*b.re);
33:C          2     end;
34:S
```

Pascal [Rev 2.0 10/19/82] CX0.TEXT

19-Oct-82 09:15:51 Page 1

```

35:D  -32  1  function dvd (a,b: complex): complex;
36:D  -40  2  var denom: real;
37:C   2  begin
38:C   2  denom := sqr(b.re)+sqr(b.im);
39:C   2  if denom = 0.0 then halt(-5); (*divide by zero*)
40:C   2  dvd.re := (b.re*a.re + b.im*a.im) / denom;
41:C   2  dvd.im := (b.re*a.im - b.im*a.re) / denom;
42:C   2  end;
43:S
44:D  -16  1  function conj (a: complex): complex;
45:C   2  begin conj.re := a.re; conj.im := -a.im end;
46:S
47:D  -16  1  function mag (a:complex): real;
48:C   2  begin mag := sqrt(sqr(a.re)+sqr(a.im)) end;
49:S
50:D  -24  1  function scmul (scale:real; a:complex): complex;
51:C   2  begin
52:C   2  scmul.re := scale*a.re;
53:C   2  scmul.im := scale*a.im
54:C   2  end;
55:S
56:C   1  end; (*complexmath*)
57:S
58:S
59:S
60:S
61:D   1  import complexmath;
62:S
63:D   1  const
64:D   1  pi = 3.141592654;
65:D   1  nsteps = 16;
66:D   1  var
67:D  -32  1  a,b: complex;
68:D -304  1  table: array [1..nsteps+1] of complex;
69:D -320  1  theta,thetastep: real;
70:D -324  1  i: integer;
71:D -324  1  listing : text;
72:S
73:C   1  begin
74:C   1  theta := 0.0;
75:C   1  thetastep := pi/(2*nsteps);
76:C   1  a := zero; b := zero;
77:C   1  for i := 1 to nsteps+1 do
78:C   2  begin
79:C   2  a.re := sin(theta); (*leave im part zero*)
80:C   2  b.im := cos(theta); (*leave re part zero*)
81:C   2  table[i] := add(a,b);
82:C   2  theta := theta + thetastep;
83:C   2  end;
84:C   1  writeln(listing,' REAL ',
85:C   1  ' IMAGINARY ',
86:C   1  ' MAGNITUDE ');
87:C   1  for i := 1 to nsteps+1 do
88:C   2  writeln(listing,' ',
89:C   2  table[i].re,' ',table[i].im,' ',
90:C   2  mag(table[i]) );
91:C   1  end.

```

No errors.

REAL	IMAGINARY	MAGNITUDE
0.00000E+000	1.00000E+000	1.00000E+000
9.80171E-002	9.95185E-001	1.00000E+000
1.95090E-001	9.80785E-001	1.00000E+000
2.90285E-001	9.56940E-001	1.00000E+000
3.82683E-001	9.23880E-001	1.00000E+000
4.71397E-001	8.81921E-001	1.00000E+000
5.55570E-001	8.31470E-001	1.00000E+000
6.34393E-001	7.73010E-001	1.00000E+000
7.07107E-001	7.07107E-001	1.00000E+000
7.73010E-001	6.34393E-001	1.00000E+000
8.31470E-001	5.55570E-001	1.00000E+000
8.81921E-001	4.71397E-001	1.00000E+000
9.23880E-001	3.82683E-001	1.00000E+000
9.56940E-001	2.90285E-001	1.00000E+000
9.80785E-001	1.95090E-001	1.00000E+000
9.95185E-001	9.80171E-002	1.00000E+000
1.00000E+000	-2.0510E-010	1.00000E+000

An Illustration

The accompanying listing shows the module “complexmath” embedded in a test program. The test program isn’t very thorough, since it only checks the constant “zero” and the “add” and “mag” functions.

Modules embedded in a program may be intermixed with global constant, type, and variable declarations, but all modules must appear before any of the program’s global procedures and functions. Usually all the modules are put first, followed by the program’s own globals. If there are several modules, they must be ordered so that no module is imported by another (or by the program) until it has been declared.

Notice the semicolon following the END of the module (line 56), and that the program must have an IMPORT declaration (line 61) even though the module is physically present in the program.

Program “cx” can be compiled and run as shown. If you’d like to try it, invoke the Compiler by pressing at the Main Command Level. When asked what text to compile, put the disc labelled DOC: in a drive and answer:

```
DOC : CX 
```

Let the Compiler put the output file on the same disc (accept the default output file).

Compiling a Module Separately

The file generated by compiling CX.TEXT is a library with two modules, the main program “cx” and module “complexmath”. Strictly speaking a program isn’t a module, but within a library it has a directory entry just as if it were. You might wish to use the Librarian and see this for yourself. The Librarian can display every detail of a code file. Had there been several modules in “cx”, each one would have had a separate directory entry.

It’s important to be clear about the distinction between modules and libraries. A library is a file that contains object-code module(s); it is created by the Compiler or Assembler or Librarian. The library’s name is its file name, which you can see with the Filer. Inside the library is a directory naming all the modules in that file. The library directory can only be displayed by the Librarian.

If you were satisfied at this point with the testing of “complexmath”, you could use the Librarian to pull that one module out of the code file, and make it a user library or add it to the system library. The Librarian chapter describes how to do this.

Another alternative is to compile the module separately. Simply use the Editor to create a text file having only the module. Notice that when the module is compiled alone, it must be terminated by a period instead of a semicolon. The Compiler will also accept a sequence of several modules separated by semicolons, as long as the last one is terminated with a period. The program listing on the next page shows the listing generated by a separate compilation.

How the Compiler Finds Library Modules

A module which has been compiled is called a “library module”. Library modules can be imported by programs or other modules, because the compiled code file carries with it a description of the module’s interface. The Compiler is able to read this description and from it determine how to properly access everything exported by the module. (Note that modules which have been “Linked” by the Librarian do not contain the module interface descriptions.)

When the Compiler processes an `IMPORT` declaration, it must find the modules named in the import list and read their interface specifications. A particular search pattern is followed, which is repeated for each module named in the list.

- If the imported module has been previously declared or imported in the source text being compiled, the reference is to that module.
- If no module of that name has been found, the Compiler must search library files on mass storage. The file(s) to be searched may be specified in a `$SEARCH 'FileName' $` option.
- If there is no `$SEARCH$` option or the module is not found in the specified list of files, the Compiler goes on to look in the current system library.
- If the module still isn’t found, error 104 (undeclared identifier) is issued.

Note

The Compiler **does not** search libraries which have been loaded into memory with the P-load command. Module interface specifications are not retained with memory-resident libraries.

A module which is imported may itself import other modules, which are listed in its import section. The Compiler must follow such a chain all the way back to its root, to a module which imports no others. The search pattern just described is applied recursively, to a maximum depth of ten levels. For a restriction, see the subsequent “INCLUDE Files” section. Sometimes in following an import chain, a module is named in more than one import list. The Compiler actually reads the interface specification for a module just once.

If a program imports module “A”, which in turn imports module “B”, the things exported from “B” are nevertheless hidden from the program. To make them visible, “B” must also be imported into the program.

The listing below shows program "cx" recompiled to search for module "complexmath" in a library called "CXMODULE" on mass storage unit #3. The second listing shows "cx" recompiled assuming "complexmath" has been put into the current System Library.

Pascal [Rev 2.0 10/19/82] CX.TEXT

19-Oct-82 09:30:34 Page 1

```

1:D      0 Program cx (listing);
2:S
3:D      1 $search '#3:CXMODULE'$
4:D      1 import complexmath;
5:S
6:D      1 const
7:D      1   pi = 3.141592654;
8:D      1   nsteps = 16;
9:D      1 var
10:D     -32 1   a,b: complex;
11:D     -304 1   table: array [1..nsteps+1] of complex;
12:D     -320 1   theta,thetasteP: real;
13:D     -324 1   i: integer;
14:D     -324 1   listing : text;
15:S
16:C      1 begin
17:C      1   theta := 0.0;
18:C      1   thetasteP := pi/(2*nsteps);
19:C      1   a := zero; b := zero;
20:C      1   for i := 1 to nsteps+1 do
21:C      2     begin
22:C      2       a.re := sin(theta); (*leave im part zero*)
23:C      2       b.im := cos(theta); (*leave re part zero*)
24:C      2       table[i] := add(a,b);
25:C      2       theta := theta + thetasteP;
26:C      2     end;
27:C      1   writeln(listing,'      REAL      ',
28:C      1     '      IMAGINARY ',
29:C      1     '      MAGNITUDE ');
30:C      1   for i := 1 to nsteps+1 do
31:C      2     writeln(listing,' ',
32:C      2     table[i].re,' ',table[i].im,' ',
33:C      2     mag(table[i]) );
34:C      1 end.

```

No errors.

Pascal [Rev 2.0 10/19/82] CX2.TEXT

19-Oct-82 09:06:14 Page 1

```

1:D      0 Program cx (listing);
2:S
3:D      1 import complexmath; (* from systemlibrary *)
4:S
5:D      1 const
6:D      1   pi = 3.141592654;
7:D      1   nsteps = 16;
8:D      1 var
9:D      -32 1   a,b: complex;
10:D     -304 1   table: array [1..nsteps+1] of complex;
11:D     -320 1   theta,thetastep: real;
12:D     -324 1   i: integer;
13:D     -324 1   listing : text;
14:S
15:C      1 begin
16:C      1   theta := 0.0;
17:C      1   thetastep := pi/(2*nsteps);
18:C      1   a := zero; b := zero;
19:C      1   for i := 1 to nsteps+1 do
20:C      2     begin
21:C      2       a.re := sin(theta); (*leave im part zero*)
22:C      2       b.im := cos(theta); (*leave re part zero*)
23:C      2       table[i] := add(a,b);
24:C      2       theta := theta + thetastep;
25:C      2     end;
26:C      1   writeln(listing,'      REAL      ',
27:C      1     '      IMAGINARY ',
28:C      1     '      MAGNITUDE ');
29:C      1   for i := 1 to nsteps+1 do
30:C      2     writeln(listing,' ',
31:C      2     table[i].re,' ',table[i].im,' ',
32:C      2     mas(table[i]) );
33:C      1 end.

```

No errors. No warnings.

How the Loader Finds Library Modules

When the Compiler processes an import declaration, it does not copy, or in any other way bind the library module into the program being compiled. Instead it emits reference information (called REF's) which enables the loader or linker to make the required connections later. Usually REF's are satisfied (hooked up to the library module) at the last possible moment: when you Run the program.

A compiled program contains no record of where the Compiler found any imported modules. The loader has a search pattern it uses to find imported things the program needs:

- First, the file being loaded is searched. There may be modules in it which were compiled at the same time as the program.
- Then memory-resident libraries are searched. The memory-resident libraries are those you have loaded with the P command, the contents of INITLIB (which is automatically loaded at boot time), and the modules of the Operating System itself. The order of search is most-recently-loaded first.
- Finally, the current System Library is searched. If a required module is in the System Library, then it will be loaded with the program and will remain in memory until a different program is executed.
- If there are still unresolved references, the loader reports them on the CRT. The program won't run. Control is returned to the Main Command Level.

If your program only imports from the System Library, everything is taken care of automatically. This is the most common case. If the program imports from user libraries via the \$SEARCH\$ option, you must help out the loader in one of three ways.:

- Use the P-load command to load copies of the libraries into memory before running the program. Do this just once, because the loader does not check to see if modules have already been loaded! Memory-resident libraries stay there until you re-boot.
- Use the Librarian to make a new library containing the compiled program and any modules it needs. This new library is an unlinked, executable program. It will automatically be linked when it is loaded.
- Use the Librarian to link the necessary modules to the program. The resulting library is a linked, executable program. It will probably still have some unresolved references (for instance to the system read and write routines), which will be resolved at load time.

A Subtle Point

The loader doesn't search for modules, it searches for **external names**. Each procedure or function exported has an external name, as do most structured constants. A single name is used for all the variables a module exports; it is actually the name of a place in memory where storage for the variables will be allocated. Certain things, such as types and simple constants, are only useful at compile time and so have no external name.

If two modules which are loaded define the same load-time name, the most recently loaded copy overrides the older one. Generally this makes no difference, because external names created by the Compiler identify the module where the name originated. However, some module names are used by the Operating System. You should avoid using these names from your own modules unless you **intend** to override the name of a system entry point. These names are listed in the Technical Reference Appendix.

\$INCLUDE Files

The source text of a module or program can be broken up into several text files which are edited separately but compiled as a group. The \$INCLUDE option tells the Compiler to insert the Pascal source of another file into the one it is presently compiling.

```

Program showinclude (input,output);
#include 'MYVOL:DECLARS'$
#include 'SYSVOL:BODY'$
end.

```

If the required volume is not on-line when needed, the Compiler pauses and prompts you to insert the proper volume.

Miscellaneous

- An included file may in turn include another file. This “nesting” is allowed to a maximum depth of 10.
- Importing a library module is a form of file inclusion, and counts against the maximum allowable depth of 10 while the import declaration is being processed.
- If the imported module has an import declaration in its own interface, the Compiler will follow the chain and find those module interfaces too. This is another form of nested file inclusion.

What Can Go Wrong?

This section discusses some problems which may occur when using the Compiler, and how to solve them.

Can't Run the Compiler

1. If the system reports, `Cannot open 'CMP:COMPILER'`, the volume with the Compiler is not online. You may have removed the volume and not put it back or changed it with the `What` command. If the Compiler wasn't found when the system booted, you are expected to put the `CMP:` disc (which contains the Compiler) on-line.
2. If the system reports, `Cannot load 'COMPILER'`, either the disc medium is bad, or not enough memory is installed in the Computer to run the Compiler. It is desirable to have at least 393K bytes; the system is normally sold with at least 524K bytes.

Errors 900 thru 908

During compilation, three files are written by the Compiler: the code file, which is the one you want, and the `REF` and `DEF` files. The latter two are temporary working storage for linkage information which is appended to the code file if the compilation terminates normally. All three of these files are normally opened on the same volume (the volume to which you directed the code file).

Each of these files is subject to three classes of error:

- Error in opening the file.
- Insufficient space to open the file.
- File fills up before compilation finishes.

An error in opening the file usually means the volume is not online. It can also indicate that the volume's directory is full.

The amount of space allocated to the code file is usually half of the largest free area on the volume, with the potential to expand to the second half of that area if needed. If you get errors 900, 903, or 906 you need to make more room on the volume to which the code file was directed, or use a different volume.

The `REF` file by default is opened with 30 blocks of disk space on the same volume as the code file. A Compiler option at the beginning of the source program can change the size and the volume selected for `REF`. There's no simple rule which gives the "right" size for the `REF` file. If the file fills up (error 907), make it bigger in proportion to the amount of program that remained to compile when the error occurred.

<code>\$REF 50\$</code>	Allocate 50 blocks
<code>\$REF 'CHARLIE:'\$</code>	Put it on volume CHARLIE
<code>\$REF 'CHARLIE:', REF 50\$</code>	Put it on CHARLIE and allocate 50 blocks

Exactly analogous remarks hold for the DEF file, except that its default size is 10 blocks and the Compiler option is \$DEF\$.

Errors When Importing Library Modules

1. Syntax errors in the interface of an imported library module. This usually indicates that the library module itself tried to import some other module which was not found by the Compiler's search algorithm.
2. Errors 608, 610: Include or import nesting too deep. If module "A" imports "B", which imports "C" and so forth, the Compiler must follow the chain to its end. The chain can only be 10 imports deep. Since the same file handling mechanism is also used to process \$INCLUDEd files, the combined limit on import and inclusion nesting is 10 deep.
3. Error 613: Imported module does not have interface text. If the library has been linked by the Librarian, the interface specification has been removed. Also, a main program looks internally like a module; but it has no interface text.

Not Enough Memory

If the Compiler generates error -2 (not enough memory), then there isn't enough room in memory to compile the program. You can watch the numbers which appear on the screen in square brackets as the compilation proceeds - they show approximately how much memory is left. There are two primary reasons for running out of memory during a compilation: one of them is large procedure bodies, and the other is P-loaded files.

Large Procedure Bodies

When the Compiler processes a procedure, the entire procedure (declarations and body) is scanned. An internal representation of the procedure, called a "tree", is built. This tree is not complete until the scanner reaches the end of the procedure, and only then does code generation begin. The tree form takes a lot of storage, particularly the statements making up the body. If you write a procedure whose body is ten pages long, the Compiler is very likely to run out of memory. The moral is that you should keep your procedures reasonably short. A good guideline is that no procedure should be longer than a page or two.

P-loaded Files

If you've Permanent-loaded a lot of libraries or programs, or space has been allocated to a memory-resident mass storage volume, you can reboot the system to recover the memory, and try again.

Insufficient Space for Global Variables

You may discover, either at compile time or at run time, that there isn't sufficient space for the global variables of your program. If this happens, please refer to "Implementation Restrictions" in this chapter, which explains the limitations and what to do if you exceed them.

Errors 403 thru 409

These errors should never be reported. They indicate a malfunction in the Compiler itself. If this ever happens, please show the program which causes it to your HP field support contact.

Compiler Options

Compiler options affect the code emitted by the Compiler. For instance, the `$DEBUG ON$` option causes the Compiler to emit a TRAP instruction after the object code for each Pascal statement, allowing you to single-step the program.

Sometimes there are restrictions on where an option may appear:

Location	Restrictions
Anywhere	Indicates that the location of the option in the file is irrelevant.
At front	Applies to entire source file; must appear before the first “token” in the source file (before PROGRAM, or before MODULE if compiling a list of modules).
Not in body	Applies to a whole procedure or function; can’t appear between BEGIN and END. Good practice to put these options immediately before the word BEGIN or the procedure heading.
Statement	Can be applied on a statement-by-statement basis or to a group of statements, by enabling before and disabling after the statement(s) of interest.
Special	As explained under the particular option.

If an option appears in the interface (import or export) part of a module, it will have effect as the module is compiled. However, the option itself will not become part of the interface specification in the compiled module’s object code.

ALIAS

Default: External name = Procedure Name

Location: Special, See Below

This Compiler option causes a name, other than the name used in the Pascal procedure or function declaration, to be used by the loader.

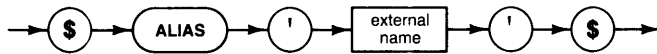

Item	Description/Default	Range Restrictions
external name	string	1 to 80 ASCII Characters

Semantics

The string parameter specifies the external name for the procedure in whose header the option appears.

Example:

```
PROCEDURE $alias 'charlie'$ P (i: integer); external;
```

Within the program, calls use the name "p"; but the loader will link to a physical routine called "charlie".

Should appear between the keywords PROCEDURE or FUNCTION and the routine's identifier.

ALLOW_PACKED

Default: OFF

Location: Anywhere

This option permits or prohibits the passing of elements of packed arrays or records to `var` parameters.

Semantics

“ALLOW_PACKED” is interpreted as “ALLOW_PACKED ON”.

Passing elements of packed arrays or records to `VAR` parameters is illegal in HP Standard Pascal, but the Workstation Pascal Compilers prior to Version 3.1 allowed it. Pascal 3.1 and subsequent compilers allow passing of packed elements to `var` parameters *only* if the compiler option `ALLOW_PACKED` is ON.

ON specifies that elements of packed structures will be allowed to be passed to `var` parameters in functions and procedures. You may need to add the option `$ALLOW_PACKED ON$` and recompile existing pre-3.1 Pascal source code to run it on the 3.1 system.

OFF specifies that passing elements of packed structures to `var` parameters is illegal. Attempts to do so result in a compile-time error message 154: “Illegal argument to match pass-by-reference parameter”.

Note

Pre-3.1 compilers allowed only certain packed elements to be passed to `var` parameters. These are the elements which `ALLOW_PACKED` affects. Others, which pre-3.1 compilers forbade from being passed, are still forbidden in 3.1 and later compilers.

ANSI

Default: OFF
Location: At Front

This Compiler option selects whether an error message is to be emitted for use of any feature of HP Standard Pascal not contained in ANSI/ISO Standard Pascal.

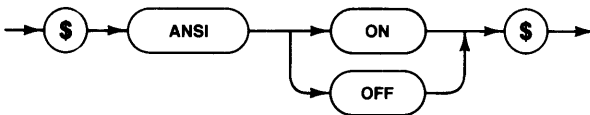

Semantics

“ANSI” is interpreted as “ANSI ON”.

ON causes error messages to be issued for use of any feature of HP Standard Pascal which is not part of ANSI/ISO Standard Pascal.

OFF suppresses the error messages.

Example:

```
$ansi on$
```

CALLABS

Default: ON
Location: Statement

This Compiler option determines whether 16-bit relative or 32-bit absolute jumps are to be generated by the Compiler.

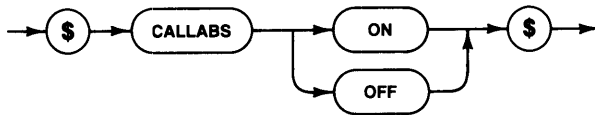

Semantics

“CALLABS” is interpreted as “CALLABS ON”.

ON specifies that 32-bit absolute jumps will be emitted for all forward and external procedure calls.

OFF specifies 16-bit PC-relative jumps.

Allowed on a statement-by-statement basis.

Example:

```
$callabs off$
```

CODE

Default: ON
Location: Not in Body

This Compiler option is used to control whether a CODE file will be generated by the Compiler.

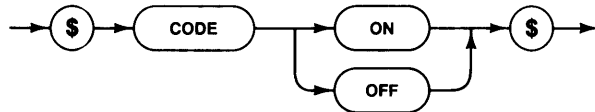

Semantics

“CODE” is interpreted as “CODE ON”.

ON specifies that a code file will be generated.

Example:

```
$code off$
```

CODE_OFFSETS

Default: OFF

Location: Not in Body

This Compiler option controls the inclusion of program counter offsets in the compiler listing.

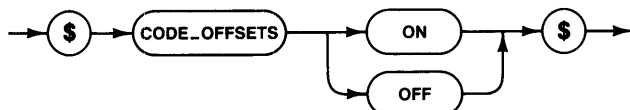

Semantics

“CODE_OFFSETS” is interpreted as “CODE_OFFSETS ON”.

ON specifies that line-number/program-counter pairs will be printed for each executable statement listed. This can be applied on a procedure-by-procedure basis.

COPYRIGHT

Default: Not Applicable
 Location: Anywhere

This Compiler option is provided for inclusion of copyright information.



Item	Description/Default	Range Restrictions
copyright message	string	1 to 80 ASCII Characters

Semantics

The string parameter is placed in the object file as the owner of the copyright. If more than one COPYRIGHT option is included, the last one is effective.

Example:

```
$copyright 'Hewlett Packard Company, 1981'$
```

DEBUG

Default: OFF
 Location: Not in Body

This Compiler option controls whether the code produced by the Compiler contains the additional information necessary for full use of the Debugger system.

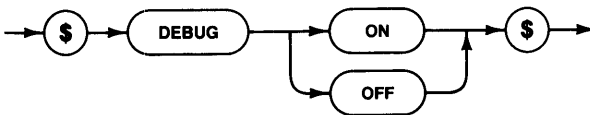

Semantics

“DEBUG” is interpreted as “DEBUG ON”

“DEBUG ON” will cause debugging instructions to be emitted for the procedure bodies following it. May be applied on a procedure-by-procedure basis.

Example:

```

procedure buggy;
var i: integer;
$debug on$
begin
  ...
end;
$debug off$

```

DEF

Default: 10 records on same volume as code output
 Location: At Front

This Compiler option allows the user to change the size and location of the temporary Compiler file named “.DEF”.

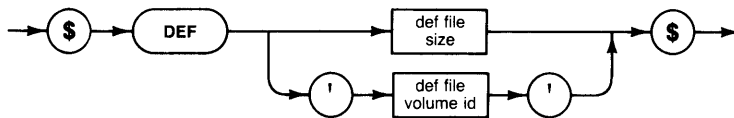

Item	Description/Default	Range Restrictions
def file size	integer constant	less than 32767
def file volume id	string	valid volume id (see glossary)

Semantics

If the parameter is a string, it specifies the volume where a temporary Compiler file called “.DEF”, which holds external definitions, will be stored. If the parameter is a number, it specifies how many logical records will be allocated for the DEF file. See “What Can Go Wrong, Errors 900 to 908”.

Examples:

```
$def 50$
$def 'junkvol:'$
$def 'junkvol:', def 50$
```

FLOAT_HDW

Default: OFF
Location: Not in body

This option enables and disables the use of floating-point hardware.

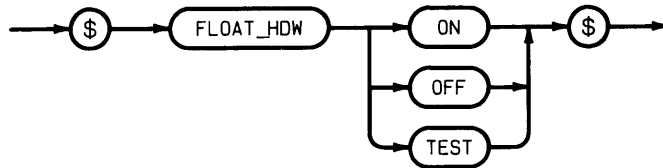

Semantics

HP 98635 Floating-point Math Card

The HP 98635 is an optional PC board that increases the execution speed of floating-point math computations. This board can be installed in all Series 200 computers.

- ON instructs COMPILER to generate accesses to 98635 hardware for the floating-point operations listed below. If the hardware is not installed when the program is executed, an error will be reported.
- OFF tells COMPILER to generate math library calls for floating-point operations.
- TEST causes COMPILER to generate both hardware accesses and library calls. The code includes tests for the presence of floating-point hardware. If the test succeeds (at execution time), the hardware accesses are used; otherwise, the library calls are used.

Operations that can potentially use the 98635 floating-point card include: addition, subtraction, multiplication, division, negation, and the `sqrt` function. Hardware can also be used by any operation that converts an integer into a real or longreal; however, hardware is not used by operations that convert reals or longreals into integers. All other math functions call library routines. There are also libraries that access the floating-point hardware.

MC68881 Floating-point Math Co-processor

When using this option with the COMPILER20 compiler on Series 300 computers equipped with the optional MC68881 math co-processor, this Compiler option has slightly different meaning.

- ON causes COMPILER20 to generate MC68881 co-processor instructions.
- OFF causes COMPILER20 to generate code that uses Pascal math libraries.
- TEST is not allowed (COMPILER20 reports an error).

Operations that can potentially use the 68881 hardware include all floating-point math computations except `trunc`.

HEAP_DISPOSE

Default: OFF
Location: At Front

This Compiler option enables and disables “garbage collection” in the heap.

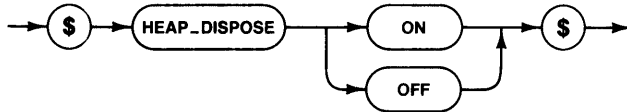

Semantics

“HEAP_DISPOSE” is interpreted as “HEAP_DISPOSE ON”

ON indicates that DISPOSE allows disposed objects to be reused.

OFF does not recycle disposed objects. If enabled, this option must appear at the front of the **main program**.

Example:

```

$heap_dispose on$
Program recycle;
...
begin
  dispose(P); (*free up cell*)
  new(P);     (*probably gets same cell back*)
end.
  
```

The HEAP_DISPOSE option must be the same (either ON or OFF) in the program and **all** modules imported by the program. Erroneous results may occur if those declarations don’t agree, because there is no way for the Compiler to check on which option other modules have used.

IF

Default: Not Applicable
Location: Anywhere

This Compiler option allows conditional compilation.

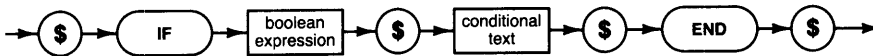

Item	Description/Default	Restrictions
boolean expression	expression that evaluates to either TRUE or FALSE	may only contain compile time constants
conditional text	source to be conditionally compiled	

If the expression evaluates to FALSE, then text following the option is skipped up to the next \$END\$ option.

If the boolean expression evaluates to TRUE, then the text following the option is compiled normally.

IF-END option blocks may not be nested.

String constants may not be used.

Example:

```

const fancy = true;
      limit = 10;
      size = 9;

...
$if fancy and ((size+1)<limit)$
  ... (* this will be skipped *)
$end$
...
$if FALSE$
  ...(* this will also be skipped*)
$end$

```

INCLUDE

Default: Not Applicable

Location: Anywhere

This Compiler option allows text from another file to be included in the compilation process.



Item	Description/Default	Range Restrictions
file specifier	string	any valid file specifier (see Glossary)

The string parameter names a file which contains Pascal source to be included at the current position in the program. Included code may contain additional INCLUDE options (nesting level is 10). The remainder of the line which contains this option must be blank except for the closing \$.

Example:

```

Program inclusive;
#include 'source:declars'$
#include 'source:body'$
end.

```

IOCHECK

Default: ON
Location: Statement

This Compiler option enables and disables error checking following calls to system I/O routines.

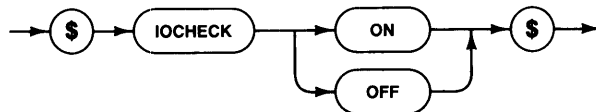

Semantics

“IOCHECK” is interpreted as “IOCHECK ON”

ON specifies that error checks will be emitted following calls on system I/O routines such as RESET, REWRITE, READ, WRITE. Can be used in conjunction with the standard function IORESULT if UCSD or SYSPROG language features have been enabled. Allowed on a statement-by-statement basis.

OFF specifies that no error will be reported in case of failure.

Example:

```

$ucsd$
...
$iocheck off$
reset(f,'datafile');
$iocheck on$
if iorresult <> 0 then writeln('IO error');
  
```

LINENUM

Default: Not Applicable
Location: Anywhere

This Compiler option allows the user to establish an arbitrary line number value.

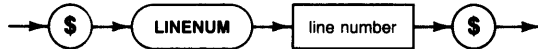

Item	Description/Default	Range Restrictions
line number	integer numeric constant	0..65535

Semantics

The integer parameter becomes the current line number (for listing and debugging purposes).

Example:

```
$linenum 20000$
```

LINES

Default: 60 lines per page

Location: Anywhere

This Compiler option allows the user to specify the number of lines-per-page on the Compiler listing. 2000000 lines-per-page suppresses autopagination.

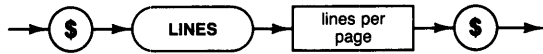

Item	Description/Default	Range Restrictions
lines per page	integer numeric constant	20 thru MAXINT

Example:

```
$lines 55$
```

```
$lines 2000000$ (*suppress autopagination*)
```

LIST

Default: ON to PRINTER:
Location: Anywhere

This Compiler option controls whether or not a listing is being generated, and to where it will be directed.

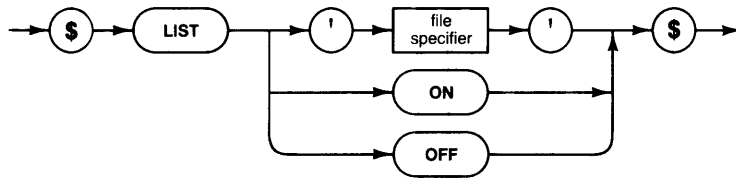

Item	Description/Default	Range Restrictions
file specifier	string	any valid file specifier (see glossary)

Semantics

“LIST” is interpreted as “LIST ON”.

LIST with a file specifier specifies that the file is to receive the compilation listing.

LIST OFF suppresses listing.

LIST ON resumes listing. No listing will be produced at all, regardless of this option, unless requested by the operator when the Compiler is invoked.

Examples:

```
$list 'myvol:keepList.text'$
$list 'printer:'$
$list off$
```

OVFLCHECK

Default: ON

Location: Statement-by-statement

This Compiler option gives the user some control over overflow checks on arithmetic operations.

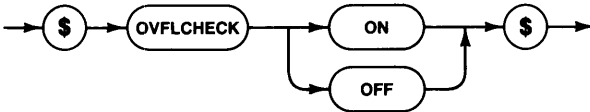

Semantics

“OVFLCHECK” is interpreted as “OVFLCHECK ON”

ON specifies that overflow checks will be emitted for all in-line arithmetic operations.

OFF does not suppress all checks; they will still be made for 32-bit integer DIV, MOD, and multiplication.

Example:

```
$ovflcheck off$
```

PAGE

Default: Not Applicable
Location: Anywhere

This Compiler option causes a formfeed to be sent to the listing file if compilation listing is enabled.



Example:

`$ P a g e $`

PAGEWIDTH

Default: 120

Location: Anywhere

This Compiler option allows the user to specify the width of the compilation listing.

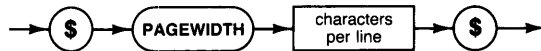

Item	Description/Default	Range Restrictions
characters per line	integer numeric constant	80 thru 132

Semantics

The integer parameter specifies the number of characters in a printer line.

Example:

```
$pagewidth 80$
```

PARTIAL_EVAL

Default: OFF
Location: Statement-by-statement

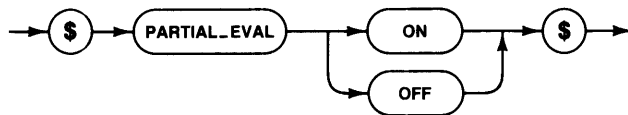

Semantics

“PARTIAL_EVAL” is interpreted as “PARTIAL_EVAL ON”.

ON suppresses the evaluation of the right operand of the AND operator when the left operand is FALSE. The right operand will not be evaluated for OR if the left operand is TRUE.

OFF causes all operands in logical operations to be evaluated regardless of the condition of any other operands.

Example:

```
$Partial_eval on$
while (P<>nil) and (P^.count>0) do
  P := P^.link;
```

RANGE

Default: ON

Location: Statement-by-statement

This Compiler option enables and disables run-time-checks for range errors.

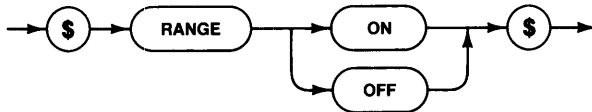

Semantics

“RANGE” is interpreted as “RANGE ON”.

ON specifies that run time checks will be emitted for array and case indexing, subrange assignment, and pointer dereferencing.

Example:

```

var a: array[1..10] of integer;
    i: integer;
...
i := 11;
$range off$
a[i] := 0; (* invalid index not caught! *)
  
```

REF

Default: 30 records on same volume as code output
 Location: At Front

This Compiler option allows the user to change the size and location of the temporary Compiler file named “.REF”.

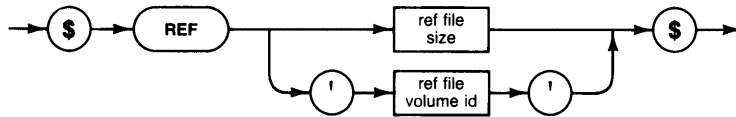

Item	Description/Default	Range Restrictions
ref file size	integer numeric constant	less than 32767
ref file volume id	string	valid volume id (see glossary)

Semantics

If the parameter is a string, it specifies the volume where a temporary Compiler file called “.REF”, which holds external references, will be stored. If the parameter is a number, it specifies how many logical records will be allocated for the REF file. See “What Can Go Wrong, Errors 900 to 908”.

Examples:

```
$ref 20$
$ref 'JUNKVOL:'$
$ref 'JUNKVOL:', ref 50$
```

SAVE_CONST

Default: ON

Location: Anywhere

This Compiler option controls whether the name of a structured constant may be used by other structured constants.

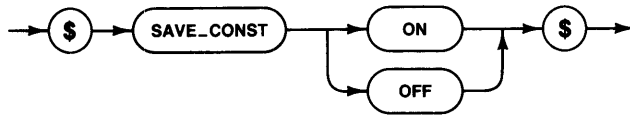

Semantics

“SAVE_CONST” is interpreted as “SAVE_CONST ON”.

ON specifies that compile-time storage for the value of each structured constant will be retained for the scope of the constant’s name (so that other structured constants may use the name).

OFF specifies that storage will be deallocated after code is generated for the structured constant.

Example:

```

$save_const off$
type ary = array [1..100] of integer;
const acon = ary [345,45691, .....];
    (*big constants take lots of compile-time
    memory*)
  
```

SEARCH

Default: Not Applicable
Location: Anywhere

This Compiler option is used to specify files to be used to satisfy IMPORT declarations.

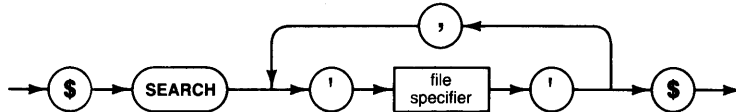

Item	Description/Default	Range Restrictions
file specifier	string	any valid file specifier (see Glossary)

Semantics

Each string specifies a file which may be used to satisfy IMPORT declarations. Files will be searched in the order given. The current system library is always searched last. A maximum of 9 files may be listed.

Multiple SEARCH options are allowed; for instance, you may want to use one for each import declaration. Note that only the last one encountered during compilation will be in effect for any import statement (i.e., these options are not cumulative).

Example:

```
$search 'FIRSTFILE', 'SECONDFILE' $
```

SEARCH_SIZE

Default: 10 files
Location: At front

This Compiler option allows you to increase the number of external files you may SEARCH during a module's compilation.



Item	Description/Default	Range Restrictions
number of files	integer numeric constant	less than 32767

Semantics

When compiling a Pascal module, it is sometimes desirable to import another module from another file. To import a module from another file, the SEARCH option is used to identify the file. Up to ten SEARCH options may be given unless the SEARCH_SIZE options is given. The SEARCH_SIZE option allows you to SEARCH up to 32,766 external files for imported modules.

Example:

```
#search_size 30#
```

STACKCHECK

Default: ON
Location: Not in Body

This Compiler option enables and disables stack overflow checks.

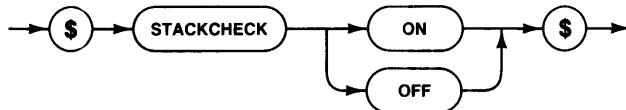

Semantics

“STACKCHECK” is interpreted as “STACKCHECK ON”.

ON specifies that stack overflow checks will be generated at procedure entry. It is very dangerous to turn overflow checks off! Obscure and unreported errors may result.

Example:

```

$stackcheck off$
procedure unsafe;
var
  may_smash_heap: array [1..500] of integer;
begin ... end;
  
```

SWITCH_STRPOS

Default: Off
Location: At front

This Compiler option reverses the positions of the parameters of the STRPOS function.

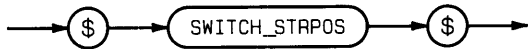

Semantics

When this Compiler option is used, the expected order of the parameters is that of the HP standard. In Series 200 Pascal (like UCSD's POS function), the STRPOS function expects the first string parameter to be the search pattern and the second string parameter to be the source string in which the search takes place. Later the HP standard was established with the order of the parameters reversed. If \$WARN OFF\$ is not in effect, then the Compiler issues a harmless warning that you are not conforming to the standard. If you wish to conform to the standard, give the SWITCH_STRPOS option in your program.

Example:

```
$switch_strpos$
```

TABLES

Default: OFF

Location: Not in Body

This Compiler option allows the user to turn on and off the listing of symbol tables.

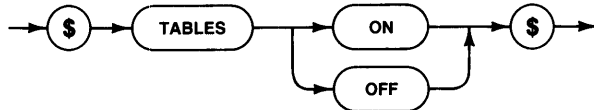

Semantics

“TABLES” is interpreted as “TABLES ON”

ON specifies that symbol table information will be printed following the listing of each procedure. This is useful for very low-level debugging.

Example:

```
$tables$  
procedure hasabug (var P: integer);  
var  
...
```

UCSD

Default: UCSD not enabled
Location: At Front

This Compiler option allows the compiler to accept most UCSD Pascal language extensions. See the subsequent “Converting UCSD Pascal” section later in this chapter.



Example:

```
$ucsd$  
PROGRAM funnyio;  
VAR  
  f: file; (* no type specified! *)  
BEGIN  
  unitread(B,ary,80,10);  
END.
```

WARN

Default: ON
Location: At Front

This option allows the user to suppress the generation of compiler warning messages.

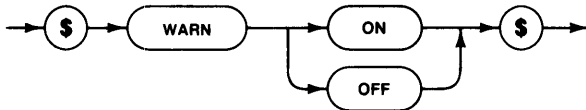

Semantics

“Warn” is interpreted as “WARN ON” and compiler warnings will be issued.

Example

```
$warn off$
```

How Pascal Programs Use the Stack

This section describes how Pascal programs use the stack to store data, return addresses for procedures, and pointers needed to access variables belonging to nested procedures. The information can be useful when writing assembly language routines, and when debugging at the machine level.

You can also investigate this subject by writing some Pascal test programs and then looking at the emitted code with the Librarian's Unassemble command. Two Compiler options also produce valuable information: \$DEBUG ON\$ correlates the machine code displayed by Unassemble with the original Pascal lines, and \$TABLES\$ causes the Compiler to print a description of the size and location of each object in the program.

The Pascal Stack

Five types of data can be stored on the stack:

- procedure/function parameters
- return addresses
- local variables
- stack frame pointers
- static links

Two address registers are reserved for stack manipulations:

- A7 - the stack pointer (SP)
- A6 - the stack frame pointer (SF)

The stack grows downward in memory as procedures are called, with A7 always pointing to the base (beginning, lowest address) of the datum on the “top” of the stack. That is, when space is allocated for a procedure which has been called, the area allocated has a lower (more negative) address than the space already allocated for the calling procedure. Space allocated to a procedure is called its **stack frame**.

However, variables extend upward in memory. This simply means that the address of the first element of an array, or the first field of a record, is lower than the address of the second element or field.

Global Variables

Register A5 is reserved as the global base register. A reference to any program or module global variable is always formulated as a displacement from where register A5 points. The maximum size of the global area is 65 536 bytes (the displacement field size). In practice, not all of this space is available to the program. Some of this area is used for system globals, command interpreter globals, permanently loaded programs and modules, and so forth.

See the Assembler chapter for details on how to reference Pascal global variables from assembly language programs.

Procedure Calls

When one procedure calls another, the caller pushes any parameters to the called procedure on the stack. The parameters are pushed on the stack by first decrementing the stack pointer (A7) an amount equal to the size of the parameter, then storing the parameter where SP now points. (Pushing a byte decrements the stack pointer by two, since it must always have an even value.) The calling procedure executes a JSR instruction which pushes the return address on the stack and jumps to the entry point of the called procedure.

The first instruction executed by the called procedure is a LINK instruction. The LINK instruction format and function is illustrated below:

format:	LINK A6,# -d	
function:	A6 → -(SP)	—push the stack frame pointer onto the stack
	SP → A6	—set the stack frame pointer equal to the stack pointer
	SP-d → SP	—drop the stack by the size(d) of the local variables for the called procedure

If the program is compiled with \$STACKCHECK ON\$ (which is the default), a TRAP instruction is issued instead of LINK. The trap service routine checks for stack overflow as it adjusts A6 and SP. In this case the size #d is stored in the next word after the TRAP instruction.

The stack frame pointer (A6) is used by the called procedure to reference its local variables. See Figure 6 for an illustration of stack usage for level 1 procedure calls. Level 1 procedures are those declared at the global level of a program or module.

If the called procedure is not at level 1, the calling procedure pushes a pointer to the stack frame of the procedure in which the **called** procedure is declared. This pointer is called the **static link**. It is used by the called procedure to resolve references to intermediate variables -- variables which are neither local to the called procedure, nor globals of the program.

An example might help to clarify the static link. Consider the following program structure (indentation indicates nesting):

```

Program main
  Procedure P1
    Procedure P2
      Procedure P3
        Procedure P4

```

Assume this calling sequence: main calls p1, calls p2, calls p4. If p4 calls p3 then the static link pushed would be that of procedure p2 (since p4 is declared within p2). If instead p4 were to call p2 then the static link would point to p1 (p2 is nested within p1). See Figure 7 for a detailed example of static links.

The called procedure is responsible for stack cleanup and for effecting the return to the calling procedure. Any parameters, local data, or static links belonging to the called procedure must be removed from the stack before returning to the caller. Once this is complete a return to the calling procedure can be performed.

The stack cleanup is performed in two steps:

Step 1: Restore the stack frame pointer. Use the UNLK instruction to remove local data from the stack.

format:	UNLK A6	
function:	A6 → SP	—set the stack equal to the stack frame pointer
	(SP) + → A6	—load the stack frame pointer from the stack and autoincrement the stack pointer (this leaves the stack pointer pointing to the return address)

Step 2: Restore the stack pointer. This removes the static link and parameters from the stack. After this step, the stack pointer should be as it was before the procedure call.

The called procedure returns to the caller by branching to the return address. If the return address was saved in an address register during stack cleanup then an indirect JMP through the address register is executed. If the return address was left on the stack then an RTS instruction is executed.

format:	RTS	
function:	(SP) + → PC	—set the program counter to the value pointed to by the stack pointer and pop the value off the stack

See Figure 8 for an example of a return from a called procedure.

Function Calls

Function calls differ from procedure calls only in that they return results. The result is usually returned on the stack. It is the responsibility of the calling procedure or function to pop the result off of the stack. This is normally done when the result is referenced.

Parameter Passing Mechanisms

There are two kinds of formal parameters: those passed by reference, and those passed by value.

- reference parameters
 - all handled alike
- value parameters:
 - a) simple value parameters:
 - simple types (integer, char.)
 - array and record types ≤ 4 bytes
 - b) copied value parameters:
 - reals, and array and record types > 4 bytes

Reference parameters are those which are specified VAR in the procedure heading. They are “passed by reference”: the address of the actual parameter is passed to the called procedure or function. This address is used for all references to the parameter. No copying of the parameter is performed.

Value parameters are those which are **not** specified VAR in the heading. They are “passed by value”: a copy of the parameter is passed to the called procedure or function. If the value parameter is a simple type (except REAL), then its value is pushed on the stack. If the parameter is a simple REAL, or an array or record (and its size is more than 4 bytes), then its address is pushed on the stack by the caller. Before the called routine executes its first statement, it uses the pushed address to copy the parameter into its local data space (the Compiler reserved this space in addition to the local variable space).

Values of type “procedure” are not copied; their values are pushed directly even though they are eight bytes long.

Function Results

Sometimes the calling environment must allocate temporary space in which to return function results. In general this is necessary when the function returns a result which is bigger than 4 bytes. The temporary space is allocated as part of the program’s global area if the call is from the main program; otherwise it is allocated as part of the local data area. The amount of temporary space required is determined at compile time. Functions which return a value of type real are an exception; the result area is on the stack and occupies eight bytes.

Figure 6. PASCAL Procedure Calls (Without Static Links)

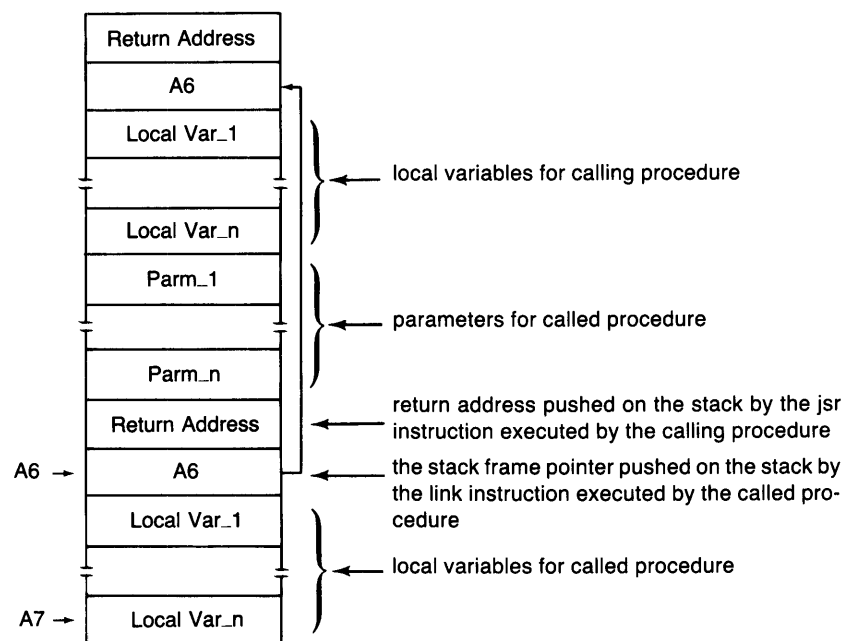

(The stack is pictured growing toward the bottom of the page. Pointers actually address the bottom of the designated entry.)

The following Pascal program illustrates the use of the static link.

```

$DEBUG ON$
Program main(input,output);

var i:integer;

Procedure A;
var k:integer;

    Procedure B;
    var m:integer;

        Procedure C(i:integer);
        var o:integer;

            Procedure D;
            var q:integer;
            begin
                i := k;
                k := m;
                m := o;
                o := q;
                q := 1;
                B;
                C(i);
            end; {D}

        begin {C}
            m := o;
            D;
        end; {C}

    begin {B}
        k := 1;
        C(m);
    end; {B}

begin {A}
    B;
end; {A}

begin {main}
    A;
end.

```

Note

The preceding program is only for the purpose of illustrating the use of the static link. Running the program results in error -2 (not enough memory), because the program recurses infinitely.

Consider the following calling sequence:

```

main calls A
A calls B
B calls C (with m as the parameter)
C calls D
D calls B
  
```

The stack for this calling sequence is shown in Figure 7.

Figure 7. PASCAL Procedure Calls With Static Links

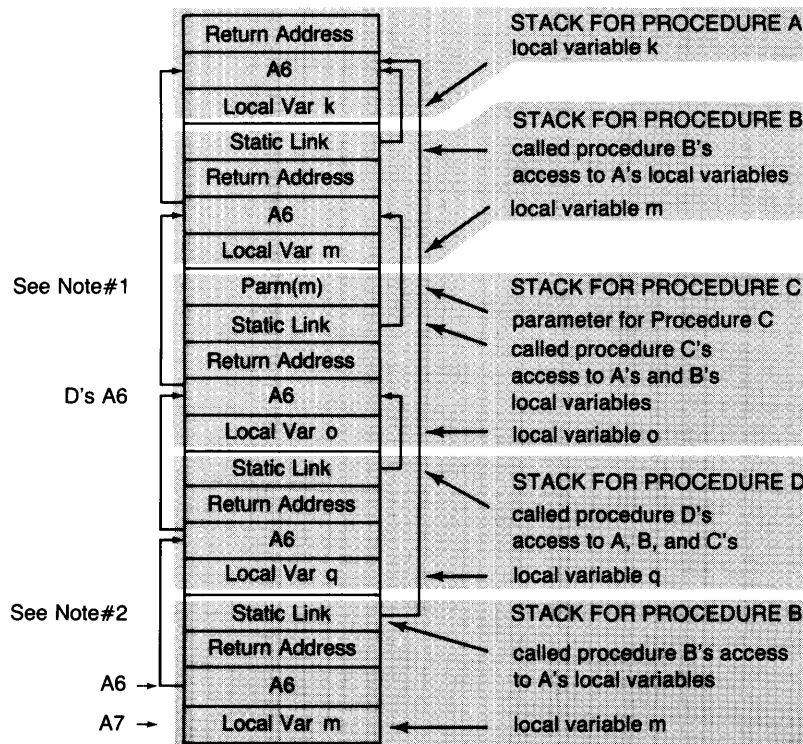

Note 1: The static link and the parameters are always accessed at positive offsets from *A6*. The effective address of the static link (if present) is always $8(A6)$. Local variables are at negative displacements from *A6*.

Note 2: In general the static link gives the called procedure access to the intermediate variables of procedures which precede it in the calling sequence. In this particular case the static link gives procedure B access to variables declared within procedure A.

(Pointers actually address the bottom of the designated entry.)

Procedure D reaches intermediate variables using:

- its current stack frame pointer
- the difference between its nesting level and that of the called procedure

In this case procedure D is at level 4 and procedure B is at level 2, for a relative distance of 2. Therefore procedure B must follow two static links to reach the stack frame of B.

In other words:

MOVEA.L 8(A6),A0	- get procedure D's static link
MOVEA.L 8(A0),A0	- get procedure C's static link
MOVE.L 8(A0),-(SP)	- get procedure B's static link and push it on the stack

Remember: procedure C's static link gives access to B's locals,
procedure B's static link gives access to A's, etc.

Note 3: When nested procedures reference intermediate variables they use the static link. An example of this is when procedure D references k and m in the statement $k := m$;

k is declared in procedure A and m is in procedure B. The nesting level relative to procedure D for k is 3 and for m it is 2.

The following code will perform the statement $k := m$.

MOVEA.L 8(A6),A0	get D's static link
MOVEA.L 8(A0),A0	get C's static link
MOVEA.L 8(A0),A0	get B's static link
MOVEA.L 8(A6),a1	get D's static link
MOVEA.L 8(a1),a1	get C's static link

MOVE.L -4(a1), -4(A0) store m in k

The return to procedure A (as shown in the following stack segment) is accomplished in four steps. Note: the register prefixes indicate the value of the register for the indicated step. The values are those the registers have AFTER the step has been executed.

Step 1: UNLK A6	- restore the stack frame pointer (A6)
Step 2: MOVEA.L (SP)+,A0	- save the return address in A0
Step 3: ADDQ.L #12,SP	- restore the stack pointer
Step 4: JMP (A0)	- return to where procedure A called B

If there are not any parameters then the return sequence normally is:

```

UNLK A6           - restore the stack frame pointer
MOVEA.L (SP) + ,(SP) - replace the static link with the return
                    address
RTS              - return to procedure A
  
```

If there is no static link (and no parameters) then the sequence is:

```

UNLK A6           - restore the stack frame pointer
RTS              - return to procedure A
  
```

Figure 8. Return from a Procedure Call

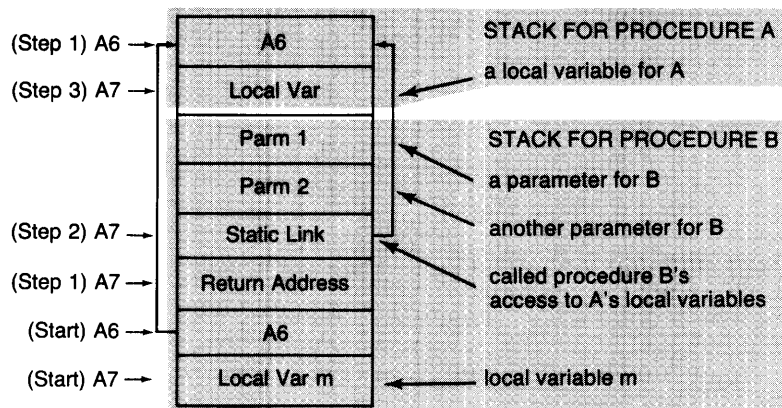

(Pointers actually address the bottom of the designated entry.)

Notes

The Assembler

Chapter

7

Introduction

This chapter describes the use of the Workstation Assembler subsystem. The Assembler translates assembly language routines into object code which can be executed on this system. Assembly language programming gives you the ability to optimize critical sections of a program (such as for reductions in execution time or code size).

The Workstation Assembler, which has a two-pass design, translates source files written in the assembly language specified by Motorola in the MC68000¹ and MC68020 manuals included in the Workstation Pascal documentation package. It also assembles instructions for the MC68881 floating-point math co-processor, which are described in the 68881 manual included in the Workstation documentation. A summary of the syntax required by this Assembler is provided in the “Instruction Syntax” section of this chapter.

Although it is not a tutorial on assembly language programming, this chapter contains the information necessary to write and execute assembly language routines on the Workstation System. The first section demonstrates the method of generating external procedures and entire object modules of Assembler code that can be interfaced to Pascal programs. You should be familiar with the concept of Pascal modules before attempting to emulate them in assembly language; refer to the “Pascal Compiler” chapter for pertinent information.

Unlike most other assembler subsystems you may have used, the directives (“pseudo-operations”) that you give to the Workstation Assembler are specified within the source program – they are not given in an interactive session with the Assembler. The Workstation Assembler’s pseudo-operations are fully described in the “Pseudo-op Reference” section near the end of this chapter.

¹ The MC68000 manual also includes documentation for the MC68010 processor.

Operating the Assembler

This section shows you how to:

- Invoke the Assembler
- Specify the name of your text file program and your resulting code file
- Give listing specifications
- Interpret the listing

Invoking the Assembler

The Assembler is delivered on the ASM: disc. If you plan to run the Assembler several times in a session, you could use the Permanent command to keep the Assembler in memory ready to run. Otherwise, put the ASM: disc in a drive and press to run the Assembler.

Source File Specification

If there is a work file (see the Filer chapter), that file will be automatically assembled and there will be an “errors only” listing on the CRT. If the “errors only” listing is sufficient, your source program file can be specified as the work file. Otherwise, clear the work file.

If there is no work file, you will be prompted to enter the name of your program file:

```
What source file?_
```

Enter the volume name (unless using the default volume explained in the Filer chapter), and file name of your source program. It is not necessary to include the “.TEXT” suffix of your file name. If it is not included, it will be done for you by the system. For example, if your program file is called PROGRAM.TEXT and it is on the volume called TOMS:, then use this file specification:

```
TOMS:PROGRAM
```

Listing File Information

You are then prompted to specify whether or not you will want a listing of the assembly:

```
Do you want a program listing (y/n/e) ?_
```

You may type:

- for a complete listing
- for no listing but errors reported on the CRT
- for a listing of the errors only

If you want a listing, you can have it printed immediately or have the Assembler generate a file of the listing information:

```
What listing file (default PRINTER:PROGRAM.ASC) ?_
```

For a printer listing, press or .

To generate a listing on a file, enter the name of the volume and the name of the file. It is recommended that a size specification be made for the listing file (See the Filer chapter). Otherwise, the largest space on the disc will be reserved for the listing, which may leave no space for the code file. A good rule of thumb is to use twice the number of blocks used by program file. For example, if TOMS:PROGRAM.TEXT is 20 blocks long, a size specification of 40 blocks is made for the listing file.

```
TOMS:PROGLIST.TEXT[40]
```

(Be sure to include the period at the end of the file name.)

It is possible to have a CRT screen listing by specifying "CONSOLE:" as the listing file. This is not recommended unless the program is very small, or an "error only" listing was requested. The listing will be scrolled onto the screen and you are returned to the Main Command Level. There is no way to control the screen listing.

Object File Specification

Finally, you are prompted to give a name for the code file that will be generated by the Assembler. The default name is that of the source file with the suffix: ".CODE" replacing ".TEXT".

```
Output file (default is TOMS:PROGRAM.CODE) ?_
```

If the default name is acceptable, press **Return** or **ENTER**. If you want to specify another name, enter the complete file specification.

After this entry, the Assembler begins processing your program. The CRT displays when the first pass of the Assembler is completed along with the number of errors encountered during the pass. There is a similar display for the second pass. After the second pass is completed, you are returned to the Main Command Level. If no errors were generated during the assembler, a code file was created.

If the assembly program is executable (has a start address), you may run it by pressing **R** at the Main Level. The Run command will run your program automatically until:

- another program is assembled or compiled.
- a workfile is specified.
- the computer is powered down.
- the system volume is re-specified.

If the Run command no longer works for your program, use the eXecute command and give the name of the code file that was generated.

Interpreting the Listing

The output from the Assembler contains the following information. The first column on the listing indicates the (decimal) number of the source-program line. For each line of source, a line number is generated. This is true of blank lines as well.

The second column shows the location counter (relative to the code origin). The value is in hex notation unless the DECIMAL pseudo-op is specified. When the program is loaded, the number in column two can be added to the base address of the load to obtain the absolute address of the instruction. This is useful information when debugging.

The third column shows the hexadecimal (base 16) representation of the machine code for the instruction or value of equated symbols generated by the Assembler.

The right side of the listing is a copy of the source program.

Sample Assembler Output

Line Number	Address	Emitted Code	Source Code
36	00000000		ror# 0
37			
38	00000000	0000 0000	simple2_zero dc.l 0,0
38	00000004	0000 0000	
39			
40	00000008	4E41	simple2_initialize trap #1 (stack check)
41	0000000A	0000	dc.w 0 (no local space)
42			
43	0000000C	4CFA 0300 FFF0	movem.l simple2_zero,a0-a1
44	00000012	48ED 0300 FFF0	movem.l a0-a1,sum(a5)
45			
46	00000018	4E5E	unlk a6
47	0000001A	4E75	rts
48			
49	0000001C	4E41	simple2_partadd trap #1
50	0000001E	FFFC	dc.w -4
51			
52		0000 0010	result equ 16
53		0000 000C	x equ 12
54		0000 0008	y equ 8 (relative to a6)
55		0000 0004	ret_addr equ 4

Error messages are listed under the line in which they occur. At the completion of the assembly, the number of errors will be displayed. If there are errors, there will be a directive for you to check the location of the last error in the program. At that location there will be a description of the error. Also listed will be the location of the error above it if one exists. In this manner, all errors can be located without having to search the whole listing.

The Programming System

It is assumed that you will be writing most of your programs in Pascal. In the instance where the execution speed of a particular routine is insufficient, this section will show you how to translate the Pascal routine into an assembly language routine and call it from your Pascal program.

It is possible to write a simple procedure, put it in the system library (usually a file named LIBRARY on the * volume), and access it with an EXTERNAL declaration from the Pascal program. However, add some interface text to the routine, and you have created a module. The benefits of modules are that global variables and constants may be used for communication among modules. Special types which define parameters need only be declared in the module containing the called procedure.

A Pascal module was developed for use as an example. The Librarian was used to disassemble the code into its assembly language counterpart. The intent of this section is to explain the method of interpreting the disassembly information and producing a working Assembler language module. The listings of the examples are included at the end of this chapter. The examples are also available on the documentation disc (DOC:). The file (ASMB_P1) imports the file (ASMB_M1). These are both Pascal files. The Pascal file (ASMB_P2) imports the Assembler language file (ASMB_M2).

You'll notice in the example program that the variables are declared to be of the type which are defined in the imported module. If the program merely declared one or two of the procedures to be EXTERNAL procedures, those special types would have to be defined in every program that called the procedures. It would be like going to the Library for a book and having to write down the table of contents every time you wanted to use the book.

For your Assembler language module to interface cleanly with the Pascal program, the conventions of the Compiler must be followed. That is, you must set up the Assembler language module to act as if it were a compiled Pascal module. You must also exit the module leaving everything in order, as a Pascal module would.

The information you need to accomplish a clean "Pascal-to-Assembler language" interface is presented in this section. You should understand how the Compiler:

- Prepares interface text (IMPORT text)
- Declares entry points (DEF table)
- Declares external references (EXT table)
- Passes parameters
- Creates global variable space
- Initializes modules
- Recovers from errors
- Returns from subroutines

You will find a listing of the Pascal program and module as originally written, a listing of the disassembly of the module, and a listing of the final, working Assembler language module. These listings are included at the end of this section. It might be helpful to remove them from the manual and keep them out for reference as you're reading this material.

The first subject covered is the method of generating the IMPORT text. This is what separates an importable module from a simple external routine. The subsequent material is of concern in either case. There will be a short explanation of the method for declaring EXTERNAL routines toward the end of the section.

The IMPORT Text

Certain information must be passed from an imported module to the Compiler to complete the module interface. This information is the IMPORT text. Actually, IMPORT text contains IMPORT declarations and EXPORT declarations. It's called IMPORT text because it's what the Compiler needs when it is importing the module. It must know the module name, global variables, global constants, and procedure and function names. If special TYPE declarations are needed to define the variables, they must be included in this information.

At compile time, your imported Assembler module must make this information available to the Compiler. This is done with the SRC pseudo-op. See how the IMPORT text of the Pascal listing is exactly the same as the SRC-IMPORT text below.

```

src module simple2;
src export
src type
src   rec = record
src     i1 : integer;
src     i2 : integer;
src   end;
src const
src   zero = rec[i1:0,i2:0];
src var
src   lastresult : rec;
src procedure initialize;
src procedure add(a,b : rec;
src               var out : rec);
src end;

```

The SRC section does not actually name the module or get the global space. There are separate techniques for accomplishing these things, which are discussed later.

The DEF Table

The DEF table contains the locations of all the entry points in the Pascal module and the location of its global space. This information is provided for the linking loader. The information is used to link all the modules together before they can be loaded and executed.

```

DEF table of 'SIMPLE':

SIMPLE                Gbase
SIMPLE_ADD            Rbase+82
SIMPLE_INITIALIZE    Rbase+10
SIMPLE_SIMPLE        Rbase+252
SIMPLE_ZERO          Rbase

```

The symbol "SIMPLE" which is the same as the module name, is the name of the module's global variable space. This symbol is entered into the DEF table automatically when you reserve the global space using the COM statement. This is explained later in the global variable section of this chapter.

“SIMPLE_ADD” AND “SIMPLE_INITIALIZE” are the entry points into the two procedures “add” and “initialize”. When writing Assembler language routines, they must be named as the Compiler names its procedures. The Compiler appends the module name to the front of the procedure name, separated by an “_”. When the Compiler looks at your IMPORT section, it assumes that the procedures have been named by its convention. When it’s time for the loader to hook everything together, it looks for those procedure names in your module’s DEF table.

“SIMPLE_SIMPLE” is the entry point, or location, of the module initialization body. Module initialization is discussed later in this chapter.

“SIMPLE_ZERO” is the location of the structured constant, “zero”, which appears in the IMPORT section of the module. Any code which resides in the assembly module and is declared in the IMPORT section of the module, must appear in the DEF table. It, too, must be named by prefixing the module name to the constant name that you declare in the IMPORT section. This name must appear as a label at the constant’s location in the program.

You must create a DEF table for the Assembler version of your routine. This is done using the DEF statement. Notice that all the symbols in the Pascal module’s DEF table are named in the DEF statements below except the symbol for the global variable space. The global variable symbol is entered into the table at the time the space is reserved with the COM statement.

```
def simple2_add
def simple2_initialize
def simple2_zero,simple2_simple2
```

The EXT Table

The EXT table that you get from the Librarian is the list of the symbols that the loader must find in some corresponding DEF table so our module can access those external items.

```
EXT table of 'SIMPLE':
SYSGLOBALS
```

“SYSGLOBALS” is the only symbol in this particular list. We need to access some of the system’s global variables in our routine so we must know where they are kept. They are in the global variable space for the system, “SYSGLOBALS”. (See the TRY-RECOVER section for more details about the system globals.)

The EXT table is created in the Assembler module using REFA and REFR. Both instructions enter symbol names into the EXT table. REFA causes the symbol to be referenced using absolute addressing. REFR causes the symbol to be referenced using 16-bit PC relative addressing. See REFA, REFR, SMODE and LMODE in the pseudo-op reference section.

In the example, “SYSGLOBALS” was declared as external using REFA.

If other modules’ global variable sections were to be referenced, the symbol for those areas would also need to be included in our EXT table. This is explained in the global variable section.

Declaring the Module Name

The module is named using MNAME. This puts the name of the module in the module directory for the Compiler to reference when importing the module.

If no MNAME is used, the module name will be the same as the file name.

Passing Parameters

When parameters are passed to a procedure, the values or addresses of variables in the parameter list are pushed onto the stack. The function result space is put on the stack if the routine is a function. The leftmost variable in the parameter list is pushed onto the stack. Then the rest are pushed onto the stack in order from left to right. The return address is pushed onto the stack automatically by the processor at the time the JSR instruction is encountered.

For example:

```

114 2F0E          move.l a6,-(sp)
116 487A 005A     pea Rbase+208
120 2B4F FFF6     move.l sp,SYSGLOBALS-10(a5)
124 598F          subq.l #4,sp
126 2F2E FFF0     move.l -16(a6),-(sp)
130 2F2E FFF8     move.l -8(a6),-(sp)
134 4EBA FF98     jsr Rbase+32
138 2B5F FFF8     move.l (sp)+,Gbase-8(a5)
142 598F          subq.l #4,sp
144 2F2E FFF4     move.l -12(a6),-(sp)
148 2F2E FFFC     move.l -4(a6),-(sp)
152 4EBA FF86     jsr Rbase+32
156 2B5F FFFC     move.l (sp)+,Gbase-4(a5)
160 202D FFF8     move.l Gbase-8(a5),d0
164 D1AD FFF0     add.l d0,Gbase-16(a5)
    
```

The stack is mapped in the following way:

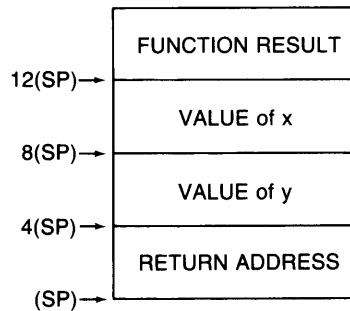

Notice that the stack grows downward (toward smaller addresses).

If a parameter is passed by reference, a 4-byte address is pushed onto the stack. When passing by value, values up to 4-bytes are pushed onto the stack, but larger values are essentially passed by reference. That is, a 4-byte address is pushed on the stack. In this case, a copy of the value must be made in local variable space so that the actual parameter is not altered. This is illustrated in the Local Variable section.

More information can be found in the Compiler chapter under the heading “How Pascal Uses the Stack”.

Declaring Global Variables

You must understand how the Compiler allocates global variable space so that you get and use global space the same way. The value stored in register A5 is the base address for all global areas. Each module that declares global variables is allocated an area for them. The symbol assigned to the area is the distance from the base address in A5 to the top of the global area. Globals are then referenced symbolically, using the global area name and offset relative to A5.

The name for the location of a module's globals (relative to the address in A5) is the same as the module name. So the symbol for the global area for "module simple" would be "SIMPLE".

Determine how much space you need for your globals. When determining how much space is needed, you must also consider any variables that are internally global to the module. Notice on the Pascal module listing that the variable "sum" is global to the module.

If you are rewriting a Pascal module as we have done in the example, the Compiler provides variable size information beside the variable declarations on the listing (the negative number). More detailed information can be displayed using the Compiler's \$TABLES\$ directive. In Assembler language modules, you must also specify the size as a negative value. Declare global space using the COM statement:

```
COM simple2,-16
```

The value, -16, corresponds to the total size of global variables "lastresult" and "sum". Both are records containing two integers each.

The COM statement also enters the symbol into the DEF table.

Referencing Global Variables

The Assembler module name is SIMPLE2, as is its global base. Notice in the DEF Table that "SIMPLE" is equal to "Gbase" (Global BASE) for the Pascal module. Global locations in the disassembly of the Pascal module are referenced using the symbol "Gbase" rather than "simple".

```
DEF table of 'SIMPLE':
```

SIMPLE	Gbase
SIMPLE_ADD	Rbase+82
SIMPLE_INITIALIZE	Rbase+10
SIMPLE_SIMPLE	Rbase+252
SIMPLE_ZERO	Rbase

```
-----
170  202D FFFC      move.l Gbase-4(a5),d0
174  D1AD FFF4      add.l d0,Gbase-12(a5)
178  4E76          trapv
180  206E 0008      movea.l 8(a6),a0
184  4CAD 1E00      movem.w Gbase-8(a5),a1-a4
```

When writing your Assembler language module, use the COM symbol to reference globals. The Assembler doesn't recognize "Gbase". In our Assembler module, the global variables are referenced using "SIMPLE2".

```

lastresult      equ simple2-8
lastresult_i1  equ simple2-8
lastresult_i2  equ simple2-4
sum            equ simple2-16 (all are relative to a5)
sum_i1        equ simple2-16
sum_i2        equ simple2-12
escapecode     equ sysglobals-2
recover_rec    equ sysglobals-10

```

Note

When structured variables are used, the individual elements of the structure are referenced at progressively higher addresses within the structure's space.

If, for example, you had declared two integers separately instead of together in one record, you would refer to them as:

```

lastresult_i1      EQU      simple2-4
lastresult_i2      EQU      simple2-8

```

Referencing Other Module's Globals

When referencing the global variables of another module, it is necessary to establish the external reference using REFR or REFA.

The individual variables are referenced at negative offsets from the symbol and relative to A5, as described in the global variable section above. As was mentioned previously, offsets into data areas are provided on Compiler listings.

Local Variables

There are several methods for getting local variable space. The following method is recommended for those intending to produce purely relocatable code. This is important if the code is to be committed to ROM.

Notice that the first instruction in each of the disassembled routines is:

```
TRAP #1
```

TRAP #1 calls a system routine which allocates local variable space in a new stack frame. A check is made of available stack space. If there isn't room on the stack, a "Not Enough Memory" error is reported and control is transferred to the Main Command Level.

The TRAP #1 routine then executes a LINK instruction. The LINK instruction is explained in detail in the MC68000 and MC68020 manuals, and in the Compiler chapter under "How Pascal Uses the Stack".

Our Assembler does not understand the double operand format of the TRAP instruction as it is printed in the disassembly listing. The size of the stack frame is specified following the TRAP instruction in a DC.W instruction. The value of the constant in the DC.W instruction specifies the amount of space needed for local variables.

The following illustration shows the stack before the function “part_add” gets its local variable space.

Before the LINK:

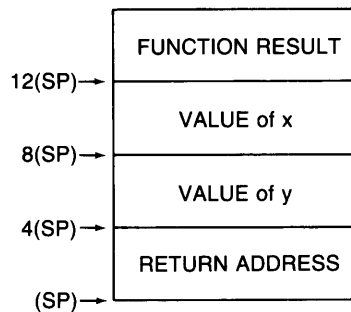

After the LINK:

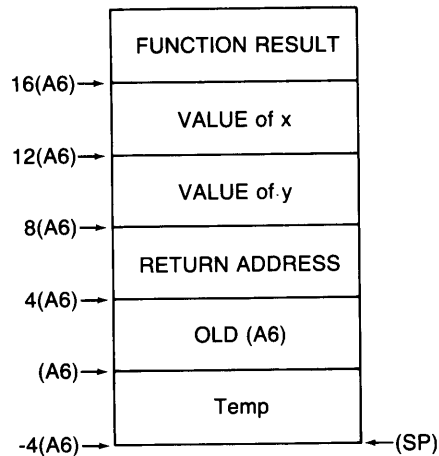

Parameters are now referenced relative to A6 instead of SP. Local variables are referenced at negative offsets from A6.

Local variable space is also needed for copies of some value parameters. As was discussed in the parameter section, value parameters which are larger than 4 bytes have their address put on the stack in place of the value. In order not to alter the value of the actual parameter, a copy must be made in local variable space. Allocate the space using the TRAP instruction, then immediately move the values of the value parameters into the local variable space. This is the case with the parameters to “Procedure Add”.

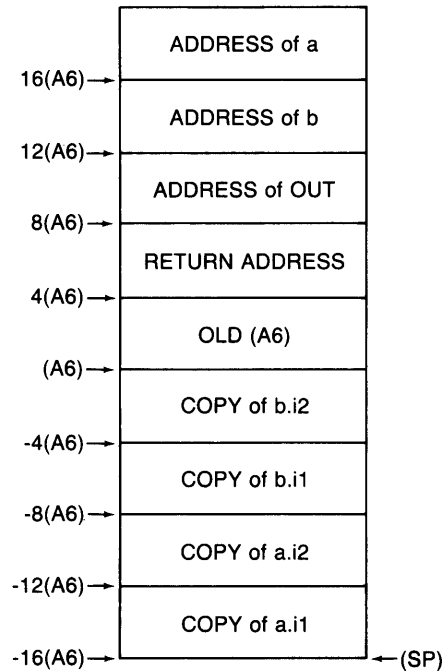

This mapping was accomplished by the following block of code:

```

76  504F      addq.w #8,sp
78  4ED0      jmp (a0)
80  0000      dc.w 0          or dc.b 0,0          or dc.b ' '
-----
82  4E41 FFF0  trap #1,*-16
86  206E 0010  movea.l 16(a6),a0
90  2D5B FFF0  move.l (a0)+,-16(a6)
94  2D50 FFF4  move.l (a0),-12(a6)
98  206E 000C  movea.l 12(a6),a0
102 2D5B FFF8  move.l (a0)+,-8(a6)
106 2D50 FFFC  move.l (a0),-4(a6)
110 2F2D FFF6  move.l SYSGLOBALS-10(a5),-(sp)
114 2F0E      move.l a6,-(sp)
116 487A 005A  pea Rbase+208
120 2B4F FFF6  move.l sp,SYSGLOBALS-10(a5)

```

Module Initialization

Finally, it is necessary to include a module initialization body within each module. The initialization body is a routine which is named by appending the module name to itself, separated by “_”.

The purpose of module initialization is to allow for file initialization within the module. Even if a module declares no files, the Compiler emits a call to the module initialization body for every module imported into a program. It can be a null routine such as an RTS with the label tacked on to the end of the assembly:

```
simple2_simple2    rts
```

The name of the module initialization body must be marked as an entry point along with the other procedure names using DEF.

Error Recovery

The TRY-RECOVER escape mechanism can be written into assembly language routines for graceful termination of programs that generate errors. TRY-RECOVER is explained in detail in the “Error Trapping and Simulation” chapter.

The section of code that could cause the error is enclosed within the TRY section. The TRY section creates a RECOVER-record on the stack. The record contains the location of the previous RECOVER-record, the stack frame pointer, (A6), and the location of the RECOVER code. The location of this record is saved in a special location that the system knows about. This location is at an offset of -10 in “SYSGLOBALS” (operating SYStem GLOBALS). “SYSGLOBALS” is relative to A5.

An example of the TRY action is taken from the disassembly:

86	206E 0010	movea.l 16(a6),a0
90	2D58 FFF0	move.l (a0)+,-16(a6)
94	2D50 FFF4	move.l (a0),-12(a6)
98	206E 000C	movea.l 12(a6),a0
102	2D58 FFF8	move.l (a0)+,-8(a6)
106	2D50 FFFC	move.l (a0),-4(a6)
110	2F2D FFFB	move.l SYSGLOBALS-10(a5),-(sp)
114	2F0E	move.l a6,-(sp)
116	4B7A 005A	Pea Rbase+20B
120	2B4F FFFB	move.l sp,SYSGLOBALS-10(a5)
124	598F	subq.l #4,sp
126	2F2E FFF0	move.l -16(a6),-(sp)
130	2F2E FFF8	move.l -8(a6),-(sp)
134	4EBA FF9B	Jsr Rbase+32
138	2B5F FFF8	move.l (sp)+,Gbase-8(a5)

After the above code has been written, write the code body of the routine.

The last piece of code must restore the pointer to the previous RECOVER-record and remove the current one from the stack. Control is then transferred to the instruction following the RECOVER section. For example:

```

178  4E76          trapv
180  206E 000B     movea.l 8(a6),a0
184  4CAD 1E00     movem.w Gbase-8(a5),a1-a4
      FFFB
190  4890 1E00     movem.w a1-a4,(a0)
194  2B6F 000B     move.l 8(sp),SYSGLOBALS-10(a5)
      FFFB
200  DEFC 000C     adda.w #12,sp
204  4EFA 0024     jmp Rbase+242
208  2C5F          movea.l (sp)+,a6
210  2B5F FFF6     move.l (sp)+,SYSGLOBALS-10(a5)
214  7064          moveq #100,d0
216  B06D FFFE     cmp.w SYSGLOBALS-2(a5),d0
220  6600 0012     bne Rbase+240
224  4CBA 0F00     movem.w Rbase,a0-a3

```

If an error or exception does occur, the system stores the number of the error in a location at “Sysglobals-2(A5)” and looks at “Sysglobals-10(A5)” to find the location of the RECOVER-record. This location is loaded into the Stack Pointer register (SP). The location of the RECOVER routine is then popped off the stack and control is transferred to the RECOVER routine. The next value popped off the stack is the stack frame pointer for the RECOVER routine. It is moved to A6. Then the higher level RECOVER-record pointer is popped off the stack and moved to “Sysglobals-10(A5)”.

Once these values have been restored, you may examine the value at “Sysglobals-2(A5)” and determine what action to take. If you want to handle the error, you may do so. If not, execute a “TRAP #10” and the problem will ripple out to be handled by the higher level RECOVER routine.

Here is the assembly version of the RECOVER routine:

```

204  4EFA 0024     jmp Rbase+242
208  2C5F          movea.l (sp)+,a6
210  2B5F FFF6     move.l (sp)+,SYSGLOBALS-10(a5)
214  7064          moveq #100,d0
216  B06D FFFE     cmp.w SYSGLOBALS-2(a5),d0
220  6600 0012     bne Rbase+240
224  4CBA 0F00     movem.w Rbase,a0-a3
      FF1C
230  4BAD 0F00     movem.w a0-a3,Gbase-8(a5)
      FFFB
236  6000 0004     bra Rbase+242
240  4E4A          trap #10
242  4E5E          unlk a6
244  205F          movea.l (sp)+,a0
246  DEFC 000C     adda.w #12,sp

```

Exception Coding

In your TRY block you may wish to raise certain exception conditions and handle them in the RECOVER section. This corresponds to the Pascal standard procedure ESCAPE. When the condition is determined, store a 16-bit integer value representing the error in “SYSGLOBALS-2(A5)” and execute a TRAP #10. For example:

```

32  4E41 FFFC      trap #1,#-4
36  202E 000C     move.l 12(a6),d0
40  D0AE 0008     add.l 8(a6),d0
44  4E76         trapv
46  2D40 FFFC     move.l d0,-4(a6)
50  4AAE FFFC     tst.l -4(a6)
54  6C00 000A     bse Rbase+66
58  3B7C 0064     move.w #100,SYSGLOBALS-2(a5)
    FFFE
64  4E4A         trap #10
66  2D6E FFFC     move.l -4(a6),16(a6)
    0010
72  4E5E         unlk a6
74  205F         movea.l (sp)+,a0
76  504F         addq.w #8,sp

```

The example generates an escape with escapecode 100 if lines 58-64 get executed. In your recovery section, check “SYSGLOBALS-2(A5)” to see if you recognize the value. If you do, make the appropriate recovery. Otherwise, your RECOVER section restores the old RECOVER-record location and issues another TRAP #10. Thus the error is passed on to the next RECOVER block.

Returning to Pascal

When returning to Pascal from assembly, the stack must be cleaned up, a function value must be left on the top of the stack if appropriate, and all Pascal dedicated registers must be restored (A5, A6 and A7).

You can return to Pascal by leaving the return address on the top of the stack and executing an RTS, or you can store the return address in an address register and execute a JMP indirect through the address register.

```

216  B06D FFFE     cmp.w SYSGLOBALS-2(a5),d0
220  6600 0012     bne Rbase+240
224  4CBA 0F00     movem.w Rbase,a0-a3
    FF1C
230  4BAD 0F00     movem.w a0-a3,Gbase-8(a5)
    FFF8
236  6000 0004     bra Rbase+242
240  4E4A         trap #10
242  4E5E         unlk a6
244  205F         movea.l (sp)+,a0
246  DEFC 000C     adda.w #12,sp
250  4ED0         jmp (a0)
252  4E75         dc.w 20085      or dc.b 78,117      or dc.b 'Nu'

```

Declaring External Procedures

Most of the subjects that have been covered in this section are relevant to EXTERNAL procedures.

If you just want to write a routine, put it in the current System Library file (default is the “LIBRARY” file), and call it from Pascal by declaring it as EXTERNAL, you won’t need to be concerned with IMPORT text.

You will need to generate EXT and DEF tables. And you will have to deal with parameters. You may or may not want to deal with local variable space. If you want local space, you will reference your parameters relative to (A6). Otherwise, reference them relative to (SP). You will **not** have to write a module initialization body.

The TRY-RECOVER mechanism is also optional. There’s always a RECOVER routine somewhere that has to handle those errors. The Operating System puts one around your program before execution.

You must be concerned with the stack. All the parameters must be removed. It must be left in the condition it was in before the calling procedure started preparing for the call.

You must be concerned with restoring A5 and A6 to their original values.

Write the routine, assemble it, and use the Librarian to put it in the System Library. From Pascal, declare it as EXTERNAL, and call it just as if it were a Pascal procedure.

Just remember — if you’re not using standard types, every program that calls this routine will have to define the special types just as you had originally defined them.

Instruction Syntax

This section provides details of the syntax of assembly language instructions required by the Workstation Assembler.

Note

Beginning with system version 3.1, the Workstation Assembler supports all of the 68020 processor and 68881 co-processor instructions. Thus, you can assemble programs that contain instructions which may not be executable by your computer. Consult the target computer's hardware documentation to determine which processor is installed in it.

General Syntax

Here is the syntax required for Workstation Assembler instructions. Each portion of the diagram is further described or expanded in the following paragraphs.

Program Line Syntax

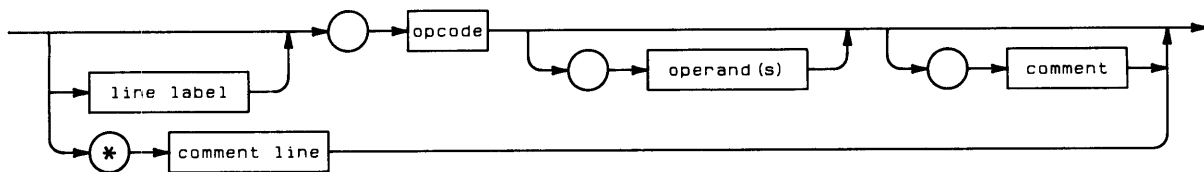

Empty circles denote required spaces. Line labels and comment lines must begin in column 1.

Examples

<u>Labels</u>	<u>Opcodes</u>	<u>Operands</u>	<u>Comments</u>
	RTS		
Label_9	STOP		
	JSR	Subr_name	
Sum	ADD	D1,D2	This is a comment.
* This whole line is a comment.			

Instruction Fields

There are no fixed-width fields within instructions; instead, space characters delimit the fields of instructions. For instance, the first space after a line label separates it from the subsequent opcode; the first space after the opcode separates it from the operand; and so forth. Therefore, the following two program lines are equivalent:

```
Label    ADD    D1,D2          This is a comment.

Label ADD D1,D2 This is a comment.
```

This rule dictates that spaces are not permitted within the label, opcode, or operand fields, because the first space encountered after the start of the field ends that field. Instructions are otherwise free-format with respect to spaces; for example, comment fields may have any number of spaces, within the limits of the line width.

Letter Case

Upper- and lower-case characters may be used interchangeably, except inside of literal (quoted) strings.

```
add    d1,d2
MOVE  D2,(A1)
BTst  #31,D2

dc    'This is a literal,'  These two literals are not equivalent.
dc    'THIS IS A LITERAL,'
```

Line Labels

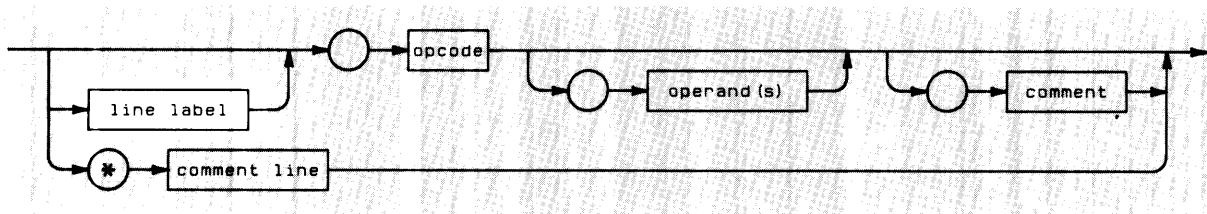

If a line label is present, it must start in column 1 of the line. The opcode must start in column 2 or later (or it will erroneously be considered to be a label).

```
1234567890123456789012345678901234567890

Label MOVE A1,A2 Comment field.
      MOVE A1,A2      Comment field.
```

Line labels are in a class of objects called *symbols*, which are described in the “Symbols” discussion of the subsequent “Operands” section.

Opcodes

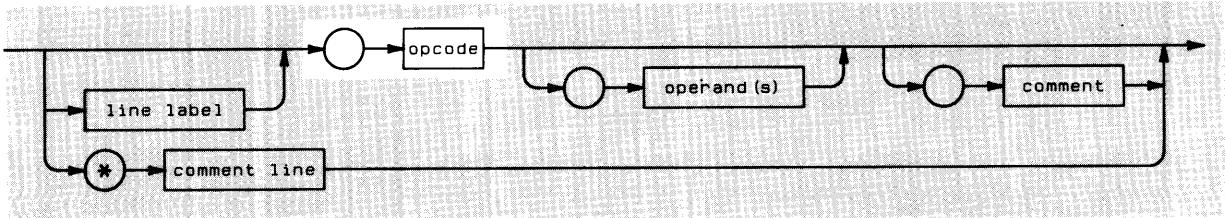

Opcodes (operation codes) are mnemonic abbreviations used for specifying machine language instructions. Here are some examples:

```
ADD
JSR
MOVE
```

The term “opcodes” includes these three types of codes:

- Processor opcodes
- Co-processor opcodes
- Assembler pseudo-opcodes (or simply “pseudo-ops”)

Processor and co-processor opcodes are described in this section. Assembler pseudo-ops are described near the end of the chapter.

Processor Opcodes

All opcodes described in the 68000 or 68020 user’s manuals are supported by the Workstation Assembler. Since the syntax and semantics of each instruction are fully described in those manuals, they will not be described here.

Note that some instructions have Address, BCD, Immediate, or Quick forms. When possible, Motorola’s assembler automatically generates machine instructions for these opcodes (for optimization). However, the Workstation Assembler does not, unless explicitly told to do so.

Co-processor Opcodes

Co-processor opcodes are supported by the Workstation Assembler. See the MC68020 user’s manual for a general description of the syntax and semantics of each. Details of particular co-processors, such as the 68881, are provided in the documentation for the corresponding product. See the “MC68881 Support” section for a description of exceptions to the syntax and support suggested in the MC68881 document.

Size Suffixes

Size suffixes can be appended to both of the following items:

- Opcodes
- Index registers (in operands)

They specify the size of operand(s) used by the instruction.

The available size suffixes and their definitions are as follows:

Suffix	Meaning	Data Size	Where Used
B	Byte	8 bits	Opcodes only
S	Short	8 bits	Opcodes (Branch instructions only)
	Single	32 bits	MC68881 opcodes only
W	Word	16 bits	Opcodes and index registers
L	Long	32 bits	Opcodes and index registers
D	Double	64 bits	MC68881 opcodes only
X	Extended	96 bits	MC68881 opcodes only
P	Packed BCD	96 bits	MC68881 opcodes only

All instructions that can operate on more than one data size will assume the default size of word (16 bits) unless a size suffix is explicitly specified.

Here are some examples of using these suffixes:

```

ADD,B  D1,D2  ADD registers as Bytes
ADD,W  D1,D2  ADD registers as Words
ADD    D1,D2  ADD registers as Words (default operand length)
ADD,L  D1,D2  ADD registers as Long words

ADD (A1,A2,W),D1  16 bits of A2 are used as index (default)
ADD (A1,D2,L),D1  32 bits of D2 are used as index

BEQ,S  Label_Z  Branch on EQual; destination specified by 8 bits
BEQ,W  Label_Z  Branch on EQual; destination specified by 16 bits (always)
BEQ    Label_Z  Branch on EQual; destination specified by 8 or 16 bits
BEQ,L  Label_Z  Branch on EQual; destination specified by 32 bits

FSGLDIV,S  FP0,FP1  Single-precision division: FP0/FP1
FSGLMUL,S  (A0),FP1  Single-precision multiply: (A0)*FP1
FMOVE,D   #3,14,FP0  Double-precision move: 3.14 to FP0

```

Note that in the `BEQ` instruction with no suffix, the Assembler determines whether it will use 8 or 16 bits to specify the destination. In contrast to this, the `BEQ,W` opcode specifies that 16 bits will be used, even though the destination might fit in 8 bits.

Operands

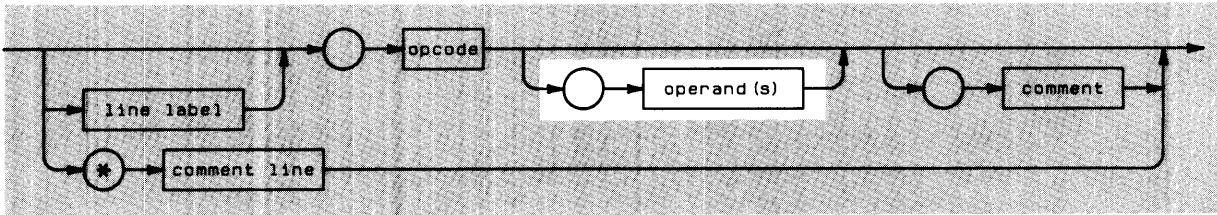

Operands specify the data upon which the operation is to be performed. They are composed of any of the following:

- Constants
- Symbols
- Expressions containing constants, symbols, and operators
- An instance of an addressing mode (see the subsequent “Addressing Modes” section for further information)

Constants

Constants are sequences of ASCII characters that define a numeric value. There are basically four types of constants:

- Decimal numeric constants.

```
123
2147000111
```

Note that decimal numeric constants may contain any decimal digits 0 through 9; however, they may **not** contain a sign character (+ or -), which would make them an *expression* (see the subsequent “Expressions” section).

- Hexadecimal numeric constants.

```
$19
$FF20
```

A \$ preceding a numeric constant indicates that it is a hexadecimal (base 16) quantity.

- Floating-point numeric constants.

```
3.14
5.01E9
-3.14E-99
2.718E-231
```

The syntax requirements for these constants are the same as for Pascal floating-point (real) constants. See the “Real and Longreal Literals” section of the “Numbers” entry in the *HP Pascal Language Reference* for details.

- Literal character constants.

```
'a'
'-.z1'
```

When the characters are enclosed within single quotes, the Assembler emits a series of bytes, one per character, each of which contains the ASCII code of the corresponding character.

Literal character constants may contain 0 to 4 characters. If the single quote character (') is to be part of the constant, you must put two quotes in the literal.

```
'a''b'      Literal is a'b
```

Symbols

Symbols are *names* used in place of values or registers. Symbols must begin with an alphabetic character, but they may subsequently contain digits (0..9), @, \$ and _ as well as alphabetic characters. Here are some examples:

```
Symbol
SYM_2
MAIN__main
Z@_$13
```

Symbols may contain any number of characters. The only restriction is that each instruction must be contained entirely on one line. Note also that upper-case and lower-case letters are considered equivalent in symbols; i.e., the symbol MAIN is equivalent to the symbol main.

Here are examples of using symbols in instructions:

```
Symbol1 EQU RBase+32
        JSR Symbol1
        ADD (Symbol12,A1),D1
```

The Location Counter Symbol

The * character is a symbol that signifies the value of the Assembler's location counter (except when the * is in column 1, which indicates a comment line). Here is an example of using the symbol in a branch instruction.

```
BRA *-2
```

The location counter points to the memory address at which the instruction begins, and thus is analogous to the processor's program counter (PC). In fact, * is equal to the program counter at the point the instruction is fetched; however, the PC varies from * by 2 or 4 bytes at the point the operands are fetched.

Symbol Types

Here are descriptions of the various types of symbols known to the Assembler:

- **Pre-defined register symbols** are any of the following:

Symbol	Register Specified
A0 thru A7	Address registers 0 thru 7
CCR	Condition Code Register
CACR	CAche Control Register
CAAR	CAche Address Register
D0 thru D7	Data registers 0 thru 7
DFC	Destination Function Code register
FPO thru FP7	Floating-Point co-processor registers 0 thru 7
FPCONTROL	Floating-Point co-processor control register
FPSTATUS	Floating-Point co-processor status register
FPIADDR	Floating-Point co-processor Immediate ADDRESS register
ISP	Interrupt Stack Pointer (A7')
MSP	Master Stack Pointer (A7'')
SFC	Source Function Code register
SP	Stack Pointer (same as USP and A7)
SR	Status Register
USP	User Stack Pointer (same as SP and A7)
VBR	Vector Base Register

Note that the symbols `FPCONTROL`, `FPSTATUS`, and `FPIADDR` are deviations from Motorola's assembler symbol names; however, you can define the Motorola register symbols as shown in the third example below.

- **User-defined register symbols** are created with the `EQU` (equate) pseudo-op:

```
StackPointer EQU SP
MyAddressReg EQU A1
STATUS EQU FPSTATUS
```

Note that these are the only type of symbols that need to be defined *before* they are used.

- **Absolute symbols** are those which either follow an `ORG` pseudo-op or are equated to an absolute expression. Here are some examples:

```
ORG $FFFFFF00
AbsSym1 EQU $FFFFFFED2
AbsSym2 EQU AbsSym1+16
AbsSym3 EQU RelSym1-RelSym2 Note: DIFFERENCE of 2 relatives is absolute
```

- **Relative symbols** are those which follow a `RORG` pseudo-op or are equated to a relative expression.

```

RORG *                               Relative to Program Counter (PC)

RelSym1 EQU RBase+16

RelSym2 EQU RelSym1

RelSym3 EQU RelSym2+AbsSym2          Note: CANNOT add 2 relatives

```

- **External symbols** are those which are defined in another module (by a `DEF` Assembler pseudo-op, or by another language's compiler). They can be either absolute or relative. Here examples of how external symbols are defined (in the module to which they are external):

`REFA AbsExtSym1` Absolute external symbol.

`REFR RelExtSym1` Relative external symbol.

Expressions

Expressions are the general case of operand: they may be just symbols; or they can be more complex combinations of symbols, constants, and operators. The operators in expressions are limited to the following:

- - subtraction, or unary minus
- + addition, or unary plus
- ! bit-wise logical OR
- & bit-wise logical AND

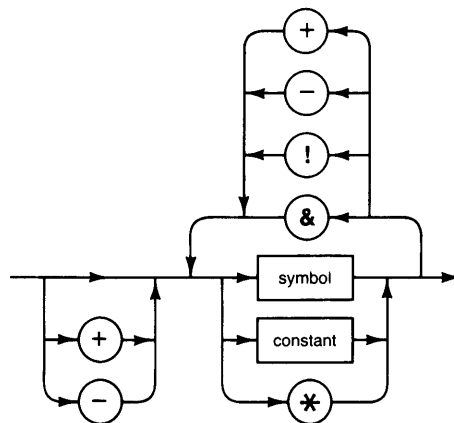

Expressions are evaluated in strict left-to-right order, and parentheses are *not* allowed. Only *one* external symbol, or symbol equated to an expression containing an external symbol, is allowed per expression. Also note that you cannot add two relative symbols (although you can subtract two, since the difference is an absolute value).

`2+2`

`RelSym1+48+$DF00`

`RelSym1-RelSym2+RelSym3+AbsExtSym1`

`AbsSym1-AbsSym2+RelSym3+AbsSym3`

Addressing Modes

The Workstation Assembler supports all of the addressing modes of the current 68000 family of processors; this section describes the syntax required to access each mode.

With system version 3.1, the Workstation Assembler was updated to support the 68020 processor's addressing modes. Since these new modes cannot be accessed with the old address syntax, new syntax is required. However, *note that the old 68000 syntax is still supported in all instances.*

The following table shows the syntax and operand components of all supported addressing modes. Descriptions of operand components are given in the legend on the next page.

Description of Mode	Old Assembler	New Assembler
Data Register Direct	Dn	same
Address Register Direct	An	same
Address Register Indirect	(An)	same
Address Register Indirect with Post-increment	(An)+	same
Address Register Indirect with Pre-decrement	-(An)	same
Address Register Indirect (absolute displacement)	d16(An)	(bd,An)
Address Register Indirect with Index (absolute displacement)	d8(An,Rn,SIZE)	(bd,An,Xn,SIZE*SCALE)
Memory Indirect Post-indexed	n/a	([bd,An],Xn,SIZE*SCALE,od)
Memory Indirect Pre-indexed	n/a	([bd,An,Xn,SIZE*SCALE],od)
PC Memory Indirect Post-indexed	n/a	([rbd],Xn,SIZE*SCALE,od)
PC Memory Indirect Pre-indexed	n/a	([rbd,Xn,SIZE*SCALE],od)
Absolute Address	Expr	same
Program Counter Indirect (relative displacement)	rd16	rbd
Program Counter Indirect with Index (relative displacement)	rd8(Xn,SIZE)	(rbd,Xn,SIZE*SCALE)
Immediate Data	*Expr	same
Register List (such as for MOVEM)	Ai-Aj/Dm-Dn	same
Bit Field Specifier	n/a	operand{offset:width}

Legend:

An	= Address register symbol:	A0 thru A7
Dn	= Data register symbol:	D0 thru D7
Xn	= Index register symbol:	A0 thru A7, or D0 thru D7
Rn	= Equivalent to Xn (see above)	
d8	= absolute expression (8-bit):	-2^7 thru $2^7 - 1$
d16	= absolute expression (16-bit):	-2^{15} thru $2^{15} - 1$
bd	= absolute expression (32-bit):	-2^{31} thru $2^{31} - 1$
od	= absolute expression (32-bit):	-2^{31} thru $2^{31} - 1$
rd8	= relative expression (8-bit):	$PC - 2^7$ thru $PC + 2^7 - 1$
rd16	= relative expression (16-bit):	$PC - 2^{15}$ thru $PC + 2^{15} - 1$
rd32	= relative expression (32-bit):	$PC - 2^{31}$ thru $PC + 2^{31} - 1$
SIZE	= literal: W (or no suffix) specifies Word operand	
	L specifies Long word operand	
SCALE	= literal: 1	
	2	
	4	
	8	

n/a = not implemented in the older "68000" Workstation Assembler

Expr = expression (relative or absolute)

Ai-Aj/Dm-Dn = List of registers: - means "thru"; / means "and".
The values of i, j, m, and n can range from 0 thru 7.
Examples: A0-A3/D1-D4/A5, and D5-D7/D0/A0

operand = any of the operands allowed with instructions that can operate on "bit fields".

offset = literal or symbol that specifies starting bit of a bit field.

width = literal or symbol that specifies number of bits in a bit field.

Examples: D7{2:3}, and (A0){D1:D2}

Operand Components: Order and Optionality

In the above table, an operand is the whole quantity shown in one column entry. Here are some examples of single operands:

```

AbsExpr1(A1,A2,L)
(AbsExpr2,A1,D3,W*4)
([AbsExpr3,A4],A3,L,AbsExpr4)

```

Thus, some of the components of these operands are AbsExpr1, A1, A2,L, AbsExpr2, D3,W*4, and so forth.

The newer Workstation Assembler allows you to vary the order of these operand components (however, *only* with the new 68020 syntax). Here are some examples of varying the order of operand components (note that all these operands are equivalent):

```
([AbsExpr3,A4],A3,L,AbsExpr4)
([A4,AbsExpr3],A3,L,AbsExpr4)
([A4,AbsExpr3],AbsExpr4,A3,L)
(AbsExpr4,A3,L,[A4,AbsExpr3])
```

The Workstation Assembler also allows you to optionally omit some of the operand components, as shown in the following examples (these operands are *not* equivalent):

```
([AbsExpr1,A1],A5,L,AbsExpr2)
([A1],A5,L,AbsExpr2)
([AbsExpr1],A5,L)
([A1])
(D1)
```

Note that whenever any operand component is omitted, an effective value of 0 is used for that component.

Comments and Comment Lines

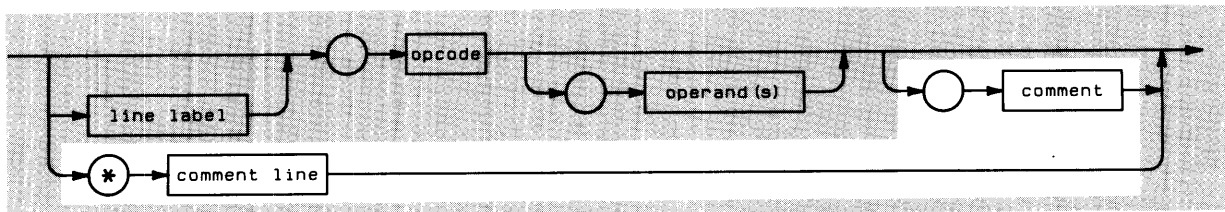

The first space following an operand (or the opcode in an instruction with no operands) terminates it; the remainder of the characters on the line, if any, are regarded as comments.

```
Label ADD D1,D2 This is a comment.
      RTS This is also a comment (since RTS has no operands).
```

An asterisk (*) in column 1 indicates that the entire line is a comment; therefore, any instructions on the line will be ignored.

```
1234567890123456789012345678901234567890
* These are comment lines.
* Add word addressed by A1 to the value of the error counter.
*
```

Notes

MC68881 Floating Point Co-processor Support

This section describes the Motorola MC68881 floating point co-processor support provided by the HP Pascal Workstation Assembler. Note that the support provided by the Assembler is a subset of the co-processor's full capabilities.

Assembler Support of the Co-processor

The co-processor support provided by the Assembler is given in the list below. This list also includes those capabilities not supported.

- All opcodes are supported.
- All sizes and types of operands are supported, with the exception that floating-point constants and immediate operands are restricted as follows:
 - The floating-point literal constant syntax is that defined in the *HP Pascal Language Reference* under "Numbers", such that a period must be present, and the "L" exponent flag is not allowed (i.e. only the "E" exponent is allowed).
 - Only double-precision constants are allowed (i.e. ".D" size suffix).
 - The size suffix ".D" must explicitly be given.
 - All non-zero constants and immediate operands are normalized (i.e. 0.0 and normalized are the only supported IEEE types).
 - Use of floating-point values in expressions is not supported.
- Single-precision division (FSGLDIV) and single-precision multiplication (FSGLMUL) may use any sizes except ".X" and ".D".
- Assembler Pseudo-op DS allocates space in memory for all types and sizes of operands.
- Assembler Pseudo-op DC, which reserves storage space, only supports double-precision operands (i.e. ".D").
- No pseudo-ops (directives) are provided to control the rounding mode, so the default of "round to nearest integer value" occurs.
- No pseudo-ops (directives) are provided to allow use of different co-processors. Therefore, the default co-processor id of 1 is used, which is the MC68881 co-processor.
- The structured "IF" recommended in the MC68881 specification is not supported.

Assembler Pseudo-Op Reference

The following is a list of the commands which direct the assembler to take the described actions. For a list of the Assembler-language and machine-language instructions, see the *MC68000 User's Manual*.

COM

Used to define a global area.

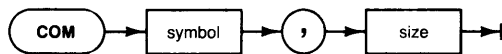

Item	Description	Range Restrictions
symbol	An identifier for the global area	see "Symbols"
size	A numeric expression	-2^{31} thru $2^{31} - 1$

Semantics

The exact location of the global area will be determined at link time. The symbol is DEFINED as an entry point. The amount of space is specified by the absolute value of the expression. If size is negative, the value of the symbol will be the offset from (A5) to the top of the global area and variables will have negative offsets from the symbol. This is how the Compiler does it. If size is positive, the symbol's value will be the bottom of the area, relative to (A5), and offsets will be positive. Only one COM statement allowed per assembly.

DC

Used to define some constant value or values, including string literals, and place them in storage.

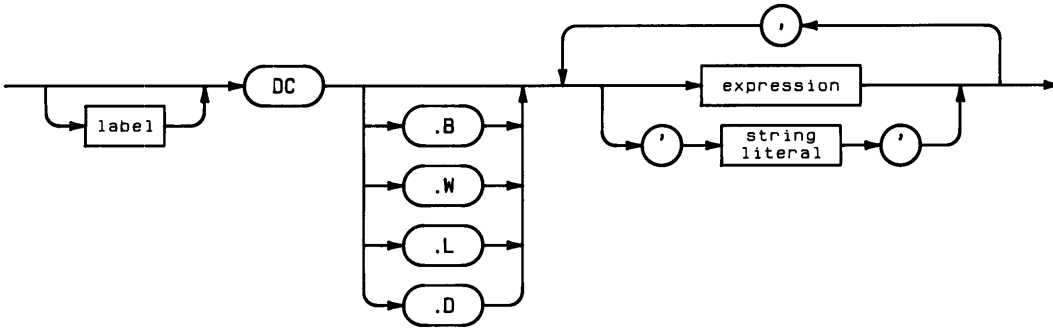

Item	Description	Range Restrictions
label	An identifier for the constant	see "Symbols"
value	An expression that can be evaluated in pass 1	-2^{31} thru $2^{31} - 1$
string literal	A string of characters	The instruction must be contained on one line

Semantics

Size suffixes may be used to specify the units of storage into which the values will be justified for storage. In the case of string literals, the amount of storage needed will be determined by the Assembler and each character will be assigned into a unit.

The ".D" suffix is supported only for the MC68881 floating-point math co-processor.

DECIMAL

Causes addresses in the listing to be printed inn decimal rather than in hex notation.

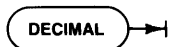

DEF

Defines a label or list of labels as entry points for other modules.

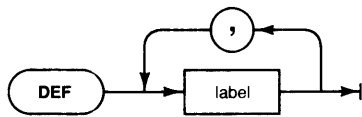

Item	Description	Range Restrictions
label	An entry point identifier	see "Symbols"

DS

Reserves storage space.

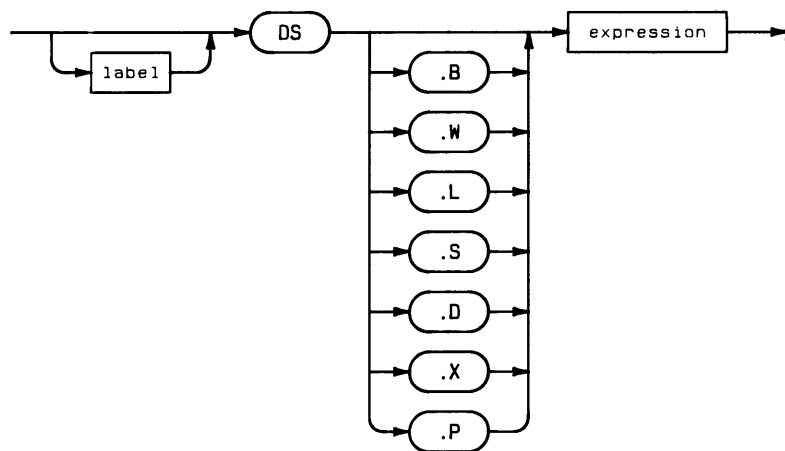

Item	Description	Range Restrictions
label	An identifier for the data space	see "Symbols"
number	An expression that can be evaluated in pass 1	0 thru $2^{31} - 1$

Semantics

The units of space are specified by the size suffix. The number of units is determined by the expression.

The ".S", ".D", ".X", and ".P" are supported only for the MC68881 floating-point math coprocessor.

END

Indicates the end of the assembly. This should be the last line of the assembly.



EQU

Assigns the value and attribute (absolute or relative) of the expression to the label.



Item	Description	Range Restrictions
label	An identifier	see "Symbols"
value	An expression that can be evaluated in pass 1	-2^{31} thru $2^{31} - 1$

INCLUDE

Specifies a file to be merged into the assembly at the point where the instruction is located. The '.TEXT' suffix will be automatically appended to the file name. The INCLUDED file may not contain another INCLUDE.



LLEN

Used to specify the line length (column width) of your printer.

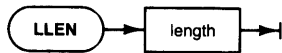

LIST

Turns the printer listing back on. You must have requested a listing when the Assembler was initiated for this to have an effect. LIST is used with NOLIST to exclude blocks of text from the listing.



LMODE

Specifies a symbol or list of symbols to be accessed using long absolute addressing mode. Overrides short addressing and PC-relative mode implications of REFR, ORG, and RORG.

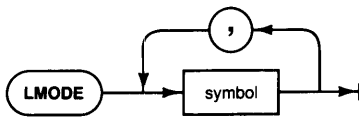

Item	Description	Range Restrictions
symbol	A location identifier	see "Symbols"

LPRINT

(Default) Causes all output from DC statements to be printed. (See SPRINT)



MNAME

Used to assign a name to an Assembler module. The default is to assign the file name to the module.



NOLIST

Turns off the listing until a LIST is encountered.



NOOBJ

Requests that no object code be produced.



NOSYMS

Inhibits the listing of the symbol table at the end of the program.



ORG

Specifies an absolute origin. When used with the “.L” option, it forces long mode addressing for forward and external references. Otherwise short absolute addressing mode is implied.

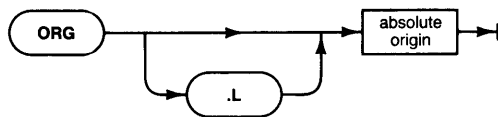

Item	Description	Range Restrictions
absolute origin	A numeric expression that can be evaluated in pass 1	-2^{31} thru $2^{31} - 1$

PAGE

Advances listing to top of next page. This command will not be printed on the listing.



REFA

Defines a symbol or list of symbols as external and absolute references. The size of the effective address is implied by the ORG statement.

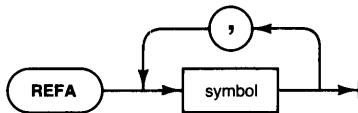

Item	Description	Range Restrictions
symbol	A location identifier	see "Symbols"

REFR

Defines a symbol or list of symbols as external and PC relative references.

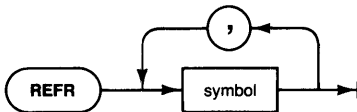

Item	Description	Range Restrictions
symbol	A location identifier	see "Symbols"

RMODE

Specifies a symbol or list of symbols for access using PC-relative addressing. Overrides all other addressing mode specifications.

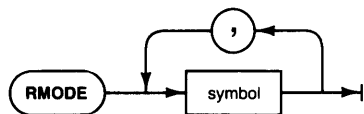

Item	Description	Range Restrictions
symbol	A location identifier	see "Symbols"

RORG

Sets a relocatable origin. Using the 'L' option, forces long absolute addressing mode for forward and external references. Otherwise, PC-relative addressing mode is implied for forward references and short absolute addressing mode for REFA symbols.

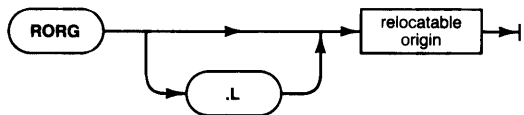

Item	Description	Range Restrictions
relocatable origin	a numeric expression that can be evaluated in pass 1	-2^{31} thru $2^{31} - 1$

SMODE

Specifies a symbol or list of symbols to be accessed using short absolute addressing mode. Overrides all other addressing mode specifications.

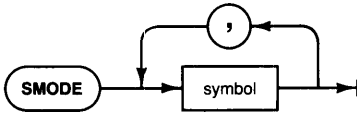

Item	Description	Range Restrictions
symbol	A location identifier	see "Symbols"

SPC

Directs the assembler to generate the specified number of blank lines. Used to separate blocks of code or blocks of comments on the listing.

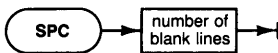

SPRINT

Print only the first line of output for the DC statements. Otherwise, each word used to store the constant is printed.



SRC

Used to specify the `IMPORT` text information which the Compiler needs when importing the module. Use one `SRC` for each line of `IMPORT` text. (see programming section)

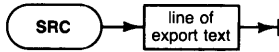

START

Specifies a start location for execution of the main program. Use only in the main program.

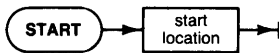

Item	Description	Range Restrictions
start location	An integer numeric or symbolic expression	-2^{31} thru $2^{31} - 1$

TTL

Specifies a title to appear on each page of the assembler listing.

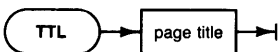

The Examples

Listings of the two programs and two modules are given here and also have been provided on the documentation disc (DOC:). On the disc they are provided in source and object form. The file (ASMB_P1) imports the file (ASMB_M1). These are both Pascal files. The Pascal file (ASMB_P2) imports the Assembler language file (ASMB_M2).

If you want to see them work, you must either use the Librarian to link the modules to the programs, P-load the modules, or put the modules in the current System Library. You can then execute the two programs.

The Sample Pascal Programs

This Program Imports the Pascal Module

```
$search /*3:ASMB_M1
Program test(input,output);
Import simple;
var i,j,k : rec;
begin
  initialize;
  i.i1:=1; i.i2:=2;
  j.i1:=3; j.i2:=4;
  add(i,j,k);
  writeln(k.i1,k.i2)
end.
```

This Program Imports the Assembly Module

```
$search /*3:ASMB_M2
Program test(input,output);
Import simple2;
var i,j,k : rec;
begin
  initialize;
  i.i1:=1; i.i2:=2;
  j.i1:=3; j.i2:=4;
  add(i,j,k);
  writeln(k.i1,k.i2)
end.
```

The Sample Pascal Module

```

$sysProc$      (*to enable try-recover*)

module simple;
export
  type
    rec = record
      i1: integer;
      i2: integer;
    end;
  const
    zero = rec [i1:0,i2:0];
  var
    lastresult: rec;

  Procedure initialize;
  Procedure add (a,b: rec; var out: rec);

implement
  var
    sum: rec;

  Procedure initialize;
  begin sum := zero end;

  function Partadd (x,y: integer): integer;
  var temp: integer;
  begin
    temp := x+y;
    if temp < 0 then escape(100);
    Partadd := temp;
  end; (*Partadd*)

  Procedure add (a,b: rec; var out: rec);
  begin
    try
      lastresult.i1 := Partadd(a.i1,b.i1);
      lastresult.i2 := Partadd(a.i2,b.i2);
      sum.i1 := sum.i1+lastresult.i1;
      sum.i2 := sum.i2+lastresult.i2;
      out := lastresult;
    recover
      if escapecode = 100
      then lastresult := zero
      else escape(escapecode);
  end; (*add*)

end.

```

The Disassembly of the Module

Librarian [Rev. 2.0 19-Oct-82] 19-Oct-82 9: 7:14 page 1

```

MODULE SIMPLE Created 8-Oct-82
NOTICE: (none)
Produced by Pascal Compiler of 20-Sep-82
Revision number 2
Directory size 172 bytes
Module size 3072 bytes
Module NDT executable
Code base 0 Size 254 bytes
Global base 0 Size 16 bytes
EXT block 5 Size 20 bytes
DEF block 3 Size 114 bytes
EXPORT block 1 Size 192 bytes
There are 1 TEXT records

```

```

TEXT RECORD # 1 of 'SIMPLE':
TEXT start block 2 Size 254 bytes
REF start block 4 Size 42 bytes
LOAD address Rbase

```

0	0000	dc.w 0	or dc.b 0,0	or dc.b ' '
2	0000	dc.w 0	or dc.b 0,0	or dc.b ' '
4	0000	dc.w 0	or dc.b 0,0	or dc.b ' '
6	0000	dc.w 0	or dc.b 0,0	or dc.b ' '
8	0000	dc.w 0	or dc.b 0,0	or dc.b ' '
----- SIMPLE_INITIALIZE				
10	4E41 0000	trap #1,#0		
14	4CBA 0F00	movem.w Rbase,a0-a3		
	FFEE			
20	4BAD 0F00	movem.w a0-a3,Gbase-16(a5)		
	FFF0			
26	4E5E	unlk a6		
28	4E75	rts		
30	0000	dc.w 0	or dc.b 0,0	or dc.b ' '

32	4E41 FFFC	trap #1,#-4		
36	202E 000C	move.l 12(a6),d0		
40	D0AE 0008	add.l 8(a6),d0		
44	4E76	trapv		
46	2D40 FFFC	move.l d0,-4(a6)		
50	4AAE FFFC	tst.l -4(a6)		
54	6C00 000A	bge Rbase+66		
58	3B7C 0064	move.w #100,SYSGLOBALS-2(a5)		
	FFFE			
64	4E4A	trap #10		
66	2D6E FFFC	move.l -4(a6),16(a6)		
	0010			
72	4E5E	unlk a6		
74	205F	movea.l (sp)+,a0		
76	504F	addq.w #8,sp		
78	4ED0	jmp (a0)		
80	0000	dc.w 0	or dc.b 0,0	or dc.b ' '

```

-----
                                     SIMPLE_ADD
82  4E41 FFF0      trap #1,#-16
86  206E 0010      movea.l 16(a6),a0
90  2D58 FFF0      move.l (a0)+,-16(a6)
94  2D50 FFF4      move.l (a0),-12(a6)
98  206E 000C      movea.l 12(a6),a0
102 2D58 FFF8      move.l (a0)+,-8(a6)
106 2D50 FFFC      move.l (a0),-4(a6)
110 2F2D FFF6      move.l SYSGLOBALS-10(a5),-(sp)
114 2F0E          move.l a6,-(sp)
116 487A 005A      Pea Rbase+208
120 2B4F FFF6      move.l sp,SYSGLOBALS-10(a5)
124 598F          subq.l #4,sp
126 2F2E FFF0      move.l -16(a6),-(sp)
130 2F2E FFF8      move.l -8(a6),-(sp)
134 4EBA FF98      jsr Rbase+32
138 2B5F FFF8      move.l (sp)+,Gbase-8(a5)
142 598F          subq.l #4,sp
144 2F2E FFF4      move.l -12(a6),-(sp)
148 2F2E FFFC      move.l -4(a6),-(sp)
152 4EBA FF86      jsr Rbase+32
156 2B5F FFFC      move.l (sp)+,Gbase-4(a5)
160 202D FFF8      move.l Gbase-8(a5),d0
164 D1AD FFF0      add.l d0,Gbase-16(a5)
168 4E76          trapv
170 202D FFFC      move.l Gbase-4(a5),d0
174 D1AD FFF4      add.l d0,Gbase-12(a5)
178 4E76          trapv
180 206E 0008      movea.l 8(a6),a0
184 4CAD 1E00      movem.w Gbase-8(a5),a1-a4
      FFF8
190 4890 1E00      movem.w a1-a4,(a0)
194 2B6F 0008      move.l 8(sp),SYSGLOBALS-10(a5)
      FFF6
200 DEFC 000C      adda.w #12,sp
204 4EFA 0024      jmp Rbase+242
208 2C5F          movea.l (sp)+,a6
210 2B5F FFF6      move.l (sp)+,SYSGLOBALS-10(a5)
214 7064          moveq #100,d0
216 B06D FFFE      cmp.w SYSGLOBALS-2(a5),d0
220 6600 0012      bne Rbase+240
224 4CBA 0F00      movem.w Rbase,a0-a3
      FF1C
230 48AD 0F00      movem.w a0-a3,Gbase-8(a5)
      FFF8
236 6000 0004      bra Rbase+242
240 4E4A          trap #10
242 4E5E          unlk a6
244 205F          movea.l (sp)+,a0
246 DEFC 000C      adda.w #12,sp
250 4ED0          jmp (a0)
252 4E75          dc.w 20085      or dc.b 78,117      or dc.b 'Nu'

```

The Assembly Language Module

```

mname simple2

src module simple2;
src export
src type
src     rec = record
src     i1 : integer;
src     i2 : integer;
src     end;
src     const
src     zero = rec[i1:0,i2:0];
src     var
src     lastresult : rec;
src     procedure initialize;
src     procedure add(a,b : rec;
src                 var out : rec);
src end;

com simple2,-16

def simple2_add
def simple2_initialize
def simple2_zero,simple2_simple2

refa sysglobals

lastresult      equ simple2-8
lastresult_i1   equ simple2-8
lastresult_i2   equ simple2-4
sum              equ simple2-16 (all are relative to a5)
sum_i1          equ simple2-16
sum_i2          equ simple2-12
escapecode      equ sysglobals-2
recover_rec     equ sysglobals-10

rorg 0

simple2_zero     dc.l  0,0

simple2_initialize trap #1      (stack check)
                dc.w  0      (no local space)

                movem.l simple2_zero,a0-a1

                movem.l a0-a1,sum(a5)

                unlk a6
                rts

simple2_partadd  trap #1
                dc.w  -4

result         equ 16
x              equ 12
y              equ 8      (all are relative to a6)
ret_addr       equ 4

```

```

dyn_link      equ 0
temp          equ -4

        move.l x(a6),d0 (temp:=x+y)
        add.l y(a6),d0
        trapv (overflow check)
        move.l d0,temp(a6)

        tst.l temp(a6) (if temp<0)
        bge Past_escape
        move #100,escapecode(a5)

        trap #10 (then escape 100)

Past_escape  move.l temp(a6),result(a6)

*
                (Partadd:=temp)

        movea.l ret_addr(a6),a0
        unlk a6
        adda.l #12,sp

        jmp (a0)

simple2_add    trap #1 (stack check)
                dc.w -16 (for param copies)

a_addr       equ 16
b_addr       equ 12
out_addr     equ 8
ret_addr2    equ 4
dyn_link2    equ 0 (relative to a6)
b_i2_copy    equ -4
b_i1_copy    equ -8
a_i2_copy    equ -12
a_i1_copy    equ -16

        movea.l a_addr(a6),a0 (making local
        move.l (a0)+,a_i1_copy(a6) copies)
        move.l (a0),a_i2_copy(a6)
        movea.l b_addr(a6),a0
        move.l (a0)+,b_i1_copy(a6)
        move.l (a0),b_i2_copy(a6)

        move.l recover_rec(a5),-(sp) (TRY)
        move.l a6,-(sp)
        pea recover_addr
        move.l sp,recover_rec(a5)

        subq.l #4,sp (calling Partadd)
        move.l a_i1_copy(a6),-(sp)
        move.l b_i1_copy(a6),-(sp)
        jsr simple2_Partadd
        move.l (sp)+,lastresult_i1(a5)

        subq.l #4,sp (calling Partadd)
        move.l a_i2_copy(a6),-(sp)

```

```

move.l b_i2_copy(a6),-(sp)
jsr simple2_partadd
move.l (sp)+,lastresult_i2(a5)

move.l lastresult_i1(a5),d0 (sum:=
add.l d0,sum_i1(a5) sum+lastresult)
trapv
move.l lastresult_i2(a5),d0
add.l d0,sum_i2(a5)
trapv

movea.l out_addr(a6),a0
movem.l lastresult(a5),a1-a2

movem.l a1-a2,(a0) (out:=lastresult)

move.l B(sp),recover_rec(a5)

adda.l #12,sp (end of TRY)

JMP Past_recover

recover_addr movea.l (sp)+,a6 (RECOVER)
move.l (sp)+,recover_rec(a5)
moveq #100,d0 (if escapecode=100)
cmp.w escapecode(a5),d0
bne sys_error
movem.l simple2_zero,a0-a1

* (then lastresult:=0)
movem.l a0-a1,lastresult(a5)

bra Past_recover
sys_error trap #10 (else escape)

Past_recover unlk a6
movea.l (sp)+,a0
adda.l #12,sp

JMP (a0)

simple2_simple2 rts (initialization body)

end

```

*** 68000 ASSEMBLER SYMBOL TABLE DUMP ***

EXTERNAL SYMBOLS

SYMBOL	TYPE	DEF	VALUE
SIMPLE2	ABS	19	00000001
SYSGLOBALS	ABS	25	00000002

INTERNAL SYMBOLS

SYMBOL	TYPE	DEF	EQU SYM	VALUE
A0	AREG	0		00000000
A1	AREG	0		00000001
A2	AREG	0		00000002
A3	AREG	0		00000003
A4	AREG	0		00000004
A5	AREG	0		00000005
A6	AREG	0		00000006
A7	AREG	0		00000007
A_ADDR	ABS	80		00000010
A_I1_COPY	ABS	88		FFFFFFF0
A_I2_COPY	ABS	87		FFFFFFF4
B_ADDR	ABS	81		0000000C

B_I1_COPY	ABS	86		FFFFFFF8
B_I2_COPY	ABS	85		FFFFFFFC
CCR	STREG	0		00000005
D0	DREG	0		00000000
D1	DREG	0		00000001
D2	DREG	0		00000002
D3	DREG	0		00000003
D4	DREG	0		00000004
D5	DREG	0		00000005
D6	DREG	0		00000006
D7	DREG	0		00000007
DYN_LINK	ABS	56		00000000
DYN_LINK2	ABS	84		00000000
ESCAPECODE	ABS	33	SYSGLOBALS	+ FFFFFFFE
LASTRESULT	ABS	27	SIMPLE2	+ FFFFFFF8
LASTRESULT_I1	ABS	28	SIMPLE2	+ FFFFFFF8
LASTRESULT_I2	ABS	29	SIMPLE2	+ FFFFFFFC
OUT_ADDR	ABS	82		00000008
PAST_ESCAPE	REL	69		0000003E
PAST_RECOVER	REL	140		000000F4
RECOVER_ADDR	REL	129		000000D2
RECOVER_REC	ABS	34	SYSGLOBALS	+ FFFFFFF6
RESULT	ABS	52		00000010
RET_ADDR	ABS	55		00000004
RET_ADDR2	ABS	83		00000004
SIMPLE2_ADD	REL	77		00000052
SIMPLE2_INITIALIZE	REL	40		00000008
SIMPLE2_PARTADD	REL	49		0000001C
SIMPLE2_SIMPLE2	REL	145		00000100
SIMPLE2_ZERO	REL	38		00000000
SP	AREG	0		00000007
SR	STREG	0		00000006
SUM	ABS	30	SIMPLE2	+ FFFFFFF0
SUM_I1	ABS	31	SIMPLE2	+ FFFFFFF0
SUM_I2	ABS	32	SIMPLE2	+ FFFFFFF4
SYS_ERROR	REL	138		000000F2
TEMP	ABS	57		FFFFFFFC
USP	STREG	0		00000007
X	ABS	53		0000000C
Y	ABS	54		00000008

The Librarian

Chapter**8**

Introduction

It may seem obvious that the Librarian's purpose is to manage libraries. However, all the things that it can do to fulfill this responsibility may not be as obvious. This chapter will help to put all of the Librarian's capabilities into perspective. The chapter first describes libraries and object modules, providing some relevant background information that will help you to understand the Librarian operations described in the latter sections of the chapter.

Here is a brief overview of the operations you can perform with the Librarian:

- Add object modules to or remove them from libraries. For instance, you can add object modules to the System Library so that the modules will be found and loaded automatically when any program that imports them is loaded for execution.
- Link the directories of the object modules in a library file. This operation reduces the file's size.
- Obtain detailed information about the object modules in a library file. For instance, you can unassemble a compiled Pascal object file and get the Assembler language object code. The Librarian can disassemble all instructions for the MC68000 family of processors, as well as MC68881 math co-processor instructions.
- Create new system Boot files. This operation is used to create files that are found and loaded by the Boot ROM and in turn load a system.

Let's look more closely at library files, what is in them, and how to use them.

Prerequisites

This chapter presents simple examples of user modules and libraries. If you find that you want more information about modules as you read this chapter, read the sections of the Compiler and Assembler chapters that describe modules.

If you are going to be using the Librarian for purposes other than adding modules to and removing them from the System Library (usually LIBRARY) or Initialization Library (BOOT:INITLIB), then you should also be familiar with the concepts presented in the Assembler chapter.

Library Overview

This section presents some important terms and concepts you will need to know in order to understand libraries. It will help you see when and why you will need to use the Librarian.

Modules and Libraries

Libraries are object files. They contain zero or more *object modules*. Object modules are the product of the Compiler or Assembler¹. For instance, compiling a Pascal source module generates an object module which is placed in an object file. This file is actually a library, because it contains an object module.

An object file is composed of a *directory* of the module(s) that it contains, followed by the object modules themselves. Here is a pictorial representation of an object file.

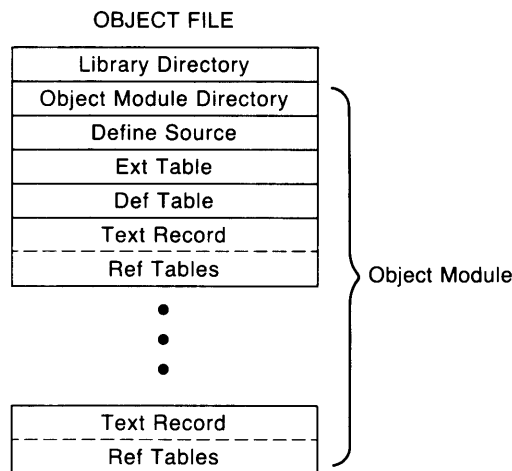

The terms Define Source, Ext Table, and so forth are defined in the Glossary of Object Code Terminology at the end of the chapter.

What the Librarian Does

The Librarian's purpose is to manage object modules. The Librarian can also produce object files; however, these files consist of object modules produced by the Compiler or Assembler. It can create library files and add modules to them or remove modules from them. The intent of these libraries is to provide a convenient location to store object modules. The following drawing shows the relationship of object modules in an object file (library):

¹ Complete descriptions of how to produce and use Pascal and Assembler modules are provided in the Compiler and Assembler chapters.

The example program imports ModuleTwo, which declared the procedure named TwoLines. Here is the source of ModuleTwo, which was compiled and stored in the library (object-code) file named MOD_2.CODE.

Source Listing of MOD_2.CODE

```

MODULE ModuleTwo;

IMPORT ModuleThree;

EXPORT
  PROCEDURE TwoLines;

IMPLEMENT

  PROCEDURE TwoLines;
  BEGIN
    WRITELN('I came from ModuleTwo and brought this:');
    ThirdLine;
  END;

END.
```

ModuleTwo exports procedure TwoLines, which is used by ProgramOne. It also imports ModuleThree, which declares procedure ThirdLine and is in the library (object-code) file named MOD_3.CODE.

Source Listing of MOD_3.CODE

```

MODULE ModuleThree;

EXPORT
  PROCEDURE ThirdLine;

IMPLEMENT

  PROCEDURE ThirdLine;
  BEGIN
    WRITELN('I came from ModuleThree');
  END;

END.
```

This module exports procedure ThirdLine, which is imported by ModuleTwo. Notice that it does not import any modules.

Here are the results of running the program.

```

***** ProgramOne *****
I came from ModuleTwo and brought this:
I came from ModuleThree
***** ProgramOne *****
```

Here is what happens when you run ProgramOne. First, ProgramOne prints two blank lines and then the line of asterisks that contains its name. The procedure TwoLines, imported from ModuleTwo, is then called; it prints the message: `I came from ModuleTwo and brought this:.` Procedure ThirdLine, imported from ModuleThree, is then called; it prints the message: `I came from ModuleThree.` Control is then returned to TwoLines and then to the program, which again prints out its name in asterisks.

Let's take a look at what is needed in order for you to compile and run the program.

Compiling and Running the Example Program

When a program (or module) imports modules, the imported modules must be accessible at two times:

- When the program is compiled.
- When the program is loaded and run.

Let's take a look at what happens at these two times.

How the Compiler Finds Imported Modules

At compile time, the Compiler searches for each module imported by the source program (or module); more specifically, it searches to find each module's "interface text." Here is the order of the places where the Compiler looks in search of interface text:

1. In the source text being compiled. (The source text of modules and programs can be combined into one source file, as long as the modules precede the program and are in proper sequence.)
2. In object files specified in a SEARCH Compiler option.
3. In the object file currently designated as the System Library.

(A module's interface text consists of the MODULE name, the IMPORT section, if present, and EXPORT section; these sections are part of the object module produced when the module was compiled or assembled. See the subsequent section called Getting Detailed Object File Information and the Compiler or Assembler chapters for a more complete description of interface text.)

Here is a strategy (and the method actually used) for compiling these source modules and program. (Note that you will be learning these Librarian operations in the subsequent examples given in this chapter, so you will probably want to perform this compilation exercise *after* working through the examples using the object modules and program).

1. Compile ModuleThree first (MOD_3.TEXT); call it MOD_3.CODE for simplicity. Since this module does not import any others, it will be compiled with no need to search for any imported module's interface text.
2. Use the Librarian to add the resultant object module (MOD_3.CODE) to the library file currently designated as the System Library. (Actually, you will be creating a new library into which you will place ModuleThree and the modules in the current System Library; this type of operation is subsequently explained in this chapter.)
3. After merging these two libraries (into a third new library), you will need to do one of two things: use the What command to make the resultant library the System Library; or use the Filer to change the resultant library's name back to the name of the current System Library.
4. Next, compile ModuleTwo (MOD_2.TEXT); call it MOD_2.CODE. The external references to ModuleThree will be resolved when the Compiler finds the object ModuleThree in the System Library.
5. Then place this compiled module in the System Library as in steps 2 and 3.
6. Compile the program (PROG_1.TEXT). Since both object modules upon which this program depends are in the System Library, they will be accessed automatically by the Compiler when the program is compiled.
7. Run the program. The loader automatically looks in the System Library in order to resolve the external references; it loads the modules required to complete the program (in this case, ModuleTwo and ModuleThree).

Since the program and modules have already been compiled and the object files placed on the DOC: disc, we will not discuss other alternatives of making the source files accessible to the Compiler. (However, you are again encouraged to do this after learning how to use the Librarian.)

Let's look now at how the loader finds imported object modules when the program is to be loaded for execution.

How the Loader Finds Imported Modules

Since a compiled program contains no record of where the Compiler found the imported modules, the loader must find the imported object modules at load time. Here is the order of the places where the loader looks:

1. Modules that are part of the object file being loaded.
2. In modules already P-loaded in memory, which includes all INITLIB and Operating System modules. (The loader searches for these modules in reverse order to which they were P-loaded; in other words, the most-recently loaded modules are searched first.)
3. In the current System Library file.

In order to make all imported modules part of the object file that uses them (alternative 1 above), you have two choices:

- Combine the source modules into one *source* file (and compile it). You can use the Editor to add each imported module's source file to the source program. You can also use an INCLUDE Compiler option in the source program to include each imported module's source file in the compilation of the program.
- Combine the object modules into one *object* file. Use the Librarian to combine the program and imported modules into one object file; you can optionally Link the modules to save space.

With both of these methods, only the file containing the program need be loaded; and when the program is finished, the memory used by the modules can be reclaimed for other purposes. With P-loaded modules, this is not possible (without re-booting).

If you want to P-load modules to make them accessible to the loader, you will only need to P-load all modules which are not in one of the three places stated above. In the example modules already given, ProgramOne imports ModuleTwo, and ModuleTwo imports ModuleThree. In the second example that follows, you will be creating a library that contains these two modules and then P-loading the library. (You can alternatively P-load MOD_3.CODE and MOD_2.CODE, in that order, which does not require use of the Librarian.) The loader will then be able to link the modules contained in the library to any program that imports them at execution time.

In general, the most convenient way to use modules is to place them in the file that is currently designated as the "System Library," which is the third alternative shown above. (The default System Library is the file named "LIBRARY" found on the system volume at power-up. You can also change it with the What command and the Main Command Level.) This is probably the most common reason for using the Librarian. In the first example that follows, you will add modules ModuleTwo and ModuleThree to the LIBRARY file and then run the program.

Subsequent tutorials also describe unassembling these library files and creating system Boot files.

Entering the Librarian

The Librarian is provided on the ACCESS: disc shipped with the system. To use the Librarian, you will first need to put it on-line: either place the disc labeled ACCESS: in a drive, or copy the LIBRARIAN file to another location (such as a hard disc) and use the What command (at the Main Command Level) to specify this copy as the system Librarian. After doing either of these, pressing directs the system to load and execute the Librarian program.

Here is the Librarian's main prompt:

```
Librarian [Rev. 3.0 15-APR-84]          15-APR-84  8:11:58

Q Quit
P Printout OFF PRINTER:LINK.ASC
O      Output file: (none)
B write to Boot disk
H file Header maximum size:          38

I      Input file: (none)

Copyright 1984 Hewlett-Packard Company.
command?
```

The commands shown on the left-hand side of the screen are invoked by pressing the corresponding key. You will see how to use all of them in the following tutorial discussions. All commands are summarized in the Librarian Command Reference.

Setting Up Mass Storage

You will often need two on-line mass storage volumes when using the Librarian. If you only have one volume in your system, you may need to set up a memory volume. This discussion tells why two volumes may be needed and then outlines how to estimate the size of the volumes required.

When you combine the object modules in two libraries using the Librarian, you actually create a third (new) library and then copy into it the desired modules from the other two libraries. For instance, suppose that you want to add the CONFIG:RS232 module to the BOOT:INITLIB library file. You will first create a new library, and then add the existing INITLIB modules and the RS232 module to this new library. This new library must *not* be taken off-line during the entire process.

Thus, two separate volumes are often necessary for these two reasons:

- The sum of *all* source libraries plus the new destination library often exceeds the capacity of one volume.
- The destination volume must *not* be taken off-line during this entire operation.

Continuing with the preceding example, suppose that you have only one mini-disc drive on-line (the capacity is approximately 1050 sectors). The operation cannot usually be completed, because one mini disc is not large enough to contain the modules in the INITLIB file (let's assume 750 sectors), the RS232 module (approximately 25 sectors), and the new INITLIB file (*roughly* the sum of 750 and 25 sectors). You will need two volumes for the process.

If you don't have two disc drives (or one with sufficient space), you can create a memory volume. It is usually more convenient to use the memory volume as the destination volume. In this case, you could create one with a specified size of 400 blocks, or 200 Kbytes. (Remember that memory volume blocks are 512 bytes each, while mini-disc sectors are 256 bytes each.) See the Memvol command in the Overview chapter for more specific details on creating memory volumes.

The following examples assume that either you have two disc volumes on-line or that you have created a memory volume of sufficient size. For these examples, a memory volume of 100 blocks is sufficient.

Creating Libraries of Object Modules

To create libraries, you can combine either modules provided by HP or your own modules, or any combination of the two. Let's first look at adding modules to the System Library file.

Adding Modules to the System Library

A common way to use library modules is to add them to the current System Library file. Let's assume that it is the file named LIBRARY for present purposes, although you can change it to any file by using the What command at the Main Command Level. The procedure used to add modules to LIBRARY is very similar to that of storing modules in a user library, which is the next example.

Here is a brief summary of the steps required: first, make a new library file, and copy into it all of the modules currently in LIBRARY; next, add ModuleThree and ModuleTwo to the new file (in this case the order of modules is arbitrary, since the loader will load them in the right order); then replace the LIBRARY file with this new library; execute the program, and the modules are loaded automatically for you. The actual procedure is given below.

1. Invoke the Librarian. This is done by pressing **L** from the Main Command Level. (If the Librarian is not on-line, insert the ACCESS: disc and try again. Remove the ACCESS: disc once the Librarian has loaded.) Now use the Librarian to create the new library.
2. Put the SYSVOL: disc (or the one containing the LIBRARY file) in the #3 drive. Press **I** and then type #3:LIBRARY., and press **Return** or **ENTER** to enter the Input file. You must include a trailing period to prevent the Librarian from appending the .CODE suffix.

When the Librarian finds the Input file, the display will show the name of the first module in the file. (You should see the module named RND if you have not yet modified the LIBRARY file.) If you have a printer, you can press **F** to list all of the modules in the Input library.

3. (For this example, we will assume that you are using unit #4 as the second volume; however, if the LIBRARY file is small enough, you can also put the new library file on drive #3. We will also assume that the destination volume has enough room for the new library file.)

Press **O** and enter #4:NEWLIB., as the Output file. Again, a trailing period prevents the .CODE suffix from being appended to the file name. If you are using a memory volume, use the unit number of the memory volume.

(If you are using a disc, this disc must *not* be removed until you have finished creating the new NEWLIB file.)

4. Press **E** to enter the Edit mode. You should now see this prompt (in the middle of the screen):

```
F  First module: RND
U  Until module: (end of file)
```

5. You can now transfer all modules in the Input file to the Output file, including the last module, by pressing **C** (for Copy).
6. When the preceding transfer is complete, press **A** to append a module to the NEWLIB Output file. The Librarian prompts with `Input file:.` Put the DOC: disc, or whichever disc now contains ModuleThree, in Unit #3 (*not* #4, which must **not** be removed). Enter #3:MOD_3 as the Input file.

7. The Librarian now prompts with `Enter list of modules or = for all.` Enter `= for all.` After `ModuleThree` has been transferred to the `NEWLIB` library, the Librarian prompts with `APPend done, <space> to continue.` Press the spacebar to clear the prompt.

Now use steps 6 and 7 again to copy `ModuleTwo` (in file `MOD_2.CODE`) into the `NEWLIB` file.

8. Now that all modules have been added to the `NEWLIB` file, press `S` to stop editing and `K` to keep the file.
9. You should now verify that the modules were indeed copied to the Output file. Press `I` and enter `*4:NEWLIB,` as the Input file. Press the spacebar repeatedly to scan through the modules in the new library file. If you have a printer, press `F` to get a File Directory listing.
10. If all modules are present, then press `Q` to Quit the Librarian.
11. Now you have one of two options to make this library the System Library: you can use the `What` command at the Main Level to specify the file named `NEWLIB` (on the destination volume) to be the System Library; or you can replace the `LIBRARY` file on the `SYSVOL:` disc with this file. If you choose the second option, it is probably better to keep the current copy of `LIBRARY` on the disc; you should first Change its name to something like `OLDLIB` and then Filecopy the `NEWLIB` file onto the `SYSVOL:` disc, changing its name to `LIBRARY`.
12. Make sure that the System Library file is on-line, and then eXecute or Run the program.

As the program is loaded, the imported modules will also be loaded automatically. Here are the results of running the program.

```
***** ProgramOne *****
I came from ModuleTwo and brought this:
I came from ModuleThree
***** ProgramOne *****
```

After the program has completed execution, the memory used by both program and modules can be used for other purposes.

As you can see, the System Library is a special library of object modules that is automatically accessed by the linking loader at program execution time (and by the Compiler at compile time). Because of this automatic access, you do not need to use the `Permanent-load` command to access this library's contents. This library would normally store those modules often used in your programs. Further descriptions of using HP-supplied libraries are given in the *Pascal 3.0 Procedure Library* and *Pascal 3.0 Graphics Techniques* manuals.

Making Your Own Library

Since we created a library that contains the modules named `ModuleTwo` and `ModuleThree` in the preceding example, you already know what is required to make your own library. The only difference is that you will not be adding the current `LIBRARY` modules to your library.

Here is a brief summary of the steps you will take in this example: first, create a new library with the Librarian and add the example modules `ModuleTwo` and `ModuleThree` to it (as with the last example, the order of modules is arbitrary; since they are in one file, the loader will take care of loading them in the proper order); P-load this library; and execute or run the program. A more detailed procedure follows.

Note

During the transfer process, you must **not** move the destination disc (the one that contains the Output file).

1. From the Main Command Level, press to enter the Librarian. Your screen should now display the Main Prompt for the Librarian.
2. Put the destination disc in drive #4. Then press , and type `#4:USERLIB` and press or to enter the Output file specification.
3. Place the DOC: Disc into the #3: disc drive. Then press , and enter `#3:MOD_3` as the Input file specification. You will see `MOD_3.CODE` displayed as the Input file. The first object module found in the object file, `MODULETHREE`, is also displayed. The computer is in Copying mode as shown by the word `COPYING` on the prompt.
5. Transfer the object module `MODULETHREE` using the T command. Since `MODULETHREE` is the only module in that file, the A command would have done the same job.
6. Repeat steps 4 and 5 to name `MOD_2` as the Input file and Transfer the object module `MODULETWO` into your new library.
7. If you had other modules to transfer, you would repeat steps 4 and 5 as needed.
8. Press to Keep the new file on the destination volume.
9. Press to Quit the Librarian and return to the Main Command Level.
10. If you P-loaded these modules as you worked through the preceding example, then you need to re-boot in order to fully test your new library (to ensure that the modules P-loaded in the preceding example aren't accessed instead).
11. Press for the Permanent-load command. You will be prompted: `Load what code file ?` Enter `#4:USERLIB` (you don't need a period if you didn't include one when you specified this file as the Output file).
12. Now press to eXecute `ProgramOne`. Answer the `Execute what file?` prompt by entering `#3:PR0G_1` as the file specification.

The results of the executed program are shown below.

```
***** ProgramOne *****
I came from ModuleTwo and brought this:
I came from ModuleThree
***** ProgramOne *****
```

As mentioned earlier, you could also have separately P-loaded ModuleThree and ModuleTwo, in that order, and then run the program. Or, as with the preceding example, you could also have added these modules to the System Library. You could also have used What at the Main Command Level to specify this library as the System Library. The method you use depends on factors such as these: whether you are developing and testing the modules; whether you are also using other modules in the System Library; who will be using the modules; and so forth.

Linking Object Files Together

The Librarian permanently links modules together by combining their module directories into a single directory. To see this process in action, you will be linking the two example modules and the example program together.

1. Put the ACCESS: disc in a drive and press to run the Librarian.
2. Put the DOC: disc in the #3 drive. Press , and then type #3:TEST_1 and press or to enter the Output file specification. #3:TEST_1.CODE will be our linked library's name; #3:TEST_1.CODE is now displayed as the Output file. When an Output file is named, the menu replaces the B and H command prompts with the "L Link" prompt. The Librarian also enters the COPYING mode.
3. Enter the LINKING mode by pressing . This is the first step in the two-step linking process. Your screen now displays a new command prompt, as shown below.

```

Librarian [Rev. 3.0 15-APR-84]                1-Jun-84 8:05:08

Q Quit
P Printout OFF PRINTER:LINK.ASC
O      Output file: TEST_1.CODE
C Copy                                     LINKING
N Name of new module: (none)
R Relocation base:           0
G Global base:               0
S Space for patches:
D output Def table? YES
X copyright notice:

I      Input file: (none)

command?

```

4. Press and enter NEWNAME as the new module name. If you did not do this, the object module contained in the new object file, TEST_1.CODE, would be the module name of the first module transferred. To avoid confusion, use "NEWNAME".
5. Press and enter #3:PROG_1 as the Input file. (The ".CODE" suffix is automatically appended to the Input file's name.) PROG_1.CODE is now the Input file.
6. Press to transfer all object modules contained in PROG_1.CODE into TEST_1.CODE. Since PROG_1.CODE contains only one module, would have done the same job.
7. Repeat steps 5 and 6 to transfer MOD_2.CODE and MOD_3.CODE. When all files are transferred, final linking must be done.
8. Press to complete the linking process. This is the second step in the linking process. Remember that **all** object modules must be on-line when you complete the linking process.
9. Press to Keep the new file, and press to Quit the Librarian and return to the Main Command Level.

To see that everything works, execute your new program. From the Main Command Prompt press , and then enter TEST_1 as the file specification. The ".CODE" is automatically added to the file name. Your screen should now display the the following:

```
***** ProgramOne *****
I came from Module_2 and brought
I camd from Module_3
***** ProgramOne *****
```

The benefit gained over merely combining modules into one library is that linking modules together reduces the amount of space required to store the library.

Subtle Points about Linking

There are several subtle side effects that occur when modules are linked that should be discussed here.

- When you link object modules, the interface text is removed. Thus, linked modules **cannot** be searched by the Compiler when it is attempting to satisfy IMPORT statements; however, these modules can be used by other modules at load time by P-loading them or placing them in the System Library. (Remember that you can also keep a copy of the unlinked object module which can, of course, be imported by other modules at compile time.)
- The linking process always produces relocatable object code. This code has been relocated to the values specified by Global base and Relocatable base, but it will be relocated again when it is loaded for execution. For this reason, you don't need to specify Global base and Relocatable base – just leave them zero.

- If two or more programs are linked together into one object file, the resultant file contains code with only *one* start address (rather than the two that you began with). Contrast this to the situation in which you put two programs in an object file; when this file is executed, the two programs get executed separately in the order encountered in the file. This is the reason that you cannot link the INITLIB modules together; it is actually a set of programs and modules in a library file.
- After linking, most programs will still have unsatisfied external references (such as calls to the File System read and write routines). These unsatisfied references do not cause error messages; they are satisfied by the linking loader as the program is prepared for execution. These system routines are not part of the compiled or linked program; rather, the entire operating system looks to the linking loader like a group of P-loaded user libraries.

Summary of Linking Object Files

Note

All input modules must remain on-line for the duration of steps 6 through 9. The output file must be on-line for steps 3 thru 10.

1. Enter the Librarian.
2. Be sure the disc containing the file to be linked is in the appropriate disc drive.
3. Specify an Output file name.
4. Press to begin the linking process.
5. Name the new module with the Name Command.
6. Specify the Input file containing the modules you want to link.
7. Transfer only those files you want into the new Output file using the All and Transfer commands.
8. Repeat steps 6 and 7 until all files are transferred.
9. Press to complete the Linking process.
10. Press to keep your output file.
11. Press to quit the Librarian.

Getting Detailed Object File Information

Let's unassemble the file MOD_2.CODE to see how the Librarian provides detailed information about a code file. It is best to have a printer on-line while unassembling; however, if you don't, you can declare a Printout file as described in the following procedure.

1. The Librarian is on the ACCESS: disc shipped with your system. To access the Librarian, you will need to put this disc on-line, or copy the file to a disc that is on-line, or P-load the file. After the file is on-line, press (at the Main Command Level) to load the Librarian subsystem into the computer.
2. If you don't have a printer on-line, then you must specify a file to which the unassembled information is sent. Press (for Printout) and enter a file specification; if no suffix or trailing period is included, then ".TEXT" is appended to the file name. The screen will be updated to show that the printout device is ON and that it is the file you specified.
3. Press and enter #3:MOD_2 as the Input file. No Output file is needed.
4. Press to get into the Unassemble mode.

Your screen should now show the Librarian Unassemble menu.

```

Librarian [Rev. 3.0 15-APR-84]                1-Jun-84 9:45:02

Q  Quit
S  Stop un assembling
T  Print import Text
E  Print Ext table
D  Print Def table
A  unassemble all (Assembler conventions)
C  unassemble all (Compiler conventions)
P  PC range      (Assembler conventions)
L  Line range    (Compiler conventions)

unassemble option?

```

When the first command key is pressed, an information header is printed along with the desired information. This header is printed only this one time. An internal counter keeps track of the line count and prints a page heading at the top of every new page. If you change the placement of the printer paper, you may waste some paper when the counter sends a form-feed to the printer. When you quit, a final form-feed is sent to the printer automatically.

The Text and Table Commands

Use these commands to obtain Interface Text and REF and DEF tables of modules.

The Print Import (or Interface) Text Command

Pressing **T** prints the interface text (DEFINE SOURCE) of the module, if any. In a compiled module, the DEFINE SOURCE portion consists of the text in the MODULE, IMPORT (if present), and EXPORT declarations; in an assembled module, this text consists of the lines containing the SRC pseudo op. (Note that any comments and indentation have been removed.)

```
Librarian [Rev. 3.0 15-Apr-84]      23-Apr-84   7: 6:51   Page 1
```

```
MODULE  MODULETWO      Created 23-Apr-84
NOTICE: (none)
  Produced by Pascal Compiler of 23-Apr-84
  Revision number 3
  Directory size      174 bytes
  Module size         3072 bytes
  Module NOT executable
  Code base           0      Size      104 bytes
  Global base         0      Size      0 bytes
  EXT  block    5      Size      72 bytes
  DEF  block    3      Size      90 bytes
  EXPORT block    1      Size      74 bytes
  There are          1 TEXT records
```

```
DEFINE SOURCE of 'MODULETWO':
```

```
MODULE MODULETWO;
IMPORT ModuleThree;

EXPORT
PROCEDURE TwoLines;

END;
```

The Print EXT Table Command

Pressing **E** prints the table of External symbols the module references. Detailed information on the EXT table may be found later in this chapter.

```
EXT table of 'MODULETWO':
```

```
FS_FWRITELN
FS_FWRITEPADC
MODULETHREE_THIRDLINE
SYSGLOBALS
```

The Print DEF Table Command

Pressing **D** prints the table of symbols the module itself defines. Detailed information on the DEF table may be found later in this chapter.

```
DEF table of 'MODULETWO':
```

```
MODULETWO          Gbase
MODULETWO_MODULETWO  Rbase+102
MODULETWO_TWOLINES  Rbase+2
MODULETWO__BASE     Rbase
```

The Unassemble Commands

There are two conventions used when unassembling object files: Compiler and Assembler. The reason for this is that the Compiler and Assembler use different conventions for the object code that they generate.

The Compiler generates code so that each procedure begins with a TRAP #1 or a LINK #n,AB and ends with a JMP or RTS. The Librarian uses this information to assume that everything from the beginning of the file to the first TRAP #1 or LINK is a constant. From the end of the procedure to the next TRAP #1 or LINK is also unassembled as constants. Everything else is unassembled as instructions. The Assembler convention assumes that everything is an instruction.

Note

All Unassemble commands require a printer unless a destination file is specified with the P command.

The Unassemble All (Compiler convention) Command

Pressing **C** directs the Librarian to unassemble the specified object module using the Compiler convention described above. You can use this command on files that were created by either the Assembler or Compiler. Here are the results of using this command with the MOD_2.CODE compiled object file.

```

Librarian [Rev. 3.0 15-Apr-84]          23-Apr-84  9:58:42    Page 1

MODULE  MODULETWO    Created 23-Apr-84
NOTICE: (none)
Produced by Pascal Compiler of 23-Apr-84
Revision number 3
Directory size    174 bytes
Module size      3072 bytes
Module NOT executable
Code base                0      Size          104 bytes
Global base              0      Size           0 bytes
EXT  block    5      Size          72 bytes
DEF  block    3      Size          90 bytes
EXPORT block    1      Size          74 bytes
There are          1 TEXT records
    
```

```

TEXT RECORD #          1 of 'MODULETWO':
TEXT start block      2      Size      104 bytes
REF  start block      4      Size      24 bytes
LOAD address          Rbase
-----
0 0000                dc.w 0          or dc.b 0,0          or dc.b ' '
-----
2 4E41 0000          trap #1,#0
6 2F2D FFAB          move.l SYSGLOBALS-90(a5),-(sp)
10 2F17              move.l (sp),-(sp)
12 4B7A 0030          pea Rbase+62
16 3F3C 0027          move.w #39,-(sp)
20 3F3C FFFF          move.w #-1,-(sp)
24 4EB9 0000          jsr FS_FWRITEPAOC
0000
30 4AAD FFEA          tst.l SYSGLOBALS-22(a5)
34 6702              beq.s Rbase+38
36 4E43              trap #3
38 4EB9 0000          jsr FS_FWRITELN
0000
44 4AAD FFEA          tst.l SYSGLOBALS-22(a5)
48 6702              beq.s Rbase+52
50 4E43              trap #3
52 4EB9 0000          jsr MODULETHREE_THIRDLINE
0000
58 4E5E              unlk a6
60 4E75              rts
62 4920              dc.w 18720          or dc.b 73,32          or dc.b 'I '
64 6361              dc.w 25441          or dc.b 99,97          or dc.b 'ca'
66 6D65              dc.w 28005          or dc.b 109,101        or dc.b 'me'
68 2066              dc.w 8294           or dc.b 32,102         or dc.b 'f '
70 726F              dc.w 29295          or dc.b 114,111        or dc.b 'ro'
72 6D20              dc.w 27936          or dc.b 109,32         or dc.b 'm '
74 4D6F              dc.w 19823          or dc.b 77,111         or dc.b 'Mo'
76 6475              dc.w 25717          or dc.b 100,117        or dc.b 'du'
78 6C65              dc.w 27749          or dc.b 108,101        or dc.b 'le'
80 5477              dc.w 21623          or dc.b 84,119         or dc.b 'Tw'
82 6F20              dc.w 28448          or dc.b 111,32         or dc.b 'o '
84 616E              dc.w 24942          or dc.b 97,110         or dc.b 'an'
86 6420              dc.w 25632          or dc.b 100,32         or dc.b 'd '
88 6272              dc.w 25202          or dc.b 98,114         or dc.b 'br'
90 6F75              dc.w 28533          or dc.b 111,117        or dc.b 'ou'
92 6768              dc.w 26472          or dc.b 103,104        or dc.b 'sh'
94 7420              dc.w 29728          or dc.b 116,32         or dc.b 't '
96 7468              dc.w 29800          or dc.b 116,104        or dc.b 'th'
98 6973              dc.w 26995          or dc.b 105,115        or dc.b 'is'
100 3A00             dc.w 14848          or dc.b 58,0           or dc.b ':'
102 4E75              dc.w 20085          or dc.b 78,117        or dc.b 'Nu'

```

The Unassemble All (Assembler Convention) Command

Pressing **A** will cause your computer to unassemble the specified object module using the Assembler convention described above. You can use this command on files that were created by either the Assembler or Compiler.

Note

Use of the Assembler convention may produce unpredictable results, because under this convention there is no way to tell code from data. Files produced by the Compiler and unassembled under the Compiler convention will almost always produce reasonable results.

Here is the unassembly of the MOD_2.CODE object file using the Assembler convention. Notice that, with Assembler convention, the first two bytes (\$0000) are assumed to be code; with Compiler convention they are assumed to be data (remember that the Compiler convention assumes that anything until the first TRAP #1 or LINK #n,AB is assumed to be data). Notice also that the module heading shows that this object module was produced by the Compiler.

Librarian [Rev. 3.0 15-Apr-84] 23-Apr-84 10: 1:34 Page 1

```

MODULE  MODULETWO  Created 23-Apr-84
NOTICE: (none)
Produced by Pascal Compiler of 23-Apr-84
Revision number 3
Directory size 174 bytes
Module size 3072 bytes
Module NOT executable
Code base 0 Size 104 bytes
Global base 0 Size 0 bytes
EXT block 5 Size 72 bytes
DEF block 3 Size 90 bytes
EXPORT block 1 Size 74 bytes
There are 1 TEXT records

```

```

TEXT RECORD # 1 of 'MODULETWO':
TEXT start block 2 Size 104 bytes
REF start block 4 Size 24 bytes
LOAD address Rbase
0 0000 4E41 ori.b #65,d0
4 0000 2F2D ori.b #45,d0
8 FFAB dc.w -90 or dc.b 255,166 or dc.b ' '
10 2F17 move.l (sp),-(sp)
12 4B7A 0030 pea Rbase+62
16 3F3C 0027 move.w #39,-(sp)
20 3F3C FFFF move.w #-1,-(sp)
24 4EB9 0000 jsr FS_FWRITEPAOC
0000

```

```

30 4AAD FFEA      tst.l SYSGLOBALS-22(a5)
34 6702          beq.s Rbase+38
36 4E43          trap #3
38 4EB9 0000      jsr FS_FWRITELN
    0000
44 4AAD FFEA      tst.l SYSGLOBALS-22(a5)
48 6702          beq.s Rbase+52
50 4E43          trap #3
52 4EB9 0000      jsr MODULETHREE_THIRDLINE
    0000
58 4E5E          unlk a6
60 4E75          rts
62 4920          lea -(a0),a4
64 6361          bls.s Rbase+163
66 6D65          blt.s Rbase+169
68 2066          movea.l -(a6),a0
70 726F          moveq #111,d1
72 6D20          blt.s Rbase+106
74 4D6F 6475      lea 25717(sp),a6
78 6C65          bse.s Rbase+181
80 5477 6F20      addq.w #2,32(sp,d6.1)
84 616E          bsr.s Rbase+196
86 6420          bcc.s Rbase+120
88 6272          bhi.s Rbase+204
90 6F75          ble.s Rbase+209
92 6768          beq.s Rbase+198
94 7420          moveq #32,d2
96 7468          moveq #104,d2
98 6973          bvs.s Rbase+215
100 3A00         move.w d0,d5
102 4E75          rts

```

The Line Range (Compiler Convention) Command

Pressing causes two prompts to be displayed. The computer needs to know the line number range to unassemble. The code will then be unassembled up to, but not including, the upper range value. The object module must have been compiled using the \$DEBUG ON\$ Compiler option to be unassembled with this command.

The PC Range (Assembler Convention) Command

Pressing causes two prompts to be displayed. The computer needs the location counter values of the segment of code you want unassembled (relative to the relocation base of the module). The code will then be unassembled up to but not including the upper location counter value.

Creating a New Boot File

At power-up, the Boot ROM searches mass storage for system Boot files: Boot ROMs 3.0 and later versions search all mass storage devices on-line and let you choose which Boot file you want; earlier Boot ROMs choose the first Boot file found on the right-hand internal disc drive. A Boot file is then loaded by the Boot ROM. The Boot file in turn may load other parts of a system. (For further details of how this system boots, see the discussion called The Booting Process in the Special Configurations chapter.)

The **B** command is used to create Boot files. This is an advanced option and should only be used if you have a clear understanding of system generation.

The following is an overview of the system generation process using the **B** command.

Note

The B command cannot create boot files in WS1.0 directories.

1. Use the Editor to produce the programs and modules that will make up the new boot program. Both Assembler language and Pascal modules may be used.
2. Assemble the Assembler language modules and compile the Pascal modules.
3. Use the Librarian to Link the code files together as desired. Be sure to specify the global and relocation bases. In addition, this file must have no unsatisfied external references. Note that the first program linked will provide the start address for the Linked file. This start address will also become the start execution address of the system Boot file at boot time.
4. Keep the linked file.
5. Specify the linked file as the Librarian Input file.
6. Now press **B** to properly place the module name in the destination's directory and format the code for use by the boot ROM. The B command moves the cursor up to the Output file prompt.
7. Specify the Output file as SYSTEM_xxx (the xxx can be any characters syntactically allowed for file names. With Boot ROMs 3.0 and later, the name can be SYSxxxxxxx; see Renaming BOOT: Files in the Special Configurations chapter for examples). Be sure to append a trailing period to the file name to keep a suffix from automatically being appended to the name.
8. Transfer the Input file into the boot file. This copies the code file.
9. Press **B** again to finish the Boot operation.
10. You can now either Quit the Librarian or power up and test your new system.

Librarian Command Reference

The Librarian command set consists of single-letter commands allowed when the letter prompts are displayed on the screen. You press the corresponding key to cause the command to be executed.

- A** In Copying and Linking modes, this command transfers All modules from the Input file to the Output file.
- In Edit mode, this command is used to Append modules to the Output file.
- In Unassemble mode, this command directs the Librarian to unassemble the Input file using Assembler conventions.
- B** The Boot command is used to create code files that are loadable by the Boot ROM. The Boot command is given instead of the Output file command. The Input modules are then combined in a format that is bootable. This command should only be used by system designers. A boot file must be a self-contained processor environment. It must be stored on a LIF or SRM volume and be named SYSTEM_xxx, where xxx represents any combination of characters. If you have Boot ROM 3.0 or later version, the file can be named SYSxxxxxxx or stored on an SRM system under the /SYSTEMS directory.
- C** In the Link mode, this command returns you to Copy mode. While in Copy mode, you can combine modules into a library without Linking. This mode can be used to add modules to (or remove them from) the System Library, your own library, or INITLIB (the Initialization Library file which is executed during the boot process).
- In Edit mode, this command Copies the First module up to (but not including) the Until module to the Output file.
- In Unassemble mode, this command unassembles the Input file according to Compiler conventions.
- D** In Link mode, this command controls whether or not the DEF table is included in the Output file. If the Output file is to be Linked to another file later, the DEF table must be left in the Output file. If the Output file is not to be Linked, you can save memory space by removing the DEF table. A YES includes the DEF table, a NO removes it. Pressing **D** toggles between these two choices.
- In Unassemble mode, this command prints the DEF table.
- E** This command is available when you have specified both Input and Output files. It puts you into Edit mode, which allows you to combine modules in the Input file with Append modules and place them into the Output file (while either Copying or Linking).
- In Unassemble mode, this command prints the Ext table.
- F** This command prints the File directory of the Input file on the current Printout file (external printer or file). It doesn't matter whether the Printout prompt is ON or OFF; the printout will be sent to the Printout file.
- In Edit mode, this command is used to specify the First module to be transferred to the Output file. (The First module must precede the Until module in the Input file.)
- G** In Linking mode, designate the Global base address (most useful when preparing a file for use as a system Boot file).

- H** The Header command allows you to change the size of the library header. From 1 through 18 module entries require only one header block, so a header size of 18 is the minimum. If you specify less (but not 0), you will still be given 18. From 19 through 38 module entries requires two header blocks. This is the default header size. The specification is made in units of module entries – not blocks. The Librarian calculates how many blocks are necessary to maintain the number of modules you specify and then gives you the maximum number of entries that will fit in that number of blocks.
- I** Name the Input file containing the modules you want to transfer to the Output file. “.CODE” is automatically appended to the file name unless suppressed by a trailing period (or by the presence of another standard suffix). This prompt can be used many times to collect modules from several object files into your new object file.
- K** Keep the Output file. Close and lock it into the directory, purging any old file of the same name.
- L** Enter Linking mode or finish Linking.
In Unassemble mode, you can use this command to unassemble a section of code defined by two Line values using the Compiler convention. The code must have been compiled using the \$DEBUG ON\$ Compiler option.
- M** Enter the specific Module name you want to transfer. (The first module in the Input file is automatically displayed when an Input file is specified.)
- N** In Linking mode, name the New object module to be created by the Librarian. If you do not specify specify a new module name, the name of the first module transferred will be used.
- O** Name your Output file. “.CODE” is appended automatically unless suppressed by a trailing period (or standard suffix) in the file name. This Output file must remain on-line throughout the process of transferring modules to it.
- P** This command is used to turn the Printout option ON or OFF (the default is OFF) and to select a Printout file. Pressing **P** and **Return** or **ENTER** turns the option ON. With the option ON, the device to which the information is sent is shown on the screen. The default Printout file specification is “PRINTER:LINK.ASC” unless you specify another. “.TEXT” is automatically appended to the file name unless it is suppressed by a trailing period (or standard suffix) in the file name.

Before any information is sent to the Printout file, the Librarian first sends heading information to the device. When Linking, you will get a map of all Linking done by the Librarian. This option does not affect any information sent to the Printout file by the Unassemble commands.

In Unassemble mode, this command allows you to unassemble (using Assembler conventions) a section of code defined by two location counter range values.

- Q** Quit the Librarian and return to the Main Command Level.
- R** In Linking mode, designate the Relocation base address to be used.
- S** In Linking mode, this command assigns Space for patches. To save execution time and memory space, the Compiler can be made to use PC-Relative addressing instead of Long-Absolute addressing. This is done with the Compiler option \$CALLABS OFF\$. The PC-Relative addressing mode has an address range of - 32 768 through 32 767 bytes; if the referenced procedure is out of this range, an error will occur at load or link time. This error prints an error message naming the module having the link out of range. To fix this, relink the modules adding patch space between them as needed. The number of bytes needed depends on the particular module. As a rule of thumb, begin with a patch of 100 bytes.
- In Edit or Unassemble modes, this command Stops the Edit or Unassemble session and returns to the Librarian's main prompt. (This will not stop an ongoing Unassemble; however, the **Stop** key will.)
- T** In Copying and Linking modes, this command Transfers the object module currently named in the Transfer prompt to the Output file.
- In Unassemble mode, this command prints the interface Text (DEFINE SOURCE) of the current Input module.
- U** Enter the Unassemble mode.
- In Edit mode, this command allows you to specify the Until module. If you enter a null response (by pressing **Return** or **ENTER** with no file specification), then (end of file) is displayed; a subsequent Copy will copy all remaining modules in the Input file (i.e., up to the end of the file) to the Output file.
- V** This command gets you into the Verify mode. This mode displays the name of each module in the Input file and allows you to Transfer it to the Output file (press **T**), to Unassemble it, or to not transfer or unassemble it (press the space bar) and step to the next module name. After all module names have been displayed, you automatically leave this mode. To re-verify the file's contents, press **V** again.
- X** In Linking mode, this command allows you to enter a copyright notice as part of the Output file. The notice is part of the heading information sent to the Printout file. The notice can be up to 255 characters long.

Glossary of Object Code Terminology

Here are detailed definitions of the terms used in this manual regarding object-code library files.

DEF table (Definition Symbol Table)

There is only one DEF table per module. It contains one DEF record for each symbol which is exported from the module. The DEF table begins on a block boundary which is specified in the directory for the module. Its length is also given in the directory. The DEF table is contiguous over its length, which means that individual DEF records within the table may cross block boundaries.

Each DEF record has two parts. The first part is a packed string containing the name of the symbol which is defined. The string begins and ends on a word (even-byte) boundary. If the string length is odd, then an extra byte is added to the end for padding so that the next part of the DEF record will begin on a word boundary.

The second part of a DEF record is a general value or address record (GVR) which defines the value of the symbol which is being exported. GVR is defined later in this section.

The value extension is 4 bytes or 8 bytes long, according to the data size field. The value of the symbol is defined to be the value extension plus what ever references are specified by the primary type and any Reference Pointers that may exist. The value extension must be present.

DEF record

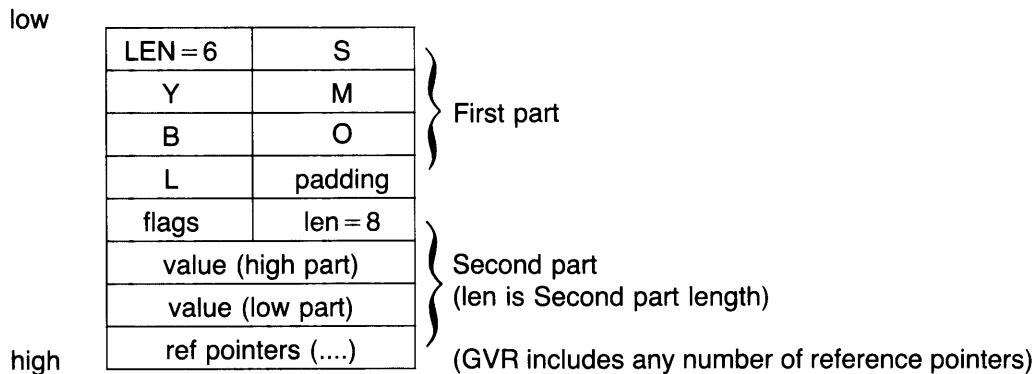

DEFINE SOURCE

This is the section of an object module that is searched by the Compiler when the module is imported (also called "interface text"). With Pascal modules, the DEFINE SOURCE consists of the declarations made by the reserved words MODULE, IMPORT (if present), and EXPORT. With Assembler modules, it consists of the lines defined by the SRC pseudo op, which are intended to serve the same function as in Pascal modules (however, it may be any arbitrary text).

There may be one table of DEFINE SOURCE per module. It begins on a block boundary, which is given in the module directory. The length is also given in the directory.

EXT Table (External Symbol Table)

The EXT table contains records (Pascal strings), each of which is the name of a symbol referenced in this module, but not defined in it (i.e., these symbols are declared in another module which this one imports and to which this module is linked at load time).

There may be one EXT table per module. The EXT table begins on a block boundary which is specified in the directory for the module. Its length is also given in the directory. The EXT table is contiguous over its length, which means that individual EXT records within the table may cross block boundaries.

Each EXT record is a multiple of four bytes long. The first byte of each string is its length (according to the Pascal string type); thus strings may be from 1 to 255 bytes long. If $\text{strlen}(\text{string}) + 1$ is not a multiple of 4, then 1 to 3 bytes are added as padding to make the EXT record extend to the proper boundary.

The first eight bytes of the EXT table are reserved. Thus, the first string in the table starts at an offset of 8 from the start of the table.

The EXT table is restricted to 65 532 bytes in length (plus the length of the last string). This is so that any entry in the table can be uniquely referenced by 14 bits; the reference is relative to the start of the table. See the description of the reference pointer.

EXT Record

low	left byte	right byte	This one is 8 bytes long.
	LEN = 6	S	
	Y	M	The formula is:
	B	O	$\text{EXTsize} = \text{len} + 4 - (\text{len} \bmod 4)$
high	L	padding	

General Value or Address Record (GVR)

The GVR is a variable length record which is intended to represent any absolute, relocatable, or linkable value.

```

TYPE DATATYPE = (sbyte, sword, sint, fltpt, ubyte, uword);
   RELOCTYPE = (absolute, relocatable, global, general);
GENERALVALUE = PACKED RECORD
  PRIMARYTYPE : RELOCTYPE;      (*allows quick indication
                                of most common types*)
  DATASIZE : DATATYPE;          (*specifies 1,2 or 4 bytes, signed or not*)
  PATCHABLE,                    (*specifies self relative field in branch*)
  VALUEEXTENDED : BOOLEAN;      (*indicates valueextension*)
  CASE LONGOFFSET : BOOLEAN OF (*1 or 3 byte offset*)
    FALSE : (short:0..255);      (*unsigned 8 bits*)
    TRUE : long:0..16777215);    (*unsigned 24 bit value*)
END;
  VALUEEXTENTION = PACKED      (*present if value extended bit above is set*)
  RECORD
    CASE DATATYPE OF
      SBYTE, SWORD, SINT,
      UBYTE, UWORD : (value integer);
END;
REFERENCEPTR = PACKED RECORD (*one or more present if type = general*)
  ADDRESS : 0..16383;          (*multiply by 4 to get address of EXT symbol*)
  OP : (ADDIT, SUBIT);         (*add or subtract the modifying value*)
  LAST : BOOLEAN;             (*indicated end of list*)
END;
GVR = CONCATENATION          (*NOTE* This is pseudo Pascal*)
  GENERALVALUE;               (*2 to 4 bytes of header info*)
  VALUEEXTENTION;            (*0 or 4 bytes of value*)
  ARRAY[zero or more] OF
    REFERENCEPTR;             (*list of EXT references*)
END;

```

IMPLEMENT

IMPLEMENT is a reserved word used in the Pascal Module. It is used as a flag to indicate the beginning of the module body. It is made up of the reserved word plus a declaration statement. The statement can be either empty or used to declare those constants, variables, procedures and functions used internally by the module. None of this information is available outside the module (unless it is also declared in the module's EXPORT section).

IMPORT

IMPORT is a reserved word used in the Pascal Module. It names the modules whose DEFINE SOURCE sections must be examined by the Compiler in order to resolve references to constants, variables, procedures, and functions exported by the modules. The Compiler uses a module's name in conjunction with names of constants, procedures, and functions declared in the module to generate EXT strings for which the loader will search (and link) at run time.

LIBRARIAN

The Librarian is a subsystem designed to manage HP Series 200 Pascal and Assembler object files, link and unassemble object modules, and create system Boot files. It can merge object files containing object modules and optionally link the object modules together. It is the file named LIBRARIAN in your operating system, which can be changed with the Main Level's What command. It is accessed by pressing from the Main Command Level.

Library

A library is an object file produced by the Assembler, Compiler, or Librarian. Its purpose is to contain object module(s).

LIBRARY

LIBRARY is a special library file included with your operating system. During the boot process, this file (if on-line) generally becomes the System Library; you can also use the What command at the Main Level to specify any file as the System Library.

Only a few useful object modules are included in the file when you received it. Feel free to examine them with the Librarian. Other object modules are supplied on the LIB: and FLTLIB: discs and may be added to the LIBRARY.

Object File

An Object File is the unit of object code managed by the Librarian. It is made up of a Library directory and one or more object modules. The Assembler generates one object file from each source file assembled; the Compiler also generates one object file per invocation. The Compiler's object file can contain one or more object modules depending upon the source file's construction. If the source file contains a number of compilable modules, that number of object modules will be created in the object file.

Object Module

Each object module is made up of a module directory and a module body. The module body is made up of the following items:

One EXT table	A table of the symbols imported by the module.
One DEF table	A table of symbols exported by the module.
One DEFINE SOURCE Area	A software interface between the module and any program which imports it.
One or more TEXT-Record/REF-Table pairs	A TEXT record consists of the constants and code instructions that make up the program. The REF table is a directory of the symbols used in the TEXT record.

Pascal Module

HP Pascal allows source modules to be compiled separately into object modules. The object modules are generally not executable, but are used to complete other Pascal programs. Examples are given earlier in this chapter.

REF Tables

Each REF table follows a TEXT record and is associated with that TEXT record. The REF table begins on a block boundary, which is specified in the directory for the module. Its length is also given in the directory. The REF table is contiguous over its length.

Each REF record is associated with one object (byte, word or integer) within the preceding TEXT record. There can be at most one REF record for a given object in the TEXT record. The REF records are ordered within the table according to the TEXT objects they reference.

The offset field specifies which text object is referenced. The first REF record gives an offset from the beginning of the TEXT record. Subsequent REF records give an offset from the object referenced by the previous REF record.

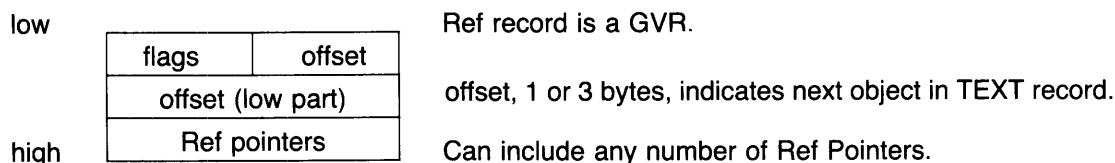

Reference Pointer

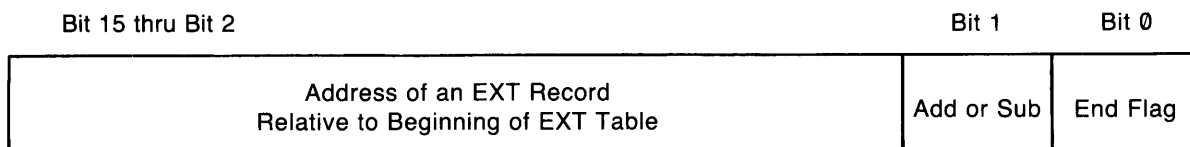

A REFERENCE POINTER is the relative address of an entry in the EXT table.

The add or sub flag indicates whether the value of the external symbol is to be added (0) or subtracted (1) from the GVR value in order to obtain the actual value. There may be any number of REFERENCE POINTERS in a GVR, and there may be more than one reference to the same EXT record. There may not, however, be both an add reference and a subtract reference to the same symbol, since these would cancel each other.

The end flag indicates whether there are any more REFERENCE POINTERS in the GVR. (0) indicates more to come, (1) indicates the end.

There are two special cases for the EXT address.

- Address 0 (bit pattern 00000000000000xx) refers to the relocation delta for the current module (i.e. new load address minus the old load address).
- Address 4 (bit pattern 00000000000001xx) refers to the global delta for the current module (i.e. new data address minus old data address)

Address 8 (bit pattern 00000000000010xx) is the first valid reference to an external symbol.

There are REFERENCE POINTERS in a GVR only if the primary type field specifies general.

System Library

The System Library is a file that is automatically accessed by the Compiler at compile time and by the linking loader at execution time. Object modules stored in this object file are automatically available to any program importing them.

During the booting process, the LIBRARY file usually gets designated as the System Library; however, you can use the What command at the Main Level to specify any file. See LIBRARY above.

Text Record

A Text record is a contiguous section of code, beginning on a block boundary, which is given in the module directory. The length is also given in the directory. The text record can be any arbitrary data, but is usually the object code produced by the Compiler or Assembler.

The Debugger

Chapter

9

Introduction

The Workstation Pascal System features a programming aid called the Debugger. As you probably have guessed, the major purpose of the Debugger is to make program debugging as painless as possible.

You may have already seen a reference to this Debugger when you got this message:

```
RESTART WITH DEBUGGER?
```

The question is in response to a user program generating *but not trapping* an “exception.” You will learn how to answer the question in this chapter.

Here are some of the operations you can perform with the Debugger:

- Step through programs on a procedure, statement, or machine-instruction basis.
- Maintain a record of the statements which have already been executed (in order of execution).
- Examine any memory locations and CPU registers, and display the contents in any of the following formats: binary, octal, decimal, or hexadecimal integer; real number; alphanumeric character; and Assembler instruction.
- Set up “breakpoints” and “error traps” in the program, optionally displaying helpful information when each is encountered.
- Perform number-base conversions and integer arithmetic calculations.

The main emphasis of this chapter is to describe using the Debugger to debug Pascal programs. Debugging an Assembler-language program is more direct; that information is obtainable from the Debugger Reference Section.

Is the Debugger Loaded?

The Debugger is a very powerful subsystem, because it allows any user to access *everything* in the computer. It is therefore a potentially dangerous feature in the hands of users who don’t know how to use it (or who you don’t *want* to use it). For this reason, and for space considerations, it is *not* automatically loaded when you boot the system. Therefore, you will need to load the Debugger before attempting to use it. (In previous system versions, it was automatically loaded at boot time, as it was part of the INITLIB file). Loading the Debugger is explained in the following Sample Session section.

A Sample Session

This section describes methods for debugging Pascal programs with the aid of the sample program called `DEBUG`, supplied to you on the `DOC` (documentation) disc. The program is given in source-code and object-code form.

- `DOC:DEBUG.TEXT` – the source-code file
- `DOC:DEBUG.CODE` – the object-code file

The Example Program

A listing of the program is included here for reference. Note that a Pascal program must contain the `$DEBUG ON$` Compiler option if you want to have the ability to halt the program at particular line numbers. The effects of this option are further described in the Compiler chapter.

```
Pascal [Rev 3.0  4/15/84] DEBUG.TEXT                28-Apr-84 14:21:55 Page 1

 1:D          0 $DEBUG ON$ { Enable debugging. }
 2:S
 3:D          0 PROGRAM XYZ (OUTPUT);
 4:D          1   VAR
 5:D          -4 1     i           : INTEGER;
 6:D          -8 1     j           : INTEGER;
 7:D         -16 1     x           : REAL;
 8:D         -24 1     y           : REAL;
 9:D         -25 1     ch1        : CHAR;
10:D         -26 1     ch2        : CHAR;
11:S
12:D          1   PROCEDURE Level_1;
13:D          2     VAR
14:D          -4 2     i           : INTEGER;
15:D          -8 2     x           : INTEGER;
16:D         -12 2     y           : INTEGER;
17:S
18:D          2     PROCEDURE Level_2b;
19:C          3       BEGIN
20*C         3         WRITE('Level 2b: ');
21*C         3         WRITE(' i=',i:2,' x=',x:4);
22*C         3         WRITELN(' ch1=',ch1:1);
23*C         3       END;
24:S
25:D          2     PROCEDURE Level_2a;
26:D          3       VAR
27:D         -12 3     i, x, y   : INTEGER;
28:S
29:D          3     PROCEDURE Level_3;
30:C          4       BEGIN
31*C         4         IF i < 4 THEN
32:C         5           BEGIN
33*C         5             WRITE('Level 3: ');
34*C         5             WRITE(' i=',i:2,' x=',x:4);
35*C         5             WRITELN(' ch1=',ch1:1);
36*C         5             i:= i + 1;
37*C         5             Level_3;
38:C         5           END;
39*C         4         IF ch1='a' THEN
40:C         5           BEGIN
41*C         5             ch1:= 'x';
42*C         5             WRITE('Level 3: ');
43*C         5             WRITE(' i=',i:2,' x=',x:4);
44*C         5             WRITELN(' ch1=',ch1:1);
45:C         5           END;
46*C         4       END;
47:S
```

```

48:C      3      BEGIN
49*C     3      WRITE('Level 2a: ');
50*C     3      WRITE(' i=',i:2,' x=',x:4);
51*C     3      WRITELN(' ch1=',ch1:1);
52*C     3      i:= 1; x:= 2; y:= 3;
53*C     3      Level_3;
54*C     3      i:= 4; x:= 5; y:= 6;
55*C     3      Level_2b;
56*C     3      END;
57:S
58:C     2      BEGIN
59*C     2      i:= 0; x:= 0; y:= 0;
60*C     2      WRITE('Level 1: ');
61*C     2      WRITE(' i=',i:2,' x=',x:4);
62*C     2      WRITELN(' ch1=',ch1:1);
63*C     2      Level_2b;
64*C     2      Level_2a;
65*C     2      END;
66:S
67:C     1 BEGIN
68*C     1 i:= 10;
69*C     1 x:= 20,0; y:= 30,0;
70*C     1 ch1:= 'a'; ch2:= 'b';
71*C     1 WRITE('Main: ');
72*C     1 WRITE(' i=',i:2,' x=',x:2:1);
73*C     1 WRITELN(' ch1=',ch1:1);
74*C     1 Level_1;
75*C     1 WRITE('Main: ');
76*C     1 WRITE(' i=',i:2,' x=',x:2:1);
77*C     1 WRITELN(' ch1=',ch1:1);
78*C     1 END.
79:S

```

No errors. No warnings.

Please Participate

You will learn much more about the Debugger if you participate in this sample session. Execute the code file one time before attempting the sample session to see the program's output.

Loading the Debugger

As previously mentioned, the Debugger is not automatically loaded as part of the standard system, so you will need to load it into the computer. You can load the module in either of two ways:

- Execute it using the eXecute command (from the Main Command Level); the program installs itself.
- Add the DEBUGGER module to INITLIB, and re-boot the system; the program is then installed automatically.

Loading the Debugger with the eXecute command allows you to use it until you re-boot the system, at which time you will have to eXecute it again to use it. By adding the module to INITLIB, you give all users (who subsequently boot with this INITLIB file) access to the Debugger. You will not want to use this second method unless you want to give all users access to the Debugger.

Executing the Debugger

First, make sure that the ASM: disc is on-line or that the file is otherwise accessible. Then, from the Main Command Level, press the **X** key to initiate the eXecute command. The system will prompt you with this message:

```
Execute what file?
```

Respond by entering the specification of the DEBUGGER file; `ASM:DEBUGGER.` will work if you are loading the program from the original disc (remember to type a trailing period to suppress the `.CODE` suffix). The system then loads and executes the program, which installs itself in memory.

Adding the Debugger to INITLIB

Use the Librarian (from the Main Command Level) to add this module to the INITLIB file. In general, the steps can be summarized as follows:

1. Make a back-up copy of INITLIB.
2. Edit the INITLIB file with the Librarian, adding the DEBUGGER module (supplied on the ASM: disc) to the file. The DEBUGGER can be anywhere *after* the modules named KEYS, BAT, and CLOCK; however, it must be *before* the module named LAST. (Editing libraries is described in the Librarian chapter.)
3. Store the new library file (using the Keep command).
4. Remove the INITLIB file on your BOOT: disc, and add your new INITLIB file.
5. Re-boot the system.

After re-booting the system, the Debugger should be in memory.

A Note about Key Notations

Throughout this chapter, you will be shown which keys invoke certain Debugger functions. Since you may have one of three different keyboards connected to your computer, each with a different set of keys, you will need to learn which key to press on your keyboard. Here are examples of keys used to invoke a few functions on the three different keyboards¹.

Desired Function	HP 46020A Key(s)	HP 98203B Key(s)	HP 98203A Key(s)
Pause	Break	PAUSE	PSE
Single Step	(System) f5	STEP	STEP
Slow Step	(System) CTRL - f5	CTRL - STEP	CTRL - STEP
Continue	(System) f4	CONTINUE	CONT

For instance, invoke the Pause function on a 46020 keyboard by pressing the **Break** key. On a 98203B keyboard, press the **PAUSE** key. With a 98203A keyboard, press the **PSE** key.

¹ This discussion only gives a few examples; the Debugger Keyboard section near the end of the chapter describes all key(s).

As another example, suppose that you want to invoke the Single-Step function. On both 98203A and B keyboards, press the **STEP** key; the label is *on the key itself*. On a 46020 keyboard it will be the System key labeled **f5** *on the key*, which is labeled **STEP** *on the screen* while in the System-key mode. (If you are not already in System-key mode, then you will need to press the **System** key before pressing **f5**.) The same notation is used for the other System keys on the 46020 keyboard; the actual System key (i.e., **f1** through **f8**) is not given in text; the label is instead given. You will need to make the association, which you can easily do by looking at the System-key labels while the Menu is being displayed (press the **Menu** key to toggle the Menu on and off). If you are not familiar with the **System** and **Menu** keys, read the discussion in the *Pascal User's Guide*.

The convention used in this manual is to show the 46020 keys first (followed by the equivalent 98203B key in parentheses). For instance, the **Break** (**PAUSE**) key invokes the Pause function: on the 46020, it is the **Break** key; on a 98203B keyboard, it is the **PAUSE** key. (The 98203A **PSE** key is not shown, because it is close enough to the **PAUSE** label that you should be able to easily make the connection.)

Is the Debugger Installed?

Before proceeding, you should verify that the Debugger is currently installed. On a 46020 keyboard, press **Break** (**PAUSE**) to pause the system. If a **P** is displayed in the lower, right-hand corner of the screen, then the Debugger is installed. Press **CONT** (**CONTINUE**) to resume operation.

If the Debugger is not installed, then pressing **Break** will do nothing.

Invoking the Debugger

The Debugger is called from the Main Command Level. When the Debugger is invoked, the system will then take steps to determine which program you want to debug. Before invoking the Debugger, let's look at how it determines which program to debug.

Specifying a Program

When the Debugger is invoked, the system will either look for a code file on its own or ask you for the code file's name, according to the following priorities. (If the Debugger is not installed, then the **D** command is identical to the **eXecute** command.)

1. If there is currently an object-code workfile, the file is automatically loaded into computer memory. If there is a source-code workfile (but not an object-code file), the system reports that it cannot open the file because it was not found.
2. If there is no workfile, the second check made is for the last file compiled since power-up. If present, that file is then loaded.
3. If neither such file exists, you are prompted for a file name.

If you plan to debug, edit, and recompile a program several times in a session, using a workfile may be the best alternative; you will not have to keep typing in the file name, because the current workfile is the automatic object of those subsystems.

For this session, we will set up a workfile. First, use the Filer's What command to see if there is already a workfile. If it happens to be the DEBUG.CODE file, you need do nothing more (before exiting the Filer). Otherwise, use the Get command to specify the example program as the workfile. Here is the prompt you will see:

```
Get what file?
```

Answer by entering the file specification of the example program. Type:

```
DEBUG  or 
```

The filer responds with something like this:

```
Source and code file loaded.
```

You may now Quit the Filer. Now press the key while at the Main Command Level to invoke the Debugger.

Answering RESTART WITH DEBUGGER?

As mentioned earlier, this prompt is shown any time that a "user" program generates *but does not trap* an exception. Answering "Yes" to this question will also get you into the Debugger; you will effectively be at the same point as if you had used the D command. (If the Debugger is not currently installed or if the program was not compiled with the \$DEBUG ON\$ option, answering "Yes" will only re-execute the program.)

The Debugger Command Screen

You are now in the Debugger's command screen. This message indicates that the Debugger is ready for further instructions:

```
NOW AT START
>
```

The `d` shown at the lower, right-hand corner of the screen also indicates that you are currently in the Debugger.

The Debugger prompt is a `>`. When this screen and prompt are displayed, you can type Debugger commands on the last line with the prompt and cursor. Enter each command by pressing the , , or () key. Note that the **CONT** key resumes normal program execution. When execution of the program is complete, control returns to the Main Command Line.

Single-Stepping a Program

When the Debugger is at this starting point, it is ready to step through your Pascal program one statement at a time; this mode is called Single-Step Mode. (It can also do many other things, which will be discussed momentarily.) In the lower, right-hand corner of the screen, the Debugger also conveniently displays the program line number which contains the *next* statement to be executed. This line number corresponds to the line number given in the Compiler listing of the program.

For instance, when debugging our example program, line number 68 is initially displayed. This is the line that contains the Pascal statement that will be executed the next time you press the **STEP** key. Press the **STEP** key once and note that the line number changes to 69, which is the line number of the next statement to be executed.

Pressing **STEP** a second time results in no change in line number. This response is due to the fact that the Debugger steps through the program one *statement* at a time, not one *line* at a time. Pressing **STEP** a third time changes the line number to 70.

Slow Program Execution

The Debugger also allows you to execute a program at a rate of about two statements per second. Press **(CTRL)-STEP** to use this execution mode (Slow-Step Mode). Line numbers are flashed on the screen as each is encountered. You can return to Single-Step Mode by pressing the **STEP** key.

Returning to the Debugger Command Screen

You may have noticed that the Debugger prompt disappeared when you began stepping through the program. Instead, the Debugger displays the screen that will be used for the program's output so that you can see what the program is doing at each step of execution.

Note that any keys pressed while in this mode appear in the system's type-ahead buffer, not in a Debugger command line. This action allows you to type in responses to any input statements in the program as you would normally type them in. The program reads this buffer when an input statement is encountered and executed.

At some point in the program's execution you may want to return to the Debugger command screen to execute a command. To do so, press **(CTRL)-Break** (**(CTRL)-PAUSE**). The Debugger restores the last Debugger command screen, which is the one that you saw before you began single-stepping the program. You can then execute Debugger commands or return to the program screen by stepping through the program with the **STEP** key.

Toggling Between Screens

While in the Debugger command mode, you can also toggle between these displays (without changing modes) by pressing **(CTRL)-ALPHA**. For example, suppose you want to quickly check the program screen to see last line displayed by the program. You can do so (without getting out of the Debugger command mode) by pressing **(CTRL)-ALPHA**. When you've examined all you want on the program screen and are ready to return to the Debugger's command screen, press **(CTRL)-ALPHA** again.

Screen Dumps

While in the Debugger, you can dump the current contents of the alpha or graphics screens. Use either the **DMP A** (**DUMP ALPHA**) key or **DMP G** (**DUMP GRAPHICS**) key, or execute a DA or DG command.

Note that this feature is only allowed when running a program in the processor's "user" state¹. It is not possible while executing programs in "system" state. If attempted while disallowed, no dump is performed and the following message is displayed:

```
NOT ALLOWED NOW
```

A Look at the Queue

At this point, you may want to continue stepping through the program and noting the order of execution of lines. You can also get a log of all Pascal program lines executed thus far by the Debugger by executing the Queue command. (Actually, these are the line numbers of Pascal statements executed thus far.) Here is an example of the results of this command (assuming that we have only pressed the **STEP** key three times in our example):

```
>Q
206144 ^ 69
206160 ^ 69
206176 ^ 68
206188 ^ 67
START
```

The line numbers are shown in the right column. (The six-digit numbers in the left column, each followed by ^, are memory addresses for use when debugging Assembler language programs; you don't usually need to be concerned with them while debugging Pascal programs.)

Note that the line numbers in the queue are in *reverse order of execution*: the first line executed is at the bottom of the queue listing, the second is listed above the first, and so forth. Also note that the line at the top of the list has *not yet been executed*; it will be executed the next time the **STEP** key is pressed.

Note that Pascal line numbers will *only* be shown if the \$DEBUG ON\$ Compiler option was used.

Note also that when the question RESTART WITH DEBUGGER? is displayed after encountering an exception that was not trapped, you can get a listing of the queue by pressing **CTRL**-**Break** and then executing a Q command. You can also direct the Debugger to trap exceptions, as described in the Exception Trapping section of this chapter.

Displaying Data

Before showing how to use many of the more powerful Debugger features, let's look at some simple Display operations. Execute the following command:

```
>D B+32
+40
```

¹ All user programs are executed in the "user" privilege state, while system programs, such as the Editor, Filer, and so forth, are executed in "supervisor" privilege state. See the *MC68000 User's Manual* for a more comprehensive description of these states.

From this example, you can deduce that the literal numbers that you entered were interpreted as decimal integers and that the result was a signed decimal integer.

Note that you don't need to specify the D in commands that begin with non-alphabetic characters.

```
>8+32
      +40
```

Now execute this command:

```
>D -32768-32768
      -65536
```

From this result, you can see that the range of integers is at least 16 bits. In fact, it is 32 bits, which indicates that a four-byte register could be used to store the numbers and results. The range is -2^{31} through $2^{31} - 1$ (or 2 147 483 648 through 2 147 483 647).

Executing these commands might help to see this range of integers more clearly:

```
>D 127*256*256*256
+2130706432
>D 128*256*256*256
```

```
OVERFLOW
```

Note that *only* integer arithmetic operations are performed. For instance, division produces the integer portion of a quotient:

```
>5/3
      +1
```

Display Formats

Since the Debugger uses the processor's 32-bit registers for expression evaluation, most results are formatted using four-byte quantities. Here are two equivalent examples of using the default format of one signed (four-byte) INTEGER:

```
>D 255
      +255
>D 255:1I4
      +255
```

The format specifier is the ':1I4' appended to the literal number 255: the leading 1 indicates that one quantity is to be generated; the I indicates that the quantity is to be displayed as a signed, decimal Integer; the trailing 4 indicates that 4 bytes are to be formatted.

If the default format of one four-byte decimal integer is not what you'd like, you can explicitly specify another format. For example, the following command generates four one-byte Binary numbers (the !'s indicate binary notation):

```
>D 1024+255:4B1
!00000000 !00000000 !00000100 !11111111
```

Here is an example of formatting the integer into four one-byte octal numbers (the %'s indicate Octal notation):

```
>D 1024+255:401
%0 %0 %4 %377
```

Now specify that the number is to be formatted as one four-byte hexadecimal number with either of the equivalent commands (the \$'s indicate hex notation):

```
>D 1024+255:1H4
$000004FF
>D 1024+255:H
$000004FF
```

The leading 1 and trailing 4 are the defaults assumed when these parameters are omitted.

This format specification directs the Debugger to display two bytes as a hex value:

```
>D 1024+255:H2
$0000
```

Note that 0's were displayed because the Debugger begins with the *most*-significant bits of the four-byte integer. Here is a more meaningful display format for the same data:

```
>D 1024+255:2H2
$0000 $04FF
```

It is also possible to display literal strings with the data you are formatting for the display. Either single or double quotes can be used to delimit the string. For example, this command gives a more descriptive display:

```
>D -7:'-7 in Hexadecimal = ',H4
-7 in Hexadecimal = $FFFFFFFF9
```

You can also disassemble machine-language instructions by using the X format specifier. Here is an example:

```
>D $4E750000:X
RTS
```

This is usually only helpful while debugging Assembler-language programs. (Note that you must load module REVASM into memory with the P-load command from the Main Command Level in order to use this format.)

Another format specifier is the slash (/). When a "/" is encountered in a Display command, the display is continued on the next line.

```
>D 23+45:/',RESULT = ',I4/
RESULT =          +68
>
```

Input Formats

The `!`, `%`, and `$` symbols preceding numbers in the above examples were used to indicate the base of the numbers displayed on the screen. Similarly, you can use them with literal numbers input in the command. This feature allows number-base conversions.

For example, suppose that you want to convert the binary number 11001010 to its decimal representation. Here is a sample command:

```
>D !11001010:I
      +202
```

To convert the number to hex, execute this command:

```
>D !00110110:H
      $0000003E
```

Changing the Default Display Format

The default format can be changed by giving an `F` (Format) command. For example, the following command changes the default to `' :1H4'`, which instructs the Debugger to take 4 bytes and display them as one four-byte Hexadecimal value:

```
FH
```

This command sets the default format to Octal (`' :1O4'`):

```
FO
```

This command sets the default format to Binary (`' :1B4'`):

```
FB
```

This command changes the default format to `' :1U4'`, which directs the Debugger to display 1 four-byte Unsigned decimal integer.

```
FU
```

This command sets the default format back to signed decimal Integer (114):

```
FI
```

Now that you've had an introduction to the Display commands, let's look at some more powerful commands.

Controlling Execution with Breakpoints

A breakpoint is a point in the program where you want execution to be temporarily halted. With a Pascal program, the point will be at a program line. Thus, when the Debugger is executing a program and encounters a breakpoint, it halts just *before* executing the program line.

Setting Breakpoints

To set a breakpoint, use the **BS** command. Specify the location as an integer which follows the letters “**BS**”, separated by a space. For example, to set a breakpoint at Pascal program line 74, enter the following command:

```
BS 74
```

Press **CONT (CONTINUE)** and the program begins executing again. When it encounters line 74, it pauses before executing the line and displays the message:

```
NOW AT LINE 74
```

The Debugger then prompts you for another command. At this point, you can do any of the following:

- Step through the program one line at a time (if it was compiled with \$DEBUG ON\$)
- Execute other Debugger commands (such as examine memory or register contents)
- Continue the program

Once the program has finished execution, all breakpoints are automatically de-activated. You will have to explicitly re-activate them, as described in a subsequent section.

Up to nine such breakpoints may be defined at one time. Most breakpoints remain in effect until cleared or de-activated.

The Count Option

An optional count can be included by adding an integer after the location. The count instructs the Debugger to stop when it reaches the location the indicated number of times. For example, enter the following command:

```
BS 31 3
```

This particular command instructs the Debugger to halt the program immediately before the third execution of line 31. Press **CONT**, and the program executes until line 31 is reached the third time and then halts. Note that this type of breakpoint is automatically cleared when encountered the specified number of times.

Breakpoints with Commands

Another form of the **BS** command is the “**BS**” and the location number followed by a Debugger command string enclosed in quotes. The command string is one or more legal Debugger commands (separated by semi-colons). These commands are immediately executed when the location is encountered. The Debugger automatically continues program execution after executing the command string. Here is an example that will provide a visual record of how many times that line 37 was executed:

```
BS 37 "D 'LINE 37 REACHED. '"
```

Of course, you will need to get back into the Debugger command screen to see the results of this breakpoint being encountered. The **D (Display)** command is explained in detail later.

You can alternately pause the program by making the last command in the string a question mark. This command directs the Debugger to pause and wait for input from the keyboard. For example, enter the following command breakpoint:

```
BS 59 "D PC; ?"
```

The Debugger stops at line 59, displays the Program Counter, and waits for input.

Here is another example of using a breakpoint with a command:

```
BS 59 'IF 1=1; D "1=1"; ELSE; D "1<>1";?; END'
```

The relational expression following the IF command, in this case `1 = 1`, is first evaluated. If it is true, then the command(s) between the IF and the ELSE are executed. If it is false, then the command(s) between the ELSE and END are executed. This type of command is useful for purposes like checking the value of a variable and then pausing if its value is out of an expected range. The IF, ELSE, and END commands are further explained in the reference section. Checking the value of variables is explained later in this tutorial.

Deactivating Breakpoints

The BD command deactivates breakpoints. If a line number is included, the breakpoint is deactivated for that line number. For instance, the following command deactivates the breakpoint at line 41:

```
BD 41
```

If no line number is included, all breakpoints are disabled. For example, this command disables all breakpoints:

```
BD
```

Displaying the Breakpoint Table

The B command displays the breakpoint table or the one at the specified line number. Execute the following command:

```
B
```

and you'll see a display similar to the following:

```
>B
BREAK POINTS
-----
A          74          0
A          37 D 'LINE 37 REACHED'
A          59 D 'IF 1=1;D "1=1";ELSE;D "1<>1";?;END
```

The first character on each line of the table is either "A" for active, or "D" for deactivated. The second parameter is the line number of the breakpoint. If the third entry in the table is a positive number, then a count option is in effect for the breakpoint (execution will pause when the Debugger reaches the line that number of times). If the third entry is a command string, then that command is executed each time the line is encountered. If it is a "0", then it is a normal breakpoint (i.e., no count nor command was specified with the breakpoint).

Reactivating Breakpoints

The BA command reactivates disabled breakpoints. If the line number is included, the breakpoint is reactivated for that line number, otherwise, all breakpoints are affected. For example, the following command reactivates the breakpoint that was deactivated in the example above:

```
BA 41
```

Try the B command to see the table again.

When a program runs to completion and is then restarted (by pressing the **D** key), the breakpoints are still there; they are just deactivated. Use the BA command to reactivate some or all breakpoints.

Clearing Breakpoints

The BC command clears breakpoints by removing them from the table. If a line number is included, the breakpoint is removed *only* for that line; otherwise, all breakpoints are cleared. Enter the following command to remove only the breakpoint at line 41:

```
BC 41
```

The Pause Function and Breakpoints

If the Debugger is not installed, the **Break** (**PAUSE**) key is a no-op. The rest of this discussion assumes that the Debugger is installed.

While *not* in the Debugger command mode, pressing **Break** effectively halts any program at the current execution point. (Note that this key may not pause the program on a line boundary like the **STEP** key does.)

While *in* the Debugger command mode, however, pressing **Break** returns you to the user program display and pauses the program at the current execution point. Press continue to finish program execution.

If you press **Break** after encountering an active breakpoint, it will also get you to the program's display. However, if you pause exactly on a currently active breakpoint (but before encountering it), pressing **Break** will not get you into the program's display. You would have to press **Break** again cause the breakpoint to take immediate effect. **CONT** will then work as expected.

Executing a Number of Statements

Go commands set a tenth temporary breakpoint. They are one-time commands to pause execution before a specified program instruction.

The G command tells the Debugger to Go. If you include a number after the "G", that number of statements is executed, after which the Debugger halts and waits for another command. For example, this command tells the Debugger to Go 8 statements:

```
G 8
```

If no number is given, the remaining instructions are executed (same as pressing **CONT**).

The GF (Go and Flash) command is the same as the G command except execution is slowed and line numbers are flashed in the lower right corner of the screen.

The GT (Go 'Til) command is the same as Go except a location is specified rather than a count. For example, this command tells the Debugger to Go 'Til line 39 is reached:

```
GT 39
```

Another form of this command tells the Debugger to Go 'Til the location is reached a number of times. For example, the following command tells the Debugger to stop before line 41 is executed the third time.

```
GT 41 3
```

The GT statement also allows the command string option. For example, this command directs the Debugger to do the following: execute the program until line 42 is reached, then display the Program Counter and await further instructions.

```
GT 42 "D PC; ?"
```

The GTF (Go 'Til and Flash) command is the same as GT except execution is slowed and line numbers are flashed in the lower right corner of the CRT.

Tracing Program Flow through Procedures

You can also halt execution of a program as it enters and exits procedures. For instance, suppose that you want to halt the program when the current procedure is exited. To do that, execute the PX (Procedure eXit) command:

```
PX
```

Execution will be halted after the procedure is exited (i.e., after the last line of this procedure is executed, but before the subsequent program line is executed). For instance, executing this command while in Level_3 results in this display:

```
>PX
PROC EXITED
```

The Debugger shows that the next line to be executed is line 31.

To halt the program at the point that the current procedure (or main program) calls another procedure, use the PN (Procedure Next) command:

```
PN
```

When the next procedure is encountered, the Debugger reports this message:

```
NEXT PROC
```

and the program is halted before executing the first executable line of the procedure. If the current procedure is exited before another is called, the Debugger reports this message:

```
PROC EXITED
```

and the program is halted before the next executable line of the calling procedure is executed.

A Look at the Stack Frame

Another handy feature to use while walking through the program on a procedure basis is the SF (Stack Frame) command. Here is an example display of this command:

```
>SF
      59  LEVEL_1
PROC ADDRESS      -403316^
CALLED FROM      -402718^
      LINE              74
```

The first line of the display shows the first (executable) line of the program next to the procedure's name. The second line shows the memory address of the procedure (which is not important while debugging Pascal programs). The third line shows the address of the procedure. The fourth line shows the number of the line from which this procedure was called.

Examining Variables

Without the ability to check the value of program variables, debugging a program could become more tedious than it already is. Rest assured that this Debugger does allow you to look at the contents of any variable in computer memory. However, in order to check the contents of program variables, you will need to know two important facts: where they are in memory, and how to format them into an understandable form.

To see where a variable is stored in memory, it is necessary to look at the Compiler listing. Each variable has a negative integer printed next to it on the listing. This negative value is the offset (in bytes) from the base address where the variables are located. The base address for a procedure's local variables is the current stack frame pointer (SF); the main program's variables have a base address offset the value of the program name (here XYZ) from A5.

That's why it's helpful if, when writing the program, you declare each variable on a separate line so that an offset will be printed on the listing for each variable. Alternatively, you can use the \$TABLES\$ Compiler option to get a printout which tells all about each data type and variable. This option is explained further under "Structured Variable Formats".

To format the variable's value in memory, you will need to use the Display command. Let's go back to the example program and let it finish by clearing the breakpoints using "BC" and then press **CONT**. Restart the program and then execute **GT 60** command to Go Til line number 60.

To see the value of the local variable *i* that is declared in the procedure called `Level_1`, look at the Compiler listing (line 14) to see that it has an offset of `-4`. This is an offset from the stack frame pointer (SF) of that procedure. Subtract 4 from the stack frame pointer, and use "`^`" after the expression to indicate you want the contents of the memory location *referenced* by the value of the expression in parentheses. Enter the following command:

```
>D (SF-4)^: ' X = ',I
X = 0
```

To see the value of *y*, execute:

```
>D (SF-8)^: ' Y = ',I
Y = 0
```

And to see the value of *z*, execute:

```
>D (SF-12)^: ' Z = ',I
Z = 0
```

You may also specify that all three integer variables be displayed at the same time by executing this command:

```
>D (SF-12)^:3
0      0      0
```

The display will show the three integer variables separated with spaces. The variable with the offset of -12 will be the first one displayed, the one with the offset of -8 is second, then the third one has offset -4 .

When looking for local variable values, be sure that you have stopped the program in the procedure that defines the variables. Each procedure that is called has a stack frame created for it even if there are no local variables. If you have stopped the program in a procedure which is contained inside of another procedure, you can use the walk commands to get to the stack frames of the outer level procedures (see “Static and Dynamic Links”).

The global variables in the main program or globals declared in modules are located at offsets from their specific global area. The respective areas have a symbol associated with each one. The symbol has a value which is equal to the offset or distance from (A5). So when you reference these variables, add the program or module name to A5 and then subtract the offset for the particular variable location.

For example, if you wanted to see the value of the variable *x* in the main program (here it is named XYZ), use this command:

```
D (A5+XYZ-4)^
```

To see the value of *Y*, execute:

```
D (A5+XYZ-8)^
```

To see the value of the two character variables in *ch1* and *ch2* (of program DEBUG), it is necessary to specify a format, because the default format is integer. To see the variables *ch1* and *ch2*, execute this command:

```
D (A5+XYZ-26)^:2A1
```

The format specifies that 2 Alpha values are to be displayed, each having 1 byte. They are located at an offset of -26 from the value of symbol XYZ, relative to A5.

The processor registers that can have their values displayed are listed below:

```
A0..A7      (the Address registers)
AA          (All Address registers)
D0..D7      (the Data registers)
DD          (all Data registers)
PC          (the Program Counter)
SR          (the Status register)
```

To display the numeric values of the contents of address register A0 and the Program Counter, execute this command:

```
D A0 PC
```

To display the numeric value at the location *referenced* by the the Program Counter (i.e., whose address is stored in the PC), execute the following command:

```
D PC^
```

To display the value at the location *referenced* by the Program Counter, interpreting it as an Assembler language instruction, execute this command (remember that module REVASM must be P-loaded to use this format):

```
D PC^:X
```

The Debugger symbols and corresponding definitions are as follows:

```
LN (Line Number)
EC (Escape Code)
ID (I/O result code)
GB (the Global variable Base)
RB (the code Relocation Base)
SF (the current Stack Frame pointer)
```

Examining Consecutive Memory Locations

The Open command is like the Display command except the address is displayed with the value and you are prompted to press either the up-arrow key or the down-arrow key. This causes the address value to increment or decrement depending on the key choice. The adjustment is 1 byte with the OB command, 2 bytes with the OW command and 4 bytes with the OL command. When you have seen enough, press **Return**, **ENTER**, or **Select** (**EXECUTE**) to terminate Open mode and return to the Debugger command mode. For example, to see the hex values which are the machine codes for the current program, use this command:

```
FH
```

(See the Default Formats section for more details.)

To examine (16-bit) word pointed to by the current contents of the Program Counter, use this command:

```
OW PC^
```

The \triangleright to the right of the display prompts for an up-arrow key ($\boxed{\uparrow}$) or down-arrow key ($\boxed{\downarrow}$). To see the next word in memory, press the up-arrow key. Continue until you have seen enough. Press **Return** or **ENTER** to exit the Open command.

Formats for Structured Variables

There is a mechanism for displaying non sequential values also. It is necessary to specify one memory location to set the memory pointer. Then by using special symbols, you can alter the value in the memory pointer. You can also display the value of the memory pointer. All these symbols are part of the format and are typed following the location specification and a colon (:).

```
"*" is the value of the memory pointer

"<" preceded by a number, decrements the value of the memory
  pointer by the number

">" preceded by a number, increments the value of the memory
  pointer by the number

"^" causes the memory pointer to take the value at the
  location indicated by the current pointer
```

These mechanisms make it possible to examine different fields of structured variables.

First, a note about structured variables. When space is allocated for a structured variable, the number of bytes needed is determined and given to the variable. The individual elements of the structure are then assigned space at ascending locations. For example, if you had the following Pascal record, 14 bytes are needed to store the whole record:

```
Pasc_Rec = RECORD
    x : INTEGER;
    y : INTEGER;
    ch1 : CHAR;
    ch2 : CHAR;
    pointer : ^Pasc_Rec;
END;
```

If a variable of this type is the first variable for a procedure, then the record would occupy the first 14 bytes below the stack frame pointer (SF-14)^. The elements in the record would be at positive offsets from this location. Variable x would have an offset of 0 (SF-14)^; y has an offset of 4 (SF-14+4)^; Ch1 has an offset of 8 (SF-14+8)^; etc. This information is easily obtainable when the \$TABLES\$ Compiler directive is used.

The following drawing illustrates the structure of the RECORD variable in memory.

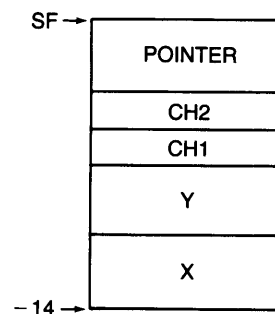

Rather than displaying the values of the record individually, you can use the following Debugger command:

```
D (SF-14)^:I4,4>,2A1,^,4>,I4,*
```

This command tells the Debugger to go to the memory location 14 bytes below the Stack Frame pointer (the bottom of the record), display the four-byte integer (x), go up 4 bytes and display the 2 Alpha characters, assume the value that is stored after the characters (the pointer field), then go up 4 bytes in the new record and display the four-byte integer (y), and then display the current location. Notice that the Debugger display pointer is left at the subsequent locations after the particular displays are made. In other words, after the display of (x), it is only necessary to move 4 bytes rather than 8, to position the display pointer to the character variables.

Changing Memory Contents

The ability to change the values in memory is, among other things, the ability to get a program back on the right track. In one Debugger session, you can detect several problems with a program without having to stop, edit and recompile the program for each one. Simply change the values of the variables that are causing the problem. To change the values of variables in a Pascal program, use the Open commands. Variables are referenced the same way they are with the Display command.

The Open commands are as follows:

- OB - for byte values.
- OW - for word values.
- OL - for long word (four-byte) values.

Suppose you want to change the value of a variable to 8; assume that it is local to the current procedure, that it is an integer variable, and that it has an offset of -4 from the procedure's stack frame pointer (SF). It is necessary to use the OL form of the Open command, since integers are 4 bytes long. Execute the following command:

```
OL (SF-4)^ 8
```

As another example, suppose you want to change the value of the global (main program's) variable ch1 to "x". Because characters only use 1 byte of storage, use the OB form of the command.

```
OB (GB-25)^ "x"
```

By changing the values of those variables, the sequence of execution is drastically altered.

Static and Dynamic Links

Each time a procedure is called in a Pascal program, a new stack frame is created. This stack frame contains all the local variables in the procedure as well as the procedure's static and dynamic links¹.

The Debugger contains a mechanism for following these links. It is the Walk command. The Walk command takes three forms:

- WS - follows the static link back one step.
- WD - follows the dynamic link back one step.
- WR - resets to the current stack frame.

There are no options or parameters. These commands in no way affect or influence program execution.

Restart the Debugger by pressing the **Stop** key and the **D** key. Set a breakpoint on line 31 for the third execution of the procedure `Level_3`.

```
BS 31 3
```

Press **Return** or **ENTER**, and then press **CONT**. The program will stop the third time line 31 is reached.

The sequence of calls is as follows:

```
Program XYZ
  Procedure Level_1
    Procedure Level_2b
      Procedure Level_2a
        Procedure Level_3
          Procedure Level_3
            Procedure Level_3
```

Give six successive WD (Walk Dynamic) commands and you'll get the above information presented in reverse order. The information displayed for each WD command is the stack frame information for the current procedure and then the same for the calling procedure. The stack frame pointer is updated to point to the calling procedure's stack frame. You can look at those variables and the links stored in that stack frame. Consecutive WD commands walk us back through the entire calling sequence. We can stop anywhere along this path and examine the variables in a procedure's stack frame.

¹ Static and dynamic links are described in detail in the section of the Compiler chapter called How Pascal Programs Use the Stack.

To return to the stack frame for Level_3 where you stopped the program, execute a Walk Reset command:

```
WR
```

This command resets the Debugger stack frame pointer variable.

You can also walk the static link. This gives you the ability to examine variables whose scope includes the current procedure. Execute:

```
WS
```

This command brings us to the Stack Frame for Level_2a which contains the variables i, x, and y.

Use the Display command to examine the value of i.

```
D (SF-4)^
```

The value of i is displayed.

```
+2
```

The value of i is only affected by successive executions of Level_3. If Level_3 had local variables, they would display different values in each stack frame. However, only one copy of the variable i exists in the one stack frame for procedure Level_2a. The value of i is as it was when we stopped program execution during the third invocation of Level_3. That value is 3.

Exception Trapping

It is possible to stop execution of a program at an exception to normal processing. Normally, an escape is made by the system and successive recovery mechanisms allow termination of the program. At the time of termination, the system displays the escape code and the line number in the outer level recovery. The escape code is valid information, but the line number may not be the location of the error. By re-executing the program with a trap set for the exception, we can stop execution at the point of the error, have the actual line number of the error displayed, and examine variables for the problem.

There are three commands for exception trapping. We can trap selected escape codes with the Escape Trap instruction. The following command directs the Debugger to trap only escape code 100.

```
ET 100
```

When escape code 100 is encountered, control is returned to the Debugger and the following message is displayed on the screen:

```
-EXCEPTION-
ESCAPE CODE 100
SR=$0000 PC=      -207532 LINE          +12
```

We can stop at all *except* selected escape codes with the Escape Trap Not instruction. This command directs the Debugger to trap every escape code except 100.

```
ETN 100
```

Not specifying an escape code causes the command to work for every escape code. This command directs the Debugger to trap *all* escape codes.

```
ET
```

This command doesn't trap any exceptions.

```
ETN
```

When the exception occurs, execution stops and control is transferred to the Debugger. At that point, you can examine the state of the program.

When the Debugger is initiated, the default escape trapping command is the following:

```
ETN 0 -20
```

These are the escape codes for normal termination and the  key. The Debugger will trap all escape codes except those.

The third type of escape trap command allows you to execute command(s) when the escape is detected. Here is an example:

```
ETC 'D "ESCAPE HAS OCCURRED" ;?'
```

This command displays its message and then halts the program, awaiting further Debugger commands.

Generating Escapes

With the Debugger, you can also generate escapes. For instance, this command generates an ESCAPE(10) at the current point in the program.

```
>EC 10
```

The result of this command is the same as if the program had encountered the escape at the current location. If you have an ET command currently defined for the escape code, the Debugger will trap it also.

A Note about Assembly Language Programs

All of the Debugger commands apply when debugging an Assembler language program as well. The difference is that the location specification is given as an address and not a line number. An address is specified with a “^” appended to the location specifier. For example, the following command says to Go Til the address FFFF 1423 is encountered:

```
GT FFFF1423^
```

The Debugger knows about symbols which have been DEFed. The entry points into assembly modules, programs, and procedures should have been defined (with DEF). You can specify an address in an assembly routine by specifying an offset from the routine's entry point. The offset in the routine can be found on the Assembler output. For example, the following (equivalent) commands direct the Debugger to Go Til encountering the the address 16 decimal (10 hex) memory locations past the entry point into "routine":

```
GT (routine+16)^
```

or:

```
GT (routine+$10)^
```

Read about the particulars of each command in the subsequent Command Reference section.

Debugger Keyboard

This section describes the key definitions while in the Debugger. Note that once you are in the Debugger there are two modes: Command Mode and Step Mode.

A Note about Key Notations

Throughout this section, you will be shown which keys invoke certain Debugger functions. Since you may have one of three different keyboards connected to your computer, each with a different set of keys, you will need to learn which key to press on your keyboard. Here are examples of keys used to invoke a few functions on the three different keyboards.¹

Desired Function	HP 46020A Key(s)	HP 98203B Key(s)	HP 98203A Key(s)
Pause	Break	PAUSE	PSE
Single Step	(System) f5	STEP	STEP
Slow Step	(System) CTRL - f5	CTRL - STEP	CTRL - STEP
Continue	(System) f4	CONTINUE	CONT

For instance, invoke the Pause function on a 46020 keyboard by pressing the **Break** key. On a 98203B keyboard, press the **PAUSE** key. With a 98203A keyboard, press the **PSE** key.

As another example, suppose that you want to invoke the Single-Step function. On both 98203A and B keyboards, press the **STEP** key; the label is *on the key itself*. On a 46020 keyboard it will be the System key labeled **f5** *on the key*, which is labeled **STEP** *on the screen* while in the System-key mode. (If you are not already in System-key mode, then you will need to press the **System** key before pressing **f5**). The same notation is used for the other System keys on the 46020 keyboard (i.e., **f1** through **f8**): the actual System key is not given in text; the label is given instead. You will need to make the association, which you can easily do by looking at the System-key labels while the Menu is being displayed (press the **Menu** key to toggle the Menu on and off). If you are not familiar with the **System** and **Menu** keys, read the discussion in the *Pascal User's Guide*.

The convention used in this manual is to show the 46020 keys first (followed by the equivalent 98203B key in parentheses). For instance, the **Break** (**PAUSE**) key invokes the Pause function: on the 46020, it is the **Break** key; on a 98203B keyboard, it is the **PAUSE** key. (The 98203A **PSE** key is not shown, because it is close enough to the **PAUSE** label that you should be able to easily make the connection.)

Is the Debugger Installed?

Before proceeding, you should verify that the Debugger is currently installed. Press **Break** (**PAUSE**) to pause the system. If a **P** is displayed in the lower, right-hand corner of the screen, then the Debugger is installed. Press **CONT** (**CONTINUE**) to resume operation.

If the Debugger is not installed, then pressing **Break** will do nothing.

¹ This discussion only gives a few examples; the Debugger Keyboard section near the end of the chapter describes all key(s).

Calling the Debugger from the Main Command Level

D From the Main Command Level, pressing the **D** key calls the Debugger (if installed).

Step Modes

Here are the available operations and key definitions while in the Debugger Single-Step and Slow-Step Mode.

Getting into the Step Modes

STEP Causes the program to halt on the next line number; or, if already halted, execute one Pascal statement. (This key gets you into the Single-Step Mode.)

CTRL-**STEP** Causes program execution to be slowed (to about 2 statements per second) and line numbers displayed. (This key gets you into the Slow-Step Mode.)

Controlling Program Execution

Break
(PAUSE) Program execution is paused. Note that the type-ahead buffer is still active and immediate-execute keys still function (e.g., **DMP A**).

Stop Stops program execution.

Getting into Command Mode

CTRL-**Break**
(CTRL)-**(PAUSE)** This key provides immediate entry into Debugger Command Mode.

Returning to the Main Command Level

CONT
(CONTINUE) Causes program execution to resume with Step mode cancelled.

Command Mode

Here is a description of available operations and key definitions while in the Debugger Command Mode. If it is not installed, the command is identical to the eXecute command.

Entering Commands

Alphanumeric Keys Used to enter Debugger commands. The characters generated are uppercase; you must use **Shift** to produce lowercase characters.

Return or **ENTER** Terminates input and initiates execution of the command.

Select
(EXECUTE) Terminates input and initiates execution of the command.

CTRL -ALPHA	Alternates between the Debugger command screen and System screen (CTRL - EXEC on the 98203A keyboard).
Caps	Undefined (keyboard is always in CAPS mode).
Shift with numeric-pad keys	Produces special characters (only 46020 keyboards).
CTRL with alphanumeric and numeric-pad keys	Allows entry of ASCII control characters.
Backspace	Back space the cursor and blanks one character (If the cursor is in the extreme left, this key is a no-op).
Clear line or Delete line (CLR LN or DEL LN)	Clears the input line.
RECALL	Clears the input line and recalls the last executed line.
Insert char (INS CHR)	Inserts one (1) blank character at the cursor position (does <i>not</i> switch to an "insert mode," as there is none).
Delete char (DEL CHR)	Deletes the character at the cursor position.
CLR-END (CLR → END)	Deletes all characters to the right of the cursor.
f1 thru f8 (k0 thru k9)	Typing-aid keys (explained under K commands).
Knob	Same as left/right arrow keys.
Shift -Knob	Same as up/down arrow keys.
Left-arrow and Right-arrow	Move the cursor in the corresponding direction.
Up-arrow and Down-arrow	Have meaning only with the Open commands (OL, OW, OB).

Screen Control

- Clear display**
(CLR SCR) Clears the alpha raster. In Step Modes, this key clears the System screen; in Command mode, it clears the Debugger Command screen.
- ALPHA** Turns on the alpha raster and turns off the graphics raster ((SHIFT)-RCL) on the 98203A keyboard).
- DMP A**
(DUMP ALPHA) Performs a DUMP ALPHA function (the current alpha raster is sent to the PRINTER: volume). ((SHIFT)-INS C) on the 98203A keyboard).
- (CTRL)-ALPHA Alternates between the Debugger and System screen images ((CTRL)-EXEC) on the 98203A keyboard).
- GRAPH**
(GRAPHICS) Turns on the graphics raster and turns off the alpha raster. ((SHIFT)-INS L) on the 98203A keyboard.)
- DMP G**
(DUMP GRAPHICS) Performs a DUMP GRAPHICS function (sends the current graphics raster to the PRINTER: volume). ((SHIFT)-DEL C) on the 98203A keyboard.)

Controlling Program Execution

- Break**
(PAUSE) Program execution is paused. Note that the type-ahead buffer is still active and immediate-execute keys still function (e.g., DMP A).
- Stop** Stops program execution.

Getting into a Step Mode

- STEP** Causes the program to continue executing until the next line number is encountered (i.e., gets you into Single-Step Mode).
- (CTRL)-STEP Causes the program to continue executing slowly, and line numbers displayed as encountered (i.e., gets you into Slow-Step Mode).

Returning to the Main Command Level

- CONT**
(CONTINUE) Causes program execution to resume with Command mode cancelled.

Debugger Command Summary

This section briefly summarizes the Debugger commands for quick reference purposes. A more complete description of each command is presented in the following Command Reference section.

Breakpoint Commands

- BS** – Sets a breakpoint at the specified location.
- BD** – Disables (but does not remove) breakpoint(s).
- BA** – Activates disabled breakpoint(s).
- BC** – Clears breakpoint(s).
- B** – Displays the breakpoint table.

Call Command

- CALL** – Calls the machine language routine at the specified memory address.

Display Commands

- D** – Displays the specified object(s). Objects can be specified immediately, directly, or indirectly. Formats describe the internal representation of the data.
- TD** – Displays the command string which is defined by the softkey **k4**.
- TD I** – Restores the initial command string to **k4**.

Dump Commands

- DA** – Performs the DUMP ALPHA function.
- DG** – Performs the DUMP GRAPHICS function.

Escape Code Commands

- EC** – Generates the specified escape.
- ET** – Sets up escape trapping of specified escape codes; Debugger halts when an escape is executed.
- ETC** – Sets up escape trapping of all codes; Debugger executes the specified command when an escape is executed.
- ETN** – Sets up escape trapping of all codes *except* those specified; Debugger executes the specified command when an escape is executed.

Format Commands

- FB** – Sets the default display format to Binary.
- FH** – Sets the default display format to Hexadecimal.
- FI** – Sets the default display format to signed Integer.
- FO** – Sets the default display format to Octal.
- FU** – Sets the default display format to Unsigned integer.

Go Commands

- G** – Causes execution to resume (same as **CONTINUE**).
- GT** – Causes execution to resume until specified location is encountered.
- GTF** or **GFT** – Same as GT except that execution is slowed and the line numbers are flashed in the lower right-hand corner of the screen.

IF, ELSE, and END Commands

IF – Allows conditional execution of subsequent commands based on the result of evaluating the specified expression.

ELSE – Delimits the commands that will be executed when the IF condition is FALSE.

END – Ends the IF command.

Open Memory Commands

OB, OL, and OW – Used to display (and optionally alter) the values of memory locations.

Procedure Commands

PN – Halts program execution when the next procedure is called (or when the current one is exited, whichever occurs first).

PX, or P – Halts program execution when the current procedure is exited.

Queue Commands

Q – Displays the Queue, which is a record of which line numbers were executed (or PC values of instructions executed).

QE – Ends recording of line number values in the Queue.

QS – Starts the recording of information in the Queue.

Register Operations

A0..A7, D0..D7, PC, SP, US, SR – Display or assign values to the corresponding processor register(s).

Softkey Commands

k0 .. k9 – Defines the command string to be displayed when the softkey is pressed (while in the Debugger).

System Boot Command

sb – The system boot command puts the computer in the power-up state for re-booting. (The command must be typed in lowercase letters.)

Trace Commands

T – Causes the specified number of instructions to be executed, each followed by an implicit TD command.

TQ – Same as the T command except that the TD command is executed only after the last instruction.

TT – Same as TQ except that a location is specified rather than a count.

Walk Procedure Links Commands

WD – The Stack Frame pointer (SF) is moved to the stack frame of the calling procedure.

WS – The SF is moved to the stack frame of the nesting procedure.

WR – The SF is returned to the current stack frame.

Debugger Command Reference

This section contains a formal description of syntax and semantics for each Debugger command.

Debugger Expressions

With the Debugger, all expressions are *integer* expressions.

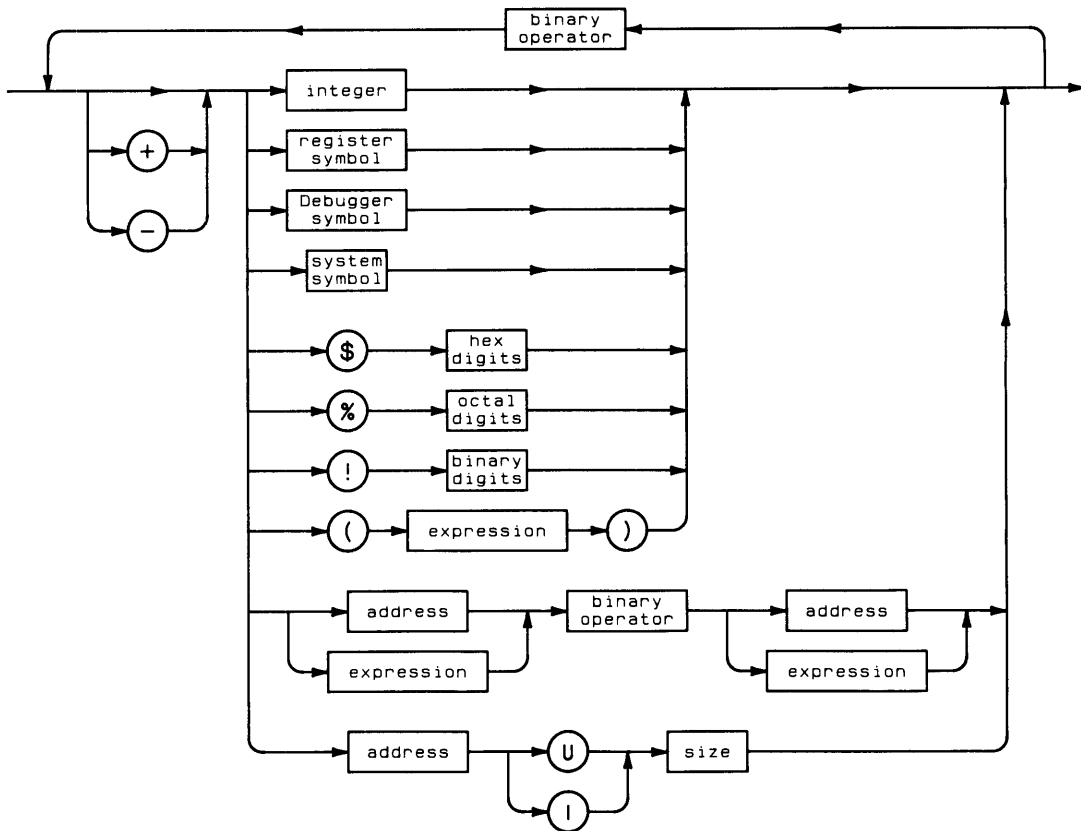

Item	Description/Default	Range Restrictions
binary operator	an operator that requires two operands	+ , - , / , * < , <= , = , >= , > , <>
register symbol	a symbol representing a processor register	A0..A7, D0..D7, PC, SP, US, SR
Debugger symbol	a symbol known to the Debugger	LN (Line Number) EC (Escape Code) IO (I/O result code) GB (the Global variable Base) RB (the code Relocation Base) SF (the current Stack Frame pointer)
system symbol	any symbol in the system symbol table	-
address	an integer numeric expression followed by a “^”, which refers to the contents of the specified memory address	- 2 ³¹ thru 2 ³¹ - 1
size	integer expression that specifies the number of bytes to be used	1 thru 4

The “U” (unsigned integer) and “I” (signed integer) option paths indicate whether the value at the specified address and with specified number of bytes (size) is to be treated as a signed or unsigned integer.

Multiple Commands on a Line

Several commands may be entered on the same line. These commands are separated by a semicolon (;).

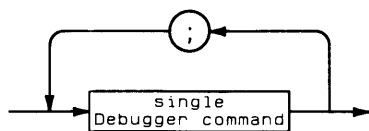

Breakpoint Commands

Breakpoints are points in a program where execution may be halted. The Breakpoint commands control program execution by setting up, activating, and clearing breakpoints in a program.

B

The “B” command causes the breakpoint table to be displayed.

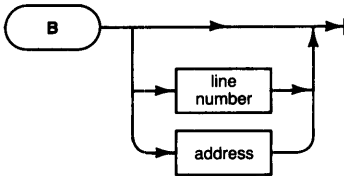

Item	Description/Default	Range Restrictions
line number	an expression that identifies a program line	0 thru $2^{16}-1$
address	an expression, followed by a “^”, that identifies a location in memory	-2^{31} thru $2^{31}-1$

The first column contains an “A” for an active breakpoint or a “D” for a deactivated breakpoint. If no location is specified, the table displays all breakpoints.

BA

The “BA” command Activates disabled breakpoints. If a location is specified, then only that breakpoint is re-activated; otherwise, all breakpoints are re-activated.

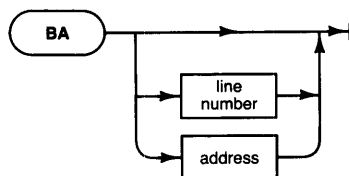

Item	Description/Default	Range Restrictions
line number	an expression that identifies a program line	0 thru $2^{16}-1$
address	an expression, followed by a “^”, that identifies a location in memory	-2^{31} thru $2^{31}-1$

BC

The “BC” command Clears breakpoints. If a location is specified, then only that breakpoint is cleared; otherwise, all breakpoints are cleared.

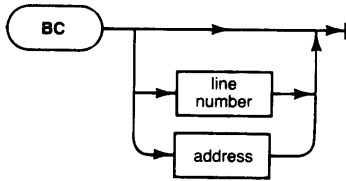

Item	Description/Default	Range Restrictions
line number	an expression that identifies a program line	0 thru $2^{16}-1$
address	an expression, followed by a “^”, that identifies a location in memory	-2^{31} thru $2^{31}-1$

BD

The “BD” command De-activates breakpoints. If a location is specified, then only that breakpoint is de-activated; otherwise, all breakpoints are de-activated.

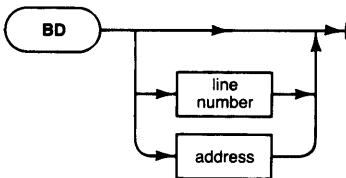

Item	Description/Default	Range Restrictions
line number	an expression that identifies a program line	0 thru $2^{16}-1$
address	an expression, followed by a “^”, that identifies a location in memory	-2^{31} thru $2^{31}-1$

BS

Setting breakpoints with the “BS” command causes the program to stop or perform some operation at a given line number or instruction address.

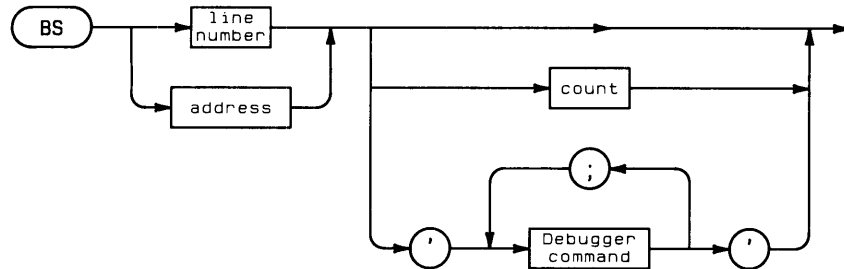

Item	Description/Default	Range Restrictions
line number	an expression that identifies a program line	0 thru $2^{16}-1$
address	an expression, followed by a “^”, that identifies a location in memory	-2^{31} thru $2^{31}-1$
count	expression	-2^{31} thru $2^{31}-1$
Debugger command	command(s) to be executed when breakpoint reached	any legal Debugger command(s)

If only a location is specified, the breakpoint is set at that location and then activated. The program will halt just *before* it subsequently reaches that point.

Specifying a count sets a breakpoint that will halt the program after the count has been decremented to 0. (The count is decremented each time the location is reached.) When the program is halted, this type of breakpoint is automatically cleared. (The other two types of breakpoints set with the BS command are not cleared when encountered.)

Adding a command string to the breakpoint causes the command to be executed each time the point is reached. A “?” in the command string causes the Debugger to wait for input from the keyboard. Otherwise, the command is executed and program execution resumes.

The Call Command

This command is used to call the subroutine at the specified address.

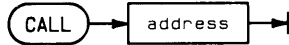

Item	Description/Default	Range Restrictions
address	an expression, followed by a “^”, that identifies a location in memory	-2^{31} thru $2^{31} - 1$

The effect of this command is as if a Jump to Subroutine (JSR) instruction was encountered just before the current program counter (PC).

The CALL command can be abbreviated with the letters CA.

Display Command

D

The D command is like a print statement where the parameters are objects and formats.

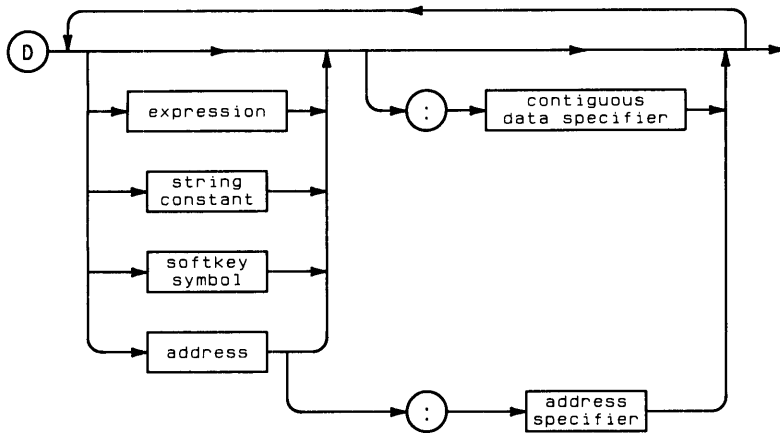

contiguous data specifier:

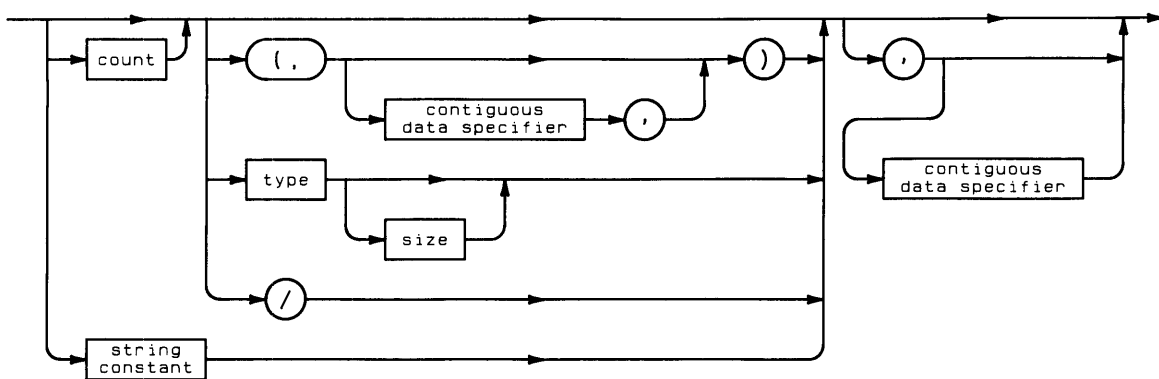

address specifier:

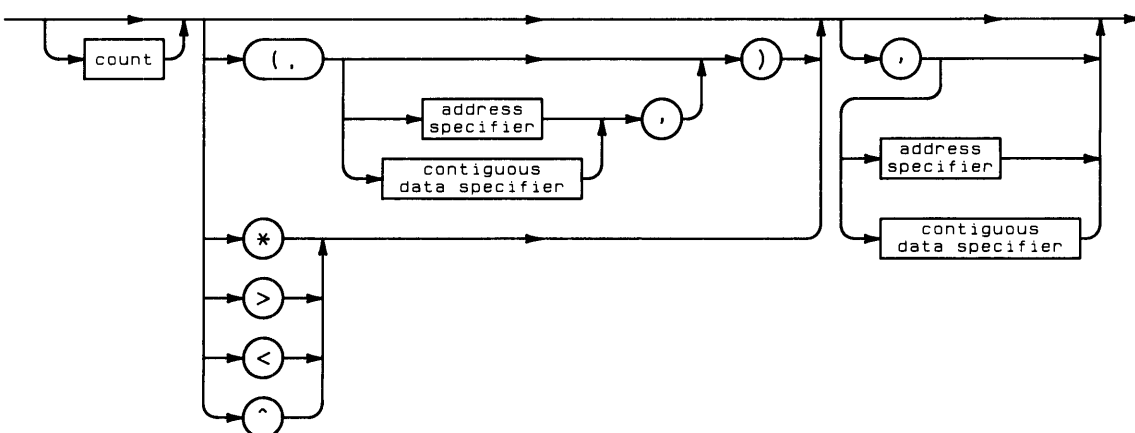

Item	Description/Default	Range Restrictions
expression	integer expression	-2^{31} thru $2^{31} - 1$
string constant	literal value	any character delimited with single or double quotes
softkey symbol	a symbol (not the actual key)	K0 thru K9
address	an expression, followed by a “^”, that identifies a location in memory	-2^{31} thru $2^{31} - 1$
count	integer constant	1 thru $2^{31} - 1$
contiguous data specifier	specifier that identifies the format of data which is contiguous in memory (i.e., memory pointer symbols * etc. not used)	see drawing (nesting limit is 3)
address specifier	specifier that identifies an address in memory (memory pointer symbols such as * may be used)	see drawing (nesting limit is 3)
type	A = Alpha character B = Binary H = Hexadecimal I = Integer (size = 1..4) O = Octal (size = 1..4) S = String type (size is declared size) R = Real (size not allowed) U = Unsigned integer X = reverse assembly (size not allowed)	
size	integer constant	-2^{31} thru $2^{31} - 1$ (except where noted above)

Objects can be immediate, direct, or indirect.

Formats describe the internal representation of the data. Non-consecutive data can be displayed using the format options available when the address parameter is used.

If a format of type S includes a count parameter, then a size parameter must also be included.

If the output of a Display command fills the screen, a MORE prompt will be issued. A reply of **Return**, **Enter**, or **Select** (**EXECUTE**) will continue the display. **Shift-Select** (**SHIFT-EXECUTE**) will cancel the display and the rest of the command string. All other responses will be ignored.

Dump Commands

These commands allow you to perform the DUMP ALPHA and DUMP GRAPHICS functions while in the Debugger.

DA

The DA command performs the DUMP ALPHA function.



DG

The DG command performs the DUMP GRAPHICS function.



Note

These commands can only be used while executing programs in the processor's "user mode." If attempted while in "supervisor mode," the following error will be reported:

NOT ALLOWED NOW

Escape Code Commands

These commands allow you generate and trap escape codes while in the Debugger.

EC

The effect of executing this command is the same as if you had executed an ESCAPE(code) in the program just before the current PC. If any ET, ETC, or ETN commands have been used to set up escape code trapping, then the Debugger will be halted and the escape code displayed on the screen.

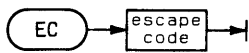

Item	Description/Default	Range Restrictions
escape code	signed integer expression; negative for system escapes, positive for user escapes.	-2^{15} thru 2^{15}

Here is an example display:

```
>EC 10
-EXCEPTION-
ESCAPE CODE      +10
SR=$0004 PC=    -228230 LINE      +9
```

ET

The Escape Trap command allows you to specify that either all escape codes or specified escape codes are to be trapped by the Debugger.

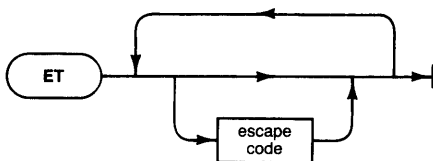

Item	Description/Default	Range Restrictions
escape code	signed integer expression; negative for system escapes, positive for user escapes	-2^{15} thru $2^{15} - 1$

If an escape code that is in the list is encountered, execution stops and control is given to the Debugger. If no escape codes are specified, then processing stops for all escape codes.

Up to 4 escape codes may be specified with the ET command.

ETC

The Escape Trap Command allows you to set up command(s) to be executed when an ESCAPE is generated.

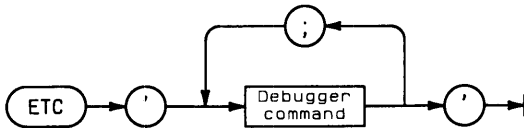

Item	Description/Default	Range Restrictions
Debugger command	command to be executed when an escape is encountered	any valid Debugger command

ETN

The Escape Trap Not command specifies that processing should stop for all escape codes *except* the ones listed. If none are listed, then processing won't stop for *any* escape codes.

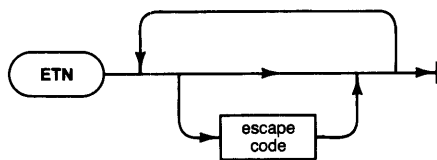

Item	Description/Default	Range Restrictions
escape code	signed integer expression; negative for system escapes, positive for user escapes	-2^{15} thru $2^{15} - 1$

If the program was started with the D command, then ETN -20 0 (which traps all except the **Stop** key and normal program termination) is in effect.

Up to 4 escape codes may be specified with the ETN command.

Format Commands

The format commands allow you to specify the default display format.

FB

The Format Binary command sets the default format to Binary values.



FH

The Format Hex command sets the default format to Hexadecimal values.

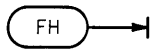

FI

The Format Integer command sets the default format to signed Integer values.

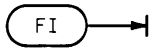

FO

The Format Octal command sets the default format to signed Octal values.

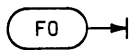

FU

The Format Integer command sets the default format to Unsigned integer values.

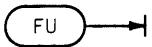

Go Commands

The Go commands control program execution by telling the Debugger how many lines to execute or the line at which to halt.

G

The “G” command causes normal execution to resume. If a count option is used, that number of statements are executed.

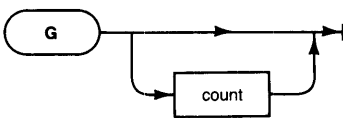

Item	Description/Default	Range Restrictions
count	integer expression	1 thru $2^{15} - 1$

GF

The “GF” command is the same as the “G” command except execution is slowed and line numbers are Flashed in the lower right corner of the CRT.

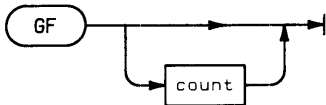

Item	Description/Default	Range Restrictions
count	integer expression	1 thru $2^{15} - 1$

GT

The “GT” command causes execution to Go 'Til the specified location is reached.

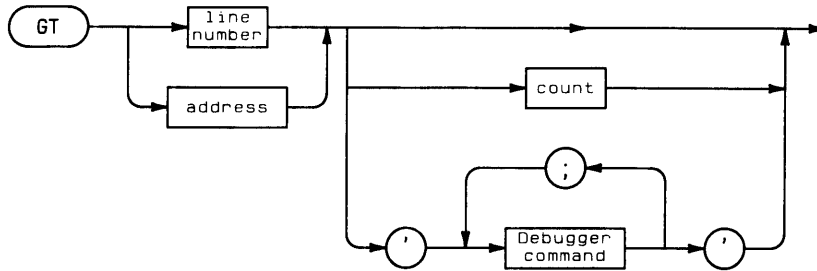

Item	Description/Default	Range Restrictions
line number	an expression that identifies a program line	0 thru $2^{16} - 1$
address	integer expression, followed by a “^”, that identifies a location in memory	-2^{31} thru $2^{31} - 1$
count	integer constant	1 thru $2^{31} - 1$
Debugger command	command(s) to be executed when the specified line or address is reached	any legal Debugger command(s)

If a count option is used, execution continues until the location is reached that number of times.

If the Debugger command option is used, the command(s) are executed when the location is reached.

GTF

The “GTF” command is the same as the “GT” command except execution is slowed and line numbers are flashed in the lower right corner of the CRT.

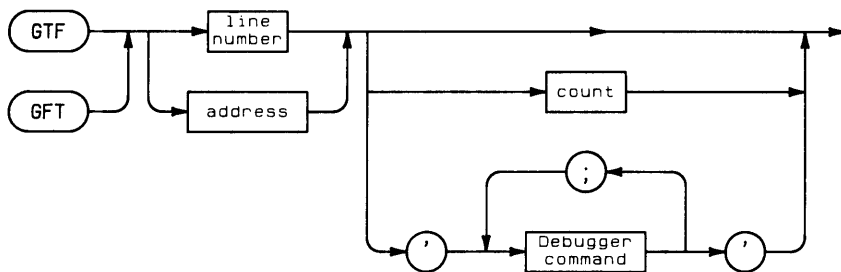

Item	Description/Default	Range Restrictions
line number	an expression that identifies a program line	0 thru $2^{16} - 1$
address	integer expression, followed by a “^”, that identifies a location in memory	-2^{31} thru $2^{31} - 1$
count	integer constant	1 thru $2^{31} - 1$
Debugger command	any legal Debugger commands delimited with single or double quotes	

IF, ELSE, and END Commands

These commands allow conditional execution of Debugger commands.

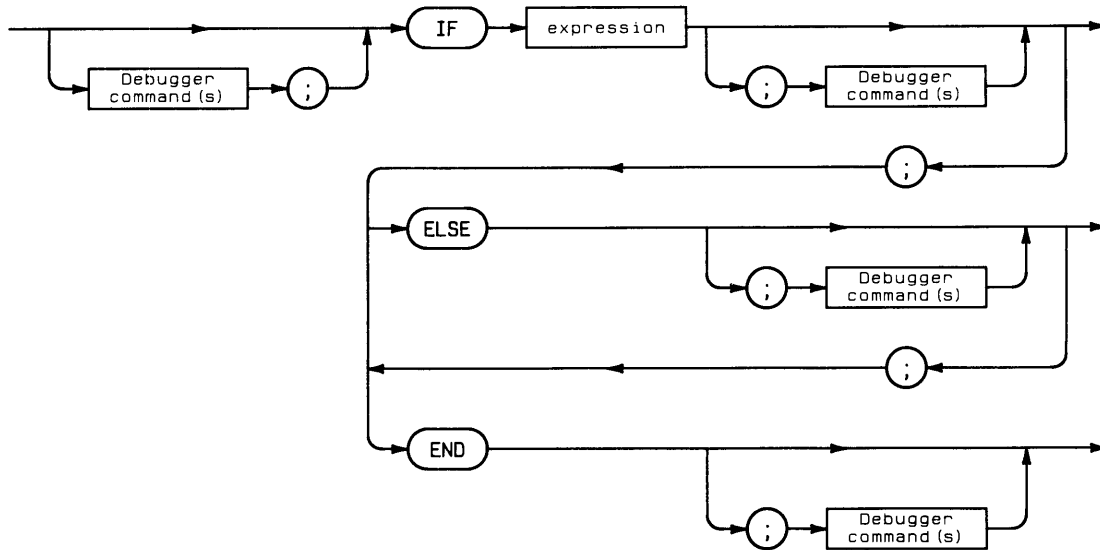

Debugger command (s):

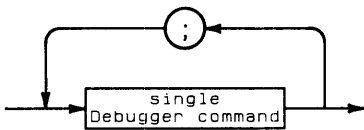

Item	Description/Default	Range Restrictions
Debugger command(s)	command(s) to be executed when the sense bit is TRUE	see drawing
expression	numeric or boolean expression whose value determines the state of the "sense bit"	any valid Debugger expression
single Debugger command	one Debugger command	any valid Debugger command described in this reference section

In order to better understand how IF, ELSE, and END statements work, you need some background information. There is a sense bit that determines whether or not Debugger commands are executed. This sense bit is set to TRUE at the beginning of every command line. Commands on the line are executed as long as this bit is TRUE and skipped when the sense bit is FALSE.

When an IF statement is encountered, the expression is evaluated. If it evaluates to non-zero or TRUE, then the sense bit is set TRUE. Subsequent commands are executed while this bit is TRUE. When an ELSE command is encountered, the sense bit is complemented (i.e., if it was TRUE, then it is set to FALSE, and vice versa). When an END statement is encountered, the sense bit is set to TRUE. Here is an example of this situation:

```
>IF 1=1;D 'NON-ZERO';D 'TRUE';ELSE;D 'ZERO';D 'FALSE';END;D 'ALWAYS'
NON-ZERO
TRUE
ALWAYS
```

Here is an example of the converse situation.

```
>IF 0;D 'NON-ZERO';D 'TRUE';ELSE;D 'ZERO';D 'FALSE';END;D 'ALWAYS'
ZERO
FALSE
ALWAYS
```

Notice that the commands after the END statement are always executed. Note that the IF statement does not have to be the first command in the line.

The ELSE command can be abbreviated as EL; the END command can be abbreviated as EN.

Open Memory Commands

These commands allow you to examine, and optionally modify, the contents of memory locations.

OL, OW, OB

The Open Byte, Open Long, and Open Word commands are used to examine consecutive memory locations and to assign values to the locations.

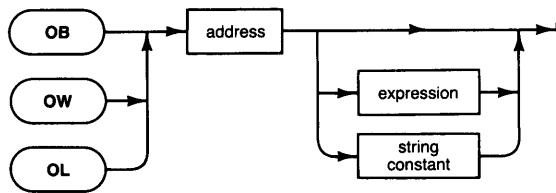

Item	Description/Default	Range Restrictions
address	an expression, followed by a “^”, that identifies a location in memory (with OW and OL, the address must be an even number)	-2^{31} thru $2^{31} - 1$
expression	integer expression	-2^{31} thru $2^{31} - 1$
string constant	literal	any character delimited with single or double quotes

Semantics

When no value is specified after the location, the location and the contents of the location are displayed and followed by a special prompt. The prompt is for an up-arrow key, a down-arrow key, or the **Return** or **Enter** key.

- The up-arrow key causes the next higher location and value to be displayed and the special “Open” prompt.
- The down-arrow key is the same except that the next lower address is displayed.
- The **Return** or **Enter** key causes termination of the “Open” prompt and a return to the standard Debugger prompt.

The amount of the increment/decrement is as follows:

- 1 byte for the “OB” command
- 2 bytes for the “OW” command
- 4 bytes for the “OL” command

When the Open memory commands are used with value options, the specified value is assigned to the corresponding location. No attempt is made to read the corresponding memory location.

Procedure Commands

These commands allow you to halt the program when a procedure is called or exited. Both of these commands will only work if the procedures were compiled with `$DEBUG ON$`.

PN

The PN (Procedure Next) command halts the Debugger when a procedure is called by the current procedure or main program (or when the current procedure is exited).



When the current procedure or main program calls another procedure, the Debugger displays `NEXT PROC` and halts the program *before* executing the first line of the called procedure.

If the current procedure is exited before another is called, the message `PROC EXITED` is displayed and the Debugger is halted *before* executing the first line of the procedure that called the current one.

PX

The PX (Procedure eXit) command allows you to halt program execution when the current procedure is exited.

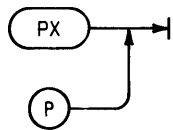

When the current procedure is exited, the message `PROC EXITED` is displayed and the program is halted *before* executing the next line of the procedure that called the current one. Calling a procedure while in the current one is not reported (as it is with PN).

Queue Commands

The Queue commands control and display the Queue, which is a record of the line numbers of statements (or memory addresses of processor instructions) encountered during the execution of a program.

Q

The “Q” command displays the addresses or line numbers and addresses of the most recent statements executed since a “QS” command or the start of execution of the current program.

Q →

“MORE” is given as a prompt when part of the Queue has been displayed and there is more to come; a reply of **Return**, **Enter**, or **Select** (**EXECUTE**) will cause the next 1..21 Queue entries to be displayed. Any other reply will be interpreted as another command.

QE

“QE” ends the recording of information in the Queue

QE →

QS

“QS” starts the recording of information in the Queue

QS →

Softkey Commands

The Softkey commands allow you to define System softkeys to display literal values and commands, so that these keys will be used as typing aids.

“K0” thru “K9”

These commands allow you to define the softkeys as typing-aid keys; when the softkey is subsequently pressed, it puts the string constant or the result of evaluating the integer expression into the Debugger command-input line.

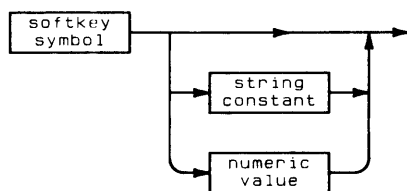

Item	Description/Default	Range Restrictions
softkey symbol	literal symbol that denotes a softkey	K0 thru K9
string constant	literal value	any characters delimited with single or double quotes
numeric value	integer expression	-2^{31} thru $2^{31} - 1$

Numeric values or command strings can be assigned to the softkey symbols K0 through K9 by typing the key *symbol* (not by pressing the actual key) and then typing the value to be assigned to the key.

If a string constant is assigned to the softkey symbol, subsequently pressing the corresponding softkey will cause the literal value to be placed in the Debugger command-input line. If a numeric expression is assigned to the softkey symbol, the *result* of evaluating the expression is placed in the input line.

After the command on a line is completed, pressing **Return**, **ENTER**, or **Select** (**EXECUTE**) causes the line to be interpreted.

To see the string constant or numeric value that is currently assigned to a softkey symbol, type the *symbol* and press **Return**.

Register Operations

A0...A7, D0...D7, SP, US, SR, PC

Registers can have their contents displayed or altered. If a value follows the register symbol, that value is assigned to the register. Otherwise, the current value of the symbol is displayed. Without the assignment, the command is the same as the D command.

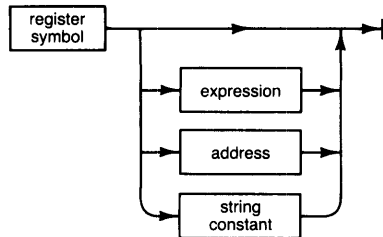

Items	Description/Default	Range Restrictions
register symbol	A0...A7, D0...D7, SP, US, SR, PC AA = All Address registers DD = All Data registers	
expression	integer numeric expression	-2^{31} thru $2^{31} - 1$
string constant	any characters delimited with single or double quotes	

“AA” and “DD” cannot be used to assign values.

System Boot

The “sb” command places the computer in the “power-up” state for rebooting. The command must be typed in lowercase.

sb →

Trace Commands

T

The “T” command with count specification causes that number of machine instructions to be executed. A “TD” command is executed after each machine instruction.

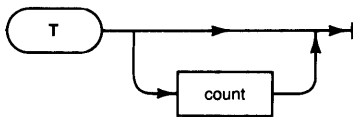

Items	Description/Default	Range Restrictions
count	integer expression	1 thru $2^{31} - 1$

For use with Assembly Language debugging. This command ignores address break points.

TD

The TD (Trace Dump) command displays the command string which is defined by the **f4** (**k4**) softkey.

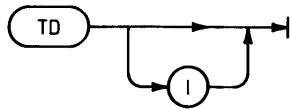

At power up, **f4** is defined to display the PC, the instruction at (PC), the status register, the SP, and all the A (address) and D (data) registers. This display may be altered by changing the definition of **f4**.

The optional parameter “I” restores the initial definition to softkey **f4**.

TQ

TQ (Trace Quiet) is the same as the T command except a TD command is only executed after the last instruction.

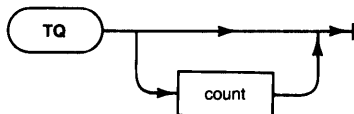

Items	Description/Default	Range Restrictions
count	Integer expression	1 thru $2^{31} - 1$

For use with Assembly Language debugging. This command ignores address break points.

TT

TT (Trace 'Til) causes machine instructions to be executed until the specified line number or address is reached. TT is like TQ in that a TD command is executed only after the last statement or instruction is executed.

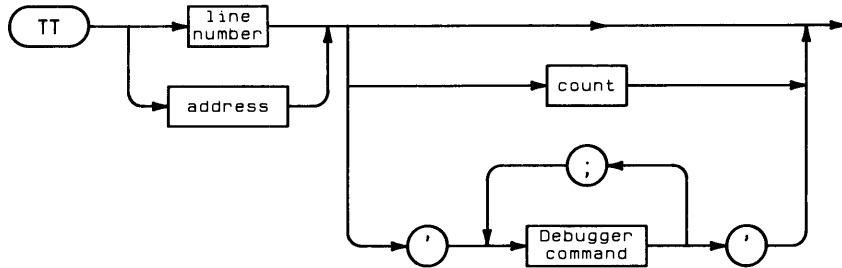

Items	Description/Default	Range Restrictions
line number	an integer expression identifying a program line.	0 thru $2^{16} - 1$
address	an integer numeric expression followed by a “~”	-2^{31} thru $2^{31} - 1$
count	integer expression	-1 thru $2^{31} - 1$
debugger command	any legal commands delimited with single or double quotes	

For use with Assembly Language debugging. This command ignores address break points.

Walk The Procedure Links

WD

Walk the Dynamic link. This command causes the stack frame pointer to move to the stack frame of the calling procedure.



WR

Walk Reset. Brings the stack frame pointer to the stack frame of the current procedure.



WS

Walk the Static link. This command is the same as the "WD" command except that the stack frame pointer takes the value of the static link. This brings you to the stack frame of the nesting procedure as opposed to the calling procedure. Level 1 procedures have no static link.



Technical Reference

This appendix contains the following useful reference information.

- A “System History” section that describes the additional features provided by Pascal System versions 2.x and 3.x
- A discussion of file interchange between the Pascal System and Series 200/300 BASIC Systems
- A list of module names used by this Operating System
- A physical memory map
- A software memory map

System History

This section first briefly describes the 1.0 version Pascal Workstation System, and then describes each subsequent version from the standpoint of what features have been added or changed by the version. It is intended to help you make the transition from earlier versions of the system to the 3.0 system.

Pascal 1.0

Here is a brief description of the Pascal 1.0 System. It is put here in order to give you a reference point from which to begin the comparison of later systems.

System Discs

The Pascal 1.0 Workstation System was distributed on a set of four mini-floppy discs, plus one additional disc for documentation. Here are the disc names:

```
BOOT :
SYSVOL :
ACCESS :
COMPASM :
DOC :
```

The SYSVOL:SYSTEM.LIBRARY file contained the entire complement of IO, GRAPHICS, and INTERFACE modules. The unmodified BOOT:SYSTEM.INITLIB contained device-driver software for all peripheral devices supported by the 1.0 system.

Documentation

Documentation for the 1.0 system included the following five manuals.

Problem Solving and Programming with Pascal – This is the textbook from which you can learn about Pascal programming, if you don't already know how to program in this language.

Pascal Language System User's Manual – This manual described booting the system and using each of the subsystems, such as the Editor, Compiler, and Assembler.

Pascal Procedure Library User's Manual – This manual described using the libraries supplied with the system. The libraries consisted of I/O, graphics, LIF-ASCII Filer, Heap Management, and other procedures (etc.) provided with the system.

MC 68000 User's Manual – This manual described MC68000 processor hardware and instruction set.

The Pascal Handbook – This manual described the Pascal language and extensions supported by the Series 200 Computers.

Computers Supported by 1.0

Pascal 1.0 supported only the 9826 and 9836, since they were the only Series 200 computers in production at the introduction of the Pascal 1.0 Workstation System.

Peripheral Devices Supported by 1.0

Pascal 1.0 supported the following mass storage devices:

- Internal 5.25-inch flexible disc drive
- HP 9885 and 9895 8-inch Flexible Disc Drives
- HP 9134 Hard Disc Drives

Pascal 2.0 and 2.1

Here are the additions to the 1.0 system and differences between the 2.1, 2.0, and 1.0 versions of the system.

System Discs

Pascal 2.0 and 2.1 Systems were distributed on six system discs, plus one documentation disc. Here are the names of the discs.

```

BOOT:
SYSVOL:
ACCESS:
CMPASM:
LIB:
CONFIG:
DOC:

```

In contrast to the 1.0 file, the 2.x SYSVOL:LIBRARY was almost empty; the IO, GRAPHICS, and INTERFACE libraries were supplied on separate discs. The user could put just the ones he wanted into his System Library (usually the LIBRARY file). In addition, the Pascal 2.1 GRAPHICS library was re-structured internally and at the user-procedure level.

The Initialization Library (BOOT:INITLIB) supplied contained device-driver software for the most common peripherals but not for all; this was done to conserve memory for the average user, since Pascal 2.x supported many more peripheral devices. The less commonly needed drivers were supplied on the separate CONFIG: disc. Thus, to configure a system to use certain peripherals, the Librarian needed to be used to install the required driver software in INITLIB. Documentation was provided which explained how and when to add optional modules to the INITLIB file.

Documentation

Documentation for the 2.0 system consisted of the five manuals supplied with the 1.0 system, plus the additional *System Internals Documentation* set. This set consisted of these three manuals:

Pascal 2.0 System Designer's Guide – This manual described much of the inner workings of the Pascal system. It contained enough detail to allow you to use many of the “kernel” modules, and it also provided a fairly detailed description of Boot ROM contents and internal computer (hardware and software) architecture.

Pascal 2.0 Source Code Listings (Volume I) – This manual consisted of a cross reference of Pascal procedure names used in the system, and listings of Assembler language modules in the system.

Pascal 2.0 Source Code Listings (Volume II) – This manual consisted of the listings of many Pascal modules used in the system.

File System

HP's Logical Interchange Format (LIF) directory structure was made the primary disc organization for 2.0 and later versions. (LIF ASCII files are intended for interchangeability with other HP products.) The 1.0 file system was only able to cleanly handle UCSD directory organizations. HP provided a library of routines to access LIF discs, but they were not integrated into the File System.

The LIF library is not present in the 2.0 and later versions, since it is no longer necessary. The Lfiler (LIF Filer) is also unnecessary and has gone away, since the standard system Filer can now do the job. The 2.0 and later Filers are completely revised programs, although their behaviors are as similar as possible to the 1.0 Filer.

If you were using the 1.0 version and are switching to a later release, don't panic! This does not mean that Pascal 1.0 discs are inaccessible, or even that you need to convert them. See the Special Configurations section of the Technical Reference Appendix for details.

The 2.0 and later File Systems are completely reorganized in comparison to the 1.0 File System. The File System is now broken into levels called File Support (FS), Directory Access Method (DAM), Access Method (AM), and Transfer Method (TM). This organization allows the system to handle any number of different directory formats, and separates out the processing of each type of file structure which is supported. In fact, a customer can invent a new directory format or file type and bind it into the system so it can be used by all programs.

The Directory Access Methods now supported are as follows:

- HP Logical Interchange Format (LIF)
- Shared Resource Manager hierarchical "structured" format (SDF)
- UCSD-compatible (same format as Pascal 1.0)

All these directory organizations are available through normal Pascal file operations. Files generated under Pascal 1.0 are all still fully usable. However, the newer systems can generate files and discs which cannot be properly interpreted by the 1.0 File System.

System File Names

The names of system files were changed with the 2.0 system. They were changed because their length was longer than allowed by the LIF directory format. The name changes are as follows:

Old 1.0 File Name	New Name
SYSTEM.LINKER	LIBRARIAN
SYSTEM.EDITOR	EDITOR
SYSTEM.FILER	FILER
SYSTEM.COMPILER	COMPILER
SYSTEM.ASSMBLER	ASSEMBLER
SYSTEM.LIBRARY	LIBRARY
SYSTEM.TABLE	TABLE
SYSTEM.INITLIB	INITLIB
SYSTEM.MISCINFO	MISCINFO
SYSTEM.STARTUP	STARTUP

Object Code Compatibility

Several internal File System changes were made with Pascal 2.0. These changes resulted in corresponding changes in the internal representation of object code files. In general, when a version of the system is not compatible with other versions, the leading digit of the version number will be changed. For instance, versions 2.0 and 1.0 are not object-code compatible, while versions 2.1 and 2.0 are.

While it is regrettable, there really is no alternative to these compatibility restrictions. On the positive side, Pascal application programs which don't "fiddle around" in the operating system are forward compatible to 2.x, so recompilation is all that's necessary.

Supervisor Vs. User State

In versions 2.0 and later, user programs run in the 68000's "user" privilege mode, using the user stack pointer (USP). Interrupts run in "supervisor" privilege mode, using the system stack pointer (SSP). This has implications for calling Boot ROM routines, etc. See the *MC60000 User's Manual* for further details regarding these states.

Additional Computer Supported by 2.0

- Model 16 (HP 9816)

Additional Computer Supported by 2.1

- Model 20 (HP 9920)

Peripheral Configuration

The Pascal 2.x BOOT:TABLE auto-configuration program scanned interfaces for various peripherals and automatically assigned File System unit numbers to devices found (if possible). That was a considerable improvement over the 1.0 version of TABLE.

A source-code version (CTABLE.TEXT) was provided with the system. You could look at the program and read the corresponding commentary in the Special Configurations section of the Technical Reference Appendix to see exactly how the auto-configuration program works. You could also modify certain portions of it to make your own special configurations.

Additional Peripherals Supported by 2.0

Here are changes to the list of disc peripherals supported by Pascal 2.0.

- The CS/80 discs (7908 family)
- The Shared Resource Management system
- The HP 8920x 5.25-inch Flexible Disc Drives
- The HP 9121 3.5-inch (Single-Sided) Flexible Disc Drives
- Several new versions of the HP 913x Hard Disc Drives (they appear as one large volume instead of four smaller ones)
- Certain less obvious features were also added. For instance, the 2.0 system could be fairly easily configured to run from a terminal instead of the built-in CRT and keyboard.

Miscellaneous

Up to 65 Kbytes of Global space has been made available with 2.0 and later versions. This change involved a redefinition of the use of register A5, which now points to an address 32 Kbytes *below* the start of Globals rather than above the first global variable. Consequently, routines in the Boot ROM cannot any longer be called directly; a small interfacing routine is now required to set up the registers and fool the TRY-RECOVER mechanism when calling Boot ROM routines.

Pascal 3.0

Here are the differences and additional features provided by the 3.0 version of the system.

System Discs

The Pascal 3.0 System is distributed on 8 discs, plus two for documentation. Here are the names of the discs.

```

BOOT:
SYSVOL:
ACCESS:
CMP:
ASM:
LIB:
FLTLIB:
CONFIG:
DOC:
DGLPRG:

```

The BOOT:INITLIB file contains a more complete set of device-driver modules; for instance, it now contains module CS80 so that these discs will be recognized by the standard system. See the “Adding Modules to INITLIB” section of the “Special Configurations” chapter for a complete list of modules and descriptions of each.

Note that the Assembler and Compiler were put on separate discs due to size. The CMP: disc contains the Compiler. The ASM: disc contains the DEBUGGER program (formerly in BOOT:INITLIB) and the new REVASM (reverse assembler) module.

There are two versions of the GRAPHICS library. The FLTLIB:FGRAPHICS library contains modules optimized for using the HP 98635 Floating-Point Math card; they were compiled with the \$FLOAT_HDW ON\$ Compiler option, and use the 98635 card, if present. The LIB:GRAPHICS library uses routines in the REALS operating system module; these routines also access the Floating-Point Math card, if present, but the overhead in calling the routines decreases execution speed. The 98635 card can be used with all Pascal 3.0 programs, as long as the REALS module is installed (via INITLIB, etc.).

The DGLPRG: disc provides magnetic copy of the example programs given in the new *Pascal 3.0 Graphics Techniques* manual.

Documentation

Here are the documents shipped with the Pascal 3.0 system.

Pascal 3.0 User's Guide – This is a new manual that takes you from booting your system through setting up your “environment.” It provides a “guided tour” of several subsystems, such as the Editor and Filer. You will see all of the steps required to enter, store, compile, and run a simple Pascal program.

Problem Solving and Programming with Pascal – This is the textbook from which you can learn about Pascal programming, if you don't already know how to program in this language.

Pascal 3.0 Workstation System – This manual describes in detail all of the subsystems, such as the Editor, Filer, and Compiler. It also describes such topics as how the computer configures itself to access File System peripherals and how to add new peripherals. This manual was formerly the *Pascal 2.0 User's Manual*. The “Getting Started” information (Chapter 1 of the former manual) has been moved to the new *Pascal 3.0 User's Guide*. Two new chapters have been added: Special Configurations and Non-Disc Mass Storage.

Pascal 3.0 Procedure Library – This manual was formerly the *Pascal Procedure Library User's Manual*. It is basically the same as the former manual, except for the removal of the LIF Procedures and Graphics chapters (graphics is now covered in its own separate manual), and the addition of the System Devices and Segmentation Procedures chapters.

Pascal 3.0 Graphics Techniques – This manual is an expanded version of the Graphics chapter of the former *Pascal Procedure Library User's Manual*. It provides several useful techniques that you can use in writing Pascal graphics programs.

HP Pascal Language Reference for Series 200 Computers – This manual describes the HP Standard Pascal language, as well as the implementation dependencies of the Workstation Pascal language.

MC 68000 User's Manual – This manual describes MC68000 processor hardware and instruction set. It is the same manual as shipped with the 2.x Pascal systems. It also covers the 68008 and 68010 processors.

System Devices Procedural Interface

The procedural interface to “system devices” (such as the keyboard, clock, screen, etc.) has been modified. These changes will not affect the way the system looks at the level of *standard* HP Pascal procedures. However, if any of your programs use procedures *below* this uppermost level (such as procedures in an operating system module), then you may have to make some changes. See the System Devices chapter of the *Pascal 3.0 Procedure Library* for complete details.

Additional Computers and Hardware Features Supported by 3.0

- Model 217 (HP 9817)
- Model 237 (HP 9837)

Both Model 217 and Model 237 have a new type of keyboard which requires Pascal 3.0. The keyboard model number is the HP 46020, which uses the HP Human-Interface Link (HP-HIL) to communicate with the computer.

Pascal 3.0 also supports an optional, “mouse” input device, which can be connected to the computer through the HP Human Interface Link (HP-HIL). The driver (provided on the CONFIG: disc) supports using the mouse for cursor-movement input in both horizontal and vertical directions; it also defines the buttons on the mouse as **Return** or **ENTER** and **Select** (**EXECUTE**) keys. You also can access the mouse from your own applications programs; see the System Devices chapter of the *Pascal Procedure Library* manual for details.

Both Models 217 and 237 may also have processor boards with Memory-Management Unit (MMU) hardware; if so, the product numbers have 'U' suffixes (such as HP 9817U and 9837U). If the cache-memory feature is also present, then the MMU hardware increases the execution speed of programs (because the cache-memory feature is automatically enabled by Pascal 3.0).

The Model 237 implements a new type of display hardware: a bit-mapped combined alpha/graphics display with a raster size of 1024 by 768 pixels on a 19-inch diagonal CRT screen.

Additional Peripherals Supported by 3.0

- The new Command Set/80 (CS80) discs, including the HP 7914, 7933, and 7935 Disc Drives
- New stand-alone DC600 (CS80) Tape Drives; right now this category only includes the HP 9144 Tape Drive
- New Sub-Set/80 (SS80) floppy discs; right now this category only includes the HP 9122 3.5-inch Double-Sided Floppy discs
- Several new versions of the 913x Hard Discs (V and XV suffix drives)

Additional Cards Supported by 3.0

Here are the new cards that are supported by Pascal 3.0

- HP 98255 EPROM and HP 98253 EPROM Programmer cards, which can be used as mass storage devices (see the Non-Disc Mass Storage chapter of this manual for details)
- HP 98259 Magnetic Bubble Memory cards, which can also be used as mass storage devices (see the Non-Disc Mass Storage chapter of this manual for details)
- HP 98635 Floating-Point Math card (see the description of the FLOAT_HDW Compiler option in the Compiler chapter for details)
- HP 98257 1-Megabyte Memory card, which features parity-checking hardware

Peripheral Configuration

How the system boots and auto-configures itself is fully discussed in the Special Configurations chapter. The Pascal 3.0 TABLE program has even more capabilities than the 2.x version: it automatically configures up to 3 floppy disc drives (dual or single) and at least the first hard disc in the system (up to 10 are potentially possible).

A source-code version of the 3.0 TABLE program (CONFIG:CTABLE.TEXT) is also provided with the 3.0 system. You can look at the program and read the corresponding commentary in the Special Configurations chapter to see exactly how the auto-configuration process works, and you can modify certain portions of it to make your own special configurations. A major change with the 3.0 TABLE is that now you can “coalesce” logical volumes on hard discs without the need to modify and re-compile the TABLE source program.

The TABLE program can now easily support printers with RS-232C interfaces by making one small change in the program and re-compiling. See the Special Configurations chapter of this manual for details.

Object Code Compatibility

Several internal changes were made with Pascal 3.0. These changes resulted in corresponding changes in the internal representation of object code files. In general, when a version of the system is not compatible with other versions, the leading digit of the version number will be changed. For instance, versions 3.0 and 2.0 are not object-code compatible, while versions 2.1 and 2.0 are.

While it is regrettable, there really is no alternative to these compatibility restrictions. On the positive side, Pascal application programs which don't “fiddle around” in the operating system are source-code compatible with 3.0, so recompilation is usually all that's necessary.

General System Features Added by 3.0

Stream Files: Stream files on read-only devices are now allowed; adding the [*] specifier to the stream file name allows this usage by disabling the prompt feature. This same mechanism also allows the use of a stream file called AUTOKEYS to provide “autostart” capabilities with read-only system volumes. See the description of the Stream command in the Overview chapter of this manual for details.

Filer: The Filer can now perform a Translate operation to the CONSOLE: volume, with the ability to view the translated file one screen at a time. See the Filer chapter of this manual for details.

Compiler: The following Compiler options were added. The WARN option allows you to disable warning messages. The FLT_HDW option allows you to specify one of three actions: ON specifies that the Compiler is to emit code that assumes a 98635 Floating-Point Math card is installed in the computer; TEST specifies that the emitted code is to test for the presence of the card; OFF specifies that emitted code always uses floating-point library routines. See the Compiler chapter of this manual for details.

Assembler: The Assembler has been modified to allow use of the new op codes provided by the 68010 processor (such as the MOVES and RTD instructions).

Librarian: A special “edit” mode was added to the Librarian. It allows you to add modules to an existing library more easily. The Librarian can also unassemble the new instructions for the 680xx processors (such as the MOVES and RTD instructions). See the Librarian chapter of this manual for details.

Debugger: These are the new commands that have been added to the Debugger: “X” format for reverse assembly; “R” format for displaying REAL numbers; “O” format and FO default format for octal numbers; added repeat counts on format specifiers; “!” input format for binary numbers; “%” input format for octal numbers; relational operators can now be used in expressions; DA and DG commands for DUMP ALPHA and DUMP GRAPHICS functions, and also the ability to use the corresponding keys; four more softkeys now available (10 total); five more breakpoints now available (9 total); PN and PX commands (PX is an alternate syntax for the existing P command); IF, ELSE, and END commands for conditional execution of Debugger commands added; CALL command added; EC and ETC commands added; **PAUSE** key definition changed. See the Debugger chapter of this manual for details.

Segmentation Procedures: Several procedures that add the capability of run-time program segmentation have been added to the system. See the Segmentation Procedures chapter of the *Pascal 3.0 Procedure Library* manual for details.

Pascal 3.01

The purpose of this revision is to fix bugs in version 3.0 of the Pascal system. The 3.01 BOOT: and ASM: discs contain software which corrects the bugs. (Note that other discs have not been revised.)

Note

These revisions do *not* add any features to the system; they only fix bugs in existing features.

Documentation Changes

Since the 3.01 software does not add any features to the system, you may replace references to the 3.0 BOOT: and ASM: discs with references to the 3.01 discs.

Disposition of 3.0 BOOT: and ASM: Discs

If you have version 3.0 BOOT: and ASM: discs, replace them with the 3.01 discs. **Do not use the old discs any longer.**

List of Bugs Fixed

Here are the areas in which bugs have been fixed by the 3.01 revisions:

- Flexible disc initialization on Model 226 and 236 Computers equipped with an HP-UX Memory Management processor board and the 3.0 Boot ROM.
- Softkeys and bus errors while using the Debugger.
- Disassembly of shift and rotate instructions with the REVASM module.
- Model 237 display driver module (CRTB).
- Non-advancing characters on some foreign language keyboards.

Pascal 3.1

The main purpose of this version of the system is to add support of Series 300 computers. It also adds support of a few new peripherals, as well as fixes miscellaneous system bugs discovered since the release of Pascal 3.01.

New Computer Hardware Supported by 3.1

New features of the Series 300 computers include the following:

- Many choices of processor, display, and human interface boards:
 - Five new displays (including a separate, high-speed display controller)
 - Two new processors: MC68010, and MC68020 (with MC68881 math co-processor)
 - Battery-backed, real-time clock
 - RS-232C serial interface (similar to the 98644 serial interface)
 - 46020 HP-HIL keyboard (similar to keyboards used with Models 217 and 237, but different from other Series 200 models)
- Support of two new foreign keyboards (Swiss-German and Swiss French).

For a more complete description of the Series 300 enhancements to Series 200 hardware, see the “Porting to Series 300” chapter of the *Pascal Workstation System* manual.

New Peripherals Supported by 3.1

The 3.1 DGL (Device-independent Graphics Library) provides support for the following new HP-HIL (Hewlett-Packard Human Interface Link) devices:

- HP 46087 and 46088 Graphics Tablets (“absolute” graphics input devices)
- HP 35723 TouchScreen (also an “absolute” input device), which attaches to HP 35731 and 35741 Medium-Resolution, 12-inch monitors

Object Code Compatibility

Pascal 3.1 is generally object-code compatible with Pascal 3.0 and 3.01 programs; i.e., programs compiled on the 3.0 or 3.01 systems will generally run on the 3.1 system (with no re-compilation required). However, you should not use 3.0 or 3.01 libraries on the 3.1 system. See the “Porting to Series 300” chapter of this manual for further information on how to determine object-code compatibility.

Backward compatibility (i.e., running 3.1-compiled programs on a 3.0 or 3.01 system) is not generally supported. This incompatibility is the result of new run-time support modules that were added for the increases in sizes of SET variables (see the description of new Compiler features below for details regarding the increase in SET size) as well as changes in the interface to the SYSDEVS operating system module.

General System Features Added by 3.1

In general, the new system features provided by Pascal 3.1 are related to the support of the new Series 300 computer hardware, or to new HIL peripherals. Here is a brief list of the features, organized according to subsystem.

Compiler: The new COMPILER20 compiler generates MC68020 instructions, and with the FLOAT_HDW Compiler option supports the use of the MC68881 floating-point co-processor. See the “Compiler” chapter of this manual for details.

A larger SET variable size limit is supported (was 256 elements; is now 262 000 elements). The COMPILER was also modified to fully conform to the HP Pascal Standard (the new COMPILER20 compiler also fully conforms):

- Conformant arrays are now supported.
- Passing elements of packed arrays or records as VAR parameters to procedures or functions is now disallowed (preceding Compiler versions allowed it, although the *HP Pascal Language Reference* showed it as disallowed). You must now use the \$ALLOW_PACKED ON\$ compiler option if you want to pass this type of parameter.
- You cannot assign values to the index of a FOR loop within the loop (previous versions allowed it).

See the *HP Pascal Language Reference* for details.

Assembler: The Assembler was upgraded to assemble MC68020 and MC68881 instructions. It also supports a new operand syntax which is required to assemble these instructions. See “Instruction Syntax” in the “Assembler” chapter of this manual.

Librarian: The Librarian was upgraded to dis-assemble all MC68020 and MC68881 instructions.

Debugger: The REVASM module was also upgraded to dis-assemble all MC68020 and MC68881 instructions. Since the MC68020 processor has a 32-bit address bus, all addresses specified in the Debugger command line must contain all 32 bits if located in RAM space (see the subsequent “Physical Memory Map” section for details on RAM space bounds).

Error numbers: ESCAPECODE values 30 (arcsin or arccos argument is greater than 1) and 31 (illegal real number) have been added to report MC68881 floating-point math co-processor errors.

IO Library: The IO library has added two registers for the built-in 98644 RS-232C serial interface in Series 300 computers. They allow you to simulate the configuration switches of the built-in 98626 serial interface of the Series 200 Models 216 and 217 computers. See the “RS-232 Serial Interface” chapter of the *Pascal Procedure Library* manual for details.

SYSDEVS interface: This operating system interface module has been modified in the way that highlight characters (130, 131, and 134 thru 143) are displayed in “debugger windows.” The variable `debughighlight` indicates which highlight(s) should be applied to characters put in a debugger window using the `dbput` operation. The `dbhighlight` operation is a no-op for Series 300 and HP 98700 displays. See the “System Devices” chapter of the *Pascal Procedure Library* manual for details.

Graphics Library: Another version of the Device-independent Graphics Library (DGL) is provided with the system (FLT20:FGRAPH20). It utilizes the MC68020 processor and MC68881 co-processor. (The FGRAPHICS library utilizes the HP 98635 Floating-Point Math Card; the GRAPHICS library uses math libraries.)

System Discs

Two new discs have been added to the 3.1 set (single-sided media options), making a total of 14 discs:

- The BOOT2: disc contains the drivers for the Series 300 displays and for the HP 98700 Display Controller. (The BOOT: disc is provided for Series 200 displays and for the HP 98546 Compatibility Video Card Set; see the “Porting to Series 300” chapter for details of using the Compatibility Card.)
- The CMP20: disc contains a compiler that generates object code for the Series 300 computers that feature an MC68020 processor.
- The FLT20: disc contains a new version of the Device-independent Graphics Library (DGL); the file is named FGRAPH20. The set of procedures it provides is the same as the GRAPHICS and FGRAPHICS libraries, but this library contains code that utilizes the MC68020 processor and MC68881 co-processor (instead of the HP 98635 Floating-Point Math Card).

The contents of the following 3.1 discs have changed slightly from their 3.0 counterparts:

- The LIB: disc has only the IO library.
- The CONFIG: disc has a new file containing the new DGL_ABS module (support for the new HP-HIL graphics tablets and TouchScreen, which are “absolute” input devices).

The rest of the 3.1 discs contain the same files as the 3.0 and 3.01 systems:

```

BOOT:
SYSVOL:
ACCESS:
CMP:
ASM:
GRAPH:
FLTLIB:
DOC:
DGLPRG:

```

Furthermore, the Workstation Pascal System is now available on *double-sided, double-density, 3½-inch, flexible micro-disc media*. With this media option, only eight discs are shipped:

Double-Sided Disc	Corresponding Single-Sided Disc(s)
BOOT:	Same files as single-sided BOOT: disc.
BOOT2:	Same files as single-sided BOOT2: disc.
SYSVOL:	Contains files on single-sided SYSVOL:, LIB:, and GRAPH: discs.
ACCESS:	Contains files on single-sided ACCESS: and CONFIG: discs.
CMP:	Contains files on single-sided CMP: and CMP20: discs.
ASM:	Same files as single-sided ASM: disc.
FLTLIB:	Contains files on single-sided FLTLIB: and FLT20: discs.
DOC:	Contains files on single-sided DOC: and DGLPRG: discs.

Documentation

Manuals for the MC68020 processor and MC68881 co-processor have been added to the documentation set.

Pascal User's Guide: This manual has been updated to parallel the structure of the new *Series 200/300 Peripheral Installation Guide*, as well as to discuss adding new peripherals supported by the 3.1 system.

Workstation Pascal System: The "Compiler" chapter describes the new ALLOW_PACKED option, as well as the addition to the FLOAT_HDW option. The "Assembler" chapter has been revised to describe the new addressing modes available with the MC68020 processor. Chapters 10 through 17 were added to describe Pascal programming topics specific to the Workstation System. Chapter 20 describes the considerations you must take in porting existing Pascal programs for Series 200 computers to run on Series 300 computers.

Pascal Procedure Library: The "RS-232C Serial Interface" chapter describes the new registers for the built-in 98644 serial interface in Series 300 computers. The "System Devices" chapter describes the changes to the SYSDEVS interface.

Pascal Graphics Techniques: The "Interactive Graphics" chapter describes the new HIL input devices (graphics tablets and TouchScreen). The "Color Graphics" chapter describes the use of the new color displays. The "Procedure Reference" section has been updated accordingly.

HP Pascal Language Reference: The "Compiler Options" section of the "Workstation Implementation" appendix describes the new ALLOW_PACKED option, as well as the addition to the FLOAT_HDW option.

All Pascal manuals have new part numbers with this revision of the system.

File Interchange Between Pascal and BASIC

You may wish to exchange data on file between the Pascal and BASIC environments. There are a few rules you should follow.

- Pascal and BASIC treat LIF directories on flexible discs similarly. ASCII text files are intended to be used as the interchange mechanism.
- It was mentioned earlier that Pascal compresses the suffix of user file names in order to effectively allow longer file names. BASIC doesn't know about compressed names, so the BASIC program needs to invert the compression algorithm. This inversion is very simple, and is described in the section of the File System chapter called Programming with Files. Essentially, Pascal chops off the dot and the suffix (such as .ASC), then appends the first letter of the suffix and enough trailing “_” characters to make a 10-character name. Thus “ABC.ASC” becomes “ABCA_____”, which is the name BASIC will see.
- BASIC can't deal with more than one LIF directory on a hard disc; Pascal, unless told otherwise, wants to divide large hard discs into several volumes each with its own directory. Hard disc partitioning is described in the Special Configurations chapter.

If a disc is initialized by BASIC, Pascal and BASIC will both see the disc as one very large volume. Pascal's preference to partition the disc is overridden by what BASIC actually did.

If a disc is initialized by Pascal and partitioned into multiple volumes, BASIC will only see the first volume and will not be able to access any part of the disc beyond the first volume. Pascal will see all the volumes.

See the Special Configurations chapter for information on forcing Pascal to treat a partitionable disc as a single volume.

Notes

Module Names Used by the Operating System

Here are the names of modules that are present in the system as it is shipped from the factory. They are provided so that you will not name a module using any of these names, unless you *definitely* want to override the system module's function.

Note that many of these module names do not show up in the system symbol table (for example, they may have been removed by linking). However, you should not use them, because HP reserves the right to use them in the future.

A complete list of symbol names actually used in the system is provided on the DOC: disc in the file named SYMBOLS.

A804XDVR	DATA_COMM	ERR_INFO	GLE_STROKE
A804XINIT	DC_INITIALIZE	EVALGVR	GLE_TYPES
ABORT_IO	DEBUGGER	EXCP	GLE_UTLS
ALLREALSTUFF	DELAY_TIMER	EXTDC	GP
ALPHAFLAG	DGL_ABS	EXTDLEDI	GPIO
ALPHALIST	DGL_ARAS	EXTG_EG	GPIO_INITIALIZE
AMIGO	DGL_ATEXT	EXTH_EH	GRAPHICSBASE
AMIGODVR	DGL_AUTL	F9885	GRAPHICSFLAG
AMIGOINIT	DGL_CONFIG_IN	F9885DVR	G_DOLLAR
ASC_AM	DGL_CONFIG_OUT	F9885INIT	HPHIL
ASM	DGL_GEN	FGATOR	HPIB
BAT	DGL_HPGL	FLTPTHDW	HPIB_0
BKGND	DGL_HPGLI	FS	HPIB_1
BOOT	DGL_IBODY	GENERAL_0	HPIB_2
BOOTDAMMODULE	DGL_INQ	GENERAL_1	HPIB_3
BUBBLE	DGL_KNOB	GENERAL_2	HPIB_INITIALIZE
BUBBLES	DGL_LIB	GENERAL_3	HPM
BUB_DVR	DGL_POLY	GENERAL_4	HV50
CHECK_TFR	DGL_RAS	GETDMA	HV52
CHECK_TIMER	DGL_RASTER	GLE_ARAS_OUT	INITBAT
CHOOK	DGL_TOOLS	GLE_ASCLIP	INITBKGND
CI	DGL_TYPES	GLE_ATEXT	INITCRT
CLOCK	DGL_VAR	GLE_AUTL	INITKBD
CMD	DGL_VARS	GLE_FILE_IO	INITLOAD
CONVERT	DISCHPIB	GLE_GEN	INITUNITS
CONVERT_TEXT	DISCINT_INITIALIZE	GLE_GENI	INIT_BKGND
CRT	DISC_INTF	GLE_HPGL_IN	INIT_DC
CRTB	DMA	GLE_HPGL_OUT	INIT_DISCINT
CS80	DMA_INITIALIZE	GLE_HPIB_IO	INIT_DMA
CS80DSR	DMA_STBSY	GLE_KNOB_IN	INIT_GPIO
CS80DVR	DROPDMA	GLE_RAS_OUT	INIT_HPIB
CS80INIT	DRVASM	GLE_SCLIP	INIT_RS
CS80_CHAN_INDEP_CLR	EDRIVER	GLE_SMARK	INIT_SRM
CSAMIGO	EPROMS	GLE_STEXT	INIT_TIMER

INSTALL_UCSD_DAM	LOCKMODULE	RELOCATE	STBSY
INSTLIFDAM	LOGEOT	RESETX	STCLR
INST_EPROM	LOGINT	REVASM	SWAP8
INTDC	M68KTYPE	REVASM_MOD	SWAPK
IOCOMASM	MATCHDEFEXT	RND	SYSDEVICES
IODECLARATIONS	MFS	ROMAN	SYSDEVS
IOLIBRARY_KERNEL	MINI	RS	SYSGLOBALS
ISR	MISC	RS232	TAPEBUF
ITXFR	MSYSFLAGS	RS_INITIALIZE	TESTDMA
KATA	NONUSKBD1	SEGMENTER	TEXT_AM
KBD	NONUSKBD2	SERIAL_0	TIMED_OUT
KERNEL	PRINTER	SERIAL_3	TIMEREXISTS
KEYS	PRINTSYMS	SETUPSYS	UCSDMODULE
LAST	PRTDVR	SRM	UCSD_AM
LDR	RAND	SRMAMMODULE	UIO
LIFMODULE	RANDOM	SRMDAMMODULE	WAIT_TFR
LIF_DAM	REALS	STACKFUDGE	WS1.0_DAM
LOADER			

Physical Memory Map

The first part of this section describes the physical hardware memory map of your Series 200/300 computer with regard to ROM space, I/O space and RAM space. This section begins with an overview of the hardware memory layout, followed by a more detailed memory map of each major section of memory.

Register addresses and descriptions are included for the internal I/O devices.

Full 16 Megabyte Addressing Range

There are 23 address lines (BA1..BA23) providing 16 megabyte addressing on WORD boundaries. For byte operations, two control lines BUDS (Buffered Upper Data Strobe) and BLDS (Buffered Lower Data Strobe) indicate whether the upper data byte (BD8 through BD15), the lower data byte (BD0 through BD7), or both bytes are involved in the communication. Note: When BA0 = 0, the high byte is requested. When BA0 = 1, the lower byte is requested.

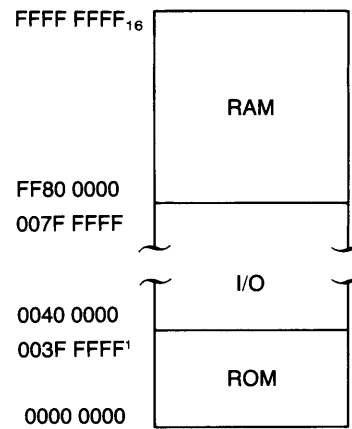

Note

For a complete description of the HP Series 200 computers' physical memory maps, see the *Pascal System Internals* documentation.

¹ On machines with Memory Management Units, the upper limit of ROM address is \$1FFFFFF.

A Hypothetical RAM Configuration

RAM is located in the top half of the 16 megabyte addressing range. The bank select switches on the boards must be set so that the boards are mapped contiguously from highest memory progressing down. Any 1M boards should be set to the highest memory addresses. Any 256K boards should be mapped in next. Any 64K boards are mapped below those. The 64K on the CPU board automatically maps into the first available address below the plug-in boards.

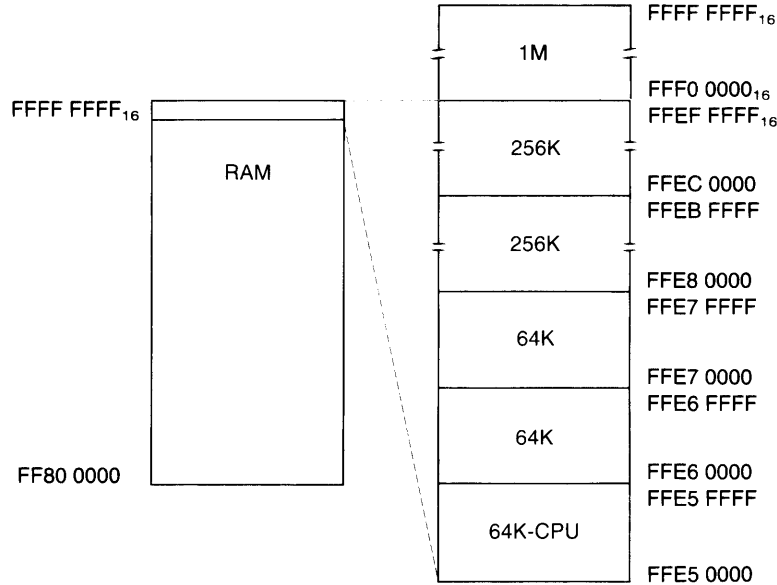

The 1M memory boards have a 4-bit, user-changeable, bank-select switch. The 4 bits of the switch correspond to the 4 MSBs of the address bus. For example, the 1M board above has its switches set as follows:

Msb	Lsb
1	1
1	1

The 256K memory boards have a 6-bit, user-changeable, bank-select switch. The 6 bits of the switch correspond to the 6 MSBs of the address bus. For example, the two 256K boards above have their switches set:

Msb	Lsb
1	1
1	1
1	0
1	0
1	0

respectively.

After all the 256K memory boards have been set in high memory, the 64K boards should then be mapped in. It is necessary to set 8 switches, corresponding to the 8 MSBs of the address bus. For example two 64K boards mapped under the 256K boards above would have their switches set:

Msb	Lsb
11100111	
11100110	

respectively. The 64K on the CPU board automatically maps into the first available memory space down:

Msb	Lsb
11100101	

Note

If the memory boards are not mapped contiguously, the auto-locating memory on the CPU board, if any, maps into the first hole left by the memory boards, and those mapped below the hole are not used.

Note

Setting the switches on two memory boards to the same code could cause damage to the memory boards.

The Overall ROM Memory Map

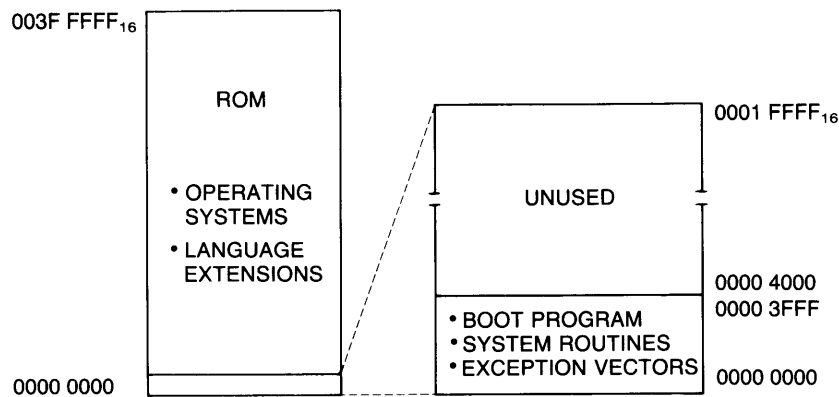

The boot program, exception vectors, and some system routines reside on ROM chips starting at \$000000 and extending to \$003FFF. The space between \$004000 and \$01FFFF is unused. (The BOOTROM 3.0 consists of approximately 48 Kbytes of code, starting at \$000000). The boot program checks for system ROMs and language extension ROMs on 16K boundaries beginning at \$020000 and continuing up to \$3FC000. These ROMs are recognized by their appropriate header information.

Memory Mapped I/O

I/O memory space is divided into three sections. External I/O is that section which corresponds to the backplane of the Series 200/300 computers. The select codes on the backplane I/O cards correspond to address bits BA16 through BA20.

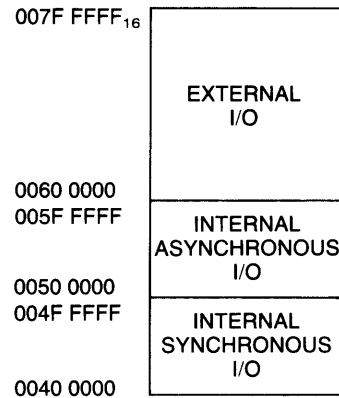

External I/O

All I/O cards available for the Series 200/300 computers are mapped into the external I/O space on 64K boundaries (except the DMA card which maps with synchronous internal I/O). There are 32 such spaces between \$600000 and \$7FFFFFFF. User designed cards must also map into one of these spaces. The select codes correspond to address lines BA16 through BA20. HP cards have been assigned default select codes but can be reset by the user to map into any configuration.

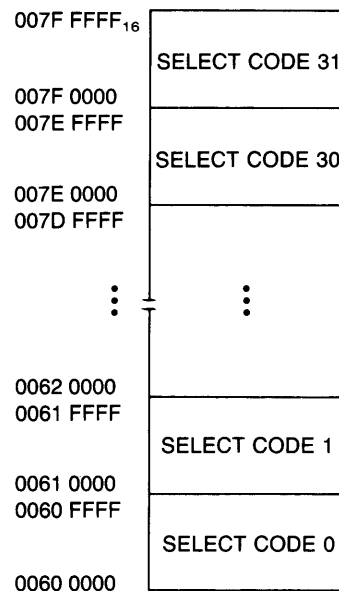

Internal I/O

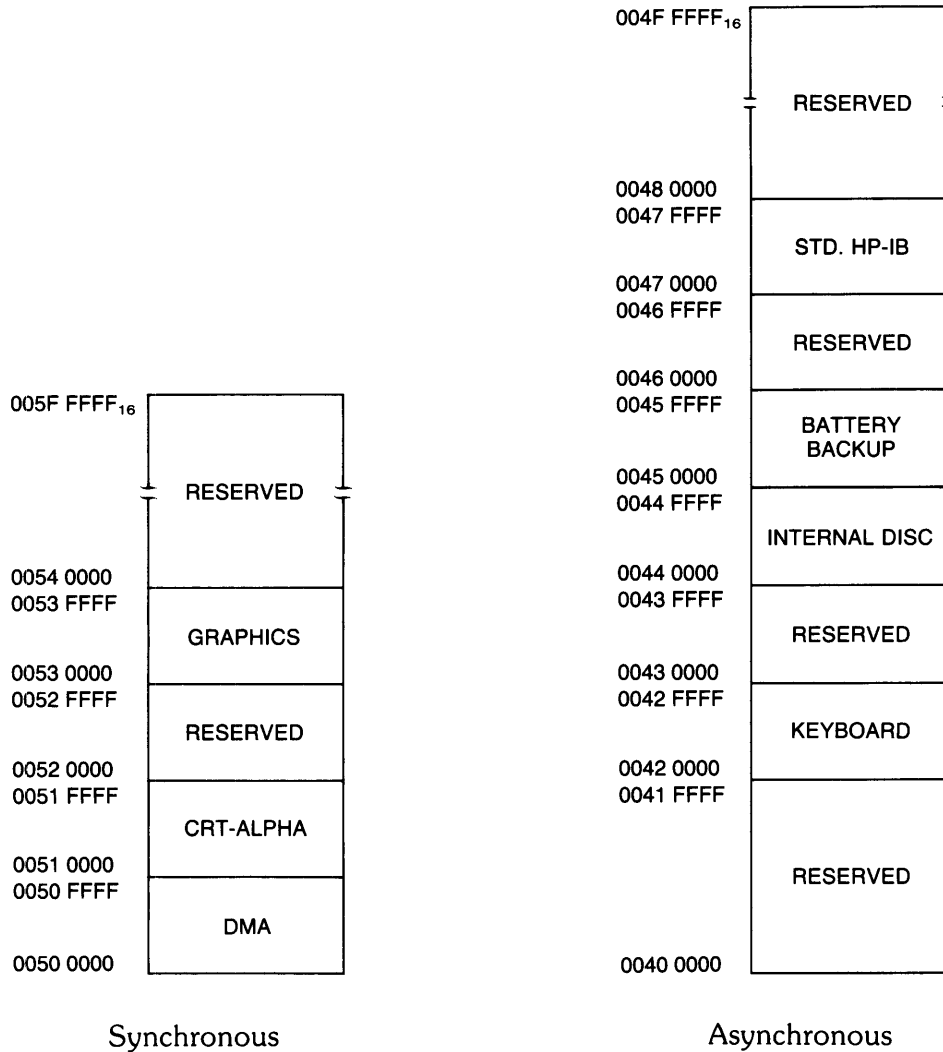

Internal I/O functions are doubly mapped, once between \$400000 and \$4FFFFFF, and again between \$500000 and \$5FFFFFF. That is why much of the internal I/O space is reserved. Those I/O functions can be addressed in either range. The difference is that the low range generates a DTACK (Data Acknowledge) automatically, whether the card has actually responded to the data or not. If the synchronous cards are addressed in the high range, there will be no DTACK generated at all.

Notes

The Software Memory Map

This software memory map shows the symbolic locations of global variables, local variables, the stack, the heap and the code relocation base.

If you'll look at the directory of the boot disk, you'll see the files that are loaded into RAM at power-up. SYSTEM is loaded first. It shows as SYSTEM CODE on the map. It sets up the EXCEPTION VECTORS, MISCElaneous DATA, SYSTEM GLOBALS, SYSTEM STACK, INITLIB GLOBALS and SYSTEM HEAP. TABLE is loaded and it modifies some of the data in SYSTEM GLOBALS and SYSTEM HEAP.

INITLIB is then loaded. It contains the I/O drivers and the Debugger.

Finally, STARTUP is loaded. When you receive a Pascal Language System from HP, STARTUP is the Main Command Level command interpreter. It handles P-loading files, loading subsystem files, and loading user programs. You may use the Filer to change any file you want to STARTUP and that file will execute at power-up. A copy of the BOOT disc should be created before the change is made because you won't be able to change the file back to the original configuration.

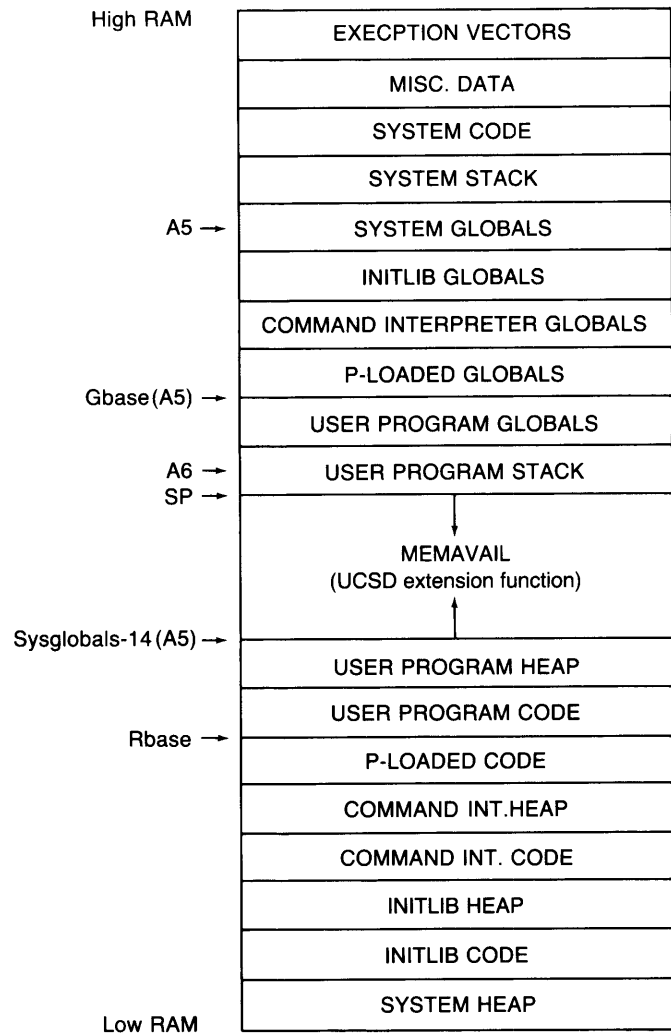

Note

For a complete description of the HP Series 200 Workstation Pascal's software memory map, see the *Pascal System Internals* documentation.

Notes

Character Sets

This section provides tables for the following character sets:

- U.S. ASCII character set
- U.S./European display characters (for Models 216, 220, 226, and 236 Computers)
- U.S./European display characters (for Models 217 and 237 Computers)
- U.S./European display characters (for all Series 300 Computers)
- Katakana display characters (for all Series 200 Computers)
- Monochrome highlight characters
- Color highlight characters

U.S. ASCII Character Set

ASCII Char.	EQUIVALENT FORMS				HP-IB
	Dec	Binary	Oct	Hex	
NUL	0	00000000	000	00	
SOH	1	00000001	001	01	GTL
STX	2	00000010	002	02	
ETX	3	00000011	003	03	
EOT	4	00000100	004	04	SDC
ENQ	5	00000101	005	05	PPC
ACK	6	00000110	006	06	
BEL	7	00000111	007	07	
BS	8	00001000	010	08	GET
HT	9	00001001	011	09	TCT
LF	10	00001010	012	0A	
VT	11	00001011	013	0B	
FF	12	00001100	014	0C	
CR	13	00001101	015	0D	
SO	14	00001110	016	0E	
SI	15	00001111	017	0F	
DLE	16	00010000	020	10	
DC1	17	00010001	021	11	LLO
DC2	18	00010010	022	12	
DC3	19	00010011	023	13	
DC4	20	00010100	024	14	DCL
NAK	21	00010101	025	15	PPU
SYNC	22	00010110	026	16	
ETB	23	00010111	027	17	
CAN	24	00011000	030	18	SPE
EM	25	00011001	031	19	SPD
SUB	26	00011010	032	1A	
ESC	27	00011011	033	1B	
FS	28	00011100	034	1C	
GS	29	00011101	035	1D	
RS	30	00011110	036	1E	
US	31	00011111	037	1F	

ASCII Char.	EQUIVALENT FORMS				HP-IB
	Dec	Binary	Oct	Hex	
space	32	00100000	040	20	LA0
!	33	00100001	041	21	LA1
"	34	00100010	042	22	LA2
#	35	00100011	043	23	LA3
\$	36	00100100	044	24	LA4
%	37	00100101	045	25	LA5
&	38	00100110	046	26	LA6
'	39	00100111	047	27	LA7
(40	00101000	050	28	LA8
)	41	00101001	051	29	LA9
*	42	00101010	052	2A	LA10
+	43	00101011	053	2B	LA11
,	44	00101100	054	2C	LA12
-	45	00101101	055	2D	LA13
.	46	00101110	056	2E	LA14
/	47	00101111	057	2F	LA15
0	48	00110000	060	30	LA16
1	49	00110001	061	31	LA17
2	50	00110010	062	32	LA18
3	51	00110011	063	33	LA19
4	52	00110100	064	34	LA20
5	53	00110101	065	35	LA21
6	54	00110110	066	36	LA22
7	55	00110111	067	37	LA23
8	56	00111000	070	38	LA24
9	57	00111001	071	39	LA25
:	58	00111010	072	3A	LA26
;	59	00111011	073	3B	LA27
<	60	00111100	074	3C	LA28
=	61	00111101	075	3D	LA29
>	62	00111110	076	3E	LA30
?	63	00111111	077	3F	UNL

U.S. ASCII Character Set

ASCII Char.	EQUIVALENT FORMS				HP-IB
	Dec	Binary	Oct	Hex	
@	64	01000000	100	40	TA0
A	65	01000001	101	41	TA1
B	66	01000010	102	42	TA2
C	67	01000011	103	43	TA3
D	68	01000100	104	44	TA4
E	69	01000101	105	45	TA5
F	70	01000110	106	46	TA6
G	71	01000111	107	47	TA7
H	72	01001000	110	48	TA8
I	73	01001001	111	49	TA9
J	74	01001010	112	4A	TA10
K	75	01001011	113	4B	TA11
L	76	01001100	114	4C	TA12
M	77	01001101	115	4D	TA13
N	78	01001110	116	4E	TA14
O	79	01001111	117	4F	TA15
P	80	01010000	120	50	TA16
Q	81	01010001	121	51	TA17
R	82	01010010	122	52	TA18
S	83	01010011	123	53	TA19
T	84	01010100	124	54	TA20
U	85	01010101	125	55	TA21
V	86	01010110	126	56	TA22
W	87	01010111	127	57	TA23
X	88	01011000	130	58	TA24
Y	89	01011001	131	59	TA25
Z	90	01011010	132	5A	TA26
[91	01011011	133	5B	TA27
\	92	01011100	134	5C	TA28
]	93	01011101	135	5D	TA29
^	94	01011110	136	5E	TA30
_	95	01011111	137	5F	UNT

ASCII Char.	EQUIVALENT FORMS				HP-IB
	Dec	Binary	Oct	Hex	
`	96	01100000	140	60	SC0
a	97	01100001	141	61	SC1
b	98	01100010	142	62	SC2
c	99	01100011	143	63	SC3
d	100	01100100	144	64	SC4
e	101	01100101	145	65	SC5
f	102	01100110	146	66	SC6
g	103	01100111	147	67	SC7
h	104	01101000	150	68	SC8
i	105	01101001	151	69	SC9
j	106	01101010	152	6A	SC10
k	107	01101011	153	6B	SC11
l	108	01101100	154	6C	SC12
m	109	01101101	155	6D	SC13
n	110	01101110	156	6E	SC14
o	111	01101111	157	6F	SC15
p	112	01110000	160	70	SC16
q	113	01110001	161	71	SC17
r	114	01110010	162	72	SC18
s	115	01110011	163	73	SC19
t	116	01110100	164	74	SC20
u	117	01110101	165	75	SC21
v	118	01110110	166	76	SC22
w	119	01110111	167	77	SC23
x	120	01111000	170	78	SC24
y	121	01111001	171	79	SC25
z	122	01111010	172	7A	SC26
{	123	01111011	173	7B	SC27
	124	01111100	174	7C	SC28
}	125	01111101	175	7D	SC29
~	126	01111110	176	7E	SC30
DEL	127	01111111	177	7F	SC31

U.S./European Display Characters

These characters can be displayed on the alpha screens of Models 216, 220, 226, and 236 Computers.

ASCII Char.	EQUIVALENT FORMS	
	Dec	Binary
0	0	00000000
1	1	00000001
2	2	00000010
3	3	00000011
4	4	00000100
5	5	00000101
6	6	00000110
7	7	00000111
8	8	00001000
9	9	00001001
10	10	00001010
11	11	00001011
12	12	00001100
13	13	00001101
14	14	00001110
15	15	00001111
16	16	00010000
17	17	00010001
18	18	00010010
19	19	00010011
20	20	00010100
21	21	00010101
22	22	00010110
23	23	00010111
24	24	00011000
25	25	00011001
26	26	00011010
27	27	00011011
28	28	00011100
29	29	00011101
30	30	00011110
31	31	00011111

ASCII Char.	EQUIVALENT FORMS	
	Dec	Binary
32	32	00100000
!	33	00100001
"	34	00100010
#	35	00100011
\$	36	00100100
%	37	00100101
&	38	00100110
'	39	00100111
(40	00101000
)	41	00101001
*	42	00101010
+	43	00101011
,	44	00101100
-	45	00101101
.	46	00101110
/	47	00101111
0	48	00110000
1	49	00110001
2	50	00110010
3	51	00110011
4	52	00110100
5	53	00110101
6	54	00110110
7	55	00110111
8	56	00111000
9	57	00111001
:	58	00111010
;	59	00111011
<	60	00111100
=	61	00111101
>	62	00111110
?	63	00111111

ASCII Char.	EQUIVALENT FORMS	
	Dec	Binary
@	64	01000000
A	65	01000001
B	66	01000010
C	67	01000011
D	68	01000100
E	69	01000101
F	70	01000110
G	71	01000111
H	72	01001000
I	73	01001001
J	74	01001010
K	75	01001011
L	76	01001100
M	77	01001101
N	78	01001110
O	79	01001111
P	80	01010000
Q	81	01010001
R	82	01010010
S	83	01010011
T	84	01010100
U	85	01010101
V	86	01010110
W	87	01010111
X	88	01011000
Y	89	01011001
Z	90	01011010
[91	01011011
\	92	01011100
]	93	01011101
^	94	01011110
_	95	01011111

ASCII Char.	EQUIVALENT FORMS	
	Dec	Binary
~	96	01100000
a	97	01100001
b	98	01100010
c	99	01100011
d	100	01100100
e	101	01100101
f	102	01100110
g	103	01100111
h	104	01101000
i	105	01101001
j	106	01101010
k	107	01101011
l	108	01101100
m	109	01101101
n	110	01101110
o	111	01101111
p	112	01110000
q	113	01110001
r	114	01110010
s	115	01110011
t	116	01110100
u	117	01110101
v	118	01110110
w	119	01110111
x	120	01111000
y	121	01111001
z	122	01111010
{	123	01111011
	124	01111100
}	125	01111101
~	126	01111110
?	127	01111111

U.S./European Display Characters

These characters can be displayed on the alpha screens of Models 216, 220, 226, and 236 Computers.

ASCII Char.	EQUIVALENT FORMS		ASCII Char.	EQUIVALENT FORMS		ASCII Char.	EQUIVALENT FORMS		ASCII Char.	EQUIVALENT FORMS	
	Dec	Binary		Dec	Binary		Dec	Binary		Dec	Binary
NOTE	128	10000000	␣	160	10100000	À	192	11000000	␣	224	11100000
NOTE	129	10000001	␣	161	10100001	Á	193	11000001	␣	225	11100001
NOTE	130	10000010	␣	162	10100010	Â	194	11000010	␣	226	11100010
NOTE	131	10000011	␣	163	10100011	Ã	195	11000011	␣	227	11100011
NOTE	132	10000100	␣	164	10100100	Ä	196	11000100	␣	228	11100100
NOTE	133	10000101	␣	165	10100101	Å	197	11000101	␣	229	11100101
NOTE	134	10000110	␣	166	10100110	Ö	198	11000110	␣	230	11100110
NOTE	135	10000111	␣	167	10100111	Û	199	11000111	␣	231	11100111
NOTE	136	10001000	␣	168	10101000	ä	200	11001000	␣	232	11101000
NOTE	137	10001001	␣	169	10101001	å	201	11001001	␣	233	11101001
NOTE	138	10001010	␣	170	10101010	Ö	202	11001010	␣	234	11101010
NOTE	139	10001011	␣	171	10101011	Û	203	11001011	␣	235	11101011
NOTE	140	10001100	␣	172	10101100	ä	204	11001100	␣	236	11101100
NOTE	141	10001101	␣	173	10101101	å	205	11001101	␣	237	11101101
NOTE	142	10001110	␣	174	10101110	Ö	206	11001110	␣	238	11101110
NOTE	143	10001111	£	175	10101111	Û	207	11001111	␣	239	11101111
␣	144	10010000	—	176	10110000	Ä	208	11010000	␣	240	11110000
␣	145	10010001	␣	177	10110001	Å	209	11010001	␣	241	11110001
␣	146	10010010	␣	178	10110010	Ö	210	11010010	␣	242	11110010
␣	147	10010011	°	179	10110011	Æ	211	11010011	␣	243	11110011
␣	148	10010100	␣	180	10110100	ä	212	11010100	␣	244	11110100
␣	149	10010101	Ç	181	10110101	å	213	11010101	␣	245	11110101
␣	150	10010110	Ñ	182	10110110	ö	214	11010110	␣	246	11110110
␣	151	10010111	Ñ	183	10110111	æ	215	11010111	␣	247	11110111
␣	152	10011000	ı	184	10111000	Ä	216	11011000	␣	248	11111000
␣	153	10011001	¿	185	10111001	Å	217	11011001	␣	249	11111001
␣	154	10011010	Ö	186	10111010	Ö	218	11011010	␣	250	11111010
␣	155	10011011	£	187	10111011	Û	219	11011011	␣	251	11111011
␣	156	10011100	␣	188	10111100	É	220	11011100	␣	252	11111100
␣	157	10011101	§	189	10111101	ı	221	11011101	␣	253	11111101
␣	158	10011110	␣	190	10111110	ß	222	11011110	␣	254	11111110
␣	159	10011111	␣	191	10111111	␣	223	11011111	␣	255	11111111

STD-L-60182

NOTE: Ignored by the 9826; see "Monochrome Highlight Characters."

U.S./European Display Characters

These characters can be displayed on the alpha screen of the Model 217 computer and on the bit-mapped graphics screen of the Model 237 computer.

ASCII

Num.	Chr.	Num.	Chr.	Num.	Chr.	Num.	Chr.
0	N	32		64	@	96	`
1	H	33	!	65	A	97	a
2	X	34	"	66	B	98	b
3	X	35	#	67	C	99	c
4	E	36	\$	68	D	100	d
5	O	37	%	69	E	101	e
6	K	38	&	70	F	102	f
7	U	39	'	71	G	103	g
8	E	40	(72	H	104	h
9	H	41)	73	I	105	i
10	L	42	*	74	J	106	j
11	V	43	+	75	K	107	k
12	F	44	,	76	L	108	l
13	C	45	-	77	M	109	m
14	O	46	.	78	N	110	n
15	T	47	/	79	O	111	o
16	D	48	0	80	P	112	p
17	D ₁	49	1	81	Q	113	q
18	D ₂	50	2	82	R	114	r
19	D ₃	51	3	83	S	115	s
20	D ₄	52	4	84	T	116	t
21	N	53	5	85	U	117	u
22	V	54	6	86	V	118	v
23	E	55	7	87	W	119	w
24	C	56	8	88	X	120	x
25	H	57	9	89	Y	121	y
26	E	58	:	90	Z	122	z
27	C	59	;	91	[123	{
28	F	60	<	92	\	124	
29	E	61	=	93]	125	}
30	E	62	>	94	^	126	~
31	U	63	?	95	_	127	■

U.S./European Display Characters

These characters can be displayed on the alpha screen of the Model 217 computer and on the bit-mapped graphics screen of the Model 237 computer.

ASCII

Num.	Chr.	Num.	Chr.	Num.	Chr.	Num.	Chr.
128	C	160		192	â	224	À
129	L	161	À	193	ë	225	Á
130	I	162	Å	194	ô	226	Â
131	V	163	Æ	195	ù	227	Ë
132	B	164	Ë	196	á	228	Ð
133	G	165	È	197	é	229	Đ
134	I	166	Ï	198	ó	230	±
135	L	167	İ	199	ú	231	Ó
136	U	168	˘	200	à	232	Ò
137	L	169	˙	201	è	233	Ï
138	B	170	˚	202	ò	234	Ø
139	G	171	˛	203	ù	235	Š
140	R	172	˜	204	ä	236	Š
141	D	173	Ù	205	ë	237	Ú
142	Y	174	Û	206	ö	238	Û
143	E	175	£	207	ü	239	Ý
144	R	176	—	208	À	240	ÿ
145	C	177	ı	209	ı	241	þ
146	Y	178	ı ₂	210	Ø	242	þ
147	E	179	˙	211	Å	243	F ₂
148	R	180	Ç	212	à	244	F ₃
149	D	181	ç	213	í	245	F ₄
150	Y	182	Ñ	214	ı	246	I
151	E	183	ñ	215	ø	247	ı
152	R	184	ı	216	æ	248	ı
153	D	185	ı	217	Ä	249	ı
154	Y	186	ı	218	İ	250	ı
155	E	187	£	219	Ü	251	«
156	R	188	¥	220	É	252	■
157	D	189	§	221	İ	253	»
158	Y	190	f	222	ß	254	±
159	E	191	¢	223	Ö	255	☒

U.S./European Display Characters

These characters can be displayed on the screen of Series 300 computers.

ASCII

Num.	Chr.	Num.	Chr.	Num.	Chr.	Num.	Chr.
0	N	32		64	@	96	`
1	H	33	!	65	A	97	a
2	X	34	"	66	B	98	b
3	E	35	#	67	C	99	c
4	E	36	\$	68	D	100	d
5	Q	37	%	69	E	101	e
6	K	38	&	70	F	102	f
7	O	39	'	71	G	103	g
8	S	40	(72	H	104	h
9	T	41)	73	I	105	i
10	L	42	*	74	J	106	j
11	V	43	+	75	K	107	k
12	F	44	,	76	L	108	l
13	C	45	-	77	M	109	m
14	O	46	.	78	N	110	n
15	S	47	/	79	O	111	o
16	L	48	0	80	P	112	p
17	D	49	1	81	Q	113	q
18	D	50	2	82	R	114	r
19	D	51	3	83	S	115	s
20	D	52	4	84	T	116	t
21	N	53	5	85	U	117	u
22	Y	54	6	86	V	118	v
23	S	55	7	87	W	119	w
24	K	56	8	88	X	120	x
25	H	57	9	89	Y	121	y
26	S	58	:	90	Z	122	z
27	E	59	;	91	[123	{
28	F	60	<	92	\	124	
29	S	61	=	93]	125	}
30	S	62	>	94	^	126	~
31	U	63	?	95	_	127	■

U.S./European Display Characters

These characters can be displayed on the screen of Series 300 computers.

ASCII

Num.	Chr.	Num.	Chr.	Num.	Chr.	Num.	Chr.
128	C	160		192	â	224	Á
129	L	161	À	193	ë	225	Â
130	U	162	Á	194	ö	226	Ã
131	B	163	Ê	195	ù	227	Ð
132	I	164	Ë	196	á	228	ð
133	V	165	È	197	é	229	í
134	L	166	Í	198	ó	230	î
135	I	167	Î	199	ú	231	Ó
136	W	168	ˆ	200	à	232	Ò
137	R	169	˘	201	è	233	Ë
138	Y	170	ˆ	202	ò	234	Ö
139	E	171	˘	203	ù	235	Š
140	R	172	˘	204	ä	236	š
141	C	173	Û	205	ë	237	Ú
142	Y	174	Ü	206	ö	238	Û
143	M	175	£	207	ü	239	Ý
144	G	176	—	208	À	240	Û
145	K	177	ÿ	209	í	241	þ
146	S	178	ÿ	210	Ø	242	·
147	S	179	˘	211	Å	243	µ
148	S	180	Ç	212	à	244	¶
149	S	181	Ç	213	í	245	ï
150	S	182	Ñ	214	ø	246	—
151	S	183	ñ	215	æ	247	¼
152	S	184	ı	216	Ä	248	½
153	S	185	ç	217	İ	249	¾
154	S	186	Ç	218	Ö	250	ε
155	A	187	£	219	Ü	251	«
156	B	188	¥	220	É	252	■
157	C	189	§	221	İ	253	»
158	D	190	f	222	ß	254	±
159	E	191	ç	223	Ó	255	☒

Katakana Display Characters

These characters can be displayed on all Series 200 Computers (while in Katakana mode).

ASCII Char.	EQUIVALENT FORMS	
	Dec	Binary
0	0	00000000
1	1	00000001
2	2	00000010
3	3	00000011
4	4	00000100
5	5	00000101
6	6	00000110
7	7	00000111
8	8	00001000
9	9	00001001
10	10	00001010
11	11	00001011
12	12	00001100
13	13	00001101
14	14	00001110
15	15	00001111
16	16	00010000
17	17	00010001
18	18	00010010
19	19	00010011
20	20	00010100
21	21	00010101
22	22	00010110
23	23	00010111
24	24	00011000
25	25	00011001
26	26	00011010
27	27	00011011
28	28	00011100
29	29	00011101
30	30	00011110
31	31	00011111

ASCII Char.	EQUIVALENT FORMS	
	Dec	Binary
32	32	00100000
!	33	00100001
"	34	00100010
#	35	00100011
\$	36	00100100
%	37	00100101
&	38	00100110
'	39	00100111
(40	00101000
)	41	00101001
*	42	00101010
+	43	00101011
,	44	00101100
-	45	00101101
.	46	00101110
/	47	00101111
0	48	00110000
1	49	00110001
2	50	00110010
3	51	00110011
4	52	00110100
5	53	00110101
6	54	00110110
7	55	00110111
8	56	00111000
9	57	00111001
:	58	00111010
;	59	00111011
<	60	00111100
=	61	00111101
>	62	00111110
?	63	00111111

ASCII Char.	EQUIVALENT FORMS	
	Dec	Binary
@	64	01000000
A	65	01000001
B	66	01000010
C	67	01000011
D	68	01000100
E	69	01000101
F	70	01000110
G	71	01000111
H	72	01001000
I	73	01001001
J	74	01001010
K	75	01001011
L	76	01001100
M	77	01001101
N	78	01001110
O	79	01001111
P	80	01010000
Q	81	01010001
R	82	01010010
S	83	01010011
T	84	01010100
U	85	01010101
V	86	01010110
W	87	01010111
X	88	01011000
Y	89	01011001
Z	90	01011010
[91	01011011
\	92	01011100
]	93	01011101
^	94	01011110
_	95	01011111

ASCII Char.	EQUIVALENT FORMS	
	Dec	Binary
~	96	01100000
a	97	01100001
b	98	01100010
c	99	01100011
d	100	01100100
e	101	01100101
f	102	01100110
g	103	01100111
h	104	01101000
i	105	01101001
j	106	01101010
k	107	01101011
l	108	01101100
m	109	01101101
n	110	01101110
o	111	01101111
p	112	01110000
q	113	01110001
r	114	01110010
s	115	01110011
t	116	01110100
u	117	01110101
v	118	01110110
w	119	01110111
x	120	01111000
y	121	01111001
z	122	01111010
{	123	01111011
	124	01111100
}	125	01111101
~	126	01111110
?	127	01111111

Katakana Display Characters

These characters can be displayed on all Series 200 Computers (while in Katakana mode).

ASCII Char.	EQUIVALENT FORMS	
	Dec	Binary
NOTE	128	10000000
NOTE	129	10000001
NOTE	130	10000010
NOTE	131	10000011
NOTE	132	10000100
NOTE	133	10000101
NOTE	134	10000110
NOTE	135	10000111
NOTE	136	10001000
NOTE	137	10001001
NOTE	138	10001010
NOTE	139	10001011
NOTE	140	10001100
NOTE	141	10001101
NOTE	142	10001110
NOTE	143	10001111
NOTE	144	10010000
NOTE	145	10010001
NOTE	146	10010010
NOTE	147	10010011
NOTE	148	10010100
NOTE	149	10010101
NOTE	150	10010110
NOTE	151	10010111
NOTE	152	10011000
NOTE	153	10011001
NOTE	154	10011010
NOTE	155	10011011
NOTE	156	10011100
NOTE	157	10011101
NOTE	158	10011110
NOTE	159	10011111

ASCII Char.	EQUIVALENT FORMS	
	Dec	Binary
ㇰ	160	10100000
ㇱ	161	10100001
ㇲ	162	10100010
ㇳ	163	10100011
ㇴ	164	10100100
ㇵ	165	10100101
ㇶ	166	10100110
ㇷ	167	10100111
ㇸ	168	10101000
ㇹ	169	10101001
ㇺ	170	10101010
ㇻ	171	10101011
ㇼ	172	10101100
ㇽ	173	10101101
ㇾ	174	10101110
ㇿ	175	10101111
㈀	176	10110000
㈁	177	10110001
㈂	178	10110010
㈃	179	10110011
㈄	180	10110100
㈅	181	10110101
㈆	182	10110110
㈇	183	10110111
㈈	184	10111000
㈉	185	10111001
㈊	186	10111010
㈋	187	10111011
㈌	188	10111100
㈍	189	10111101
㈎	190	10111110
㈏	191	10111111

ASCII Char.	EQUIVALENT FORMS	
	Dec	Binary
ㇰ	192	11000000
ㇱ	193	11000001
ㇲ	194	11000010
ㇳ	195	11000011
ㇴ	196	11000100
ㇵ	197	11000101
ㇶ	198	11000110
ㇷ	199	11000111
ㇸ	200	11001000
ㇹ	201	11001001
ㇺ	202	11001010
ㇻ	203	11001011
ㇼ	204	11001100
ㇽ	205	11001101
ㇾ	206	11001110
ㇿ	207	11001111
㈀	208	11010000
㈁	209	11010001
㈂	210	11010010
㈃	211	11010011
㈄	212	11010100
㈅	213	11010101
㈆	214	11010110
㈇	215	11010111
㈈	216	11011000
㈉	217	11011001
㈊	218	11011010
㈋	219	11011011
㈌	220	11011100
㈍	221	11011101
㈎	222	11011110
㈏	223	11011111

ASCII Char.	EQUIVALENT FORMS	
	Dec	Binary
ㇰ	224	11100000
ㇱ	225	11100001
ㇲ	226	11100010
ㇳ	227	11100011
ㇴ	228	11100100
ㇵ	229	11100101
ㇶ	230	11100110
ㇷ	231	11100111
ㇸ	232	11101000
ㇹ	233	11101001
ㇺ	234	11101010
ㇻ	235	11101011
ㇼ	236	11101100
ㇽ	237	11101101
ㇾ	238	11101110
ㇿ	239	11101111
㈀	240	11110000
㈁	241	11110001
㈂	242	11110010
㈃	243	11110011
㈄	244	11110100
㈅	245	11110101
㈆	246	11110110
㈇	247	11110111
㈈	248	11111000
㈉	249	11111001
㈊	250	11111010
㈋	251	11111011
㈌	252	11111100
㈍	253	11111101
㈎	254	11111110
㈏	255	11111111

281109-711-01LS

NOTE: These are the same as the U.S./European characters.

Monochrome Highlight Characters

These characters affect the highlight mode on all subsequently displayed characters on monochrome displays (not implemented on some Model 216 and 220 displays). Note that bit-mapped alpha displays have no blinking or half-bright modes (Model 237 and all Series 300 displays).

ASCII code	halfbright	underline	blinking	inverse video
128				
129				X
130			X	
131			X	X
132		X		
133		X		X
134		X	X	
135		X	X	X
136	X			
137	X			X
138	X		X	
139	X		X	X
140	X	X		
141	X	X		X
142	X	X	X	
143	X	X	X	X

"X" means that this highlight is enabled by displaying the character.

Color Highlight Characters

These characters change the color of subsequently displayed characters on the alpha screen of color displays.

ASCII code	Resultant Color
136	white (pen 1)
137	red (pen 2)
138	yellow (pen 3)
139	green (pen 4)
140	cyan (pen 5)
141	blue (pen 6)
142	magenta (pen 7)
143	black (pen 0)

Note that the colors shown in this table are the default colors for the corresponding pen number. On Series 300 displays, changing one of these pen colors also affects the color corresponding to the character. However, on the Model 236C, changing one of these pen colors has no effect on the alpha display character's color.

Command Summaries

Main Command Level Summary

Assembler—Run the Assembler.

Compiler—Run the Pascal Compiler.

Debugger—Run the Debugger subsystem.

Editor—Run the Editor subsystem.

eXecute—Execute a specified object file.

Filer—Run the Filer subsystem.

Initialize—Places all current blocked devices online.

Librarian—Run the Librarian subsystem.

Memvol—Create a memory resident volume.

Newsys—Select a new System Volume.

Permanent—Move an object file from a mass storage medium into internal read/write memory.

Run—Compile and execute the workfile or execute the last file compiled.

Stream—Stream a text file to be processed as keyboard commands.

User restart—Run the last program executed.

Version—Display version information about the Pascal Operating System.

What—Display the complete file specifier of each Pascal subsystem.

?—Display alternate command prompt.

Editor Command Summary

Text Modifying Commands

Copy – Insert text from the copy buffer or an external file in front of the current cursor location.

Delete – Remove text from the current cursor location to the location of the cursor when **(Select)** (**EXECUTE**) is pressed.

Insert – Inserts text in front of the current cursor location.

Replace – Replace the specified target string with the specified substitute string.

eXchange – Replace the text at the cursor with text typed from the keyboard, on a character-by-character basis.

Zap – Delete all text between the anchor and the current cursor location. (The anchor is set at the location of the latest Adjust, Find, Insert, or Replace command.)

Text Formatting Commands

Adjust – Adjust the column in which a line (or lines) start.

Margin – Format the paragraph the cursor is located to the margins in the current environment.

Miscellaneous Commands

Quit – Leave the Editor in an orderly manner. Provides various ways for saving the text currently in memory.

(STOP) (**(SHIFT)-(CLR I/O)**) – terminates the Editor subsystem, but the text is lost.

Set – Modify the environment or set markers in the text.

Verify – Update the displayed text to reflect the text stored in memory.

Cursor Keys

(TAB) – Move cursor to next tab position (fixed tabs) in the current direction.

(Return) or **(ENTER)** – Move cursor in current direction to the leftmost character in the next line.

Space Bar – Move cursor one character in the current direction.

Arrow Keys – Move cursor in the direction specified by the key.

Cursor Wheel – Moves the cursor like the arrow keys. Without **(SHIFT)**, works like right and left arrows; with **(SHIFT)**, works like the up and down arrows.

Cursor Positioning Commands

(=) – Typing **(=)** positions the cursor at the anchor. (The anchor is set at the location of the latest Adjust, Find, Insert, or Replace command.)

Find – Position the cursor after the specified target string.

Jump – Position the cursor at the beginning, the end, or the specified marker.

Page – Position the cursor ± 23 lines from the current location.

Filer Command Summary

Volume Related Commands

Bad sectors – Scans a volume and searches for unreliable (bad) storage areas.

Extended Directory – Lists directory information about a specified volume or set of files.

Krunch – Consolidates all unused space on a volume in a single area by packing the existing files together. (Not valid for SRM)

List Directory – Lists directory information about a specified volume or set of files.

Prefix – Specifies a new default volume.

Volumes – Lists the volumes currently on line.

Udir – Sets the default unit directory. (SRM only)

Zero – Creates an empty directory on the specified volume. (Not valid for SRM)

Exit Commands

Quit – Provides an orderly exit from the filer.

STOP – Pressing the **STOP** key unconditionally exits the Filer Subsystem. The current I/O operation is completed before exiting.

File Related Commands

Access – Change the access rights (passwords) on a file or directory. (SRM only)

Change – Change the name of a file, set of files, or volume.

Duplicate link – Duplicates links to a file or set of files. (SRM only)

Filecopy – Copies a file, set of files, or a volume to a specified destination.

Make – Create a directory (SRM) or a file on a volume.

Remove – Remove a directory entry or a set of directory entries.

Translate – Translates text files of types TEXT, ASCII, and DATA to other text file representations or to unblocked volumes.

Workfile Related Commands

Get – Specifies a file as the workfile.

New – Specifies that no file is the current workfile.

Save – Saves the current workfile(s) with the specified name.

What – Lists the name and current state (saved or not saved) of the workfile(s).

Librarian Command Summary

General Commands

- Boot** – creates “system Boot files.”
- Edit** – gets you into Edit mode, for either Copying or Linking.
- File** – sends the File directory (all module names) to the current Printout file.
- Header** – allows you to specify the Header size for the Output file.
- Input** – allows you to specify the Input file.
- Keep** – makes a permanent copy of the current Output file.
- Output** – allows you to specify the Output file.
- Printout** – turns the Printout option ON or OFF, or allows you to specify a Printout file.
- Quit** – quits the Librarian and returns you to the Main Command Level.
- Unassemble** – gets you into the Unassemble mode.
- Verify** – gets you into the Verify mode, and shows the name of the first module in the Input.

Copy Mode Commands

- All** – transfers All modules from the Input file to the Output file.
- Link** – gets you into Link mode.
- Module** – allows you to specify the next Module to be copied from the Input file.
- Transfer** – Transfers the current object module to the Output file.

Edit Mode Commands

- Append** – Appends modules to the Output file.
- Copy** – Copies the First module up to (but not including) the Until module to the Output file.
- First** – allows you to specify the First module to be transferred to the Output file.
- Stop** – Stops the Edit session and returns to the Librarian’s main prompt.
- Transfer** – Transfers the current object module to the Output file.
- Until** – allows you to specify the Until module.

Link Mode Commands

- All** – transfers All modules from the Input file to the Output file.
- Copy** – returns you to Copy mode.
- Def** – controls whether or not the DEF table is included in the Output file.
- Global** – allows you to change the Global base address of the module.
- Link** – finishes Linking.
- Module** – allows you to specify the next Module to be copied from the Input file.
- New** – allows you to name the New object module being created.
- Relocation** – designate the Relocation base address to be used.
- Space** – assigns Space for patches.
- Transfer** – Transfers the current object module to the Output file.
- X** – allows you to enter a copyright notice as part of the Output file.

Unassemble Commands

- Assembler** – directs the Librarian to unassemble the Input file using Assembler conventions.
- Compiler** – unassembles all lines of the Input file according to Compiler conventions.
- Def** – sends the DEF table to the Printout file.
- Ext** – sends the EXT table to the Printout file.
- Line range** – unassemble (using Compiler conventions) a section of code defined by two Line values.
- PC range** – unassemble (using Assembler conventions) a section of code defined by two location counter range values.
- Stop** – Stops the unassemble session and returns to the Librarian’s main prompt.
- Text** – sends the interface Text (DEFINE SOURCE) of the current Input module to the Printout file.

Debugger Command Summary

Register Operations

A0..A7, D0..D7, PC, SP, US, SR – Display or assign values to the processor registers.

Breakpoint Commands

BS – Set a breakpoint at the specified location.

BD – Disable (but don't remove) breakpoints.

BA – Activate disabled breakpoints.

BC – Clear and remove breakpoints.

B – Display the breakpoint table

Call Command

CALL – Calls the machine-language routine at the specified address.

Display Command

D – Display the specified object(s) immediately, directly, or indirectly.

Dump Commands

DA – Performs a DUMP ALPHA function.

DG – Performs a DUMP ALPHA function.

Escape Commands

EC – Generates the specified escape code.

ET – Specify escape codes to be trapped by the Debugger.

ETC – Sets up trapping of all escape codes; the Debugger executes specified command(s) when an escape is encountered.

ETN – Specify that all escape codes except the ones listed are to be trapped by the Debugger.

Format Commands

FB – Sets the default display format to Binary.

FH – Sets default format to hex values.

FI – Sets default format to signed integer values.

FO – Sets the default display format to Octal.

FU – Sets default format to unsigned integer values.

Go Commands

G – Resume execution.

GT – Resume execution at a specified location.

GTF or **GFT** – Same as GT except execution is slowed and the line numbers are flashed in the lower right corner of the CRT.

IF, ELSE, and END Commands

IF, ELSE, END – Allow conditional execution of Debugger command(s).

Open Memory Commands

OB, OW, OL – Display or alter memory locations.

Procedure Commands

PN – Continues the program, but halts program execution when the next procedure is called (or current one is exited, whichever occurs first).

PX, or **P** – Continues the program, but halts program execution when the current procedure is exited.

Queue Commands

Q – List the most recent line numbers (or PC values if Trace commands were used with machine code).

QE – Terminate recording of line number values in the queue.

QS – Start recording the information in the queue.

Softkey Commands

k0 ... **k9** – Define softkeys as typing-aid keys.

System Boot Command

sb – The system boot command puts the computer in the power-up state for rebooting.

Trace Commands

T – Execute the specified number of instructions, each followed by a TD command.

TD – Display the command string defined by the softkey **k4**.

TD I – Restores the initial command string to **k4**.

TQ – Same as the T command except the TD command is executed only after the last instruction.

TT – Same as the TQ command except a location is specified rather than a count.

Walk Procedure Links Commands

WD – Move the stack frame pointer to the stack frame of the calling procedure.

WS – Move the stack frame pointer to the stack frame of the nesting procedure.

WR – Return the stack frame pointer to the current stack frame.

Notes

Glossary

ASCII character Any of the 8-bit characters in Hewlett-Packard's extended ASCII (American Standard Code for Information Interchange) set. The characters include letters, numerals, punctuation, control characters and foreign character sets. A table of these characters and their code values can be found in the "Character Sets" appendix.

anchor An internal pointer used by the Editor's Zap command as a starting point for removing text. The anchor is set at the cursor position of the most recent Adjust, Find, Insert or Replace command. The cursor is moved to the anchor location by the Equals command.

bit An abbreviation for the term "binary digit", a bit is a single digit in base 2 that must be either a 0 or a 1.

block A block is a 512-byte unit of storage area on a WS1.0 volume and a 256-byte sector on a LIF volume. The Pascal system allocates storage space for files on the WS1.0 and LIF volumes in block increments.

block-structured An attribute of a device which structures its memory allocation in block units; examples are flexible or hard discs. Devices such as printers and screens (CRTs) are not block-structured.

boot device The peripheral where the Boot ROM found and loaded the Pascal operating system. The Boot ROM has a search pattern which allows booting from just about any drive in any HP mass storage product, including the Shared Resource Manager.

bus address When several peripherals are connected to the same HP-IB interface, a bus address is required (in addition to the select code) to designate the particular peripheral referenced by an I/O transaction.

byte A group of eight bits processed as a unit.

control character Any ASCII character whose value is either 127 or in the range of 0 thru 31. Use of control characters in the Editor and Filer is discouraged, because they may have undesirable effects.

cursor The flashing underline (└) symbol on the screen. The cursor functions as a reference point for Editor commands which manipulate text and as a reference for prompts in other Pascal subsystems.

cursor wheel The wheel (also called the knob) on the upper left area of the non-ITF keyboard whose action duplicates that of the four arrow keys. When used in the Editor with the **SHIFT** key pressed, turning the wheel produces up or down cursor movement; unshifted, it produces left or right cursor movement.

device selector By convention in the Pascal, BASIC and HPL systems, when select code and bus address are used together to address a peripheral, they are concatenated into a single number. Thus the device at address 1 on select code seven is referenced as 701, which is derived by multiplying the select code by 100 and adding the address. Some HP products contain, within a single package, several peripheral devices which must be addressed separately.

directory Contains information about the files on a volume. This information includes the volume name and the following information about each file on the medium: the file name, the file size (in number of blocks), the date of last modification to the file, its starting block address, and the file type (which reflects the file's attributes). Directory information can be seen by using the Filer's List Directory and Extended Directory commands. The directory is initialized with the Filer's Zero command.

Directory Access Method or DAM Each mass storage unit has a directory describing the files it contains, the type of each file and so forth. Many different directory organizations are used within HP, and data on a disc can't be interpreted properly unless it is accessed using the correct Directory Access Method. Pascal 2.0 and later versions support three DAMs: the "Workstation" format compatible with Pascal 1.0 systems; HP's "Logical Interchange Format" or LIF directory; and the Shared Resource Manager's hierarchical directory.

dollar sign This character "\$" is used in the Filer as a convenience in specifying file names. When used in place of a destination file name, it means that the file is to have the same name as the source file.

entry point The place where a program or subroutine begins. Before a routine is executed, the address of the entry point must be obtained from a symbol table and that address is put in the program counter.

environment The conditions or parameters which affect how text in the Editor is Adjusted, Inserted, and Margined. These parameters may be changed with the Editor's Set command.

file A discrete collection of information designated by a file name and residing on a mass storage medium.

file name An entry in a directory which identifies a particular file.

file specification Completely identifies a file and may include both a volume specification and a file name. A volume specification can be one of many items, but it is always part of a file specification. If a volume ID is given, it must be separated from the file name by a colon (:). If not, the default volume is assumed.

file types Several file types are recognized by the Pascal System. Files generally (but not always) have a suffix as part of the file name which indicates their type. The file type is established at the time of the file's creation and cannot be changed just by changing the suffix. The types and their associated suffixes are:

- TEXT files - (suffix is .TEXT) Contain ASCII characters and Editor environment information.
- ASCII files - (suffix is .ASC) Are similar to TEXT files. The format is slightly different and there is no Editor environment information.
- CODE files - (suffix is .CODE) Contain code generated by the Pascal Assembler, Compiler or Librarian.
- Data files - (no specific suffix) Are files which can be created by any subsystem but are used primarily as INPUT and OUPUT files in Pascal programs. They do not have suffixes.
- System files - (suffix is .SYSTEM) Are files created with the Librarian's Boot command. They are loadable by the boot ROM.
- Bad files - (suffix is .BAD) are a type of file created by the user to isolate unreliable or worn-out areas on a mass storage medium. Once created, BAD files will not be moved by subsequent crunches of the volume.

interface The electronic circuitry which connects the computer's high-speed internal bus to lower speed physical peripheral devices. Interfaces are either built-in, like the standard HP-IB port at the back of your computer, or plug into the I/O backplane. Most of the peripherals supported by the Series 200/300 computers are designed to connect through an HP-IB interface.

knob The rotary-pulse generator that is used as an input device on the built-in keyboards of the 9826 and 9836, on optional HP 98203B keyboards, and on the HP46083 HIL knob optional on computers with HIL keyboards. It is used in the Editor for moving the cursor (in that context, it is referred to as the "cursor wheel"). You can use it in programs for any purpose that you like.

library A file that contains object modules. Libraries are the object of the compiler, Assembler, or Librarian.

Librarian A Pascal subsystem designed to manage object modules. It can link or just collect object modules together into object files. The Librarian is the file named LIBRARIAN in the operating system and is accessed by pressing from the Main Command Level.

LIBRARY A special library included with the Pascal operating system. This file is usually designated as the System Library at power-up. (The System Library is a special library file automatically accessed by the compiler and loader.) The System file should be kept on-line so that object modules stored in it are automatically available to any program importing them.

Main Command Level The level from which all the subsystems of the Pascal System are entered. The prompt displayed at this level looks like:

```
Command: Compiler Editor Filer Initialize Librarian Run eXecute Version ?
```

module See “object module”.

mouse A small, rodent-like input device, consisting of a roller ball and buttons. Rolling the device on any surface generates two-dimensional movement information that is transmitted through its tail to the computer. Pushing the buttons also generates information that is sent to the computer. The mice available with Series 200/300 equipment are connected to the computer through the HP Human-Interface Link (HP-HIL).

object file An object file is a unit of binary code managed by the Librarian. It is made up of a Library directory and one or more object modules. The Assembler and Compiler generate one object file per source file. The Compiler’s object file can contain one or more object modules depending upon the source file’s construction. If the source file contains a number of compilable modules, that number of object modules will be created in the object file.

object module Contains the interface information necessary to link and run the module and the machine code.

on-line Any object (device, volume or file) currently accessible by the Pascal System.

opcode A word that stands for one of the operations of the microprocessor. The Assembler translates these words into actual binary codes which the microprocessor understands.

operand The symbol which stands for the object on which microprocessor operations are performed.

Pascal module HP Pascal allows program modules to be compiled separately into object modules. The modules are generally not executable, but are parts of Pascal programs. The sections of a module are:

```
MODULE , EXPORT , IMPORT , IMPLEMENT
```

pass by reference The address of a parameter variable is given to the called routine. Using that address, the routine can alter the value of the variable.

pass by value The current value of a variable is given to the called routine. In this way the value can be used but the routine does not alter the actual variable.

peripheral An I/O device such as a printer or disc.

prompt Generally, any request for information from the system. The different Pascal subsystems have primary prompts (the Editor Prompt, Filer Prompt, etc.) and many subsystem commands have prompts of their own which are displayed at the top of the screen when the command is entered.

pterodactyl A large flying reptile, presumed extinct.

relative addressing An addressing mode where the location of a routine or variable is given as an offset from the current location rather than an absolute address. In this way, the code can be placed at different places in memory without having to change the addresses of variables and entry points.

select code A number between 0 and 31, the “address” or name by which an interface is identified and referenced. When a peripheral operation is performed, it takes place through an interface which is said to be “on a select code”. Most interface cards which plug into the I/O backplane have switches which can be set to indicate the select code to which the interface will respond. The built-in interfaces have fixed select codes.

string A contiguous series of non-control ASCII characters.

structured constant A constant that has more than a single value, such as a record or array.

structured variable A variable that has more than a single value, such as a record or array.

symbol table A table containing the address locations of the variables and routine entry points.

system volume or system unit The Pascal system distinguishes one mass storage unit to be used for special purposes. This “system volume” is where the date and any AUTOSTART (or AUTOKEYS) file are found at boot time. It is where the system looks first for system files such as the Compiler and Editor, where workfiles are stored, and where an intermediate file is stored during interpretation of a Stream (command) file.

text file A file created and/or used by the Editor which contains ASCII or selected foreign characters. The Editor automatically appends .TEXT to a file name unless it either already contains a suffix or the last character in the file name is a period. A text file may be of type TEXT, ASCII or DATA.

unit An entry in the Unit Table.

Unit Table The Pascal system provides for up to 50 units, designated #1 through #50. They are represented by a 50-entry array called the Unit Table or “Unitable”. Each entry fully specifies the association of one logical unit to a physical peripheral, with such information as the device selector and driver procedures to be used for I/O operations to the unit.

unit number An integer in the range from 1 through 50 representing the volume having the corresponding entry in the unit table.

volume A volume refers to any I/O device such as a printer, keyboard, screen, or mass storage device. The name of a mass storage volume is found in its directory; the name of an unblocked device is found in its Unit Table entry. There may be several volumes on one physical storage medium. Hard discs typically contain multiple volumes, but flexible discs generally have only a single volume. The volume may be mounted (in a disc drive) or not. The syntax of a volume name depends on its type (for example, LIF volume names may contain 6 characters, WS1.0 may contain 7).

wildcard Both of the characters = and ? can be used in the Filer as wildcards in place of parts of a file specification.

workfile If the workfile exists, it is the automatic file used by the Editor, Compiler, Assembler, Debugger and the Run command. It is designated when quitting the Editor using the Update option or the Filer's Get command.

Error Messages

This appendix contains all of the error messages and conditions that you are likely to encounter while using the Pascal system. They can be placed into the following categories; each category is discussed in a subsequent section.

- Unreported errors – certain errors do not get reported by this implementation of Pascal.
- Boot-time errors – These are errors that occur while the Pascal system is booting (they are reported by the system loader).
- Run-time errors – These are general errors which may occur while you are using the system. Run-time errors – 10, – 26, and – 27 have special meanings, as described below.

I/O System errors – When run-time error – 10 occurs, there has been a problem with the I/O system. The operating system then prints an error message from the list of I/O system errors.

I/O Library errors – When run-time error – 26 occurs, there has been a problem in an I/O library procedure.

Graphics Library errors – When run-time error – 27 occurs, there has been a problem in a GRAPHICS library procedure.

- Compiler syntax errors.
- Editor, Filer, and Debugger errors and conditions.

Unreported Errors

The following errors in Pascal programs are not reported by this implementation of the language.

- Disposing a pointer while in the scope of a WITH referencing the variable to which it points.
- Disposing a pointer while the variable it points to is being used as a VAR parameter.
- Disposing an uninitialized or NIL pointer.
- Disposing a pointer to a variant record using the wrong tagfield list.
- Assignment to a FOR-loop control variable while inside the loop.
- GOTO into a conditional or structured statement.
- Exiting a function before a result value has been assigned.
- Changing the tagfield of a dynamic variable to a value other than was specified in the call to NEW.
- Accessing a variant field when the tagfield indicates a different variant.
- Negative field width parameters in a WRITE statement.
- The underscore character “_” is allowed in identifiers. This is permitted in HP Pascal, but is not reported as an error when compiling with \$ANSI\$ specified.
- Value range error is not always reported when an illegal value is assigned to a variable of type SET.

Boot-Time Errors

Errors that occur while your system is booting will report a message like this:

```
IORESULT, ERROR: 0, 112
```

The value of `IORESULT` is shown first (0 in the above display). See the I/O System Errors section for descriptions of those error numbers.

The value of `ERROR` is shown second (112 in the above display). See the Loader/SEGMENTER Errors section for a description of those error numbers.

Run-Time Errors

Errors detected by the operating system during the execution of a program generate one of the error messages listed on this page (unless you trap it with a `TRY..RECOVER` construct).

Note

Note that error -10 occurs, the error message listed here will *not* be shown; the message on the next page (in I/O System Errors) will be shown instead.

When using a `TRY..RECOVER` construct (which requires the `$SYSPROG ON$` Compiler option), the following numbers correspond to the value returned by the `ESCAPECODE` function.

- | | |
|--|---|
| 0 Normal termination. | - 15 Bad argument - SIN/COS. |
| - 1 Abnormal termination. | - 16 Bad argument - Natural Log. |
| - 2 Not enough memory. | - 17 Bad argument - SQRT. (Square root.) |
| - 3 Reference to NIL pointer. | - 18 Bad argument - real/BCD conversion. |
| - 4 Integer overflow. | - 19 Bad argument - BCD/real conversion. |
| - 5 Divide by zero. | - 20 Stopped by user. |
| - 6 Real math overflow. (The number was too large.) | - 21 Unassigned CPU trap. |
| - 7 Real math underflow. (The number was too small.) | - 22 Reserved |
| - 8 Value range error. | - 23 Reserved |
| - 9 Case value range error. | - 24 Macro Parameter not 0..9 or a..z. |
| - 10 Non-zero IORESULT. (Note that the corresponding message on the next page, not this message, will be shown.) | - 25 Undefined Macro parameter. |
| - 11 CPU word access to odd address. | - 26 Error in I/O subsystem. |
| - 12 CPU bus error. | - 27 Graphics routine error. |
| - 13 Illegal CPU instruction. | - 28 Parity error in memory. |
| - 14 CPU privilege violation. | - 29 Misc. floating-point hardware error. |
| | - 30 Arcsin, arccos argument > 1. |
| | - 31 Illegal real number. |

I/O System Errors

These error messages are automatically printed by the system unless you have enclosed the error-producing statement in a TRY..RECOVER construct. Within the RECOVER block, the ESCAPECODE function returning a value of -10 indicates that one of the following errors has occurred; you can determine which error has occurred by using the IORESULT function.

- | | | | |
|----|-------------------------------------|----|---|
| 0 | No I/O error reported. | 27 | No room in directory. |
| 1 | Parity (CRC) incorrect. | 28 | String subscript out of range. |
| 2 | Illegal unit number. | 29 | Bad file close string parameter. |
| 3 | Illegal I/O request. | 30 | Attempt to read or write past end-of-file mark. |
| 4 | Device timeout. | 31 | Media not initialized. |
| 5 | Volume went off-line. | 32 | Block not found. |
| 6 | File lost in directory. | 33 | Device not ready or medium absent. |
| 7 | Bad file name. | 34 | Media absent. |
| 8 | No room on volume. | 35 | No directory on volume. |
| 9 | Volume not found. | 36 | File type illegal or does not match request. |
| 10 | File not found. | 37 | Parameter illegal or out of range. |
| 11 | Duplicate directory entry. | 38 | File cannot be extended. |
| 12 | File already open. | 39 | Undefined operation for file. |
| 13 | File not open. | 40 | File not lockable. |
| 14 | Bad input format. | 41 | File already locked. |
| 15 | Disc block out of range. | 42 | File not locked. |
| 16 | Device absent or unaccessible. | 43 | Directory not empty. |
| 17 | Media initialization failed. | 44 | Too many files open on device. |
| 18 | Media is write protected. | 45 | Access to file not allowed. |
| 19 | Unexpected interrupt. | 46 | Invalid password. |
| 20 | Hardware/media failure. | 47 | File is not a directory. |
| 21 | Unrecognized error state. | 48 | Operation not allowed on directory. |
| 22 | DMA absent or unavailable. | 49 | Cannot create /WORKSTATIONS/TEMP_FILES. |
| 23 | File size not compatible with type. | 50 | Unrecognized SRM error. |
| 24 | File not opened for reading. | 51 | Medium may have been changed. |
| 25 | File not opened for writing. | 52 | IO result was 52. |
| 26 | File not opened for direct access. | | |

I/O Library Errors

When run-time error -26 occurs, there has been a problem in an I/O library procedure. By importing the IODECLARATIONS module, you can use the IOE_RESULT and IOERROR_MESSAGE functions to get a textual error description. For example:

```

$SYSPROG ON$
    ***
import IODECLARATIONS, GENERAL_3;
    ***
begin
try
    ***
recover
    if ESCAPECODE = IOESCAPECODE
        then writeln (IOERROR_MESSAGE(IOE_RESULT));
    ESCAPE(ESCAPECODE);
end.

```

IOESCAPECODE is a constant ($= -26$) which you can import from the IODECLARATIONS module. ESCAPE is a procedure and ESCAPECODE is a function; both are accessible when you use the \$SYSPROG ON\$ Compiler option.

0	No error.	17	A timeout has occurred.
1	No card at select code.	18	Not system controller.
2	Interface should be HP-IB.	19	Bad status or control.
3	Not active controller.	20	Bad set/clear/test operations.
4	Should be device address, not select code.	21	Interface card is dead.
5	No space left in buffer.	22	End/eod has occurred.
6	No data left in buffer.	23	Miscellaneous - value of parameter error.
7	Improper transfer attempted.	306	Data-Comm interface failure.
8	The select code is busy.	313	USART receive buffer overflow.
9	The buffer is busy.	314	Receive buffer overflow.
10	Improper transfer count.	315	Missing clock.
11	Bad timeout value.	316	CTS false too long.
12	No driver for this card.	317	Lost carrier disconnect.
13	No DMA.	318	No activity disconnect.
14	Word operations not allowed.	319	Connection not established.
15	Not addressed as talker.	325	Bad data bits/parity combination.
16	Not addressed as listener.	326	Bad status/control register.
		327	Control value out of range.

Graphics Errors

When run-time error -27 occurs, there has been an error in a GRAPHICS library routine.

By importing the DGL_LIB module, you can call the GRAPHICSError function which returns an INTEGER value you can cross reference with the numbered list of graphics errors.

```

$SYSPROG ON$
    ***
import DGL_LIB;
    ***
begin
try
    ***
recover
    if ESCAPECODE = -27
        then writeln ('Graphics error #', GRAPHICSError,
                     ' has occurred')
        else ESCAPE(ESCAPECODE);
end.

```

You may wish to write a procedure which takes the INTEGER value from GRAPHICSError and prints the description of the error on the CRT. You could keep this procedure with your program or, for more global use, in the System Library (normally SYSVOL:LIBRARY).

- 0 No error. {Since last call to GRAPHICSError or GRAPHICS_INIT.}
- 1 The graphics system is not initialized.
- 2 The graphics display is not enabled.
- 3 The locator device is not enabled.
- 4 ECHO value requires a graphic display to be enabled.
- 5 The graphics system is already enabled.
- 6 Illegal aspect ratio specified.
- 7 Illegal parameters specified.
- 8 The parameters specified are outside the physical display limits.
- 9 The parameters specified are outside the limits of the window.
- 10 The logical locator and the logical display use the same physical device. {The logical locator limits cannot be redefined explicitly. They must correspond to the logical view surface limits.}
- 11 The parameters specified are outside the current virtual coordinate system boundary.
- 12 The escape function requested is not supported by the graphics display device.
- 13 The parameters specified are outside of the physical locator limits.

Loader/SEGMENTER Errors

Here is a list of errors that can be generated by a program that uses the SEGMENTER module (or by the loader; see Boot-Time Errors):

Error	Meaning
100..105	field overflow trying to link or relocate something
110	circular or too deeply nested symbol definitions
111	improper link info format
112	not enough memory
116	file was not a code file
117	not enough space in the explicit global area
118	incorrect version number
119	unresolved external references
120	generated by the dummy procedure returned by find_proc
121	unload_segment called when there are no more segments to unload
122	not enough space in the explicit code area

SEGMENTER Errors

When one of these errors occurs while using the SEGMENTER module procedures, you can determine which has occurred by using a TRY..RECOVER construct and calling the ESCAPECODE function in the RECOVER block.

Loader Boot-Time Errors

When an error occurs while booting, a message such as the following will be reported:

```
IORESULT, ERROR =      0, 112
```

The second number indicates which loader error has occurred. (The first number indicates which I/O system error has occurred; see the preceding I/O System Errors section for descriptions of each error.)

Pascal Compiler Errors

The following errors may occur during the compilation of a HP Pascal program.

ANSI/ISO Pascal Errors

- | | | | |
|----|---|-----|--|
| 1 | Erroneous declaration of simple type | 98 | Illegal character in source text |
| 2 | Expected an identifier | 99 | End of source text reached before end of program |
| 4 | Expected a right parenthesis “)” | 100 | End of program reached before end of source text |
| 5 | Expected a colon “:” | 101 | Identifier was already declared |
| 6 | Symbol is not valid in this context | 102 | Low bound > high bound in range of constants |
| 7 | Error in parameter list | 103 | Identifier is not of the appropriate class |
| 8 | Expected the keyword OF | 104 | Identifier was not declared |
| 9 | Expected a left parenthesis “(“ | 105 | Non-numeric expressions cannot be signed |
| 10 | Erroneous type declaration | 106 | Expected a numeric constant here |
| 11 | Expected a left bracket “[” | 107 | Endpoint values of range must be compatible and ordinal |
| 12 | Expected a right bracket “]” | 108 | NIL may not be redeclared |
| 13 | Expected the keyword END | 110 | Tagfield type in a variant record is not ordinal |
| 14 | Expected a semicolon “;” | 111 | Variant case label is not compatible with tagfield |
| 15 | Expected an integer | 113 | Array dimension type is not ordinal |
| 16 | Expected an equal sign “=” | 115 | Set base type is not ordinal |
| 17 | Expected the keyword BEGIN | 117 | An unsatisfied forward reference remains |
| 18 | Expected a digit following “.” | 121 | Pass by value parameter cannot be type FILE |
| 19 | Error in field list of a record declaration | 123 | Type of function result is missing from declaration |
| 20 | Expected a comma “,” | 125 | Erroneous type of argument for built-in routine |
| 21 | Expected a period “.” | 126 | Number of arguments different from number of formal parameters |
| 22 | Expected a range specification symbol “..” | 127 | Argument is not compatible with corresponding parameter |
| 23 | Expected an end of comment delimiter | 129 | Operands in expression are not compatible |
| 24 | Expected a dollar sign “\$” | 130 | Second operand of IN is not a set |
| 50 | Error in constant specification | 131 | Only equality tests (= , <>) allowed on this type |
| 51 | Expected an assignment operator “:=” | 132 | Tests for strict inclusion (< , >) not allowed on sets |
| 52 | Expected the keyword THEN | | |
| 53 | Expected the keyword UNTIL | | |
| 54 | Expected the keyword DO | | |
| 55 | Expected the keyword TO or DOWNTO | | |
| 56 | Variable expected | | |
| 58 | Erroneous factor in expression | | |
| 59 | Erroneous symbol following a variable | | |

- | | |
|--|---|
| <p>133 Relational comparison not allowed on this type</p> <p>134 Operand(s) are not proper type for this operation</p> <p>135 Expression does not evaluate to a boolean result</p> <p>136 Set elements are not of ordinal type</p> <p>137 Set elements are not compatible with set base type</p> <p>138 Variable is not an ARRAY structure</p> <p>139 Array index is not compatible with declared subscript</p> <p>140 Variable is not a RECORD structure</p> <p>141 Variable is not a pointer or FILE structure</p> <p>143 FOR loop control variable is not of ordinal type</p> <p>144 CASE selector is not of ordinal type</p> <p>145 Limit values not compatible with loop control variable</p> <p>147 Case label is not compatible with selector</p> <p>149 Array dimension is not bounded</p> <p>150 Illegal to assign value to built-in function identifier</p> <p>152 No field of that name in the pertinent record</p> <p>154 Illegal argument to match pass by reference parameter</p> <p>156 Case label has already been used</p> <p>158 Structure is not a variant record</p> <p>160 Previous declaration was not forward</p> <p>163 Statement label not in range 0..9999</p> <p>164 Target of nonlocal GOTO not in outermost compound statement</p> <p>165 Statement label has already been used</p> <p>166 Statement label was already declared</p> <p>167 Statement label was not declared</p> <p>168 Undefined statement label</p> <p>169 Set base type is not bounded</p> <p>171 Parameter list conflicts with forward declaration</p> | <p>177 Cannot assign value to function outside its body</p> <p>181 Function must contain assignment to function result</p> <p>182 Set element is not in range of set base type</p> <p>183 File has illegal element type</p> <p>184 File parameter must be of type TEXT</p> <p>185 Undeclared external file or no file parameter</p> <p>190 Attempt to use type identifier in its own declaration</p> <p>300 Division by zero</p> <p>301 Overflow in constant expression</p> <p>302 Index expression out of bounds</p> <p>303 Value out of range</p> <p>304 Element expression out of range</p> <p>400 Unable to open list file</p> <p>401 File or volume not found</p> <p>403.. Compiler error</p> <p>409</p> <p>Compiler options</p> <p>600 Directive is not at beginning of the program</p> <p>601 Indentation too large for \$PAGewidth</p> <p>602 Directive not valid in executable code</p> <p>604 Too many parameters to \$SEARCH</p> <p>605 Conditional compilation directives out of order</p> <p>606 Feature not in Standard PASCAL flagged by \$ANSI ON</p> <p>607 Feature only allowed when \$UCSD enabled</p> <p>608 \$INCLUDE exceeds maximum allowed depth of files</p> <p>609 Cannot access this \$INCLUDE file</p> <p>610 \$INCLUDE or IMPORT nesting too deep to IMPORT <module-name></p> <p>611 Error in accessing library file</p> <p>612 Language extension not enabled</p> <p>613 Imported module does not have interface text</p> <p>614 LINENUM must be in the range 0..65535</p> |
|--|---|

- 620 Only first instance of routine may have \$ALIAS
- 621 \$ALIAS not in procedure or function header
- 646 Directive not allowed in EXPORT section
- 647 Illegal file name
- 648 Illegal operand in compiler directive
- 649 Unrecognized compiler directive
- 677 Constant overflow
- 678 Allowable string length is 1..255 characters
- 679 Range of case labels too large
- 680 Real constant has too many digits
- 681 Real number not allowed
- 682 Error in structured constant
- 683 More than 32767 bytes of data

Implementation restrictions

- 651 Reference to a standard routine that is not implemented
- 652 Illegal assignment or CALL involving a standard procedure
- 653 Routine cannot be followed by CONST, TYPE, VAR, or MODULE
- 655 Record or array constructor not allowed in executable statement
- 657 Loop control variable must be local variable
- 658 Sets are restricted to the ordinal range 0 .. 261 999
- 659 Cannot blank pad literal to more than 255 characters
- 660 String constant cannot extend past text line
- 661 Integer constant exceeds the range implemented
- 662 Nesting level of identifier scopes exceeds maximum (20)
- 663 Nesting level of declared routines exceeds maximum (15)
- 665 CASE statement must contain a non-OTHERWISE clause
- 667 Routine was already declared forward
- 668 Forward routine may not be external
- 671 Procedure too long
- 672 Structure is too large to be allocated
- 673 File component size must be in range 1..32766
- 674 Field in record constructor improper or missing
- 675 Array element too large
- 676 Structured constant has been discarded (cf. \$SAVE_CONST)
- 684 Expression too complex
- 685 Variable in READ or WRITE list exceeds 32767 bytes
- 686 Field width parameter must be in range 0..255
- 687 Cannot IMPORT module name in its EXPORT section
- 688 Structured constant not allowed in FORWARD module
- 689 Module name may not exceed 15 characters
- 696 Array elements are not packed
- 697 Array lower bound is too large
- 698 File parameter required
- 699 32-bit arithmetic overflow

Non-ISO Language Features

- 701 Cannot dereference (^) variable of type anyptr
- 702 Cannot make an assignment to this type of variable
- 704 Illegal use of module name
- 705 Too many concrete modules
- 706 Concrete or external instance required
- 707 Variable is of type not allowed in variant records
- 708 Integer following # is greater than 255
- 709 Illegal character in a "sharp" string
- 710 Illegal item in EXPORT section
- 711 Expected the keyword IMPLEMENT
- 712 Expected the keyword RECOVER
- 714 Expected the keyword EXPORT
- 715 Expected the keyword MODULE

416 Error Messages

- 716 Structured constant has erroneous type
- 717 Illegal item in IMPORT section
- 718 CALL to other than a procedural variable
- 719 Module already implemented (duplicate concrete module)
- 720 Concrete module not allowed here
- 730 Structured constant component incompatible with corresponding type
- 731 Array constant has incorrect number of elements
- 732 Length specification required
- 733 Type identifier required
- 750 Error in constant expression
- 751 Function result type must be assignable
- 900 Insufficient space to open code file
- 901 Insufficient space to open ref file
- 902 Insufficient space to open def file
- 903 Error in opening code file
- 904 Error in opening ref file
- 905 Error in opening def file
- 906 Code file full
- 907 Ref file full
- 908 Def file full

Assembler Errors

Error messages are listed under the line in which they occur. At the completion of the assembly, the number of errors will be displayed. If there are errors, there will be a directive for you to check the location of the last error in the program. At that location there will be a description of the error. Also listed will be the location of the error above it if one exists. In this manner, all errors can be located without having to search the whole listing.

Error Messages

Address Register Expected.

Attempt to Nest Included Files.

Blank or EOL Expected.

Comma Expected.

Code Segment Starts at Odd Address.

Duplicate Definition of Symbol.

Error Reading Code File.

Error Reading Source File.

Error Writing Code File.

Error Writing Source File.

Error Reading Code File.

Expression is Improper Mode.

External Reference Not Allowed.

Failed to Open Included File. File could not be found.

Field Overflow. A specification of the assembly instruction will not fit within the appropriate field of the machine instruction.

Illegal Constant.

Illegal Expression.

Illegal Operand Size for this Instruction.

Illegal Syntax.

Improper Addressing Mode

Improper Use of Mode Declaration. Symbol already has mode or declaration appears after first use of symbol.

Improper Use of Size Suffix.

Invalid Opcode.

Label Required. For some pseudo-ops.

Module Directory Overflow. Too many ORG or RORG statements in assembly or Non-Contiguous DS statements.

More Than One COM Statement.

More Than One MNAME Statement.

More Than One START Statement.

Phase Error. A symbol value is not equal in both passes.

Register or Register List Expected.

Right Parenthesis Expected.

Symbol Expected.

Undefined Symbol.

Debugger Error Messages/Conditions

WHAT?

The first characters of a command are not recognized.

SYNTAX ERROR

Somewhere in the current command, the syntax rules for the command have been violated.

OVERFLOW

A number entered or the result of an arithmetic operation cannot be represented in 32 bits.

BUSERORR

An address has been accessed which does not exist in the machine's configuration.

INPUT OVERFLOW

An internal input stack has overflowed.

ADDRESS ERROR

An odd address has been referenced when an even address is required.

TOO MANY CODES

Too many escape codes in the ET or ETN list.

SIZE ERROR

An entered value does not fit in the required space, e.g., registers.

TYPE ERROR

The parameter entered for a command is not the correct type; e.g., an alpha value when a line number or address is required.

EXPRESSION TOO COMPLEX

The expression requires too much stack space to execute; e.g., more than three levels of parentheses.

DIVIDE BY ZERO

The value to the right of the / symbol is zero.

UNDEFINED SYMBOL

An expression contains a reference to a symbol which the DEBUGGER does not recognize.

SIZE FIELD TOO BIG

In a format, the size field is too large for the object being dumped or the format spec being used; e.g., the size field for I and U is 1..4. The default size for string data is the length of the string.

FORMAT REQUIRES MORE DATA

An attempt has been made to display more bytes than the object contains.

ADDRESS FORMAT NOT ALLOWED

The *, < > and ^ format codes are only allowed if the object is type address.

PC/SP HAS ODD ADDRESS

An attempt to return to the user code has been made under the above conditions.

DUPLICATE BREAK

GT or TT has specified a location which already has a break point defined.

Notes

Subject Index

a

Absolute symbols 243
Access command (Filer) 126
Access rights (SRM) 46,110
Adding modules to System Library 280
Addresses (heap) 381
Addresses (of I/O) 378-9
Addresses (of RAM) 375-6
Addresses (of ROM) 377
Addresses (stack) 381
Addresses (used by system) 381
Addressing modes, Assembler 245
Addressing range 375
Adjust command (Editor) 74
ALIAS (Compiler option) 180
ALLOW_PACKED (Compiler option) 181
ANSI (Compiler option) 182
Assembler pseudo ops:
 COM 250
 DC 251
 DECIMAL 251
 DEF 252
 DS 252
 END 253
 EQU 253
 INCLUDE 253
 LIST 254
 LLEN 254
 LMODE 255
 LPRINT 255
 MNAME 256
 NOLIST 256
 NOOBJ 257
 NOSYMS 257
 ORG 258
 PAGE 258
 REFA 259
 REFR 259
 RMODE 260
 RORG 260
 SMODE 261
 SPC 261
 SPRINT 261
 SRC 262
 START 262
 TTL 262

Assembler syntax (diagram) 237
Assembler:
 Addressing modes 245
 Comment 237,247
 Declaring global variables 229
 Declaring module name 228
 DEF table 226
 Error recovery 233
 Errors 417
 Example modules 263
 Exception coding 235
 Expressions 244
 EXT Table 227
 EXTERNAL procedures 236
 General syntax 237
 IMPORT text 226
 Instruction fields 238
 Introduction 221
 Invoking 222
 Letter case 238
 Line label 238
 Listing 222,224
 Local variables 230
 Module initialization 233
 Modules 225
 Object file 223
 Opcode size suffix 240
 Operand(s) 237,241
 Passing Parameters 228
 Pseudo ops 250
 Source file 222
 Support of co-processor 249
 Syntax 237
 Use of the stack 235
Assembly language instructions 237
Available memory (MEMAVAIL) 381

b

Backing up volumes 113
Bad sector command (Filer) 128
Blocked and unblocked Units 25
Boot-time errors 408
Breakpoints (Debugger) 313

C

CALLABS (Compiler option)	183
Change command (Filer)	119,129
Changing memory contents	322
Chapter Previews	2,3,4
Character sets	383
Co-processor support	249
Co-processor:	
68881	237
Co-processors	239
CODE (Compiler option)	184
CODE_OFFSETS (Compiler option)	185
Color highlight characters	394
Command reference:	
Debugger	333
Editor	72
Filer	122
Librarian	293-5
Command summary:	
Debugger	73,331,399
Editor	396
Filer	397
Librarian	398
Main Command Level	395
Command:	
Krunch (Filer)	140
Access (Filer)	126
Adjust (Editor)	74
Bad sector (Filer)	128
Change (Filer)	129
Copy (Editor)	76
Debugger (summary)	331
Delete (Editor)	78
Duplicate (Filer)	131
Equals (=) (Editor)	80
Exchange (Editor)	100
eXecute (Main level)	8
Extended directory (Filer)	132
Filecopy (Filer)	81
Find (Editor)	81
Get (Filer)	139
Initialize (Main Level)	8,9
Insert (Editor)	84
Jump (Editor)	87
Librarian (Summary)	293-5
List directory (Filer)	142
Main Level	5,6
Make (Filer)	144
Margin (Editor)	88
Memory volume (Main Level)	9
New (Filer)	146
New sysvol (Main Level)	12

Page (Editor)	89
Permanent (Main Level)	13
Prefix (Filer)	147
Quit (Editor)	90
Quit (Filer)	149
Remove (Filer)	150
Replace (Editor)	92
Run (Main Level)	14
Save (Filer)	152
Set (Editor)	95
Stream (Main Level)	15
Syntax diagram	7
Translate (Filer)	153
Unit directory (Filer)	155
User restart (Main Level)	18
Verify (Editor)	99
Version (Main Level)	19
Volumes (Filer)	157
What (Filer)	158
What (Main Level)	21
Zap (Editor)	102
Zero (Filer)	159
Comments, Assembler	237,247
Compiler option:	
ALIAS	180
ALLOW_PACKED	181
ANSI	182
CALLABS	182
CODE	184
CODE_OFFSETS	184
COPYRIGHT	186
DEBUG	187
DEBUG ON	212
DEF	188
FLOAT_HDW	189
General	179
HEAP_DISPOSE	190
IF	191
INCLUDE	192
IOCHECK	193
LINENUM	194
LINES	195
LIST	196
OVFLCHECK	197
PAGE	198
PAGEWIDTH	199
PARTIAL_EVAL	200
RANGE	201
REF	202
SAVE_CONST	203
SEARCH	204
SEARCH_SIZE	205
STACKCHECK	206,212,213

SWITCH_STRPOS.....	207
SYSPROG.....	208
TABLES.....	209
UCSD.....	210
WARN.....	211
Compiler:	
Errors.....	177,413
Function calls.....	214
Function results.....	215
Global variables.....	212
INCLUDE files.....	176
Introduction.....	161
Invoking.....	162
Listing.....	163
Modules.....	167
Parameter passing.....	214
Procedure calls.....	213
Running the program.....	165
SEARCH option.....	173
Separate module compilation.....	172
Stack usage.....	212
Static links.....	217
Strategy for compiling modules.....	276
UCSD options.....	161
Workfile.....	165
Compiling modules.....	275
Constants, Assembler.....	241
Copy command (Editor).....	76
Copying:	
Discs.....	113
Files.....	116
COPYRIGHT (Compiler option).....	186
Creating an SRM Directory.....	115
Cursor wheel.....	54,68

d

DEBUG ON (Compiler option).....	212,304
Debugger commands:	
B.....	335
BA.....	335
BC.....	336
BD.....	336
BS.....	337
CALL.....	338
D.....	339
DA.....	341
DG.....	341
EC.....	342
ET.....	342
ETC.....	343

ETN.....	343
FB.....	344
FH.....	344
FI.....	344
FO.....	344
FU.....	344
G.....	345
GF.....	345
GT.....	346
GTF.....	346
IF, ELSE, END.....	347
OL,OW,OB.....	349
PN.....	350
PX.....	350
Q.....	351
QE.....	351
QS.....	351
Register operations.....	353
sb.....	353
Softkey commands.....	352
T.....	354
TD.....	354
TQ.....	354
TT.....	355
WD.....	356
WR.....	356
WS.....	356
Debugger:	
Breakpoint Table.....	315
Breakpoints.....	313
Changing memory contents.....	322
Clearing Breakpoints.....	316
Code file specification.....	306
Command reference.....	333
Command screen.....	308
Command summary.....	331,399
DEBUG Compiler option.....	304
Default display formats.....	313
Display formats.....	310
Displaying data.....	310
Errors.....	419
Examining consecutive memory.....	320
Examining variables.....	318
Example program.....	304
Exception trapping.....	324
Executing a number of statements.....	316
Expressions.....	333
Formats for structured variables.....	321
Generating Escapes.....	325
Input formats.....	313
Introduction.....	303
Invoking.....	306

Is it installed?	306,327
Key notation	306
Keyboard	327
Loading	303,305
Pause function	316
Prompt	308
Queue	310
Sample session	304
Screen dumps	310
Single-stepping	308
Slow program execution	309
Stack frame	317
Static and dynamic links	323
Tracing program flow	317
DEF (Compiler option)	188
DEF table	226,296
DEF table command (Librarian)	287
Default display formats (Debugger)	313
Default volume	22,26,106
Define Source	296
Delete command (Editor)	78
Deleting files	120
Directory access methods (DAMs)	10,34
Directory path syntax	30
Disassembly of a module	265,288-91
Disc drives	24
Display formats (Debugger)	311
Displaying data (with Debugger)	310
Drive numbers	25
Duplicate command (Filer)	129

e

Editor:	
Anchor	68
Backing up your file	67
Changing text	57
Command summary:Editor	396
Confirming or aborting commands	53
Copying text from other files	52
Creating a text file	49
Creating text	50,51
Cursor	68
Deleting text	55
Duplicating text	56
Entering the	48

Exiting the Editor	66
File size	69
Finding text patterns	62
Formatting text	62
I/O errors	71
Introduction	47
Margining text	64
Moving text	56
Moving the cursor	54
Recovering deleted text	56
Setting the environment	64,65
Storing your file	51,66
Stream Files	71
Text files	68
Using workfiles	70
Window	68
Equals (=) command (Editor)	80
Error messages	407
Error recovery	233
Errors:	
Assembler	417
Boot-time	408
Compiler	413
Debugger	419
Graphics errors	411
I/O library	410
I/O system	409
Loader/SEGMENTER	412
Messages	407
Run-time	408
Syntax	163
Unreported	407
Examining consecutive memory (Debugger)	320
Examining variables (Debugger)	318
Exception coding	235
Exception trapping (Debugger)	324
eXchange command (Editor)	100
eXecute Command (Main Level)	8
EXPORT	298
Expressions (Debugger)	333
Expressions, Assembler	244
EXT table	227,297
EXT table command (Librarian)	287
Extended directory command (Filer) ..	109,132
EXTERNAL procedures	236
External symbols	244

f

File directory	272
File specification	29
File system:	
Introduction	23
File types	34
Filecopy command (Filer).....	115,116,135
Filer:	
Access command	126
Bad sector command	128
Change command	119,129
Command summary	397
Confirming or aborting commands	104
Creating a Directory (SRM)	115
Deleting files	120
Duplicate command	131
Entering the Filer	104
Extended directory command	109,132
Filecopy command	113,116,135
Get command	139
Introduction	103
Krunch command	140
Leaving the Filer	121
List directory command	108,142
Make command	144
New command	146
Prefix command	27,147
Prompt	104
Quit command	149
Remove command	150
Removing Files	120
Save command	152
SRM access Rights	110
Translate command	36,111,153
Unit directory command	155
Volume back-up	113
Volumes command	24,157
What command	158
What devices are accessible?	105
Wildcards	111
Workfile	121
Zero command	159
Files:	
Creating a text file	49
Deleting	120
File specification (syntax)	124
General Discussion	27
Interchange between BASIC and Pascal	371
LIF file names	32
Names to avoid	39
Naming Conventions	28

Object (definition of).....	272
Object modules	165
Removing	120
Renaming	119
Size specification	33
Specification	29
SRM concurrent file access	46
SRM names	33
Stream	15
Stream Files	71
Structure of text files	70
Suffixes	34
Suppressing the suffix	35
Syntax of name	31
Translating between Data Types	36
Types	31,34
Wildcards	37,111
Workfile	70,121,165
WS1.0 file names	33
Find command (Editor)	81
Flags	298
FLOAT_HDW (Compiler option)	189
Formats for structured variables (Debugger)	321
Function calls	214
Function results	215

g

General Value or Address Record (GVR)	299
Generating Escapes (Debugger)	325
Get command (Filer)	139
Global base	212
Global space	20
Global variables	13,18,212,229,230
Glossary	401-6
Glossary (Librarian)	295
Graphics errors	411

h

Heap (addresses)	381
HEAP_DISPOSE (Compiler option)	190
Hierarchical directories (SRM)	41
Highlight characters	394

i

I/O addresses	378-9
I/O library errors	410
I/O system errors	409
I/O, memory map	378-9
IF (Compiler option)	191
IMPLEMENT	299
IMPORT	299
IMPORT text	226
IMPORT text command (Librarian)	287
INCLUDE (Compiler option)	192
INCLUDE files (Compiler)	176
Initialize Command (Main Level)	9
Initializing modules	233
Input formats (Debugger)	313
Insert command (Editor)	84
Instruction syntax, Assembler	237
Interchange of files	371
Interface text	225,226
IOCHECK (Compiler option)	193

j

JSR instruction	213
Jump command (Editor)	87

k

Katakana display characters	392-3
Key notations	1,306
Keyboard notation (Debugger)	327
Knob	54,68
Krunch command (Filer)	140

l

Letter case:	
Assembler	238
LIBRARIAN file	299
Librarian:	
Adding modules to System Library	280
Command summary	398

Creating a Boot file	292
Creating libraries	280
DEF table	296
DEF table command	287
Define Source	296
Detailed file information	286
EXPORT	298
EXT table	297
EXT table command	287
Flags	298
General Value or Address Record (GVR)	299
Glossary	296
IMPLEMENT	299
IMPORT	299
IMPORT text command	287
Introduction	271
Invoking	278
Libraries	272
Linking object files together	283
Making your own library	282
Mass storage setup	279
Object file	300
Object module	300
REF tables	301
Reference Pointer	301
Text Record	302
Unassemble commands	288-91
What it does	272
LIBRARY	277
Library:	
Definition of	272
Overview	272
System	302
LIF file names	32
Line label, Assembler	238
LINENUM (Compiler option)	194
LINES (Compiler option)	195
LINK instruction	213,231
Linking object files	283
LIST (Compiler option)	196
List directory command (Filer)	108,142
Listing files:	
On PRINTER	112
On screen	112
Loader/SEGMENTER errors	412
Local variables	230
Location counter symbol	242
Logical units	25

m

Main Command Level	5
Main Level command summary	395
Main Level commands	6
Make command (Filer)	144
Manual Overview	1,2
Margin command (Editor)	88
Mass storage:	
Introduction	23
Volumes	24
MC68881	239,249
MEMAVAIL function	381
Memory (RAM)	23
Memory characteristics	23
Memory map (physical)	375
Memory map (RAM)	375-6
Memory map (ROM)	377
Memory map (software)	381
Memory volume command (Main Level) ..	10
Memory-mapped I/O	378-9
Modules:	
Assembler	225
Developing and testing	170
Examples	169,170,174,263-270,272
How the Compiler finds them	275
How the loader finds them	277
Importing	273-7
Initialization	233
Names used by operating system	373
Object (definition of)	272
Pascal	300
Separate compilation	172
Strategy for compiling	170
Structure of	167
Monochrome highlight characters	394
Mouse	54,68
Moving files	116

n

New command (Filer)	146
New sysvol Command (Main Level)	12

o

Object file	300
Object module	300
Object module (definition of)	272
On-Line devices	9
Opcode:	
Assembler	237,239
Co-processor	239
Processor	239
Size suffixes	240
Operand components, Assembler	246
Operand(s):	
Components	241
Constants	241
Description	237,241
Location counter symbol	242
Symbol type	243
Symbols	242
Other manuals	1,2
OVFLCHECK (Compiler option)	197

p

PAGE (Compiler option)	198
Page command (Editor)	89
PAGEWIDTH (Compiler option)	199
Parameter passing	214
PARTIAL_EVAL (Compiler option)	200
Pascal 1.0 (description)	357
Pascal 2.0 (description)	359
Pascal 3.0 (description)	362
Pascal 3.01 (description)	366
Pascal 3.1 (description)	367
Pascal stack	212
Pascal system history	357
Pascal:	
Description of extensions	161
Module	300
Source program	186
Volumes	24
Passing parameters	228
Passwords (SRM files)	46
Permanent Command (Main Level)	13
Physical memory map	375
Prefix command (Filer)	27,147
Prefix volume	26

Problems:	
Compiler	177
File names to avoid	39
Insufficient global space	178
No room on volume	40
Not Enough Memory	178
Syntax errors	163
Procedure calls (effects on stack)	213
Procedures, EXTERNAL	236
Processor, 68020	237
Programming system	225
Prompts:	
Date	20
Debugger	308
Editor	49
Filer	104
Main Level	5
Time	20

q

Queue (Debugger)	310
Quit command (Editor)	90
Quit command (Filer)	149

r

RAM memory	23
RAM memory map	375-6
RANGE (Compiler option)	201
Range of addresses	375
REF (Compiler option)	202
REF tables	301
Reference Pointer	301
Register symbols	242
Relative symbols	244
Remove command (Filer)	150
Removing Files	120
Renaming files	119
Renaming volumes	119
Replace command (Editor)	92
ROM addresses	377
ROM memory map	377
Run Command (Main Level)	14
Run-time errors	408

S

Save command (Filer)	152
SAVE_CONST (Compiler option)	203
Screen dumps (Debugger)	310
SEARCH (Compiler option)	204
SEARCH_SIZE (Compiler option)	205
Set command (Editor)	95
Single stepping a program	309
Size suffixes of opcodes	240
Slow program execution	309
Software memory map	381
Source program	162
SRM:	
Access rights	46,110
Concurrent file access	46
Creating a Directory	115
Current working volume	43
Default volume	45
Directories	41
Directory structure	41
File names	33
File notation	42
Passwords	46
Unit numbers	42
Volumes	42
Stack (addresses)	381
Stack (How Pascal uses it)	212
Stack frame (Debugger)	318
STACKCHECK (Compiler option)	206,212
STACKCHECK ON (Compiler option)	213
Static and dynamic links (Debugger)	323
Static links (Compiler)	217
Stream Command (Main Level)	15
Stream files	71
Subsystems	5
Suffix Suppression	35
Suffixes	34
Summary:	
Debugger commands	331
Editor commands	72
Filer Commands	122
Librarian commands	293-5
SWITCH_STRPOS (Compiler option)	207
Symbol types:	
Absolute	243
External	244
Register	243
Relative	244
User-defined	243

Symbols	242
Syntax diagram (explanation)	7
SYSPROG (Compiler option)	208
System addresses	381
System File Table	12,21
System files	12,21
System history	357
System Library	8,12,22,277,302
System version	19
System volume:	
General	12,22,107
Purpose of	26

t

TABLE program:	
General	9
TABLES (Compiler option)	209
Text files:	
Creating	50,51
Structure of	70
Text Record	302
Translate command (Filer)	36,111,153
TRAP instruction	213,231

u

U.S. ASCII characters	384-5
U.S./European display characters	386-91
UCSD (Compiler option)	210
Unassemble commands (Librarian)	288-91
Unit directory command (Filer)	155
Unit numbers:	
Defined	25
General	9,10,12
Unit Table	9,10,25
Units (blocked vs unblocked)	25
UNLK instruction	214
Unreported errors	407
User restart Command (Main Level)	18
User-defined symbols	243
Using the stack	235

v

Variables, global	18,20
Variables, zeroing	18
Variables:	
Global	13
Zeroing	13
Verify command (Editor)	99
Version Command (Main Level)	19
Volume ID	29
Volumes command (Filer)	24,105,157
Volumes:	
Backing up	113
Default Volume	26
Defined	24
General	24
Pascal	24
Prefix Volume	26
Renaming	119
Specification (syntax)	125
Syntax of identifier	29
System Volume	26

w

WARN (Compiler option)	211
What command (Filer)	158
What Command (Main Level)	21
Wildcards	37,111
Workfile	121,165
Workfiles	70
WS1.0 file names	33

z

Zap command (Editor)	102
Zero command (Filer)	159

Manual Comment Sheet Instruction

If you have any comments or questions regarding this manual, write them on the enclosed comment sheets and place them in the mail. Include page numbers with your comments wherever possible.

If there is a revision number, (found on the Printing History page), include it on the comment sheet. Also include a return address so that we can respond as soon as possible.

The sheets are designed to be folded into thirds along the dotted lines and taped closed. Do not use staples.

Thank you for your time and interest.

MANUAL COMMENT SHEET

Pascal 3.1 Workstation System
for the HP 9000 Series 200/300

98615-90022

May 1985

Update No. _____

(See the Printing History in the front of the manual)

Name: _____

Company: _____

Address: _____

Phone No: _____

fold ----- fold

Programming Experience: _____

System Configuration: _____

Comments: _____

fold ----- fold

BUSINESS REPLY MAIL

FIRST CLASS PERMIT NO. 37 LOVELAND, COLORADO

POSTAGE WILL BE PAID BY ADDRESSEE

Hewlett-Packard Company
Fort Collins Systems Division
Attn: Customer Documentation
3404 East Harmony Road
Fort Collins, Colorado 80525



NO POSTAGE
NECESSARY
IF MAILED
IN THE
UNITED STATES

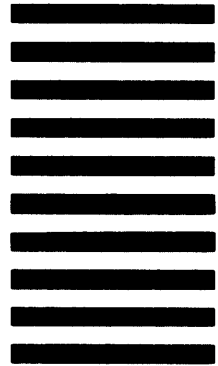



Reorder Number
98615-90022
Printed in U.S.A. 5/85



98615-90621
Mfg. No. Only