User's Guide

**HP B1476
68020/030
Debugger/Emulator**

Notice

Hewlett-Packard makes no warranty of any kind with regard to this material, including, but not limited to, the implied warranties of merchantability and fitness for a particular purpose. Hewlett-Packard shall not be liable for errors contained herein or for incidental or consequential damages in connection with the furnishing, performance, or use of this material.

Hewlett-Packard assumes no responsibility for the use or reliability of its software on equipment that is not furnished by Hewlett-Packard.

© Copyright 1989-1992, Hewlett-Packard Company.

This document contains proprietary information, which is protected by copyright. All rights are reserved. No part of this document may be photocopied, reproduced or translated to another language without the prior written consent of Hewlett-Packard Company. The information contained in this document is subject to change without notice.

Microtec is a registered trademark of Microtec Research Inc.

SunOS, SPARCsystem, OpenWindows, and SunView are trademarks of Sun Microsystems, Inc.

UNIX is a registered trademark of UNIX System Laboratories Inc. in the U.S.A. and other countries.

Hewlett-Packard Company
P.O. Box 2197
1900 Garden of the Gods Road
Colorado Springs, CO 80901-2197, U.S.A.

RESTRICTED RIGHTS LEGEND Use, duplication, or disclosure by the U.S. Government is subject to restrictions set forth in subparagraph (C) (1) (ii) of the Rights in Technical Data and Computer Software Clause in DFARS 252.227-7013. Hewlett-Packard Company, 3000 Hanover Street, Palo Alto, CA 94304 U.S.A.

Rights for non-DOD U.S. Government Departments and Agencies are set forth in FAR 52.227-19(c)(1,2).

Printing History

New editions are complete revisions of the manual. The date on the title page changes only when a new edition is published.

A software code may be printed before the date; this indicates the version level of the software product at the time the manual was issued. Many product updates and fixes do not require manual changes, and manual corrections may be done without accompanying product changes. Therefore, do not expect a one-to-one correspondence between product updates and manual revisions.

Edition 1 B1476-97006, July 1992

Certification and Warranty

Certification and warranty information can be found at the end of this manual on the pages before the back cover.

Debugging C Programs for 68020/030 Microprocessors

The HP B1476 68020/030 Debugger/Emulator is a debugging tool for 68020 and 68030 microprocessor code. The debugger loads and executes C programs or assembly language programs on an HP 64748 or HP 64747 emulator. The code is executed in real time unless a specific feature of the debugger or emulator requires halting the processor. The emulator functions as a high-speed execution environment for the debugger.

With the Debugger, You Can ...

- Browse and edit C and C++ source files.
- View C and C++ functions on the stack.
- Monitor variables as the program executes.
- View assembly language code with source lines.
- View registers and stack contents.
- Step through programs by C or C++ source lines or by assembly language instructions.
- Stop programs upon the execution of selected instructions or upon a read or write of selected memory locations.
- Create conditional breakpoints using macros.
- Patch C or C++ code without recompiling.
- Collect microprocessor bus-level data as the program executes. You can specify when data should be collected and which states get saved.
- Simulate input and output devices using your computer's keyboard, display, and file system.
- Save and execute command files.
- Log debugger commands and output.
- Examine the inheritance relationships of C++ classes.
- Use the debugger, the emulator/analyzer, and the Software Performance Analyzer together.

With the Graphical Interface You Can ...

- Use the debugger under an X Window System that supports OSF/Motif interfaces.
- Enter debugger commands using pull-down or pop-up menus.
- Set source-level breakpoints using the mouse.
- Create custom action keys for commonly used debugger commands or command files.
- View source code, monitored data, registers, stack contents, and backtrace information in separate windows on the debugger's main display.
- Access on-line help information.
- Quickly enter commands using the guided syntax of the standard interface.

With the Standard Interface You Can ...

- Use the debugger with a terminal or terminal emulator.
- Quickly enter commands using guided syntax, command recall, and command editing.
- View source code, monitored data, registers, stack contents, and backtrace information in separate windows on the debugger's main display.
- Define your own screens and windows in the debugger's main display.
- Access on-line help information.

In This Book

This book is organized into five parts:

Part 1. Quick Start Guide

An overview of the debugger and a short lesson to get you started.

Part 2. User's Guide

How to use the debugger to solve your problems.

Part 3. Concept Guide

Background information on X resources.

Part 4. Reference

Descriptions of what each debugger command does, details of how the debugger works, and a list of error messages.

Part 5. Installation

How to install the debugger software on your computer.

Contents

Part 1 Quick Start Guide

1 Getting Started with the Graphical Interface

The Graphical Interface at a Glance 5

- Pointer and cursor shapes 5
- The Debugger Window 6
- Graphical Interface Conventions 8
- Mouse Buttons 9
- Platform Differences 10

The Quick Start Tutorial 11

- The Demonstration Program 11
- To prepare to run the debugger 12
- To start the debugger 13
- To activate display area windows 15
- To run until main() 16
- To scroll the Code window 17
- To display a function 18
- To run until a line 19
- To edit the program 20
- To display `init_system()` again 21
- To set a breakpoint 21
- To run until the breakpoint 22
- To patch code using a macro 23
- To delete a single breakpoint 25
- To delete all breakpoints 25
- To step through a program 26
- To run until a stack level 26
- To step over functions 27
- To step out of a function 27
- To display the value of a variable 27
- To change the value of a variable 28

Contents

| | |
|--|----|
| To recall an entry buffer value | 29 |
| To display the address of a variable | 30 |
| To break on an access to a variable | 31 |
| To use the command line | 32 |
| To use a C printf command | 32 |
| To turn the command line off | 33 |
| To trace events following a procedure call | 34 |
| To see on-line help | 35 |
| To end the debugging session | 36 |

2 Getting Started with the Standard Interface

| | |
|---|----|
| The Standard Interface At a Glance | 38 |
| The Quick Start Tutorial | 40 |
| Before You Begin | 40 |
| The Demonstration Program | 40 |
| To copy the demonstration files | 41 |
| To start the debugger | 42 |
| To enter commands | 43 |
| To activate display area windows | 43 |
| To display main() | 44 |
| To display a subroutine | 44 |
| To set a breakpoint | 45 |
| To run the demo program | 45 |
| To step through the program | 46 |
| To step over functions | 46 |
| To delete a breakpoint | 46 |
| To display variables in their declared type | 47 |
| To display the address of a variable | 47 |
| To use a C printf command | 48 |
| To break on an access to a variable | 48 |
| To display blocks of memory | 49 |
| To monitor variables | 50 |
| To modify a variable by entering a C expression | 50 |
| To end the debugging session | 51 |

Part 2 User's Guide**3 Entering Debugger Commands**

| | |
|--|----|
| Using Menus, the Entry Buffer, and Action Keys | 59 |
| To choose a pull-down menu item using the mouse (method 1) | 59 |
| To choose a pull-down menu item using the mouse (method 2) | 60 |
| To choose a pull-down menu item using the keyboard | 61 |
| To choose pop-up menu items | 62 |
| To use pop-up menu shortcuts | 63 |
| To place values into the entry buffer using the keyboard | 63 |
| To copy-and-paste to the entry buffer | 63 |
| To recall entry buffer values | 65 |
| To edit the entry buffer | 66 |
| To use the entry buffer | 66 |
| To copy-and-paste from the entry buffer to the command line entry area | 66 |
| To use the action keys | 67 |
| To use dialog boxes | 68 |
| To access help information | 72 |
| Using the Command Line with the Mouse | 73 |
| To turn the command line on or off | 74 |
| To enter a command | 75 |
| To edit the command line using the command line pushbuttons | 76 |
| To edit the command line using the command line pop-up menu | 77 |
| To recall commands | 77 |
| To get help about the command line | 78 |
| Using the Command Line with the Keyboard | 79 |
| To enter debugger commands from the keyboard | 79 |
| To edit the command line | 81 |
| To recall commands using the command line recall feature | 81 |
| To display the help window | 82 |
| Viewing Debugger Status | 84 |
| Debugger Status | 84 |
| Indicator Characters | 85 |
| CPU Emulated | 85 |
| Current Module | 85 |

Contents

| | |
|------------------------------|----|
| Last Breakpoint | 86 |
| Trace Status | 86 |
| If pop-up menus don't pop up | 87 |

4 Loading and Executing Programs

| | |
|--|-----|
| Compiling Programs for the Debugger | 90 |
| Using a Hewlett-Packard C Cross Compiler | 90 |
| Using Microtec Language Tools | 92 |
| Loading Programs and Symbols | 94 |
| To specify the location of C source files | 94 |
| To load programs | 95 |
| To load programs only | 96 |
| To load symbols only | 97 |
| To append programs | 97 |
| To specify demand loading of symbols | 98 |
| Stepping Through and Running Programs | 100 |
| To step through programs | 100 |
| To step over functions | 101 |
| To run from the current PC address | 102 |
| To run from a start address | 102 |
| To run until a stop (break) address | 103 |
| Using Breakpoints | 105 |
| To set a memory access breakpoint | 105 |
| To set an instruction breakpoint | 107 |
| To set a breakpoint for a C++ object instance | 109 |
| To set a breakpoint for overloaded C++ functions | 110 |
| To set a breakpoint for C++ functions in a class | 110 |
| To clear selected breakpoints | 111 |
| To clear all breakpoints | 112 |
| To display breakpoint information | 112 |
| To halt program execution on return to a stack level | 115 |
| Restarting Programs | 116 |
| To reset the processor | 116 |
| To reset the program counter to the starting address | 116 |

To reset program variables 117

Loading a Saved CPU State 118

To load a saved CPU state 118

Using the MC68030 Memory Management Unit 120

The deMMUer 120

The emulator/analyzer interface 120

Restrictions when using the MMU 120

To enable the MMU 121

Accessing the UNIX Operating System 122

To fork a UNIX shell 122

To execute a UNIX command 123

Using the Debugger and the Emulator Interface 124

To start the emulation interface from the debugger 124

Using simulator and emulator debugger products together 125

Using the Debugger with the Branch Validator 126

To unload Branch Validator data from program memory 126

5 Viewing Code and Data

Using Symbols 130

To add a symbol to the symbol table 130

To display symbols 131

To display symbols in all modules 132

To delete a symbol from the symbol table 132

Displaying Screens 134

To display the high-level screen 136

To display the assembly level screen 136

To switch between the high-level and assembly screens 136

To display the standard I/O screen 137

To display the next screen (activate a screen) 137

Contents

| | |
|--|-----|
| Displaying Windows | 139 |
| To change the active window | 141 |
| To select the alternate view of a window | 142 |
| To view information in the active window | 143 |
| To view information in the "More" lists mode | 144 |
| To copy window contents to a file | 145 |
| Displaying C Source Code | 146 |
| To display C source code | 146 |
| To find first occurrence of a string | 147 |
| To find next occurrence of a string | 147 |
| Displaying Disassembled Assembly Code | 149 |
| To display assembly code | 149 |
| Displaying Program Context | 150 |
| To set current module and function scope | 150 |
| To display current module and function | 151 |
| To display debugger status | 151 |
| To display register contents | 152 |
| To display the function calling chain (stack backtrace) | 153 |
| To display all local variables of a function at the specified stack (backtrace) level | 157 |
| To display the address of the C++ object invoking a member function | 158 |
| Using Expressions | 159 |
| To calculate the value of a C expression | 159 |
| To display the value of an expression or variable | 160 |
| To display members of a structure | 161 |
| To display the members of a C++ class | 162 |
| To display the values of all members of a C++ object | 162 |
| To monitor variables | 163 |
| To monitor the value of a register | 164 |
| To discontinue monitoring specified variables | 164 |
| To discontinue monitoring all variables | 165 |
| To display C++ inheritance relationships | 165 |
| To print formatted output to a window | 166 |
| To print formatted output to journal windows | 166 |

| | |
|---|-----|
| Viewing Memory Contents | 168 |
| To compare two blocks of memory | 168 |
| To search a memory block for a value | 168 |
| To examine a memory area for invalid values | 169 |
| To display memory contents | 170 |
| How Simulated I/O Works | 171 |
| Simulated I/O Connections | 172 |
| Special Simulated I/O Symbols | 173 |
| To enable simulated I/O | 174 |
| To disable simulated I/O | 175 |
| To set the keyboard I/O mode to cooked | 175 |
| To set the keyboard I/O mode to raw | 175 |
| To control blocking of reads | 176 |
| To interpret keyboard reads as EOF | 176 |
| To redirect I/O | 177 |
| To check resource usage | 178 |
| To increase file resources | 179 |
| If problems occur when using simulated I/O | 181 |

6 Making Trace Measurements

| | |
|--|-----|
| The Trace Function | 184 |
| To start a trace using the Code pop-up menu | 190 |
| To start a trace using the command line | 190 |
| To stop a trace in progress | 191 |
| To display a trace | 192 |
| To specify trace events | 193 |
| To delete trace events | 194 |
| To specify storage qualifiers | 194 |
| To specify trigger conditions | 196 |
| To halt program execution on the occurrence of a trigger | 197 |
| To remove a storage qualification term | 198 |
| To remove a trigger term | 198 |
| To trace code execution before and after entry into a function | 199 |
| To trace data written to a variable | 199 |
| To trace data written to a variable and who wrote to the variable | 200 |
| To trace events leading up to writing a particular value in a variable | 201 |
| To execute a complex breakpoint using the trace function | 202 |
| To trace entry to and exit from modules | 203 |
| If tracing is not triggered as expected | 205 |

7 Editing Code and Data

Editing Files 208

- To edit source code from the Code window 208
- To edit an arbitrary file 209
- To edit a file based on an address in the entry buffer 209
- To edit a file based on the current program counter 209

Patching Source Code 210

- To change a variable using a C expression 210
- To patch a line of code using a macro 211
- To patch C source code by inserting lines 212
- To patch C source code by deleting lines 212

Editing Memory Contents 214

- To change the value of one memory location 214
- To change the values of a block of memory interactively 214
- To copy a block of memory 215
- To fill a block of memory with values 216
- To compare two blocks of memory 216
- To re-initialize all program variables 217
- To change the contents of a register 217

8 Using Macros and Command Files

Using Macros 221

- To display the Macro Operations dialog box 225
- To define a new macro interactively using the graphical interface 225
- To use an existing macro as a template for a new macro 226
- To define a macro interactively using the command line 227
- To define a macro outside the debugger 228
- To edit an existing macro 228
- To save macros 229
- To load macros 229
- If macros do not load 229
- To call a macro 230
- To call a macro from within an expression 231
- To call a macro from within a macro 231
- To call a macro on execution of a breakpoint 232
- To call a macro when stepping through programs 234

- To stop a macro 235
- To display macro source code 235
- To delete a macro 236

Using Command Files 237

- To record commands 238
- To place comments in a command file 239
- To pause the debugger 239
- To stop command recording 240
- To run a command file 240
- To set command file error handling 241
- To append commands to an existing command file 242
- To record commands and results in a journal file 242
- To stop command and result recording to a journal file 243
- To open a file or device for read or write access 243
- To close the file associated with a window number 244
- To use the debugger in batch mode 245

9 Configuring the Debugger

Setting the General Debugger Options 249

- To display the Debugger Options dialog box 249
- To list the debugger options settings 249
- To specify whether command file commands are echoed to the Journal window 250
- To set automatic alignment for breakpoints and disassembly 250
- To set backtrace display of bad stack frames 251
- To specify demand loading of symbols 252
- To select the interpretation of numeric literals (decimal/hexadecimal) 252
- To specify step speed 253

Setting the Symbolics Options 254

- To display symbols in assembly code 254
- To display intermixed C source and assembly code 255
- To enable parameter checking in commands and macros 255

Setting the Display Options 257

- To specify the Breakpoint window display behavior 257
- To specify the View window display behavior 258
- To specify the standard I/O window display behavior 258

Contents

| | |
|--|------------|
| To display half-bright or inverse video highlights | 259 |
| To display information a screen at a time (more) | 259 |
| To specify scroll amount | 260 |
| To store timing information when tracing | 260 |
| To mask fetches while tracing | 261 |
| Modifying Display Area Windows | 262 |
| To resize or move the active window | 262 |
| To move the Status window | 263 |
| To define user screens and windows | 264 |
| To display user-defined screens | 265 |
| To erase standard I/O and user-defined window contents | 265 |
| To remove user-defined screens and windows | 266 |
| Saving and Loading the Debugger Configuration | 267 |
| To save the current debugger configuration | 267 |
| To load a startup file | 268 |
| Setting X Resources | 270 |
| To modify the debugger's graphical interface resources | 272 |
| To use customized scheme files | 276 |
| To set up custom action keys | 278 |
| To set initial recall buffer values | 279 |
| To set up demos or tutorials | 280 |
| 10 Configuring the Emulator | |
| To start the Emulator Configuration dialog box | 285 |
| To modify a configuration section | 286 |
| To store a configuration | 287 |
| To examine the emulator configuration | 288 |
| To change the configuration directory context | 288 |
| To display the configuration context | 289 |
| To access configuration help information | 289 |
| To exit the Emulator Configuration dialog box | 289 |
| To load a configuration file | 290 |
| To create or modify a configuration file | 292 |
| If an error occurs when loading a configuration file | 292 |
| To store an emulator configuration | 293 |

| | |
|--|---------|
| Emulator Configuration Items | 294 |
| Memory | 294 |
| Emulation Monitor | 294 |
| Break Conditions | 295 |
| Other Configuration Items | 295 |
| To enter the monitor after configuration | 296 |
| To restrict to real-time runs | 297 |
| To enable the processor cache memory | 298 |
| To enable one wait state for emulation memory | 299 |
| To change the memory configuration | 299 |
| To enable the MC68030 Memory Management Unit | 300 |
| To select and configure the MC68030 emulation monitor | 301 |
| To select and configure the emulation monitor | 301 |
| To set up specifications for the emulation monitor | 302 |
| To assign memory map terms | 308 |
| To modify the emulator pod configuration | 316 |
| To disable target system interrupts | 317 |
| To preset the interrupt stack pointer and Program Counter | 317 |
| To set the target memory access size | 319 |
| To modify the debug/trace options | 320 |
| To break the processor on a write to ROM | 320 |
| To define the software breakpoint vector | 321 |
| To trace background or foreground operation | 322 |
| To configure the analyzer clock | 323 |
| To modify the simulated I/O configuration | 324 |
| To modify the interactive measurement specification | 325 |
| Mapping The Foreground Monitor For Use With The MC68030 MMU | 326 |
| To modify the MMU mappings to translate the monitor address space 1:1 | 327 |
| To modify a transparent translation register to map the monitor address space 1:1 | 328 |

Part 3 Concept Guide

11 X Resources and the Graphical Interface

| | |
|---|-----|
| An X resource is user-definable data | 332 |
| A resource specification is a name and a value | 332 |
| Don't worry, there are shortcuts | 333 |
| But wait, there is trouble ahead | 334 |
| Class and instance apply to applications as well | 335 |
| Resource specifications are found in standard places | 336 |
| Loading order resolves conflicts between files | 337 |
| The app-defaults file documents the resources you can set | 338 |
| Scheme files augment other X resource files | 338 |
| You can create your own scheme files, if you choose | 340 |
| Scheme files continue the load sequence for X resources | 340 |
| You can force the debugger's graphical interface to use certain schemes | 340 |
| Resource setting - general procedure | 342 |

Part 4 Reference

12 Debugger Commands

| | |
|--|-----|
| How Pulldown Menus Map to the Command Line | 348 |
| How Popup Menus Map to the Command Line | 351 |
| Command Summary | 353 |
| Breakpoint Commands | 353 |
| Session Control Commands | 353 |
| Expression Commands | 354 |
| File Commands | 354 |
| Memory Commands | 355 |
| Program Commands | 356 |
| Symbol Commands | 356 |
| Trace Commands | 357 |
| Window Commands | 357 |

Breakpt Access 358
 Breakpt Clear_All 360
 Breakpt Delete 361
 Breakpt Instr 362
 Breakpt Read 364
 Breakpt Write 365
 Debugger Directory 366
 Debugger Execution Display_Status 367
 Debugger Execution Environment FwdCmd 368
 Debugger Execution Environment Load_Config 369
 Debugger Execution Environment Modify_Config 370
 Debugger Execution IO_System 371
 Debugger Execution Load_State 374
 Debugger Execution Reset_Processor 375
 Debugger Host_Shell 376
 Debugger Help 378
 Debugger Level 379
 Debugger Macro Add 380
 Debugger Macro Call 383
 Debugger Macro Display 384
 Debugger Option Command_Echo 385
 Debugger Option General 386
 Debugger Option List 389
 Debugger Option Symbolics 390
 Debugger Option Trace 392
 Debugger Option View 393
 Debugger Pause 396
 Debugger Quit 397
 Expression C_Expression 399
 Expression Display_Value 400
 Expression Fprintf 403
 Expression Monitor Clear_All 408
 Expression Monitor Delete 409
 Expression Monitor Value 410
 Expression Printf 413
 File Command 415
 File Error_Command 416
 File Journal 417
 File Log 418
 File Startup 420
 File User_Fopen 423

Contents

| | |
|--------------------------------|-----|
| File Window_Close | 425 |
| Memory Assign | 426 |
| Memory Block_Operation Copy | 428 |
| Memory Block_Operation Fill | 429 |
| Memory Block_Operation Match | 431 |
| Memory Block_Operation Search | 433 |
| Memory Block_Operation Test | 435 |
| Memory Display | 437 |
| Memory Register | 439 |
| Memory Unload_BBA | 441 |
| Program Context Display | 444 |
| Program Context Expand | 445 |
| Program Context Set | 446 |
| Program Display_Source | 447 |
| Program Find_Source Next | 448 |
| Program Find_Source Occurrence | 449 |
| Program Load | 451 |
| Program Pc_Reset | 454 |
| Program Run | 455 |
| Program Step | 458 |
| Program Step Over | 460 |
| Program Step With_Macro | 462 |
| Symbol Add | 463 |
| Symbol Browse | 466 |
| Symbol Display | 467 |
| Symbol Remove | 472 |
| Trace Again | 474 |
| Trace deMMUer | 475 |
| Trace Display | 477 |
| Trace Event Clear_All | 483 |
| Trace Event Delete | 484 |
| Trace Event List | 485 |
| Trace Event Specify | 486 |
| Trace Event Used_List | 490 |
| Trace Halt | 491 |
| Trace StoreQual | 492 |
| Trace StoreQual Event | 496 |
| Trace StoreQual List | 498 |
| Trace StoreQual None | 499 |
| Trace Trigger | 500 |
| Trace Trigger Event | 504 |

| | |
|---------------------|-----|
| Trace Trigger List | 507 |
| Trace Trigger Never | 508 |
| Window Active | 509 |
| Window Cursor | 511 |
| Window Delete | 512 |
| Window Erase | 513 |
| Window New | 514 |
| Window Resize | 517 |
| Window Screen_On | 518 |
| Window Toggle_View | 519 |

13 Expressions and Symbols in Debugger Commands

| | |
|--|-----|
| Expression Elements | 523 |
| Operators | 523 |
| Constants | 525 |
| | |
| Symbols | 530 |
| Program Symbols | 530 |
| Debugger Symbols | 531 |
| Macro Symbols | 531 |
| Reserved Symbols | 532 |
| Line Numbers | 532 |
| | |
| Addresses | 533 |
| Code Addresses | 533 |
| Data and Assembly Level Code Addresses | 533 |
| Address Ranges | 533 |
| | |
| Keywords | 535 |
| | |
| Forming Expressions | 536 |
| | |
| Expression Strings | 537 |
| | |
| Symbolic Referencing | 538 |
| Storage Classes | 538 |
| Data Types | 539 |
| Special Casting | 542 |
| Scoping Rules | 543 |

Contents

| | |
|---------------------|-----|
| Referencing Symbols | 543 |
| Evaluating Symbols | 547 |
| Stack References | 548 |

14 Reserved Symbols

15 Predefined Macros

| | |
|-------------|-----|
| break_info | 558 |
| byte | 560 |
| close | 561 |
| cmd_forward | 562 |
| dword | 564 |
| error | 565 |
| fgetc | 566 |
| fopen | 567 |
| key_get | 568 |
| key_stat | 569 |
| memchr | 570 |
| memclr | 571 |
| memcpy | 572 |
| memset | 573 |
| open | 574 |
| pod_command | 576 |
| read | 578 |
| reg_str | 579 |
| showversion | 580 |
| strcat | 581 |
| strchr | 582 |
| strcmp | 583 |
| strcpy | 584 |
| stricmp | 585 |
| strlen | 586 |
| strncmp | 587 |
| until | 588 |
| when | 589 |
| word | 590 |
| write | 591 |

16 Debugger Error Messages**17 Debugger Versions**

| | |
|--------------------------------|-----|
| Version A.05.00 | 612 |
| Graphical User Interface | 612 |
| New Product Number | 612 |
| New Reserved Symbols | 612 |
| New Predefined Macro | 612 |
| Environment Variable Expansion | 613 |
| Target Program Function Calls | 613 |
| C++ Support | 613 |
| Simulated Interrupts Removed | 613 |
| Simulated I/O Changes | 613 |
| Support for 68030 with MMU | 613 |

Part 5 Installation Guide
18 Installation

| | |
|---|-----|
| Installation at a Glance | 618 |
| Supplied interfaces | 618 |
| Supplied filesets | 619 |
| Emulator/Analyzer Compatibility | 619 |
| To install software on an HP 9000 system | 620 |
| Required Hardware and Software | 620 |
| Step 1. Install the software | 621 |
| To install the software on a Sun SPARCsystem™ | 624 |
| Required Hardware and Software | 624 |
| Step 1: Install the software | 625 |
| Step 2: Map your function keys | 625 |

Contents

| | |
|--|------------|
| To install the emulator hardware | 627 |
| To set up your software environment | 628 |
| To start the X server | 628 |
| To start HP VUE | 629 |
| To set environment variables | 630 |
| To find the logical name of your emulator | 632 |
| To add an emulator to the 64700tab.net file | 633 |
| To add an emulator to the /etc/hosts file | 634 |
| To verify the software installation | 635 |
| To remove software | 636 |
| Configuring Terminals for Use with the Debugger | 637 |
| To configure HP terminals or bit-mapped displays | 641 |
| To configure the DEC VT100 terminal | 643 |
| To configure the VT220 terminal | 645 |
| To set the TERM environment variable | 648 |
| To set up control sequences | 649 |
| To resize a debugger window in an X-Window larger than 24 lines by 80 columns | 650 |
| To resize a debugger window in a window larger than 24 lines by 80 columns | 651 |

Part 1

Quick Start Guide

Part 1



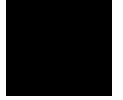

Getting Started with the Graphical Interface

How to get started using the debugger's graphical interface.

Chapter 1: Getting Started with the Graphical Interface



When an X Window System that supports OSF/Motif interfaces is running on the host computer, the debugger has a *graphical interface* that provides features such as pull-down and pop-up menus, point and click setting of breakpoints, cut and paste, on-line help, customizable action keys and pop-up recall buffers.

The debugger also has a *standard interface* for several types of terminals, terminal emulators, and bitmapped displays. When using the standard interface, commands are entered from the keyboard. If you are using the debugger's standard interface, please skip to the chapter "Getting Started with the Standard Interface".

Some advanced commands are not well-suited to menus. Those commands are entered through the *command line*. The command line allows you to enter standard interface commands in the graphical interface.

The Graphical Interface at a Glance



Pointer and cursor shapes



Arrow

The arrow mouse pointer shows where the mouse is pointing.



Hand

The hand mouse pointer indicates that a pop-up menu is available by pressing the right mouse button.



Hourglass

The hourglass mouse pointer means "wait." If the debugger is busy executing a program, you may stop it by pressing < **Ctrl**> -**C**.



Text

The "I-beam" keyboard cursor shows where text entered with the keyboard will appear in the entry buffer or in a dialog box.



Command-line

The "box" keyboard cursor on the command line shows where commands entered with the keyboard will appear.

The Debugger Window

The screenshot shows a debugger window with the following components and content:

- Menu bar:** File, Display, Modify, Execution, Breakpoints, Window, Settings, Help
- Action keys:**
 - Row 1: < Demo >, Disp Src (), Disp Src PC, Run, Run Til (), Run Xfer
 - Row 2: < Your Key >, Make, C Expr (), Monitor (), Step, Step Over, Step Out
- Entry buffer:** (): main Recall
- Display area:**
 - Monitor:**

```

1 num_checks 0
2 target_temp 0
3 current_tem 0
4 old_data [00]:temp 0
5 humid 0
6 ave_temp 0.000000E+00
7 ave_humid 0.000000E+00
8 [01]:temp 0
                    
```
 - Backtrace:**

```

0. 00000400:crt0\entry
                    
```
 - Code:**

```

1 /******
2 A Hewlett-Packard Software Product
3 Copyright Hewlett-Packard Co. 1992
4
5 All Rights Reserved. Reproduction, adaptation, or translation without pri
6 written permission is prohibited, except as allowed under copyright law
7 *****
8 #include <stdio.h>
9 #include <string.h>
10 #include "update_sys.h"
11 #include "proc_spec.h"
12 /******
13 * This typedef is also found in demo.h but since demo.h is not included in
14 * this file, this declaration appears here by itself.
15 *****
16 #define SHRINKFACTOR 1.3
17 #define LISTLEN NUM_OF_OLD*4+1
                    
```
 - Journal:**

```

> File Command /usr/hp64000/cmdfiles/debug/examples.com
                    
```
- Status line:** STATUS: Command 68EC030 MODULE: crt0 BREAK #: 0 TRC:Idle
- Command line:**
 - Buttons: Breakpt, Debugger, Expression, Memory, Program, Symbol, Window, Trace
 - Text: Command Error_Command User_Fopen Journal Log Window_Close Startup
 - Buttons: Command: Return, Recall; Cursor: Backup, Forward, Clear to end, Clear; Help

Menu Bar. Provides pull-down menus from which you select commands. When menu items are not applicable, they appear half-bright and do not respond to mouse clicks.



Action Keys. User-defined pushbuttons. You can label these pushbuttons and define the action to be performed. Action key labels and functions are defined by setting X resources (see the “Configuring the Debugger” chapter).

Entry Buffer. Wherever you see "()" in a pull-down menu, the contents of the entry buffer are used in that command. You can type values into the entry buffer, or you can cut and paste values into the entry buffer from the display area or from the command line entry area. You can also set up action keys to use the contents of the entry buffer.

Display Area. This area of the screen is divided into windows which display information such as high-level code, simulated input and output, and breakpoints. To activate a window, click on its border.

In this manual, the word "window" usually refers to a window inside the debugger display area.

Scroll Bar. Allows you to page or scroll up or down the information in the active window.

Status Line. Displays the debugger status, the CPU type, the current program module, the number of the last breakpoint, and the trace status. You can press and hold the right mouse button to access the Status Line pop-up menu.

Command Line. The command line area is similar to the command line in the standard interface; however, the graphical interface lets you use the mouse to enter and edit commands. You can turn off the command line if you only need to use the pull-down menus.

Graphical Interface Conventions

This manual uses a shorthand notation for indicating that you should choose a particular menu item. For example, the following instruction

Choose **File**→**Load**→**Executable...**

means to select the **File** menu, then select **Load** from the File menu, then select the **Executable...** item from the Load menu.

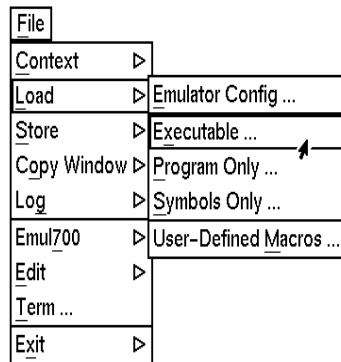

Refer to the “Entering Debugger Commands” for specific information about choosing menu items.

In this manual, the word "window" usually means a window inside the debugger display area, rather than an X window.

Mouse Buttons

Mouse Button Descriptions

| Button Name | General Function |
|-----------------------|---|
| left | Selects pushbuttons. Pastes from the display area to the entry buffer. |
| middle | Pastes from the entry buffer to the command line text area. If you have a two-button mouse, press both buttons together to get the "middle button." |
| right | Click selects first item in pop-up menus. Click on window border activates windows. Press and hold displays menus. |
| <i>command select</i> | Displays pull-down menus. May be the left button or right button, depending on the kind of computer you have. <i>See</i> "Platform Differences." |

Platform Differences

A few mouse buttons and keyboard keys work differently between platforms. This manual refers to those mouse button and keyboard bindings in a general way. Refer to the following tables to find out the button names for the computer you are using to run the debugger.

Mouse Button Bindings

| Generic Button Name | HP 9000 | Sun SPARCsystem |
|----------------------------|----------------|------------------------|
| <i>command select</i> | left | right |

Keyboard Key Bindings

| Generic Key Name | HP 9000 | Sun SPARCsystem |
|-------------------------|----------------|--------------------------|
| menu select | extend char | extend char (diamond) |
| left-arrow | left arrow | left arrow ¹ |
| right-arrow | right arrow | right arrow ¹ |

¹These keys do not work while the cursor is in the main display area.

The Quick Start Tutorial

This tutorial gives you step-by-step instructions on how to perform a few basic tasks using the debugger.

Perform the tasks in the sequence given; otherwise, your results may not be the same as those shown here.

Some values displayed on your screen may vary from the values shown here. The exercises and displays in this chapter were made using a HP 64747 40 MHz 68030/EC030 emulator. If you are using an emulator with a different clock rate or the HP 64748 68020 emulator, the information displayed in some windows on your screen will be different.

The Demonstration Program

The demonstration program used in this chapter is a simple environmental control system (ECS). The system controls the temperature and humidity of a room requiring accurate environmental control. The program continuously looks at flags which tell it what action to take next.

Note

Some commands are printed on two lines in this chapter. When entering these commands, type the entire command on one line.

To prepare to run the debugger

1 Check that the debugger has been installed on your computer. Installation is described in the "Installation" chapter.

2 Find the logical name of your emulator.

The emulator name *emul68k* is used in the examples in this chapter. If you have given your emulator a different logical name in the HP 64700 emulator device table */usr/hp64000/etc/64700tab.net*, use your emulator name or lan address in the examples. See the section "To find the logical name of your emulator" in the "Installation" chapter of this manual. See the *HP 64700A Card Cage Installation/Service Manual* for detailed information on installing your emulator.

3 Find out where the debugger software is installed. If it is not installed under */usr/hp64000* then use *"\$HP64000"* wherever */usr/hp64000* is printed in this chapter.

4 Check that */usr/hp64000/bin* and *."* are in your *\$PATH* environment variable. (Type *"echo \$PATH"* to see the value of *\$PATH*.)

5 If the debugger software is installed on a different kind of computer than the computer you are using, edit the "platformScheme" in the */usr/hp64000/demo/debug_env/hp64747/Xdefaults.demo* or */usr/hp64000/demo/debug_env/hp64748/Xdefaults.demo* file. For example, if you are sitting at a Sun workstation which is networked to an HP 9000 Series 300 workstation, change the platformScheme to "SunOS".

To start the debugger



- 1 Change to the debugger demo directory:

```
cd /usr/hp64000/demo/debug_env/<emulator>
```

where *<emulator>* is *hp64747* for a 68030 or 68EC030 emulator, or *hp64748* for a 68020 emulator.

- 2 Start the debugger by entering:

```
Startdebug emul68k
```

This will set some environment variables, start the debugger, load a configuration file, and load a program for you to look at.

If the logical name of your emulator is not *emul68k*, then use the name of your emulator instead of *emul68k*. If you do not know the name of your emulator, see “To find the logical name of your emulator” in the “Installation” chapter of this manual.

The Startdebug script will ask you whether it should copy the demo files to another directory.

Or, if you have installed the emulator/analyzer and Software Performance Analyzer interfaces, you can use the following command to start all of the interfaces:

```
Startall emul68k
```

Note

If you were debugging your own program, you would need to enter a command like:

```
db68k -e emul68k -C Config -c mycmd ecs
```

or, for the 68030/EC030 debugger/emulator:

```
db68030 -e emul68k -C Config -c mycmd ecs
```

Chapter 1: Getting Started with the Graphical Interface
To start the debugger

This command starts the debugger, which executes the command file *mycmd.com* and loads the absolute file *ecs.x*. See the “Loading and Executing Programs” chapter for more details.

| | | | | | | | | | | | | | | | | | | | | | | | | | | | |
|---|--|----------|--|--------------|--|----------------------|--|------|--------|-------------|--|-------------------------------------|--|--|-------------|--|--|--------|--|--|----------|--|--------|------|--|--|--|
| File | | | | | | Display | | | Modify | | | Execution | | | Breakpoints | | | Window | | | Settings | | | Help | | | |
| Action keys: | | < Demo > | | Disp Src () | | Disp Src PC | | Run | | Run Til () | | Run Xfer | | | | | | | | | | | | | | | |
| < Your Key > | | Make | | C Expr () | | Monitor () | | Step | | Step Over | | Step Out | | | | | | | | | | | | | | | |
| (): main | | | | | | | | | | | | | | | | | | | | | | | Recall | | | | |
| Monitor | | | | | | | | | | | | Backtrace | | | | | | | | | | | | | | | |
| <pre> 1 num_checks 0 2 target_temp 0 3 current_tem 0 4 old_data [00]:temp 0 5 humid 0 6 ave_temp 0.000000E+00 7 ave_humid 0.000000E+00 8 [01]:temp 0 </pre> | | | | | | | | | | | | <pre> 0. 00000400:crt0\entry </pre> | | | | | | | | | | | | | | | |
| Code | | | | | | | | | | | | | | | | | | | | | | | | | | | |
| <pre> 1 /***** 2 A Hewlett-Packard Software Product 3 Copyright Hewlett-Packard Co. 1992 4 5 All Rights Reserved. Reproduction, adaptation, or translation without pri 6 written permission is prohibited, except as allowed under copyright law 7 *****/ 8 #include <stdio.h> 9 #include <string.h> 10 #include "update_sys.h" 11 #include "proc_spec.h" 12 /***** 13 * This typedef is also found in demo.h but since demo.h is not included in 14 * this file, this declaration appears here by itself. 15 *****/ 16 #define SHRINKFACTOR 1.3 17 #define LISTLEN NUM_OF_OLD*4+1 </pre> | | | | | | | | | | | | | | | | | | | | | | | | | | | |
| Journal | | | | | | | | | | | | | | | | | | | | | | | | | | | |
| > File Command /usr/hp64000/cmdfiles/debug/examples.com | | | | | | | | | | | | | | | | | | | | | | | | | | | |
| STATUS: Command | | | | | | 68EC030 MODULE: crt0 | | | | | | BREAK #: 0 TRC:Idle | | | | | | | | | | | | | | | |

To activate display area windows

Notice there are several windows in the main display area of the debugger. The different windows contain different types of information from the debugger. The active window has the thicker border.

- 1** Use the right mouse button to click on the border of the Monitor window.

Be sure to click only once (do not "double-click"). The Monitor window should now have a thick border. Now activate the Code window:

- 2** Use the right mouse button to click on the border of the Code window.

If you click on the border of the active window, it will be expanded. Just click again to show the window in its normal size.

See the "Debugging Programs" chapter for a list of other ways to activate a window.

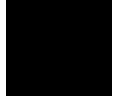

To run until main()

- 1 Click on the **Run Til ()** action key.

The Code window now shows the *main ()* routine.

Clicking on the **Run Til ()** action key runs the program until the line indicated by the contents of the *entry buffer*.

Locate the **():** symbol. The area to the right of this symbol is the entry buffer. When you started the demonstration program, the debugger loaded the entry buffer with the value “main”.

The screenshot shows a debugger window with a menu bar (File, Display, Modify, Execution, Breakpoints, Window, Settings, Help) and a toolbar with action keys: < Demo >, Disp Src (), Disp Src PC, Run, Run Til (), Run Xfer, < Your Key >, Make, C Expr (), Monitor (), Step, Step Over, Step Out, and Recall. The 'Run Til ()' key is highlighted. Below the toolbar, the '()' symbol is set to 'main'. The 'Monitor' window shows variables: num_checks (0), target_temp (0), current_tem (0), old_data ([00]:temp (0), humid (0), ave_temp (0.000000E+00), ave_humid (0.000000E+00), [01]:temp (0)). The 'Backtrace' window shows: 2. 0000203C?crt0\<unknown>, 1. 00002316 startup\startup, 0. 00002CF2*main\main. The 'Code' window shows the main() function starting at line 96. The 'Journal' window shows: > Program Run Until main (Temp) Break module main line 96. The status bar at the bottom indicates: STATUS: InMon, 68EC030 MODULE: main, BREAK #: 1, TRC:Idle.

To scroll the Code window

To see more of the program you can:

- Use the mouse to operate the vertical scroll bar:

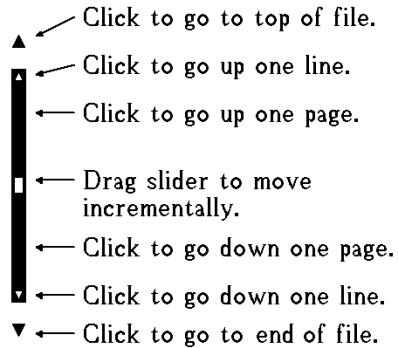

- Use the mouse to operate the horizontal scrolling buttons: 
- Use the < Page Up> and < Page Down> keys on your keyboard.

The scroll bar affects the contents of the active (highlighted) window.

You might notice that the scroll bar has a "sticky" slider which always returns to the center of the scroll bar. This is so that you can always do local navigation even in very large programs. Use the **Disp Src ()** action key or the **Display→Source ()** pull-down menu item to move larger distances.

To display a function

1 Position the cursor over the call to *init_system*.

2 Click the left mouse button.

This will place the string "init_system" into the entry buffer.

3 Click on the **Disp Src ()** action key.

4 Scroll up one line to see the "init_system()" line.

You should now see the source code for the *init_system()* routine in the Code window.

The screenshot displays a debugger window with the following components:

- Menu Bar:** File, Display, Modify, Execution, Breakpoints, Window, Settings, Help.
- Action keys:** < Demo >, Disp Src (), Disp Src PC, Run, Run Til (), Run Xfer.
- Secondary Action keys:** < Your Key >, Make, C Expr (), Monitor (), Step, Step Over, Step Out.
- Entry Buffer:** (): init_system, Recall.
- Monitor Window (3):**

```
1 num_checks 0
2 target_temp 0
3 current_tem 0
4 old_data [00]:temp 0
5           humid 0
6           ave_temp 0.000000E+00
7           ave_humid 0.000000E+00
8           [01]:temp 0
```
- Backtrace Window (4):**

```
2. 0000203C?crt0\<unknown>
1. 00002316 startup\_startup
0. 00002CF2*main\main
```
- Code Window (2):**

```
30 init_system()
31 { /* FUNCTION init_system() */
32 /* Initialize the target values for temperature and humidity */
33 target_temp = 73;
34 target_humid = 45;
35
36 /* Intialize the variables indicating the current environment */
37 /* conditions */
38 current_temp = 68;
39 current_humid = 41;
40
41 /* Set starting directions for temp and humid */
42 temp_dir = up;
43 humid_dir = up;
44
45 /* Initialize the variables that depict the current status of the */
46 /* computer room and what hardware needs to be on or off in the room */
```
- Journal Window (1):**

```
> Program Context Set init_system
> Program Display_Source init_system
```
- Status Bar:** STATUS: Command 68EC030 MODULE: init_system BREAK #: 1 TRC:Idle

To run until a line

- 1 Position the cursor over line 34. The hand-shaped cursor means that a pop-up menu is available.
- 2 Hold down the right mouse button to display the Code window pop-up menu. Move the mouse to **Run until**, then release the button.

Line 34 should now be highlighted. Notice that "init_system" now appears in the Backtrace window at level 0, which means that the program counter is inside the *init_system()* function.

The screenshot shows a debugger window with the following components:

- Menu Bar:** File, Display, Modify, Execution, Breakpoints, Window, Settings, Help.
- Action keys:** < Demo >, Disp Src (), Disp Src PC, Run, Run Til (), Run Xfer.
- Secondary Action keys:** < Your Key >, Make, C Expr (), Monitor (), Step, Step Over, Step Out.
- Command Line:** (): init_system
- Monitor Window (3):**

```

1 num_checks 0
2 target_temp 0
3 current_tem 0
4 old_data [00]:temp 0
5 humid 0
6 ave_temp 0.000000E+00
7 ave_humid 0.000000E+00
8 [01]:temp 0

```
- Backtrace Window (4):**

```

2. 0000203C?crt0\<unknown>
1. 00002316 startup\_startup
0. 00002CF2*main\main

```
- Code Window (2):**

```

30 init_system()
31 { /* FUNCTION init_system() */
32 /* Initialize the target values for temperature and humidity */
33 target_temp = 73;
34 target_humid = 45;
35
36 /* Initialize the variables for the current environment */
37 /* conditions */
38 current_temp = 68;
39 current_humid = 41;
40
41 /* Set starting directions */
42 temp_dir = up;
43 humid_dir = up;
44
45 /* Initialize the variables for the current status of the */
46 /* computer room and its lights to be on or off in the room */

```
- Debugger Display Context Menu:**
 - Debugger Display
 - Set/Delete Breakpoint
 - Edit source
 - Attach Macro ...
 - Edit Attached Macro ...
 - Run until
 - Trace after
 - Trace before
 - Trace about
 - Trace until
- Command Line:**

```

> Program Context Set init_system
> Program Display_Source init_system

```
- Status Bar:** STATUS: Command 68EC030 MODULE: init_system BREAK #: 1 TRC:Idle

To edit the program

This step assumes you are using an HP Advanced Cross Language System compiler (HP B1461/HP B1478). If you are using another compiler, skip this step.

Suppose we wanted the initial value of *target_temp* to be 74 instead of 73. The debugger makes it easy to change the source code:

- 1 Place the cursor over the assignment to *target_temp* (line 33).
- 2 Hold the right mouse button and select **Edit Source** from the Code window pop-up menu.

An editor will appear in a new X window. The default text editor is **vi**. You can use a different text editor by editing the `Xdefaults.demo` file.

```
File Display Modify Execution Breakpoints Window Settings Help
Action keys: < Demo > Disp Src ( ) Disp Src PC Run Run Til ( ) Run Xfer
< Your Key > Make C Expr ( ) Monitor ( ) Step Step Over Step Out
( ): init_system Recall
Monitor 3 Backtrace 4
1 num_checks 0 3. 0000203C?crt0\<unknown>
2 target_temp 73 2. 00002316 startup\startup
3 current_tem 0
4 old_data [00]:temp 0
5 humid 0
6 ave_temp 0.00
7 ave_humid 0.00
8 [01]:temp 0

*****
#include "update_sys.h"
#include "demo.h"
void init_val_arr();
void
init_system()
{
/* FUNCTION init_system() */
/* Initialize the target values for t
target_temp = 74;
target_humid = 45;
/* Intialize the variables indicating
/* conditions */
current_temp = 68;
current_humid = 41;
/* Set starting directions for temp a
temp_dir = up;
humid_dir = up;
/* Initialize the variables that depi
"init_system.c" 100 lines, 3168 character

30 init_system()
31 { /* FUNCTION init_system()
32 /* Initialize the target v
33 target_temp = 73;
34 target_humid = 45;
35
36 /* Intialize the variables
37 /* conditions */
38 current_temp = 68;
39 current_humid = 41;
40
41 /* Set starting directions
42 temp_dir = up;
43 humid_dir = up;
44
45 /* Initialize the variable
46 /* computer room and what

Journal 1
(Temp) Break module init_system line 34
> Debugger Host_Shell vi +33 init_system.c
STATUS: Command 68EC030 MODULE: init_system BREAK #: 1 TRC:Idle
```

- 3 Change the "73" to "74".
- 4 Exit the editor.
- 5 Click on the **Make** action key.

The program will be re-compiled with the new value and reloaded into the emulator.



To display *init_system()* again

- Click on the **Disp Src()** action key.

Since "init_system" is still in the entry buffer, the *init_system()* routine is displayed.

You have now completed a edit-compile-load programming cycle.

To set a breakpoint

We want to run until just past the line that we changed.

- 1 Position the mouse pointer over line 42.
- 2 Click the right mouse button to set a breakpoint.

The breakpoint window is displayed, showing the breakpoint has been added.

An asterisk (*) appears in the first column of the Code window next to the location of the breakpoint. Dots appear in front of any other lines (such as comments) associated with the breakpoint.

To run until the breakpoint

- Click on the **Run Xfer** action key to run the program from its transfer address.

While the program is executing, the menus and buttons are "grayed out," and an "hourglass" mouse pointer is displayed. You cannot enter debugger commands while the program is executing. If you need to stop an executing program, type **< Ctrl> -C** with the mouse pointer in the debugger X window.

After a few moments, line 42 will be highlighted, showing that program execution stopped there.

The Journal window shows that a break occurred and which breakpoint it was.

The screenshot displays a debugger window with the following components:

- Menu Bar:** File, Display, Modify, Execution, Breakpoints, Window, Settings, Help.
- Action keys:** < Demo >, Disp Src (), Disp Src PC, Run, Run Til (), Run Xfer.
- Secondary Action keys:** < Your Key >, Make, C Expr (), Monitor (), Step, Step Over, Step Out.
- Current Module:** (): init_system
- Monitor Window (3):**

```

1 num_checks 0
2 target_temp 73
3 current_tem 68
4 old_data [00]:temp 0
5 humid 0
6 ave_temp 0.000000E+00
7 ave_humid 0.000000E+00
8 [01]:temp 0

```
- Backtrace Window (4):**

```

3. 0000203C?crt0\<unknown>
2. 00002316 startup\_startup
1. 00002CFC main\main
0. 00003242 init_system\init_sy

```
- Code Window (2):**

```

39 current_humid = 41;
40
41 /* Set starting directions for temp and humid */
* 42 temp_dir = up;
43 humid_dir = up;
44
45 /* Initialize the variables that depict the current status of the */
46 /* computer room and what hardware needs to be on or off in the room */
47 func_needed = 0;
48 hdw_encode = 0;
49
50 /*Initialize the count of calls to update_state_of_system() */
51 num_checks = 0;
52
53 /* Initialize writing location in old_array */
54 curr_loc = 0;
55

```
- Journal Window (1):**

```

> Program Run
Break # 1 on instr module init_system line 42

```
- Status Bar:** STATUS: Command 68EC030 MODULE: init_system BREAK #: 1 TRC:Idle

To patch code using a macro

- 1 Position the cursor over line 38.
- 2 Select **Attach macro** from the Code window pop-up menu.

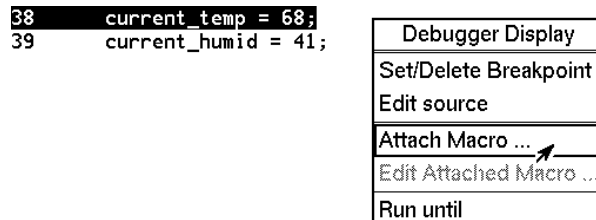

The Macro Operations dialog box appears. The macro "patch_temp" is already selected. Before we attach the macro, let's examine it:

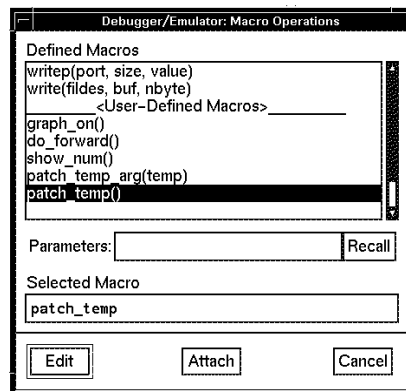

- 3 Click on the **Edit** button in the dialog box.

This macro will set `current_temp` to 71 each time the breakpoint is encountered. The macro skips over the assignment in the program source code by setting the program counter to line 39. The return value of 0 tells the macro to stop program execution after the macro.

Chapter 1: Getting Started with the Graphical Interface

To patch code using a macro

```

Debugger Macro Add int patch_temp()
{
    /* set the current_temp to be 71 degrees instead of what the code says */
    current_temp = 71;

    /* Restart execution at line # 39 -- Skips over the code too!! */
    $Memory Register @PC = #39$;

    /* Return value indicates continuation logic: 1=continue, 0=break */
    return(0);
}

```

- 4 Exit the editor.
- 5 Click on the **Attach** button in the dialog box.

The plus sign ("+") in front of line 38 indicates that a macro has been attached to a breakpoint at that line.

- 6 Click on the **Run Xfer** action key to run the program.

The screenshot shows a debugger window with the following components:

- Menu Bar:** File, Display, Modify, Execution, Breakpoints, Window, Settings, Help.
- Action keys:** < Demo >, Disp Src (), C Expr (), Run, Run til (), Step Over.
- Secondary Action keys:** < Your Key >, Make, Disp Src PC, Monitor (), Step, Run Xfer, Step Out.
- Breakpoint Table:**

| # | ADDRESS | MOD/FUNCT | LINE | TYPE | COMMAND ARGUMENT |
|---|----------|-----------|------|--------|----------------------|
| 1 | 00003242 | init_sys | #42 | INST/H | init_system\#42 |
| 2 | 00003232 | init_sys | #38 | INST/H | init_system\#38; pat |
- Code Editor:** Shows assembly code with line 42 highlighted. Line 38 has a plus sign in front of it, indicating a macro is attached.

```

34 target_humid = 45;
35
36 /* Initialize the variables indicating the current environment */
37 /* conditions */
+ 38 current_temp = 68;
39 current_humid = 41;
40
41 /* Set starting directions for temp and humid */
+ 42 temp_dir = up;
43 humid_dir = up;
44
45 /* Initialize the variables that depict the current status of the */
46 /* computer room and what hardware needs to be on or off in the room */
47 func_needed = 0;
48 hwr_encode = 0;
49
50 /*Initialize the count of calls to update_state_of_system() */

```
- Journal:**

```

Break # 1 on instr module init_system line 42
> Breakpt Instr init_system\#38; patch_temp()

```
- Status Bar:** STATUS: Command 68EC030 MODULE: init_system BREAK #: 1 TRC:Idle

Notice that *current_temp*, as shown in the Monitor window, is 71, not 68.



To delete a single breakpoint

Once you set a breakpoint, program execution will break each time the breakpoint is encountered. If you don't want to break on a certain breakpoint again, you must delete the breakpoint. Suppose you want to delete the breakpoint that was previously set at line 42 in *init_system*.

- 1 Position the mouse over line 42.
- 2 Click the right mouse button to delete the breakpoint.

The breakpoint window shows the breakpoint has been deleted. The asterisk in front of line 42 disappears.

To delete all breakpoints

- 1 Position the mouse pointer in the Breakpoint window.
- 2 Hold down the right mouse button to select **Delete All Breakpoints** from the Breakpoint window pop-up menu.

All breakpoints are deleted.

To step through a program

You can execute one source line (high-level mode) or one instruction (assembly-level mode) at a time by stepping through the program.

- Click on the **Step** action key a few times.
- If you want to try using a pull-down menu, select **Execution**→**Step**→**from PC** a few times.

As the debugger steps through the program, you can see the PC progress through the source code, as shown by the inverse video line in the Code window.

To run until a stack level

Now we need to go back to *main()*. You can run the program until it enters *main()* by running to a stack level.

- 1 Position the mouse pointer over the line containing "main\main" in the Backtrace window.
- 2 Select **Run Until Stack Level** from the Backtrace pop-up menu.

The program counter is now back in *main()*, on the call to *proc_spec_init()*.

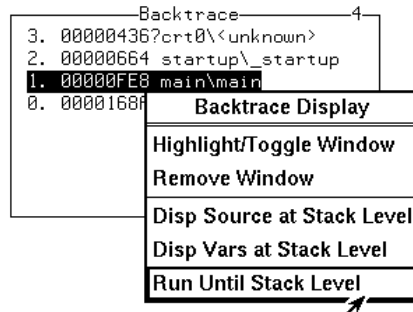

To step over functions

You can either step through functions or step over functions. When you step over a function, it is executed as a single program step.

- Click on the **Step Over** action key.

The next line in *main()* is highlighted. The routine *proc_spec_init()* was executed as a single program step.

To step out of a function

- 1 Click on the **Step** action key until the program counter is in *update_system()*.
- 2 Click on the **Step Out** action key.

The program will execute until it returns from *update_system()*.

To display the value of a variable

- 1 Use the left mouse button to highlight "num_checks" in the Code window.
- 2 Click on the **C Expr ()** action key.

In the Journal window, the current value of the variable is displayed in its declared type (int). Notice that this is the same as the value displayed in the Monitor window.

To change the value of a variable

- 1 In the entry buffer, add "= 10" after "num_checks".
- 2 Click on the **C Expr ()** action key.

The new value is displayed in the Journal window and in the Monitor window.

| File Display Modify Execution Breakpoints Window Settings Help | | | | | | |
|--|---|------------------------|----------------------|-------------------------|---------------------|-----------|
| Action keys: | < Demo > | Disp Src () | C Expr () | Run | Run til () | Step Over |
| < Your Key > | Make | Disp Src PC | Monitor () | Step | Run Xfer | Step Out |
| (:) | num_checks=10 | | | | | Recall |
| Monitor | | | Backtrace | | | |
| 1 | num_checks | 10 | 2. | 000203C?crt0\<unknown> | | |
| 2 | target_temp | 76 | 1. | 0002316 startup\startup | | |
| 3 | current_tem | 70 | 0. | 0002D0A main\main | | |
| 4 | old_data | [00]:temp 70 | | | | |
| 5 | | humid 43 | | | | |
| 6 | | ave_temp 0.000000E+00 | | | | |
| 7 | | ave_humid 0.000000E+00 | | | | |
| 8 | | [01]:temp 65 | | | | |
| Code | | | | | | |
| 100 | while (true) | | | | | |
| 101 | { | | | | | |
| 102 | update_system(); | | | | | |
| 103 | num_checks++; | | | | | |
| 104 | interrupt_sim(&num_checks); | | | | | |
| 105 | if (graph) | | | | | |
| 106 | graph_data(); | | | | | |
| 107 | proc_specific(); | | | | | |
| 108 | } | | | | | |
| 109 | } | | | | | |
| 110 | | | | | | |
| 111 | /***** | | | | | |
| 112 | * FUNCTION: interrupt_sim | | | | | |
| 113 | * PARMs: counter -- loop counter passed in from main | | | | | |
| 114 | * DESCRIPTION: | | | | | |
| 115 | * create a simulation of a (usually) long interrupt service routine tha | | | | | |
| 116 | * also has a duration profile to use with a SPA duration trigger. | | | | | |
| Journal | | | | | | |
| > | Expression C_Expression num_checks=10 | | | | | |
| | Result is: 10 0x0A | | | | | |
| STATUS: Command | | | 68EC030 MODULE: main | | BREAK #: 1 TRC:Idle | |

To recall an entry buffer value

- 1 Click on the **Recall** button.
- 2 In the Recall dialog box, click the left mouse button on "num_checks".
- 3 In the Recall dialog box, click the left mouse button on **OK**.

The string "num_checks" is now in the entry buffer.

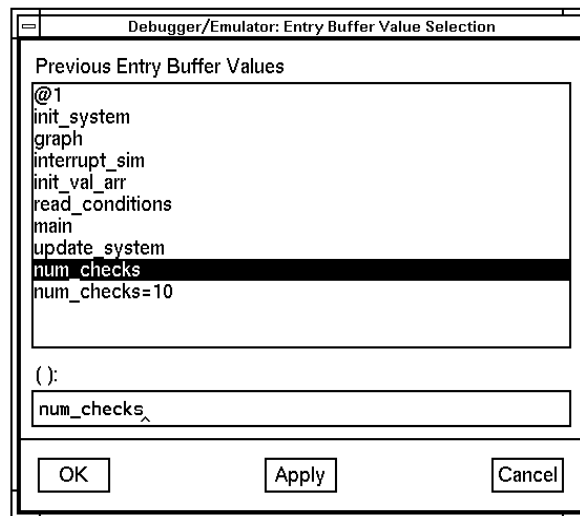

To display the address of a variable

You can use the C address operator (&) to display the address of a program variable.

- 1 Position the mouse pointer in the entry buffer.
- 2 Type "&" in the entry buffer so that it contains "&num_checks".
- 3 Click on the **C Expr ()** action key.

The result is the address of the variable *num_checks*. The address is displayed in hexadecimal format.

The screenshot shows a debugger window with a menu bar (File, Display, Modify, Execution, Breakpoints, Window, Settings, Help) and a toolbar with buttons for Action keys, < Demo >, Disp Src (), C Expr (), Run, Run til (), Step Over, < Your Key >, Make, Disp Src PC, Monitor (), Step, Run Xfer, Step Out, and Recall. The entry buffer contains the expression (&) : &num_checks. The Monitor window displays the following data:

| | | | | |
|---|-------------|-----------|--------------|--|
| 1 | num_checks | 10 | | |
| 2 | target_temp | 76 | | |
| 3 | current_tem | 70 | | |
| 4 | old_data | [00]:temp | 70 | |
| 5 | | humid | 43 | |
| 6 | | ave_temp | 0.000000E+00 | |
| 7 | | ave_humid | 0.000000E+00 | |
| 8 | | [01]:temp | 65 | |

The Backtrace window shows the following stack frames:

```
2. 0000203C?crt0\<unknown>
1. 00002316 startup\_startup
0. 00002D0A main\main
```

The Code window shows the following C code:

```
100 while (true)
101 {
102     update_system();
103     num_checks++;
104     interrupt_sim(&num_checks);
105     if (graph)
106         graph_data();
107     proc_specific();
108 }
109 }
110
111 /*****
112 * FUNCTION: interrupt_sim
113 * PARMS:   counter -- loop counter passed in from main
114 * DESCRIPTION:
115 * create a simulation of a (usually) long interrupt service routine tha
116 * also has a duration profile to use with a SPA duration trigger.
```

The Journal window shows the following output:

```
> Expression C_Expression num_checks=10
Result is: 10 0x0A
```

The STATUS bar at the bottom shows: Command 68EC030 MODULE: main BREAK #: 1 TRC:Idle

To break on an access to a variable

If you started the debugger using the **Startall** script, skip this section. Access breakpoints are disabled because the analyzer has been configured to use the Trig2 trigger for other purposes.

You can also set breakpoints on a read, a write, or any access of a variable. This helps to locate defects due to multiple functions accessing the same variable. Suppose you want to break on the access of the variable *num_checks*. ("*&num_checks*" should still be in the entry buffer.)

- 1 Set the breakpoint by selecting **Breakpoints**→**Set**→**Read/Write ()**.

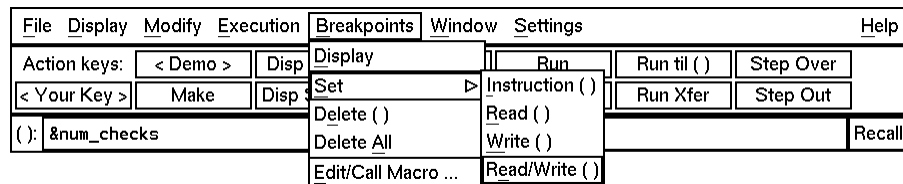

- 2 Run the program by clicking on the **Run** action key.

When the program stops, the code window shows that the program stopped at the next reference to the variable *num_checks*. Due to the latency of the emulation analyzer, the processor may halt up to two instruction cycles after the breakpoint has been detected.

Try running the program a few more times to see where it stops. (Notice that *num_checks* is passed by reference to *interrupt_sim*. Since *counter* points to the same address as *num_checks*, the debugger stops at references to *counter*.)

- 3 Delete the access breakpoint. Select **Window**→**Breakpoints**, place the mouse in the Breakpoint window, press and hold the right mouse button, and choose **Delete All Breakpoints**.

To use the command line

- 1 Select **Settings**→**Command Line** from the menu bar.

The command line area which appears at the bottom of the debugger window can be used to enter complex commands using either the mouse or the keyboard.

- 2 Build a command out of the command tokens which appear beneath the command line entry area.

To use the command line with the mouse, click on the button for each command token.

- 3 When the command has been built, type or select < Return> .

To use a C printf command

The command line's Expression Printf command prints the formatted output of the command to the Journal window using C format parameters. This command permits type conversions, scaling, and positioning of output within the Journal window.

- Using the command line, enter:

```
Expression Printf "%010d", num_checks
```

In this example, the value of *num_checks* is printed as a decimal integer with a field width of 10, padded with zeros.

Chapter 1: Getting Started with the Graphical Interface

To turn the command line off

The screenshot shows a debugger window with the following components:

- Menu Bar:** File, Display, Modify, Execution, Breakpoints, Window, Settings, Help.
- Action keys:** < Demo >, Disp Src (), C Expr (), Run, Run til (), Step Over.
- Command Line:** < Your Key >, Make, Disp Src PC, Monitor (), Step, Run Xfer, Step Out.
- Breakpoint Table:**

| # | ADDRESS | MOD/FNCT | LINE | TYPE | COMMAND | ARGUMENT |
|----|-----------|----------|------|------|---------|----------|
| 25 | | | | | | |
| 8 | [01]:temp | | 65 | | | |
- Code Window:**

```

119 void
120 interrupt_sim(counter)
121 int *counter;
122     short outer;
123     short inner;
124     short limit;
125     limit = (*counter % 10) * (*counter % 10) / 3;
126     for ( outer = 0; outer < limit; outer++ )
127         for ( inner = 0; inner < 270; inner++ )
128             inner++;
129     if ( ! ( (*counter) % 4 ) )
130         do_sort( old_data, ascii_old_data, limit % NUM_OF_OLD );
131 }

```
- Journal Window:**

```

> Expression Printf "%010d",num_checks
0000000011

```
- Status Bar:** STATUS: Command 68EC030 MODULE: main BREAK #: 1 TRC:Halted
- Debugger Menu:** Breakpt, Debugger, File, Memory, Program, Symbol, Window, Trace.
- Command Line:** C_Expression Fprintf Printf Monitor Display_Value. Command: Return Recall. Cursor: Backup Forward Clear to end Clear Help.

To turn the command line off

- 1 Move the mouse pointer to the Status line.
- 2 Hold down the shift key and click the right mouse button.

The shift-click operation selects the second item from a pop-up menu, which in this case is **Command Line On/Off**.

You can turn the command line on and off from the Settings pull-down menu, the Status pop-up menu, and the command line pop-up menu.

To trace events following a procedure call

- 1 Position the mouse pointer over the call to `update_system()` on line 102.
- 2 Select **Trace After** from the Code window pop-up menu.

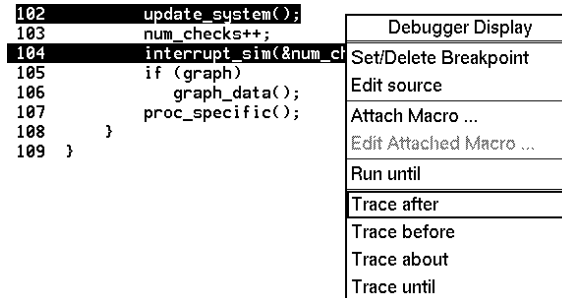

- 3 Run the program by clicking on the **Run** action key.

Notice that the debugger interface is "grayed out" and that the mouse pointer is an hourglass when the mouse is in the debugger X window. This means that the program is executing.

- 4 Wait for the status line to show `TRC: Cmp1 t`, then press `<Ctrl> -C` in the debugger window.
- 5 Select **Window→Trace** to see the bus states which occurred after the call to `update_system()`.

The trace listing will be displayed in the Trace Mode debugger window. If an emulator/analyzer X window is active, it will display the trace listing. You can scroll through the trace to see more bus states.

- 6 Press the `<ESC>` key twice to exit the trace display.

Chapter 1: Getting Started with the Graphical Interface To see on-line help

| | | | | | | | |
|---|---------|--------|-----------|-------------|--------|----------|--------|
| File | Display | Modify | Execution | Breakpoints | Window | Settings | Help |
| Action keys: < Denio > Disp Src () C Expr () Run Run til () Step Over | | | | | | | |
| < Your Key > Make Disp Src PC Monitor () Step Run Xfer Step Out | | | | | | | |
| (): main | | | | | | | Recall |

Trace Mode 24

```

In update_sys\get_targets. Line 95
Lines 96..99   if (temp_dir == up){
1018. Line 95   MAKEBAR(ARG3);
Lines 96..99   if (temp_dir == up){
Reenter update_sys\get_targets
+ Line 95     MAKEBAR(ARG3);
ESC-ESC=Quit mode F2=New Top Line F6=Track Direction(^) F7=Track
8 [01]:temp 74
```

Code 2

```

284 {
285     int i=0;           /* counter */
286     char buf[16];
287     MAKEBAR(ARG7);
288
289     /* Clear the array first */
290     for (i=0; i < NUM_OF_OLD*4; i++)
291         strcpy8(ascii_data[i], "CLEARED");
292
293     /* Generate the array to sort */
294     gen_ascii_data( data, ascii_data, size );
295
296     /* Sort the array */
297     combsort( ascii_data );
298
299     /* Print the floating point average temp also */
300     sprintf( buf, "Ave%5.2f", aver_temp );
```

Journal 1

```

> Trace Display
Trace mode entered. Press ESC-ESC to quit mode.[]
```

STATUS: TrcMode 68EC030 MODULE: main BREAK #: 0 TRC:DataOK

To see on-line help

- 1 Select **Help**→**General Topic ...**
- 2 Select **To Use Help**, then click on the **OK** button.

Spend a few minutes exploring the help topics, so that you can find them when you need them.

To end the debugging session

- Use the *command select* mouse button to choose **File→Exit→Released (all windows, release emulator)**.

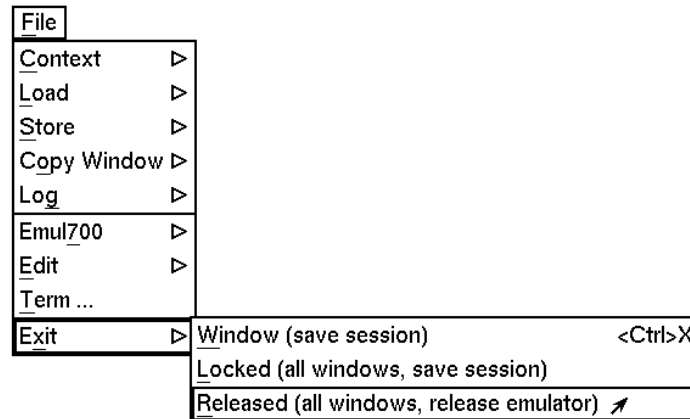

Or:

- Using the command line, enter:

```
Debugger Quit Released
```

The debug session is ended and your system prompt is displayed. The Released option unlocks the emulator so that other users on your system can use it.

This completes your introduction to the 68020/030 debugger. You have used many features of the debugger. For additional information on performing tasks with the debugger, refer to the "User's Guide" part of this manual. For more detailed information on debugger commands, error messages, etc., refer to the "Reference" part of this manual.



Getting Started with the Standard Interface

How to get started using the debugger's character-based interface.

The Standard Interface At a Glance

The debugger has a *standard interface* for several types of terminals, terminal emulators, and bitmapped displays. When using the standard interface, commands are entered from the keyboard.

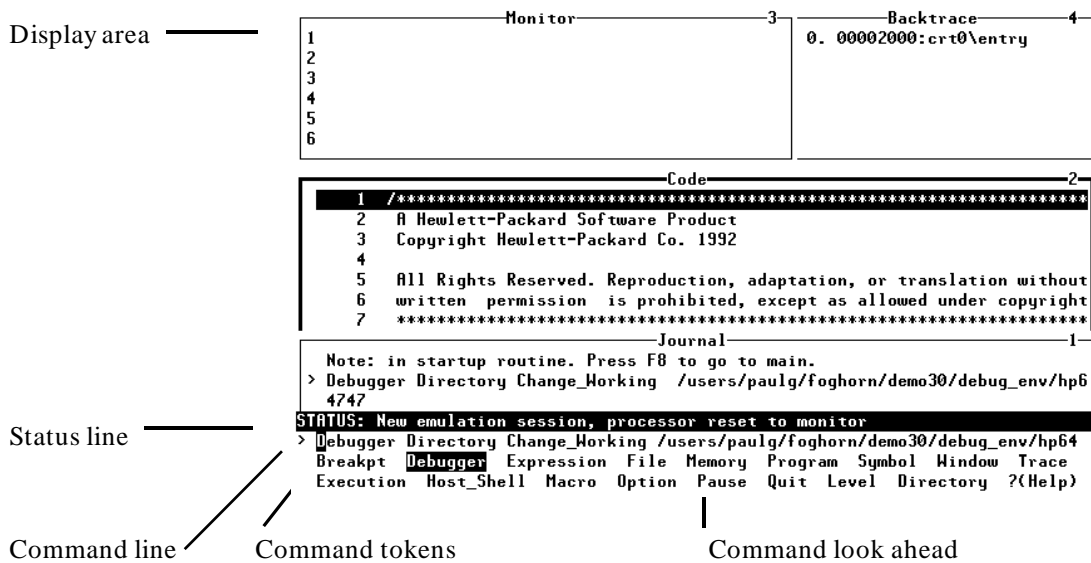

Display area. Can show assembly level screen, high-level screen, simulated I/O screen, or user-defined screens. These screens contain windows that display code, variables, the stack, registers, breakpoints, etc. You can use the UP ARROW, DOWN ARROW, PAGE UP, and PAGE DOWN cursor keys to scroll or page up or down the information in the active window.

Status line. Displays the debugger status, the CPU, the current program module, the number of the last breakpoint, and the trace status.

Command line. Commands are entered on the command line at the debugger prompt (>) and executed by pressing the <Return> key. Command tokens are placed on the command line by typing a single letter, typically the first uppercase letter of the token. The Tab and Shift-Tab keys allow you to move the cursor on the command line forward or backward. The Clear line key clears from the cursor position to the end of the line. The <Ctrl>-U key clears the whole command line.

Command tokens. The second line under the status line shows the tokens that you can enter at the current location in the command line.

Command look ahead. The third line under the status line shows tokens that are available if you select the highlighted command token above.



The Quick Start Tutorial

This tutorial gives you step-by-step instructions on how to perform basic tasks using the debugger.

Perform the tasks in the sequence given; otherwise, your results may not be the same as those shown here.

Some values displayed on your screen may vary from the values shown here. The exercises and displays in this chapter were made using a HP 64747 40 MHz 68030/EC030 emulator. If you are using an emulator with a different clock rate or the HP 64748 68020 emulator, the information displayed in some windows on your screen will be different.

Before You Begin

This chapter assumes you have already installed the debugger as described in the "Installation" chapter.

The emulator name *emul68k* is used in the examples in this chapter. If you have given your emulator a different logical name in the HP 64700 emulator device table */usr/hp64000/etc/64700tab.net*, use your emulator name or lan address in the examples. See the *HP 64700A Card Cage Installation/Service Manual* for detailed information on installing your emulator.

Note

Some commands are printed on two lines in this chapter. When entering these commands, type the entire command on one line.

The Demonstration Program

The demonstration program used in this chapter is a simple environmental control system (ECS). The system controls the temperature and humidity of a room requiring accurate environmental control. The program continuously looks at flags which tell it what action to take next.

To copy the demonstration files

Before you can run the demonstration program, you must copy the debugger demo files to a new subdirectory. Perform the following steps to make the subdirectory and copy the demo files into it.

- 1 Make a subdirectory for the debugger demo files.

Make sure the present working directory is the one in which you wish to create the subdirectory for the debugger demo files. Then, enter the command:

```
mkdir mydirectory
```

where *mydirectory* is the name of your debugger demo subdirectory.

- 2 Change to the debugger demo subdirectory:

```
cd mydirectory
```

- 3 Copy the demo files:

```
cp -r /usr/hp64000/demo/debug_env/<emulator>/* .
```

All files that you need to run the demonstration program should now be in the working directory.

To start the debugger

- Start the debugger by entering:

```
db68k -t -e emul68k -C Config  
      -c cmdfiles/debug/Cmd_dbstart ecs020
```

The **-t** option starts the debugger's standard interface.

The **-e emul68k** option tells the debugger which emulator to use.

If the logical name of your emulator is not *emul68k*, then use the name of your emulator or the emulator's lan address instead of *emul68k*.

The **-C ioconfig** option tells the debugger how to set up memory mapping for the program.

The **-c cmdfiles/debug/Cmd_dbstart** option tells the debugger to execute the *Cmd_dbstart.com* command file.

The **ecs020** argument tells the debugger to load the *ecs020.x* absolute file.

Note

Start the 68030/EC030 debugger/emulator using the command:

```
db68030 -t -e emul68k -C Config  
        -c cmdfiles/debug/Cmd_dbstart ecs030
```

This command starts execution of the debugger, which executes the command file *Cmd_dbstart.com* and loads the absolute file *ecs.x*.

To enter commands

- 1 Type the first letter of one of the command tokens listed below the command entry line.
- 2 Type the first letter of the next command token, if any.
- 3 Type any necessary parameters. They are indicated on the command token line in < angle brackets> .
- 4 Press <Return> to enter the command.

You may edit the command you are entering. See the section “To edit the command line” in the “Entering Debugger Commands” chapter for more information on how to enter and edit commands.

Note

If a portion of the previous command is still visible on the command line, press <Ctrl>-E to clear to the end of the command line before pressing <Return>.

To activate display area windows

Notice there are several windows in the main display area of the debugger. The different windows contain different types of information from the debugger. The active window has the thicker border. It is in the active window that the scroll bar and the PAGE UP and PAGE DOWN keys have an effect. There are several ways to activate a window in the display area.

- Press the F1 function key to activate the next higher numbered window or the F2 function key to activate the next lower numbered window.

Or:

Chapter 2: Getting Started with the Standard Interface

To display main()

- Using the command line, enter the Window Active command.

Try changing the active window a few times. Activate the Code window when you are done.

To display main()

- Enter the following command:

```
Program Display_Source main
```

Remember, to enter this command all you need to type is "P" then "D" then "main" then **<Return>**.

The *main()* function is displayed. Use the UP ARROW key to see the "main()" statement.

To display a subroutine

Notice that *main()* calls *update_system()*.

- Enter the following command:

```
Program Display_Source update_system
```

The *update_system()* function is displayed. Use the UP ARROW key to see the "update_system()" statement.

To set a breakpoint

Suppose you want to execute up to the call to *update_system()*. To do this you could set a breakpoint at the statement "update_system()" and run the program.

- Using the command line, enter:

```
Breakpt Instr update_system
```

The breakpoint window is displayed, showing the breakpoint has been added.

An asterisk (*) appears in the first column of the Code window next to the location of the breakpoint. The dot (.) in the first column of the previous lines show the source lines associated with that breakpoint.

To run the demo program

- Using the command line, enter:

```
Program Run
```

The journal window shows that a break occurred and which breakpoint it was.

Notice that the source file line at which the breakpoint was set is now in inverse video. The inverse video line shows the current program counter. You should now be viewing the *update_system()* routine.

To step through the program

You can execute one source line (high-level mode) or one instruction (assembly-level mode) at a time by stepping through the program.

- Using the command line, enter:

```
Program Step
```

You can step again by just pressing **<Return>**.

As the debugger steps through the program, you can see the PC progress through the source code, as shown by the inverse video line in the Code window.

To step over functions

You can either step through functions or step over functions. When you step over a function, it is executed as a single program step.

- Using the command line, enter:

```
Program Step Over
```

To delete a breakpoint

Once you set a breakpoint, program execution will break each time the breakpoint is encountered. If you don't want to break on a certain breakpoint again, you must delete the breakpoint. Suppose you want to delete the breakpoint that was previously set at the statement "update_system()".

- 1 Run the program up to the breakpoint:

Program Run

- 2 Using the command line, enter:

```
Breakpt Delete 1
```

The breakpoint window is displayed, showing the breakpoint has been deleted.

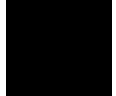

To display variables in their declared type

Whenever you specify a variable name without a C or debugger operator prefix, it is displayed in its declared type.

- Using the command line, enter:

```
Expression Display_Value current_temp
```

In the Journal window, the current value of the variable is displayed in its declared type (int).

To display the address of a variable

You can use the C address operator (&) to display the address of a program variable.

- Using the command line, enter:

```
Expression Display_Value &current_temp
```

The result is the address of the variable *current_temp*. The address is displayed in hexadecimal format.

To use a C printf command

The Expression Printf command prints the formatted output of the command to the Journal window using C format parameters. This command permits type conversions, scaling, and positioning of output within the Journal window.

- Using the command line, enter:

```
Expression Printf "%010d",current_temp
```

In this example, the value of *current_temp* is printed as a decimal integer with a field width of 10, padded with zeros.

The Expression Fprintf command can be used to print formatted output to a file or user-defined window.

To break on an access to a variable

You can also set breakpoints on a read, a write, or any access of a variable. This helps to locate defects due to multiple functions accessing the same variable. Suppose you want to break on the access of the variable *¤t_temp*.

- 1 Set the access breakpoint:

```
Breakpt Access &current_temp
```

- 2 Run the program:

```
Program Run
```

When the program stops (after approximately ten seconds), the code window shows that the program stopped at the next reference to the variable *current_temp*. Due to the latency of the emulation analyzer, the processor may halt up to two instruction cycles after the breakpoint has been detected.

Try running the program (just press **<Return>**) a few more times to see where it stops. If the program had a pointer to the variable, it would stop there, too.

- 3 Delete the access breakpoint.

Using the command line, enter:

```
Breakpt Delete 1
```



To display blocks of memory

You can display structures and arrays in memory as well as ranges of memory locations that encompass several variables.

- Using the command line, enter:

```
Memory Display Byte &current_temp
```

The debugger displays a block of memory starting at the address of the variable *current_temp*.

The C address operator **&** is used because the Memory Display command is an assembly-level command and expects a memory address as its argument.

To monitor variables

The Expression Monitor Value command allows you to monitor a variable's value during execution of your program.

- Using the command line, enter:

```
Expression Monitor Value current_temp
```

The value of *current_temp* is now displayed in the Monitor window.

To modify a variable by entering a C expression

The Expression C_Expression command calculates the value of a C expression or modifies a C variable if the C expression contains the assignment operator (=). This command recognizes variable types and the assignment expression specified behave according to the rules of C.

- Using the command line, enter:

```
Expression C_Expression current_temp = 99
```

Notice that the value of *current_temp* in the Monitor window has changed to the number you entered.

To end the debugging session

- Enter:

```
Debugger Quit Released
```

The debug session is ended and your system prompt is displayed. The emulator is released so that other people can use it.

This completes your introduction to the 68020/030 debugger. You have used many features of the debugger. For additional information on performing tasks with the debugger, refer to the "User's Guide" part of this manual. For more detailed information on debugger commands, error messages, and so on, refer to the "Reference" part of this manual.

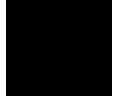

Chapter 2: Getting Started with the Standard Interface
To end the debugging session

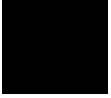

Part 2

User's Guide

Part 2

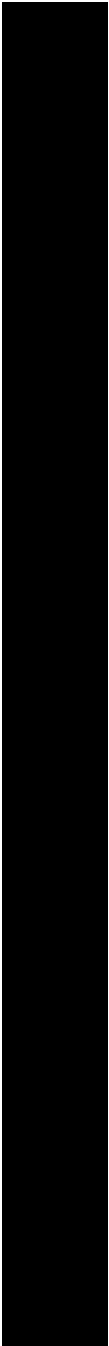

3



Entering Debugger Commands

How to enter debugger commands using the mouse or the keyboard.

Entering Debugger Commands

This chapter shows you how to enter debugger commands using the graphical interface or the standard interface. The tasks are grouped into the following sections:

- Using menus, the entry buffer, and action keys.
- Using the command line with the mouse.
- Using the command line with the keyboard.

The *graphical interface* provides an easy way to enter commands using a mouse. It lets you use pull-down and pop-up menus, point and click setting of breakpoints, cut and paste, on-line help, customizable action keys and pop-up recall buffers, and other advanced features. To use the graphical interface, your computer must be running an X Window System that supports OSF/Motif interfaces.

The debugger also has a *standard interface* for several types of terminals, terminal emulators, and bitmapped displays. When using the standard interface, commands are entered from the keyboard.

When using the graphical interface, the *command line* portion of the interface gives you the option of entering commands in the same manner as they are entered in the standard interface. If you are using the standard interface, you can only enter commands from the keyboard using the command line.

Function Key Commands

You can enter commonly used commands quickly and easily by pressing the function keys F1 through F8 on your keyboard. Function keys can be used in the graphical interface as well as the standard interface. The following table and figure describe the commands associated with the function keys.

If you are using the debugger on a Sun SPARCsystem, refer to the "Installation" chapter for information on mapping function keys.

Function Key Commands

| Function Key | Menu Equivalent, Command Line Equivalent | Description |
|--------------|---|---|
| F1 | Display → Next Window , Window Active Next | Activate the next higher numbered window. |
| F2 | Display → Previous Window , Window Active Previous | Activate the next lower numbered window. |
| F3 | Settings → High Level Debug or Settings → Assembly Level Debug , Debugger Level | Switch between assembly-level and high-level mode. |
| F4 | Right click on active window border, Window Toggle_View | Select the alternate display of the active window. |
| F5 | Help → Command Line... , Debugger ? (Help) | Access on-line help. |
| F6 | Display → Simulated I/O , Window Screen_On Next | Access the standard I/O screen. Also access any existing user-defined screens. |
| F7 | Execution → Step Instruction → from PC , Program Step | Execute one C source line (high-level mode), or execute one microprocessor instruction (assembly-level mode). |
| F8 | Execution → Step Source → from PC , Program Step Over | Execute one C source line, but treat whole functions as a single line (high-level mode); execute one microprocessor instruction, but treat whole subroutines as a single instruction. |

Command Line Control Character Functions

Press the control key **<Ctrl>** simultaneously with the **B, C, E,F, G, L, Q, R, S, U,** or **** keys to execute the operations listed in the following table. (The letter keys may be upper- or lower-case.)

Command Line Control Character Functions

| Control | Function |
|----------|--|
| <Ctrl> B | Recall command reverse. |
| <Ctrl> C | Abort the current command and return to debugger command mode. |
| <Ctrl> E | Clear to end of command line. |
| <Ctrl> F | Shift contents of active window to right. |
| <Ctrl> G | Shift contents of active window to left. |
| <Ctrl> L | Redraw screen. |
| <Ctrl> Q | Resume output to screen. |
| <Ctrl> R | Recall previous command. |
| <Ctrl> S | Suspend output to screen. |
| <Ctrl> U | Clear command line |
| <Ctrl> \ | End the debug session (same as Debugger Quit Released command) |

The Journal Window

The debugger displays debugger commands entered from the keyboard in the Journal window. The Journal window also displays warning and informational messages from the debugger and output generated by commands. This window is available in both the high-level and assembly-level screens.

Using Menus, the Entry Buffer, and Action Keys

This section describes the tasks you perform when using the debugger's graphical interface to enter commands. This section describes how to:

- Choose a pull-down menu item using the mouse.
- Choose a pull-down menu item using the keyboard.
- Use the pop-up menus.
- Use action keys.
- Use the entry buffer.
- Copy and paste to the entry buffer.
- Use dialog boxes.
- Access help information.



To choose a pull-down menu item using the mouse (method 1)

- 1 Position the mouse pointer over the name of the menu on the menu bar.
- 2 Press and hold the *command select* mouse button to display the menu.
- 3 While continuing to hold down the mouse button, move the mouse pointer to the desired menu item. If the menu item has a cascade menu (identified by an arrow on the right edge of the menu button), then continue to hold the mouse button down and move the mouse pointer toward the arrow on the right edge of the menu. The cascade menu will display. Repeat this step for the cascade menu until you find the desired menu item.
- 4 Release the mouse button to select the menu choice.

Chapter 3: Entering Debugger Commands

Using Menus, the Entry Buffer, and Action Keys

If you decide not to select a menu item, simply continue to hold the mouse button down, move the mouse pointer off of the menu, and release the mouse button.

Some menu items have an ellipsis (“...”) as part of the menu label. An ellipsis indicates that the menu item will display a dialog or message box when the menu item is chosen.

Note

The *command select* button can be either the left or right button, depending on the computer you are using. The “Getting Started with the Graphical Interface” chapter has a table which explains which button to use.

To choose a pull-down menu item using the mouse (method 2)

- 1 Position the mouse pointer over the menu name on the menu bar.
- 2 Click the *command select* mouse button to display the menu.
- 3 Move the mouse pointer to the desired menu item. If the menu item has a cascade menu (identified by an arrow on the right edge of the menu button), then repeat the previous step and then this step until you find the desired item.
- 4 Click the mouse button to select the item.

If you decide not to select a menu item, simply move the mouse pointer off of the menu and click the mouse button.

Some menu items have an ellipsis (“...”) as part of the menu label. An ellipsis indicates that the menu item will display a dialog or other box when the menu item is chosen.

To choose a pull-down menu item using the keyboard

- To initially display a pull-down menu, press and hold the *menu select* key (for example, the “Extend char” key on a HP 9000 keyboard) and then type the underlined character in the menu label on the menu bar. (For example, “F” for “File”. Type the character in lower case.)
- To move right to another pull-down menu after having initially displayed a menu, press the **right-arrow** key.
- To move left to another pull-down menu after having initially displayed a menu, press the **left-arrow** key.
- To move down one menu item within a menu, press the **down-arrow** key.
- To move up one menu item within a menu, press the **up-arrow** key.
- To choose a menu item, type the character in the menu item label that is underlined. Or, move to the menu item using the arrow keys and then press the < **RETURN** > key on the keyboard.
- To cancel a displayed menu, press the **Escape** key.

The interface supports keyboard mnemonics and the use of the arrow keys to move within or between menus. For each menu or menu item, the underlined character in the menu or menu item label is the keyboard mnemonic character. Notice the keyboard mnemonic is not always the first character of the label. If a menu item has a cascade menu attached to it, then typing the keyboard mnemonic displays the cascade menu.

Some menu items have an ellipsis (“...”) as part of the menu label. An ellipsis indicates that the menu item will display a dialog or other box when the menu item is chosen.

Dialog boxes support the use of the keyboard as well. To direct keyboard input to a dialog box, you must position the mouse pointer somewhere inside the boundaries of the dialog box. That is because the interface *keyboard focus*

Chapter 3: Entering Debugger Commands

Using Menus, the Entry Buffer, and Action Keys

policy is set to *pointer*. That just means that the window containing the mouse pointer receives the keyboard input.

In addition to keyboard mnemonics, you can also specify keyboard accelerators which are keyboard shortcuts for selected menu items. Refer to the “Setting X Resources” chapter and the “Debug.Input” scheme file for more information about setting the X resources that control defining keyboard accelerators.

To choose pop-up menu items

- 1 Move the mouse pointer to the area whose pop-up menu you wish to access. (If a pop-up menu is available, the mouse pointer changes from an arrow to a hand.)
- 2 Press and hold the right mouse button.
- 3 After the pop-up menu appears (while continuing to hold down the mouse button), move the mouse pointer to the desired menu item.
- 4 Release the mouse button to select the menu choice.

If you decide not to select a menu item, simply continue to hold the mouse button down, move the mouse pointer off of the menu, and release the mouse button.

Some pop-up menus which are available include:

- Display-area Windows.
- Status Line.
- Command Line.

To use pop-up menu shortcuts

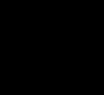
- To choose the first item in a pop-up menu, click the right mouse button.
 - To choose the second item in a pop-up menu, hold down the < **Shift** > key and click the right mouse button.
- 

To place values into the entry buffer using the keyboard

- 1 Position the mouse pointer within the text entry area. (An “I-beam” cursor will appear.)
- 2 Enter the text using the keyboard.

To clear the entry buffer text area from beginning until end, press the < **Ctrl** > **U** key combination.

To copy-and-paste to the entry buffer

- To copy and paste a "word" of text, position the mouse pointer over the word and click the left mouse button.
- To specify the exact text to copy to the entry buffer, position the mouse pointer over the first character to copy, then hold the left mouse button while dragging the mouse pointer over the text. When you release the mouse button, the highlighted text will appear in the entry buffer.

You can copy-and-paste from the display area, the status line, and from the command line entry area.

Chapter 3: Entering Debugger Commands

Using Menus, the Entry Buffer, and Action Keys

Note

If you have several graphical interface windows connected to the emulator, then a copy-and-paste action in any window causes the text to appear in all entry buffers in all windows. That is because although there are several entry buffers being displayed, there is actually only one entry buffer, which is shared by all windows. You can use this to copy a symbol or an address from one window to another window.

On a memory display or trace display, you may need to scroll the display to show more characters of a symbol.

The interface displays absolute addresses as hex values. If you copy and paste an address from the display to the entry buffer, you must add a trailing “h” to make the interface interpret it as a hex value when you use the entry buffer contents with a command.

Text pasted into the entry buffer replaces that which is currently there. You cannot use paste to append text to text already in the entry buffer. You can retrieve previous entry buffer values by using the **Recall** button.

See “To copy-and-paste from the entry buffer to the command line entry area” for information about pasting the contents of the entry buffer into the command line entry area.

Example

To paste the symbol “update_system” into the entry buffer from the interface display area, position the mouse pointer over the symbol and then click the left mouse button.

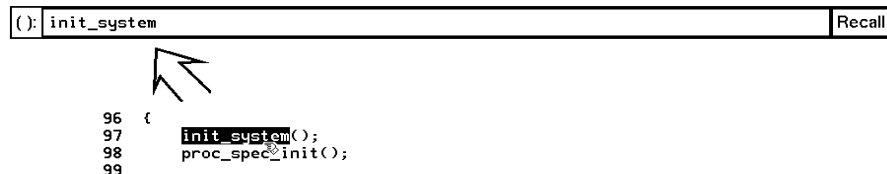

The screenshot shows a debugger interface. At the top, there is a horizontal entry buffer containing the text "(): init_system" and a "Recall" button on the right. Below the entry buffer, a code window displays the following code:

```
96 {
97   init_system();
98   proc_spec_init();
99 }
```

A mouse cursor is positioned over the text "init_system()" in the code window.

To recall entry buffer values

- 1 Position the mouse pointer over the **Recall** button just to the right of the entry buffer text area, and click the mouse button to bring up the Entry Buffer Value Selection dialog box.
- 2 In the dialog box, click on the string you want.
- 3 In the dialog box, click on the "OK" button.

The Entry Buffer Value Selection dialog box contains a list of previous values from the entry buffer. You can also predefine entries for the Entry Buffer Value Selection dialog box and define the maximum number of entries by setting X resources (refer to the “Setting X Resources” chapter).

If you decide not to change the contents of the entry buffer, click on the "Cancel" button in the dialog box.

If you want the Entry Buffer Value Selection dialog box to remain visible after you make a selection, press "Apply" instead of "OK". You may drag the dialog box to another location on your display so that it does not cover the debugger window.

See the following “To use dialog boxes” section for information about using dialog boxes.



To edit the entry buffer

- To position the keyboard cursor, click the left mouse button or use the arrow keys.
- To clear the entry buffer, type < **Ctrl**> -U.
- To delete characters, press the < **Backspace**> or < **Delete char**> keys.
- To delete several characters, highlight the characters to be deleted using the left mouse button, then press the < **Backspace**> or < **Delete char**> keys.

To use the entry buffer

- 1 Place information into the entry buffer (see the previous “To place values into the entry buffer using the keyboard”, “To copy-and-paste to the entry buffer”, or “To recall entry buffer values” task descriptions).
- 2 Choose the menu item, or click the action key, that uses the contents of the entry buffer.

The contents of the entry buffer will be used wherever the "()" symbol appears in a menu item or action key.

To copy-and-paste from the entry buffer to the command line entry area

- 1 Position the mouse pointer within the command line text entry area.

Chapter 3: Entering Debugger Commands Using Menus, the Entry Buffer, and Action Keys

- 2 If necessary, reposition the keyboard cursor to the location where you want to paste the text.
- 3 If necessary, choose the insert or replace mode for the command entry area.
- 4 Click the middle mouse button to paste the text into the command line entry area at the current cursor position.

Note

You should paste to the command line *only* when the command line is expecting an address or a string. The characters from the entry buffer will be treated as if they were typed from the keyboard. If the command line is expecting keyword tokens, pasting can have unexpected results. For example, pasting "delta" into an empty command line will generate a "Debugger Execution Load_State ta" command!

Although a paste from the display area to the entry buffer affects all displayed entry buffers in all open windows, a paste from the entry buffer to the command line only affects the command line of the window in which you are currently working.

See "To copy-and-paste to the entry buffer" for information about pasting information from the display into the entry buffer.

To use the action keys

- 1 If the action key uses the contents of the entry buffer, place the desired information in the entry buffer.
- 2 Position the mouse pointer over the action key and click the action key.

Action keys are user-definable pushbuttons that perform interface or system functions. Action keys can use information from the entry buffer — this makes it possible to create action keys that are more general and flexible.

Several action keys are predefined when you first start the debugger's graphical interface. You can use the predefined action keys to make, load,

Chapter 3: Entering Debugger Commands

Using Menus, the Entry Buffer, and Action Keys

run, and step through the demo program. You'll really appreciate action keys when you define and use your own.

Action keys are defined by setting an X resource. Refer to the chapter "Setting X Resources" for more information about creating action keys.

To use dialog boxes

- 1 Click on an item in the dialog box list to copy the item to the text entry area.
- 2 Edit the item in the text entry area (if desired).
- 3 Click on the "OK" pushbutton to make the selection and close the dialog box, click on the "Apply" pushbutton to make the selection and leave the dialog box open, or click on the "Cancel" pushbutton to cancel the selection and close the dialog box.

The graphical interface uses a number of dialog boxes for selection and recall:

| | |
|---------------------|--|
| Directory Selection | Selects the working directory. You can change to a previously accessed directory, a predefined directory, or specify a new directory. |
| File Selection | From the working directory, you can select an existing file name or specify a new file name. |
| Entry Buffer Recall | You can recall a previously used entry buffer text string, a predefined entry buffer text string, or a newly entered entry buffer string, to the entry buffer text area. |
| Command Recall | You can recall a previously executed command, a predefined command, or a newly entered command, to the command line. |

The dialog boxes share some common properties:

- Most dialog boxes can be left on the screen between uses.

Chapter 3: Entering Debugger Commands Using Menus, the Entry Buffer, and Action Keys

- Dialog boxes can be moved around the screen and do not have to be positioned over the graphical interface window.
- If you iconify the interface window, all dialog boxes are iconified along with the main window.

Except for the File Selection dialog box, predefined entries for each dialog box (and the maximum number of entries) are set via X resources (refer to the “Setting X Resources” chapter).

In file names, you may use a tilde as shorthand for your home directory.



Chapter 3: Entering Debugger Commands
Using Menus, the Entry Buffer, and Action Keys

Examples To use the File Selection dialog box:



The file filter selects specific files.

A list of filter-matching files from the current directory.

A list of files previously accessed during the emulation session.

A single click on a file name from either list highlights the file name and copies it to the text area. A double click chooses the file and closes the dialog box.

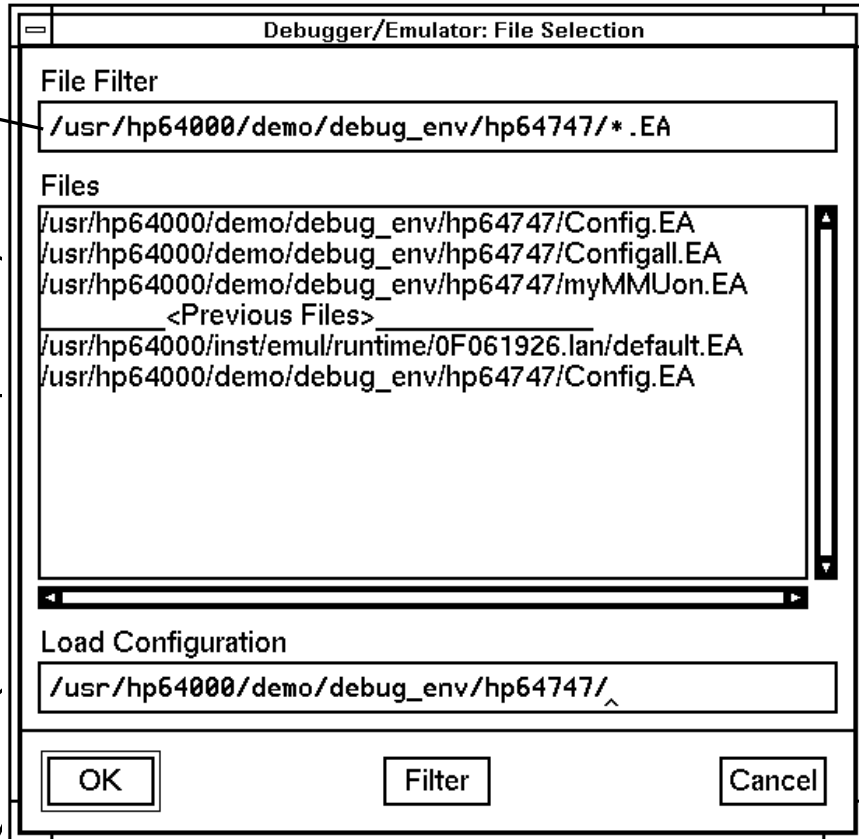

Label informs you what kind of file selection you are performing.

Text entry area. Text is either copied here from the recall list, or entered directly.

Clicking this button chooses the file name displayed in the text entry area and closes the dialog box.

Entering a new file filter and clicking this button causes a list of files matching the new filter to be read from the directory.

Clicking this button cancels the file selection operation and closes the dialog box.

To use the Directory Selection dialog box:

Label informs you of the type of list displayed.

A single click on a directory name from the list highlights the name and copies it to the text area. A double click chooses the directory and closes the dialog box.

A list of predefined or previously accessed directories.

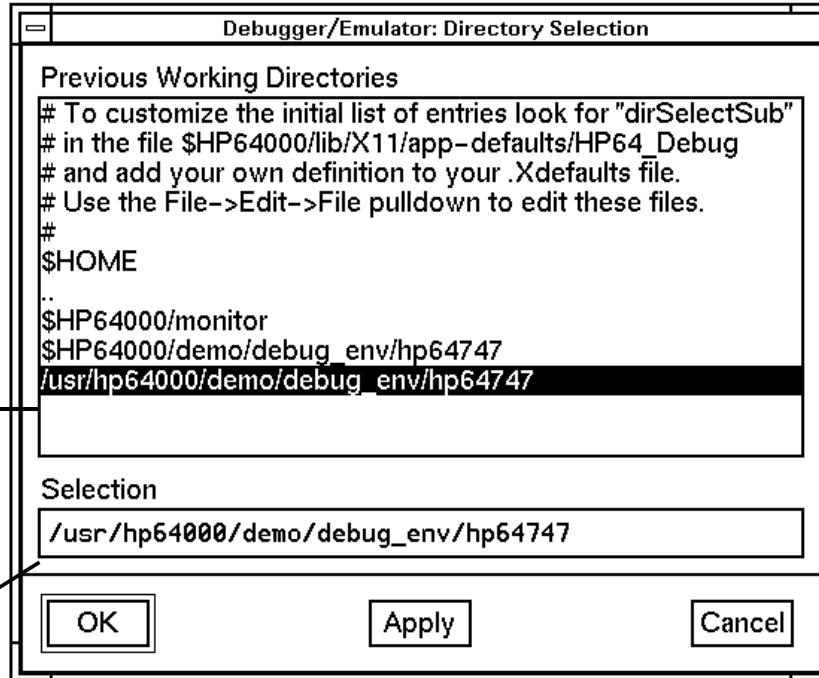

Text entry area. Directory name is either copied here from the recall list, or entered directly.

Clicking this button chooses the directory displayed in the text entry area and closes the dialog box.

Clicking this button chooses the directory displayed in the text entry area, but keeps the dialog box on the screen instead of closing it.

Clicking this button cancels the directory selection operation and closes the dialog box.

To access help information

- 1 Display the Help Index by choosing **Help**→**General Topic ...** or **Help**→**Command Line ...**
- 2 Choose a topic of interest from the Help Index.

The Help Index lists topics covering operation of the interface as well other information about the interface. When you choose a topic from the Help Index, the interface displays a window containing the help information. You may leave the window on the screen while you continue using the interface.

Examples

To see more information on how to use the on-line help, click on **Help**, then click on **General Topics ...**, then click on "To Use Help", then click on the "OK" button.

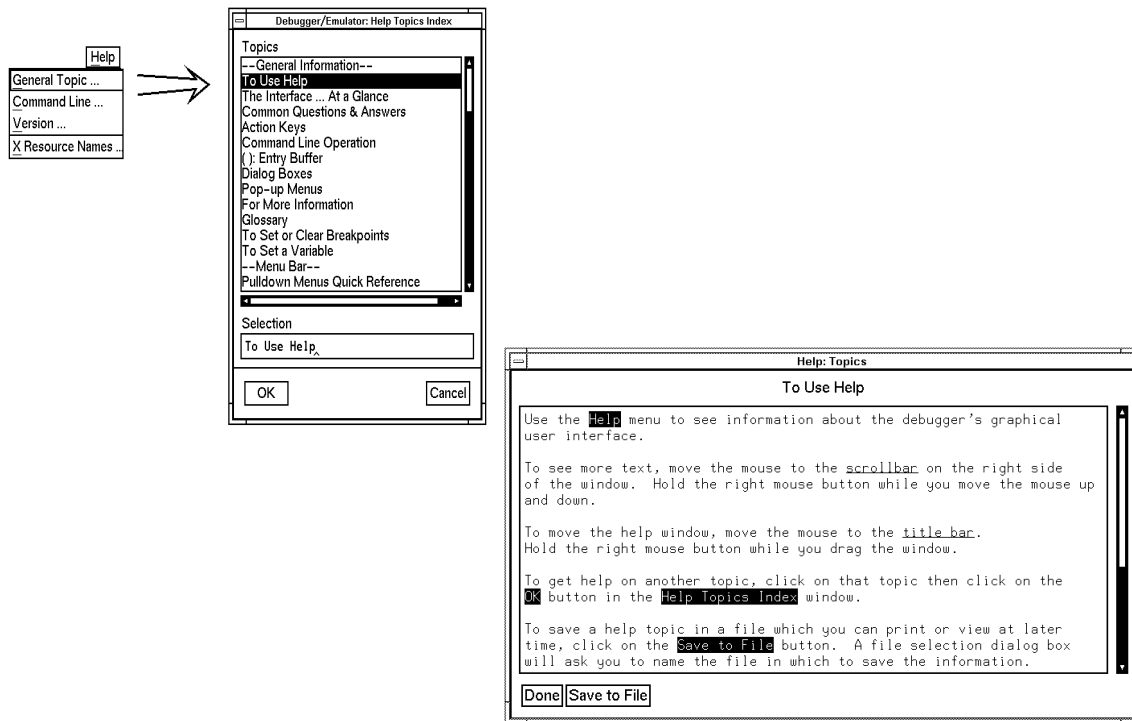

Using the Command Line with the Mouse

When using the graphical interface, the *command line* portion of the interface gives you the option of entering commands in the same manner as they are entered in the standard interface. Additionally, the graphical interface makes the command tokens pushbuttons so commands may be entered using the mouse.

If you are using the standard interface, the command line is the only way to enter commands.

This section describes how to:

- Turn the command line off/on.
- Enter commands.
- Edit commands.
- Recall commands.
- Display the help window.



To turn the command line on or off

- To turn the command line on or off using the pull-down menu, choose **Settings**→**Command Line**.
- To turn the command line on or off using the status line pop-up menu: position the mouse pointer within the status line area, press and hold the right mouse button, and choose **Command Line On/Off** from the menu.
- To turn the command line on or off with a single mouse click, hold the **< Shift >** key and click on the status line.
- To turn the command line off using the command line entry area pop-up menu: position the mouse pointer within the entry area, press and hold the right mouse button, and choose **Command Line On/Off** from the menu.
- To turn the command line on with the keyboard: place the mouse pointer in the display area and press any alphanumeric key.

"On" means that the command line is displayed and you can use the command token pushbuttons, the command return and recall pushbuttons, and the cursor pushbuttons for command line editing. "Off" means the command line is not displayed and you can use only the pull-down and pop-up menus and the action keys to control the interface.

The command line area begins just below the status line and continues to the bottom of the debugger window. The status line is not part of the command line and continues to be displayed whether the command line is on or off.

Choosing certain pull-down menu items while the command line is off causes the command line to be turned on. That is because the menu item chosen requires some input at the command line that cannot be supplied another way.

To enter a command

- 1 Build a command using the command token pushbuttons by successively positioning the mouse pointer on a pushbutton and clicking the left mouse button until a complete command is formed.
- 2 Execute the completed command by clicking the **Return** pushbutton (found near the bottom of the command line in the “Command” group).

Or:

Execute the completed command using the Command Line entry area pop-up menu: Position the mouse pointer in the command line entry area; press and hold the right mouse button until the Command Line pop-up menu appears; then, choose the **Execute Command** menu item.

You may need to combine pushbutton and keyboard entry to form a complete command.

A complete command is a string of partial commands or command tokens. You know a command is complete when “< return> ” appears on one of the command token pushbuttons. The interface does not check or act on a command, however, until the command is executed. (In contrast, commands resulting from menu choices and action keys are supplied with the needed carriage return as part of the command.)



To edit the command line using the command line pushbuttons

- To clear the command line, click the **Clear** pushbutton.
- To clear the command line from the cursor position to the end of the line, click the **Clear to end** pushbutton.
- To move to the right one command word or token, click the **Forward** pushbutton.
- To move to the left one command word or token, click the **Backup** pushbutton.
- To insert characters at the cursor position, press the **Insert char** key to change to insertion mode, and then type the characters to be inserted.
- To delete characters to the left of the cursor position, press the < **Backspace**> key.

When the cursor arrives at the beginning of a command word or token, the softkey labels change to display the possible choices at that level of the command.

When moving by words left or right, the **Forward** pushbutton becomes half-toned and unresponsive when the cursor reaches the end of the command string. Similarly, the **Backup** pushbutton becomes half-toned and unresponsive when the cursor reaches the beginning of the command.

See “To edit the command line using the mouse and the command line pop-up menu” and “To edit the command line using the keyboard” for information about additional editing operations you can perform.

To edit the command line using the command line pop-up menu

- To clear the command line: position the mouse pointer within the Command Line entry area; press and hold the right mouse button until the Command Line pop-up menu appears; choose **Clear Entire Line** from the menu.
- To clear the command line from the cursor position to the end of the line: position the mouse pointer at the place where you want the clear-to-end to start; press and hold the right mouse button until the Command Line pop-up menu appears; choose **Clear to End of Line** from the menu.
- To position the cursor at the next token or the previous token: press and hold the right mouse button until the Command Line pop-up menu appears; choose **Forward Tab** or **Backward Tab** from the menu.

When the cursor arrives at the beginning of a command word or token, the softkey labels change to display the possible choices at that level of the command.

See “To edit the command line using the mouse and the command line pushbuttons” and “To edit the command line using the keyboard” for information about additional editing operations you can perform.

To recall commands

- 1 Click the pushbutton labeled **Recall** in the Command Line to display the dialog box.
- 2 Choose a command from the buffer list. (You can also enter a command directly into the text entry area of the dialog box.)

Because all command entry methods in the interface — menus, action keys, and command line entries — are echoed to the command line entry area, the

Chapter 3: Entering Debugger Commands

Using the Command Line with the Mouse

contents of the Command Recall dialog box is not restricted to commands entered directly into the command line entry area.

The Command Recall dialog box contains a list of interface commands executed during the debugger session as well as any predefined commands present at interface startup.

You can predefine entries for the Command Recall dialog box and define the maximum number of entries by setting X resources (refer to the “Setting X Resources” chapter).

See “To use dialog boxes” for information about using dialog boxes.

To get help about the command line

- To display the help topic explaining the operation of the command line, select **Help**→**General Topic ...**→**Command Line Operation**.
- To display the command line help menu, select **Help**→**Command Line ...**

Using the Command Line with the Keyboard

Commands are entered on the command line at the debugger prompt (>) and executed by pressing the < **Return**> key. Command tokens are entered by typing a single letter, typically the first uppercase letter of the token.

The third and fourth lines of the status window display command tokens. The third line shows the tokens that you can enter at the current location in the command line. The fourth line shows tokens that are available if you select the highlighted command token on the third line. The command token lines provide you with a look ahead feature, showing you the debugger commands available to you at any time.

This section describes how to:

- Enter commands.
- Edit commands.
- Recall commands.
- Access on-line help information.

To enter debugger commands from the keyboard

- 1 Build a command using direct keyboard entry by successively typing letters corresponding to command tokens until a complete command is formed.
- 2 Execute a completed command using the keyboard, press the < **Return**> key on the keyboard.

You can enter commands any time the cursor is displayed on the command line. You can enter only one debugger command at a time.

Debugger commands have the following syntax:

```
command [qualifier...] [parameter...]
```

Chapter 3: Entering Debugger Commands

Using the Command Line with the Keyboard

To enter a command keyword, type the first letter of the keyword. For example, to enter the command *Debugger Level Assembly*, type the letters **D**, **L**, and **A**. The following command will appear on the command line:

```
Debugger Level Assembly
```

Press < **Return**> to enter (execute) the command.

In command examples, the letter you must type is highlighted in bold type.

Note

In cases where you can select from more than one keyword beginning with the same letter, type the first uppercase letter of the desired keyword. For example, type **O** to select **On** and **F** to select **oFF**.

Enter qualifier keywords in the same way as command keywords. Qualifiers provide the debugger with information on how to execute the command. Qualifiers are normally single words that immediately follow the command name. For example, in the command:

```
Program Find_Source Next Backward
```

the qualifier *Backward* causes the debugger to search the file from the current position in the file towards the beginning of the file for a specified string.

Type parameters in their entirety from the keyboard. Parameters must be separated from the command or qualifier keyword by at least one space. Parameters describe the object of the command and are typically C expressions that represent values or addresses used by the command. For example, in the command:

```
Expression Display_Value &system_is_running
```

the parameter *&system_is_running* specifies the address of the variable *system_is_running*.

To edit the command line

- To clear the command line, press < **Ctrl**> **U**.
- To clear the command line from the cursor position to the end of the line, press < **Ctrl**> **E**.
- To move to the right one command word, press < **Tab**> .
- To move left or right character-by-character, press the ← and → keys.
- To delete characters to the left of the cursor position, press the < **BACKSPACE**> key.

When the cursor arrives at the beginning of a command word or token, the softkey labels change to display the possible choices at that level of the command.

To recall commands using the command line recall feature

- To recall commands from the command line, press the < **Ctrl**> **R** key combination. Continue to press < **Ctrl**> **R** to move from the most recently executed commands backward to earlier commands.
- To move forward in the recall list, press < **Ctrl**> **B**.

The command line recall feature is available to you, but it is not as easy to use or as flexible as the Command Recall dialog box in the graphical interface. You must search through commands in a linear fashion instead of going directly to the command you want in the dialog box. The depth of the recall list is predefined and cannot be controlled by you. The recall list may contain duplicate entries that you must scroll past and that take up room in the recall

list. Finally, you cannot predefine entries for the recall list — the list only contains the most recent commands executed during the emulation session.

To display the help window

- Press the function key **F5**.

Or:

- Enter the command

`Debugger ?`

This command displays a menu of debugger commands, command parameters, function keys, and other debugger features. Descriptions for each topic may be obtained by positioning the cursor on the first letter of any topic in the help menu and pressing the **< Return >** key.

The debugger's help window is context sensitive. When you display the help window, the cursor is located on the last command you entered before displaying the help window. The debugger assumes you need help with this command. Press **< Return >** to display information about the command.

Pressing **< Return >** or **< Down >** displays information on the next item in the help menu. Pressing **< Up >** displays information about the previous item in the help menu.

You can move the cursor to the first command of a command type (Breakpoint, Debugger, etc.) by entering the first letter of the command type. For example, to move to cursor to the entry for the first window command, enter:

W

Chapter 3: Entering Debugger Commands Using the Command Line with the Keyboard

The cursor will be positioned at the Window Active command entry. Then you can use the cursor keys to select the window command you need help with and press < **Return**> to display information on that command.

Press the **F5** function key one time or press the escape (< **Esc**>) key twice to exit the help window. (Note that you cannot exit the graphical interface help window this way.)



Viewing Debugger Status

The status line shows you what the debugger is doing. The status line:

- Contains information about the operation being performed by the debugger.
- Contains indicators to warn you about special conditions.
- Shows the microprocessor being emulated.
- Shows the program module associated with the current program counter.
- Shows the number of the last breakpoint that occurred.
- Shows the trace measurement status.

The status line is always present in both the graphical interface and the standard interface.

The debugger displays the status line in the following format:

```
STATUS:<Status> [J][L][W] CPU MODULE: <module> BREAK #: <#> TRC:<Trc_status>
[R]
```

Debugger Status

The Status entry (< Status>) on the status line shows what type of operation the debugger is doing. The possible types of debugger operations are:

| | |
|---------|--|
| Command | The debugger is accepting a debugger command. |
| Define | The debugger is accepting a macro definition. |
| Execute | The debugger is executing target environment instructions. The debugger displays <i>Execute</i> on the status line when you enter the Program Run command or the Program Step command. |
| Include | The debugger is reading commands from a command file. |
| InMon | The debugger is executing in the monitor. |
| Input | The debugger is reading data from an input port. |

| | |
|---------|---|
| Macro | The debugger is executing a macro. |
| Output | The debugger is writing data to an output port. |
| Paused | The debugger is in the paused state after execution of the Debugger Pause command. |
| Reading | The debugger is reading an executable file or a C source file into the debugger's memory. |
| Working | The debugger is executing internal debugger operations. |

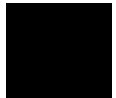

Indicator Characters

The Warning indicator (W) indicates that the program counter is not on a C source line boundary. The debugger displays a warning when it detects a breakpoint, an instruction halt, or an instruction error between lines.

The Log indicator (L) indicates that commands are being logged to a log file.

The Journal indicator (J) indicates that everything appearing in the Journal window is being written to a journal file.

The Register indicator (R) indicates that a register variable is being used, but its lifetime is not known by the debugger. The debugger displays an R when the variable is referenced, indicating that the values being used for this variable may not be valid.

CPU Emulated

The CPU entry indicates which microprocessor is being emulated.

If you are using a 68030 emulator, the status line will show "68EC030" if the MMU is not enabled, and "68030" if the MMU is enabled.

Current Module

The MODULE: entry names the current module (< module>). The current module is the module pointed to by the program counter. If the program counter points outside of the known code area associated with the program, this entry displays ???????.

Last Breakpoint

The `BREAK #` entry indicates the number of the last breakpoint that occurred, or (0) zero if execution was not terminated with a breakpoint.

Trace Status

The `TRC:< Trc_status>` entry indicates the status of the trace measurement function. The possible values for `<Trc_status>` are:

| | |
|---------------------|--|
| <code>AwtTrg</code> | A trace measurement is in progress, but the trigger condition has not been detected. |
| <code>BrkRWA</code> | An access breakpoint has been set and will be used as the trigger in the next trace measurement. |
| <code>Cmplt</code> | A trace measurement has completed. |
| <code>DataOK</code> | The trace buffer contains valid data. |
| <code>Halted</code> | The <code>Trace Halt</code> command was used to halt the trace. |
| <code>Idle</code> | No trace measurement has been executed during the current debug session. |
| <code>Setup</code> | A trace measurement has been set up (specified), and will start on the next program run or program step command. This status message appears only before the first trace measurement in a debug session. |
| <code>Trgrd</code> | A trace measurement is in progress, and the trigger has been detected. |

If pop-up menus don't pop up

When you hold the right mouse button down, a pop-up menu does not appear. Here are some things to check:

- Check that the mouse pointer is hand-shaped.

Some areas of the screen do not have pop-up menus.

- Check that your mouse buttons are not being redefined by your window manager.

If you are using **mwm** to redefine your mouse buttons, delete the redefinition from your `.mwmrc` file.

- If you are using an older window manager such as **mwm**, look in

```
/usr/hp64000/lib/X11/HP64_schemes/HP-UX/Debug.Input
```

Copy the line

```
HP64_Debug*whichButton: Button5
```

to your `.Xdefaults` file. Change the 5 to a 3.



Chapter 3: Entering Debugger Commands
Viewing Debugger Status



4

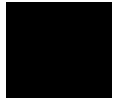

Loading and Executing Programs

How to load a program into the debugger and control its execution.

Compiling Programs for the Debugger

Using a Hewlett-Packard C Cross Compiler

Use the default compile mode when compiling your target programs for use with the debugger. The default settings generate executable files (.x file extension) in the HP-MRI IEEE-695 file format required by the debugger. The default option settings force a stack frame to be built for every function call, which is required for stack backtracing.

The "Getting Started" chapter of the *68020 C Cross Compiler User's Guide* or the *68030 C Cross Compiler User's Guide* gives an example of how to compile a simple program and execute it in the HP 64747A/748A environment.

Note

Do not use the `-h` option when compiling and linking your program for the debugger. The `-h` option causes the compiler to generate HP 64000 file formats. Use the default settings which generate executable files in the HP-MRI IEEE-695 file format required by the debugger. The debugger extracts all symbolic information from the executable (.x) file.

Using Environment Dependent Files

The HP 64903/B1461 and HP 64907/B1478 C Cross Compilers provide environment dependent files that support the HP 64747A/748A emulation environment. The debugger has the same simulated I/O capabilities as the HP 64000 Series emulators. The same environment dependent files are used for both the debugger and emulator environments. These environment dependent routines affect the following areas of C programming:

- program setup
- dynamic memory allocation
- program input and output

The "Environment Dependent Routines" chapter of the *68020 C Cross Compiler Reference* or the *68030 C Cross Compiler Reference* describes the environment dependent routines supplied with the compiler.

Using Optimizing Modes

If you use the optimizing modes (`-O` or `-OT`), function calls that do not have automatic variables will not have stack frames. As a result, the stack backtrace window will not contain entries for such functions. Additionally, the optimizing modes will cause the compiler to generate code which is not easily debugged.

Note

When initially compiling a program for the debugger, you should turn off all optimizations to avoid confusion when using the debugger. After program flow and all basic algorithms have been debugged, you can recompile the program with all optimizations turned on.

When you compile with all optimizations on, one or more of the following problems may occur while using the debugger:

- Target program execution in the debugger may not appear to correctly reflect the logical flow of the program.
- The debugger may not stop execution at a high-level breakpoint or may stop execution at the wrong location in the program.
- The debugger may not be able to display local variables.

Forcing Variables to be Placed in Memory

The default compiler settings automatically create register variables for statics and frequently used variables. Some debugger functions such as breakpoints will not work with register variables. The compiler option `-Wc`, `-F` turns off the compiler's automatic creation of register variables, forcing the compiler to assign these variables to memory. This enables greater functionality of some debugger commands. After debugging your code, you can then recompile your code without these options for greater efficiency.

Using Math Libraries

Although FPU instructions can be executed in the target system, the debugger/simulator cannot execute these instructions. To generate code that will run interchangeably in both the debugger/emulator and debugger/simulator, use the C compiler's floating point library routines.

Chapter 4: Loading and Executing Programs

Compiling Programs for the Debugger

These libraries contain routines that do not use FPU instructions, thereby allowing them to execute properly in both debugging environments.

References

The “Getting Started” chapter of the *68020 C Cross Compiler User’s Guide* gives an example of how to compile a simple program and execute it in the debugger environment.

The “Command Syntax” chapter of the *68020 C Cross Compiler User’s Guide* gives detailed descriptions of compiler options.

The “Environment Dependent Routines” chapter of the *68020 C Cross Compiler Reference* describes the environment dependent routines supplied with the compiler.

Using Microtec Language Tools

The debugger is designed to work with the HP Advanced Cross Language System. However, you can also use the Microtec Research, Inc. language tools with the debugger.

Microtec’s language tools are quite similar to the HP language tools. The input syntax and code generated by the HP and Microtec assemblers, linkers, and librarians are identical with few exceptions.

The language tools available from Microtec[®] are the **mcc68k** C compiler, the **ccc68k** C++ compiler, the **asm68k** assembler, the **lnk68k** linker, and the **lib68k** librarian.

Using the Microtec Commands

For instructions on how to compile and assemble programs using the Microtec language tools, refer to the *Application Note for Hewlett-Packard 68xxx Product Interfaces and Microtec Research Inc. 68xxx Language Tools*. This application note is available from your Hewlett-Packard sales representative.

Assembler Defaults

You should be aware of these differences between **asm68k** and **as68k**:

Command-line syntax. The differences are minor. See the on-line man pages for a description of the command-line options.

Chapter 4: Loading and Executing Programs

Compiling Programs for the Debugger

Case sensitivity. as68k is case sensitive by default, asm68k is not. Use the command line flag "-fcase" to make asm68k case sensitive.

Symbols in HP-MRI IEEE-695 files. The HP assembler places local symbols in the output object file by default, asm68k does not. Use the command line flag "-fd" with asm68k to generate local symbols.

The HP assembler places global symbols in the debug part by default. There is no way to do this with Microtec's asm68k. This information is needed by emul700/SRU to correctly scope symbols. Thus you will find that some symbols may be incorrectly scoped when using the emulator with the Microtec assembler.

Linker Defaults

You should be aware of these differences between lnk68k and ld68k:

Output file format. ld68k produces HP-MRI IEEE-695 by default. lnk68k products Motorola S-Records by default. To generate an HP-MRI IEEE-695 (.x) format absolute file, use the **-H** command line option or **-fi** flag.

Local symbols. ld68k provides local symbols in absolute file by default, but lnk68k does not. The command line flag **-fi** and option **-H** also set the **d** flag which will cause lnk68k to generate local symbols.

Support files. ld68k and lnk68k have different default locations and environment variables used to locate linker command files and libraries.

Librarian Defaults

ar68k uses **.a** as the default library suffix. lib68k uses **.lib** as the default library suffix.

The Microtec MCC68K Compiler

mcc68k is very different from the HP compilers. Study the Microtec documentation if you need specific information about mcc68k.

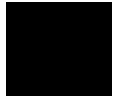

Loading Programs and Symbols

This section shows you how to:

- Specify the location of C source files.
- Load programs.
- Load programs only (without symbols).
- Load symbols only (without the program).
- Append programs.
- Specify demand loading of symbols.

To specify the location of C source files

- Before you start the debugger, set the `HP64_DEBUG_PATH` environment variable.

The location of C source files can be defined to the debugger with the UNIX shell variable `HP64_DEBUG_PATH`. If `HP64_DEBUG_PATH` is defined, the debugger only searches for the files in the path(s) specified in `HP64_DEBUG_PATH`, in the order in which they are listed.

The `%` character can be included in the path to cause the debugger to search the location of the source files recorded in the absolute file.

If `HP64_DEBUG_PATH` is not defined, the debugger searches for source files in the following sequence:

- 1 their location at compile time (this information is recorded in the absolute file)
- 2 the current directory (if the required source files are not found in their compile location)

Example

The shell variable definition:

```
HP64_DEBUG_PATH=/users/proj/src:/users/proj/mysrc:%  
export HP64_DEBUG_PATH
```

causes the debugger to search paths for C source files in the following order:

- 3 /users/proj/src
- 4 /users/proj/mysrc
- 5 the paths specified in the absolute file at compile time

If you use the csh shell (most Sun systems), use **setenv** instead of **export** to set the variable.

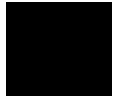

To load programs

- When starting the debugger, enter the executable file name as the last term in the db68k command line.

```
$ db68k -e emul68k <abs_file>
```

Or:

- Select **File**→**Load**→**Executable**, then use the File Selection dialog box to select the executable file.

Or:

- Using the command line, enter:

```
Program Load Default <file_name>
```

When you load an absolute file, the debugger:

- 1 Removes all previous program symbols.
- 2 Removes all previously set breakpoints.
- 3 Resets the program counter (PC).
- 4 Loads the full symbol set.

Chapter 4: Loading and Executing Programs

Loading Programs and Symbols

5 Loads the new executable module.

Absolute files contain executable object code. They must have a file name extension of `.x`. You do not need to specify the `.x` file extension when entering the absolute file name.

Examples

To load the executable file `ecs.x`:

```
$ db68k -e emul68k ecs
```

Or:

```
Program Load Default ecs
```

To load programs only

- Select **File**→**Load**→**Program Only ...**, then use the File Selection dialog box to select the absolute file.

Or:

- Using the command line, enter:

```
Program Load New Code_only No_Pc_Set <absolute_name>
```

Enter the name of the absolute file whose code is to be loaded, and press the **< Return >** key.

The code will be loaded without loading symbols or resetting the PC.

If you are re-loading a program, you may need to restore some debugger settings; for example, you might need to re-specify variables for the Monitor window.

To load symbols only

- Use the -I option to the db68k command when starting the debugger.

```
$ db68k -e emul68k -I <absolute_file> <RETURN>
```

Or:

- Select **File→Load→Symbols Only ...**, then use the File Selection dialog box to select the absolute file.

Or:

- Using the command line, enter:

```
Program Load New Symbols_only No_Pc_Set <absolute_file>
```

Enter the name of the absolute file whose symbols are to be loaded, and press the < **Return** > key.

Only symbolic information is loaded from the absolute file.

To append programs

- Using the command line, enter:

```
Program Load Append
```

Select either All, Code_Only, or Symbols_Only. Then, select either Pc_Set or No_Pc_Set. Finally, enter the name of the absolute file to be appended, and press the < **Return** > key.

All both code and symbols are loaded.

Chapter 4: Loading and Executing Programs

Loading Programs and Symbols

| | |
|--------------|---|
| Code_Only | only code from the absolute file is loaded. |
| Symbols_Only | only symbols from the absolute file are loaded. |
| Pc_Set | the program counter (PC) is set to the transfer address found in the absolute file. |
| No_Pc_Set | the program counter (PC) is not changed. |

When you append a program, it is loaded without deleting the existing program.

Examples

To append the program “module2.x” to the current program without setting the program counter:

```
Program Load Append All No_Pc_Set module2
```

To specify demand loading of symbols

- Use the -d option when starting the debugger.

The -d option turns on demand loading of symbols, loading some symbol information on an as-needed, demand basis rather than during the initial load of the .x file.

Symbol information for global symbols, local symbols in the source module containing main, and local symbols in assembly modules are loaded during the initial load of the .x file. Local symbols in C source modules other than that module which contains main are loaded either when the user explicitly references the module or when the program is stopped with the program counter in the module. The primary advantage of demand load is that it lets you load and debug programs that otherwise would not be loaded because of very large amounts of symbol information.

There are several side effects of demand loading. The debugger command Memory Unload_BBA is disabled. Type mismatch errors may not be detected during the initial load of the .x file. Global symbols may have leading

Chapter 4: Loading and Executing Programs

Loading Programs and Symbols

underscores stripped depending on whether they were defined/referenced in a C or assembly source module.

Examples

To specify demand loading of symbols when starting the debugger:

```
$ db68k -e emul68k -d <RETURN>
```

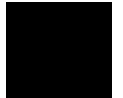

Stepping Through and Running Programs

The various Program Run command options can be combined to make complex run-time control commands for your program.

This section shows you how to:

- Step through programs.
- Step over functions.
- Run from the current PC address.
- Run from a start address.
- Run until a stop address.

To step through programs

- Click on the **Step** action key.

Or:

- Select **Execution**→~~Step~~→**from PC**.

Or:

- Using the command line, enter:

```
Program Step
```

And press the < **Return**> key.

Your program executes one C source line (high-level mode) or one machine instruction (assembly-level mode) at a time from the address contained in the program counter (PC). When the program calls a function, stepping continues in the called function.

You can specify a starting address with the Program Step command. You can also specify a step count to cause the debugger to step multiple lines or instructions in your program.

Note

If the debugger steps into an HP library routine, run until the stack level above the level of the library routine. Use the Program Run Until command or the Backtrace window pop-up menu.

The debugger updates the screen after each instruction or line is executed. The highlighted line in the Code window (which indicates the value of the program counter) is the location of the next line to be executed. If a breakpoint is encountered, single-stepping is halted.

You can also use function key *F7* to single-step.

To step over functions

- Click on the **Step Over** action key.
- Or:
- Select **Execution→Step Over→from PC**.
- Or:
- Using the command line, enter:

`Program Step Over`

And press the **< Return >** key.

The debugger steps through the program one line or one instruction at a time. However, if the debugger encounters a C function or assembly-level JSR or CALL instruction, it stops stepping, executes the JSR or CALL instruction, and then continues stepping when the called subroutine returns.

You can also use function key *F8* to step over functions.

To run from the current PC address

- Click on the **Run** action key.
- Or:
- Select **Execution** → **Run** → **from PC**.
- Or:
- Using the command line, enter:

`Program Run`

And press the **< Return >** key.

The program runs until:

- The program encounters a permanent or temporary breakpoint.
- An error occurs.
- A STOP instruction is encountered.
- You press **< Ctrl > -C**.
- The program terminates normally.

You can run from the current program counter address to resume program execution after the program has been stopped.

To run from a start address

- 1 Enter the start address into the entry buffer.

2 Select **Execution**→~~**Run**~~→**from ()**.

Or:

- Using the command line, enter:

```
Program Run From <start_addr>
```

Type in the start address, and press the **< Return >** key.

The program runs until:

- The program encounters a permanent or temporary breakpoint.
- An error occurs.
- A STOP instruction is encountered.
- You press **< Ctrl > -C**.
- The program terminates normally.

Running from a start address in high-level mode may cause unpredictable results if the compiler startup routine is bypassed.

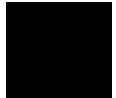

To run until a stop (break) address

1 Enter the stop address into the entry buffer.

2 Select **Execution**→~~**Run**~~→**until ()** or click on the **Run Til ()** action key.

Or:

- Using the command line, enter:

```
Program Run Until <break_addr>
```

Type in the stop address and, optionally, a pass count, and press the **< Return >** key.

Chapter 4: Loading and Executing Programs

Stepping Through and Running Programs

The break address (`< break_address >`) acts as a temporary instruction breakpoint. It is automatically cleared when program execution is halted.

The pass count (`< pass_count >`) parameter specifies the number of times the break address is executed before the program is halted. For example, a pass count of three will cause the program to break on the fourth execution of the break address.

Multiple break addresses are OR'ed. In other words, if you specify more than one break address, the program runs until either address is encountered.

Note

The debugger/emulator implements instruction breaks using software breakpoints. Therefore, break addresses cannot be specified for addresses in target ROM.

Examples

To run the program until either line 20 or line 90 is encountered, whichever occurs first.

```
Program Run Until #20,#90
```

To run from the current program counter address until the break address `update_state_of_system` is encountered twice:

```
Program Run Until update_state_of_system %%2
```

The `Until` option in the command sets a temporary breakpoint at address `update_state_of_system`. The pass count parameter `%%2` specifies that the debugger is to stop program execution on the second access to address `update_state_of_system`.

Using Breakpoints

The debugger implements access, read, and write breakpoints using analyzer hardware.

The debugger implements instruction breakpoints using software breakpoints.

This section shows you how to:

- Set a memory access breakpoint (read, write, or either).
- Set an instruction breakpoint.
- Clear selected breakpoints.
- Clear all breakpoints.
- Display breakpoint information.

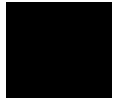

To set a memory access breakpoint

- Enter the address (which may be a symbol) in the entry buffer. Select **Breakpoints**→**Set** and select **Read**, **Write**, or **Read/Write**.

Or:

- Using the command line, enter **Breakpt** select the type of access to break on (Read, Write, or Access), enter the address of the memory location, and press the < **Return**> key.

The access types have the following meanings:

Read break on read accesses.

Write break on write accesses.

Access break on either read or write accesses.

Chapter 4: Loading and Executing Programs Using Breakpoints

Access breakpoints cause the debugger to halt program execution each time the target program reads from or writes to the specified memory location(s). Memory locations can contain code or data.

The debugger uses the emulation analyzer to implement access breakpoints. The analysis hardware has eight single break resources and one range break resource. Each breakpoint command uses one or more of the analysis resources.

The following commands each use one analysis break resource:

- Breakpt Access < addr>
- Breakpt Read < addr>
- Breakpt Write < addr>

The command *Breakpt Access <addr>..<addr>* uses the one range break resource.

The commands *Breakpt Read <addr>..<addr>* or *Breakpt Write <addr>..<addr>* use the analysis range resource and four analysis break resources.

If you request more access breakpoints than there are available in the analysis hardware, the message *Breakpoint limit exceeded* will be displayed on your screen. If this happens, you must delete an existing analysis breakpoint before you can enter a new one.

Due to the latency of the emulation analyzer, the processor will halt from 0 to 2 instruction cycles after the breakpoint is detected. Due to the processor's prefetch feature, it is possible for hardware breaks to occur on addresses of instructions that are not executed.

An address can be accessed without the address appearing on the bus. In this case, a break will not occur. Be sure to read the "Limitations to the Trace Function" section in the introduction to the "Making Trace Measurements" chapter.

Note

The emulator user interface may specify a trace that overrides a debugger access breakpoint. The debugger interface will set up the access breakpoint trace when a run or step command is issued only if the analyzer is not currently in use. Using both access breakpoints in the debugger and trace features in the emulator is not recommended.

Examples

To cause execution to halt each time the program reads from or writes to the variable `current_temp`:

```
Breakpt Access &current_temp
```

To cause execution to halt each time the program reads from the variable `current_temp`:

```
Breakpt Read &current_temp
```

To cause execution to halt each time the program writes to the variable `current_temp`:

```
Breakpt Write &current_temp
```

To set an instruction breakpoint

- Position the mouse pointer in the code window over the line at which you wish to set a breakpoint. Either click the right mouse button, or press and hold the right mouse button to display the Debugger Display pop-up menu and choose **Set/Clear Breakpoint** from the menu.

Or:

- Enter the instruction address into the entry buffer, then select **Breakpoints**→**Set**→**Instruction** ().

Or:

- Using the command line, enter:

```
Breakpt Instr <addr>
```

Enter the address of the instruction location, and press the **< Return >** key.

The instruction breakpoint causes the debugger to halt program execution each time the target program attempts to execute an instruction at the

Chapter 4: Loading and Executing Programs Using Breakpoints

specified memory location(s). The debugger halts program execution before the program executes the instruction at the breakpoint address.

If you specify a range, the debugger sets breakpoints on the first byte of each instruction within the specified range.

Set breakpoints are marked with asterisks “*” in the code window. In the high-level mode, dots “.” show the source lines associated with a breakpoint.

Instruction breakpoints are implemented using the emulator’s software breakpoint capability. You can set up to 32 software breakpoints. These breakpoints are implemented by replacing the program opcode with a BKPT instruction. Executing the BKPT instruction causes program control to be transferred to the emulation monitor, stopping the program.

Because a BKPT instruction must replace the instruction at a memory location, software breakpoints can only be set in:

- Emulation RAM.
- Emulation ROM.
- Target system RAM.

Software breakpoints cannot be set in target ROM. Software breakpoints cannot be used to detect data accesses.

Note

The default setting of the debugger option *Align_Bp* (align breakpoint) is *oFF*. Setting the option to *On* causes breakpoints to be aligned based on the assembly language instructions found in memory at the time the breakpoints are set. If multiple breakpoints exist in the same program area, their alignment may be incorrect. Make sure the *Align_Bp* option is set to *oFF* to prevent breakpoint alignment problems. See the “Configuring the Debugger” chapter for more information.

Note

Setting an instruction breakpoint in a memory area mapped as emulation ROM is allowed because the debugger can write to emulation ROM addresses. Setting an instruction breakpoint in a memory area mapped as target ROM is allowed if you answer *no* to the configuration question *Break processor on write to ROM?*. The breakpoint will be recorded in the breakpoint window. However, if the target memory area is made up of ROM chips in the specified memory area, the BKPT instruction cannot be written to memory. Therefore, the breakpoint will never be executed. If you answer *yes* to the configuration question *Break processor on write to ROM?*, you are not permitted to set breakpoints in areas mapped as target ROM.

Examples

To set an instruction breakpoint at line 82 of the current module:

```
Breakpt Instr #82
```

To set a breakpoint for a C++ object instance

- Use the dot or arrow operator to specify the object and the member function.

This allows you to set a breakpoint for a member function only when it is invoked for a given object or instance.

Example

To break when function *cfunc* is invoked by object instance *cobj1*, enter:

```
Breakpoint Instr cobj1.cfunc
```

To do this the hard way, you could enter:

```
Breakpoint Instr C::cfunc\@entry;when (C::cfunc\this==&cobj1)
```

To set a breakpoint for overloaded C++ functions

- To set a breakpoint at one of the functions when you know the argument type, supply the argument type following the function name.
- To set a breakpoint at one of the functions when you don't know which argument type you want, just use the name of the function. The debugger will list the choices with a menu in the Journal window.

Example

To set a breakpoint for the function *print* (which is not in a class) for **float** arguments, enter **print (float)** in the entry buffer and select **Breakpoints→Set ()**.

Another way to set a breakpoint for the function *print* is to enter **print** in the entry buffer, select **Breakpoints→Set ()**, then type the number of "print (float);" from the menu in the Journal window.

To set a breakpoint for C++ functions in a class

- Set a breakpoint for the C++ class.

Examples

To set breakpoints for all member functions of the class *classname*, enter "classname::" in the entry buffer, then select **Breakpoints→Set ()** from the menu bar.

Or, using the command line, enter:

```
Breakpoint Instr classname::
```

To clear selected breakpoints

- Position the mouse pointer in the Code window over the line at which you wish to clear a breakpoint. Click the right mouse button.

Or:

- Position the mouse pointer in the Code window over the line at which you wish to clear a breakpoint. Hold the right mouse button and select **Set/Clear Breakpoint**.

Or:

- Position the mouse pointer in the Breakpoint window over the breakpoint you wish to clear. Hold the right mouse button and select **Delete Breakpoint**.

Or:

- Enter the breakpoint number into the entry buffer, then select **Breakpoints** → **Delete ()**.

Or:

- Using the command line, enter:

```
Breakpt Delete <brkpt_nmbr>
```

Enter the breakpoint number, and press the < **Return** > key.

The debugger assigns a breakpoint number to each breakpoint. The debugger uses this number to remove the breakpoint.

The < brkpt_nmbr > is the number of the breakpoint displayed in the debugger breakpoint window. Enter a range of breakpoint numbers (< brkpt_nmbr > ..< brkpt_nmbr >) to remove more than one breakpoint at a time. When you delete a breakpoint, all following breakpoints are renumbered.

Examples

To delete breakpoint number 1:

```
Breakpt Delete 1
```

To clear all breakpoints

- Select **Breakpoints**→**Delete All**.

Or:

- Select **Delete All Breakpoints** from the Breakpoints window pop-up menu.

Or:

- Using the command line, enter:

```
Breakpt Clear_All
```

And press the < **Return** > key.

To display breakpoint information

- Select **Window**→**Breakpoints**.

Or:

- Using the command line, enter:

```
Window Active Breakpoint
```

And press the < **Return** > key.

The debugger displays the breakpoint window when:

- You enter a breakpoint command.
- You execute the Window Active Breakpoint command.
- You use function keys F1/F2 to activate next/previous windows.

The Breakpoint window temporarily overlays the top portion of the screen.

When made active, this window displays breakpoint information including:

- Breakpoint number.
- Breakpoint address.
- Name of the module or function containing the breakpoint (in high-level mode).
- Module line number (in high-level mode).
- Breakpoint type.
- Command arguments entered with the breakpoint command.

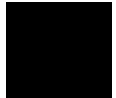

The following paragraphs describe each field in the breakpoint window.

Breakpoint number

The debugger assigns a breakpoint number (#) when you execute a breakpoint command. The debugger uses this number as a label to reference or clear each breakpoint.

Breakpoint address

The breakpoint address (ADDRESS) shows the memory location of the breakpoint. The debugger displays the address as a hexadecimal value.

Module/function

The module/function field (MOD/FNCT) displays either the name of the module containing the breakpoint or the name of a function if you qualified the breakpoint with a function name. If you specify a module name with a breakpoint command, the name must be followed by a line number (for example: *main\#80*). The field width is eight characters. The debugger truncates field entries greater than eight characters in length to eight characters.

Line number

The line number entry (LINE) displays a module line number if you set a breakpoint in a high-level module. If the compiler did not generate executable code for the C statement at the line number specified, the debugger examines the source code and sets a breakpoint on the next line number for which the compiler generated executable code.

In the code window, the debugger places asterisks beside all line numbers that are associated with breakpoints. The debugger places period symbols (.) beside line numbers that are specified as breakpoints, but have no code associated with them.

Breakpoint type

The breakpoint type (TYPE) describes what type of breakpoint is set: instruction, read, write, or access. In assembly-level mode, the debugger sets instruction breakpoints on microprocessor instruction addresses. In high-level mode, the debugger sets instruction breakpoints on source line numbers. The debugger flags instruction breakpoints with */A* (assembly-level) or */H* (high-level). When switching between modes, these flags are useful for differentiating between the different types of breakpoints.

Command argument

The debugger records arguments (COMMAND ARGUMENT) in the breakpoint window as you entered them on the command line. Line numbers, addresses, symbol names, and macro names all appear in this field. For more information about breakpoints, see the specific breakpoint command descriptions in the “Debugger Commands” chapter.

To halt program execution on return to a stack level

- Select **Run Until Stack Level** from the Backtrace window pop-up menu.

Or:

- 1 Set a stack level breakpoint.
- 2 Run the program.
- 3 If desired, delete the breakpoint that was just encountered.

Example

Assume that you want to run the program until it returns to the *main()* function. You can determine where to set a breakpoint on return to main by using the stack level information in the backtrace window (you may have to activate this window in order to see the information in it).

There is a number next to the function *main()* in the backtrace window. This is the current stack level of *main()*. This is the address of the machine level instruction immediately following the call to *initialize_system*.

Place the mouse pointer over the line in the backtrace window that lists "main." Hold the right button and select **Run Until Stack Level**.

Or, using the command line and assuming *main()* is at stack level 1, enter:

```
Breakpoint Instr @1
```

This command will cause program execution to stop when the program returns to the function *main*. The at sign (@) is a debugger operator that causes the debugger to interpret the number 1 as a stack level.

Executing the Breakpt Instr command causes the debugger to update and display the Breakpoint window. The breakpoint you just entered is shown in the Breakpoint window. Now use the appropriate commands to run the program and delete the breakpoint.

Restarting Programs

This section shows you how to:

- Reset the processor.
- Reset the program counter to the starting address.
- Reset program variables.

To reset the processor

- Select **Execution**→**Reset to Monitor**.

Or:

- Using the command line, enter:

```
Debugger Execution Reset_Processor
```

And press the < **Return** > key.

Resetting the processor resets the microprocessor to its initial state and leaves the microprocessor running in the monitor.

To reset the program counter to the starting address

- Select **Execution**→**Set PC to Transfer**.

Or:

- Using the command line, enter:

```
Program Pc_Reset
```

And press the < **Return** > key.

The program counter is reset to the transfer address of your absolute file. The next Program Run or Program Step command entered without a *from* address will restart program execution at the beginning of the program.

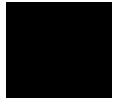

To reset program variables

- Reload your program.

Memory is not reinitialized when you reset the processor or reset the program counter. Therefore, program variables are not reset to their original values. To reset program variables after resetting the processor or program counter, reload your program.

For faster loading, you can load only the program. The debugger retains symbol information. You do not have to reload symbol information if symbol addresses have not changed.

For information on loading programs, refer to the previous “Loading Programs and Symbols” section.

Loading a Saved CPU State

State files are used to save the current CPU state (memory image and register values) of a debug session. Though state files can only be created from within a debugger/simulator session, you can use them to restore a CPU state in either a debugger/simulator or debugger/emulator session.

This section shows you how to:

- Load a saved CPU state.

To load a saved CPU state

- 1 Ensure that the emulator is configured correctly for the code you are restoring and that debugger parameters that affect the emulator (such as breakpoints) are set to appropriate values.
- 2 Load symbolic information from same absolute file that was in the simulator when the CPU state was saved. (The debugger/simulator does not save symbolic information.)
- 3 Load the save file. Using the command line, enter:

```
Debugger Execution Load_State
```

Enter the name of the file from which the CPU state should be loaded, and press the < **Return** > key.

The memory contents and register values saved with the debugger/simulator Debugger Execution Save_State command are restored from the specified state file. If you do not specify a file name, the debugger uses the default file *db68k.sav* (for 68020) or *db68040.sav* (for 68030).

The Debugger Execution Load_State command does not restore breakpoints, macros, or pseudo register values. After redefining any breakpoints, macros, and pseudo registers, you are ready to continue your debugging session.

If your program uses simulated I/O, it may not function properly on entering the debugger/emulator because the simulated I/O initialization may not have occurred.

Examples

To restore memory contents and register values saved in save file "session1.sav":

```
Debugger Execution Load_State session1
```

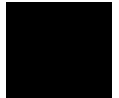

Using the MC68030 Memory Management Unit

The deMMUer

The deMMUer in the analyzer reverses the translations made by the MMU before sending addresses to the analyzer. The debugger interface can use the deMMUer to translate physical addresses to logical addresses.

Your HP emulator and analyzer can give you complete support for a static memory management system, and partial support for a non-paged, dynamic memory management system. Your HP emulator will let you run a paged, dynamic system, but the analyzer will not be able to support features such as symbolic addresses or source code display.

The emulator/analyzer interface

If your target system uses the MC68030 MMU, you should use the emulator's graphical user interface along with the debugger's graphical user interface.

The HP B1479 MC68030 Graphical User Interface provides additional commands to help you design and test programs which use the MMU. In addition, the *68020/030 Graphical User Interface User's Guide* discusses MMU programming and deMMUer operation in detail.

Restrictions when using the MMU

The following restrictions apply when using the MC68030 emulator with the MMU turned on:

- Use a foreground monitor.
- The foreground monitor must not be write protected.
- Map the foreground monitor to address space that the MMU translates 1:1 (logical= physical).

These restrictions are necessary because the emulator must be able to find the monitor code whether the MMU is turned on or off.

To enable the MMU

- 1 Make sure that the translation tables are valid. These translation tables must be set up by your target system software.
- 2 Enable the MMU in the emulator by answering the "Enable the MMU?" question in the emulator configuration or by loading the translation control register.

When you enable the MMU, the debugger status line will change from "68EC030" to "68030."

- 3 Load the translation tables into the deMMUer by entering the following command on the debugger's command line:

```
Trace deMMUer Load Verbose
```

- 4 Enable the deMMUer by entering the following command on the debugger's command line:

```
Trace deMMUer Enable
```

After the deMMUer is loaded, any change to the MMU will make the deMMUer out of date. If you change the MMU, remember to re-load the deMMUer.

The target program will be interrupted while the deMMUer is being loaded. The analyzer will produce strange results if it is making a trace while the deMMUer is being loaded.

Accessing the UNIX Operating System

This section shows you how to:

- Fork a UNIX shell.
- Execute a UNIX command.

To fork a UNIX shell

- Select **File**→**Term**.

A terminal emulation window will be created.

Or:

- Using the command line, enter:

```
Debugger Host_Shell
```

And press the < **Return** > key.

The *Debugger Host_Shell* command lets you temporarily leave the debugging environment by forking a UNIX shell. The shell created is whatever the shell variable *SHELL* is expanded to. In this mode, you may enter operating system commands.

The *Debugger Host_Shell* command does not end the debugger session; it suspends program operation. To return to the debugger, enter < **Ctrl** > **-D** or type **exit** at the UNIX prompt, and press the < **Return** > key.

To execute a UNIX command

- Using the command line, enter:

```
Debugger Host_Shell
```

Type in the UNIX command, and press the < **Return** > key.

When using the graphical interface, a terminal emulation window will be opened and the UNIX command will be executed in that window (as specified by the “shellCommand” X resource).

When using the standard interface, *stdout* from the command is written to the journal window. *stderr* is not captured. Commands writing to *stderr* will corrupt the display. Interactive UNIX commands **cannot** be used in this mode.

Examples

To display the current working directory, enter:

```
Debugger Host_Shell pwd
```

Using the Debugger and the Emulator Interface

The debugger and the emulator interface can use the emulator hardware at the same time.

You should be aware of a few inconsistencies between the emulator and the debugger interfaces:

- Modifying registers in one interface will not affect the register content in the other interface. For example, modifying register D0 in the emulator does not change the contents of D0 in the debugger interface. The PC register is an exception to this rule.
- Loading an executable file in the debugger interface will set the program counter to the transfer address by default. Loading an executable in the emulator interface does not set the program counter.

To start the emulation interface from the debugger

Proceed with your debugging session until you get to the point where you need to use an emulator analysis feature.

- If you are using the graphical interface, choose **File**→~~Emul700~~→**Emulator/Analyzer**.
- If you are using the standard interface, enter

```
Debugger Host_Shell
```

Then, at the operating system prompt, type:

```
emul700 <emulator_name>
```

When you are done using the emulator, enter **end** then **exit** to return to the debugger's standard interface.

Using simulator and emulator debugger products together

You can continue a debugging session started in the debugger/simulator in the debugger/emulator by following the steps listed below:

- 1 In the debugger/simulator, use the **Debugger Execution Save_State** command to save the current memory contents and register values.
- 2 Quit the simulator session using the **Debugger Quit** command.
- 3 Start the debugger/emulator.
- 4 Load the save file created with the **Debugger Execution Save_State** command using the **Debugger Execution Load_State** command. This will restore memory and processor registers to the state you saved in the debugger/simulator.

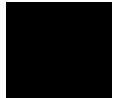

Using the Debugger with the Branch Validator

The Hewlett-Packard Branch Validator (BBA) is an interactive tool that helps you rapidly determine which branches of a program have not been taken. With the missed branches identified, you can modify your regression tests to ensure software reliability.

The branch analysis information is collected by C programs that have been compiled using the **bbacpp** preprocessor.

To unload Branch Validator data from program memory

- Select **File**→**Store**→**BBA Data ...**. Then choose a file name from the File Selection dialog box.

Or:

- Using the command line, enter:

```
Memory Unload_BBA All
```

And press the < **Return** > key.

This command unloads branch analysis information associated with all absolute files loaded.

The default file name is *bbadump.data*.

The BBA preprocessor (-b option) must be used at compile time in order for this information to exist in program memory.

Once this information has been unloaded, it can be formatted with the BBA report generator, *bbarep* (see the *HP Branch Validator for AxLS C User's Guide*).

Note

The Unload_BBA command is disabled when the debugger option Demand_Load is *On*. If Demand_Load is *off* but the program was loaded with Demand_Load On, the Memory Unload_BBA command will generate a BBA file with incomplete information. See the Debugger Option General command description in this manual for more information on the Demand_Load option.

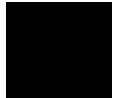

Chapter 4: Loading and Executing Programs
Using the Debugger with the Branch Validator

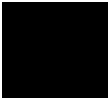

5

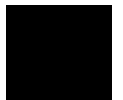

Viewing Code and Data

How to find and display source code and memory contents.

Using Symbols

This section shows you how to:

- Add a symbol to the symbol table.
- Display symbols.
- Delete a symbol from the symbol table.

To add a symbol to the symbol table

- Using the command line, enter:

```
Symbol Add
```

Enter the symbol data type, the symbol name, and optionally the base address and the initial value; then, press the < **Return**> key.

Two type of symbols can be added:

- Program symbols, which are identical to variables defined in a C or assembly program. These symbols must be given base addresses.
- Debugger symbols, which may be used to aid and control the flow of the debugger. These symbols are specified without a base address, and only debugger commands and C expressions in macros can refer to them. They cannot be referenced by the program in target memory.

Example

To add a program symbol named EOF of type int (default) at target memory address 9ff0h and set the memory location to value -1:

```
Symbol Add EOF Address 9ff0h Fill_Mem -1
```

To display symbols

- Select **Display**→**Symbols**→to display information about the symbol in the entry buffer.

Or:

- Using the command line, enter:

```
Symbol Display Default
```

Enter the symbol, module, or function name; then, press the < **Return** > key.

Symbols and associated information are displayed in the journal window.

When displaying a symbol in the current module, the debugger looks for the symbol in the current module. If there is no module qualifier, all symbols with the specified name will be displayed, including global symbols and symbols local to the module.

The wildcard character * may be placed at the end of a symbol name to represent zero or more characters. If used with no symbol name, * is treated the same as \, that is, all symbols are displayed.

Examples

To display the symbol 'updateSys' in the current module:

```
Symbol Display Default updateSys
```

```
Symbol Display Default updateSys
@ecs\\updateSys    : Type is High level module.
                   Code section = 00001436 thru 00001C21
```

To display all symbols in module 'updateSys':

```
Symbol Display Default updateSys\
```

```
> Symbol Display Default updateSys\
Root is: updateSys

@ecs\\updateSys    : Type is High level module.
                   Code section = 00001436 thru 00001C21
updateSys\update_state_of_system
                   : Type is Global Function returning void.
```

Chapter 5: Viewing Code and Data

To display symbols in all modules

```
update_state_of\refresh      Address = 00001436 thru 00001513
                             : Type is Local int.
                             Address = Frame + 8
update_state_of\interval_complete
                             : Type is Local int.
                             Address = Frame + 12
:
```

To display symbols in all modules

- With "\ " in the entry buffer, select **Display**→**All Symbols** ().

Or:

- Using the command line, enter:

```
Symbol Display Default \
```

To delete a symbol from the symbol table

- Using the command line, enter:

```
Symbol Remove <symb_name>
```

Enter the symbol, module, or function name; then, press the < **Return** > key.

The specified symbols are removed from the symbol table. Only program symbols and user-defined debugger symbols can be deleted from the symbol table.

Examples

To delete symbol 'current_targets' in function 'alter_settings':

```
Symbol Remove alter_settings\current_targets
```

Chapter 5: Viewing Code and Data
To delete a symbol from the symbol table

To delete all symbols in module 'updateSys':

```
Symbol Remove updateSys\
```

To delete all symbols in all modules:

```
Symbol Remove \
```

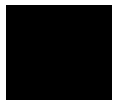

Displaying Screens

A debugger screen is what you see in the display area. Each debugger screen may contain one or more debugger windows. A debugger window is a predefined physical area on the screen containing specific debugger information.

The debugger has three predefined screens. Each predefined screen has a corresponding name and number. The predefined screens and their associated names and numbers are listed below:

| Screen Name | Screen Number |
|-----------------------|---------------|
| High-level screen | 1 |
| Assembly-level screen | 2 |
| Standard I/O screen | 3 |

This section shows you how to:

- Display the high-level screen.
- Display the assembly level screen.
- Switch between the high-level and assembly screens.
- Display the standard I/O screen.
- Display the next screen (activate a screen).

High-Level Screen

The debugger automatically displays the high-level screen when an executable (.x) file containing the C function main() is loaded from the UNIX command line with the db68k command. This screen has nine windows:

- journal
- code
- monitor
- backtrace
- status
- breakpoint
- error
- help

- view

The high-level screen displays high-level source code and stack backtrace information including the calling sequence of functions and function nesting levels.

Assembly-Level Screen

The debugger automatically displays the assembly-level screen when an executable (.x) file is loaded from within the debugger or the executable file does not contain the C source function main(). This screen has ten windows:

- journal
- code
- monitor
- register
- stack
- status
- breakpoint
- error
- help
- view

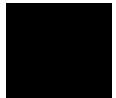

The assembly-level window displays assembly-level code and processor register and stack information.

Standard I/O Screen

The debugger displays the standard I/O screen when your program requests interactive input from the standard input device (stdin), or directs output to the standard output device (stdout). It may also be displayed using the *F6* function key. This screen has five windows:

- status
- breakpoint
- error
- help
- view

You can also access the standard I/O screen as a window (window No. 20).

The standard I/O window emulates a dumb terminal. It can be moved about the display, but it can be no larger than 24 rows by 80 columns.

To display the high-level screen

- Select **Settings**→**High Level Debug**.

Or:

- Using the command line, enter:

```
Window Screen_On High_Level
```

To display the assembly level screen

- Select **Settings**→**Assembly Level Debug**.

Or:

- Using the command line, enter:

```
Window Screen_On Assembly_Level
```

To switch between the high-level and assembly screens

- Press the **F3** function key.

Or:

- Using the command line, enter:

```
Debugger Level
```

You can also use the Window New and the Window Active commands to display a different screen.

To display the standard I/O screen

- Press the **F6** function key.

Or:

- Select **Window→Simio**.

Or:

- Using the command line, enter:

```
Window Screen_On Stdio
```

The standard I/O screen is displayed when your program requests interactive input from the standard input device (keyboard) or when your program writes information to the standard output device.

To display the next screen (activate a screen)

- Press the **F6** function key.

Or:

Chapter 5: Viewing Code and Data
To display the next screen (activate a screen)

- Using the command line, enter:

`Window Screen_On Next`

The next higher-numbered screen will be displayed. Either the high-level or the assembly-level screen will be displayed, not both.

The debugger screens are numbered as follows:

| Screen Name | Screen Number |
|-----------------------|----------------------|
| High-level screen | 1 |
| Assembly-level screen | 2 |
| Standard I/O screen | 3 |
| User-defined screens | 4-256 |

Displaying Windows

This section shows you how to:

- Change the active window.
- Select the alternate view of a window.
- Set the cursor position for a window.

A debugger window is a predefined physical area on the screen. The debugger has 18 predefined windows. Each window displays information specific to its associated name (for example, the breakpoint window displays breakpoint information).

Each of the 18 predefined windows has a corresponding name and number. All windows (except the log file and journal file windows, which are files) also have an associated screen number. The following table lists the predefined windows and their associated names and numbers.



Chapter 5: Viewing Code and Data
To display the next screen (activate a screen)

| Window Name | Window Number | Screen Number |
|---------------------------|---------------|---------------|
| journal (high-level) | 1 | 1 |
| code (high-level) | 2 | 1 |
| monitor (high-level) | 3 | 1 |
| backtrace | 4 | 1 |
| status (high-level) | 5 | 1 |
| journal (assembly-level) | 10 | 2 |
| code (assembly-level) | 11 | 2 |
| monitor (assembly-level) | 12 | 2 |
| register (assembly-level) | 13 | 2 |
| stack | 14 | 2 |
| status (assembly-level) | 15 | 2 |
| standard I/O | 20 | 3 |
| view | 24 | 1, 2, 3 |
| breakpoint | 25 | 1, 2, 3 |
| error | 26 | 1, 2, 3 |
| help | 27 | 1, 2, 3 |
| log file | 28 | none |
| journal file | 29 | none |

The code window displays C source code in high-level mode. The code window displays disassembled machine code in assembly-level mode. The C source code that generated the assembly code can be interleaved with the assembly-level code.

When disassembled code is displayed, the address and machine code of a disassembled instruction are displayed on the left side of the window as hexadecimal values. For instructions over 6 bytes in length, bytes 7 through n are replaced by ellipsis (...).

The stack window displays the stack beginning at the memory location pointed to by the debugger stack pointer @SP. This window is available only within the assembly-level screen.

To change the active window

- Use the *command select* mouse button to click on the border of the window you wish to activate.

Or:

- Select the window you want to make active from the **Window**→menu.

Or:

- Use the command line to select a window:

```
Window Active <window>
```

where <window> is the name of the window to be made active, and press the <Return> key.

The debugger uses a highlighted or thick border for the active window. The cursor keys, scroll bar, and function key *F4* (select the alternate display) only operate in the active window.

If you are using a terminal without graphics capabilities, the active window is indicated by single dashes around the border (other windows all have borders of equals signs).

The window number is displayed in the upper right border of the window.

Examples

To make the high-level backtrace window active:

```
Window→Backtrace
```

Or:

```
Window Active High_Level Backtrace
```

To make the breakpoint window active:

```
Window Active Breakpoint
```

To select the alternate view of a window

To make user window 57 active:

```
Window Active User_Window 57
```

To select the alternate view of a window

- Click on the border of the active window with the *command select* mouse button.

Or:

- Press the **F4** function key.

Or:

- Using the command line, enter:

```
Window Toggle_View
```

Or:

- Using the command line, enter:

```
Window Toggle_View <Window>
```

where < *Window* > is the name of the window whose alternate view is to be displayed, and press the < **Return** > key.

The typical default alternate view of a window is an enlarged view of the window, letting you view more information. Repeating the command switches between the normal view and the alternate view of the active window.

Example

To display the alternate view of the assembly level code window:

```
Window Toggle_View Assembly Code
```

To view information in the active window

- Use the scroll bar.

Or:

- Use the cursor control keys.

Press the < **Up**> or < **Down**> cursor key to move up or down in the window one line at a time.

Press the < **Page Down**> (< **Next**>) or < **Page Up**> (< **Prev**>) key to move the window one-half of the window length at a time.

Press the < **Home**> or < **End**> (< **Shift**> < **Home**>) key to position the window at the beginning or end of the information displayed in the window.

Type < **Ctrl**> -**F** or < **Ctrl**> -**G** to shift the contents of the active window to the right or left.

The following table describes the functions of the cursor control keys in the active window and the command line window.

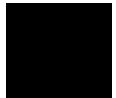

Chapter 5: Viewing Code and Data
To view information in the "More" lists mode

| Key | Description |
|------------------|--|
| → | Move to right in data field of command. Highlight token to the right in status line window. |
| ← | Move to left in data field of command. Highlight token to the left in status line window. |
| ↑ | Move up one line in window. |
| ↓ | Move down one line in window. |
| Prev | Move up one half window. |
| Next | Move down one half window. |
| Home | Move to the top of the active window (except stack window). |
| End (Shift Home) | Move to bottom of window (except for stack window). |
| Insert char | Put keyboard in insert mode for editing data field of command. |
| Delete char | Delete character within data field of command. |
| Undo | Back tab. |

The Home and End (Shift-Home) keys have additional functions when used with the code and stack windows. The following table describes how the Home and End (Shift-Home) keys work in these active windows.

| Active Window | Home Key | End Key |
|----------------------|------------------------------------|------------------------------------|
| Code | Move to top of module | Move to bottom of module |
| Stack | Move to current stack pointer (SP) | Move to current frame pointer (FP) |

To view information in the "More" lists mode

If the "--More--" prompt is printed at the bottom of a window, the debugger is waiting to display more than one screen of information.

- Press the space bar to display the next screen of information.
- Press the < **Return**> key to display the next line.
- Press "Q" to end the "More" display.

If you try to enter a command while the debugger is displaying the "--More--" prompt, the command will not be executed until the "More" display has ended.

You can turn the "More" list mode off or on with the **Settings**→**Debugger Options** dialog box.

For more information, see your operating system documentation on the **more** command.

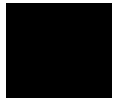

To copy window contents to a file

- Select **File**→**Copy Window**→

Or:

- From the command line, enter the following commands:

```
File User_Fopen Append 99 File <file_name>  
Expression Fprintf 99, "%w", <window_number>  
File Window_Close 99
```

Displaying C Source Code

This section shows you how to:

- Display the C source code.
- Find first occurrence of a string.
- Find next occurrence of a string.

To display C source code

- 1 Display the high-level screen (see the instructions in the previous “Displaying Screens” section).
- 2 Display source code at the location in the entry buffer by selecting **Display→Source ()**. Or click on the **Disp Src ()** action key.

Or, using the command line, enter:

```
Program Display_Source
```

Enter the line number or function name of the code you wish to display, and press the < **Return** > key.

Examples

To display the C source code at line number 1:

```
Program Display_Source #1
```

To display the C source code at function *main*:

```
Program Display_Source main
```

To display C++ source code at overloaded C++ function *cfunc*, you can either give the name of the function and select the definition from a menu, or you can specify the definition by entering the argument type:

```
Program Display_Source cfunc (float)
```

To find first occurrence of a string

- 1 Display the high-level screen (see the instructions in the previous “Displaying Screens” section).
- 2 Enter the string in the entry buffer.
- 3 Select **Display→Source Find Fwd ()** or **Display→Source Find Back ()**.

Or, using the command line, enter:

```
Program Find_Source Occurrence <Direction>
```

Select either **Forward** or **Backward** as the direction, enter the line number or string you wish to find, and press the **< Return >** key.

Example

To find the first occurrence of the string “main”:

```
Program Find_Source Occurrence Forward main
```

To find next occurrence of a string

- Select **Display→Source Find Again**.

Or:

Chapter 5: Viewing Code and Data
To find next occurrence of a string

- Using the command line, enter:

```
Program Find_Source Next <Direction>
```

Select either Forward or Backward as the direction, and press the < **Return** > key.

Example

To find the next occurrence of a string:

```
Program Find_Source Next Forward
```

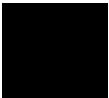

Displaying Disassembled Assembly Code

Coprocessor Support

External devices must be supported by your target system. No support is provided by the debugger/emulator.

68881/68882 Floating-Point Unit. The debugger does not disassemble the 68881 FPU instruction set. It does not contain features that allow FPU register display or modification.

While FPU instructions can be executed in the target system, the debugger/simulator cannot execute these instructions. To generate code that will run interchangeably in both the debugger/emulator and debugger/simulator, use the C compiler's floating point library routines. These libraries contain routines that do not use FPU instructions, thereby allowing them to execute properly in both debugging environments.

68851 Memory Management Unit. The debugger does not support the 68851 MMU.

To display assembly code

- Select **Settings**→**Assembly Level Debug**.

Or:

- Using the command line, enter:

```
Window Screen_On Assembly_Level
```

The Code window will show disassembled instructions.

Displaying Program Context

This section shows you how to:

- Set current module and function scope.
- Display current module and function.
- Display debugger status.
- Display register contents.
- Display the function calling chain (stack backtrace).
- Display all local variables of a function at the specified stack (backtrace) level.

To set current module and function scope

- Select **File**→**Context**→**Symbols ...**, enter the module or function name in the dialog box, and click on the OK pushbutton.

Or:

- Using the command line, enter:

```
Program Context Set
```

Enter the module or function name, and press the < **Return**> key.

The module and function scope is used by the debugger to uniquely identify symbols. For example, several functions may have local variables with the same names. When you use that variable name without naming the function, the debugger assumes you mean the variable in the current module or function scope.

Examples

To select module “updateSys” as the current module:

```
Program Context Set updateSys
```

To select function “updateSys\paint_display” as the current function:

```
Program Context Set updateSys\paint_display
```

To set the program context to the module at which the program counter is pointing:

```
Program Context Set
```

To display current module and function

- Select **Display**→**Context**. Click on the Done pushbutton when you wish to stop displaying the information.

Or:

- Using the command line, enter:

```
Program Context Display
```

The current module, function, and line number are displayed in the journal window.

To display debugger status

- Select **Window**→**Status**.

Or:

Chapter 5: Viewing Code and Data
To display register contents

- Using the command line, enter:

```
Debugger Execution Display_Status
```

The following information is displayed in the view window (which temporarily overlays the top portion of the screen):

- Product version.
- Current working directory.
- Current log file in use.
- Current journal file in use.
- Startup file used.

The view window is also used to display trace data and information about trace command or event status. When trace data is displayed, a trace status character may be displayed in front of the trace line. The following table defines the trace status characters.

Trace List Status Characters

| Character | Description |
|------------------|---|
| * | The indicated trace line is the trigger condition. |
| + | The indicated trace line is in the middle of a C statement, that is, not the first assembly language statement in the C source statement. |
| ! | The data in the trace buffer line does not match the data in memory. |
| ? | The trace line may be a prefetch. |

To display register contents

- Select **Window→Registers**.

Or:

- Select **Modify**→**Registers**.

Or:

- Using the command line, enter:

```
Window Active Assembly Registers
```

The register window shows the current values of the microprocessor's registers and several debugger variables. The microprocessor register values are labeled with their standard names. The debugger displays all values in hexadecimal format unless otherwise noted.

If you are running just the debugger the Registers window is available only within the assembly-level screen. If the emulator/analyzer graphical interface is active, **Window**→**Registers** will display registers in the emulator window.

Note

The information displayed in the register window varies with different microprocessors. See the “Reserved Symbols” chapter for more information about debugger variables.

To display the function calling chain (stack backtrace)

- Select **Window**→**Backtrace**.

Or:

- Using the command line, enter:

```
Window Active High_Level Backtrace
```

To display the function calling chain (stack backtrace)

The backtrace window displays the function calling chain, from the compiler startup routine to the current function in high-level mode.

This window displays (from left to right):

- Function nesting level.
- Return address to the calling function.
- Frame status character.
- Module containing the function.
- Function name.

Function Nesting Level. The nesting level of the current function is always 0, the calling function always 1, etc.

You may reference the nesting level when setting a breakpoint. For example, to cause the program to execute until it returns to the second nested function, enter the command:

```
Program Run Until @2
```

Another way to execute until a stack level is reached is to choose **Run Until Stack Level** in the Backtrace window pop-up menu.

Return Address. The return address field displays the return address of the calling function.

Frame Status Character. One of several characters immediately precedes a function name in the backtrace window. These frame status characters and their descriptions are listed in the table below.

Chapter 5: Viewing Code and Data
To display the function calling chain (stack backtrace)

| Character | Description |
|-----------|--|
| Space | The debugger is executing within a function. |
| : | The program counter is at a label. Typically, this is an assembly language function point. |
| * | The function has been entered, but the function prolog has not been executed. The debugger cannot locate local symbols in the function until the prolog has been executed. |
| ? | The frame is questionable. For example, this is displayed when a function has been stripped of debug information. |
| ! | The frame is not valid. |
| | The debugger is at the start of an interrupt routine. |
| + | The debugger is executing an interrupt routine. |

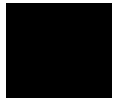

Module Name. If the function is in a known module, the backtrace window displays the module name. If the program counter is pointing to an address that is not contained in a module known to the debugger, the module field in the backtrace window displays a string of question marks (??????).

Function Name. If the return address of a function is inside a known function, the debugger displays the function name. If the address is outside of all known functions, the function field in the backtrace window will display *<unknown>*. This is the case with the compiler startup module *crt0*, because it is assembly code and contains no debug information.

Backtrace Information. Whenever a break occurs in program execution, the backtrace window is updated. When updating the window, the debugger generates backtrace information as described in the following paragraphs. The backtrace window is displayed only in the high-level screen.

Nesting level 0. Nesting level 0 information is based solely on the current value of the processor's program counter (PC). The address shown at this level is the value of the PC. The module and function shown at this level are selected because the value of the PC falls within their code spaces.

Chapter 5: Viewing Code and Data
To display the function calling chain (stack backtrace)

Nesting level 1. When program execution breaks on an address that has an associated public label (for example, a function entry point), nesting level 1 information is based on the processor SP. The debugger assumes that the SP is pointing to the return address because the label is assumed to be a function entry point and no stack frame has yet been established. With no stack frame available, the return address of the calling function is at the top of the stack. This return address is the address at level 1. The module and function shown are based on this address, that is, the address falls within their code spaces.

When program execution breaks on an address that has no associated public label, nesting level 1 is based on the processor's frame pointer (register A6). In this case, the stack location four bytes above the location pointed to by register A6 contains the return address of the calling function. This address is the address shown at level 1; the module and function shown are based on this address.

Nesting levels 2 through n. Nesting levels 2 through n are always based on existing stack frames. A stack frame is generated for each frame on the stack, based on saved frame pointers. Nesting levels are generated until backtracing of the stack encounters a zero frame pointer. This occurs when the stack frame associated with the compiler startup routines crt0/crt1 is encountered.

Functions with no stack frame. If a function has no stack frame (due to compiling with the -O option), the function that called it does not appear in the backtrace window at any stack level other than levels 0 or 1.

Assembly language functions. Assembly language functions that set up stack frames appear in the backtrace window, but the information shown is incomplete. Since high level debug information is not present in such handwritten functions, the stack frame appears as a questionable

To display all local variables of a function at the specified stack (backtrace) level

frame. Additionally, there is no function name associated with the frame, i.e., it is displayed as *<unknown>*.

To display all local variables of a function at the specified stack (backtrace) level

- Select **Disp Vars at Stack Level** from the Backtrace window pop-up menu.

Or:

- Using the command line, enter:

```
Program Context Expand <@stack_level>
```

Enter the stack level preceded by an *at* sign (@), and press the **< Return >** key.

The values of the parameters passed to the function and the function's local variables are displayed in the Journal window.

Example

To display local variables at stack level 1, position the cursor over "1." in the Backtrace window, and hold the right mouse button. Move the mouse to **Disp Vars at Stack Level** and release the button.

Or, use the command line to enter:

```
Program Context Expand @1
```

To display the address of the C++ object invoking a member function

- Display the value of the function's **this** pointer.

If the program has stopped at a function, you can find out the address of the object which invoked the function.

The program counter must be *inside* the function; otherwise you may see a "Local variable not alive" error message.



Example

To see the address of the object that invoked the *cfunc* function in class *C*, enter the following string in the entry buffer:

```
C::cfunc\this
```

then select **Display→Var/Expression ()**.

Using Expressions

This section shows you how to:

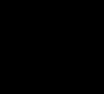
- Calculate the value of a C expression.
 - Display the value of an expression or variable.
 - Monitor variables.
 - Discontinue monitoring specified variables.
 - Discontinue monitoring all variables.
 - Print formatted output to a window.
 - Print formatted output to journal windows.
- 

To calculate the value of a C expression

- Enter the expression in the entry buffer, then select **Display→C Expression ()**.

Or:

- Using the command line, enter:

```
Expression C_Expression
```

Enter the C expression to be calculated, and press the < **Return**> key.

The value of the C expression is displayed in the journal window.

If the C expression is an assignment statement, the Expression C_Expression command sets the value of the C variable.

Examples

To calculate the value of 'time':

To display the value of an expression or variable

```
Expression C_Expression time  
Result is: data address 000091DC {time_struct}
```

To calculate the value of member 'hours' of structure 'time':

```
Expression C_Expression time->hours  
Result is: 4 0x04
```

To assign the value 1 to 'system_is_running':

```
Expression C_Expression system_is_running = 1  
Result is: 1 0x01
```

To display the value of an expression or variable

- Use the mouse to copy the expression or variable into the entry buffer, then select **Display→Var/Expression ()**.

Or:

- Using the command line, enter:

```
Expression Display_Value
```

Enter the expression or variable whose value is to be displayed, and press the **< Return >** key.

The value of the expression or variable is displayed in the journal window.

The contents of an item, such as an array, are displayed instead of the C value of the item which is its address.

Examples

To display the value of the variable 'system_is_running':

```
Expression Display_Value system_is_running  
01h
```

To display the address of the variable 'system_is_running':

```
Expression Display_Value &system_is_running  
000091F0
```

To display the address of the C structure 'time':

```
Expression Display_Value time  
000091DC
```

To display the values of the members of structure 'time':

```
Expression Display_Value *time  
hours      4  
minutes    0  
seconds    20
```

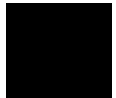

To display the name of the current program module:

```
Expression Display_Value @module
```

To display the name of the current program function:

```
Expression Display_Value @function
```

To display members of a structure

- 1 Copy the name of the structure into the entry buffer.
- 2 Add an asterisk (*) in front of the name of the structure.
- 3 Select **Display→Var/Expression ()**.

If you are using the command line, use the **Expression Display_Value** command.

Chapter 5: Viewing Code and Data
To display the members of a C++ class

Example

To display the names of the members of structure *astruct*, use the following expression in the entry buffer:

```
*astruct
```

The * operator tells the debugger to display the members of the structure, rather than the address of the structure.

To display the members of a C++ class

- Using the command line, enter

```
Symbol Display Options Search_all End_Options  
<class_name>\
```

This will display the type, size, protection, and overloading of each member of *class_name*.

Example

To display the members of class *C*, enter:

```
Symbol Display Options Search_all End_Options C\
```

To display the values of all members of a C++ object

- Enter the name of the C++ object in the entry buffer and select **Display→Var/Expression ()**.

Or:

- Using the command line, enter:

```
Expression Display_Value <object>
```

Remember, you are displaying the values in an *object*, so you need to run the program to the point where the object is created. To display the members of a class, see "To display the members of a C++ class."

Example

To display the members of object *cobj* in class *C*, enter "cobj" in the entry buffer and select **Display→Var/Expression ()**.

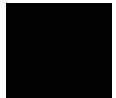

To monitor variables

- Enter the variable to be monitored in the entry buffer and click on the **Monitor ()** action key.

Or:

- Enter the variable to be monitored in the entry buffer and select **Display→Monitor ()**.

Or:

- Using the command line, enter:

```
Expression Monitor Value
```

Enter the variable to be monitored, and press the < **Return** > key.

The monitor window displays monitored variable expressions. This window can be displayed in both the high-level and assembly-level screens.

Chapter 5: Viewing Code and Data

To monitor the value of a register

Variables in the monitor window are updated each time the debugger stops executing the program. (The program is not considered to be "stopped" when a breakpoint with an attached macro is encountered.)

Example

To monitor the value of variable 'current_temp':

```
Expression Monitor Value current_temp
```

To monitor the value of a register

- Monitor a register just as you would a variable.

Example

To monitor the value of register D2, enter "@D2" in the entry buffer and select **Display**→**Monitor** ().

Or, using the command line, enter

```
Expression Monitor Value @D2.
```

To discontinue monitoring specified variables

- Select **Delete Variable** in the Monitor window pop-up menu.

Or:

- Using the command line, enter:

```
Expression Monitor Delete
```

Enter the number of the variable (shown in the monitor window) that should no longer be monitored, and press the < **Return**> key.

The variable is removed from the monitor window.

Example

To stop monitoring variable 2 in the monitor window:

```
Expression Monitor Delete 2
```

To discontinue monitoring all variables

- Select **Delete All Variables** in the Monitor window pop-up menu.

Or:

- Using the command line, enter:

```
Expression Monitor Clear_All
```

All variables are removed from the monitor window.

To display C++ inheritance relationships

- Enter the name of a C++ class in the entry buffer, then select **Display→Symbols→Browse C++ Class ()**.

Or:

- Using the command line, enter:

```
Symbol Browse
```

Enter the name of the C++ class to be displayed, and press the < **Return** > key.

To print formatted output to a window

- Using the command line, enter:

```
Expression Fprintf
```

Enter the number of the user-defined window, the format string (enclosed in quotes), and the arguments; then, press the < **Return** > key.

The formatted output is written to the user-defined window. This command is similar to the C `fprintf` function.

The debugger associates the log file window (window no. 28) with a log (.com) file so that you can write output to that window using the Expression `Fprintf` command. This window is not displayed. It is used only for writing to a command file.

The debugger associates the journal file window (window no. 29) with a journal file so that it can write journal window output to the journal (.jou) file. Additional output may be written to the journal file by writing to window 29.

Examples

To print the value of `var` to user window 57 as a single character:

```
Expression Fprintf 57, "%c", var
```

To print the string in double quotes to user window 57 followed by the floating point value of 'temperature' with a precision of 2:

```
Expression Fprintf 57, "The value of 'temperature' is:  
%.2f \n", temperature
```

To print formatted output to journal windows

- Using the command line, enter:

```
Expression Printf
```

Chapter 5: Viewing Code and Data
To print formatted output to journal windows

Enter the format string (enclosed in quotes) and the arguments; then, press the < **Return** > key.

The formatted output is written to the journal window. This command is similar to the C printf function.

Examples

To print the value of *var* to the journal window as a single character:

```
Expression Printf "%c",var
```

To print the string in double quotes to the journal window followed by the floating point value of 'temperature' with a precision of 2:

```
Expression Printf "The value of 'temperature' is: %.2f\n",temperature
```

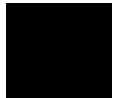

Viewing Memory Contents

This sections explains how to to view, compare, and search blocks of memory.

To compare two blocks of memory

- Using the command line, enter:

```
Memory Block_Operation Match <Mismatch_Operation>
```

Select either Repeat_On_Mismatch or Stop_On_Mismatch to specify what happens when a mismatch is found, enter the address range to be compared and the starting address of the range that it is compared to; then, press the <Return> key.

Example

To compare the block of memory starting at address 1000h and ending at address 10ffh with a block of the same size beginning at address 5000h and stop when a difference is found:

```
Memory Block_Operation Match Stop_On_Mismatch  
1000h..10ffh,5000h
```

To search a memory block for a value

- Using the command line, enter:

```
Memory Block_Operation Search <Size> <Until>
```

Select either Byte, Word, or Long as the size of the memory locations, select either Once or Repeatedly to specify when the search should stop, enter the

Chapter 5: Viewing Code and Data
To examine a memory area for invalid values

address range and the value that is to be searched for, and press the **< Return >** key.

Example

To search for the expression 'gh' in the memory range from address 1000h through address 10ffh and stop when the expression is found or address 10ffh is reached:

```
Memory Block_Operation Search Word Once  
1000h..+0xff = 'gh'
```

To examine a memory area for invalid values

- Using the command line, enter:

```
Memory Block_Operation Test <Size> <Until>
```

Select either Byte, Word, or Long as the size of the memory locations, select either Once or Repeatedly to specify when the search should stop, enter the address range and the value that should be found in the range, and press the **< Return >** key.

Example

To test for the expression 'gh' in the memory range from address 1000h through address 10ffh and stop when a word not matching the expression is found:

```
Memory Block_Operation Test Word Once 1000h..+0xff =  
'gh'
```

To display memory contents

- Select **Display**→**Memory**→.

Or:

- Using the command line, enter:

```
Memory Display <Format>
```

Select either Mnemonic, Byte, Word, or Long as the format in which memory contents are to be displayed.

If you are using the command line, enter the starting address or the address range of the memory whose contents are to be displayed, and press the **< Return >** key.

Examples

To display disassembled memory in the code window starting at the symbol `'_emeg_shutdown'` (this command works only in assembly-level mode):

```
Memory Display Mnemonic _emeg_shutdown
```

To display memory in byte format in the journal window starting at the symbol `'current_humid'`:

```
Memory Display Byte current_humid
```

Using Simulated I/O

Simulated I/O (SIMIO) lets programs use the UNIX file system, run UNIX commands, and use the keyboard and display for input and output.

Your programs can use SIMIO by means of the I/O libraries and environment dependent routines provided with the HP B1461/HP B1478 C Cross Compiler. Your programs use the library functions when they open, close, read, or write to files, etc. These simulated I/O functions are identical in both the debugger/emulator and debugger/simulator to let you write programs that will function correctly in both environments. Refer to the "Environment Dependent Routines" chapter of your compiler manual for information on using the C SIMIO libraries.

Your programs can also use SIMIO by means of user-written assembly code. If you are developing programs that use SIMIO from assembly code, refer to the *Simulated I/O User's Guide* for a complete description of SIMIO protocol.

This chapter shows you how to:

- Enable simulated I/O.
- Disable simulated I/O.
- Set the keyboard I/O mode.
- Redirect I/O.
- Check resource usage.
- Increase file resources.
- Display the simulated I/O system report.

How Simulated I/O Works

Communication between your program running in the emulation system and the SIMIO process takes place through contiguous single-byte length memory locations. The first memory location is called the Control Address (CA). The Control Address and the memory locations that follow it are called the CA buffer.

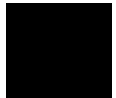

Chapter 5: Viewing Code and Data

To display memory contents

Control Address buffers are less than or equal to 260 bytes in size. A maximum of 256 bytes of information can be transferred between the debugger and the host system at one time. Some simulated I/O commands require four additional bytes for command parameters.

The debugger supports only one Control Address (CA) for doing SIMIO operations. This buffer is named *systemio_buf* in the HP B1461/HP B1478 C I/O libraries. Assembly code users who want to use SIMIO with the debugger must label their Control Address as *_systemio_buf* (the compiler prefixes symbols with an underscore).

Communication between a program and the simulated I/O process is a series of requests by the program and responses by the SIMIO process:

The program places a SIMIO command in the CA buffer and then waits for a return code to be placed in the first byte of the CA.

The SIMIO process polls the CA buffer memory. When it finds a command, the SIMIO process executes the command. When the SIMIO process completes the command, the first byte of the CA buffer is changed to the command return code.

Simulated I/O Connections

The SIMIO system supports three types of I/O connections. These are:

- Keyboard and display.
- UNIX files.
- UNIX processes.

Display and Keyboard

The debugger provides a window named `stdio` which functions as the normal display output for target programs. The screen can be opened for output from target programs via SIMIO with the special name `/dev/simio/display`. This name appears to be an UNIX file name. However, it is really a name reserved by the debugger to indicate the internal screen. The keyboard is accessed by the special name `/dev/simio/keyboard`.

UNIX Files

UNIX files are accessed by their names from the target program running in the debugger in the same way they are accessed by host software. The file operations of open, close, read, write, and seek are supported by the SIMIO

protocol. When opening a stream on an UNIX file, SIMIO supports the same control parameters for file creation and blocking I/O that are available to host programs.

UNIX Processes

UNIX processes can be run as subprocesses to the debugger with their input and output directed to the user program. Subprocesses are controlled from the user program by a Process Identification number (PID). This lets the user program check specific subprocesses, send them signals, or stop them. This subprocess facility allows user programs to take advantage of the powerful software and execution environment of the host UNIX system. Host programs can be used to process data for a debugger user program or to simulate portions of the software that are not available in the user program.

Because simulated I/O lets the debugger execute UNIX commands, the debugger can communicate with other host system I/O devices, such as printers, plotters, modems, etc.

For more information on using UNIX processes, refer to the description of the *exec_cmd()* function in the "Environment Dependent Routines" chapter of the *68020 C Cross Compiler Reference* or *68030 C Cross Compiler Reference* manual.

Special Simulated I/O Symbols

User Program Symbols

The following symbols are user program symbols that are used by the SIMIO system to process the simulated I/O protocol:

systemio_buf This symbol indicates the start of the Control Address buffer.

Simulated I/O Reserved Symbols

The following names are reserved by the SIMIO system and cannot be used for your file names. The SIMIO system recognizes these names and uses special processing to direct the I/O to the proper location:

stdin This name will be replaced by the name stored in the *stdin_name*. This name is set via the *Stdio_Redirect* command.

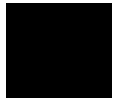

To enable simulated I/O

stdout This name will be replaced by the name stored in the `stdout_name`. This name is set via the `Stdio_Redirect` command.

stderr This name will be replaced by the name stored in the `stderr_name`. This name is set via the `Stdio_Redirect` command.

/dev/simio/keyboard This name refers to the keyboard while the product is running interactively.

/dev/simio/display This name refers to the stdio display window while the product is running interactively.

To enable simulated I/O

- Using the command line, enter:

```
Debugger Execution IO_System Enable
```

When SIMIO is enabled, polling for simio command begins. In the debugger/emulator, the host computer periodically reads the memory in the emulator or target system to detect simio commands issued by the user code. SIMIO behavior in the debugger is identical to that described in the *Simulated I/O User's Guide*, with the exception that only one control address is supported by the debugger. The control address must be named `systemio_buf` (`_systemio_buf` in assembly code).

SIMIO is also enabled if the "Enable polling for simulated I/O?" emulator configuration question was answered `yes` and "Simio control address 1" is `_systemio_buf`.

To disable simulated I/O

- Using the command line, enter:

```
Debugger Execution IO_System Disable
```

To set the keyboard I/O mode to cooked

- Using the command line, enter:

```
Debugger Execution IO_System Mode Cooked
```

In the Cooked mode, the keyboard input is processed. This lets you type and then edit the line to correct errors. When the final line is composed, press the **< Return >** key to enter the line. Once the line is entered, it is read by the target program. Only the characters from the final line and the carriage return character are passed as input. If program execution is interrupted by entering **< Ctrl > -C** before the line is entered, the characters on the input line are lost.

See also

"To set the keyboard I/O mode to raw"

To set the keyboard I/O mode to raw

- Using the command line, enter:

```
Debugger Execution IO_System Mode Raw
```

In the Raw mode, each character you type is sent directly to the target program that is reading from the keyboard. Characters are not echoed as they are typed. Any input editing, such as backspace, must be handled by the target

Chapter 5: Viewing Code and Data

To control blocking of reads

program. The only special character that cannot be sent to the target program is `< Ctrl> -C` which is used to interrupt the debugger's execution of the program.

See also "To set the keyboard I/O mode to cooked"

To control blocking of reads

- Set the `O_NDELAY` flag in the `startup()` routine.

The flag `O_NDELAY` is passed to the function `open()` to control whether or not reads from the keyboard will block *waiting for characters*. When the keyboard is functioning in COOKED mode, this flag is ignored; all reads wait for the line to be composed and entered. When set in RAW mode, the keyboard can be read in a blocking or non-blocking manner, based on the value of the control flag `O_NDELAY`.

This flag can only be set when opening the stream; it may not be changed after the file stream is open. This flag can be set in the compiler-supplied routine `startup()`. This routine opens streams `stdin`, `stdout`, and `stderr`.

See also The chapter titled "Environment Dependent Routines" in the *68020 C Cross Compiler Reference* or *68030 C Cross Compiler Reference* manual.

To interpret keyboard reads as EOF

- Using the command line, enter:

```
Debugger Execution IO_System Keyboard_EOF
```

This causes the debugger to interpret any further keyboard reads as being at the end of file.

In cooked mode, pressing **< Ctrl> -D** is equivalent to entering the *Debugger Execution IO_System Keyboard_EOF* command.

To redirect I/O

To redirect the three I/O streams and to reset your program to the startup address, perform the following steps.

- 1 Redirect the three I/O streams by changing the translation names for the stdio streams. Using the command line, enter:

```
Debugger Execution IO_System Stdio_Redirect  
<"stdin_name", "stdout_name", "stderr_name">
```

Enter the new names for standard input, standard output, and standard error; then, press the **< Return>** key.

- 2 Reset the program counter to the startup address. Select **Execution→Set PC to Transfer**. Or, using the command line, enter:

```
Program Pc_Reset
```

When the target program starts execution from the normal compiler startup address, the standard C startup libraries open the following three I/O streams:

- stdin
- stdout
- stderr

The debugger uses an internal table to determine where the streams should be opened. Each of the names (stdin, stdout, and stderr) has an associated translation name:

- stdin_name
- stdout_name
- stderr_name

Chapter 5: Viewing Code and Data

To check resource usage

The translation name contains the name of a file to use when the target requests opening of any of these stdio streams. By default, `stdin_name` contains `/dev/simio/keyboard` (the keyboard), and translations `stdout_name` and `stderr_name` contain `/dev/simio/display` (the standard I/O (stdio) screen).

These translations are used only when opening the streams. They cannot be used to redirect the streams after they have been opened. The target program must be rerun from the startup address to allow the stdio streams to be reopened if the translations have been changed.

Examples

To redirect the standard input file to the keyboard, the standard output file to the display, and the standard error file to file `~/users/project/errorfile`:

```
Debugger Execution IO_System Stdio_Redirect
"/dev/simio/keyboard", "/dev/simio/display",
"/users/project/errorfile"
```

```
Program Pc_Reset
```

To redirect the standard input file to `temp.dat`, the standard output file to `cmdout.dat`, and the standard error file to file `errorlog.err`:

```
Debugger Execution IO_System Stdio_Redirect
"temp.dat", "cmdout.dat", "errorlog.err"
```

```
Program Pc_Reset
```

To check resource usage

- Using the command line, enter:

```
Debugger Execution IO_System Report
```

The command displays the simulated I/O status, keyboard mode, and the translation names used for `stdin`, `stdout`, and `stderr`.

The SIMIO system has the following default resource limitations:

- 40 open files
- 4 subprocesses

To increase file resources

1 Change to directory *68020* or *68030* in path */usr/hp64000/include* using the **cd** command.

2 Change the value of macro *FOPEN_MAX* from 12 to the new maximum number of open files (the limit is 40) in file *stdio.h* using an editor on your system.

3 Change to directory

/usr/hp64000/env/hp64748/src (for 68020)

or

/usr/hp64000/env/hp64747/src (for 68030/EC030)

using the **cd** command.

4 Recompile file *startup.c* using the command:

```
cc68020 -Ouc startup.c
```

Or

```
cc68030 -Ouc startup.c
```

5 Archive file *startup.o* using the command:

```
ar68k -r startup ../env.a
```

or

```
ar68030 -r startup ../env.a
```

To increase file resources

You can increase the simulated I/O file limit by modifying the startup code for your compiler. The code must be modified from the UNIX shell. The maximum number of open SIMIO files descriptors can be increased to 40.

Caution

Compiler startup files compiled with the modified *stdio.h* header file will run only in the debugger environment. Emulators which do not have the debugger interface do not support the increased number of open SIMIO file descriptors. Call to the SIMIO function `open()` will fail in this environment if 12 file descriptors have already been allocated.

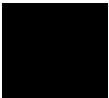

If problems occur when using simulated I/O

- If the target program stops ("hangs") while reading from the keyboard with the *O_NDELAY* flag set, or if programs do not appear to be getting proper input from the keyboard, check the keyboard mode setting.

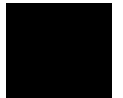

Chapter 5: Viewing Code and Data
If problems occur when using simulated I/O



6

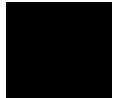

Making Trace Measurements

How to use the debugger to trace the execution of a program in the emulator.

Chapter 6: Making Trace Measurements

This chapter shows you how to:

- Start traces.
- Stop traces.
- Display traces.
- Specify trace events.
- Delete trace events.
- Specify storage qualifiers.
- Specify trigger conditions.
- Halt program execution on the occurrence of a trigger.
- Remove a storage qualification term.
- Remove a trigger term.

The Trace Function

The trace function uses the emulation analyzer in your emulator to capture processor bus cycle information synchronously with the processor's clock signal. A trace is a collection of these captured states.

You can make simple trace measurements using the Code window pop-up menu. Using this menu, you can trace states before and after a line of code is executed.

If you need to make a simple trace measurement, skip the details which follow and turn to "To start a trace using the Code pop-up menu."

You can make complex trace measurements using the command line Trace command. You can tell the debugger exactly which states to store by defining trigger events (a series of events which will start the trace) and storage qualifications (which kinds of states to store).

If you will be making many detailed trace measurements, you should set up your traces using the emulator user interface rather than the debugger interface.

Default Trace Specification

The default trigger condition is "never". You can make a default trace measurement by entering the *Trace Again* command. When you use the default trace condition, qualified bus cycles are collected continuously until you halt the measurement. The trace buffer will then contain the bus states prior to the halt.

Trace Events

Trace measurement parameters are specified as events. An event is a bus state consisting of a combination of address, data, and status values.

Address and Data Values. Address and data values may be specified as 32-bit values or a range of 32-bit values. You can specify a mask to mark valid bits in addresses or data to define "don't care" values. You can also specify the logical "NOT" of an address or data value.

Status Values. Status values are the types of bus activities, such as:

- Read or write operations.
- Memory access size.
- Function codes.
- Cycle types.

You can also specify the logical "NOT" of a status value.

Trace Trigger

A *trigger* specifies the bus events that cause the debugger to make a trace measurement. The debugger lets you trigger on the detection of a single event, an OR'ed combination of events, or after a sequence of events are detected. You can specify a sequence of events, the last of which is the triggering event. You can also trigger on the Nth occurrence of an event, where N is a number you specify with the *count* parameter in the *Trace Trigger Event* command.

You can position the trigger event at the start of the trace buffer, centered in the trace buffer, or at the end of the trace buffer.



Storage Qualification

A storage qualifier defines which bus cycles will be stored when you make a trace measurement. You can specify that only cycles corresponding to certain values be stored in the trace buffer. These values can be addresses, a range of addresses, data values, status values (the type of bus activity), or an OR'ed combination of values. You can also specify the logical NOT of the specified value to be the storage qualifier, that is, any condition that does not match the specification. You can specify that the trace function store up to two instruction fetch cycles preceding the qualified state (prestore).

Trace Resources

The trace function uses the emulation analyzer to implement its measurements. The analyzer puts the following limitations on resources available for trace specifications:

- One range resource.
- Eight event resources.
- Seven sequence terms.

If you enter a range value that can be expressed as a "don't care" value (for example, *address 0x100 to 0x1ff*), the debugger uses one of the eight event resources, rather than the range resource. Complex event specifications, such as combinations of *Is* and *Not* terms, can use multiple event resources. Up to seven sequential events can be specified in a trigger specification.

Trace Status

The status of the trace measurement is indicated on the debugger status line by the *TRC:<Trc_status>* field. The possible values for *<Trc_status>* are:

| | |
|--------|--|
| AwtTrg | A trace measurement is in progress, but the trigger condition has not been detected. |
| BrkRWA | An access breakpoint has been set and will be used as the trigger in the next trace measurement. |
| Cmplt | A trace measurement has completed. |

| | |
|--------|--|
| DataOK | The trace buffer contains valid data. |
| Halted | The <i>Trace Halt</i> command was used to halt the trace. |
| Idle | No trace measurement has been executed during the current debug session. |
| Setup | A trace measurement has been set up (specified), and will start on the next program run or program step command. This status message appears only before the first trace measurement in a debug session. |
| Trgrd | A trace measurement is in progress, and the trigger has been detected. |

Trace status characters

When trace data is displayed, a trace status character may be displayed in front of the trace line. The following table defines the trace status characters.

Trace List Status Characters

| Character | Description |
|------------------|---|
| * | The indicated trace line is the trigger condition. |
| + | The indicated trace line is in the middle of a C statement, that is, not the first assembly language statement in the C source statement. |
| ! | The data in the trace buffer line does not match the data in memory. |
| ? | The trace line may be a prefetch. |

Access Breakpoints

If you have set access breakpoints with the Breakpt Access, Breakpt Read, or Breakpt Write commands, the trace function will interpret the breakpoints as trace trigger terms. When you step or run your program after setting an access breakpoint, the trace measurement is started automatically. You cannot

define a trace trigger while an access breakpoint is active. This will cause an error condition.

Note

The emulator user interface may specify a trace that overrides a debugger access breakpoint. The debugger interface will set up the access breakpoint trace when a run or step command is issued only if the analyzer is not currently in use. Using both access breakpoints in the debugger and trace features in the emulator is not recommended.

Limitations to the Trace Function

There are limitations to the trace function imposed on the debugger by the use of a foreground monitor and when triggering on C variables and instruction fetches.

Limitations when Using a Foreground Monitor. When you use a foreground monitor, the trace function may capture monitor activity as well as your target program activity.

Limitations when Triggering on C Variables. The emulator's analysis hardware watches bus cycles, and triggers on specified bus values. However, bus cycles do not always map directly to C variables. This limitation takes two forms:

The first form occurs when an access to a C variable requires multiple bus cycles. In addition to requiring multiple bus cycles, the number of cycles and the contents of the data bus on each cycle varies with the memory bus width, data size, and data address alignment.

To illustrate this problem, consider a 32-bit variable `foo` at the odd word address `0x1002`. A write of value `0x01023fff` to `foo` will take multiple bus cycles. The following table shows the number of cycles and the contents of the data bus on each cycle for the three possible memory bus widths.

| Bus Cycle | Memory Bus Width | | |
|-----------|--------------------|--------------------|--------------------|
| | 8 Bits | 16 Bits | 32 Bits |
| | addr (data) | addr (data) | addr (data) |
| 1 | 10020102102) | 10020102102)) | 10020102102)) |
| 2 | 10030202f02) | 1003f3ffff) | 1003f3ffff) |
| 3 | 1003f3ffff) | | |
| 4 | 1005ffff)) | | |

The number of cycles and the data bus values will vary depending on memory bus width, data size, and data address alignment. You must consider these factors when specifying triggers containing both address and data values.

The second form of problem occurs when a C variable is written, but the address never appears on the bus. To demonstrate this problem, consider a 32-bit C variable `foo` at address `0x1002` and a "wild pointer" pointing to address `0x1000`. A 32-bit write indirect through the pointer will overwrite part of variable `foo`, but if the memory bus width is 32 bits, the address of `foo` (`0x1002`) will never appear on the address bus. Similarly, a write indirect through a wild pointer pointing to address `0x1004` will overwrite part of `foo` without the address of `foo` appearing on the bus. This limitation can be overcome by specifying an address range when triggering on a symbol that you suspect is being modified by a wild pointer.

Limitations when Triggering on Instruction Fetches. Instructions located on odd word address boundaries can be traced by specifying address values with the mask operator. For example, if `foo` is located on an odd word address boundary, the command:

```
Trace Trigger Address Is foo &= 0xffffffffc
```

will let the trace function trigger on variable `foo`. The mask operator can also be specified as shown in the following command:

```
Trace Trigger Address Is foo &=~3
```

The tilde operator (`~`) performs the one's complement operation in a C expression.

The debugger will apply the appropriate mask for all instruction fetches if you use the Debugger Option `Trace Fetch_Align` command.

To start a trace using the Code pop-up menu

- 1 Position the mouse pointer over the line of code which should trigger the trace.
- 2 Hold down the right mouse button and select one of the **Trace** items from the Code window pop-up menu.
- 3 When "TRC:Cmplt" appears on the status line, stop execution of the program if it is not already halted.
- 4 Select **Window**→**Trace** to see the trace information.
- 5 Use the keyboard arrow keys or the scroll bar to scroll through the trace information. Press <ESC> <ESC> to exit trace mode.

This will trace the execution of code near the line you selected.

You can choose any one of the following:

- **Trace after** will trace what happens after the selected line is executed.
- **Trace before** will trace what happens before the selected line is executed.
- **Trace about** will trace what happens before and after the selected line is executed.
- **Trace until** will trace what happens before the selected line is executed. When the selected line is reached, execution is stopped automatically.

To start a trace using the command line

A trace measurement is started on the first *Program Step* or *Program Run* command following the specification of a trigger or storage qualifier, or after a *Trace Again* command.

The *Trace Again* command starts the trace using the last trace specification you set up or the default trace specification if you have not set up a trace in the current debug session. The default specification is:

```
Trace StoreQual None
```

```
Trace Trigger Never
```

The default specification causes the trace to execute continuously, storing all bus states in the trace buffer, until you stop the trace by entering the command:

```
Trace Halt
```

If you have set up a trace specification, the trace function behavior is determined by your specification.

The debugger must be in command mode (your target program is halted and the word *Command* is displayed on the status line) in order for you to enter a trace command.

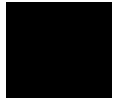

To stop a trace in progress

- Using the command line, enter:

```
Trace Halt
```

And press the < **Return** > key.

If the trace trigger specification is defined to be *Trace Trigger Never*, the trace function will run continuously until you halt the trace.

If you have defined a trace trigger specification, the trace function stops automatically when the trace trigger specification is detected and the trace buffer is full.

To display a trace

- Select **Window**→**Trace**.
- Or:
- In the emulator/analyzer window, select **Display**→**Trace**.
- Or:
- Using the command line, enter:

`Trace Display`

And press the **<Return>** key.

The default trace display shows the high-level program source lines corresponding to the trace states and entries and exits from modules.

Display options allow you to display entry to and exit from modules, assembly language instructions, data read and write cycles, and the raw uninterpreted data collected by the trace function.

The *Line(s)* option allows you to specify a range of lines in the trace buffer to be copied to a specified debugger window or the first state to be displayed in the trace window.

Examples

To view source lines, their corresponding assembly language instructions, and data read and write cycles:

`Trace Display Modules Source Assembly Data`

To copy the raw data in lines -20 through +20 of the trace buffer to a log file you have opened:

`Trace Display Lines -20..20 <Tab> Raw OutputTo 28`

28 is the window number for the log file.

To display the raw data starting with the trigger state in the trace window and cause the debugger to enter trace mode:

```
Trace Display Lines 0 <Tab> Raw
```

To exit trace mode, press the < Esc > key twice. This action returns the debugger to command mode where you can enter commands from the keyboard.

To specify trace events

- Using the command line, enter:

```
Trace Event Specify <event_nmbr> <Tab>  
<event_definition>
```

And press the < Return > key.

You use trace events as terms in the trace trigger specification and in the storage qualification specification. The event definition can be address values, data values, status values, or a logically AND'ed combination of the above.

Examples

Address event. To define event 1 to be the address of function `update_state_of_system`:

```
Trace Event Specify 1 <Tab> Address Is  
update_state_of_system
```

Status event. To define event 2 to be any bus cycle corresponding to an instruction fetch from supervisor memory space:

```
Trace Event Specify 2 <Tab> Status Is FnCde Supr CycTyp  
Fetch
```

Combined address and status event. To define event 3 to be a write access of variable `current_humid`:

Chapter 6: Making Trace Measurements
To delete trace events

```
Trace Event Specify 3 <Tab> Address Is  
&current_humid <Tab> Status Is Write
```

To delete trace events

- Using the command line, enter:

```
Trace Event Delete <event_nmbr>
```

Enter the number of the event you wish to delete, and press the **< Return>** key.

If you attempt to delete an event that is assigned to a storage qualification term or trigger term, the debugger will display an error message on your screen. You cannot delete events that are assigned as storage qualifiers or trigger terms. You can, however, modify these events by entering a new specification.

Examples

To delete event 2:

```
Trace Event Delete 2
```

To specify storage qualifiers

- Using the command line, enter:

```
Trace StoreQual Event <event_nmbr>
```

Enter the number of the event previously defined with the Trace Event Specify command, and press the **< Return>** key.

You can specify a single event or an OR 'ed combination of events in the trace storage qualification specification.

If you specify the Prestore function, the trace function stores the two instruction fetch bus cycles immediately preceding the qualified states being stored.

Examples

To store either of two events:

```
Trace Event Specify 1 <Tab> Address Is  
update_state_of_system
```

```
Trace Event Specify 3 <Tab> Address Is  
&current_humid <Tab> Status Is Write
```

```
Trace StoreQual Event 1 <Tab> Or 3
```

The debugger will then store calls to function *update_state_of_system* or write accesses to variable *current_humid*.

To store accesses to *update_state_of_system* along with the two bus cycles immediately preceding the accesses:

```
Trace StoreQual Address Is update_state_of_system <Tab>  
Prestore
```

The prestore operation helps you determine what instructions caused an access to a variable or function.

Note that in the preceding example, we defined the qualifying event in the Trace StoreQual command rather than using an event defined previously with the Trace Event Specify command. When you define the qualifying event in the Trace StoreQual command, you can specify only a single event. You cannot use an OR'ed combination of events as the storage qualification condition.

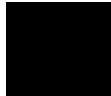

To specify trigger conditions

- Using the command line, enter:

```
Trace Trigger Event <event_nmbr>
```

Enter the number of the event previously defined with the Trace Event Specify command, and press the <Return> key.

You can specify a single event, an OR'ed combination of events, a specified number of occurrences of a single event or an OR'ed combination of events, or a sequence of events (maximum of seven) in the trace trigger specification. If you specify a sequence of more than seven events, the debugger will respond with an error message indicating that the specification is too complex.

You can define the trigger event in the Trace Trigger command rather than using an event defined previously with the Trace Event Specify command. When you define the qualifying event in the Trace Trigger command, you can specify only a single event. You cannot use an OR'ed combination of events, a sequence of events, or multiple occurrences of an event as the trigger condition.

Examples

Trigger on a single event. To trigger on the occurrence of a call to function *update_state_of_system*:

```
Trace Event Specify 1 <Tab> Address Is  
update_state_of_system
```

```
Trace Trigger Event 1
```

Trigger on a sequence of events. To trigger on a call to function *update_state_of_system* followed by a write access to variable *current_humid*:

```
Trace Event Specify 1 <Tab> Address Is  
update_state_of_system
```

```
Trace Event Specify 3 <Tab> Address Is  
&current_humid <Tab> Status Is Write
```

Chapter 6: Making Trace Measurements
To halt program execution on the occurrence of a trigger

```
Trace Trigger Event 1 <Tab> Then 3
```

Trigger on an OR'ed combination of events. To trigger on a call to function *update_state_of_system* or a write access to variable *current_humid*:

```
Trace Event Specify 1 <Tab> Address Is  
update_state_of_system
```

```
Trace Event Specify 3 <Tab> Address Is  
&current_humid <Tab> Status Is Write
```

```
Trace Trigger Event 1 <Tab> Or 3
```

Trigger on the nth occurrence of an event. To trigger on the fifth call to function *update_state_of_system*:

```
Trace Trigger Event 1 <Tab> Count 5
```

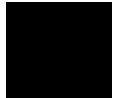

To halt program execution on the occurrence of a trigger

- Enter the keyword *BrkOnTrg* in your trace trigger specification to halt program execution on occurrence of the trigger condition.

Examples

To break on a write to memory location *current_humid*:

```
Trace Trigger Event 3 <Tab> BrkOnTrg PosnTrig End
```

When you start your program, the debugger will execute the program until the trigger condition is detected. Then the debugger will halt the program. The keywords *PosnTrig End* cause the trigger to be stored at the end of the trace buffer, allowing you to view events leading up to the trigger.

To remove a storage qualification term

- Using the command line, enter:

```
Trace StoreQual None
```

And press the < **Return** > key.

This command restores the storage qualification to its default value, that is, all bus cycles will be stored in the trace buffer. If you specified events defined with the Trace Event Specify command, the events are removed from the storage qualification specification, but remain defined.

To remove a trigger term

- Using the command line, enter:

```
Trace Trigger Never
```

And press the < **Return** > key.

This command restores the trace trigger to its default value. Events in trigger terms defined with the Trace Event Specify command are disabled as trigger terms, but are not removed as events. The Trace Trigger Never command causes the trace function to never trigger. The trace will run continuously until you stop the trace using the Trace Halt command.

To trace code execution before and after entry into a function

- 1 Specify the trigger condition.

```
Trace Trigger Address Is function_name <Tab> Status Is  
FnCde Prog PosnTrig Center
```

- 2 Run the program.
- 3 When the trace is completed (the command line will contain the message *TRC: Cmp1t*), press **CTRL C** to halt program execution and enter command mode.
- 4 Display the trace data.

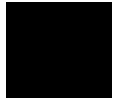

To trace data written to a variable

- 1 Define trace event 1 to be a write access to the range of addresses corresponding to the variable.

```
Trace Event Specify 1 <Tab> Address Is  
&variable..+sizeof(variable)-1 <Tab> Status Is Write
```

By using the **sizeof** operator, we can specify an address range the size of the variable to ensure that we capture all bytes of *variable*.

- 2 Assign *variable* as the trigger and storage qualification terms.

```
Trace Trigger Event 1
```

```
Trace StoreQual Event 1
```

To trace data written to a variable and who wrote to the variable

3 Start program execution.

4 Complete the trace.

The the TRC status on the status line will change to `TRC:Trgrd` to indicate that the first write has taken place.

You may do one of two things to complete the trace:

- To see a full buffer of writes, wait until the status changes to `TRC:Cmplt`.
- To see the trace without waiting, press `<Ctrl> -C` to return to command mode, then halt the trace by entering:

```
Trace Halt
```

5 Display the trace information.

To trace data written to a variable and who wrote to the variable

1 Define trace event 1 to be a write access to the range of addresses corresponding to the variable.

```
Trace Event Specify 1 <Tab> Address Is  
&variable..+sizeof(variable)-1 <Tab> Status Is Write
```

2 Assign the variable as the trigger and storage qualification terms.

```
Trace Trigger Event 1
```

```
Trace StoreQual Event 1 <Tab> Prestore
```

Note that we added the *Prestore* keyword to the Trace StoreQual command. The *Prestore* keyword in the storage qualification definition will cause the trace function to capture the last two fetch cycles before the write to *current_humid*, enabling you to see which routine is writing to the variable.

To trace events leading up to writing a particular value in a variable

3 Start program execution.

4 Complete the trace.

The the TRC status on the status line will change to `TRC:Trgrd` to indicate that the first write has taken place.

You may do one of two things to complete the trace:

- To see a full buffer of writes, wait until the status changes to `TRC:Cmplt`.
- To see the trace without waiting, press `<Ctrl> -C` to return to command mode, then halt the trace by entering:

```
Trace Halt
```

5 Halt the trace measurement.

6 Display the trace information.

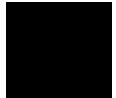

To trace events leading up to writing a particular value in a variable

To trace events leading up to writing the value 0 (zero) to the element *seconds* in a structure pointed to by *time*, perform the following steps.

1 Define event 1 to be the write of a data value of 0 to the least-significant word of the integer value *seconds*.

```
Trace Event Specify 1 <Tab> Address Is
&time_struct.seconds <Tab> Data Is 0 <Tab> Status Is
Write
```

2 Assign event 1 to be the trace trigger, and position the trigger at the end of the trace buffer so that states leading up to the trigger will be captured.

```
Trace Trigger Event 1 <Tab> PosnTrig End
```

To execute a complex breakpoint using the trace function

- 3 Disable any storage qualification terms to cause the trace function to store all states.

```
Trace StoreQual None
```

- 4 Start program execution and the trace.

```
Program Run
```

- 5 When the trace is completed (the command line will contain the message *TRC: Cmp1t*), press **CTRL C** to halt program execution and enter command mode.

- 6 Display the trace information.

To execute a complex breakpoint using the trace function

The trace function can be used to execute a complex breakpoint in your target program.

Example

- 1 Define event 6 to be a write of value 0x3c (60 decimal) to the least-significant word of the integer value *seconds*.

```
Trace Event Specify 6 <Tab> Address Is  
&time_struct.seconds <Tab> Data Is 0x3c Status Is Write
```

- 2 Define event 7 to be a write to the least-significant word of the integer value *minutes*.

```
Trace Event Specify 7 <Tab> Address Is  
&time_struct.minutes <Tab> Status Is Write
```

Chapter 6: Making Trace Measurements To trace entry to and exit from modules

- 3 Define the trace trigger as event 6 followed by event 7, and position the trigger at the center of the trace buffer so that states leading up to the trigger and following the trigger will be captured.

```
Trace Trigger Event 6 <Tab> Then 7 <Tab> BrkOnTrg  
PosnTrig Center
```

The keyword *BrkOnTrg* causes the debugger to halt program execution when the trigger condition is detected.

- 4 Start the trace measurement.

```
Program Run
```

The program will run until the trigger condition is detected and then halt.

- 5 Display the trace buffer.

```
Trace Display Line(s) 0 <Tab> Source Assembly Data
```

Note that the minutes count is updated at line 0 in the trace display. The trigger specification has allowed us to see the program activity leading up this event. Press the **Return** key or **F7** function key to scroll through the data source line by source line. Note that the highlighted line in the code window tracks the first line displayed in the trace display. Press the **F6** function key to change the direction of tracking in the trace display.

To trace entry to and exit from modules

- 1 Define event 5 to be any instruction fetch with an opcode value of *4e5x* where *x* is a don't care value.

```
Trace Event Specify 5 <Tab> Data Is 0x4e50 &= 0xffff0  
<Tab> Status Is CycTyp Fetch
```

Chapter 6: Making Trace Measurements

To trace entry to and exit from modules

The don't care condition is specified by specifying a mask in the data specification. `&=` is the mask operator. This value corresponds to the LINK and UNLK instructions.

- 2 Define event 5 as the trace storage qualifier.

```
Trace StoreQual Event 5
```

- 3 Restore the trace trigger to its default value.

```
Trace Trigger Never
```

- 4 Start the program and trace.

```
Program Run
```

- 5 Let the program run for a moment, then press **CTRL C** to halt program execution and enter command mode.

- 6 Stop the trace measurement.

```
Trace Halt
```

- 7 Display the trace information.

```
Trace Display Modules Assembly
```

The display should show entries and exits of modules and the assembly code that was captured in the trace buffer. The code should consist of only LINK and UNLK instructions.

Note

This method of viewing entries and exits of modules may not work for all code. It will depend on how your compiler generates code and which compiler options you choose.

If tracing is not triggered as expected

If you are using 16-bit memory, you need to make fetches appear to be on longword boundaries. Use the command line Debugger Option Trace Fetch_Align command to mask the fetch addresses.

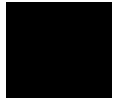

Chapter 6: Making Trace Measurements
If tracing is not triggered as expected

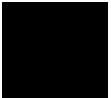

7



Editing Code and Data

How to use the debugger to make permanent or temporary changes to source code, memory contents, and registers.

Editing Files

The graphical interface gives you a number of context-dependent and context-independent editing commands. From several screens, you can bring up the source file that contains the source line or symbol you are viewing in the display.

The interface will choose the “vi” editor as its default editor, unless you specify another editor by setting an X resource. Refer to the chapter “Configuring the Debugger” for more information about setting this resource.

Remember to re-compile

When you use the editor to change a source code file, you will need to re-compile the source file. You can recompile with a click of the mouse if you define the **Make** action key to compile the target program.



To edit source code from the Code window

- Place the mouse pointer over the line you want to edit. Select **Edit source** from the Code window pop-up menu.

The debugger will start the editor in a new X window. The cursor in the editor window will be on the same line of code as the mouse pointer in the Code window.

After editing the file, you quit the edit session by the standard method for the editor used.

You will need to re-compile the source file. You can recompile with a click of the mouse if you define the **Make** action key to compile the target program.

To edit an arbitrary file

- 1 Select **File**→**Edit**→**File**.
- 2 Using the file selection dialog box, enter the name of the file you wish to edit; then, click on the OK pushbutton.

After editing the file, you quit the edit session by the standard method for the editor used.

To edit a file based on an address in the entry buffer

- 1 Place an address reference (either absolute or symbolic) in the entry buffer.
- 2 Select **File**→**Edit**→**At () Location**.

The interface determines which source file contains the code generated for the address in the entry buffer and opens an edit session on the file.

To edit a file based on the current program counter

- Select **File**→**Edit**→**At PC Location**.

The interface determines which source file generated the address currently in the program counter and opens an edit session on that source file. The interface will issue an error if it cannot find a source file for the address in the PC.

Patching Source Code

When you change source code by editing the C source file, you need to re-compile.

The debugger provides several ways to patch your program without re-compiling:

- Change a variable's value using a C expression.
- Apply a patch using a breakpoint macro.

To change a variable using a C expression

- 1 Enter a C expression in the entry buffer.

A good way to do this is to highlight an expression from your source code using the left mouse button. When you release the button, the expression will appear in the entry buffer. Now edit the expression to have the desired value.

- 2 Click on the **C Expr ()** action key. Or select **Display→C Expression** from the menu bar.

The value of the variable will be changed until the program modifies it. You can continuously monitor the variable's value if you display it in the Monitor window (use the **Monitor ()** action key or the **Expression Monitor Value** command).

Or:

- Using the command line enter:

```
Expression C_Expression <expression>
```

To patch a line of code using a macro

- 1 Set a breakpoint at the line you wish to patch.

An easy way to set the breakpoint is to click the right mouse button on the line in the Code window.

- 2 Attach a macro to the breakpoint.

Choose **Attach Macro ...** from the Code window pop-up menu.

- 3 Write a macro to patch the code.

In the Macro Operations dialog box, enter the name of a new macro and click on the **Edit** button.

The macro may contain any number of C expressions and debugger commands.

The last two lines of the macro should be:

```
$Modify Register @PC = #next_line$;  
return(1)
```

where *next_line* is the number of the line after the breakpoint. Return 0 instead of 1 if you want the debugger to stop after the macro is executed.

Exit the editor as usual, then click on the **Attach** button in the Macro Operations dialog box.

Now whenever the breakpoint line is encountered, the debugger will execute the macro before the patched line is executed. The macro will execute your patch code, then skip to the next line.

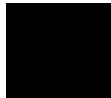

To patch C source code by inserting lines

- 1 Define a macro containing the inserted statements. The macro must provide a return value of 1 (true) in order for the program to continue after the macro is executed.
- 2 Set a breakpoint on the C line following the point where the insertion should occur and attach the macro to the breakpoint.
- 3 Start your program.

The program will run until the breakpoint is encountered. The debugger will then interpret and execute the C statements in the macro, and continue executing the program.



To patch C source code by deleting lines

- 1 Write a macro that sets the program counter to point to the first line of code beyond the lines of code that you want to delete. The macro must provide a return value of 1 (true) in order for the program to continue after the macro is executed.
- 2 Set a breakpoint on the first line to be deleted and specify the macro with that breakpoint.
- 3 Start your program.

The program will run until the breakpoint is encountered. The macro will then set the program counter to the line specified in the macro. Program execution will then continue, skipping the program lines between the breakpoint and line specified in the macro.

Example

Consider the following code:

Chapter 7: Editing Code and Data
To patch C source code by deleting lines

```
25     count = 5;
26     for (i=0; i < MAXNUM; i++)
27     {
28         array[i]=1;
29         count=count+2;
30         k=count*i;
31     }
```

To delete lines 29 and 30, and insert a new line incrementing *count* by one, you could write the following macro:

```
Debugger Macro Add patch_29()
{
    count++;
    $Expression C_Expression @PC = #31$;
    return(1);
}
.
```

To execute the code patch, enter the command:

```
Breakpt Instr #29;patch_29()
```

and run your program.

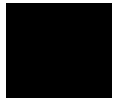

Editing Memory Contents

This section shows you how to:

- Change memory location values.
- Copy a block of memory.
- Fill a block of memory with values.
- Compare two blocks of memory.
- Change the contents of a register.
- Unload BBA data from program memory.

To change the value of one memory location

- 1 Select **Modify**→**Memory**.

Or, using the command line, enter:

```
Memory Assign <Size>
```

- 2 Using the command line, select either Byte, Word, or Long as the size of the memory location, and enter the expression that assigns a value to an address, and press the < **Return** > key.

To change the values of a block of memory interactively

- 1 Select **Modify**→**Memory**.

Or, using the command line, enter:

```
Memory Assign <Size>
```

- 2 Using the command line, select either Byte, Word, or Long as the size of the memory location, enter the address of the beginning of the block, and press the < **Return** > key.

This starts the interactive memory modification mode.

- 3 Enter the value for the location displayed in the Journal window and press the < **Return** > key.
- 4 To exit this mode, press the < **Return** > key without entering a value.

Example

To display the contents of memory location 1000h and allow interactive modification of memory contents:

```
Memory Assign Byte 1000h  
00001000 = 0x48 72:
```

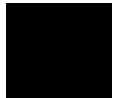

To copy a block of memory

- 1 Using the command line, enter:

```
Memory Block_Operation Copy
```
- 2 Enter the address range of the memory to be copied, followed by a comma.
- 3 Enter the starting address of the destination and press the < **Return** > key.

Example

To copy the block of memory starting at address 1000h and ending at address 10ffh to a block of the same size starting at address 5000h:

```
Memory Block_Operation Copy 1000h..10ffh,5000h
```

To fill a block of memory with values

- Using the command line, enter:

```
Memory Block_Operation Fill <Size>
```

Select either Byte, Word, or Long as the size of the memory locations, enter the expression that assigns a value to locations in a range of addresses, and press the <Return> key.

Example

To fill memory locations 1000h through 1007h with the long pattern 61626364, 65666768:

```
Memory Block_Operation Fill Long 0x1000..+7='abcdefgh'
```

To compare two blocks of memory

- Using the command line, enter:

```
Memory Block_Operation Match <Mismatch_Operation>
```

Select either Repeat_On_Mismatch or Stop_On_Mismatch to specify what happens when a mismatch is found, enter the address range to be compared and the starting address of the range that it is compared to; then, press the <Return> key.

Example

To compare the block of memory starting at address 1000h and ending at address 10ffh with a block of the same size beginning at address 5000h and stop when a difference is found:

```
Memory Block_Operation Match Stop_On_Mismatch  
1000h..10ffh,5000h
```

To re-initialize all program variables

- Select **File**→**Load**→**Program Only ...**, then use the File Selection dialog box to select the absolute file.

Or:

- Using the command line, enter:

```
Program Load New Code_only No_Pc_Set <absolute_name>
```

Enter the name of the absolute file whose code is to be loaded, and press the **< Return >** key.

The code will be loaded without loading symbols or resetting the PC.

The debugger does not save the initial values of variables. The only way to restore the initial values is to re-load the program. After re-loading the program, you may need to restore some debugger settings; for example, you might need to re-specify variables for the Monitor window.

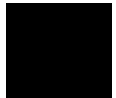

To change the contents of a register

- Select **Modify**→**Register**. This will display the Modify Register dialog box.

Or:

- Using the command line, enter:

```
Memory Register
```

On the command line, enter the name of the register and the value to which the register's contents should be changed, and press the **< Return >** key.

Registers may also be modified by using "@register" in a C_expression.

Chapter 7: Editing Code and Data
To change the contents of a register

Example

To modify register values interactively:

Memory Register

The program counter (PC) is displayed in the journal window. You can modify the PC by entering a value (10a4h in this example) at the cursor prompt and pressing < **Return**> . The PC will be modified, and the next register will be displayed:

```
@pc      = 0x000010B8      4280: 10a4h
@sp      = 0x00015DB4      89524:
```

Press < **Return**> without entering a value to exit this mode.

To set the value of register @d1 to 44h:

Memory Register @d1=0x44

To interactively change the value of register @d1:

Memory Register @d1



Using Macros and Command Files

How to use macros and command files to make debugging easier.

Chapter 8: Using Macros and Command Files

The debugger provides several ways for you to simplify tasks that you do often.

- **Macros** are C-like functions. You can call macros individually, attach them to breakpoints, or automatically execute them with each program step. Macros are especially useful for temporarily patching C code.
- **Command files** contain series of debugger commands. The debugger can read a command file and execute the commands found there as if they were entered directly into the interface command line. Command files are useful for setting up the debugger, for executing a program to a certain point, and for automated testing.
- **Action keys** are shortcut definitions or "hotkeys" which allow you to add new commands to the graphical interface. Action keys are useful for simplifying frequently-used commands, for making the debugger easier to use for co-workers who do not frequently use a debugger, and for making the debugger into a framework for demos and tutorials.



Using Macros

A macro is a C-like function consisting of debugger commands and C statements and expressions.

Macros are most often used to:

- Patch C source code.
Often, bugs found with the debugger can be temporarily patched with C source statements in macros. You do not have to exit the debugger, edit the source code, recompile and link, and then reenter the debugger. Instead, you can make a temporary patch by using breakpoint macros.
- Return values to expressions.
- Create conditional breakpoints.
- Execute commands after each program step command.
- Execute a set of commands.

Macros can:

- Have input parameters (macro arguments).
- Define macro local variables.
- Contain C statements and expressions.
- Refer to target variables and registers.
- Refer to user-defined variables.
- Have return values.
- Call other macros.
- Can be used in expressions (if they return values).
- Execute most debugger commands.

Macros cannot:

- Define global variables.
- Define static variables.
- Be recursive.
- Define other macros.
- Contain the conditional operator (expression ? expression : expression).

Macros can be called:

- By specifying the macro name in an expression.
- By calling the macro from within another macro.
- With the Debugger Macro Call command.
- With the Breakpt command.
- With the Program Step With_Macro command.

Chapter 8: Using Macros and Command Files

Using Macros

This section shows you how to:

- Define a macro.
- Call a macro.
- Stop a macro.
- Display macro source code.
- Patch C source code by using macros.
- Delete a macro.

Saving and re-using macros

You can define and save macros interactively during a debugger session.

Macro limits

The maximum number of characters that can be entered on a line in a macro definition is 255. When entering macro interactively, the debugger does not respond to more than 78 characters on a line. When reading a command file, the debugger stops recognizing characters after 255 characters have been read on a line.

The maximum number of lines allowed in a macro depends on the complexity of the lines. Macros with too many lines (too complex) will fail. Error 92 "*Not enough memory for expression*" will be displayed.

A maximum of 40 parameters may be specified in a macro definition.

Once you have defined a macro, you can use it any time during the debugging session, whenever that set of commands or statements is needed.

Caution

The pseudoregister `@cycles` is not implemented in the emulation environment. Macros written for execution in both the simulation and emulation environments must not refer to `@cycles`.

Macro comments

Macros support C comments (introduced by the characters `/*` and terminated with the characters `*/`).

Macro arguments

You can use formal macro arguments throughout the macro definition. They are replaced at execution time by the actual parameters present in the macro call. The actual parameter is coerced to the corresponding formal parameter type. If coercion is not possible, an error occurs.

You must list the macro's arguments (if any), along with their associated types, when you define the macro. For example, the following listing defines arguments for the built-in macro `strcpy()`:

```
Debugger Macro Add int strcpy(target, source)
char *target;
char *source;
```

Macro variables

Variables that are local to the macro may be created within the macro. The definition of local variables follows the rules of C, with the exception that you cannot define variables with initializers. Variables may be defined to have a simple type, or they may be of type array or pointer. Derived types (such as structures and unions), enumerated types, and typedefs are not legal within macros.

The macro processor does not recognize the C keywords `extern`, `auto`, `static`, and `register`. The macro processor reports an error if these C keywords are used. Static variables are not scoped within a macro. However, symbols created with the Symbol Add command (debugger symbols) are globally scoped, and can be accessed from within a macro. Register variables (such as `@PC`) may also be accessed from within a macro.

Target program symbols can also be accessed from within a macro. Variables which are globally scoped within the target program can be accessed directly. File static, function static, and automatic variables can be accessed directly only if the current context of the debugger is the module or function in which they are scoped. Otherwise, they require a module or function name as a qualifier before they can be accessed. For example, assume the following definition exists in your target program, in a file called `init.c`:

```
...
static int i;          /* file static */
...
foo(int parm)
{
    static int j;      /* function static */
    auto int k;        /* function local */
...
}
```

```
}  
...
```

If a macro is executed while the PC is pointing into the function `foo()`, variables `i`, `j`, and `k` can be directly accessed. If this is not the case, `i` must be accessed with a module qualifier, such as `init|i`. The function static `j` must be accessed as `init|foo|j`. The automatic `k` can be accessed as `init|foo|k` if the stack frame for `foo()` is alive.

Macro control flow statements

Macros support the following C control flow statements:

- If-else
- While and For
- Do-while
- Break and Continue in While, For, and Do statements.

However, macros cannot contain conditional expressions of the form:

```
<expression>?<expression>:<expression>
```

Macro return values

Macros support the C “return” statement for returning values.

If a breakpoint macro returns a nonzero value, program execution continues. If it returns a zero value, program execution is halted. If a macro does not return a value, it should be declared as void when it is defined.

Macros containing debugger commands

You can create macros that contain only a sequence of debugger commands. Macros containing only debugger commands are similar to command files. You can use these macros to set up complex initialization conditions.

You cannot use the following commands in macros:

- Program Run
- Program Step
- Program Step Over
- Debugger Host_Shell
- Debugger Macro Add
- Symbol Add
- Symbol Remove

- File Command
- Debugger Quit

To display the Macro Operations dialog box

- Select **Breakpoints**→**Edit/Call Macro** from the menu bar.

Or:

- Select **Attach Macro** from the Code window pop-up menu.

The Macro Operations dialog box allows you to call predefined macros, edit or call existing user-defined macros, and create new macros.

To define a new macro interactively using the graphical interface



- 1 Display the Macro Operations dialog box.
- 2 Move the mouse pointer to the Selected Macro entry area.
- 3 Type < **Ctrl**> **-U** to clear the Selected Macro entry area, then type the name of the macro you wish to create.

When you press < **Return**> or click on the **Edit** button, the debugger will display an editor window.

A "skeleton" macro will appear in the editor window.

- 4 Edit the macro definition.

Chapter 8: Using Macros and Command Files

Using Macros

When you exit the editor, save the macro under the default name. If you save it under a different name, the macro may be lost.

See Also

See "To use an existing macro as a template for a new macro" if you want to use an existing macro as the basis for a new macro.

Example

To create an macro called "test_macro", select **Breakpoints**→**Edit/Call Macro** and enter "test_macro" in the Selected Macro area. Now press < **Return**> or click on the **Edit** button. Edit the macro in the editor window. If you are using the **vi** editor, exit using the "ZZ" command. The new macro should now appear at the end of the Defined Macros list.

To use an existing macro as a template for a new macro

- 1 Display the Macro Operations dialog box.
- 2 In the dialog box, select the macro you wish to use as a template.
- 3 Click on the **Edit** button.
- 4 In the editor, change the name of the macro.

Now you may edit the parameters and body of the macro.

When you exit the editor, the macro will be saved under the new name. The original macro will not be changed.

To define a macro interactively using the command line

- 1 Enter the Debugger Macro Add command followed by an optional return type, and then a macro name. The macro name must be followed by parentheses; the parentheses can optionally enclose macro arguments separated by commas.

```
Debugger Macro Add [<type>] <name> ([parm,parm,...])  
[<parm_types>;]
```

- 2 Enter the text of the macro body.

```
{  
  [[<C_expr>|<C_stmt>|<debugger_cmd>];...]  
}
```

- 3 End the macro definition with a period as the first and only character on a line. The macro is checked for syntax errors as soon as the period is encountered. If an error is found within a macro, the macro definition is not saved. The macro must be completely reentered.

Your completed macro definition should have the following syntax:

```
Debugger Macro Add [<type>] <name> ([parm,parm,...])  
[<parm_types>;]  
{  
  [[<C_expr>|<C_stmt>|<debugger_cmd>];...]  
}  
.
```

Debugger commands can be embedded in the macro by enclosing the commands between \$ characters. For example,

```
$Expression C_Expression @PC = #31$;
```

No standard C library functions are available from within a macro. However, there are built-in macros available in the debugger that perform similar functions (refer to the "Predefined Macros" chapter).



To define a macro outside the debugger

- 1 Using a text editor on your host system, define the macro.
- 2 Save the macro definition in a command file (< filename> .com).
- 3 Start the debugger.
- 4 Load the command file into the debugger using the File Command command.

As the macro is loaded into the debugger, the macro processor parses the macro, looking for syntax errors. If the macro definition contains no errors, it is loaded into the debugger's symbol table.

If an error is detected, the macro processor reports the error and quits loading the command file. The macro remains undefined.

The number of macros that you can define is limited only by the available memory on your host computer system.

To edit an existing macro

- If you want to edit a macro attached to a breakpoint, select **Edit Attached Macro** from the Code window pop-up menu.

Or:

- 1 Display the Macro Operations dialog box.
- 2 Select the macro you want to edit.
- 3 Click on the Edit button.

Remember to save the macro under the default file name when you leave the editor (use the "ZZ" or ":wq!" command in **vi**).

To save macros

- Select **File→Store→User-Defined Macros...**

The File Selection dialog box will be displayed so that you can choose a file in which to save the macros. The debugger will automatically add a *.com* extension to the file name.

The debugger will save all of the your user-defined macros to a file.

The debugger does not provide a way to save only selected macros. If you want to save macros in separate files, you can create the macros using a text editor.

To load macros

- Select **File→Load→User-Defined Macros...**

Choose the macro file to load from the File Selection dialog box.

If macros do not load

- Check that the macros do not directly access local program variables.

When the debugger loads macros which access local program variables, the debugger does not know which local scope to use to define the macro.

If you need to access local program variables in a macro, pass them to the macro as parameters.

To call a macro

- Select **Breakpoints**→**Edit/Call Macro ...**→**Call**.

Or:

- Using the command line, enter:

```
Debugger Macro Call
```

Enter the name of the macro to be called, and press the < **Return** > key.

When a macro is called with the Debugger Macro Call command, its return value is ignored. Macros are typically called in this manner for the side effects they generate.

Example

If you have the following macro definition:

```
Debugger Macro Add void stackchk()  
{  
  /* The symbols 'stack' and 'TopOfStack' exist in the compiler's */  
  /* environment library, and are addresses which indicate the   */  
  /* bottom and the top of the system stack. The symbol @sp is a */  
  /* debugger reserved symbol which contains the current value of */  
  /* the processor's stack pointer.                               */  
  
  $Expression Printf "%d bytes of stack used", TopOfStack - @sp$;  
  $Expression Printf "%d bytes of stack available", @sp - stack$;  
}  
.
```

the command:

```
Debugger Macro Call stackchk()
```

displays, in the journal window, the amount of stack used and the amount of stack left.

To call a macro from within an expression

- Enter a macro call as part of any expression entered on the command line of the debugger.

The debugger will evaluate the macro and use its return value when evaluating the rest of the expression.

Example

If you have the following macro definition:

```
Debugger Macro Add int power(x,y)
int      x;
int      y;
{
    int      i;          /* Loop counter */
    int multiplier;     /* Value x is multiplied by */

    /* Multiply x by itself y -1 times */
    for (i = 1, multiplier = x; i < y;i++)
        x *= multiplier;

    /* Return x ^y */
    return x;
}
.
```

The command:

```
Expression Display_Value 33.3 + power(2,3)
```

will call and evaluate the macro, displaying the value 41.3 in the debugger's journal window.

To call a macro from within a macro

- You can call a macro from within a macro when they are part of an expression.

The following restrictions apply to calling macros from within a macro:

- The macro called must have been previously defined.

Chapter 8: Using Macros and Command Files

Using Macros

- The macro cannot call itself.

Example

If you have the following macro definition:

```
Debugger Macro Add int ten_to_the(y)
int      y;
{
    return power(10,y); }
.
```

the macro will compute $10^{**}y$ by calling the previously defined macro *power()*.

To call a macro on execution of a breakpoint

- Select **Attach Macro** from the Code window pop-up menu.

Or:

- When using the command line to set a breakpoint, add a semicolon (;) and the name of the macro to the command.

When setting breakpoints, you can attach a macro to the breakpoint. Whenever the breakpoint is encountered, the macro is executed. Depending on the return value of the macro, program execution will either stop or continue.

- If the macro returns zero, program execution stops at the breakpoint.
- If the macro returns a nonzero value, program execution continues at the breakpoint.

Macros attached to breakpoints can test program or user-defined variables before determining whether execution should break or not (by returning zero or nonzero values, respectively).

Macro control flow statements within a breakpoint macro can alter execution flow in the target environment based on target or debugger variable values. You can also include C expressions in macros. By using control flow statements and C expressions in macros, you can patch your C programs.

Example

The following example shows how return values can be used to conditionally control a breakpoint. The example uses the Debugger Macro Add and Breakpt Write commands to define a breakpoint that occurs only when the target variable `days` becomes greater than 31.

```
Debugger Macro Add int daycheck()
{
    if (days > 31)
        return 0;
    else
        return 1;
}
.
Breakpt Write &days; daycheck()
```

When the break occurs, the macro is executed. If `days` is less than or equal to 31, program execution continues. If `days` is greater than 31, program execution stops.

If you have the following macro definition:

```
Debugger Macro Add int break_when(stopfunction, min, max)
char    *stopfunction;
int     min;
int     max;
{
    /* Debugger symbol @function is a char pointer to the name */
    /* of the current function. Compare the current function */
    /* with the function name passed, using the built-in macro */
    /* memcmp(). */
    if (!strcmp(@function, stopfunction))
    if ((global_var > min) && (global_var < max))
    {
        $Expression Printf "global_var: %d\n", global_var;
        return 0;
    }
    /* Not in specified function, return 1 so that program will */
    /* continue executing. */
    return 1;
}
.
```

the command:

```
Breakpt Write &global_var; break_when("foo", 256, 512)
```

will set a write breakpoint on the global variable `global_var`. Whenever the program writes to `global_var`, the macro `break_when()` is executed with the parameters `"foo"`, `256`, and `512`. The macro returns the value 1 until the value of `global_var` falls between 256 and 512 because of a write to `global_var` in the function `foo()`. The macro then returns 0, causing the program to halt.

To call a macro when stepping through programs

- Select **Execution**→**Step**→**with Macro ...**

Or:

- Using the command line, enter:

```
Program Step With_Macro
```

Enter the name of the macro to be called, and press the < **Return**> key.

You can use the Program Step With_Macro command to execute a macro after the step occurs. Calling a macro in this manner is useful in tracking down subtle bugs.

Example

If the function *foo()* was corrupting automatic variables *index* and *ch* on the stack, the following macro and commands could be used to identify the line where the corruption was occurring:

```
Debugger Macro Add void auto_check()
{
    if ((index < 0 || index > 80) || (ch < 32 || ch > 126))
    {
        $Window Screen_On High_Level$;
        $Expression Printf "Autos corrupted!!!\n"$;
        $Expression Printf "index: %d ch: %c\n", index, ch$;
    }
}
.
```

```
Program Run Until foo
```

```
Program Step With_Macro auto_check()
```

To stop a macro

- Press **< Ctrl> -C**.

Macros can be halted during execution by pressing **< Ctrl> -C**.

Caution

< Ctrl> -C will stop execution of a macro. Pressing **< Ctrl> -C** may interrupt a code-patching macro before it completes execution. If this occurs, you cannot restart program execution within the macro where it stopped.

To display macro source code

- Choose **Edit** in the Macro Operations dialog box.

Or:

- Using the command line, enter:

```
Debugger Macro Display <macro_name>
```

Enter the name of the macro you want to display, and press the **< Return>** key.

This command will write the macro source to the journal window. If you want to write the macro source to a user-defined window or to a file, you can specify an optional user window number as the destination.

Example

To write the source for macro `auto_check()` to user window 51:

```
Debugger Macro Display auto_check() ,51
```

To delete a macro

- Using the command line, enter:

```
Symbol Remove <macro_name>
```

Enter the name of the macro you want to delete, and press the < **Return** > key.

Use the Breakpt Delete command to remove the breakpoint that called the macro.

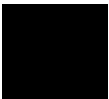

Using Command Files

A command file is an ASCII file containing debugger commands.

You can create command files from within the interface by logging commands to a command file as you execute the commands, or you can create or modify command files outside the interface with an ASCII text editor.

The debugger can read a command file and execute the commands found there as if they were entered directly into the interface command line.

Command files can also call other command files and the interface will execute the called file like a subroutine of the calling file.

This section shows you how to:

- Record commands.
- Place comments in a command file.
- Pause the debugger.
- Stop command recording.
- Run a command file.
- Set command file error handling.
- Append commands to a command file.
- Record commands and results to a journal file.
- Stop recording commands and results to a journal file.
- Open a file or device for read or write access.
- Close the file associated with a window number.
- Use the debugger in batch mode.



To record commands

- Use the `-l command_file` option to the `db68k` or `db68030` command when starting the debugger. (The debugger appends the file extension `.com` to *command_file*.)

```
$ db68k -e <emulator_id> -l <command_file> <RETURN>
```

Or:

- Select **File**→**Log**→**Record Commands**. Using the file selection dialog box, enter the name of the file to which the commands will be saved, and click on the OK pushbutton.

Or:

- Using the command line, enter:

```
File Log On
```

Enter the name of the file to which commands will be saved, and press the **< Return >** key.

All commands, whether they are entered from the menus or the command line, are recorded to the *log file*. If a command causes an error, both the command and the error code are recorded as comments.

Example

To start logging commands to file “`cmdfile1.com`”:

```
File Log On cmdfile1
```

To place comments in a command file

- Using the command line, enter:

```
File Log Comment
```

Enter the comment that should be placed in the command file, and press the **< Return >** key.

In the command file, the comment is prefixed with a semicolon (;).

When editing command files, you can also use C-style comments (introduced by the characters `/*` and terminated with the characters `*/`).

Example

To place the comment “Place this comment in a command file.” in the command file:

```
File Log Comment Place this comment in the command file.
```

To pause the debugger

- Using the command line, enter:

```
Debugger Pause
```

And press the **< Return >** key.

The debugger is paused until you enter the spacebar.

You can also specify that the debugger pause for a number of seconds by using the Debugger Pause Time command.

The Debugger Pause commands are useful when executing command files.

To stop command recording

- Select **File**→**Log**→**Stop Command Recording**.

Or:

- Using the command line, enter:

```
File Log oFF
```

And press the < **Return** > key.

The command file is closed.

To run a command file

- Use the `-c command_file` option to the `db68k` command when starting the debugger. (The *command_file* must end with the `.com` extension.)

```
$ db68k -e <emulator_id> -c <command_file> <RETURN>
```

Or:

- Select **File**→**Log**→**Playback**. Using the file selection dialog box, enter the name of the command file, and click on the OK pushbutton.

Or:

- Using the command line, enter:

```
File Command
```

Enter the name of the command file from which debugger commands will be executed, and press the < **Return** > key.

The debugger will begin executing commands found in the command file as if those commands were entered directly into the interface. The debugger will continue to execute commands until it reaches the end of the file or, perhaps, until an error occurs, depending on the command file error handling mode (see “To set command file error handling”).

To interrupt playback of a command file, press the < **Ctrl** > **-c** key combination. (If the graphical interface is being used, the mouse pointer must be within the interface window.)

Example

To start executing command from the file “cmdfile1.com”:

```
File Command cmdfile1
```

To set command file error handling

- Using the command line, enter:

```
File Error_Command <Handling_Mode>
```

Select either Abort_Read, Continue_Read, or Quit_Debugger error handling mode, and press the < **Return** > key.

When an error occurs while executing a command file:

Abort_Read causes the debugger to stop reading the command file.

Continue_Read causes the debugger to continue executing the command file with the next command.

Quit_Debugger causes the debugger session to end.

To append commands to an existing command file

- Using the command line, enter:

```
File Log Append
```

Enter the name of the file to which commands will be appended, and press the < **Return** > key.

Example

To append command to the file “cmdfile1.com”:

```
File Log Append cmdfile1
```

To record commands and results in a journal file

- Use the `-j journal_file` option to the `db68k` command when starting the debugger. (The debugger appends the file extension `.jou` to `journal_file`.)

```
$ db68k -e <emulator_id> -j <journal_file> <RETURN>
```

Or:

- Select **File**→**Log**→**Record Journal**. Enter the name of the file to which the commands and results will be saved, and click on the OK pushbutton.

Or:

- Using the command line, enter:

```
File Journal On
```

Enter the name of the file to which commands and results will be saved, and press the < **Return** > key.

Journal files are similar to command files. They contain debugger commands entered during a debug session. Journal files also contain any output generated by debugger commands. Journal files contain everything that is written to the journal window during a debug session.

Example

To start recording commands and results to file “journal1.jou”:

```
File Journal On journal1
```

To stop command and result recording to a journal file

- Select **File**→**Log**→**Stop Journal Recording**.

Or:

- Using the command line, enter:

```
File Journal oFF
```

And press the < **Return** > key.

To open a file or device for read or write access

- Using the command line, enter:

```
File User_Fopen
```

Select the open option, window number, and file name; then, press the < **Return** > key.

Chapter 8: Using Macros and Command Files

Using Command Files

After opening a file using the File User_Fopen Append or File User_Fopen Create command, you can use the Expression Fprintf command to write information to the file. Files opened for reading may be read from the built-in macro fgetc(). See the "Predefined Macros" chapter of this manual for a complete description of this macro.

The window number must be between 50 and 256 inclusive.

Use the Window Delete or the File Window_Close command to close the file.

Example

To open user window 57 and redirect any data written to window 57 to the file 'varTrace.out':

```
File User_Fopen Create 57 File varTrace.out
```

To close the file associated with a window number

- Using the command line, enter:

```
File Window_Close
```

Enter the window number associated with the file when it was opened, and press the < **Return** > key.

Example

To close the file associated with user window number 57:

```
File Window_Close 57
```

To use the debugger in batch mode

- Use the `-b` and `-c command_file` options to the `db68k` command when starting the debugger.

When using the debugger in batch mode, `stdin`, `stdout`, and `stderr` are disabled. The `-b` option must be accompanied by the `-c` option and a debugger command file. All commands are read from the command file. No user interaction with the debugger is allowed. In batch mode, the debugger can be executed as a background process. This mode is commonly used for automatic testing.

Example

```
$ db68k -b -e <emulator> -c <command_file>
```



Chapter 8: Using Macros and Command Files
Using Command Files



9



Configuring the Debugger

How to change the appearance and behavior of the debugger.

Configuring the debugger

These tasks are grouped into the following sections:

- Setting the general debugger options.
- Setting the symbolics options.
- Setting the display options.
- Modifying display area windows.
- Saving and loading the debugger configuration.
- Setting X resources.

Some options can be set using either the Debugger Options dialog box or the command line. Other options can be set only using the command line.



Setting the General Debugger Options

This section describes how to:

- Display the Debugger Options dialog box.
- List the debugger options settings.
- Change debugger options settings.

To display the Debugger Options dialog box

- Select **Settings**→**Debugger Options** from the menu bar.

You can change settings in the Debugger Options dialog box by clicking on the appropriate buttons.

To list the debugger options settings

- Select **Settings**→**Debugger Options ...**

Or:

- Using the command line, enter:

```
Debugger Option List
```

And press the < **Return** > key.

The following information is displayed:

```
> Debugger Option List
Processor      = 68EC030
Intermixed    = On
Assem_Symbols = On
```

Chapter 9: Configuring the Debugger

Setting the General Debugger Options

```
Step_Speed      = 0
Radix           = Decimal_Input, Decimal_Output
Stdio_Window    = Swap
Check_Args      = oFF
Align_Bp        = oFF
Breakpt_Window  = Swap
More            = On
Highlight       = Inverse
Frame_Stop      = oFF
Command_Echo    = oFF
View_Window     = Swap
Demand_Load     = oFF
Amt_Scroll      = 1
Trace_Counts    = Nothing
Fetch_Align     = Long
```

To specify whether command file commands are echoed to the Journal window

- Using the command line, enter:

```
Debugger Option Command_Echo
```

Select On or oFF, and press the < **Return**> key.

| | |
|-----|---|
| On | Command file commands are echoed to the Journal window. |
| oFF | Command file commands are not echoed to the Journal window. |

To set automatic alignment for breakpoints and disassembly

- In the Debugger Options dialog box, click on the Align Breakpoints button to toggle alignment.

Or:

- Using the command line, enter:

```
Debugger Option General Align_Bp
```

Select On or oFF, and press the < **Return**> key.

- | | |
|-----|---|
| On | Debugger automatically aligns breakpoints or locations to be displayed in mnemonic format to the beginning of instructions. |
| oFF | Breakpoints are not automatically aligned. |

To set backtrace display of bad stack frames

- In the Debugger Options dialog box, click on the Frame Stop button to toggle display of bad stack frames.

Or:

- Using the command line, enter:

```
Debugger Option General Frame_Stop
```

Select On or oFF, and press the < **Return**> key.

- | | |
|-----|--|
| On | Only consecutive valid stack frames are displayed. |
| oFF | All stack frames, including bad frames, are displayed. |

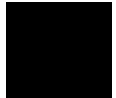

To specify demand loading of symbols

- Using the command line, enter:

```
Debugger Option General Demand_Load
```

Select On or oFF, and press the < **Return** > key.

On Symbol information is loaded on an as-needed basis.

oFF All symbol information is loaded.

To select the interpretation of numeric literals (decimal/hexadecimal)

- In the Debugger Options dialog box, hold the *command select* mouse button down on the button for "Input Radix" or "Output Radix". Release the button to select "Decimal" or "Hex".

Or:

- Using the command line, enter:

```
Debugger Option General Radix
```

Select Decimal or Hex, and press the < **Return** > key.

If you select Hex, any number you want interpreted as decimal must be terminated with a *T* (for example, specify 32 as 32T).

Binary numbers are not available when you select Hex.

Floating point and enumeration type values are not affected.

To specify step speed

- Using the command line, enter:

```
Debugger Option General Step_Speed <numb 0..100>
```

Enter the step speed number (from 0 to 100), and press the < **Return** > key.

Higher numbers represent slower speeds.

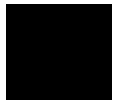

Setting the Symbolics Options

This section shows you how to:

- Display symbols in assembly code.
- Display intermixed C source and assembly code.
- Enable parameter checking in commands and macros.

To display symbols in assembly code

- In the Debugger Options dialog box, click on the Assembly Symbols button to toggle assembly symbol display.

Or:

- Using the command line, enter:

```
Debugger Option Symbolics Assem_symbols
```

Select On or oFF, and press the < **Return**> key.

On Symbols are displayed instead of addresses wherever possible.

oFF Addresses are displayed.

To display intermixed C source and assembly code

- In the Debugger Options dialog box, click on the Intermixed Source/Assembly button to toggle source display.

Or:

- Using the command line, enter:

```
Debugger Option Symbolics Intermixed
```

Select On or oFF, and press the < **Return** > key.

On Assembly code is intermixed with C source code.

oFF Only C source code is displayed.

To enable parameter checking in commands and macros

- In the Debugger Options dialog box, click on the Check Parameters button to toggle parameter checking.

Or:

- Using the command line, enter:

```
Debugger Option Symbolics Check_Args
```

Select On or oFF, and press the < **Return** > key.

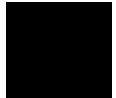

Chapter 9: Configuring the Debugger
Setting the Symbolics Options

- On When an assignment is made, the debugger warns you if the assignment contains a C type mismatch.

- oFF The debugger does not perform any argument checking.



Setting the Display Options

This section shows you how to:

- Specify the Breakpoint window display behavior.
- Specify the View window display behavior.
- Display half-bright or inverse video highlights.
- Display information a screen at a time (more).
- Specify the standard I/O window display behavior.
- Specify scroll amount.

To specify the Breakpoint window display behavior

- In the Debugger Options dialog box, hold the *command select* mouse button down on the Breakpoint Window button. Release the button to select On or Swap.

Or:

- Using the command line, enter:

```
Debugger Option View Breakpt_Window
```

Select On or Swap, and press the < **Return**> key.

On The Breakpoint window is displayed at all times.

Swap The Breakpoint window is only displayed when you set or delete a breakpoint or when you display breakpoints.

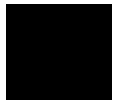

To specify the View window display behavior

- In the Debugger Options dialog box, hold the *command select* mouse button down on the View Window button. Release the button to select On or Swap.

Or:

- Using the command line, enter:

```
Debugger Option View View_Window
```

Select On or Swap, and press the < **Return**> key.

On The View window is displayed at all times.

Swap The View window is only displayed when you activate the View window or when you enter the Debugger Execution Display_Status command breakpoints.

To specify the standard I/O window display behavior

- In the Debugger Options dialog box, hold the *command select* mouse button down on the Stdio Window button. Release the button to select On or Swap.

Or:

- Using the command line, enter:

```
Debugger Option View Stdio_Window
```

Select On, oFF, or Swap; then, press the < **Return**> key.

On The Stdio window is displayed at all times.

| | |
|------|--|
| oFF | The Stdio window is only displayed when function key F6 is pressed or when the Window Screen_On Stdio command is entered. |
| Swap | The Stdio window is displayed when a program writes to it and removed when the program returns to the command mode. |

To display half-bright or inverse video highlights

- In the Debugger Options dialog box, hold the *command select* mouse button down on the Highlighting button. Release the button to select Inverse or Half Bright.

Or:

- Using the command line, enter:

```
Debugger Option View Highlight
```

Select Half_Bright or Inverse, and press the < **Return**> key.

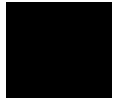

To display information a screen at a time (more)

- In the Debugger Options dialog box, hold the *command select* mouse button down on the More List Mode button. Release the button to select On or Off.

Or:

Chapter 9: Configuring the Debugger

Setting the Display Options

- Using the command line, enter:

```
Debugger Option View More
```

Select On or oFF, and press the < **Return**> key.

On Information is listed one screen at a time.

oFF Information is listed all at once.

To specify scroll amount

- Using the command line, enter:

```
Debugger Option View Amt_Scroll <numb 0..50>
```

Enter the number of lines for information to be scrolled (from 0 to 50), and press the < **Return**> key.

To store timing information when tracing

- In the Debugger Options dialog box, select a Trace Counts option.

Or:

- Using the command line, enter:

```
Debugger Option Trace Count
```

Select Time or Nothing and press < **Return**> .

| | |
|---------|---|
| Time | Use half of trace memory to store timing information. |
| Nothing | Use all of trace memory to store bus states. |

To mask fetches while tracing

- In the Debugger Options dialog box, select a Fetch Mask option.

Or:

- Using the command line, enter:

```
Debugger Option Trace Fetch_Align
```

Select Byte, Word, or Long and press < **Return** > .

Fetch addresses will be masked so that all fetches on the selected boundary size can trigger traces.

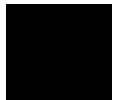

Modifying Display Area Windows

You can reformat display-area screens by modifying their windows. For example, you can reformat the high-level screen by resizing and moving the high-level Code, Monitor, Backtrace, Journal, and Breakpoint windows. You can also resize and move the alternate view of these windows.

This section shows you how to:

- Resize or move the active window.
- Move the Status window.
- Define user screens and windows.
- Display user-defined screens.
- Erase standard I/O and user-defined window contents.
- Remove user-defined screens and windows.

To resize or move the active window

- 1 Using the command line, enter:

```
Window Resize
```

And press the < **Return** > key.

- 2 Type **T** to position the top-left corner, **B** to position the lower-right corner, or **M** to move the window without resizing it; then, use the cursor keys to move the window or window border. When the window is at the desired location, press the < **Return** > key to save the new coordinates.

If you make a mistake while resizing the window, press **CTRL C** or press **Esc** twice to restore the previous coordinates.

The Window Resize command is used to move or alter the size of any existing window, except for the Status window. Use the Window New command to move the Status window.

When you use the Window Resize command on the normal view of a window, the normal dimensions are modified. When you use the command on the alternate view of a window, the alternate dimensions are modified.

You can enter resize commands when any screen is displayed. However, the debugger does not display commands on the standard I/O screen or on any user-defined screen.

To move the Status window

The Status window cannot be moved in the graphical interface.

- 1 Using the command line in the standard interface, enter:

Window New

Specify window number 5 to move the high-level Status window (or window number 15 to move the assembly level Status window), select Tab followed by High_Level (or Assembly), enter the new coordinates for the Status window, and press the < **Return** > key.

The Status window cannot be resized. The difference between the bottom row coordinate and top row coordinate must be 3.

A high-level program must be loaded in order to move the high-level status screen.

Be sure to move any windows that occupy the screen area to which you are moving the Status window. Otherwise, the Status window will be hidden behind these windows.

Examples

To move the high-level Status window to the top of the display (upper left corner at 0,0 and lower right corner at 3,78):

Chapter 9: Configuring the Debugger

Modifying Display Area Windows

```
Window New 5 <tab> High_Level 0,0,3,78
```

To move the assembly-level Status window to the bottom of the display:

```
Window New 15 <tab> Assembly 19,0,22,78
```

To define user screens and windows

- Using the command line, enter:

```
Window New
```

Enter the window and screen parameters, and press the < **Return** > key.

The debugger lets you define your own screens and windows so that you have flexibility in displaying debugger information.

User-defined windows must be assigned a number greater than or equal to 50, and less than or equal to 256. Numbers below 50 are reserved for predefined debugger screens and windows.

When you make a new window with the Window New command, the normal view and alternate view dimensions are set identically. The debugger allocates a buffer with enough memory to contain the entire window. Therefore, the window with the largest dimensions (normally the alternate view) should be defined first to allocate sufficient memory.

To display a user-defined screen, use the **Window Screen_On** command or press function key **F6**.

Caution

When making a new window on the high-level or assembly-level screens, be careful not to enter coordinates that will result in a window that covers the status line and command line. On a standard 80-column terminal display, a row coordinate may be between 0 and 23. Creating a window with a bottom row coordinate greater than 18 will cause part or all of the status and command lines to be covered.

Examples

To make a user window numbered 57 in user screen 4 with the upper-left corner of the window at coordinates 5,5 and the lower-right corner of the window at coordinates 18,78:

```
Window New 57 <tab> User_Screen 4 <tab> Bounds 5,5,18,78
```

If user screen 4 does not exist, the debugger automatically creates it.

To display user-defined screens

- Using the command line, enter:

```
Window Screen_On User_Screen <screen_nmbr>
```

Enter the user screen number, and press the < **Return** > key.

Examples

To display user screen 4:

```
Window Screen_On User_Screen 4
```

To erase standard I/O and user-defined window contents

- Using the command line, enter:

```
Window Erase <user_window_nmbr>
```

Enter the user window number (the standard I/O window number is 20) whose contents you wish to clear, and press the < **Return** > key.

If you do not specify a window number or if you specify 0, the active user-defined window is cleared. This command is useful in macros.

Examples To erase the contents of user window 57:
 Window **E**rase 57

To remove user-defined screens and windows

- Using the command line, enter:

Window **D**elete <user_window_nmbr>

Enter the number of the window to be removed, and press the < **R**eturn> key.

To remove a user-defined screen, remove all windows associated with that screen.

You cannot remove predefined debugger windows and screens.

Examples To remove a user-defined screen that has three windows (numbers 50, 55, and 73):

Window **D**elete 50

Window **D**elete 55

Window **D**elete 73

Saving and Loading the Debugger Configuration

Information regarding debugger options and screen configurations can be saved in a *startup file*. Startup files can be created only from within the debugger.

This section shows you how to:

- Save the current debugger configuration.
- Load a startup file.

To save the current debugger configuration

- Use the menu select mouse button to choose **File→Store→Startup (.rc) file (as default)**. The information is saved in file “db68k.rc” (for 68020 debug sessions) or file “db68030.rc” (for 68030 debug sessions) in the current directory.

Or:

- Use the menu select mouse button to choose **File→Store→Startup (.rc) file**. Using the file selection dialog box, enter the name of the file to which startup information should be saved; then, click on the OK pushbutton.

Or:

- Using the command line, enter:

```
File Startup <startup_file>
```

Enter the name of the file in which the startup information should be saved, and press the < **Return** > key. If you do not specify the name of the startup file, the default value will be used.

This command also saves the window and screen settings.

Chapter 9: Configuring the Debugger

Saving and Loading the Debugger Configuration

When saving window and screen settings that have been customized for a particular type of terminal, name the startup file the same as the TERM environment variable setting. If no startup file is loaded when starting the debugger, the debugger will automatically search for startup files named “`./$TERM.rc`” (in the current directory) or “`~/.$TERM.rc`” (in the home directory). files.

Examples

To save the current debugger state in a file called “`my_state.rc`”:

```
File Startup my_state
```

To save, in you home directory, window and screen settings that have been customized for the 2392, 2392a, 2392A, hp2392, hp2392a, or hp2392A terminal types:

```
File Startup ~/.2392
```

To load a startup file

- Use the `-s startup_file` option to the `db68k` command when starting the debugger.

```
$ db68k -e <emulator_id> -s <startup_file> <RETURN>
```

The debugger’s startup options and window specifications are configured as described in *startup_file*.

The *startup_file* must end with the `.rc` extension and can be created only from within the debugger.

If no startup file is named, the following files are searched for in order. The first one that exists will be used (`$HOME` and `$TERM` are UNIX environment variables).

```
db68k.rc (for 68020 debug sessions) or file db68030.rc (for 68030  
debug sessions) in the current directory  
./$TERM.rc in the current directory  
$HOME/.$TERM.rc
```

Chapter 9: Configuring the Debugger
Saving and Loading the Debugger Configuration

If no startup file is found, reasonable defaults will be used.

Examples

To start the debugger and load the state saved in the startup file “my_state.rc”:

```
$ db68k -e emul68k -s my_state.rc <RETURN>
```



Setting X Resources

The debugger's graphical interface is an X Window System application which means it is a *client* in the X Window System client-server model.

The X server is a program that controls all access to input devices (typically a mouse and a keyboard) and all output devices (typically a display screen). It is an interface between application programs you run on your system and the system input and output devices.

An *X resource* controls an element of appearance or behavior in an X application. For example, in the graphical interface, one resource controls the text in action key pushbuttons as well as the action performed when the pushbutton is clicked.

By modifying resource settings, you can change the appearance or behavior of certain elements in the graphical interface.

When the graphical interface starts up, it reads resource specifications from a set of configuration files. Resources specifications in later files override those in earlier files. Files are read in the following order:

- 1 The application defaults file. For example, `/usr/lib/X11/app-defaults/HP64_Debug` in HP-UX or `/usr/openwin/lib/X11/app-defaults/HP64_Debug` in SunOS.
- 2 The `$XAPPLRESDIR/HP64_Debug` file. (The `XAPPLRESDIR` environment variable defines a directory containing system-wide custom application defaults.)
- 3 The server's `RESOURCE_MANAGER` property. (The `xrdb` command loads user-defined resource specifications into the `RESOURCE_MANAGER` property.)

If no `RESOURCE_MANAGER` property exists, user defined resource settings are read from the `$HOME/.Xdefaults` file.

- 4 The file named by the `XENVIRONMENT` environment variable.

If the `XENVIRONMENT` variable is not set, the `$HOME/.Xdefaults-host` file (typically containing resource specifications for a specific remote host) is read.

- 5 Resource specifications included in the command line with the **-xrm** option.
- 6 System scheme files in directory `/usr/hp64000/lib/X11/HP64_schemes`.
- 7 System-wide custom scheme files located in directory `$XAPPLRESDIR/HP64_schemes`.
- 8 User-defined scheme files located in directory `$HOME/.HP64_schemes` (note the dot in the directory name).

Scheme files group resource specifications for different displays, computing environments, and languages.

This section shows you how to:

- Modify the debugger's graphical interface resources.
- Use customized scheme files.
- Set up custom action keys.
- Set initial recall buffer values.
- Set up demos or tutorials.

Refer to the "X Resources and the Graphical Interface" chapter for more detailed information.

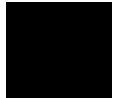

To modify the debugger's graphical interface resources

You can customize the appearance of an X Windows application by modifying its X resources. The following tables describe some of the commonly modified application resources.

| Application Resources for Schemes | | |
|-----------------------------------|-----------------------------|---|
| Resource | Values | Description |
| HP64_Debug.platformScheme | HP-UX SunOS (custom) | Names the subdirectory for platform specific schemes. This resource should be set to the platform on which the X server is running (and displaying the debugger's graphical interface) if it is different than the platform where the application is running. |
| HP64_Debug.colorScheme | BW Color (custom) | Names the color scheme file. |
| HP64_Debug.sizeScheme | Small Large (custom) | Names the size scheme file which defines the fonts and the spacing used. |
| HP64_Debug.labelScheme | Label \$LANG (custom) | Names to use for labels and button text. The default uses the \$LANG environment variable if it is set and if a scheme file named Debug.\$LANG exists in one of the directories searched for scheme files; otherwise, the default is Label. |
| HP64_Debug.inputScheme | Input (custom) | Specifies mouse and keyboard operation. |

| Commonly Modified Application Resources | | |
|---|---------------------------|--|
| Resource | Values | Description |
| HP64_Debug.enableCmdline | True False | Specifies whether the command line area is displayed when you initially enter the debugger's graphical interface. |
| *editFile | (example) vi % s | Specifies the command used to edit files. |
| *editFileLine | (example) vi + % d % s | Specifies the command used to edit a file at a certain line number. |
| *< proc> *actionKeysSub.keyDefs | (paired list of strings) | Specifies the text that should appear on the action key pushbuttons and the commands that should be executed in the command line area when the action key is pushed. Refer to the "To set up custom action keys" section for more information. |
| *< proc> *dirSelectSub.entries | (list of strings) | Specifies the initial values that are placed in the File → Context → Directory pop-up recall buffer. Refer to the "To set initial recall buffer values" section for more information. |
| *< proc> *recallEntrySub.entries | (list of strings) | Specifies the initial values that are placed in the entry buffer (labeled "(:)"). Refer to the "To set initial recall buffer values" section for more information. |



Chapter 9: Configuring the Debugger

Setting X Resources

The following steps show you how to modify the debugger's graphical interface's X resources.

- 1 Copy part or all of the HP64_Debug application defaults file to a temporary file.

The HP64_Debug file contains the default definitions for the graphical interface application's X resources.

For example, on an HP 9000 computer you can use the following command to copy the complete HP64_Debug file to HP64_Debug.tmp (note that the HP64_Debug file is several hundred lines long):

```
cp /usr/lib/X11/app-defaults/HP64_Debug HP64_Debug.tmp
```

NOTE: The HP64_Debug application defaults file is re-created each time debugger's graphical interface software is installed or updated. You can use the UNIX **diff** command to check for differences between the new HP64_Debug application defaults file and the old application defaults file that is saved as /usr/hp64000/lib/X11/HP64_schemes/old/HP64_Debug.

- 2 Modify the temporary file.

Modify the resource that defines the behavior or appearance that you wish to change.

For example, to change the number of lines in the main display area to 36:

```
vi HP64_Debug.tmp
```

Search for the string "HP64_Debug.lines". You should see lines similar to the following.

```
!-----  
! The lines and columns set the vertical and horizontal dimensions of the  
! main display area in characters, respectively. Minimum values are 18 lines  
! and 80 columns. These minimums are silently enforced.  
!  
! Note: The application cannot be resized by using the window manager.  
  
!HP64_Debug.lines:      24  
!HP64_Debug.columns:   85
```

Edit the line containing "HP64_Debug.lines" so that it is uncommented and is set to the new value:

```
!-----  
! The lines and columns set the vertical and horizontal dimensions of the  
! main display area in characters, respectively. Minimum values are 18 lines
```

```
! and 80 columns. These minimums are silently enforced.  
!  
! Note: The application cannot be resized by using the window manager.  
  
HP64_Debug.lines: 36  
!HP64_Debug.columns: 85
```

Save your changes and exit the editor.

- 3 If the `RESOURCE_MANAGER` property exists (as is the case with HP VUE — if you're not sure, you can check by entering the `xrdb -query` command), use the `xrdb` command to add the resources to the `RESOURCE_MANAGER` property. For example:

```
xrdb -merge -nocpp HP64_Debug.tmp
```

Otherwise, if the `RESOURCE_MANAGER` property does not exist, append the temporary file to your `$HOME/.Xdefaults` file. For example:

```
cat HP64_Debug.tmp >> $HOME/.Xdefaults
```

- 4 Remove the temporary file.
- 5 Start or restart the debugger's graphical interface.

After you have completed the above steps, you must either start, or restart by exiting and starting again, the debugger's graphical interface.

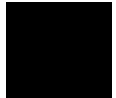

To use customized scheme files

Scheme files are used to set platform specific resources that deal with color, fonts and sizes, mouse and keyboard operation, and labels and titles. You can create and use customized scheme files by following these steps.

- 1 Create the `$HOME/.HP64_schemes/< platform>` directory.

For example:

```
mkdir $HOME/.HP64_schemes
mkdir $HOME/.HP64_schemes/HP-UX
```

- 2 Copy the scheme file to be modified to the `$HOME/.HP64_schemes/< platform>` directory.

Label scheme files are not platform specific; therefore, they should be placed in the `$HOME/.HP64_schemes` directory. All other scheme files should be placed in the `$HOME/.HP64_schemes/< platform>` directory.

For example:

```
cp /usr/hp64000/lib/X11/HP64_schemes/HP-UX/Debug.Color
   $HOME/.HP64_schemes/HP-UX/Debug.MyColor
```

Note that if your custom scheme file has the same name as the default scheme file, the load order requires resources in the custom file to explicitly override resources in the default file.

- 3 Modify the `$HOME/.HP64_schemes/< platform> /Debug.< scheme>` file.

For example, you could modify the “`$HOME/.HP64_schemes/HP-UX/Debug.MyColor`” file to change the defined foreground and background colors. Also, since the scheme file name is different than the default, you could comment out various resource settings to cause general foreground and background color definitions to apply to the debugger’s graphical interface. At least one resource must be defined in your color scheme file for it to be recognized.

- 4 If your custom scheme file has a different name than the default, you must modify the scheme resource definitions.

The debugger's graphical interface application defaults file contains resources that specify which scheme files are used. If your custom scheme files are named differently than the default scheme files, you must modify these resource settings so that your customized scheme files are used instead of the default scheme files.

For example, to use the "\$HOME/.HP64_schemes/HP-UX/Debug.MyColor" color scheme file you would set the "HP64_Debug.colorScheme" resource to "MyColor":

```
HP64_Debug.colorScheme: MyColor
```

Refer to the previous "To customize debugger's graphical interface resources" section for more detailed information on modifying resources.



To set up custom action keys

- Modify the “actionKeysSub.keyDefs” resource.

The “actionKeysSub.keyDefs” resource defines a list of paired strings. The first string defines the text that should appear on the action key pushbutton. The second string defines the command that should be sent to the command line area and executed when the action key is pushed.

A pair of parentheses (with no spaces, that is “()”) can be used in the command definition to indicate that text from the entry buffer should replace the parentheses when the command is executed.

Action keys that use the entry buffer should always include the entry buffer symbol, “()”, in the action key label as a visual cue to remind you to place information in the entry buffer before clicking the action key.

Shell commands can be executed by using the Debugger Host_Shell command.

Also, command files can be executed by using the File Command command.

Finally, an empty action (“”) means to repeat the previous operation, whether it came from a pull-down, a dialog, a pop-up, or another action key.

Examples

To set up custom action keys, modify the “debug*actionKeysSub.keyDefs” resource:

```
debug*actionKeysSub.keyDefs: \  
  "Init Demo"           "F C initDemo" \  
  "Make"                "D H make demo" \  
  "Load Pgm"           "P L D ecs" \  
  "Display Source"     "W A H C" \  
  "Run Until ( )"      "P R U ( )" \  
  "Step"               "P S" \  
  "Again"              ""
```

Refer to the previous “To modify debugger’s graphical interface resources” section for more detailed information on modifying resources.

To set initial recall buffer values

- Modify the “entries” resource for the particular recall buffer.

Some of the resources for the pop-up recall buffers are listed in the following table:

| Pop-up Recall Buffer Resources | |
|---|----------------------------------|
| Recall Pop-up | Resources |
| Entry Buffer (): | *recallEntrySub.entries |
| File → Context → Directory ... | *dirSelectSub.entries |
| Modify → Register; Recall Value | *modRegDB*recallSub.entries |
| Command Line command recall | *recallCmdSub.entries |
| Macro Operations dialog box; Recall Value | *macroDB_popup*recallSub.entries |

Other X resources for the recall buffers are described in the supplied application defaults file.

The window manager resource “*transientDecoration” controls the borders around dialog box windows. The most natural setting for this resource is “title.”

Example

To set the initial values for the directory selection dialog box, modify the “debug*dirSelectSub.entries” resource:

```
debug*dirSelectSub.entries: \
    "$HOME" \
    ". ." \
    "/users/project1" \
    "/users/project2/code"
```

Refer to the previous “To modify the debugger’s graphical interface resources” section in this chapter for more detailed information on modifying resources.

To set up demos or tutorials

You can add demos or tutorials to the debugger's graphical interface by modifying the resources described in the following tables.

| Demo Related Component Resources | | |
|----------------------------------|----------------------|--|
| Resource | Value | Description |
| *enableDemo | False True | Specifies whether Help→Demo appears in the pull-down menu. |
| *demoPopupSub.indexFile | ./Xdemo/Index-topics | Specifies the file containing the list of topic and file pairs. |
| *demoPopup.textColumns | 30 | Specifies the width, in characters, of the demo topic list pop-up. |
| *demoPopup.listVisibleItemCount | 10 | Specifies the length, in lines, of the demo topic list pop-up. |
| *demoTopic | About demos | Specifies the default topic in the demo pop-up selection buffer. |

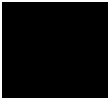

| Tutorial Related Component Resources | | |
|--------------------------------------|--------------------------|--|
| Resource | Value | Description |
| *enableTutorial | False True | Specifies whether Help → Tutorial appears in the pull-down menu. |
| *tutorialPopupSub.indexFile | ./Xtutorial/Index-topics | Specifies the file containing the list of topic and file pairs. |
| *tutorialPopup.textColumns | 30 | Specifies the width, in characters, of the of the tutorial topic list pop-up. |
| *tutorialPopup.listVisibleItemCount | 10 | Specifies the length, in lines, of the tutorial topic list pop-up. |
| *tutorialTopic | About tutorials | Specifies the default topic in the tutorial pop-up selection buffer. |

The mechanism for providing demos and tutorials in the graphical interface is identical. The following steps show you how to set up demos or tutorials in the debugger's graphical interface.

- 1 Create the demo or tutorial topic files and the associated command files.

Topic files are simply ASCII text files. You can use “\I” to produce inverse video in the text, “\U” to produce underlining in the text, and “\N” to restore normal text.

Command files are executed when the “Press to perform demo (or tutorial)” button (in the topic pop-up dialog) is pushed. A command file must have the same name as the topic file with “.cmd” appended. Also, a command file must be in the same directory as the associated topic file.

Chapter 9: Configuring the Debugger

Setting X Resources

- 2 Create the demo or tutorial index file.

Each line in the index file contains first a quoted string that is the name of the topic which appears in the index pop-up and second the name of the file that is raised when the topic is selected. For example:

```
"About demos"      /users/guest/gui_demos/general
"Loading programs" /users/guest/gui_demos/loadprog
"Running programs" /users/guest/gui_demos/runprog
```

You can use absolute paths (for example, /users/guest/topic1), paths relative to the directory in which the interface was started (for example, mydir/topic2), or paths relative to the product directory (for example, ./Xdemo/general where the product directory is something like /usr/hp64000/inst/db68k/64748A).

- 3 Set the “*enableDemo” or “*enableTutorial” resource to “True”.
- 4 Define the demo index file by setting the “*demoPopupSub.indexFile” or “*tutorialPopupSub.indexFile” resource.

For example:

```
*demoPopupSub.indexFile: /users/guest/gui_demos/index
```

You can use absolute paths (for example, /users/guest/Index), paths relative to the directory in which the interface was started (for example, mydir/indexfile), or paths relative to the product directory (for example, ./Xdemo/Index-topics where the product directory is something like /usr/hp64000/inst/db68k/64748A).

- 5 If you wish to define a default topic to be selected, set the “*demoTopic” or “*tutorialTopic” resource to the topic string.

For example:

```
*demoTopic: "About demos"
```

Refer to the previous “To customize debugger’s graphical interface resources” section for more detailed information on modifying resources.

10



Configuring the Emulator

How to configure the emulator for your target system.

Each target system differs in the way it uses the processor, memory, and memory mapped I/O devices. During system development, your needs for emulator resources may change as your target system design matures. You can allocate emulator resources using debugger commands. This resource allocation is called the emulator configuration.

There are three ways to configure the emulator:

- Load a configuration file into the emulator.
- Change the configuration using the Emulator Configuration dialog box.
- Change the configuration using the **D**ebuffer **E**xecution **E**nvironment **M**odify_**C**onfig command from the command line.

The Emulation Configuration dialog box is available both in the debugger/emulator graphical interface and in the emulator/analyzer graphical interface.



To start the Emulator Configuration dialog box

- Select **Modify→Emulator Config...** in either the debugger/emulator or emulator/analyzer graphical interface.

The Emulator Configuration main menu and an Emulator Configuration window are displayed. The Emulator Configuration dialog box may be left running while you are using the debugger.

Examples

The Emulator Configuration main menu is shown below.

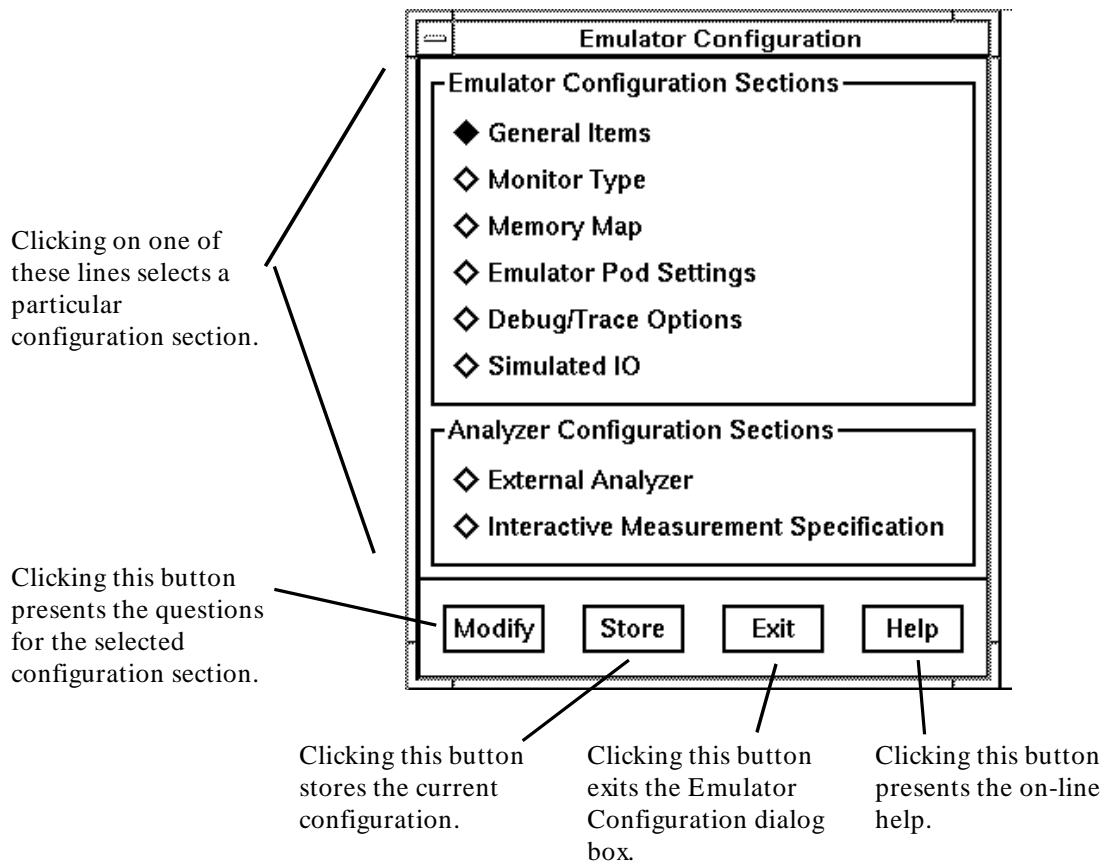

To modify a configuration section

- 1 Start the emulator Emulator Configuration dialog box.
- 2 Click on a section name in the Emulator Configuration main menu, and click the "Modify" pushbutton.
- 3 Use the command line in the Emulator Configuration window to answer the configuration questions.

Each configuration section presents a window similar to the following.

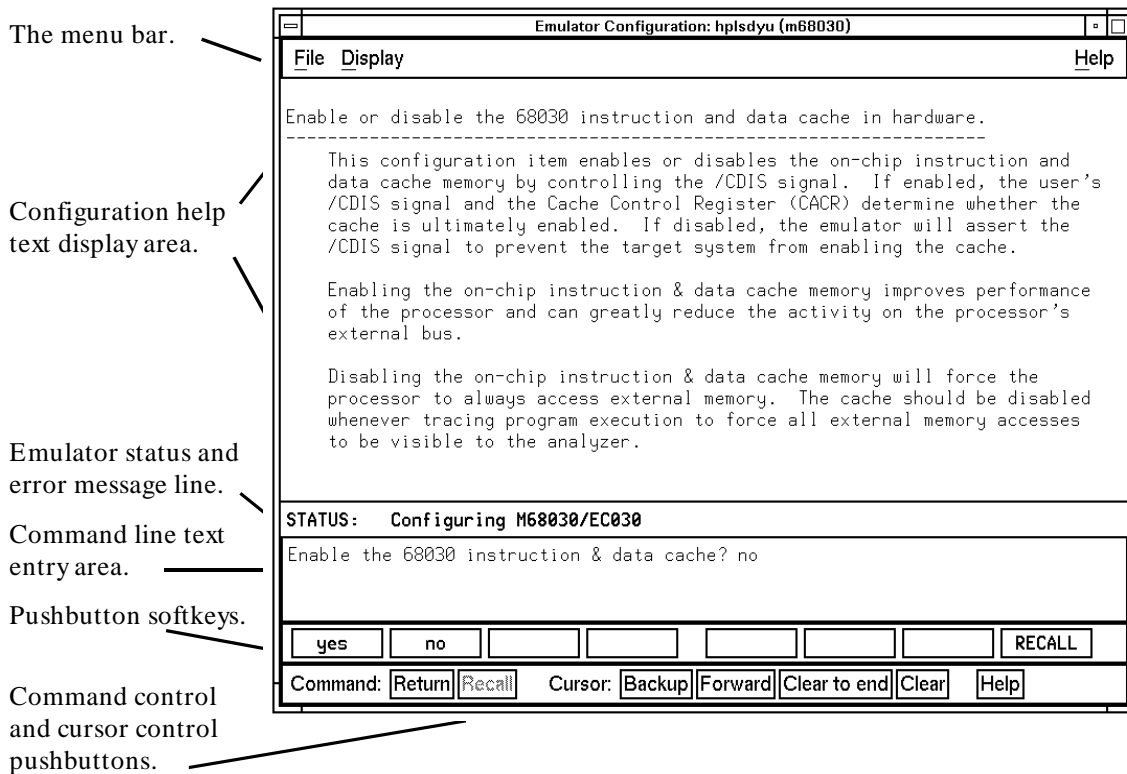

To answer a configuration question, click the softkey pushbutton that has your answer. Or, click on the "Return" command pushbutton to accept the answer that is shown.

When you answer a configuration question, you are normally presented with the next question in the section; however, there are some cases when a carriage return is required, and you can supply it by clicking the **Return** command pushbutton or by pressing the < **Return**> key.

At the last question of a configuration section, you are asked if you wish to return to the main menu. You can click the "next_sec" softkey pushbutton to access the questions in the next configuration section.

To recall a configuration question, click the **RECALL** softkey pushbutton. If you do this at the starting question of a configuration section, you are asked if you want to return to the main menu.

In order for the emulator to recognize any configuration changes, the configuration must be stored.

To store a configuration

- When answering the configuration questions, choose **File→Store...** from the pull-down menu, and use the File Selection dialog box to name the configuration file.
- From the Emulator Configuration dialog box main menu, click on the "Store" button, and use the File Selection dialog box to name the configuration file.

The file to which the configuration is stored becomes the current configuration file. The emulator only recognizes configuration changes when they are stored or loaded.

When modifying a configuration, you can choose to store your answers at any time.

For more information on how to use dialog boxes, refer to the "To use dialog boxes" description in the "Entering Commands" chapter.

To examine the emulator configuration

- 1 Select **Modify→Emulator Config...** to display the Emulator Configuration dialog box.
- 2 Click on the configuration section you wish to examine.
- 3 Click on the **Return** button or press **< Return >** on your keyboard to page through the configuration questions without changing their values.
- 4 At the end of the configuration section, click on **yes** to return to the Emulator Configuration dialog box (main menu).
- 5 Click on **Exit Window**.

This procedure allows you to examine the emulator configuration without changing it.

If you accidentally change one of the configuration items, don't worry. As long as you do not click on **Apply to Emulator**, any changes you make will not be saved. Just click on **Yes** when the debugger asks "Your changes will be lost—Exit configuration?"



To change the configuration directory context

- When answering the configuration questions, choose **File→Directory...** from the pull-down menu, and use the Directory Selection dialog box to specify the new directory.

The directory context specifies the directory to which configuration files are stored and from which they are loaded.

The Emulator Configuration dialog box directory context is separate from the debugger interface directory context. Changing one does not affect the other.

To display the configuration context

- When answering the configuration questions, choose **Display**→**Context...** from the pull-down menu.

The current directory context and the current configuration files are displayed in a window. Click the **Done** pushbutton when you wish to close the window.

To access configuration help information

- When answering the configuration questions, choose **Help**→**General Topic...** from the pull-down menu.
- From the Emulator Configuration dialog box main menu, click on the "Help" button.

To exit the Emulator Configuration dialog box

- When answering the configuration questions, choose **File**→**Exit...** from the pull-down menu (or type <CTRL> x), and click **Yes** in the confirmation dialog box.
- From the Emulator Configuration dialog box main menu, click the **Exit** button, and click **Yes** in the confirmation dialog box.

Any modifications made to the configuration which haven't been stored are lost. Choosing **No** from the confirmation dialog box cancels the exit and keeps the emulator Emulator Configuration dialog box running.

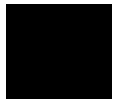

To load a configuration file

- Use the `-C` command line option when starting the debugger.

Or:

- Use a default configuration file.

Or:

- Select **File**→**Load**→**Emulator Config**.

Or:

- Using the command line, enter

```
Debugger Execution Environment Load_Config
```

The emulation configuration file contains configuration information for the emulator. The debugger/emulator accepts files generated by the emulation software or by an editor. The debugger uses the `.EA` suffixed file (ASCII format) to load emulator configurations.

If you do not specify a configuration file (no `-C` option is given) and the emulator is locked at startup, the configuration saved when you left the emulator locked is used. No default configuration is loaded.

If you do not specify the `-C` option and the emulator is not locked, the debugger searches for a default configuration file in the following sequence:

- 1 configuration file `default.EA` in the current directory.
- 2 configuration file `default.EA` in the `$HOME` directory.
- 3 configuration file `/usr/hp64000/inst/emul/64748A/userconfig.EA` or `/usr/hp64000/inst/emul/64747A/userconfig.EA`.
- 4 configuration file `/usr/hp64000/inst/emul/64748A/default.EA` or `/usr/hp64000/inst/emul/64747A/default.EA` provided with the emulator.

Note

Default configuration files are also supplied with the HP 64907/B1478 68030/EC030 C compiler and HP 64903/B1461 68020 C compiler. You should copy the appropriate default configuration file for your memory configuration into your directory and name it *default.EA*. These files are located in directories:

```
/usr/hp64000/env/hp64748
/usr/hp64000/env/hp64747
```

The file *userconfig.EA* is not supplied with the debugger. This file name refers to a configuration file that you may create and put in directory

```
/usr/hp64000/inst/emul/64748A or
/usr/hp64000/inst/emul/64747A.
```

Examples

The following examples show a few ways to load a configuration file:

```
db68k -e test -C srwcfg.EA
```

Run the debugger using emulator "test" and configuration file "srwcfg.EA"

```
db68k -e m68020
```

Run the debugger using emulator "m68020" and use the default configuration file named "default.EA" in the current working directory.

If "default.EA" does not exist in the current directory, the debugger searches for a default configuration file in the sequence described previously in this chapter, in the section titled "To Configure the Emulator".

```
Debugger Execution Environment Load_Config "mycnfig"
```

Load the emulation configuration file "mycnfig.EA" (from within the debugger).

To create or modify a configuration file

- Use the Emulator Configuration dialog box to set up the configuration, then save the configuration using **File→Store→Emul Config**.

Or:

- Change the configuration using the **Debugger Execution Environment Modify_Config** command from the command line.

Or:

- Edit a configuration file using a text editor.

If you use a text editor to create a configuration file, be use to give the file a name with the file extension `.EA`. The `.EA` file extension tells the debugger that the file is an ASCII configuration file.

If an error occurs when loading a configuration file

- Load a different configuration file.

Or:

- 1 Exit the debugger.
- 2 Modify the configuration file using a text editor.
- 3 Return to the debugger

Caution

If you reload a configuration using the *Debugger Execution Environment Load_Config* command, the contents of memory will be changed. Even if the new configuration memory map is identical to the old memory map, you must reload the contents of memory.

See also

The *Softkey Interface User's Guide* for your emulator
68020 C Cross Compiler Reference
68030 C Cross Compiler Reference

To store an emulator configuration

- Click on the **Store** button in the Emulator Configuration dialog box.

You may use any legal file name.

The configuration you have created will be saved in two files, each with the name you specify, as follows:

- < filename> .EA is an ASCII version of the configuration file that is saved when you modify the configuration. You can make changes to this file outside the emulation environment by using a text editor.
- < filename> .EB is a binary version of the configuration file that is created from the .EA file. It can be loaded quickly and is used when you start the emulator or load a configuration. If you modify the .EA file using a text editor, be sure to delete the .EB file with the same name so that it will be re-created and include your changes.



Emulator Configuration Items

Memory

The emulator must know how your target system memory resources are allocated. You can use emulation memory for some memory ranges. This is useful in the early stages of target system design.

In the MC68020 emulator, if your target system runs at more than 25 MHz, emulation memory requires one wait state (except for the 4 Kbytes of dual-port memory, which will run at 33 MHz without wait states).

In the MC68030/EC030 emulator, emulation memory always requires one wait state for synchronous and burst modes. If your target system runs at more than 25 MHz, target memory accesses will also require one wait state for synchronous and burst modes.

You can choose to interlock the emulation and target system DSACK signals (and STERM for the MC68030/EC030) for emulation memory cycles and monitor bus cycles (foreground monitor only on the MC68030/EC030). For emulation memory, the interlock is enabled for only the blocks that require it.

Emulation Monitor

The emulation monitor is used to implement some emulator features. For example, display or modification of emulation or target system memory is done by the monitor. You can choose either a foreground or background monitor, and the base address where the monitor resides. (See the book *Concepts of Emulation and Analysis* that you received with your HP emulator for more information on foreground and background monitors.)

If you're using the MC68020 emulator with the background monitor, the emulator makes the background cycles visible to the target system. These cycles appear in a 4 Kbyte range that begins with the base address you set for the monitor. The MC68030/EC030 emulator doesn't make background cycles visible to the target system. For these systems, you can set a "keep-alive address" from which the background monitor will periodically read a byte during monitor operation.

If you select a foreground monitor, you can choose a default foreground monitor that is resident in the emulator, or you can design a custom

foreground monitor to support your special target system needs. You can also specify the interrupt priority mask to use during foreground monitor execution.

A foreground monitor must be used when the MMU of the 68030 is enabled. If the background monitor selected when you attempt to enable the MMU, the foreground monitor will be selected, by default. If you have the 68030 emulator/analyzer graphical interface, you may wish to read the "Using MC68030 Memory Management" chapter in the *68020/030 Graphical User Interface User's Guide*.

Break Conditions

Software and hardware breakpoints allow you to terminate your program and start the monitor.

Software breakpoints use one of the BKPT instructions (BKPT 1..7). You can choose—via configuration—which instruction is used. The BKPT 0 instruction is not used by the emulator.

Other Configuration Items

The emulation configuration lets you set up the emulator to restrict your target program to real-time runs; these ignore commands that temporarily interrupt execution of your target program. This is important for systems that require nonstop, real-time execution of the target program.

You can disable the processor cache memory. The emulation-bus analyzer can't trace instructions (or data) that are fetched from the cache. This can make trace displays difficult to interpret. When you disable the cache, all instructions and data are fetched from the processor buses, and therefore will appear in the trace list.

You can block target system interrupts from the processor. This can help you troubleshoot problems with spurious interrupts or allow you to delay testing of interrupt service routines.

An **Execution→Run→From Reset** command usually causes the emulation processor to fetch its stack pointer and program counter values from the reset vector addresses. Under certain run conditions (such as an emulator reset, followed by a break to monitor, followed by a run command), the emulation processor can't fetch its stack pointer and program counter values from the



reset vector addresses. In the emulation configuration questions, you will specify the appropriate values for the stack pointer and program counter so that they can be supplied by the emulator when they can't be fetched from the reset vector addresses.

To enter the monitor after configuration

You can allow the emulator to remain in the reset state after you complete the configuration process, or you can have it begin executing in the monitor.

- In the "General Items" configuration section, answer the question:

Enter monitor after configuration?

yes means that the emulator will break to the monitor (from reset) when you finish the configuration session. (This is the default.)

no means that the emulator will remain reset when you finish the configuration session.

To restrict to real-time runs

The emulator uses the emulation monitor program to implement some features, such as register displays. When the emulation processor executes the monitor, it is not executing your target system program. This may cause problems in target systems that need real-time program execution (uninterrupted execution of your target system program).

- Answer the question:

`Restrict to real-time runs?`

yes means the emulator will stop running your target system program only with the reset, break, run, and step commands. Other commands that require a break to monitor will be ignored. Also, the **Display→Memory** command will be ignored if the address argument requires access to standard emulation memory (not dual-ported) or target system memory.

no means all commands are accepted. The emulation monitor may be entered at any point during execution of your target system program to perform requirements of your commands. This is the default.

CAUTION

If your target system could be damaged because the emulator isn't running target system code continuously, answer **yes** to this configuration question.



This configuration item doesn't affect hardware breakpoints, such as: break on write to ROM, break on analyzer trigger, or break on access to guarded memory. It also doesn't affect the emulator's response to software breakpoints.

To enable the processor cache memory

The MC68020 processor has a cache that stores the most recently used instructions. The MC68030/EC030 processor has an instruction cache like the MC68020, and additionally has a cache for recently used data. When enabled, processor caches increase processor performance.

The emulation-bus analyzer can't trace transactions that are completed using the processor's internal cache. Without these transactions, the analyzer may show confusing trace displays, or it may fail to trigger. This happens when the code you are tracing is a small loop where all of the instructions and operands fit within the cache(s) and the processor registers.

- For the MC68020 emulator, answer the question:

Enable the 68020 instruction cache?

- For the MC68030/EC030 emulator, answer the question:

Enable the 68030 instruction & data cache?

no means the processor will always access external memory for instructions and data. The analyzer will be able to capture all bus cycles; this will improve readability of the trace list. Processor performance will be reduced.

yes means maximum processor performance will be obtained. If you are making analyzer trace measurements, you may need to experiment to find suitable trigger combinations.

The emulator uses the $\overline{\text{CDIS}}$ signal according to the answer you give to this configuration question. If you answer **no**, the emulator asserts $\overline{\text{CDIS}}$ to disable the cache(s). If you answer **yes**, the target system is allowed to use the $\overline{\text{CDIS}}$ signal and the cache control register (CACR) enable bit to determine when the cache(s) are enabled.

If you would like to enable the cache(s) during execution of most of your target program, but disable them during accesses to a specific memory block, you can use the **ci** memory map attribute (available only on the MC68030/EC030 emulator). This allows you to trace state executions within a

specific memory range while obtaining maximum system performance in the remaining memory ranges. See “To assign memory map terms” later in this chapter.

To enable one wait state for emulation memory

In the MC68020 emulator, emulation memory doesn't require any wait states for clock speeds under 25 MHz. One wait state is needed when the clock speed is above 25 MHz (except for the dual-port memory, which will run at 33 MHz without wait states).

The MC68030/EC030 emulator always requires one wait state for synchronous and burst memory accesses to emulation memory. When the clock speed is above 25 MHz, the emulator *must* add a wait state for synchronous and burst mode accesses to target system memory.

- Answer the question:

Is speed of external clock faster than 25 MHz?

yes for clock speeds above 25 MHz. (This is the default.) This ensures that emulation memory has enough time to respond to the memory access. Otherwise, emulator operation will be erratic.

no for clock speeds below 25 MHz. Emulation memory accesses will be made without adding wait states.

To change the memory configuration

Each target system allocates memory and I/O as needed by the application. As the system design matures, memory locations and requirements may change. The emulator has flexible memory resources that allow you to configure the emulator to support your needs. For example, the initial target system design

Chapter 10: Configuring the Emulator

Emulator Configuration Items

may not support external memory, but after a change in the application definition, more program code might be required, needing external memory. While the design is being changed, you can develop your program using emulation memory to simulate target system memory.

- Answer the question:

Modify memory configuration?

- | | |
|------------|--|
| yes | leads you into the memory, MMU (for MC68030), and monitor configuration questions. |
| no | skips to the “Modify the emulator pod configuration?” configuration question. This is the default. |

To enable the MC68030 Memory Management Unit

The MC68030 MMU can manage a program that occupies a large space in logical (virtual) memory while running it from a much smaller space in physical memory.

- Answer the question:

Enable the MMU?

- | | |
|------------|---|
| yes | lets the MMU of the MC68030 control placement of the program in physical memory space. With a valid entry in the translation control register, the target system will be able to enable and disable the MMU during program execution by using the /MMUDIS signal. |
| no | disables the MMU in the emulation processor. The /MMUDIS signal from the target system will be ignored. The STATUS line will identify your emulator as MC68EC030 after the configuration modification is complete. |

To select and configure the MC68030 emulation monitor

If you are using the MC68020 or MC68EC030 emulator, skip to the next step. The emulation monitor is used to perform emulation functions, such as display and modification of emulation and target system memory. You must use a foreground monitor when the MMU is enabled, either the foreground monitor supplied with the emulator, or a foreground monitor of your own design.

Make sure the foreground monitor is mapped to memory address space that has a 1:1 translation. You can define a 1:1 translation for the monitor address space by modifying the content of the translation tables in the emulation processor MMU. Refer to "Mapping The Foreground Monitor For Use With The MC68030 MMU" at the end of this chapter for instructions on how to modify the translation tables or transparent translation registers in the MC68030 MMU.

- Answer the question:

Monitor type (with MMU enabled)?

foreground selects the default foreground monitor that is supplied with your emulator.

user_foreground selects a custom foreground monitor.

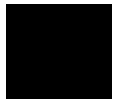

To select and configure the emulation monitor

If you are using an MC68030 with the MMU enabled, skip to the next step. The emulation monitor is used to perform emulation functions such as display and modification of emulation or target system memory.

- Answer the question:

Monitor type?

| | |
|------------------------|--|
| background | selects the background monitor. |
| foreground | selects the default foreground monitor that is built-in to the emulator. |
| user_foreground | allows you to load a custom emulation monitor. |

To set up specifications for the emulation monitor

The background monitor overlays processor address space and doesn't use any processor memory resources. It is the simplest monitor to use, and is guaranteed to be compatible with the emulator. However, interrupts are disabled (including level 7) when the emulator is running in background. Some target system designs fail to operate properly under this condition. With these target systems, you will need to use a foreground monitor.

When you select a foreground monitor, the emulator maps the 4 Kbyte block of dual-port memory for the monitor. You can't use any portion of the dual-port address range for any other purpose. Doing so will destroy the monitor.

There are two selections you can make when choosing a foreground monitor. One is the **foreground** monitor that is resident in the emulator. If this monitor doesn't meet your needs, you can modify the monitor source code (supplied with the emulator), and save it under a different name, such as **myforeground**. To select it, you will choose the **user_foreground** monitor. Within the next few questions, you will tell the emulator the name you assigned to your **user_foreground** monitor.

If you have trouble with emulation monitor functions, you can reload the monitor. Simply reset the emulation processor and then issue a new run or break command. Either the default foreground, **user_foreground**, or background monitor will be loaded when the processor transitions out of emulator reset. The monitor that will be loaded will depend on the answer you gave to the Monitor type question earlier.

Background and foreground monitors both use the trace exception vector (located at offset 24 in the vector table) to implement the **step** command.

More information on emulation monitors is given in the book *Concepts of Emulation and Analysis* that you received with your HP emulator.

- 1 Reset Map question. If you changed the monitor type, you need to answer the question:

Reset map (change of monitor type requires map reset)?

no to discard your monitor changes and return to the configuration question on monitor type.

yes to keep your monitor changes. The memory map is reset.

When you change monitor types, the emulation processor is reset, and you must reset the memory map. You will have to create a new memory map later in the configuration process. If you choose not to reset the map, the interface will return to the “Monitor type?” question to give you an opportunity to review your choice or make a different choice.

- 2 Periodic Read question. If you choose a foreground monitor, skip to question 4. If you choose the **background** monitor for the MC68030/EC030 (with MMU disabled), and you would like to have it read a byte from the target system, periodically, answer the question:

Do you want periodic read accesses while in background monitor?

yes proceeds to the next configuration question, which allows you to specify the address to be read.

no disables periodic background monitor reads from the target system.

The background monitor for the MC68030/EC030 can periodically read a byte from the target system if your system requires this service. The MC68030/EC030 emulator does not normally drive background monitor cycles to the target system. Some target systems need background monitor cycles. For example, your target system may have a watchdog timer that will time out if a specific address isn't read periodically. Other target systems may have a block of dynamic RAM that needs to be refreshed at regular intervals.

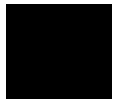

Chapter 10: Configuring the Emulator

Emulator Configuration Items

- 3 Read Specifier questions. If you answered **yes** to the periodic read question, answer the next two questions:

Address for read cycles?

Enter a hexadecimal address from 0 to 0ffffffH.

Function code for read cycles?

Select a function code from the softkeys.

Whenever it is executing, the background monitor will periodically read a byte from the location you specify with your answer to the above two questions.

- 4 Monitor Filename question. If you selected the background monitor, skip to question 6. If you selected the **user_foreground** monitor type, you need to answer this question:

Monitor filename?

Specify the name of the absolute file containing your custom foreground monitor code (such as, **myforeground**).

- 5 Interrupt Priority question. If you selected the **foreground** or **user_foreground** monitor type, you need to answer the question:

Interrupt priority level for default foreground monitor?

or

Interrupt priority level for user foreground monitor?

Enter a number from 0 to 7 in answer to the above question. Set the interrupt priority level low enough to allow your target system to function correctly, yet high enough to avoid excessive interrupt processing.

The emulator uses a level 7, non-maskable interrupt to interrupt the target system and break into the monitor. When the foreground monitor is not executing critical code (such as monitor entry and exit), the foreground monitor will set the interrupt priority mask to the value given as an answer to

this question, or to the interrupt level that was in effect before monitor entry, whichever is greater.

This configuration item is ignored if you choose the background monitor. You can also block all target system interrupts.

Example

Suppose your target system has a disk device driver that uses interrupt level 5, and the service routine must be run to prevent target system damage. To allow interrupts of higher priority than level 4 to be serviced during foreground monitor execution, enter:

```
Modify memory configuration? yes
Monitor type? foreground
Reset map (change of monitor type requires map reset)?
yes
Interrupt priority level for default foreground
monitor? 4
. . .
```

-
- 6 Base Address question. If you're using the MC68030/EC030 emulator with the **foreground** or **user_foreground** monitor, or the MC68020 emulator with any monitor type, you must set the base address where the monitor will be loaded. Answer the question:

Monitor's base address?

Enter a hexadecimal address on a 4 Kbyte boundary (XXXXXX000h).

Background monitor

When you select the background monitor, the emulator uses overlay memory to load the monitor. This overlay memory doesn't use any processor memory space. You might ask, "If the emulation monitor is in background memory, why would I care about its base address?" In most cases, you won't care. The reason this question is offered when you are using the background monitor with an MC68020 emulator is to solve the following problem, if it occurs.

In the MC68020 emulator, the address, data and control strobes are driven to the target system during background monitor operation. Background write cycles appear as reads to the target system. These false target system

Chapter 10: Configuring the Emulator

Emulator Configuration Items

reads may cause unpredictable results to some I/O and target system memory addresses. You can relocate the background monitor (using this configuration item) so that these read cycles won't occur in address space occupied by I/O or other target system hardware. For example, if your target system hardware occupies address space from 0H through 4FFFH, you might answer this question with 5000H.

In the MC68030/EC030 emulator, this question is not asked for the background monitor. Bus cycles aren't driven to the target system by the background monitor unless you requested them in the periodic read question, earlier.

Foreground monitor

For both the MC68020 and MC68030/EC030 emulators, this configuration item sets the base address where the monitor is loaded. When you select a foreground monitor, the emulator loads the foreground monitor into the 4 Kbyte block of dual-port emulation memory. It resets the memory map, and creates a map term at the address you specified when you answered the "Monitor's base address?" question. You can't delete or alter this map term by using the map configuration commands. Instead, you must change the monitor configuration by modifying your answers to the monitor configuration questions.

If you did not change the monitor type but did change the monitor base address, you need to answer the question:

Reset map (change of monitor type requires map reset)?

as described in the Reset Map question (1) of this procedure.

- 7 Interlocking Signals question.** If you're using the MC68030/EC030 emulator with the **foreground** or **user_foreground** monitor, or the MC68020 emulator with any monitor type, you can interlock emulator and target DSACKs for monitor cycles.

For the MC68020 emulator, answer the question:

Enable the DSack Interlock?

For the MC68030/EC030 emulator, answer the question:

Enable signal interlocking on monitor accesses?

- yes** interlocks emulator and target system cycle termination signals for monitor accesses.
- no** terminates monitor accesses with only the emulator-generated cycle termination signals.

When you enable interlocking, emulation monitor cycles aren't terminated until the target system DSACK (DSACK or STERM for the MC68030/EC030) is received. The emulator will also respond to BERR signals from the target system. If you disable interlocking, emulator-generated signals will terminate the cycle and the target system signals will be ignored.

This configuration item only applies to the map term defined for the monitor. For other memory ranges, refer to "To assign memory map terms."

If you enable the interlock, and the monitor is in an address range where the target system does not return DSACK (or STERM), the emulator will stop. If this happens, use the **Execution→Reset to Monitor** command to reset the processor. Then disable the interlock.

Remember that emulation monitor bus cycles are visible to the target system (except when you are using the MC68030/EC030 with a background monitor). If you disable the interlock, your target system may operate erratically if it is not prepared for the emulation monitor bus cycles.

If you did not change the monitor type nor the monitor base address, but you did change the answer to this interlocking signals question, you will need to answer the question:

Reset map (change of monitor type requires map reset)?

as described in the Reset Map question (1) of this procedure.



To assign memory map terms

The memory map should be on screen. You need to specify the location and type of various memory regions used by your programs and your target system. The emulator needs this information to:

- Orient buffers for data transactions with emulation memory and the target system.
- Reserve emulation memory blocks.
- Identify the types of the memory blocks so that configuration items such as write to ROM break will operate correctly.

The emulation memory configuration is presented as a memory mapping screen. The emulator has seven available map terms.

- Assign memory to a specific address range by entering

< lower> [thru < upper>] < fcode> < memory_type> < attribute> .

Parameters in the above command are defined in the following pages.

< lower> , < upper> Specifies an address range aligned with 256-byte boundaries. If you omit the **< upper>** address, a 256-byte block is allocated, starting at the lower address.

To specify an address beginning on a 256-byte boundary, enter an address ending in 00. To specify an address ending on a 256-byte boundary, enter an address ending in FFH.

Because of the way the emulation memory system is designed, the amount of memory used by each map term corresponds to the nearest block size available, not the amount specified by the address range. To help you to better understand this, the next few paragraphs describe the physical design of emulator memory.

There is one 4 Kbyte block of dual-ported emulation memory on the emulator probe. (Dual-ported means the emulation controller can access memory locations without interfering with program execution). This block can be mapped by specifying the **dp** attribute after the map address and memory type specification. If you use a foreground monitor, it will be loaded into this space and you won't be able to map this memory for any other purpose.

If you specify an address range less than 4K with the **dp** attribute, all 4K is allocated because that is the minimum block size for that memory. If you specify a block size less than 4K and the dual-port memory is unmapped, the emulator will use that memory to more closely match the requested address range to the block size.

In the MC68020 emulator, the dual-port memory does not require wait states, even when you use the emulator at 33 MHz. The dual-port memory is 16 bits wide.

In the MC68030/EC030 emulator, the dual-port memory runs at the same speed as target system accesses. The dual-port memory in this emulator is 32 bits wide.

In addition to the 4K of dual-port memory, there are also two memory sockets on the probe. This memory is not dual-ported; the monitor is used to read and write the locations when you display or modify this memory. The bus width for this memory is 32 bits. You can install 256-Kbyte or 1-Mbyte SRAM memory modules in these sockets.

The following table lists the possible installation combinations of memory modules. For each installation, the “Blocks Available” indicates the minimum amount of memory that will be allocated if you specify a map term with that block size or less. If you need to use emulation memory, you should examine your target system design and install memory in the way that will maximize block usage. (See the examples.)



Chapter 10: Configuring the Emulator
Emulator Configuration Items

| Installation | Memory slot 0² | Memory slot 1² | Blocks Available |
|----------------------|----------------------------------|----------------------------------|-------------------------|
| 1 | 256K | 256K | 4-64K, 2-128K |
| 2¹ | 256K | 1M | 4-64K, 2-512K |
| 3 | 1M | 256K | 4-256K, 2-128K |
| 4 | 1M | 1M | 4-256K, 2-512K |
| 5 | 256K | Empty | 4-64K |
| 6 | 1M | Empty | 4-256K |
| 7 | Empty | 256K | 2-128K |
| 8 | Empty | 1M | 2-512K |

¹ Installation 2 is not recommended because it does not allocate blocks as well as installation 3.

² If you look down at the component side of the probe with the cables leading towards you, memory slot 0 is to your left and memory slot 1 is to your right. Illustrations in the *68020/030 Graphical User Interface User's Guide* manual identify the locations of slot 0 and slot 1.



< fcode>

Specifies a function code space for the memory as follows:

| < fcode> | Description |
|--------------------|--------------------------|
| program | Program space |
| data | Data space |
| user | User space |
| supervisor | Supervisor space |
| user program | User program space |
| user data | User data space |
| supervisor program | Supervisor program space |
| supervisor data | Supervisor data space |

< memory_type>

Specifies the location and type of memory. The choices are as follows:

| Type value | Memory Assigned |
|---------------|-------------------|
| emulation ram | Emulation RAM |
| emulation rom | Emulation ROM |
| target ram | Target System RAM |
| target rom | Target System ROM |
| guarded | Guarded memory |

< attribute>

Attributes control specific functionality on a term-by-term basis. Attributes can be the following:

- dp** places this block in the special 4-Kbyte block of dual-ported emulation memory on the probe. (Dual-ported memory can be accessed by the host controller without the emulation monitor program, which means that your program executes uninterrupted during the access.)
- dsi** causes target system and emulation $\overline{\text{DSACKs}}$ to be interlocked. (The MC68030/EC030 emulator also interlocks the $\overline{\text{STERM}}$ signals when you choose **dsi**.)
- ci** asserts the $\overline{\text{CIIN}}$ line to the MC68030/EC030 for all addresses in this memory block. This prevents caching of

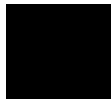

Chapter 10: Configuring the Emulator

Emulator Configuration Items

accesses to this block. This attribute is available only on the MC68030/EC030 emulator.

If you specify the **dsi** attribute, the emulator waits for both the emulation memory data to become valid and the target system **DSACK** to be returned before it terminates an emulation memory cycle. This makes the bus cycle length identical to that of your target system, so that timing will be the same. If your target system does not return **DSACK** in the address range mapped to emulation memory, don't use the **dsi** attribute because the system will stop to wait for the target **DSACK**. (See “To Interlock Emulator and Target **DSACKs** for Monitor Cycles” for more information.) For the MC68030/EC030 emulator, the target system **STERM** signal is also used for cycle termination if you specify the **dsi** attribute.

If you don't specify the **dsi** attribute when you map a memory block, the target **DSACK** and **BERR** signals (and **STERM** for the MC68030/EC030) are ignored on accesses to that block.

If you specify the **ci** attribute (MC68030/EC030 emulator only), the $\overline{\text{CIIN}}$ (cache inhibit input) line is asserted for accesses to that memory block. This prevents instructions or data from that memory block from being loaded into the processor cache memory. If you need to disable caching for all memory accesses, such as when you are tracing activity in all of the address ranges, answer **no** to the question “Enable the 68030 instruction and data cache”.

The attributes that are valid with a given term depend on the emulator (MC68020 or MC68030/EC030) and what kind of memory the term applies to (emulation or target).

In addition to the base attributes, the interface defines some combinations of attributes for you. The following two tables list the base and combination attributes for the two emulators, and indicate the memory type for which each attribute is valid.

MC68020 (HP 64748)

| Attribute | Description | Emulation Memory | Target Memory |
|------------------|---|-------------------------|----------------------|
| dp | Use dual-port memory. | Yes ¹ | No |
| dsi | Interlock DSACKs | Yes | No |
| dp_dsi | Use dual-port memory and interlock DSACKs | Yes ¹ | No |

1. Only valid for the 4K dual-port memory.

MC68030/EC030 (HP 64747)

| Attribute | Description | Emulation Memory | Target Memory |
|------------------|---|-------------------------|----------------------|
| dp | Use dual-port memory. | Yes ¹ | No |
| dsi | Interlock DSACKs and STERM | Yes | No |
| ci | Inhibit caching | Yes | Yes |
| dp_dsi | Use dual-port memory and interlock DSACKs and STERM | Yes ¹ | No |
| dp_ci | Use dual-port memory and inhibit caching | Yes ¹ | No |
| dsi_ci | Interlock DSACKs and STERM and inhibit caching | Yes | No |
| dp_dsi_ci | Use dual-port memory, interlock DSACKs and STERM, and inhibit caching | Yes ¹ | No |

1. Only valid for the 4K dual-port memory.

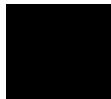

Chapter 10: Configuring the Emulator

Emulator Configuration Items

- Assign the memory map default by entering **default < type>** .

where **< type>** may be one of:

guarded

target rom

target ram

The default map term tells the emulator how to treat all address ranges not otherwise covered by existing memory map terms. You may want to know when the processor accesses a nonexistent memory location during a program run. Use the **guarded** map type to do this. The emulator will break to monitor and display a message when a guarded memory access occurs.

- Delete a particular memory map term by entering **delete < term# >** where **< term# >** is in the range 1-7.

or

Remove all memory map terms and reset the map by typing **delete all** .

If you want to add a term that overlaps an address range that is already represented by an existing term, you must either redefine or delete the existing term.

- End the mapping session by entering **end**.

Example

Suppose you're using the emulator in-circuit, and there is a 12-byte I/O port at 1c000 hex in your target system. You have ROM in your target system from 0 through ffff hex. Also, you want to use the dual-port emulation memory at 20000 hex:

```
1c000h thru 1c0ffh target ram
0 thru 0ffffh target rom
20000h thru 20fffh emulation ram dp
```

Remember that when you use the background monitor, the dual-port (**dp**) emulation memory is available for your target programs.

The relationship between memory ranges and the block sizes of memory is easier to understand by looking at an example. Suppose you have Installation 1 from the table of installation combinations of memory modules earlier in this chapter. Then you enter the following map commands:

```
0 thru 7fffh emulation ram
20000h thru 3f000h emulation ram
40000h thru 4ffffh emulation ram
50000h thru 500ffh emulation ram
default target ram
```

If you haven't used the dual-port emulation RAM, the first map term that will fit is assigned to that memory. In this example, that is the last term you defined (the range from 50000..500ff). The entire 4 Kbyte block is reserved though you specified only a 256-byte range. Two 64K blocks and one 128K block are used from the other emulation memory, leaving two 64K blocks and one 128K block. One of the 64K blocks is used for the first map term, but 32K of that block is unused and unavailable. The third term uses the other 64K block. The second term uses part of the 128K block, leaving the rest unavailable.

Mapper resolution is independent of block allocation. In the above example, if you had **default guarded** and your program accessed 8000h, the emulator would do a guarded memory break.

Combinations of regular emulation memory and dual-port emulation memory may be confusing when you look at analysis displays. Assume you have installation 3 from the table. Suppose you reset the map, and then mapped a range covering 260 Kbytes:

```
0 thru 40fffh emulation ram
```

Chapter 10: Configuring the Emulator

Emulator Configuration Items

The emulator will allocate one 256K block from the SRAM memory modules and will use the 4-Kbyte, dual-port memory for the rest of the range. Only one mapper term is created (without the **dp** attribute). This combination of SRAM and dual-port memory affects the MC68020 emulator differently from the way it affects the MC68030/EC030 emulator. The MC68020 dual-port memory is 16-bits wide, which means you will see a change from 32-bit to 16-bit fetches as the processor crosses the boundary between the two memory types. The MC68030/EC030 dual-port memory is 32 bits wide, but you may still see a speed difference for dual-port memory accesses by the MC68030/EC030.

You can use function codes when mapping memory. For example, you might want to map separate ranges for user and supervisor function codes:

```
1000 thru 1ffffh supervisor emulation ram
1000 thru 1ffffh user emulation ram
```

Then, to load programs named `supprog.x` and `userprog.x` into the supervisor and user memory spaces, you would use the commands:

```
load supprog fcode s
load userprog fcode u
```

To modify the emulator pod configuration

You can define the way the emulator interacts with the target system interface by modifying the emulator pod configuration.

- Answer the question:

Modify emulator pod configuration?

yes to enter the series of emulator pod configuration questions.

no to bypass the emulator pod configuration questions and skip to the debug/trace options. (This is the default.)

To disable target system interrupts

You may want to disable target system interrupts if your target system interrupt logic doesn't work correctly or isn't finished. You may also want to disable these interrupts if the service routines and vectors aren't assigned. You may want to enable the interrupts if you're ready to test your interrupt handling routines.

- Answer the question:

Respond to target system interrupts?

- yes** to allow target system interrupts to be received by the processor. (This is the default.)
- no** to block target system interrupts from the emulation processor.

Target system interrupts are always disabled during background monitor execution. The foreground monitor also disables interrupts during certain critical routines, such as monitor entry and exit.

You can enable interrupts during the remainder of foreground execution. See the section on selecting and configuring the emulation monitor earlier in this chapter.

To preset the interrupt stack pointer and Program Counter

Normally, if you run the emulator from reset, the processor fetches the values at offsets 0 and 4 from the vector table and loads these values into the interrupt stack pointer and program counter registers. It then begins running from the program counter address value. (To run from reset, select **Execution**→**Run**→**From Reset**.)

Chapter 10: Configuring the Emulator

Emulator Configuration Items

There are cases where the interrupt stack pointer and program counter cannot be fetched from the reset vector table. For example, if you reset the emulator, break to the monitor, and then run the emulator, the stack pointer and program counter values will not be read from the normal locations. Your answers to the following two questions will allow the emulator to supply the needed values for the stack pointer and program counter.

1 Answer the question:

Reset value for Interrupt Stack Pointer?

Enter a 32-bit hexadecimal address for the initial value of the ISP. This value usually should correspond to the value loaded at offset 0 of your vector table. The default value is 1H. Since this is an invalid value, you must change it to a valid even address.

2 Answer the question:

Reset value for Program Counter?

Enter a 32-bit hexadecimal address for the initial value of the PC. This value usually should correspond to the value loaded at offset 4 of your vector table. The default value is 0ffffff hex, which is invalid. You must change it to a valid even address.

This configuration item is provided as a convenience. You can accomplish the same thing by using modifying registers to set the PC and ISP values while in the monitor.

Example

Assume that the memory range f00 thru fff is mapped as **emulation ram** and reserved as stack space in your design. To set the interrupt stack pointer to f40 hex and the initial program counter to 400h, answer the questions as follows:

Reset value for Interrupt Stack Pointer? 0f40h
Reset value for Program Counter? 0400h

To set the target memory access size

When you display or modify target system memory or emulation memory that is not dual-port, the emulator makes the MC68020 or MC68030/EC030 processor execute the monitor to read or write target memory locations. The access mode determines whether the emulator uses byte, word, or long word instructions for the memory accesses.

- Answer the question:

User memory access size?

bytes to have the monitor use byte data type for accesses to target memory.

words to have the monitor use word data type for accesses to target memory.

longs to have the monitor use long word data type for accesses to target memory.

If you see messages advising of a mismatch between memory access size and the amount of data supplied when you modify memory or load programs, you may need to change your answer to this configuration question.



To modify the debug/trace options

You can define certain break conditions for the emulator and choose whether to trace only target program cycles or all program cycles.

- Answer the question:

Modify debug/trace options?

yes to access the debug/trace configuration questions.

no to accept the current debug/trace configuration and skip to the simulated I/O configuration.

To break the processor on a write to ROM

If your program writes to a location mapped to emulation ROM, there is probably a logic error. You can have the emulator stop execution of your target program when this event occurs.

- Answer the question:

Break processor on write to ROM?

yes to cause the emulator to break into the monitor when a write to emulation or target ROM is detected.

no to ignore any writes to emulation or target ROM.

The memory in the emulation or target system will be changed by processor writes, even if that memory has been mapped as ROM.

To define the software breakpoint vector

The MC68020 and MC68030/EC030 emulators use the BKPT instruction to implement software breakpoints. The BKPT instruction has eight possible data operands. You can choose from seven of these for the software breakpoint function.

- Answer the question:

Vector number for software breakpoint (1..7)?

Enter a number in the range of 1 through 7 to use as the data value for the BKPT instruction. The default setting is 7. The BKPT 0 vector cannot be used as the software breakpoint vector.

When using the emulator in most target systems, the default (7) will work fine. Some target systems use the processor BKPT instruction to implement certain features, and in these systems, BKPT 7 may already have been assigned to implement target system features. When using the emulator in these target systems, you may want to choose a different breakpoint vector number to implement software breakpoints in your emulator.

Regardless of the BKPT vector number you choose, the emulator will process it, as follows:

When you define a breakpoint, the emulator saves the instruction at the address where the breakpoint is to be set and then writes a BKPT instruction at that address.

When the BKPT instruction is encountered during target program execution, the processor executes a breakpoint acknowledge cycle. The emulator forces the breakpoint to be taken, and then provides a monitor entry vector during the breakpoint vector fetch to allow the processor to enter the emulation monitor. The monitor replaces the BKPT instruction with the instruction that was saved earlier, and clears the breakpoint status.

Changing this configuration item disables any active breakpoints from the emulator breakpoint table.

To trace background or foreground operation

Normally, you'll use the emulation-bus analyzer to trace only your target program execution. However, sometimes you may want to analyze execution of the emulation monitor to help solve a problem with the interaction of the target system and the emulator.

- Answer the question:

Trace background or foreground operation?

- | | |
|-------------------|---|
| foreground | to trace only target program cycles. (This includes the foreground monitor.) |
| background | to trace only emulation monitor cycles, and only if you are using the background monitor. |
| both | to trace both target program cycles and emulation background monitor cycles. |

To configure the analyzer clock

The emulation-bus analyzer can capture bus cycles at data rates up to 25 MHz. The trace state and time counters are limited to lower speeds. The MC68020 processor is set to a slow analyzer clock by default, and does not need to be modified because the data rate is sufficiently low, even at the maximum clock rate of 33 MHz.

By default, the MC68030/EC030 analyzer data rate is set to **veryfast**. This processor has more complicated requirements due to the burst and synchronous access modes. The analyzer can capture all types of bus cycles correctly up to the maximum clock rate of 40 MHz, but it cannot count states or time at those higher speeds for certain bus cycle types.

- Answer the question:

Set the analyzer speed:

slow for a data rate less than or equal to 16.67 MHz.

fast for a data rate between 16.67 and 20 MHz.

veryfast for a data rate between 20 and 25 MHz.

The worst-case situation occurs during a zero-wait state burst cycle. The data rate for burst cycles is given by the equation:

$$\text{Data Rate} = \frac{\text{Processor Clock Rate}}{(1 + \text{number of wait states})}$$

To determine the correct answer to this question in the MC68030/EC030 emulator, calculate the maximum data rate by using the above equation. Remember that the emulator always inserts one wait state for all synchronous and burst accesses to emulation memory, and also must insert one wait state for synchronous and burst accesses to target memory when the external clock is greater than or equal to 25 MHz. Then choose the data rate option according to the data rate you calculate.

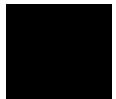

Chapter 10: Configuring the Emulator

Emulator Configuration Items

The trace state and time count qualifiers are limited by the analyzer data rate settings as follows:

| Analyzer clock rate | Analyzer speed setting | Valid count qualifier options |
|------------------------|------------------------|------------------------------------|
| clock \leq 16.67 MHz | slow | counting < state> counting time |
| clock \leq 20 MHz | fast | counting < state> |
| clock \leq 25 MHz | very fast | counting off |

Example

Suppose you are running the MC68030/EC030 processor at 40 MHz. You have answered “yes” to the configuration question “Is speed of external clock faster than 25 MHz?” because target memory requires one wait state for synchronous/burst accesses over 25 MHz. The resulting data rate is 20 MHz so you answer the configuration question as follows:

```
Set analyzer speed: fast
```

Note that you can use only the **nothing** debugger trace option. You cannot count time because the analyzer clock speed is too high.

To modify the simulated I/O configuration

The Softkey Interface provides a simulated I/O capability that you can use to test certain I/O-dependent parts of your program before target system hardware is complete.

- Answer the question:

```
Modify simulated I/O configuration?
```

```
yes to modify the simulated I/O configuration.
```

no to accept the current simulated I/O configuration and skip to the interactive measurement configuration questions. (This is the default.)

If you answer **yes** to this question, you will see a series of several more questions whose answers define the simulated I/O configuration. See the *Simulated I/O* manual for details on configuring and using simulated I/O.

To modify the interactive measurement specification

The HP 64700 Series emulators have internal trigger signals that allow you to coordinate measurements with associated instruments. The interactive measurement specification defines these trigger connections.

- Answer the question:

Modify interactive measurement specification?

yes to review and/or change the interactive measurement specification.

no to bypass the interactive measurement specification and skip to saving the configuration file.

If you answer **yes** to this question, you will see a series of several questions, whose answers define the interactive measurement specification. To give proper answers to these questions, refer to Chapter 6 in this manual. It explains how to make coordinated measurements.

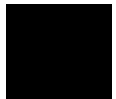

Mapping The Foreground Monitor For Use With The MC68030 MMU

To use the memory management feature of the MC68030 emulator, you have to use a foreground monitor that is mapped 1:1 (logical address = physical address). The reason that 1:1 monitor mapping is important is that the MC68030 MMU may be enabled or disabled at any time by your target system during execution of your target program; whether or not the MMU is enabled, the emulator must be able to enter the foreground monitor to provide emulation features. There are two ways to map the address range 1:1 where the foreground monitor is located:

- Modify the mapping tables in the MMU to maintain a 1:1 mapping of the memory address space where the foreground monitor is located. Make sure the mappings used for the foreground monitor are not write protected.
- Use one of the two transparent translation registers (TT0 or TT1) to control the block where the foreground monitor is located. You must remember to set the Read/Write Mask bit (RWM) to 1. Transparent translation registers can be set to translate only read accesses or only write accesses. To use a transparent translation register to control the address space of the foreground monitor, both read and write accesses must be enabled (by ignoring the R/W bit).



To modify the MMU mappings to translate the monitor address space 1:1

- 1 In the operating system that sets up the MMU for your target program, set aside a 4 Kbyte address space to contain the foreground monitor.

or

- 2 After the operating system for your target program has set up the MMU, but before you enable the MMU (with an appropriate TC register value), modify the MMU translation tables to ensure that the foreground monitor resides in logical address space that will be translated 1:1 to physical address space.

When you modify the content of any MMU mapping table, remember that the tables are located in physical address space. You must enter your modification commands by using physical addresses.

Select an address space to contain your foreground monitor that is higher than the address space used for your target program and I/O. This will optimize deMMUer resources by using them first to reverse-translate your target address space.

If you are mapping page sizes smaller than 4 Kbytes through the MMU mapping tables, ensure 1:1 translations for all of the pages that contain portions of the emulation foreground monitor.

See Also

"To modify the MMU mappings to translate the monitor address space 1:1" in the emulator/analyzer manual.

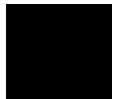

To modify a transparent translation register to map the monitor address space 1:1

- Modify the value of a transparent translation register to the base address you specified for the foreground monitor, or the first address within the range to be occupied by the foreground monitor.

Where transparent translation register may be TT0 or TT1, and the first address must begin on a 4-Kbyte boundary (hexadecimal number ending in 000H).

Examples

To map the foreground monitor to 1:1 address space beginning at 0800 0000H by using TT0, configure the base address:

Monitor's base address? 08000000h

Then set register TT0 to 08008777h. This will map 8000000..8ffffff transparently (1:1). This is a 16M block, the smallest that can be specified in a transparent translation register.

Part 3

Concept Guide

Part 3

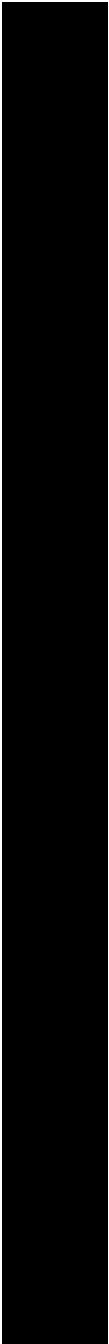

X Resources and the Graphical Interface

An introduction to X resources.

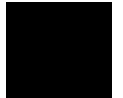

X Resources and the Graphical Interface

This chapter helps you to understand how to set the X resources that control the appearance and operation of the debugger's graphical interface. This chapter:

- Gives you an explanation of the X Window concepts surrounding resource specification.
- Gives you an explanation of the implementation of scheme files as used by the debugger's graphical interface.

The debugger's graphical interface is an X Window System application which means it is a *client* in the X Window System client-server model.

The X server is a program that controls all access to input devices (typically a mouse and a keyboard) and all output devices (typically a display screen). It is an interface between application programs you run on your system and the system input and output devices.

An X resource is user-definable data

A resource is a user-definable piece of data that controls the operation or appearance of an X Windows application. A resource may apply to an application (application-specific resources) or it may apply to the objects called widgets from which the application is constructed. That is particularly true of standard widget resources that control the appearance of an application. For example, most widgets have a standard resource that allows the user to specify the font used to display text on objects like buttons, menus, and labels.

An application-specific resource is defined by the application developer and may control such things as the mode of operation of an application. For example, you can use an application-specific resource for the debugger's graphical interface to control whether to start the interface with the command line on or the command line off.

A resource specification is a name and a value

Each resource in an application has a name and a value. Because an X Window System application is constructed from widgets, a resource name is

closely associated with the names of the widgets that make up the application. Each application begins with a top-level widget that is the parent of all other widgets in the application. The name of the top-level widget is usually the same as that of the application. This top-level widget may have a number of widgets “beneath” it that are called children of the top-level widget. The names for these widgets are most often chosen for their mnemonic value. These children can also in turn have child widgets. A resource name, then, is simply a name of a piece of data for the lowest-level widget coupled with a string of widget names picked up from each of the widgets along the path starting with the top-level widget and going down to the lowest-level widget.

The data name and widget names within a resource name are separated from each other by dots. The resource name itself is terminated by a colon. A resource value is simply the data value itself. Ignoring the widget names and data name for the moment, a common resource for most widgets is color. A data value for color might be “blue.”

To put this all together, a resource string for the foreground color for the “quit” pushbutton displayed on an application called “tracker” might look like the following:

```
tracker.panel.control.quit.foreground: white
```

Don't worry, there are shortcuts

As you might guess, specifying resources for applications with many levels of widgets can be difficult and error-prone. For that reason, you can use a shortened notation. To fully understand how the notation works, however, you must first understand about *instance names* and *class names*.

An *instance name* is a name given to a particular widget by an application developer. You have already seen instance names used. The name “quit” is an instance name for a pushbutton widget used by the developer of the “tracker” application from the last example. An instance name makes the pushbutton widget named “quit” unique from other pushbutton widgets in the “tracker” application.

A *class name* is a general name for all widgets of a particular type. For example, the class name for the OSF/Motif pushbutton widget is `XmPushButton`. When you refer to a widget in an application by its class name, you are referring to all widgets of that class in the application, and not to just a particular widget.

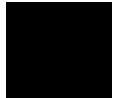

Instead of specifying the foreground color for the tracker quit button by using a resource name made up of instance names as in the last example, you could instead use a class name, as follows:

```
tracker.panel.control.XmPushButton.foreground: white
```

Using class names in this way makes it easier to specify resources because it relieves you from having to discover the names of particular widgets in an application. A long string of instance names or class names is still a long string of names, however. Fortunately, a wildcard helps to make the shortcut a true shortcut. The wildcard is an asterisk ("*"). It can be used to replace any number of class or instance names in a resource name. The last example could now be shortened to either of the following:

```
tracker*XmPushButton.foreground: white
```

```
tracker*quit.foreground: white
```

But wait, there is trouble ahead

An X Window System application maintains a complete list of resources, and the application knows the complete instance and class names for each resource. Because you can specify resource values using shortened notation, the application, when starting up, must match specified values to individual resources. Some general rules apply:

- Either a class name or instance name from the request must match each class or instance name in the application's list of resources.
- Entries prefixed by a dot are more specific and therefore have precedence over entries prefixed by an asterisk.
- Instance names are more specific and therefore have precedence over class names.
- Matching is done from left to right. Instance or class names appearing at the beginning of the specification have precedence over those later in the specification.

As you can quickly see, resource matching favors specific resource names over general resource names. General resource names, especially those involving class names, can have unexpected and unintended effects. Consider the last example again. The resource specification

```
tracker*XmPushButton.foreground: white
```

may not only set the foreground color of the quit button on the control panel of the application to white — it could also set the foreground colors for any pushbutton anywhere in the application. That is because the combination of the wildcard and the use of the class name make this resource specification match a resource request for any pushbutton in the application.

The second of the two specifications in the example does not completely solve the problem either. Suppose there was another button elsewhere in the application with the instance name of “quit.” (Duplicating instance names is correct as long as the widget paths to two different widgets of the same name are different.) The second specification of

```
tracker*quit.foreground: white
```

could match a resource request for that button as well because the wildcard allows the specification to match a number of different widget paths through the application.

Resource specification is usually a matter of trial and error. The following resource is probably specific enough to set just the foreground color for the quit button on the control panel:

```
tracker*control*quit.foreground: white
```

To view the resources in the debugger’s graphical interface, you can choose **Help**→**X Resource Names** and click on the “All names” button.

Class and instance apply to applications as well

Just as there are classes and instances of widgets, there are classes and instances of X Window applications. Resource specifications can be constructed in such a way that they apply to a whole class of applications, or just to an instance of those applications.

The class name for the debugger graphical interface products is *HP64_Debug*. The instance of the class that this debugger graphical interface falls under is called *debug*. A few examples are in order.

- For a given resource (called < resource >), the following specification applies to all debugger/emulator interface products for all processors:

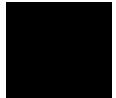

```
HP64_Debug*<resource>: <value>
```

- The following specification applies to all debugger/emulator products connected to 68000 emulators:

```
HP64_Debug.m68000*<resource>: <value>
```

- Finally, the following specification applies to all debugger/emulator graphical interfaces connected to 68000 emulators:

```
debug.m68000*<resource>: <value>
```

According to the precedence rules for resource matching, the first specification is the most general and would be overridden by either of the following two.

Resource specifications are found in standard places

There are a number of conventions for putting X resources in standard places so that applications can find them and use them when starting up. The least complicated model has the default resources for an application in a file in a system directory and user-defined resources in a file in the user's \$HOME directory.

The system directory for application default files is:

```
HP-UX          /usr/lib/X11/app-defaults
```

```
SunOS          /usr/openwin/lib/X11/app-defaults
```

The name of the default file is the same as the class name for the application and is also called the app-defaults file (for example, HP64_Debug is the name of the debugger's graphical interface's application defaults file). The name of the file in the user's \$HOME directory is *.Xdefaults*. Both files contain lists of resource specifications. The app-defaults file contains only resources for a specific application. The *.Xdefaults* file usually contains resource specifications for a number of different applications.

Also, it is possible for X resource specifications to point to *scheme files* in which other X resources are specified.

Why is it necessary to have at least two files? The application developer must supply a set of default resource values so that the application will at least

execute in the absence of user-defined resources. The developer does so in the `app-defaults` file. These defaults should not be changed by individual users because doing so affects the appearance and behavior of the application for all users of the application. Yet a user must have a location to put resources to override the default resources so the user can customize the application according to the user's needs or desires. The `.Xdefaults` file is that place.

Loading order resolves conflicts between files

If there are two files, then which resource specification from which file controls the resource in the application? That problem is solved by adhering to a loading order for files. Again, in the simple form, the application first loads the application default file and then loads the user's `.Xdefaults` file. Any resource specifications in the `.Xdefaults` file with exactly the same resource name as resource specifications in the application default file replace those from the application default file in the resource database. In that way, the resources specified by the user override the default resources in the application default file.

However, there are more than two places in which applications look for resource specifications when starting up. The following is a list of the standard places, in order, that an application looks to find resources:

- 1 The application default file.

The application default file for the graphical interface is called `HP64_Debug`. This file is created at software installation time and placed in the system application defaults directory.

- 2 `$XAPPLRESDIR/< class>`

This environment variable defines an alternative directory path leading to customized class files. Useful for directing the application to system-wide custom files.

- 3 `RESOURCE_MANAGER` property. Some X servers have a resource property associated with the root window for the server. Resources are added to the resource property database by using `xrdb`. (HP VUE is an example.) The server can use this property to access those resources.

If no `RESOURCE_MANAGER` property exists, then `$HOME/.Xdefaults` is read. The primary and probably best method for creating or adding to this file is by copying part or all of the `app-defaults` file into the `.Xdefaults` file.

- 4 `$XENVIRONMENT` file. This environment variable defines a file that contains resource specifications.

If the `XENVIRONMENT` variable is not set, then `$HOME/.Xdefaults-host` is read.

- 5 Command line options

Resources can be specified on the command line by using the `-xrm` command line option. The application strips these arguments out and sets these resources before passing the rest of the command line on to the application.

Remember, load order specifies the precedence for resource overrides. A resource found later in the load order overrides a resource found earlier in the load order if the resource specifications match each other.

The `app-defaults` file documents the resources you can set

The `HP64_Debug` file is complete, well-commented, and a good source of reference for graphical interface resources. The `HP64_Debug` file should be your primary source of information about setting graphical interface resources. This file can be easily viewed from the help topic menu by choosing **Help**→**General Topic** and selecting the “X Resources: Setting” topic.

To further assist you with setting X resources, there is also another topic on the help menu pull-down that you should use. Choose **Help**→**X Resource Names** to display the class and instance name for the graphical interface in a dialog box. From the dialog box, you can also display all widget class and instance names for all widgets that make up the debugger’s graphical interface. In most cases, you will not need to delve that far into the widget tree, but it is there if you choose to.

In addition to the `app-defaults` file, the graphical interface uses *scheme files*. Resources are not duplicated between scheme files and the `HP64_Debug` file. You may wish to set resources found in the scheme files as well, so you need to understand how scheme files relate to the interface and to the other X resource files.

Scheme files augment other X resource files

Hewlett-Packard realizes that the debugger’s graphical interface will be run in environments made up of workstations with different display capabilities and

even in environments with different types of computers (platforms) running the X Window System. The debugger's graphical interface, unlike many other X applications, makes determinations about display hardware as to the platform type, the resolution of the display, and whether the display is color or monochrome. The interface then loads the appropriate scheme files to allow the interface to come up in a reasonable way based on the hardware.

There are six scheme files. Their names and a brief description of the resources they contain follows:

| | |
|-------------|---|
| Debug.Label | Defines the labels for the fixed text in the interface. Such things as menu item labels and similar text are in this file. If the \$LANG environment variable is set, the scheme file "Debug.\$LANG" is loaded if it exists; otherwise, the file "Debug.Label" is loaded. |
| Debug.BW | Defines the color scheme for black and white displays. This file is chosen if the display cannot produce at least 16 colors. |
| Debug.Color | Defines the color scheme for color displays. This file is chosen if the display can produce 16 or more colors. |
| Debug.Input | Defines the button and key bindings for the mouse and keyboard. |
| Debug.Large | Defines the window dimensions and fonts for high resolution display (1000 pixels or more vertically). |
| Debug.Small | Defines the window dimensions and fonts for low resolution displays (less than 1000 pixels vertically). |

Debug.Label (or Debug.\$LANG) resides in the directory */usr/hp64000/lib/X11/HP64_schemes*. This directory is the upper level directory for scheme files. The other five files are in subdirectories below this one named by platform (or operating system). For example, the HP 9000 scheme files are in the subdirectory */usr/hp64000/lib/X11/HP64_schemes/HP-UX*.

Like the app-defaults file, these scheme files are system files and should not be modified directly.



You can create your own scheme files, if you choose

The debugger's graphical interface supports user-defined scheme files. The interface searches two places for user-defined scheme files and loads any it finds after loading the system scheme files. Refer to any of the scheme files mentioned for information about where to place your own scheme files.

Scheme files continue the load sequence for X resources

Scheme files extend the load order for finding X resources. System scheme file resources override all other resources gathered so far, and user-defined scheme files, in turn, override the system scheme files. Continuing from the load order list previously, the scheme files follow, in the order

- 6 /usr/hp64000/lib/X11/HP64_schemes/Debug.Label
/usr/hp64000/lib/X11/HP64_schemes/< platform> /Debug.< scheme>
- 7 \$XAPPLRESDIR/HP64_schemes/Debug.Label
\$XAPPLRESDIR/HP64_schemes/< platform> /Debug.< scheme>

Just as \$XAPPLRESDIR can point to a system-wide app-defaults file, so can it point to a set of system-wide scheme files.

- 8 \$HOME/.HP64_schemes/Debug.Label
\$HOME/.HP64_schemes/< platform> /Debug.< scheme>

Please note the dot (.) in the ".HP64_schemes" directory name.

You can force the debugger's graphical interface to use certain schemes

Five application-specific resources allow you to force the interface to use certain schemes. The resources and what they control are as follows:

HP64_Debug.platformScheme:

Controls the platform scheme chosen by the interface. This resource is particularly useful in mixed-platform environments where you might be executing the interface remotely on an HP 9000 computer, but displaying the interface on a Sun SPARCsystem computer. In this situation, you may wish to set the resource to use the SunOS scheme so that you can use the same key and mouse button bindings as other Sun OpenWindows applications.

The value of this resource is actually the name of a subdirectory under `/usr/hp64000/lib/X11/HP64_schemes` or one of the alternative directories for scheme files. You can create your own file and subdirectory under `/usr/hp64000/lib/X11/HP64_schemes` (or alternative) and then set this resource to choose that subdirectory instead of the standard platform subdirectory.

Values can be: HP-UX, SunOS, or the name of a sub-directory containing custom scheme files.

HP64_Debug.colorScheme:

Chooses the black and white or color scheme.

Values can be: Color, BW, or the name of a custom scheme file.

HP64_Debug.inputScheme:

Chooses the keyboard and mouse bindings.

Values can be: Input or the name of a custom scheme file.

HP64_Debug.sizeScheme:

Chooses the large or small scheme for fonts and sizes.

Values can be: Large, Small, or the name of a custom scheme file.

HP64_Debug.labelScheme:

Chooses a different label scheme for fixed text. Again, this resource is affected by the `$LANG` variable.

Values can be: Label, `$LANG` (if this environment variable is set and there is a `Debug.$LANG` scheme file), or the name of a custom scheme file.

These resources are in the `app-defaults` file. To override these resources, set them in your `.Xdefaults` file.

Again, setting X resources is a trial and error process. The scheme files used by the debugger's graphical interface simplify the process by collecting related resources in specific files.

To recap the organization:

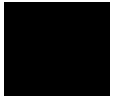

- The `app-defaults` file contains resources that control the operation of the interface. To override a resource in this file, copy the resource to your `.Xdefaults` file and change it there.
- Resources that control the appearance of the display and keyboard and mouse button bindings for your platform are in the scheme files. Copy the scheme files to an appropriate place and modify the resources found in them to change the look of the interface.

If you would rather place these resources in your `.Xdefaults` file, remember the load order. Make the resource name in the `.Xdefaults` file more specific or it will be overridden by the one in the scheme file.

The `app-defaults` file and the scheme files are your best sources of reference for help with modifying individual resources.

Resource setting - general procedure

Application specific resources

If you plan to modify an application-specific resource, you should look in the `HP64_Debug` file for information about that resource.

If the `RESOURCE_MANAGER` property exists (as is the case with HP VUE), copy the complete `HP64_Debug` file, or just the part you are interested in, to a temporary file. Modify the resource in your temporary file and save the file. Then, merge the temporary file into the `RESOURCE_MANAGER` property with the `xrdb -merge < filename >` command.

If the `RESOURCE_MANAGER` property does not exist, copy the complete `HP64_Debug` file, or just the part you are interested in, to your `.Xdefaults` file. Modify the resource in your `.Xdefaults` file and save the file.

Finally, if the debugger's graphical interface is currently executing, you must exit and restart the interface for the change to have any effect.

General resources

If you plan to modify a general resource that could not be found in the `HP64_Debug` file, look to the scheme files for information about that resource. A general discussion of the kinds of information found in the

Chapter 11: X Resources and the Graphical Interface

scheme files can be found in the previous “Scheme files augment other resources” section.

Copy the appropriate scheme file to one of the alternative directories and make the modifications there. (If you are using `$XAPPLRESDIR`, make sure the variable is set and exported.) Save the file. If the debugger’s graphical interface is currently executing, you must exit the application and restart it to see the results of your change.

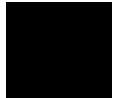

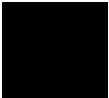

Part 4

Reference

Part 4

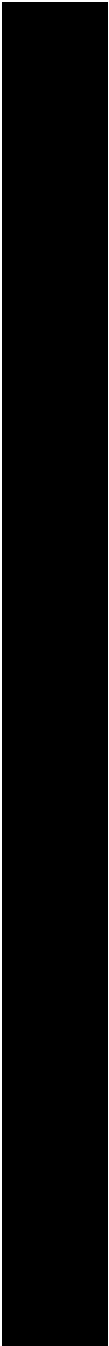

12

Debugger Commands

Detailed descriptions of command line commands.



How Pulldown Menus Map to the Command Line

| Pulldown | Command Line |
|---|--|
| File→Context→Directory | Debugger Directory Change_Working |
| File→Context→Symbols | Program Context Set |
| File→Load→Emulator Config | Debugger Execution Environment Load_Config |
| File→Load→Executable | Program Load Default |
| File→Load→Program Only | Program Load New Code_OnlyNo_Pc_Set |
| File→Load→Symbols Only | Program Load New Symbols_OnlyNo_Pc_Set |
| File→Load→User-Defined Macros | File Command < filename> |
| File→Store→Startup (.rc) file (as default) | File Startup |
| File→Store→Startup (.rc) file | File Startup < filename> |
| File→Store→User-Defined Macros | N/A |
| File→Store→BBA Data | Memory Unload_BBA < filename> |
| File→Copy Window→ | File User_Fopen Append < win> File < filename> |
| File→Log→Playback | File Command |
| File→Log→Record Commands | File Log On < filename> |
| File→Log→Stop Command Recording | File Log oFF |
| File→Log→Record Journal | File Journal On |
| File→Log→Stop Journal Recording | File Journal oFF |
| File→Emul700→Emulator/Analyzer (Graphic) | N/A |
| File→Emul700→Emulator/Analyzer (Term) | N/A |
| File→Edit→File | Debugger Host_Shell < editor> |
| File→Edit→At () Location | Debugger Host_Shell < editor_at_line> |
| File→Edit→At PC Location | Debugger Host_Shell < editor_at_line> |
| File→Term | Debugger Host_Shell |
| File→Exit→Window | Debugger Quit Yes |
| File→Exit→Locked | Debugger Quit Locked |
| File→Exit→Released | Debugger Quit Released |

| Pulldown | Command Line |
|--|--|
| Display→Context | N/A |
| Display→Memory→Mnemonic () | Memory Display Mnemonic |
| Display→Memory→byte | Memory Display Byte |
| Display→Memory→word | Memory Display Word |
| Display→Memory→long | Memory Display Long |
| Display→Source () | Program Display_Source |
| Display→Source at PC | Program Context Set |
| Display→Source Find Fwd () | Program Find_Source Occurrence Forward |
| Display→Source Find Back () | Program Find_Source Occurrence Backward |
| Display→Source Find Again | Program Find_Source Next |
| Display→C Expression () | Expression C_Expression |
| Display→Var/Expression () | Expression Display_Value |
| Display→Monitor Variable | Expression Monitor Value |
| Display→All symbols () | Symbol Display Default |
| Display→Symbols→Data & Macros () | Symbol Display Options Data¯os End_Options |
| Display→Symbols→Functions & Labels () | Symbol Display Options Functions&labels End_Options |
| Display→Symbols→Modules () | Symbol Display Options Modules End_Options |
| Display→Symbols→Browse C+ + Class () | Symbol Browse |
| Display→Error Log | N/A |
| Modify→Emulator Config | Debugger Execution Environment Modify_Config |
| Modify→C Expression () | Expression C_Expression < variable> = |
| Modify→Memory | Memory Assign |
| Modify→Memory at () | Memory Assign Long |
| Modify→Register | Expression C_Expression @reg |
| Execution→Run→from PC | Program Run |
| Execution→Run→from () | Program Run From |
| Execution→Run→from Transfer Address | Program PC_Reset - Program Run |
| Execution→Run→from Reset | Debugger Execution Reset_Processor Program Run |
| Execution→Run→until () | Program Run Until |
| Execution→Step Over→ | Program Step Over |
| Execution→Step→ | Program Step |
| Execution→Reset to Monitor | Debugger Execution Reset_Processor |
| Execution→Set PC to Transfer | Program Pc_Reset |

| Pulldown | Command Line |
|--|------------------------------|
| Breakpoints →Set→ Instruction () | Breakpt Instr |
| Breakpoints →Set→ Read () | Breakpt Read |
| Breakpoints →Set→ Write () | Breakpt Write |
| Breakpoints →Set→ Read/Write () | Breakpt Access |
| Breakpoints → Delete () | Breakpt Delete |
| Breakpoints → Delete All | Breakpt Clear_All |
| Breakpoints → Edit/Call Macro | N/A |
| Window → | Window Active < window name> |
| Settings → High Level Debug | Debugger Level High_Level |
| Settings → Assembly Level Debug | Debugger Level Assembly |
| Settings → Debugger Options | N/A |
| Settings → Command Line | N/A |



How Popup Menus Map to the Command Line

| Code window pop-pup | Command Line |
|------------------------------|---|
| Set/Delete Breakpoint | Breakpt Instr or Breakpt Delete |
| Attach Macro | N/A |
| Edit Attached Macro | N/A |
| Edit source | N/A |
| Run until | Program Run Until # < line_number> |
| Trace After | Trace Trigger Address Is # < line_number> Status Is CycTyp Fetch PosnTrig Start |
| Trace Before | Trace Trigger Address Is # < line_number> Status Is CycTyp Fetch PosnTrig End |
| Trace About | Trace Trigger Address Is # < line_number> Status Is CycTyp Fetch PosnTrig Center |
| Trace Until | Trace Trigger Address Is # < line_number> Status Is CycTyp Fetch BrkOnTrg PosnTrig End |

| Default window pop-up | Command Line |
|--------------------------------|---|
| Highlight/Toggle Window | Window Active/ < window_name> Window Toggle_View |
| Remove Window | N/A |

| Breakpoint window pop-up | Command Line |
|-------------------------------|------------------------------|
| Delete Breakpoint | Breakpt Delete < brkpt_nmbr> |
| Delete All Breakpoints | Breakpt Clear_All |

| Monitor window pop-pup | Command Line |
|-----------------------------|-------------------------------------|
| Delete Variable | Expression Monitor Delete < number> |
| Delete All Variables | Expression Monitor Clear_All |

| Backtrace window pop-up | Command Line |
|-----------------------------------|----------------------------------|
| Disp Source at Stack Level | Program Context Set @< level> |
| Disp Vars at Stack Level | Program Context Expand @< level> |
| Run Until Stack Level | Program Run Until @< level> |

| Status Line Popup | Command Line |
|---------------------------------|---------------------|
| Command Line On/Off | N/A |
| Remove Temporary Message | N/A |

| Command Line Popup | Command Line |
|-----------------------------|---------------------|
| Forward Tab | < Tab> |
| Backward Tab | < Shift> -< Tab> |
| Execute Command | < Return> |
| Clear to End of Line | < Ctrl> -E |
| Clear Entire Line | < Ctrl> -U |
| Command Line On/Off | N/A |

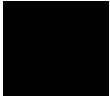

Command Summary

Breakpoint Commands

Breakpoint commands control execution of a program.

| Command | Definition |
|-------------------|---|
| Breakpt Access | Set a breakpoint on access (read/write) of an address |
| Breakpt Clear_All | Clear all breakpoints |
| Breakpt Delete | Delete specified breakpoints |
| Breakpt Instr | Set an instruction breakpoint |
| Breakpt Read | Set a breakpoint on a read from an address |
| Breakpt Write | Set a breakpoint on a write to an address |

Session Control Commands

The session control commands select debugger operating modes, set debugger session options, define and display macros, allow access to the host operating system, and end debugger sessions.

| Command | Definition |
|------------------------------------|---|
| Debugger ? | Access debugger on-line help |
| Debugger Directory | Display or change present working directory |
| Debugger Execution Display_Status | Display current directory and files in use |
| Debugger Execution Environment | Configure and control emulation environment |
| Debugger Execution IO_System | Control debugger simulated I/O |
| Debugger Execution Load_State | Restore previously saved debugger session |
| Debugger Execution Reset_Processor | Simulate microprocessor reset |
| Debugger Host_Shell | Enter HP-UX operating system environment |
| Debugger Level | Select debugger mode (high-level or assembly) |
| Debugger Macro Add | Create a macro |
| Debugger Macro Call | Call a macro |
| Debugger Macro Display | Display macro source code |
| Debugger Option | Set or list debugger options for this session |
| Debugger Pause | Pause debugger session |
| Debugger Quit | Terminate a debugging session |

Expression Commands

Expression commands calculate expression values, print formatted output to a window, and monitor variables.

| Command | Definition |
|------------------------------|--|
| Expression C_Expression | Calculate the value of a C expression |
| Expression Display_Value | Display the value of an expression or variable |
| Expression Fprintf | Print formatted output to a window |
| Expression Monitor Clear_All | Discontinue monitoring all variables |
| Expression Monitor Delete | Discontinue monitoring specified variables |
| Expression Monitor Value | Monitor variables |
| Expression Printf | Print formatted output to Journal window |

File Commands

File commands read and process command files, open files or devices for writing, log debugger commands to a file, and save debugger startup parameters.

| Command | Definition |
|--------------------|--|
| File Command | Read in and process a command file |
| File Error_Command | Set command file error handling |
| File Journal | Copy Journal window output to a journal file |
| File Log | Record debugger commands/errors in a file |
| File Startup | Save the default startup options |
| File User_Fopen | Open a file or device for read or write access |
| File Window_Close | Close the file associated with a window number |

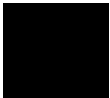

Memory Commands

Memory commands do operations on the target microprocessor's memory.

| Command | Definition |
|-------------------------------|--|
| Memory Assign | Change the values of memory locations |
| Memory Block_Operation Copy | Copy a memory block |
| Memory Block_Operation Fill | Fill a memory block with values |
| Memory Block_Operation Match | Compare two blocks of memory |
| Memory Block_Operation Search | Search a memory block for a value |
| Memory Block_Operation Test | Examine memory area for invalid values |
| Memory Display | Display memory contents |
| Memory Register | Change the contents of a register |
| Memory Unload_BBA | Unload BBA data from program memory |

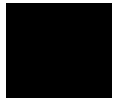

Program Commands

Program commands load and execute programs, control program execution, display source code and program variables, and set or cancel program interrupts.

| Command | Definition |
|--------------------------------|--|
| Program Context Set | Specify current module and function scope |
| Program Context Display | Display all local variables of a function |
| Program Context Expand | Display all local variables of a function at the specified stack (backtrace) level |
| Program Display_Source | Display C source code |
| Program Find_Source Occurrence | Find first occurrence of a string |
| Program Find_Source Next | Find next occurrence of a string |
| Program Interrupt Add | Simulate an interrupt |
| Program Interrupt Remove | Cancel all pending interrupts |
| Program Load | Load an absolute file for debugging |
| Program Pc_Reset | Reset the program starting address |
| Program Run | Start or continue program execution |
| Program Step | Execute a number of instructions or lines |
| Program Step With_Macro | Execute macro after each instruction step |

Symbol Commands

Symbol commands add, remove, and display symbols.

| Command | Definition |
|----------------|---------------------------------------|
| Symbol Add | Add a symbol to the symbol table |
| Symbol Browse | Browse C++ class |
| Symbol Display | Display symbol, type, and address |
| Symbol Remove | Delete a symbol from the symbol table |

Trace Commands

Trace commands let you do bus level tracing of your program activity with bus cycle store qualification of data.

| Command | Definition |
|-----------------------|--|
| Trace Again | Start a trace using the last defined trigger and qualification terms |
| Trace Display | Display trace information in the View window |
| Trace Event Clear_All | Clear (remove) all defined events |
| Trace Event Delete | Delete specified events |
| Trace Event List | List terms (conditions) of specified event |
| Trace Event Specify | Define an event (combination of bus conditions) |
| Trace Event Used_List | List summary of trace events in the View window |
| Trace Halt | Stop the current trace |
| Trace StoreQual | Specify the bus conditions to be stored (captured) |
| Trace StoreQual Event | Specify a previously defined event to be stored (captured) |
| Trace StoreQual List | List the current storage qualification terms |
| Trace StoreQual None | Disable current storage qualification terms (store everything) |
| Trace Trigger | Specify the bus conditions to be used to trigger (start) a trace |
| Trace Trigger Event | Specify a previously defined event to be used as the trigger |
| Trace Trigger List | List the current trigger terms in the View window |
| Trace Trigger Never | Disable current trigger terms (start trace on any bus state) |

Window Commands

Window commands do operations on the debugger windows.

| Command | Definition |
|--------------------|--|
| Window Active | Activate a window |
| Window Cursor | Set the cursor position for a window |
| Window Delete | Remove a user-defined window or screen |
| Window Erase | Clear data from a window |
| Window New | Make a new screen or window |
| Window Resize | Change the size of a window |
| Window Screen_On | Activate a screen |
| Window Toggle_View | Select the alternate display of a window |

Breakpt Access

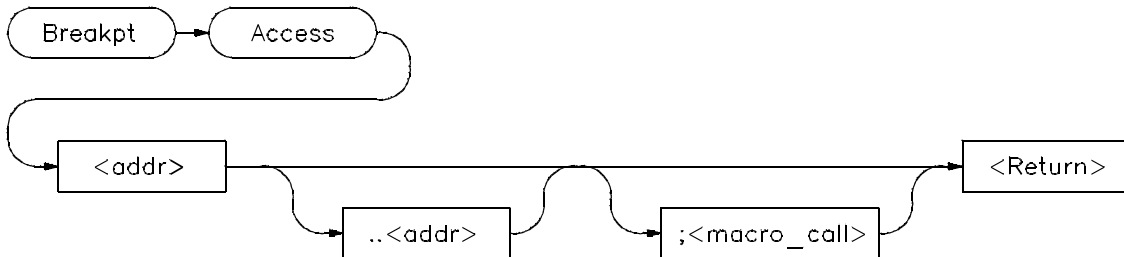

The Breakpt Access command sets an access breakpoint at the specified memory location (`< addr>`) or range (`< addr> ..< addr>`). The access breakpoint halts program execution each time the target program attempts to read from or write to the specified memory location or range. Memory locations may contain code or data.

You can attach a macro to a breakpoint using the optional `< macro_call>` parameter. See the chapter titled “Using Macros and Command files”.

Each time the debugger detects an access of the address or range, it does the following:

- 1 Suspends program execution.

Sometimes execution may stop a few instructions past the instruction causing the access. This is called "skid."

- 2 Executes a macro (if you attached one to the breakpoint). Depending on the macro return value, the debugger does one of the following actions:
 - If the macro return value is true (nonzero), the debugger resumes execution with the next instruction after the instruction that caused the read or write to the memory location. No breakpoint information is displayed.
 - If the macro return value is false (zero), the debugger returns to command mode and displays breakpoint information.
- 3 Returns to command mode if no macro was attached and displays breakpoint information.

Interaction with trace commands

The Breakpt Access command and Trace Trigger command both require use of emulation analyzer resources. If access breakpoints are active (indicated by the message *TRC: BrkRWA* on the status line), then a Trace Trigger command may not be entered. If a trace trigger is active, a Breakpt Access command may not be entered.

Note

If a trace is started using the emulator interface, debugger read/write/access breakpoints will be disabled until the trace has been completed. It is recommended not to use the debugger read/write/access breakpoints and the emulator interface trace specification feature at the same time.

The Breakpt Access command sets up a trace with the trigger at the end of the trace buffer, using the current storage qualification. You can display the trace after the break occurs to see the cycles leading up to the break.

See Also

| | |
|-------------------|---------------|
| Breakpt Clear_All | Breakpt Write |
| Breakpt Delete | Program Run |
| Breakpt Instr | Program Step |
| Breakpt Read | |

Examples

To set a breakpoint on accesses of addresses 'assign_vectors' through 'assign_vectors' + 16:

```
Breakpt Access &assign_vectors..+16
```

To set a breakpoint of access of the address of the variable 'current_temp':

```
Breakpt Access &current_temp
```

To stop program execution when the value of variable system_running is set or read as TRUE:

```
Breakpt Access &system_running; when (system_running==1)
```

The predefined macro 'when' is executed when the breakpoint is encountered.

Breakpt Clear_All



The Breakpt Clear_All command clears (removes) all defined breakpoints.

See Also

| | |
|----------------|---------------|
| Breakpt Access | Breakpt Write |
| Breakpt Delete | Program Run |
| Breakpt Instr | Program Step |
| Breakpt Read | |

Examples

To remove all defined breakpoints:

```
Breakpt Clear_all
```

Breakpt Delete

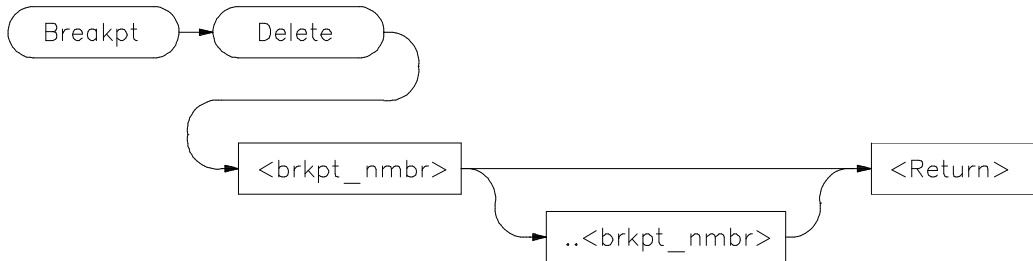

The Breakpt Delete command deletes (removes) one or more previously set breakpoints. When you set a breakpoint, the debugger assigns it a breakpoint number. Use this breakpoint number (<brkpt_nmbr>) to remove a specific breakpoint. You can delete a group of breakpoints by specifying a range of breakpoint numbers (<brkpt_nmbr> ..<brkpt_nmbr>). The debugger displays the breakpoint numbers in the Breakpoint window.

When you remove a breakpoint, the Breakpoint window displays the remaining breakpoints. Any breakpoints following the one removed are renumbered.

See Also

| | |
|-------------------|---------------|
| Breakpt Access | Breakpt Write |
| Breakpt Clear_All | Program Run |
| Breakpt Instr | Program Step |
| Breakpt Read | |

Examples

To delete breakpoint number 2:

```
Breakpt Delete 2
```

To delete breakpoint numbers 3 through 5:

```
Breakpt Delete 3..5
```

Breakpt Instr

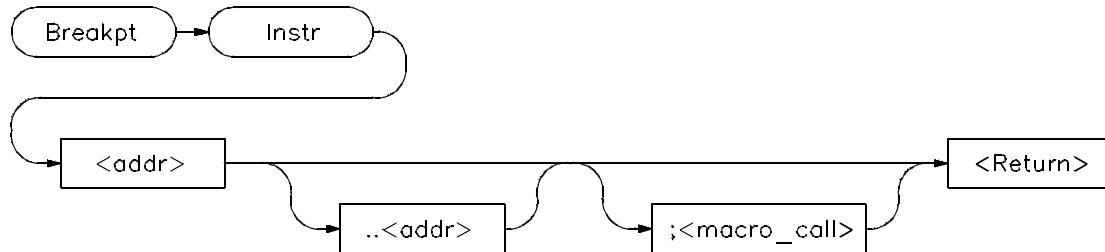

The Breakpt Instr command sets an instruction breakpoint at a specified memory location (< addr>) or range (< addr> ..< addr>). The instruction breakpoint halts program execution each time the target program attempts to execute an instruction at the specified memory location(s). If you specify a range, the debugger sets breakpoints on the first byte of each instruction within the specified range or (in high-level mode) the first instruction of each line within the range.

If you set a breakpoint for an overloaded C++ function, the debugger will ask you to choose which definition of the function to use. You can also specify the argument type of the function definition in parentheses after the function name in the Breakpt Instr command.

Note

The debugger/emulator cannot set instruction breakpoints on address locations in target ROM.

You can attach a macro to a breakpoint using the optional < macro_call> parameter. See the “Using Macros and Command Files” chapter.

The debugger performs the following actions when it encounters an instruction breakpoint:

- 1 Suspend program execution before the program executes the instruction at the breakpoint address.
- 2 Executes a macro (if you attached one when you set the breakpoint). Depending on the macro return value, the debugger does one of the following actions:

- If the macro return value is true (nonzero), the debugger resumes execution starting at the instruction where the break occurred. No breakpoint information is displayed.
 - If the macro return value is false (zero), the debugger returns to command mode without executing the instruction where the break occurred and displays breakpoint information.
- 3** Returns to command mode without executing the instruction where the break occurred if no macro was attached and displays breakpoint information.

See Also

| | |
|-------------------|---------------|
| Breakpt Access | Breakpt Write |
| Breakpt Clear_All | Program Run |
| Breakpt Delete | Program Step |
| Breakpt Read | |

Examples

To set an instruction breakpoint at line 82 of the current module:

```
Breakpt Instr #82
```

To set an instruction breakpoint at line 83 of the current module only when the system is running (using the predefined macro 'when'):

```
Breakpt Instr #83; when (system_running)
```

To set an instruction breakpoint starting at address 10deh and ending at address 10e4h:

```
Breakpt Instr 10deh..10e4h
```

To set instruction breakpoints beginning on lines 15 through 25 of module 'initSystem':

```
Breakpt Instr initSystem\#15..#25
```

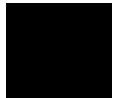

Breakpt Read

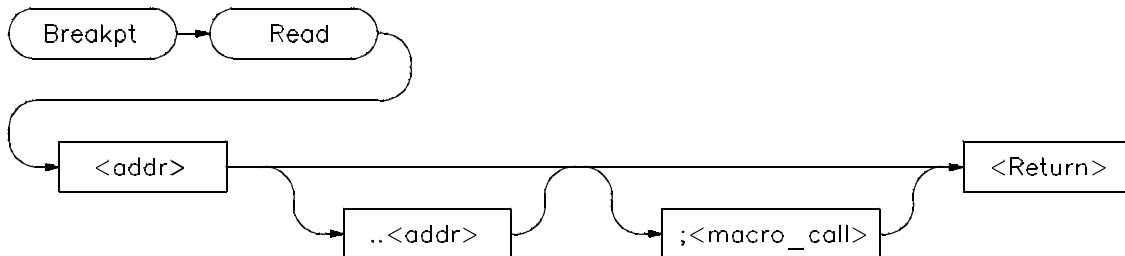

The Breakpt Read command sets a read breakpoint. The read breakpoint halts program execution each time the target program attempts to read data from the specified memory location (< addr>) or range (< addr> ..< addr>).

The Breakpt Read command behaves just like the Breakpt Access command.

See Also

Breakpt Access

Examples

To set a breakpoint on reads from variable 'system_running':

```
Breakpt Read &system_running
```

To set a read breakpoint starting at the address of variable 'current_temp' and ending 8 bytes after the address of 'current_temp':

```
Breakpt Read &current_temp..+8
```

To stop program execution when the value of variable system_running is read as TRUE:

```
Breakpt Read &system_running; when (system_running==1)
```

Breakpt Write

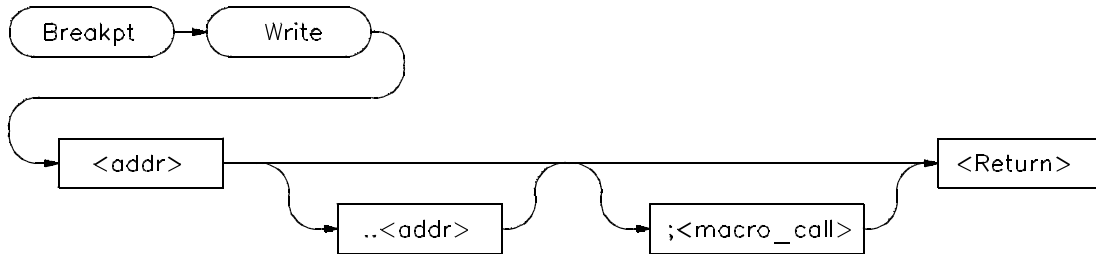

The Breakpt Write command sets a write breakpoint. The write breakpoint halts program execution each time the target memory attempts to write data to the specified memory location (< addr>) or range (< addr> ..< addr>).

The Breakpt Read command behaves just like the Breakpt Access command.

See Also Breakpt Access

Examples

To set a breakpoint to occur when the program writes a false value to variable 'system_is_running':

```
Breakpt Write &system_running; when (system_running==00)
```

To set a write breakpoint starting at the address of global variable 'current_temp' and ending 8 bytes after the address of 'current_temp':

```
Breakpt Write &current_temp..+8
```

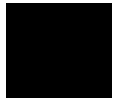

Debugger Directory

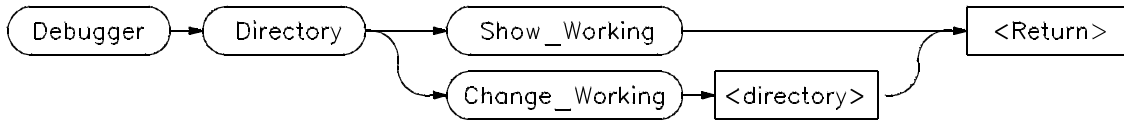

The Debugger Directory command displays or changes the current working directory. When you specify the *Show_Working* parameter, the debugger displays the current working directory in the journal window. When you specify the *Change_Working* parameter with a directory name, the debugger makes that directory the current working directory.

Changing the working directory will change the current working directory in all interfaces connected to the emulator.

Examples

To display the current working directory:

```
Debugger Directory Show_Working
```

To change the current working directory to /users/project/sources:

```
Debugger Directory Change_Working /users/project/sources
```

Debugger Execution Display_Status

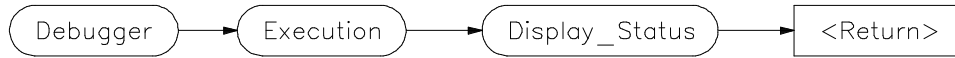

The Debugger Execution Display_Status command activates the debugger View window and displays the following status information:

- Version of debugger
- Current working directory
- Current log file
- Current journal file
- Startup file used in current debug session
- Loaded absolute files

If no files have been loaded, the absolute file will be missing from the display. If multiple executable files have been loaded using the Program Load Append command, they will be displayed in the View window. You may need to toggle the window (click on the window border) to see all of the files.

Example

To display product version, current working directory, and current log, journal, startup, and absolute files in the View window:

```
Debugger Execution Display_Status
```

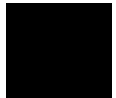

Debugger Execution Environment FwdCmd

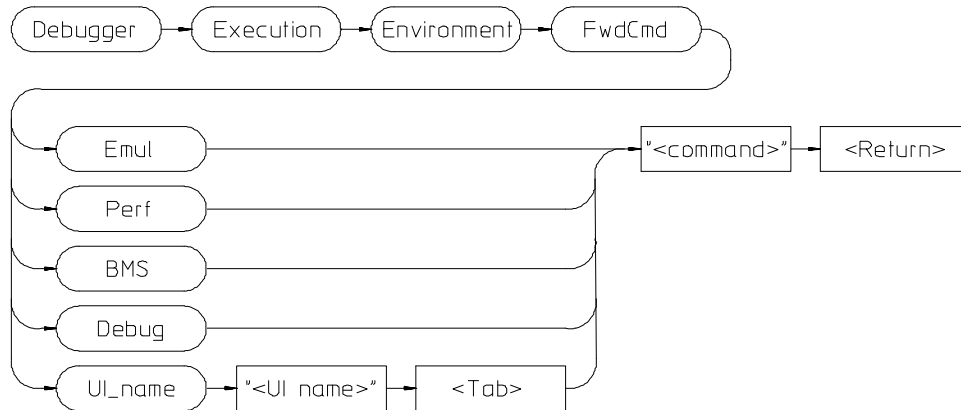

The Debugger Execution Environment FwdCmd command enables you to forward commands to other interfaces which are using the same emulator.

The other interfaces are:

| | |
|---------|---|
| Emul | Emulator/analyzer interface. If several emulator interfaces are sharing the emulator, the command will be forwarded to the most recently started interface. |
| Perf | Software Performance Analyzer. |
| BMS | Broadcast Message Server (the Softbench Gateway). |
| Debug | Debugger. This sends a command back to the debugger you are using. |
| UI_name | An interface described by a string. The command will be forwarded to an interface specified by a debugger or target string array (char *). |

If an interface of the type specified is currently running, the < command> will be executed there and any errors will be displayed in that interface.

See Also Predefined macro "cmd_forward".

Debugger Execution Environment Load_Config

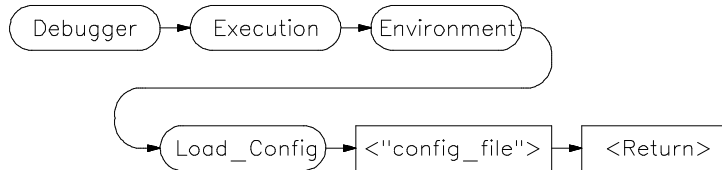

The Debugger Execution Environment Load_Config command loads an emulation configuration file for the emulator. The emulation configuration file contains configuration information for the emulator. The debugger/emulator accepts files generated by the emulation software or by an editor.

Note

You cannot use tilde expansion when specifying emulator configuration files with the *Debugger Execution Environment Load_Config* <"config_file"> command because the configuration file name must be enclosed in quotation marks. However, you may use shell environment variables.

See Also

The "Configuring the Emulator" chapter for detailed information on the modify configuration command.

Example

To load the emulation configuration file "mycnfig" (from within the debugger):

```
Debugger Execution Environment Load_Config "mycnfig"
```

Or, if "mycnfig" is in another directory:

```
Debugger Execution Environment Load_Config  
"$HOME/project/mycnfig"
```

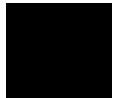

Debugger Execution Environment Modify_Config



The Debugger Execution Environment Modify_Config command starts a process which allows you to modify the current emulator configuration.

See Also The “Configuring the Emulator” chapter in this manual.



Debugger Execution IO_System

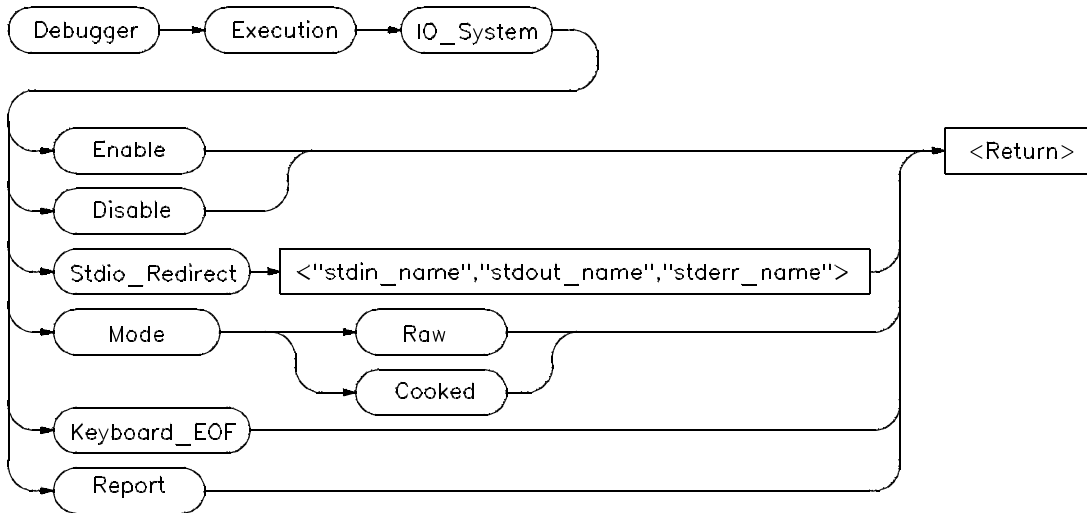

The Debugger Execution IO_System command enables you to configure the simulated I/O system to use the host system keyboard, display, and file system to simulate I/O devices for your target program.

Debugger Execution IO_System Enable

The Debugger Execution IO_System Enable command enables the debugger simulated I/O system. Remember, you also need to configure the emulator for simulated I/O polling and addresses.

Debugger Execution IO_System Disable

The Debugger Execution IO_System Disable command disables the debugger simulated I/O system.

Debugger Execution IO_System Stdio_Redirect

The Debugger Execution IO_System Stdio_Redirect command allows you to define the standard I/O input (< stdin_name >), output (< stdout_name >), and error (< stderr_name >) files/devices. These are file/device names in the

Chapter 12: Debugger Commands

Debugger Execution IO_System

host computer file system. Two special filenames allow you to access the system keyboard (/dev/simio/keyboard) and the system display (/dev/simio/display).

Debugger Execution IO_System Mode

The Debugger Execution IO_System Mode command selects how keyboard I/O input is processed. Keyboard I/O may be either cooked or raw.

Cooked Mode. In cooked mode, the target program gets input from the keyboard in the form of lines. Editing operations, such as backspace, line kill, etc., on input is done by the debugger. When **Return** or **CTRL D** is entered, the line is passed to the target program by the simulated I/O system. The keyboard input is echoed to the screen during the editing operation. If program execution is interrupted by entering **< Ctrl> -C** before the line is entered, the characters on the input line are lost.

Raw Mode. In raw mode, each keystroke is passed from the keyboard to the simulated I/O system with no processing. No carriage return is needed to enter characters and no editing operations are available. In the raw mode any character is valid, including *CTRL D*. No characters are echoed to the screen upon entry. The only special character that cannot be sent to the target program is **< Ctrl> -C** which is used to interrupt the debugger's execution of the program.

Debugger Execution IO_System Keyboard_EOF

The Debugger Execution IO_System Keyboard_EOF command causes the keyboard to return EOF (end of file). The keyboard stream is marked as being at EOF. Further reads from the keyboard return EOF.

Debugger Execution IO_System Report

The Debugger Execution IO_System Report command displays the status of the simulated I/O system.



See Also

The "Using Simulated I/O" section in the "Viewing Code and Data" chapter. The "Environment-Dependent Routines" chapter in the *68020 C Cross Compiler Reference* or *68030 C Cross Compiler Reference* manual.

Examples

To enable simulated I/O:

```
Debugger Execution IO_System Enable
```

To disable simulated I/O:

```
Debugger Execution IO_System Disable
```

To redirect the standard input file to the keyboard, the standard output file to the display, and the standard error file to file '/users/project/errorfile':

```
Debugger Execution IO_System Stdio_Redirect  
"/dev/simio/keyboard", "/dev/simio/display",  
"/users/project/errorfile"
```

To redirect the standard input file to 'temp.dat', the standard output file to 'cmdout.dat', and the standard error file to file 'errorlog.err':

```
Debugger Execution IO_System Stdio_Redirect  
"temp.dat", "cmdout.dat", "errorlog.err"
```

To set data input mode to cooked:

```
Debugger Execution IO_System Mode Cooked
```

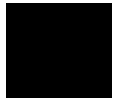

Debugger Execution Load_State

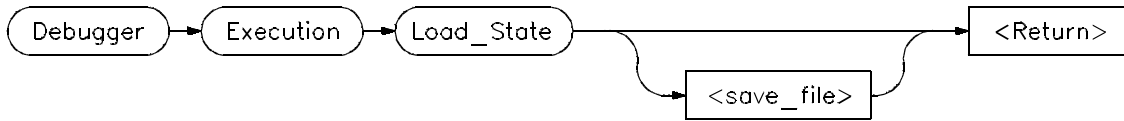

The Debugger Execution Load_State command restores the memory contents and register values saved with the debugger/simulator Debugger Execution Save_State command. If you do not specify a file name (< save_file>), the debugger uses the default file *db68k.sav* for the 68020 and the file *db68040.sav* for the 68030.

Example

To restore memory contents and register values saved in save file "session1":

```
Debugger Execution Load_State session1
```

Debugger Execution Reset_Processor

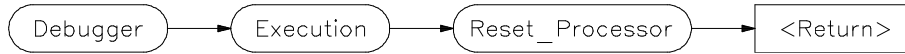

The Debugger Execution Reset_Processor command resets the microprocessor to its initial state. It performs the following operations:

- 1 The program counter is loaded from exception vector 1 at location 4.
- 2 The interrupt stack pointer is loaded from exception vector 0 at location 0 in memory.
- 3 The status register is reset as follows;
 - the trace bits are cleared,
 - the supervisor bit is set to 1,
 - the master bit is set to 0,
 - the interrupt priority mask is set to level 7.
- 4 All other bits in the status register are set to 0.
- 5 The vector base register is set to 0.
- 6 The cache control register is set to 0.
- 7 Any pending interrupt or exception is cleared.
- 8 Registers A0-A6 and D0-D7 are set to 0.
- 9 The emulator breaks into the emulation monitor.

Note

Memory is not reinitialized by the Debugger Execution Reset_Processor command. Therefore, C variables are not reset to their original values. Use the **Program Load New Code_Only** command to reset C variables.

See Also

Program Pc_Reset

Example

To reset the microprocessor:

```
Debugger Execution Reset_Processor
```

Debugger Host_Shell

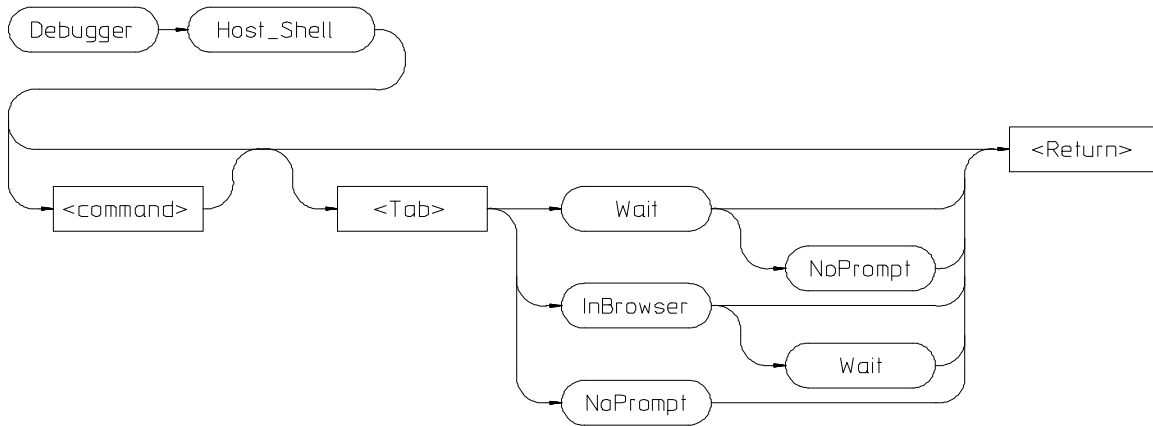

The Debugger Host_Shell command enables you to temporarily leave the debugging environment by forking an operating system shell or to execute a single UNIX operating system command from within the debugger. The type of shell forked is based on the shell variable SHELL. In this mode, you may enter operating-system commands. To return to the debugger, enter **CTRL D** or type **exit** and press the **Return** key.

You can execute operating system commands from within the debugger by entering a single operating system command with the debugger *Debugger Host_Shell* command. If you are using the graphical interface, the operating system command is executed in a "cmdscript" window. Press **< Return >** to close the window. If you are using the standard interface, *stdout* from the command is written to the Journal window and *stderr* is not captured. Commands writing to *stderr* will corrupt the display. Interactive commands **cannot** be used in this mode.

The following options are available only in the graphical user interface:

InBrowser

Directs *stderr* and *stdout* of the command into text browser windows.

Wait

Suspends the interface until the command completes.

NoPrompt

When the command completes, the "cmdscript" window is closed immediately.

See Also

Debugger Quit

Examples

To temporarily exit the debugger to the UNIX operating system command mode:

```
Debugger Host_Shell
```

To write the current working directory to the journal window:

```
Debugger Host_Shell pwd
```

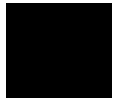

Debugger Help



This command displays the on-line help screen. The debugger provides on-line help for all debugger commands, debugger command arguments, and debugger function keys. You can access on-line help by entering the command **Debugger ?** or by pressing the **F5** function key.

If you are using the graphical interface, a Help dialog box will be displayed. If you are using the standard interface, a menu will appear in the display area.

If you enter the command *Debugger ?* in the standard interface, the debugger puts the cursor at the top of the topic list in the help menu. If you press the **F5** function key, the debugger puts the cursor at the entry for the command displayed on the command line (if one is displayed). Otherwise, the cursor is positioned at the top of the topic list. You can select topics from the help menu in two ways:

- Use the cursor keys to move to the desired topic and press the **Return** key.
- Type the first letter of the desired topic. This positions the cursor at that topic. Then press the **Return** key.

Use the **Return** key to see more topics in alphabetical order.

To exit help in the standard interface, press the **Esc** (escape) key twice or press function key **F5**.

Example

To display the debugger help screen:

`Debugger ?`

Debugger Level

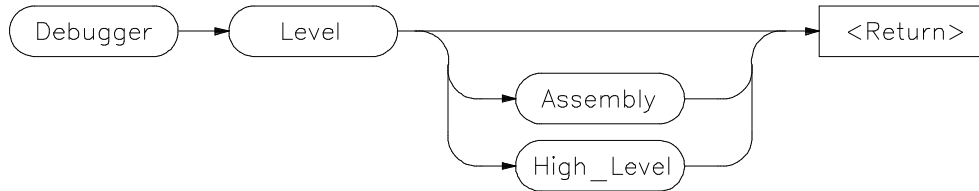

The `Debugger Level` command selects either high-level mode or assembly-level mode for debugging. When debugging programs containing C modules, you can switch back and forth between the two modes. If the program contains no high-level modules accessible to the debugger, the debugger displays an error message if you attempt to select high-level mode.

If no parameters are specified with this command, the mode is switched back and forth between the two modes, performing the same function as the `F3` function key.

Examples

To select the assembly-level debug mode:

```
Debugger Level Assembly
```

To select the high-level debug mode:

```
Debugger Level High_Level
```

To switch to the alternate debug mode:

```
Debugger Level
```

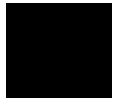

Debugger Macro Add

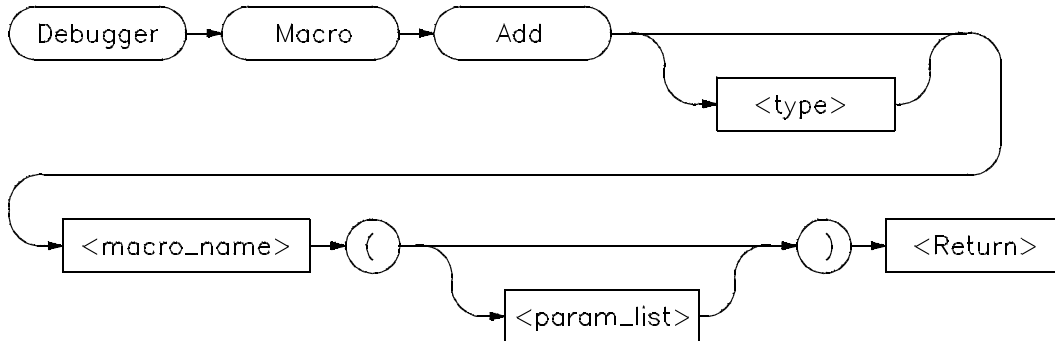

The Debugger Macro Add command defines a macro.

The name of the macro is specified by *<macro_name>*. The result type of the macro is specified by *<type>*. If a type is not specified, it defaults to type `int`. A parenthesized list of parameters (*<param_list>*) may optionally follow the macro name. Parameter names must be composed of alphanumeric characters. A maximum of 40 parameters is allowed.

When you enter the Debugger Macro Add command, the Journal window is automatically enlarged, and the debugger displays the macro text prompt character (`>`) indicating that you can enter the macro body.

Note

If the `stdio` screen or a user-defined screen is active when the Debugger Macro Add command is issued, the Journal window will not become active. Keyboard input at this point will be interpreted by the debugger as the macro definition.

To terminate the macro definition, a period (`.`) must be entered as the first and only character on a line.

The macro definition consists of all lines entered after the macro name and before the terminating period. The macro definition consists of the source lines of the macro (the macro body) and optional formal arguments. The syntax for the macro body is:

```
{macro_statement; [macro_statement;]...}
```

The curly braces ({ }) are required punctuation. Formal arguments can be used throughout the macro definition, and are later replaced by the actual arguments in the macro call.

The maximum number of characters that can be entered on a line in a macro definition is 255. When entering macros interactively, the debugger does not respond to more than 78 characters on a line. When reading a command file, the debugger stops recognizing characters after 255 characters have been read on a line.

The maximum number of lines allowed in a macro depends on the complexity of the lines. Macros with too many lines (too complex) will fail. Error 92 "*Not enough memory for expression*" will be displayed.

A macro is similar to a C function. The body can contain any legal C statement (except the SWITCH and GOTO statements). The statements IF, ELSE, DO, WHILE, FOR, RETURN, BREAK, and CONTINUE can be used to control program flow within a macro, just as in C. Macros have return types and can be used in expressions.

Note

Debugger commands may be used in macro definitions; they are indicated by placing a dollar sign (\$) at the beginning and the end of a command sequence. For example, the following command sequences are legal in macro definitions:

```
$Program Find_Source Occurrence Forward system$;  
or  
$  
Memory Assign Long &time=12  
Program Find_Source Occurrence Forward system  
$;
```

Macros can be executed by specifying the macro name on the command line in a Debugger Macro Call command, in an expression, or with a breakpoint command.

Macros can be removed using the command:

```
Symbol Remove <macro_name>
```

See Also

Breakpt Access
Breakpt Instr
Breakpt Read
Breakpt Write

Chapter 12: Debugger Commands

Debugger Macro Add

Debugger Macro Call
Debugger Macro Display
Program Run
Symbol Remove
The “Using Macros and Command Files” chapter
The “Predefined Macros” chapter in this manual.

Example

```
Debugger Macro Add int power(x, y)
int    x;
int    y;
{
    int    i;                /* Loop counter */
    int    multiplier;       /* Value x is multiplied by */

    /* Multiply x by itself y -1 times */
    for (i = 1, multiplier = x; i < y; i++)
        x *= multiplier;

    /* Return x ^y */
    return x;
}
.

Debugger Macro Add void stackchk()
{
    /* The symbols 'stack' and 'TopOfStack' exist in the compiler's */
    /* environment library, and are addresses which indicate the    */
    /* bottom and the top of the system stack. The symbol @sp is a  */
    /* debugger reserved symbol which contains the current value of */
    /* the processor's stack pointer.                                */
    $Expression Printf "%d bytes of stack used", TopOfStack - @sp$;
    $Expression Printf "%d bytes of stack available", @sp - stack$;
}
.
```

Debugger Macro Call

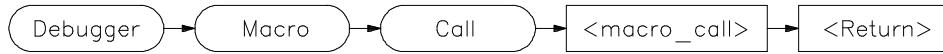

The Debugger Macro Call command calls a macro previously defined by the Debugger Macro Add command or a macro built into the debugger.

See Also

Debugger Macro Add
Debugger Macro Display
Symbol Remove

Example

To call the previously defined macro 'stackchk()':

```
Debugger Macro Call stackchk()
```



Debugger Macro Display

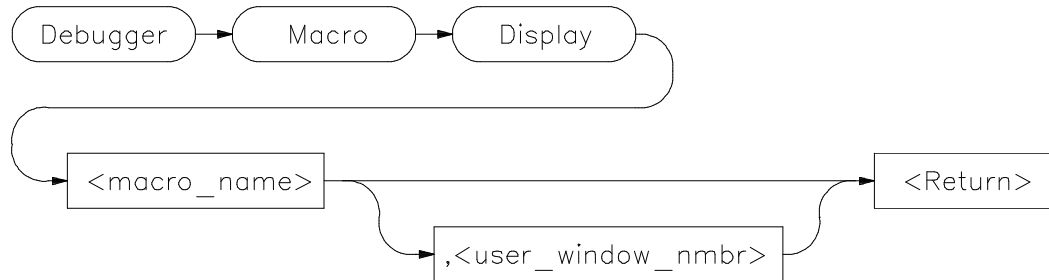

The Debugger Macro Display command displays the source code for the named macro. If a window number is specified (< user_window_nmbr >), the macro source is written to the file or user-defined window associated with the number. If you do not specify a window number, the macro source is written to the Journal window.

Macro source for built-in macros cannot be displayed.

See Also

Debugger Macro Add
File Command
Symbol Display

Examples

To display the source for macro 'stackchk' in user-defined window 57:

```
Debugger Macro Display stackchk,57
```

To display the source for macro 'stackchk' in the Journal window:

```
Debugger Macro Display stackchk
```

Debugger Option Command_Echo

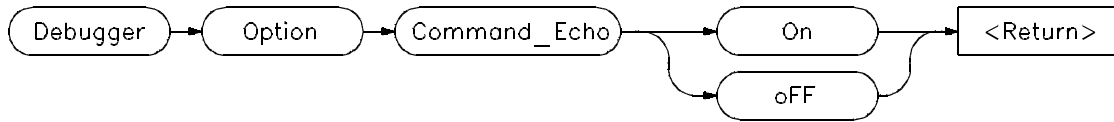

The Debugger Option Command_Echo command controls whether or not commands executed from a command file are echoed (copied) to the Journal window. If the *oFF* parameter is specified, only the results (if any) of a command are copied to the Journal window. If the *On* parameter is specified, both the command and its results (if any) are echoed to the Journal window. The default setting is *On*.

Examples

To turn OFF echo to the Journal window of commands executed from a command file:

```
Debugger Option Command_Echo oFF
```

To turn ON echo to the Journal window of commands executed from a command file:

```
Debugger Option Command_Echo On
```

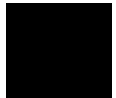

Debugger Option General

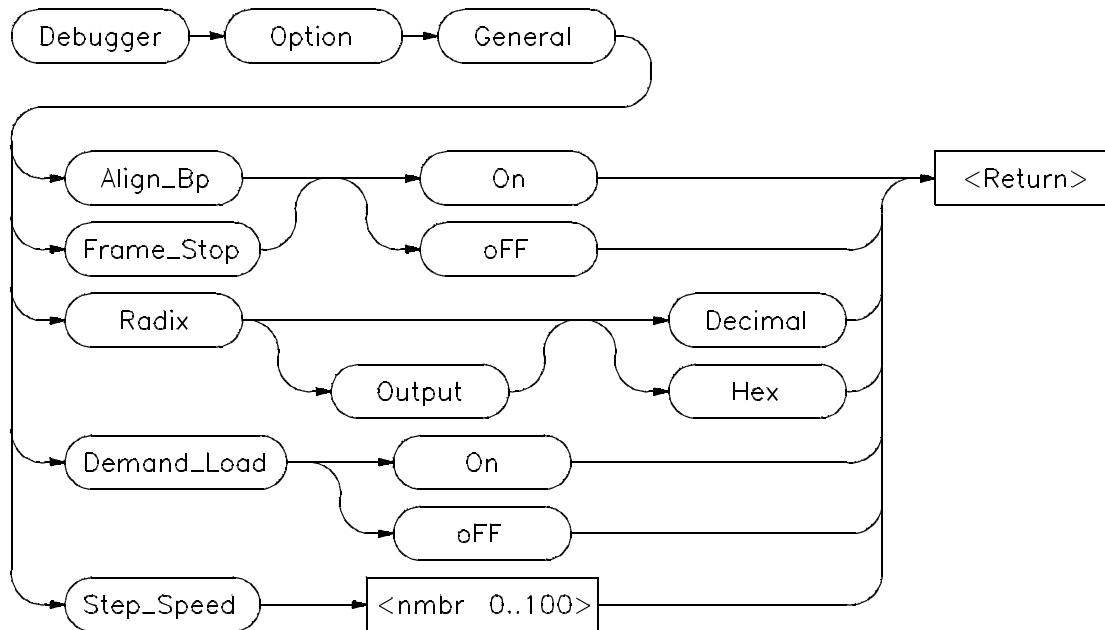

The Debugger Option General command changes the default values for the following debugger startup options for the current debugging session:

| | |
|-------------|---|
| Align_Bp | Aligns breakpoints with processor instruction start |
| Frame_Stop | Controls stack walking |
| Demand_Load | Enables/disables demand loading of symbols |
| Radix | Interprets numbers as decimal or hex |
| Step_Speed | Specifies the stepping speed |

Use the Debugger Option List command to display the current option values.

To permanently change any option default values, first use the Debugger Option command to change the value(s) and then use the File Startup

command to save the new default values in a startup file. See the File Startup command for more information.

Align_Bp

The `Align_Bp` option controls automatic alignment of low-level breakpoints and automatic alignment of disassembly. If the `Align_Bp` option is set to `On`, the debugger locates what it interprets as the starting address of all instructions in a module (by disassembling code from the beginning of the module). If you try to set the breakpoint at an address other than the start of an instruction, the debugger moves the breakpoint to the beginning of the next instruction and displays a warning. If you try to display memory mnemonically from an address other than the start of an instruction, the debugger moves the disassembly address to the beginning of an instruction. No Warning is displayed. If the `Align_Bp` option is set to `OFF`, the debugger lets you set the breakpoint at any address. The default setting is `OFF`.

Note

If multiple breakpoints exist in the same program area and `Align_Bp` is set to `On`, their alignment may be incorrect. Make sure the `Align_Bp` option is set to `OFF` to prevent breakpoint alignment problems.

Frame_Stop

When you set the `Frame_Stop` option to `On`, if the debugger encounters a bad stack frame, it displays only the valid stack frames below the bad frame in the Backtrace window. When you set the `Frame_Stop` option to `OFF`, the debugger displays all frames, including the bad frame. The default setting is `OFF`.

Demand_Load

When the `Demand_Load` option is set to `On`, the debugger loads some symbol information on an as-needed, demand basis rather than during the initial loading of the executable (.x) file. Symbol information for global symbols, local symbols in the source module containing main, and local symbols in assembly modules are loaded during the initial load of the executable file. Local symbols in C source modules other than that module which contains main are loaded when the debugger explicitly references the module or when the program is stopped with the program counter set to an address in the module. Demand loading lets you load and debug programs that you could not

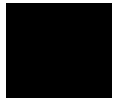

Chapter 12: Debugger Commands

Debugger Option General

otherwise load because of very large amounts of symbol information. The default setting for `Demand_Load` is `OFF`.

There are several side effects of demand loading. The debugger command `Memory Unload_BBA` is disabled. Type mismatch errors may not be detected during the initial load of the executable (.x) file. Global symbols may have leading underscores stripped, depending on whether they were defined or referenced in a C or assembly source module.

Radix

The `radix` option causes the debugger to interpret numeric literals, including integers and addresses, as either decimal or hexadecimal values. By default, numeric literals are interpreted as decimal values.

If you set `Radix` to hexadecimal, any number you want interpreted as decimal must be terminated with a `T` (for example, specify 32 as 32T). Binary numbers are not available when `Radix` is set to hexadecimal. Floating point and enumeration type values are not affected by the `radix` option.

The `Output` parameter lets you specify whether the output of the `Expression Display_Value`, `Expression Monitor Value`, and `Program Context Expand` command is displayed in decimal or hexadecimal format.

Step Speed

The `Step_Speed` option specifies the stepping speed. The stepping speed can be in the range of 0 to 100 units. Higher numbers represent slower speeds. This option affects the `Program Step` command. The default value is 0.

See Also

File Startup
Debugger Option List

Example

To align assembly-level breakpoints at the beginning of an instruction:
`Debugger Option General Align_Bp On`

Debugger Option List



The Debugger Option List command lists the current debugger option values in the Journal window. The list will be similar to the sample list shown in the example.

See Also Debugger Option Command_Echo
 Debugger Option General
 Debugger Option Symbolics
 Debugger Option View

Examples To list the current debugger option settings in the Journal window:

Debugger Option List

```
> Debugger Option List
Processor      = 68020
Intermixed    = On
Assem_Symbols = On
Step_Speed    = 0
Radix         = Decimal_Input, Decimal_Output
Stdio_Window  = Swap
Check_Args    = oFF
Align_Bp     = oFF
Breakpt_Window = Swap
More         = On
Highlight     = Inverse
Frame_Stop   = oFF
Command_Echo = oFF
View_Window  = Swap
Demand_Load  = oFF
Amt_Scroll   = 1
Trace_Counts = True
Fetch_Align  = Byte
```

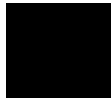

Debugger Option Symbolics

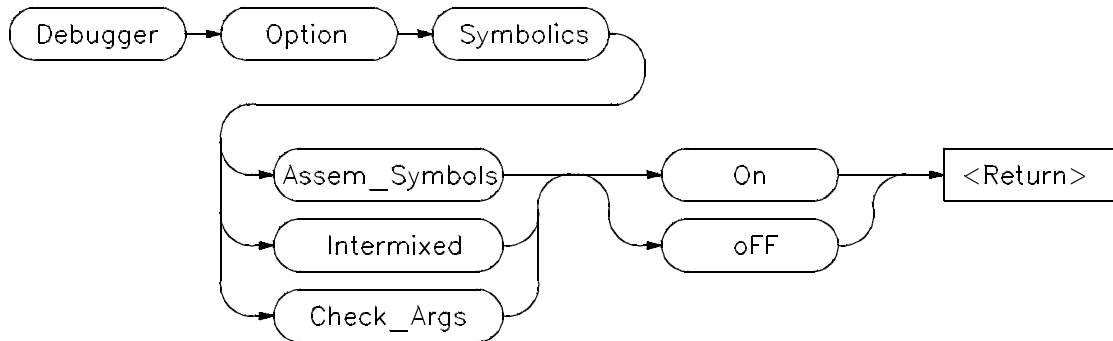

The Debugger Option Symbolics command changes the default values for the following debugger symbol options and C source line display options for the current debugging session:

| | |
|---------------|---|
| Assem_Symbols | Displays symbols in assembly code |
| Intermixed | Intermixes C source with assembly code |
| Check_Args | Enables parameter checking in commands and macros |

Use the Debugger Option List command to display the current option values.

To permanently change any option default values, first use the Debugger Option command to change the value(s) and then use the File Startup command to save the new default values in a startup file. See the File Startup command for more information.

Assem_Symbols

The Assem_Symbols option causes symbols instead of memory addresses to be displayed in the disassembled code whenever possible. Symbol names are placed to the right of the disassembled code for immediate values. This is done because there is no sure way of telling if the immediate value was represented by the symbol at assembly time. This option is set to *On* by default.

Intermixed

The Intermixed option intermixes C source code with the assembly code generated for each respective C statement. This option is off by default.

Check_Args

The Check_Args option controls parameter checking in commands and macros. If *OFF* is selected, the debugger does not do any argument checking. If *On* is selected, the debugger warns you when an assignment is made which contains a C type mismatch. This option is off by default.

See Also

File Startup

Examples

To display symbol names instead of address values in disassembled code:

```
Debugger Option Symbolics Assem_Symbols On
```

To turn OFF display of C source lines in assembly-level Code window:

```
Debugger Option Symbolics Intermixed OFF
```

To enable debugger expression parameter checking:

```
Debugger Option Symbolics Check_Args On
```

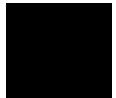

Debugger Option Trace

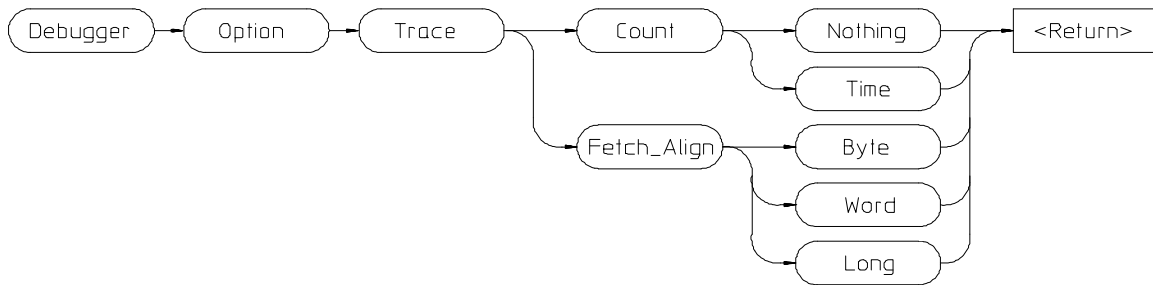

The Debugger Option Trace command changes the default behavior of bus-level tracing.

Count

If *Count* is *Nothing*, all of the trace memory will be used to store bus states.

If *Count* is *Time*, half of the trace memory will be used to store timing information.

The debugger interface does not display timing information. Use the emulator/analyzer interface to display timing.

Fetch_Align

The *Fetch_Align* option allows you to trigger a trace on an instruction's address which never appears on the bus. For example, this might happen when an instruction for a processor with a 32-bit bus lies between longword boundaries. The *Fetch_Align* operation masks address values so that they appear to occur on the boundaries appropriate for the processor's bus width.

Defaults are *Count Nothing* and *Fetch_Align Long*. If you are using 16-bit memory with a 68030, you should specify *Fetch_Align Word*.

See Also

Information about "equivalent addresses" in your analyzer manual.

Debugger Option View

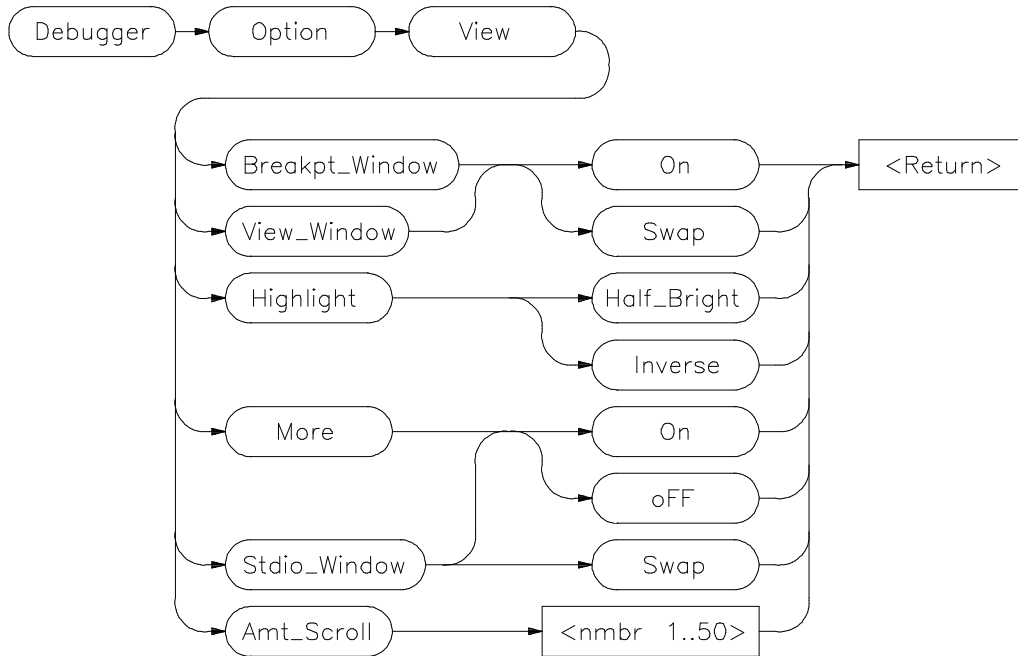

The Debugger Option View command changes the default values for the following debugger display options for the current debugging session:

- Breakpt_Window
- View_Window
- Highlight
- More
- Stdio_Window
- Amt_Scroll

Use the Debugger Option List command to display the current option values.

To permanently change any of the default values, first use the appropriate Debugger Option command to change the value(s) and then use the File Startup command to save the new default values in a startup file. See the File Startup command for more information.

Breakpt_Window

The Breakpt_Window option controls the display of the breakpoint window.

The *On* setting causes the Breakpoint window to be displayed at all times. The window may be hidden by other windows but will be displayed whenever a breakpoint is set or deleted.

If you specify the *Swap* setting, the window is not automatically displayed. You must set or delete a breakpoint or enter the Window Active Breakpoint command to display the window. The default setting is *Swap*.

View_Window

The View_Window option controls the display of the view window.

The *On* setting causes the View window to be displayed at all times. The window may be hidden by other windows but will be displayed whenever a Debugger Execution Display_Status command is executed.

If you specify the *Swap* setting, the window is not automatically displayed. You must enter the Debugger Execution Display_Status command or the Window Active View command to display the window. The default setting is *Swap*.

Highlight

The Highlight option determines whether highlighted information in debugger windows is displayed in half-bright video or inverse video. The default is Inverse.

More

The More option controls how information resulting from a debugger command is listed to the Journal window.

If the More option is *On*, information is listed one screen at a time in the Journal window, in the same way as the more command in the Unix operating system works.

If the More option is *OFF*, all information resulting from a debugger command is written to the display at once, making it difficult to view information greater than the number of lines available in the Journal window. The default setting is *On*.

Stdio_Window

The `Stdio_Window` option controls the display of the Stdio window.

The `Swap` setting causes the Stdio window to be displayed when a program writes to it and to be removed when the program returns to the command mode.

The `On` setting causes the Stdio window to be displayed at all times. The window may be hidden by other windows but will be displayed when a program is writing to it.

If the `OFF` setting is selected, the window is not automatically displayed. You must press function key **F6** or enter the command **Window Screen_On Stdio** to display the window.

The default setting is `Swap`.

Amt_Scroll

The `Amt_Scroll` option controls the amount that the Journal and Stdio windows are scrolled when written to. When the output reaches the bottom of the window, the data scrolls up one line by default. You can specify a number of lines from one to 50.

Examples

To set the `Swap` option so that the Breakpoint window is displayed only when the `Window Active Breakpoint` command is executed:

```
Debugger Option View Breakpt_Window Swap
```

To set the `View_Window` option so that the view window is always displayed:

```
Debugger Option View View_Window On
```

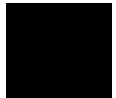

Debugger Pause

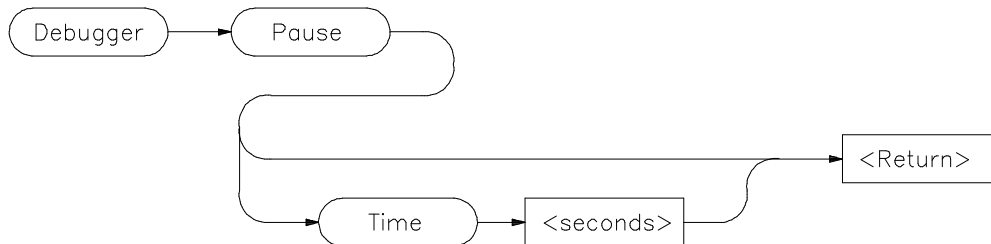

The Debugger Pause Time command pauses the debugger for the specified number of seconds or (if you enter the Debugger Pause command without the Time parameter) pauses the debugger until you press the space bar, **CTRL C**, or the escape key (**Esc**) twice. The Debugger Pause command is useful when executing command files.

See Also File Command

Examples To pause the debugger for ten seconds:

```
Debugger Pause Time 10
```

To pause the debugger until the space bar, CTRL C, or Esc-Esc is pressed:

```
Debugger Pause
```

Debugger Quit

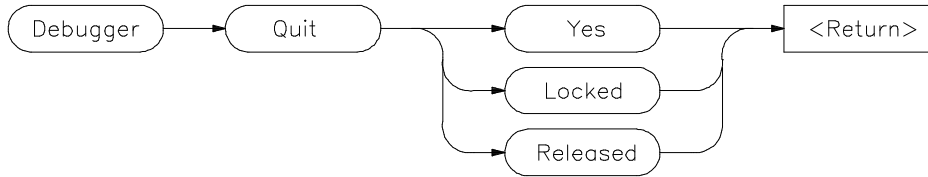

The Debugger Quit command ends a debugging session without saving the session. If you enter the command *Debugger Quit Yes*, the debugging session is immediately ended.

The Debugger Quit command does not save the debugging session. Use the File Startup command to save the current set of debugger startup options and window parameters in a startup file.

Yes Option

The Yes option terminates only this interface to the emulator. If this is the only interface using the emulator, the emulator will be left locked.

Locked Option

The Locked option lets you lock the emulation hardware (and a connected target system) so that other users cannot access the hardware until it is explicitly released.

This option will cause all interfaces connected to the emulator to disconnect.

Released Option

The Released option releases the emulation hardware to other users on the host computer system.

This option will cause all interfaces connected to the emulator to disconnect.

See Also

Debugger Host_Shell

Chapter 12: Debugger Commands

Debugger Quit

Examples

To terminate the debugging session immediately:

```
Debugger Quit Yes
```

To terminate the debugging session and release the emulator hardware so that other users can access it:

```
Debugger Quit Released
```

To terminate the debugging session and lock the emulator hardware so that other users cannot access it:

```
Debugger Quit Locked
```

Expression C_Expression

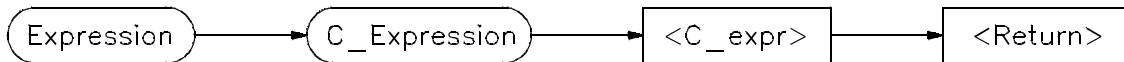

The Expression C_Expression command calculates the value of most valid C expressions or assigns a value to a variable. The result is displayed in floating point or in decimal, hexadecimal, and ASCII formats.

The Expression C_Expression command can be used to set C variables by specifying a C assignment statement. This command recognizes variable types, and the assignment expressions specified behave according to the rules of C.

Note

The Expression C_Expression command cannot evaluate conditionals of the form:

```
<expression>?<expression>:<expression>
```

Examples

To calculate the value of 'time' and display the result "data address 000091DC {time_struct}":

```
Expression C_Expression time
```

To calculate the value of member 'hours' of structure 'time' and display the result "4 0x04":

```
Expression C_Expression time->hours
```

To assign the value 1 to 'system_is_running' and display the result "1 0x01":

```
Expression C_Expression system_is_running = 1
```

Expression Display_Value

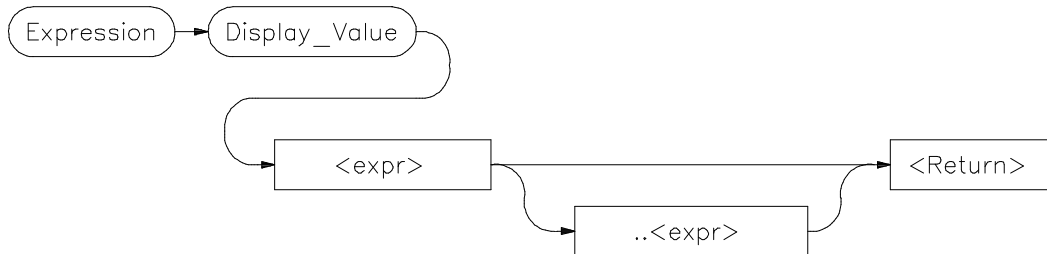

The Expression Display_Value command displays expressions and their values in the Journal window. All expressions displayed with this command are displayed according to their type as shown in the following list:

| Type | Display Format |
|-----------------|--|
| Ints | 32-bit signed decimal numbers |
| Longs | 32-bit signed decimal numbers |
| Shorts | 16-bit signed decimal numbers |
| Chars | 8-bit characters (unsigned hexadecimal numbers if not printable) |
| Pointers | 32-bit unsigned numbers |
| Enums | Name of Enumerator constant (enumerator value if name not defined) |
| Arrays | All elements |
| Structures | All members |
| Quoted String | All characters as typed, in by double quotes (" ") |
| Hex Byte | 8-bit hexadecimal |
| Hex Word | 16-bit hexadecimal |
| Hex Double Word | 32-bit hexadecimal |
| Float | 32-bit floating point |
| Double | 64-bit floating point |

Note The contents of an item such as an array is displayed instead of the C value of the item, which is its address.

If an expression range is displayed, each value within the range is displayed according to the base type (if one exists). For example, if the variable *flags* is a character array, the following command results in elements *flags[10]* through *flags[30]* being displayed:

```
Expression Display_Value flags+10..+30
```

Note that the command first evaluates *flags[10]* to a character, and uses this as the base of the address range. *Flags[30]* is also evaluated to a character. It is used as the end of the address range.

Any expression can be type cast to display it in a different format. All values that make up a complex type are printed. For example, if the variable *count* is a long, the following statement displays it as a four-character array:

```
Expression Display_Value (char[4])&count
```

To display the contents of a character array as a string, cast the variable using the quoted string cast, as shown in the following example:

```
Expression Display_Value (Q S)buf
```

If the type of the expression is unknown, it defaults to type byte. See the “Expressions and Symbols in Debugger Commands” chapter for more information about type casting.

See Also

Expression Fprintf
Expression Monitor Value
Expression Printf
Memory Display

Examples

To display the value of the variable 'system_is_running': 01h

```
Expression Display_Value system_is_running
```

To display the address of the variable 'system_is_running': 000091F0

```
Expression Display_Value &system_is_running
```

To display the address of the C structure 'time': 000091DC

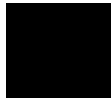

Chapter 12: Debugger Commands

Expression Display_Value

Expression Display_Value time

To display the values of the members of structure 'time':

```
hours    4  
minutes  0  
seconds 20
```

Expression Display_Value *time

To display the name of the current program module:

Expression Display_Value @module

To display the name of the current program function:

Expression Display_Value @function

Expression Fprintf

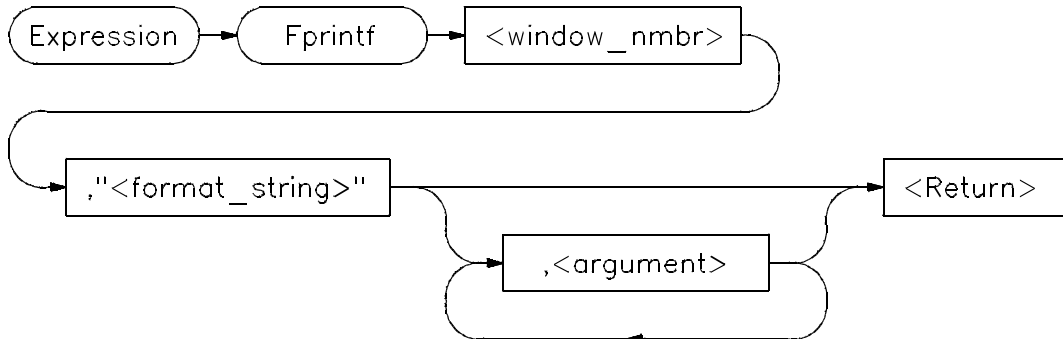

The Expression Fprintf command prints formatted output to the specified user-defined window. Formatted output may be written to a file that has been opened by the File User_Fopen command. The Expression Fprintf command is similar to the C fprintf function.

This command allows type conversions, scaling, and positioning of output in a file or in a window. The window number must have been previously assigned by a File User_Fopen or Window New command or the window number must be the log file number (28) or journal file number (29), if opened.

The command requires a format string as the second parameter. The format string may contain both text and argument conversion specifications. Whenever a conversion specification is encountered, the next argument is converted according to the specification, and the result is copied to the output window.

The conversion specifiers are similar to those in C and have the following format:

`%[-] [digits] [.[digits]] [l] conversion_char`

where:

`%` indicates the start of a conversion specification.

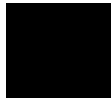

Chapter 12: Debugger Commands

Expression Fprintf

- indicates that the result of conversion is to be left-justified within the field.
- digits is a string of one or more decimal characters. The first *digits* is a minimum field width. The field will be at least this many characters wide, padded if necessary. The padding is normally on the left. When '-' is used, padding is on the right. The field is padded with blanks unless the first digit in *digits* is a 0; then the field is padded with zeros.
- separates two digit strings and must be specified if a second digit string is used.
- digits (second occurrence) is the maximum field width. For strings, it is the maximum number of characters to print; for f and e notations, it is the maximum number of fractional decimal places to print. For g notation, it is the number of significant digits to be printed.
- l indicates that a conversion character (d, x, or u) corresponds to a long argument.

Conversion Characters

Conversion characters are listed in the following table with a detailed description of each character.

| Char | Description |
|------|---|
| c | The argument is converted to character format. |
| d | The argument is converted to decimal format. |
| e, E | The float or double argument is converted to the format <code>[-]d.ddde+dd</code> , where the number of digits after the decimal point is equal to the precision. If precision is zero, no decimal point is printed. The default precision is 6. The E conversion character produces a number with E instead of e introducing the exponent. The exponent always contains at least two digits. |

- f The double argument is converted to decimal notation in the format [-]ddd . ddd, where the number of digits after the decimal point is equal to the precision specification. If the precision is not specified, it is 6 by default; if the precision is explicitly zero, no decimal point appears. If there is a decimal point, at least one digit appears before it.
- g, G The double argument is printed in f or e notation, or in F or E notation when G is used. The precision specifies the number of significant digits. The notation used depends on the value converted; e or E notation will be used only if the exponent resulting from the conversion is less than -3 or greater than or equal to the precision. Trailing zeros are removed from the result; a decimal point appears only if it is followed by a digit.
- h The argument is either the debugger internal variable @HLPC, or a high level line number preceded by the # character. Source lines are formatted as strings according to %s rules. (Note: See @HLPC in the "Reserved Symbols" chapter of this manual.)
- m The argument is an instruction address. The disassembled instruction is treated as a string.
- s The argument is a string. The characters from the string are copied to the output until a NULL character is encountered or the maximum number of characters specified have been printed.
- u The argument is converted to unsigned decimal format.
- v The argument is displayed according to its type.
- w The argument is is a window number. The current contents of the window are written to the specified window.
- X The argument is converted to hexadecimal. Letters are displayed in upper case. 0x is not printed before the value.

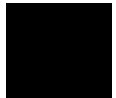

Chapter 12: Debugger Commands

Expression Fprintf

| | |
|---|---|
| x | The argument is converted to hexadecimal. Letters are displayed in lower case. |
| % | The character % is substituted for the field. Any other non-conversion character following a % is printed. %% is used to generate % in the output as a literal character. |

Conversion characters are case-sensitive. Values printed in E notation have the following format:

`[-] d . d . . E { + | - } d d`

Each *d* represents a decimal digit. The number is first scaled so that one digit appears to the left of the decimal point. The number of digits in the fractional part is six by default, or the maximum field width if specified. The sign of the mantissa is printed only if the number is negative. The sign of the exponent is always printed.

Values printed in F notation have the following format:

`[-] d d . . .`

Each *d* represents a decimal digit. The number of digits in the fractional part is six by default or the maximum field width if specified. The number of digits printed depends on the number of significant digits in the number.

Because floating point values are passed as parameters, they are converted to double precision. Parameters must be promoted to double precision values as a requirement of the C language. Other values passed as parameters may also be converted.

The Expression Fprintf command uses the format string to decide how many arguments to print. The number of conversion specifications must equal the number of arguments. If there are too many arguments, some of them will not be printed. If there are too few arguments, the value printed cannot be determined.

If the argument type does not correspond to its conversion field specification, arguments may be converted incorrectly.

See the Expression Printf command for details about conversion specifiers.

See Also Expression Printf
File Journal
File Log
File User_Fopen
Window New

Examples

To print value of 'var' to user window 57 as a single character:

```
Expression Fprintf 57,"%c",var
```

To print the string in double quotes to user window 57 followed by the floating point value of 'temperature' with a precision of 2:

```
Expression Fprintf 57,"The value of 'temperature' is:  
%.2f \n",temperature
```

To print source line 24 to user window 55:

```
Expression Fprintf 55,"%h",#24
```

To print the contents of the assembly-level stack window to user window 256:

```
Expression Fprintf 256,"%w",14
```



Expression Monitor Clear_All

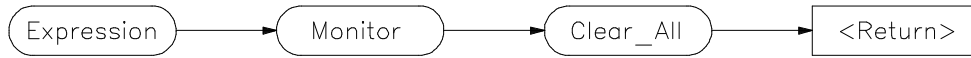

The Expression Monitor Clear_All command stops monitoring of all expressions being monitored with the Expression Monitor Value command and removes all expressions from the Monitor window.

See Also

Expression Fprintf
Expression Monitor Delete
Expression Monitor Value
Expression Printf
Memory Display

Examples

To stop monitoring all expressions:

```
Expression Monitor Clear_All
```

Expression Monitor Delete

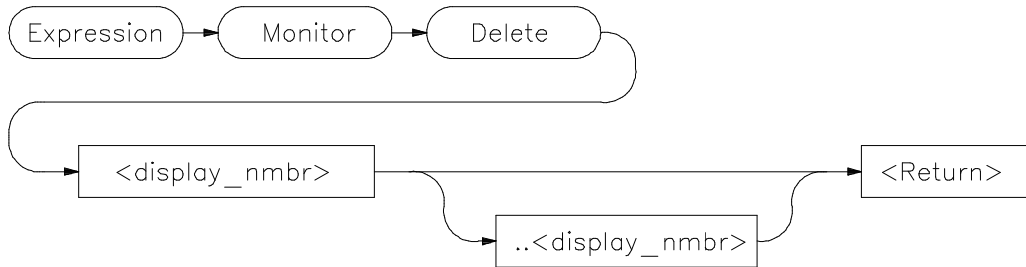

The Expression Monitor Delete command stops monitoring of specified expressions being monitored with the Expression Monitor Value command and removes those expressions from the Monitor window.

When an expression is monitored using the Expression Monitor Value command, it is assigned a line number, which is displayed in the Monitor window. These assigned line numbers are used to specify the expression or group of expressions to be deleted (removed). All monitored expressions can be deleted with the Expression Monitor Clear_All command.

See Also

Expression Fprintf
Expression Monitor Clear_All
Expression Monitor Value
Expression Printf
Memory Display

Examples

To stop monitoring expression 2 in the Monitor window:

```
Expression Monitor Delete 2
```

To stop monitoring expressions 3 through 6 in the Monitor window:

```
Expression Monitor Delete 3..6
```

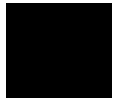

Expression Monitor Value

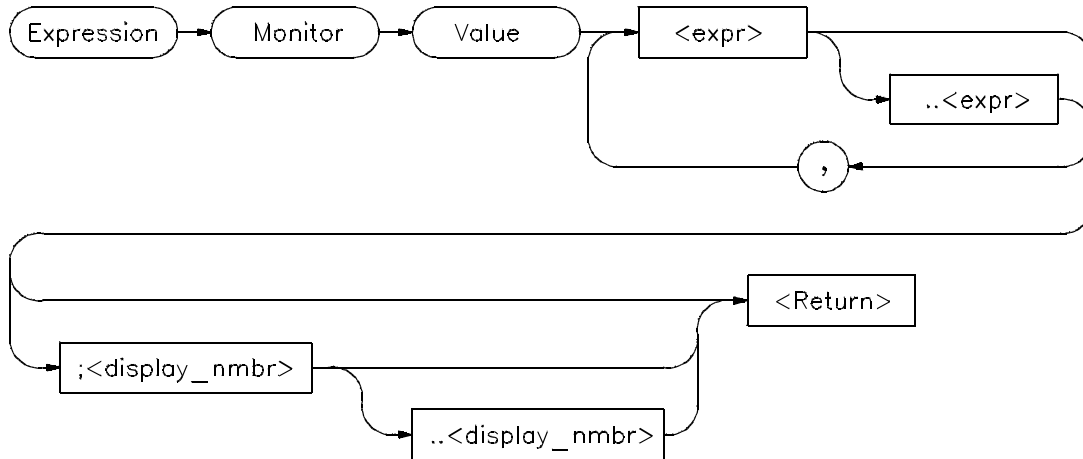

The Expression Monitor Value command monitors the specified expressions as the target program is executing. Expressions are updated and displayed in the Monitor window each time the debugger stops executing the program.

Up to seventeen lines, selected by the display line range parameter (`;< display_nمبر> ..< display_nمبر>`), can be displayed in the Monitor window.

Variables located in registers are shown with a ? between their names and values.

All expressions monitored with this command are displayed according to their type as follows:

| Type | Display Format |
|------|----------------|
|------|----------------|

| | |
|-----------------|--|
| Ints | 32-bit signed decimal numbers |
| Longs | 32-bit signed decimal numbers |
| Shorts | 16-bit signed decimal numbers |
| Chars | 8 bit characters (unsigned hexadecimal numbers if not printable) |
| Pointers | 32-bit unsigned numbers |
| Enums | Name of Enumerator constant (enumerator value if name not defined) |
| Arrays | All elements if enough lines, else first element |
| Structures | All members if enough lines, else first element |
| Quoted String | Characters surrounded by double quotes (" ") |
| Hex Byte | 8-bit hexadecimal |
| Hex Word | 16-bit hexadecimal |
| Hex Double Word | 32-bit hexadecimal |
| Float | 32-bit floating point |
| Double | 64-bit floating point |

If an expression range is displayed, each value within the range is displayed according to the base type (if one exists). For example, if the variable *flags* is a character array, the following command displays 20 characters.

```
Expression Monitor Value flags+10..+29
```

Any expression can be type cast to display its value in a different format. For example, if the variable *count* is a long value, the following statement causes *count* to be displayed as a four character array:

```
Expression Monitor Value (char[4])&count
```

If the type of the expression is unknown, it defaults to type byte.

Only 17 lines can be displayed in the data window. By default, a single line is used to display monitored expressions. If an array is monitored, only the elements that will fit on one line will be displayed. If a structure is monitored, only the first member will be displayed. To display an entire array or structure, a display line range may have to be specified. If all lines in the data window are filled, you must use the Expression Monitor Delete command to delete an expression before monitoring another one.

If you do not specify a display line range, the next available line in the data window is selected to display the monitored variable. If you specify one line,

Chapter 12: Debugger Commands

Expression Monitor Value

the expression is displayed on that line. If you specify a range of lines, the amount of data that will fit on those lines is displayed.

See Also Expression Monitor Clear_All
Expression Monitor Delete
Symbol Display

Examples

To monitor the value of variable 'current_temp':

```
Expression Monitor Value current_temp
```

To monitor the value of the three members in structure 'time' and display them on Monitor window lines 4 through 6:

```
Expression Monitor Value *time;4..6
```

To monitor the contents of string buf:

```
Expression Monitor Value (Q S)buf
```

Expression Printf

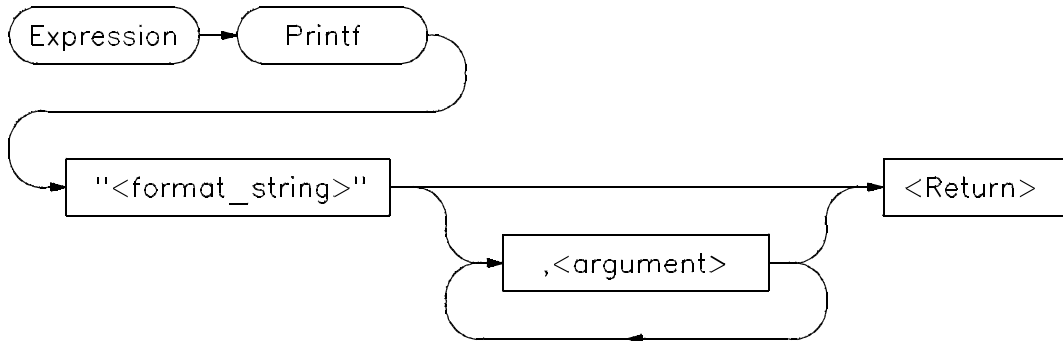

The Expression Printf command prints formatted output to the Journal window.

See the Expression Fprintf command for a detailed description.

See Also

Expression Fprintf
File User_Fopen

Examples

To print the string in double quotes to the journal window followed by the floating point value of 'temperature' with a precision of 2:

```
Expression Printf "The value of 'temperature' is: %.2f\n",temperature
```

To print source line 24 to the Journal window:

```
Expression Printf "%h",#24
```

To print the name of the current module to the Journal window:

```
Expression Printf "%s",@module
```

To print the disassembled instruction at address 2030h to the Journal window as a string:

Chapter 12: Debugger Commands

Expression Printf

```
Expression Printf "%m", 2030h
```

```
00002030 2040          MOVEA.L D0,A0
```

To print the contents of the assembly-level stack window to the Journal window:

```
Expression Printf "%w",14
```

```
> Expression Printf "%w",14
    00043FC8=00000690
FP->00043FC4=00043FF0
    00043FC0=000604AC
    00043FBC=00000001
SP->00043FB8=00000001
```

File Command

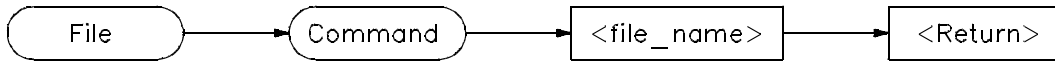

The File Command command reads the file specified by < file_name> and executes the commands contained in the file as though they were entered from the keyboard. Commands in the file are executed until the end of the file is reached. Input then continues from the previous source. The previous source can be the keyboard or another command file.

This command is commonly used to read macro definitions from a file, to set up I/O ports, or to change window displays.

File Command commands may be nested up to 16 levels deep.

If the filename consists of alphanumeric characters, a period, or a backslash, double quotation marks are optional. Otherwise, quotation marks must enclose the file name. If a filename extension is not specified, the debugger automatically appends a default extension, *.com*.

Command files can be executed at debugger startup using the *-c* option, from the command line during a debugging session, or from a startup file.

See the File Startup command description for information about how to automatically execute a command file when the debugger is started.

See Also

File Log
File Startup
The “Using Macros and Command Files” chapter.

Example

To execute command file 'varTrace.com':

```
File Command varTrace
```

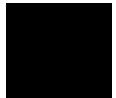

File Error_Command

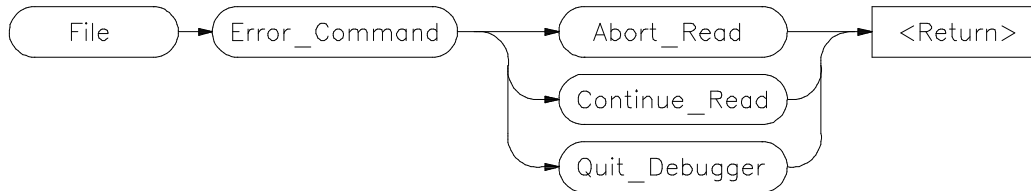

The `File Error_Command` command sets the command file error handling mode. The command specifies what action the debugger takes when an error occurs while reading a command file. *Abort_Read* causes the debugger to return to the command line after an error and wait for keyboard input. This is the default action. *Continue_Read* causes the debugger to continue to the next command in the command file after an error. *Quit_Debugger* causes the debugger to end the debugging session when an error occurs (as if you typed Debugger Quit Yes).

See Also File Command
File Log

Examples To return to the command line after an error and wait for keyboard input:

File `Error_Command Abort_Read`

To continue to the next command in the command file after an error:

File `Error_Command Continue_Read`

To exit the debugger when an error occurs:

File `Error_Command Quit_Debugger`

File Journal

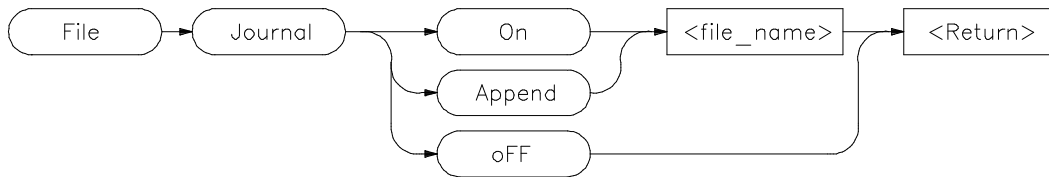

The File Journal command copies the information written to the Journal window output into a journal file specified by < file_name> . The default journal filename extension *.jou* will be appended to < filename> . The journal file provides a history of your debugging session.

File Journal On opens a journal file for writing. If a file already exists with the specified file name, new information is appended to the end of the existing file.

File Journal Append opens an existing file. New information is appended to the end of the existing file.

File Journal oFF closes the journal file.

A window number (29) is assigned to the journal file so that output can be written to that file using the Expression Fprintf command.

See Also Expression Fprintf

Examples To make and open journal file 'debug1.jou' for writing:

```
File Journal On debug1
```

To close the currently open journal file:

```
File Journal oFF
```

To open existing journal file 'debug1.jou' for writing and append new information at the end of the file:

```
File Journal Append debug1
```

File Log

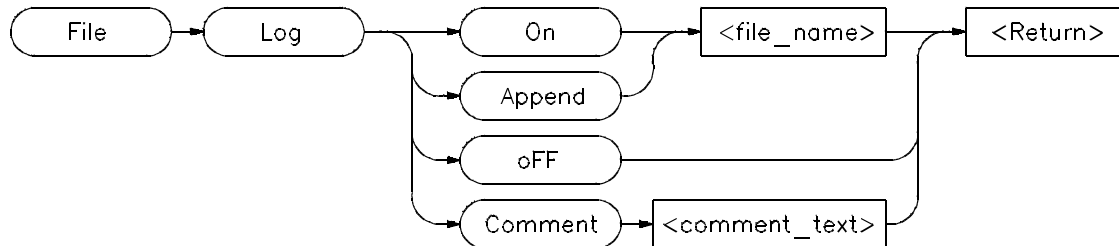

The File Log command records user input in a command file, specified by `< file_name >` . The default filename extension `.com` will be appended to `< filename >` . The File Log command allows an interactive debugger session to be logged as a command file which can be rerun at a later time.

File Log On opens a file for writing. If the specified file already exists, the file is overwritten by the new data.

File Log Append reopens a logging file to allow new information to be added to the end of the file.

File Log oFF terminates logging to the file.

File Log Comment places a string of text in the file as a comment. If a log file is not open, File Log Comment commands are ignored by the debugger.

All successful commands are written to the log file so the file can later be used as a command file.

Commands which are entered but not successfully completed, are written to the `.com` file as comments along with their error codes.

User input is recorded in the log file until the Log oFF command is executed.

A window number (28) is assigned to the log file so that output can be written to that file using the Expression Fprintf command.

See Also

Expression Fprintf
File Error_Command

Examples

To make and open log file 'log1.com' for writing:

```
File Log On log1
```

To close the currently open log file:

```
File Log oFF
```

To open existing log file 'log1.com' for writing and append new information at the end of the file:

```
File Log Append log1
```

To place the comment 'This is a comment string' in the log file:

```
File Log Comment This is a comment string.
```

If a log file is not open, this command is ignored.

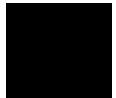

File Startup

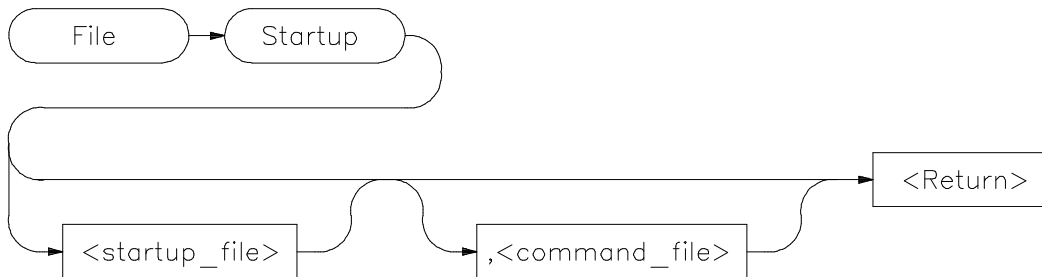

The File Startup command saves the current debugger startup options and window parameters in a startup file specified by < startup_file> . When you start a debugging session and specify the startup file with the -s option of the db68k command, the startup options and window parameters you saved will be the default parameters in that debugging session.

A startup file has an extension of .rc appended to the end of it. If you do not specify a startup file name, the startup options are saved in a file named *db68k.rc*. (Or *db68030* for the 68030/EC030.)

You can modify default debugger startup option values with the Debugger Option command and window parameters with the Window commands.

The following information is contained in the startup file.

| Option Command Parameters | Default Setting |
|----------------------------------|--|
| Align_Bp | oFF |
| Amt_Scroll | 1 |
| Assem_Symbols | On |
| Breakpt_window | Swap |
| Check_Args | oFF |
| Command_Echo | On |
| Demand_Load | On |
| Exceptions | Stop |
| Frame_Stop | oFF |
| Highlight | Inverse |
| Intermixed | oFF |
| More | On |
| Processor | 68020 or 68030/EC030 |
| Radix | Decimal_Input, Decimal_Output |
| Stdio_Window | Swap |
| Step_Speed | 0 |
| View_Window | Swap |
| Window Information | Window sizes, user windows, and window locations |

You can specify a command file to be executed when the debugger starts. If you specify a command file, it executes after the debugger is started. Command files may perform other operations at startup, such as I/O port setup and macro definition.

See Also Debugger Option
File Command
Window New
Window Resize

Examples To save the current set of debugger startup options and window parameters in startup file 'my_start_file.rc':

```
File Startup my_start_file
```

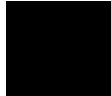

Chapter 12: Debugger Commands

File Startup

To save the current set of debugger startup options and window parameters in startup file 'my_start_file.rc' and execute the command file 'initDemo.com' whenever the debugger is started using 'my_start_file.rc':

```
File Startup my_start_file , initDemo
```

File User_Fopen

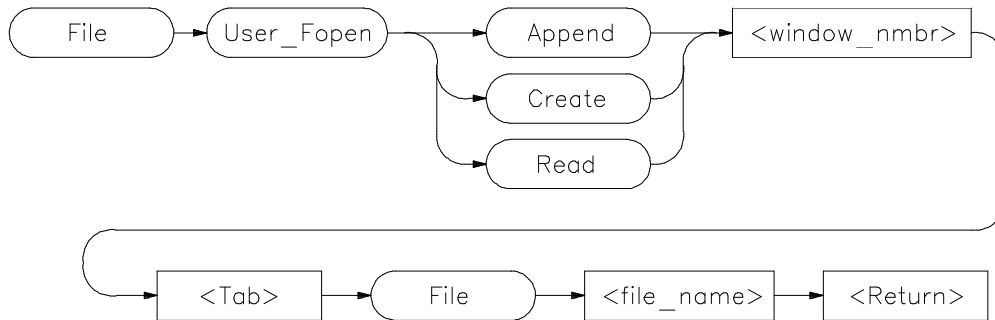

The File User_Fopen command opens the file specified by < file_name> for reading or writing and assigns a window number to it.

The *File User_Fopen Append* command opens an existing file for writing, adding new information at the end of the file.

The *File User_Fopen Create* command creates a new file for writing.

The *File User_Fopen Read* command opens an existing file for reading.

After opening a file using the File User_Fopen Append or File User_Fopen Create command, you can use the Expression Fprintf command to write information to the file. Files opened for reading may be read from the built-in macro fgetc(). See the "Predefined Macros" chapter of this manual for a complete description of this macro.

The window number must be between 50 and 256 inclusive.

Use the Window Delete or the File Window_Close command to close the file.

See Also

Expression Fprintf
File Window_Close
Window Delete
Window New

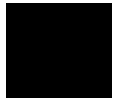

Chapter 12: Debugger Commands

File User_Fopen

Examples

To open user window 57 and redirect any data written to window 57 to the file 'varTrace.out':

```
File User_Fopen Create 57 File varTrace.out
```

To open user window 57 and append any data written to window 57 to the existing file 'varTrace.out':

```
File User_Fopen Append 57 File varTrace.out
```

To open file 'temp.dat' for reading, accessing the file as user window 52:

```
File User_Fopen Read 52 File temp.dat
```

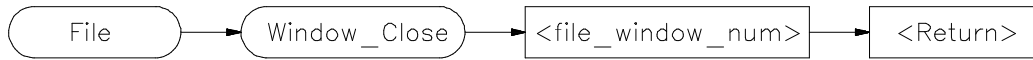

File Window_Close



The File Window_Close command closes a device or file which was previously opened with the File User_Fopen command. The Window Delete command may also be used for this purpose.

See Also File User_Fopen
Window Delete

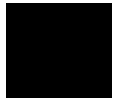
Example To close file associated with user window number 57:
File Window_Close 57



Memory Assign

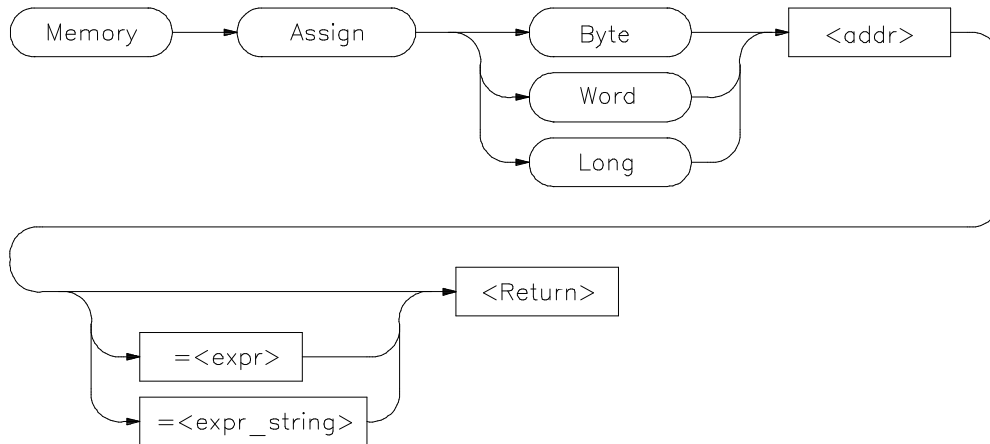

Note

Debugger/emulators cannot modify memory locations in target ROM

The Memory Assign command changes the contents of the memory location specified by *<addr>* to the value or values defined by the expression *<expr>* or expression string *<expr_string>*. The size of the memory elements to be modified is specified by one of the size qualifiers (Byte, Word, or Long).

Expression strings are specified as ASCII characters enclosed in quotation marks and/or as a list of values separated by commas. Expressions and expression string elements will be truncated or padded as required, based on the size qualifier.

Memory values can be entered interactively if you do not define a value on the command line. When a value is not specified, the contents of the specified memory locations are displayed in hexadecimal and decimal. You can change the existing value by entering any legal expression followed by a carriage return. The next memory location and its contents are then displayed. The return key entered without a value will cause the command to terminate.

The Memory Assign command does not recognize variable typing. It is intended to be used as an assembly-level memory setting routine. For example,

assume that the variable *count* is a long integer. If you want to set the value of count equal to 5, the command

```
Memory Assign Long count=5
```

will not work. The command will set the memory location referenced by the value of count equal to 5, not the contents of the variable. To set the value of count equal to 5, use the following command:

```
Memory Assign Long &count=5
```

The Expression C_Expression command should be used to set C variables. This command recognizes variable types and the specified expressions behave according to the rules of C. The command:

```
Expression C_Expression count=5
```

will set count equal to 5.

See Also

Expression C_Expression
Memory Register

Examples

To display the contents of memory location 1000h and allow interactive modification of memory contents:

```
00001000 = 0x48 72:
```

```
Memory Assign Byte 1000h
```

To change the contents of memory locations 2000h through 2005h to 00, 41, 00, 42, 00, 43, and change the contents of locations 2006h/2007h to the value of 'system_is_running':

```
Memory Assign Word 2000h=41h,42h,43h,system_is_running
```

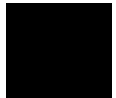

Memory Block_Operation Copy

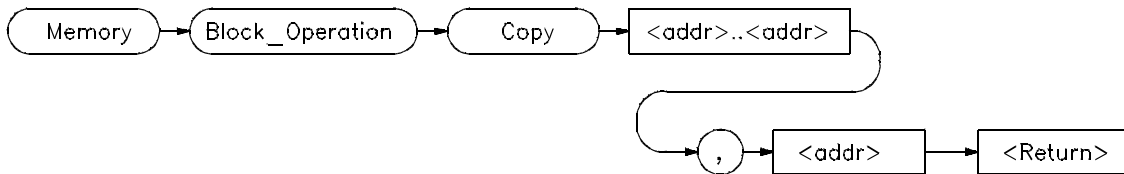

Note Debugger/emulators cannot copy to memory locations in target ROM.

The Memory Block_Operation Copy command copies the contents of the memory range specified by *<addr>..<addr>* to a block of the same size starting at the memory location specified by *<addr>*.

See Also Memory Assign
Memory Block_Operation Fill
Memory Block_Operation Match
Memory Block_Operation Search
Memory Block_Operation Test

Examples To copy the block of memory starting at address 1000h and ending at address 10ffh to a block of the same size starting at address 5000h:

```
Memory Block_Operation Copy 1000h..10ffh,5000h
```

To copy the block of memory starting at the address of the structure 'current_targets' and ending 15 bytes after this address to a block of memory starting at the address of the structure 'default_targets':

```
Memory Block_Operation Copy &current_targets..+0xf,  
&default_targets
```

Memory Block_Operation Fill

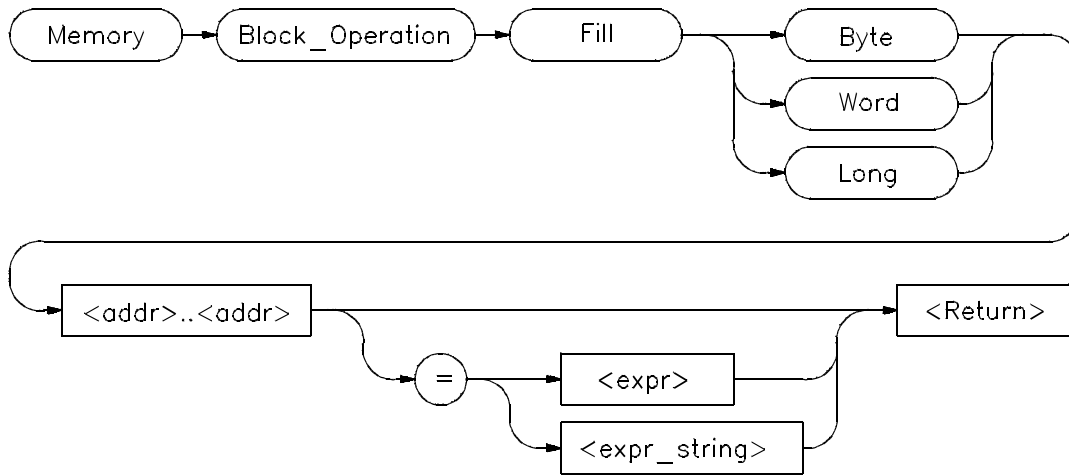

Note

Debugger/emulators cannot fill memory locations in target ROM.

The Memory Block_Operation Fill command fills the range of memory locations specified by the address range *<addr>..<addr>* with the value or values specified by an expression *<expr>* or an expression string *<expr_string>*. If no expression is given, the debugger fills the specified memory locations with zeros. The specified size qualifier (Byte, Word, or Long) determines the size of the value.

If you specify a single expression value, the debugger fills the memory area with that value. If you enter an expression string, the debugger fills the memory area with the specified string pattern.

An expression string is a list of values separated by commas and can include ASCII characters enclosed in quotation marks. All expressions in an expression string are padded or truncated to the size specified by the size qualifiers if they do not fit the specified size evenly.

If the number of values in an expression string is less than the number of bytes in the specified address range, the debugger repeatedly places the list of values

Chapter 12: Debugger Commands

Memory Block_Operation Fill

in memory until all designated memory locations are filled. If you specify more values than can be contained in the specified address range, the debugger ignores the excess values.

See Also

Memory Assign
Memory Block_Operation Copy
Memory Block_Operation Match
Memory Block_Operation Search
Memory Block_Operation Test
Memory Register

Examples

To fill memory locations 1000h through 1007h with the long pattern 61626364, 65666768:

```
Memory Block_Operation Fill Long 0x1000..+7='abcdefgh'
```

To fill the memory area starting at location 1000h and ending at location 10ffh with zeros:

```
Memory Block_Operation Fill Byte 0x1000..0x10ff
```

Memory Block_Operation Match

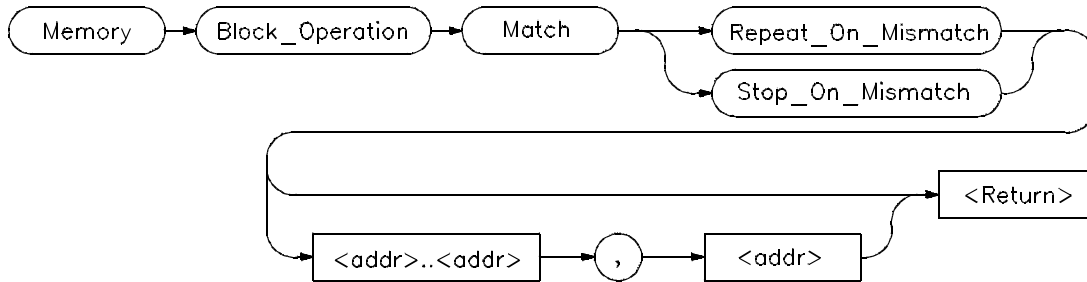

The Memory Block_Operation Match command compares the contents of two blocks of memory to determine their similarities or differences. The command compares the block of memory specified by the address range `<addr>..<addr>` with the same size block starting at `<addr>`.

The debugger displays differences between the two blocks of memory, mismatched values and addresses, in the Journal window. If the contents of the two blocks of memory are the same, the debugger displays the message *Memory blocks are the same.*

The Memory Block_Operation Match Stop_On_Mismatch command halts when a mismatch is found. If the Memory Block_Operation Match Repeat_On_Mismatch command is selected, the comparison continues until the end of the block.

When you execute the Memory Block_Operation Match Stop_On_Mismatch/Repeat_On_Mismatch command without specifying an address range, the debugger continues comparing the address range specified in the previous Memory Block_Operation Match Stop_On_Mismatch command starting from where it found the last mismatch.

See Also

- Memory Block_Operation Copy
- Memory Block_Operation Fill
- Memory Block_Operation Search
- Memory Block_Operation Test

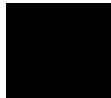

Chapter 12: Debugger Commands

Memory Block_Operation Match

Examples

To compare the block of memory starting at address 1000h and ending at address 10ffh with a block of the same size beginning at address 5000h and stop when a difference is found:

```
Memory Block_Operation Match Stop_On_Mismatch  
1000h..10ffh,5000h
```

To execute the previous Memory Block_Operation Match Stop_On_Mismatch command starting from where it found the last mismatch:

```
Memory Block_Operation Match Stop_On_Mismatch
```

To compare the block of memory starting at address 1000h and ending at address 10ffh with a block of the same size beginning at address 5000h and stop at the end of the memory block:

```
Memory Block_Operation Match Repeat_On_Mismatch  
1000h..10ffh,5000h
```

Memory Block_Operation Search

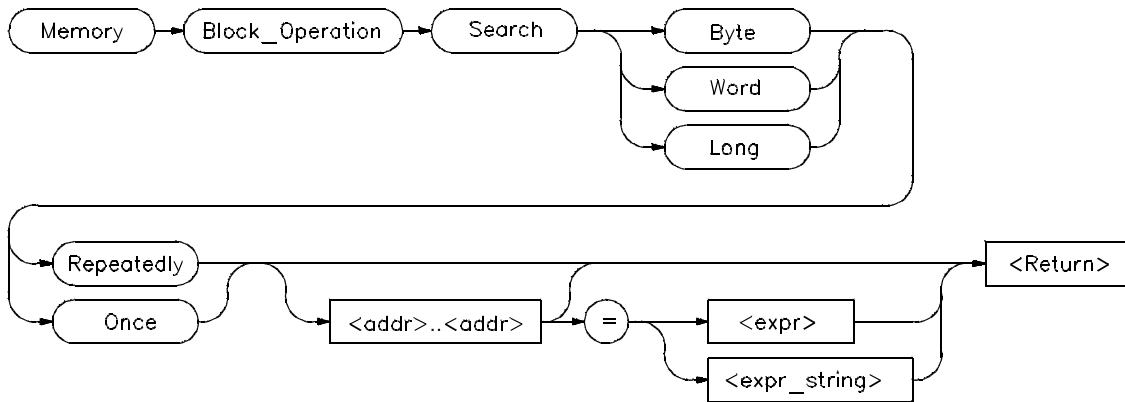

The Memory Block_Operation Search command searches the block of memory specified by `<addr> ..<addr>` for the specified expression `<expr>` or expression string `<expr_string>`. The size qualifier (Byte, Word, or Long) specifies the size of an expression or each expression in an expression string. A Memory Block_Operation Search command given without parameters continues the search of a previous Memory Search command given with the Once qualifier. The Repeatedly qualifier causes the search to repeat.

You can specify expression strings as ASCII characters enclosed in quotation marks and/or as a list of values separated by commas. If the strings do not fit the specified size evenly, all expressions in an expression string will be padded or truncated to the size specified by the size qualifiers.

If you specify the Once qualifier, the search stops when the expression is found. If you specify the Repeatedly qualifier, the debugger repeatedly searches for the specified expression, displaying each match until it reaches the end of the block or until you press **CTRL C**.

When you execute the Memory Block_Operation Search command with the Once qualifier, subsequent Memory Block_Operation Search commands that are executed without expression parameters cause the debugger to continue searching through the originally specified address range starting from where it found the last match. If the expression or expression string is not found in the specified block, the debugger displays the message *Not found*.

Chapter 12: Debugger Commands

Memory Block_Operation Search

See Also

- Memory Display
- Memory Block_Operation Copy
- Memory Block_Operation Fill
- Memory Block_Operation Match
- Memory Block_Operation Test
- Program Find First
- Program Find Next

Examples

To search for the expression 'gh' in the memory range from address 1000h through address 10ffh and stop when the expression is found or address 10ffh is reached:

```
Memory Block_Operation Search Word Once  
1000h..+0xff = 'gh'
```

To execute the previous Memory Block_Operation Search command starting from where it found the last match:

```
Memory Block_Operation Search Word Once
```

To search for the hexadecimal value '65666768' in long format in the address range 1000h through 10ffh and stop at the end of the address range:

```
Memory Block_Operation Search Long Repeatedly  
0x1000..0x10ff=0x65666768
```

Memory Block_Operation Test

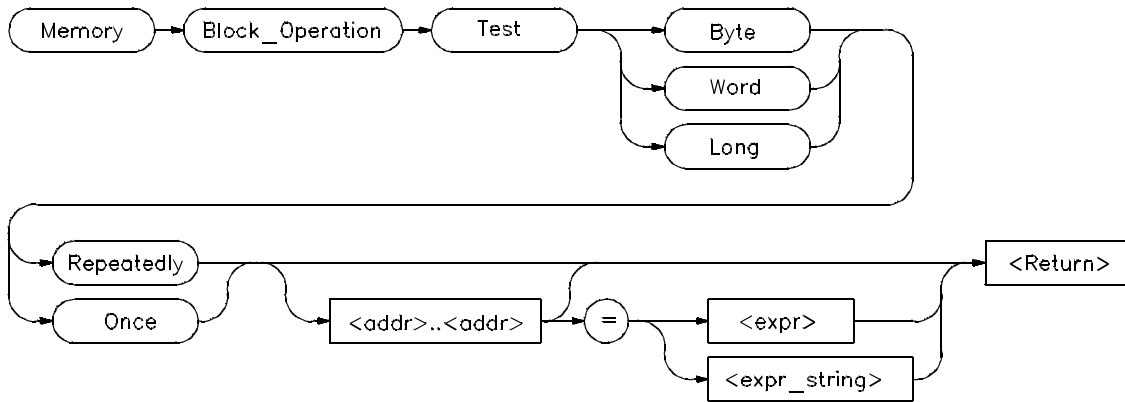

The Memory Block_Operation Test command examines the specified memory locations specified by *<addr..addr>* to verify that the value(s) defined by *<expr>* or *<expr_string>* exist throughout the specified memory area. When the debugger finds a mismatch, it displays the mismatched address and value. The size qualifier (Byte, Word, or Long) specifies the size of an expression or expression in a string.

If you enter a single expression value, the debugger tests the memory area for that value. If you specify an expression string, the debugger tests the memory area to verify that it is filled with the values found in the expression string.

You can specify expression strings either as ASCII characters enclosed in quotation marks or as a list of values separated by commas. If they do not evenly fit the specified size, all expressions in an expression string will be padded with zero-valued bytes to the size specified by the size qualifier.

Once Qualifier

If you specify the Once qualifier, the test stops when a mismatch is found. If you execute the Memory Block_Operation Test command with the Once qualifier specified, subsequent *Memory Block_Operation Test . . . Once* commands that are specified without parameters will continue testing through the address range originally specified, beginning with the last address tested. A Memory Block_Operation Test command given without parameters continues

Chapter 12: Debugger Commands

Memory Block_Operation Test

the test of a previous Memory Block_Operation test command given with the Once qualifier, beginning with the last address tested.

Repeatedly Qualifier

If you specify the Repeatedly qualifier, the debugger continues testing the specified value(s) for mismatches until the end of the block is reached, or until you enter **CTRL C**.

Examples

To test for the expression 'gh' in the memory range from address 1000h through address 10ffh and stop when a word not matching the expression is found:

```
Memory Block_Operation Test Word Once 1000h..+0xff =  
'gh'
```

To execute the previous Memory Block_Operation Test command starting from where it found the last mismatch:

```
Memory Block_Operation Test Word Once
```

To test for the hexadecimal value '65666768' in long format in the address range 1000h through 10ffh and stop at the end of the address range:

```
Memory Block_Operation Test Long Repeatedly  
0x1000..0x10ff=0x65666768
```

Mismatched values are displayed in the Journal window.

Memory Display

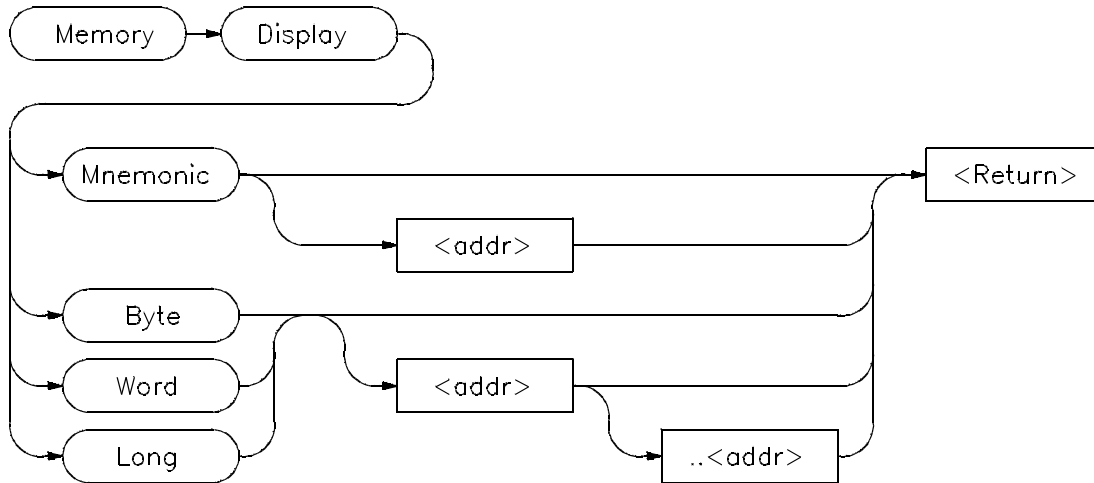

The Memory Display displays the contents of the specified memory locations.

Mnemonic Option

The *Mnemonic* option displays memory in assembly language mnemonics starting at the memory location specified by *<addr>*. If you do not specify an address, the debugger displays memory beginning with the address pointed to by the program counter. This command functions only in the assembly-level mode.

If you have executed the Debugger Options Symbolics Intermixed On command, C source code lines will be intermixed with the assembly language code (when applicable). If you have executed the Debugger Options Symbolics Assem_Symbols On command, symbol references will be displayed with the assembly language code.

The *Prev*, *Next*, *Up*, and *Down* keys may be used when the Code window is active to display instructions with higher or lower addresses. Note that the *Prev* and *Up* keys do not function when disassembling addresses outside of the target program.

Chapter 12: Debugger Commands

Memory Display

Note

If the `Align_bp` option is set to *On*, the address of the first instruction in the assembly Code window may be incorrect after executing the Memory Display Mnemonic command.

Byte, Word, and Long Options

The byte, word, or long qualifier option displays the contents of memory locations specified by `<addr> ..<addr>` in the Journal window in both hexadecimal and ASCII formats. The debugger represents nonprintable ASCII characters by a period (.). The debugger displays memory contents in the size specified by the size qualifier (Byte, Word, or Long).

If you specify an address range, the debugger displays all memory locations in that range.

If you specify a single address, the debugger displays two lines of data.

If you do not specify any parameters, the debugger displays the next 80 bytes (five lines) of data after the previously displayed address range.

The memory contents are displayed in the Journal window. The alternate view of the Journal window is displayed if more than two lines are copied to the display.

See Also

Expression Display_Value
Symbol Display

Examples

To display disassembled memory in the Code window starting at the symbol `'_emeg_shutdown'` (this command works only in assembly-level mode):

```
Memory Display Mnemonic _emeg_shutdown
```

To display memory in word format in the Journal window starting at the symbol `'time'` and ending 15 bytes after `'time'`:

```
Memory Display Word time..+0xf
```

Memory Register

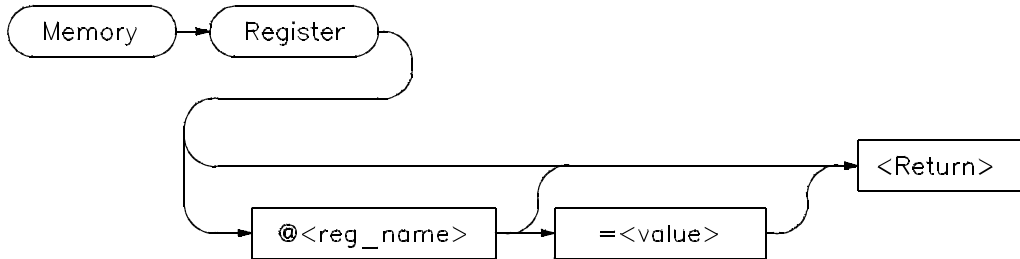

The Memory Register command changes the contents of a register, status flag, or other processor variables such as pc or sp. The new contents are defined by `< value>` .

The PC (program counter) is displayed or changed if you do not specify a register name.

If you do not specify a value in the command, values are entered interactively. You can enter multiple register values interactively. The debugger displays contents of the specified register in binary, hexadecimal, or decimal, as appropriate for the register. You can change the existing value by entering any legal expression and pressing the **Return** key.

Pressing the **Return** key without specifying a register value terminates the command.

All register names are preceded with an @ sign. A complete list of the reserved words that you can use with this command is given in the "Reserved Symbols" chapter of this manual.

See Also

Memory Assign

Examples

To modify register values interactively:

`Memory Register`

Chapter 12: Debugger Commands

Memory Register

The program counter (PC) is displayed in the Journal window. You can modify the PC by entering a value (10a4h in this example) at the cursor prompt and pressing Return. The PC will be modified, and the next register will be displayed:

```
@pc      = 0x000010B8      4280: 10a4h
@sp      = 0x00015DB4      89524:
```

To set the value of register @d1 to 44h:

```
Memory Register @d1=0x44
```

To interactively change the value of register @d1:

```
Memory Register @d1
```

To set the value of the lower 32-bits of the CPU root pointer to 0x000174B4:

```
Memory Register @CRP_L = 0x000174B4
```

Memory Unload_BBA

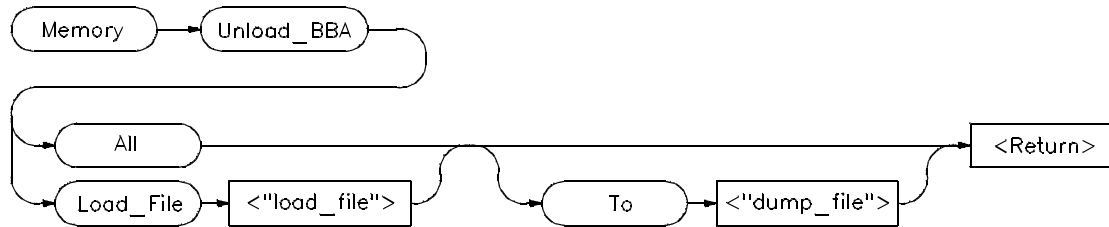

Note

You must have the HP Branch Validator product for the processor you are debugging code for installed on your system in order to use this command.

If you do not have the HP Branch Validator for your processor, the debugger will display the following error message when you attempt to execute this command:

```
error code = 141
```

```
No valid BBA spec file for <processor> processor
```

The Memory Unload_BBA command unloads basis branch analysis (BBA) information from program memory. The BBA preprocessor (-b option) must be used at compile time in order for this information to exist in program memory. The file name *bbadump.data* is used as the default name of all dump files if none is specified in the command.

Once this information has been unloaded, it can be formatted with the BBA report generator, *bbarep* (see the *HP Branch Validator for AxLS C User's Guide*).

Note

The Unload_BBA command is disabled when the debugger option Demand_Load is *On*. If Demand_Load is *OFF* but the program was loaded with Demand_Load On, the Memory Unload_BBA command will generate a BBA file with incomplete information. See the Debugger Option General command description in this manual for more information on the Demand_Load option.

Memory Unload_BBA All

The Memory Unload_BBA All command unloads branch analysis information associated with all absolute files loaded into the file *bbadump.data*.

This command lets you run *bbarep* without specifying a file name. The file name *bbadump.data* is used as the default name of all dump files.

Memory Unload_BBA All To < "dump_file">

The Memory Unload_BBA All To < "dump_file"> command unloads branch analysis information associated with all absolute files loaded into < "dump_file"> .

Memory Unload_BBA Load_File < "load_file">

The Memory Unload_BBA Load_File command unloads only basis branch information associated with the specified absolute file (< "load_file">) into the file *bbadump.data*.

This command lets you run *bbarep* without specifying a file name. The file name *bbadump.data* is used as the default name of all dump files.

Memory Unload_BBA Load_File < "load_file"> To < "dump_file">

The Memory Unload_BBA Load_File < "load_file"> To < "dump_file"> command unloads only basis branch information associated with the specified absolute file (< "load_file">) into the file < "dump_file"> .

Examples

To unload all branch analysis information into file "bbadump.data":

`Memory Unload_BBA All`

To unload all branch analysis information into file "mydata":

```
Memory Unload_BBA All To "mydata"
```

To unload branch analysis information associated with absolute file a.out.x into file "bbadump.data":

```
Memory Unload_BBA Load_file "a.out"
```

To unload branch analysis information associated with absolute file a.out.x into file "mydata":

```
Memory Unload_BBA Load_file "a.out" To "mydata"
```

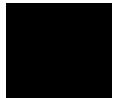

Program Context Display

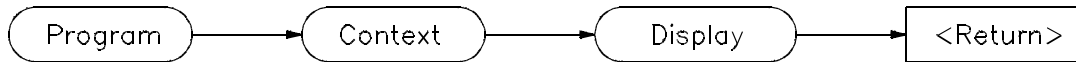

The Program Context Display command displays the current module, function, and line number in the Journal window. The current module is the one pointed to by the program counter.

This command will display both the view context, as set by a Program Context Set command, and the context of the current program counter, if the two are different.

Example

To display the current module, function, and line number:

```
Program Context Display
```

```
Current context is: @ecs\\main\main On line 81
```

See “Expression Elements” section of the “Expressions and Symbols in Debugger Commands” chapter for a description of debugger operators.

Note

If the PC does not point to a valid module, an alternate context is displayed. The alternate context is the name of the executable file that has been loaded into the debugger.

Program Context Expand

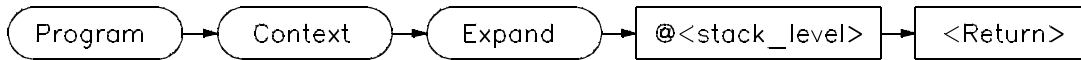

The Program Context Expand command displays values of the parameters passed to a function, and the local variables in a function. The values are displayed in the Journal window.

To display a function's calling parameters and local variables, specify the function's stack level preceded by an at sign (@). The Backtrace window in high-level mode displays the function calling chain from the main program to the current function. The debugger displays the function stack (nesting) level beside each function name. The current function is level 0, the caller is always 1, etc.

You can use the Program Context Expand command to display the local variables and parameters of any function shown in the backtrace window. The calling parameters and local variables are accessible on the C run-time stack for functions in a directly-called chain from the main program to the current function.

See Also

Expression Display_Value
Expression Monitor
Symbol Display

Example

To display local variables and calling parameters of the function at stack level 2:

```
Program Context Expand @2
```

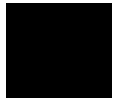

Program Context Set

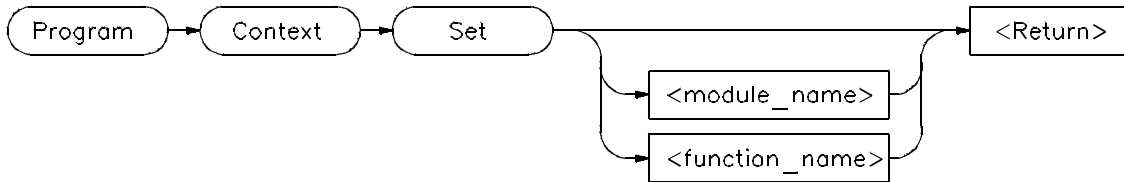

The Program Context Set command changes the default module and function (context). The current module (the one to which the program counter is pointing) is the default when functions are referenced without a module or function qualifier.

The default module reverts to the current module when you invoke any command that causes program execution, or if you execute the Program Context Set command without a parameter.

Example

To select module 'updateSys' as the current module:

```
Program Context Set updateSys
```

Program Display_Source

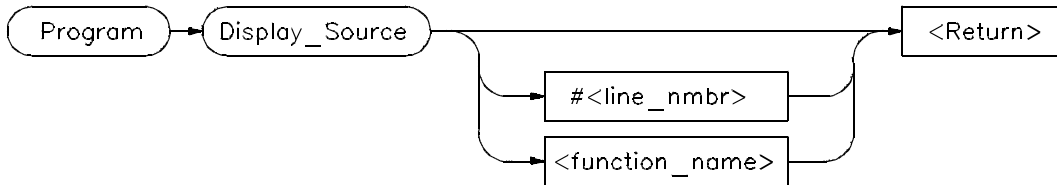

The Program Display_Source command displays C source code in the Code window beginning at the specified line or function. This command works in high-level mode only. If you do not specify a line number or function name, the debugger displays the line pointed to by the program counter.

You can display lines or functions in other modules by preceding them with a module name. The *Next Page*, *Prev Page*, *Up* arrow, and *Down* arrow keys may be used when the Code window is active to display code at higher or lower line numbers.

This command does not change the current program context.

See Also

Memory Display Mnemonic
Program Context Set
Program Find_Source

Examples

To display line 82 of the current module in the Code window:

```
Program Display_Source #82
```

To display the source code for function 'update_state_of_system' in the Code window:

```
Program Display_Source update_state_of_system
```

To display line 25 of module updateSys:

```
Program Display_Source updateSys\#25
```

Program Find_Source Next

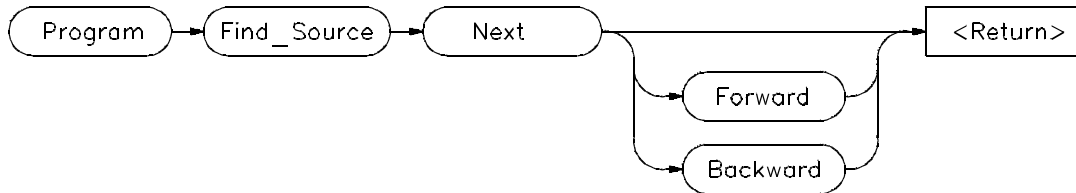

The Program Find_Source Next command searches a high-level source program for the next occurrence of the string specified in the last Program Find_Source Occurrence command. When the debugger finds the string, it displays the line containing the string at the top of the Code window.

If you specify *Forward*, the debugger searches forward through the file for the string.

If you specify *Backward*, the debugger searches backward through the file for the string.

If neither *Forward* nor *Backward* is specified, the debugger searches forward through the file for the string.

If the debugger cannot find the specified string, it displays the message "*string not found*". The screen remains unchanged.

See Also

Program Find_Source Occurrence

Example

To find the next forward occurrence of the string specified in the last Program Find_Source Occurrence command:

Program **F**ind_**S**ource **N**ext

Program Find_Source Occurrence

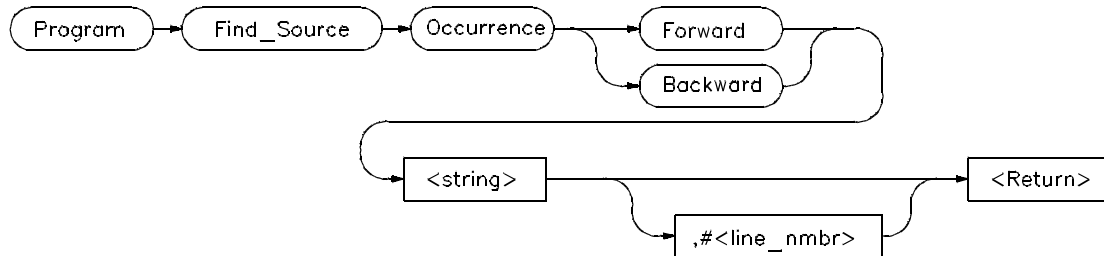

The Program Find_Source Occurrence command searches a high-level source file for the first occurrence of the specified string. If you provide a line number, the debugger searches for the string starting at the given line number. If you do not specify a line number, the string search starts at the top of the Code window.

If you specify *Forward*, the debugger searches forward through the file for the string.

If you specify *Backward*, the debugger searches backward through the file for the string.

You must enclose strings containing nonalphanumeric characters in quotation marks. Quotation marks are not required if the string consists of only alphanumeric characters.

If the debugger finds an occurrence of the string, it displays the line containing the string at the top of the Code window. If the string does not exist or the debugger cannot find it, the debugger displays the message "*string not found*". The screen remains unchanged.

You can use the Program Find_Source Next command to search for the next occurrence of the specified string.

If you specify a line number with a module reference, the debugger displays the source code for that module in the Code window.

See Also

Program Display_Source
Program Find_Source Next

Chapter 12: Debugger Commands

Program Find_Source Occurrence

Examples

To search forward through the current module for the string 'time':

```
Program Find_Source Occurrence Forward 'time'
```

To search backward through the current module for the string 'time', starting at line 237:

```
Program Find_Source Occurrence Backward 'time',#237
```

To search forward through the module 'main', for the string system_is_running, beginning at line 1:

```
Program Find_Source Occurrence Forward  
"system_is_running", main\#1
```

Program Load

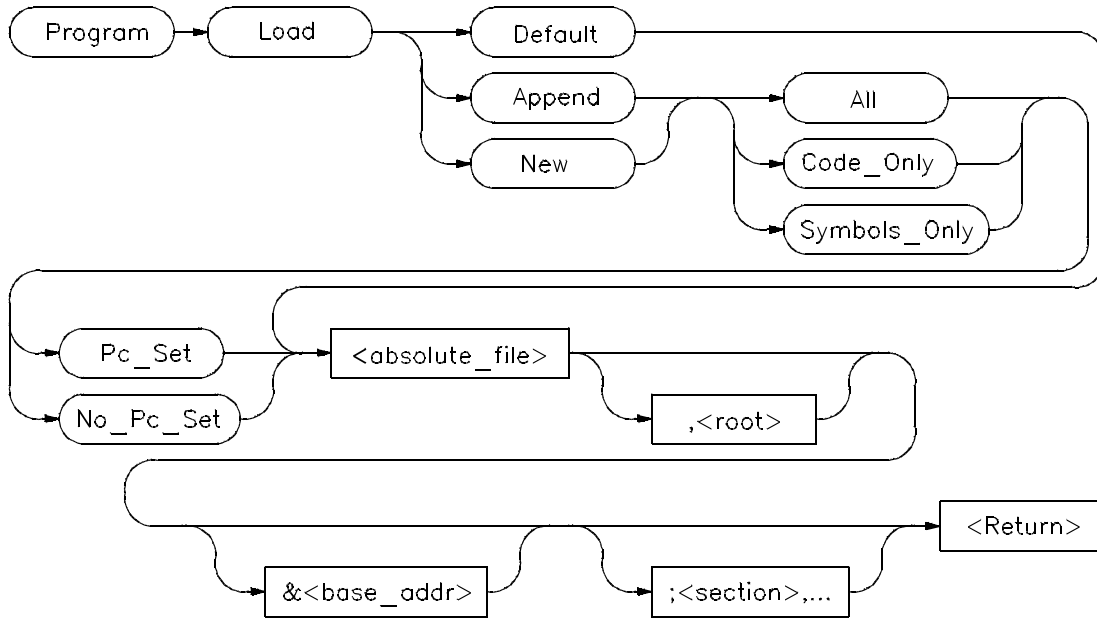

The Program Load command loads the specified executable module into the debugger.

Default Parameter

When you specify the Default parameter, the debugger:

- removes all previous program symbols
- removes all previously set breakpoints
- resets the program counter (PC)
- loads the full symbol set
- loads the executable module

New/Append Parameters

The *New* parameter loads a new program, removing any old program that may have been loaded. The *New* parameter optionally allows you to load the

Chapter 12: Debugger Commands

Program Load

program image, the program symbols, or both. The program counter can be set from the transfer address in the load file or ignored.

The *Append* parameter loads another program without deleting the existing program.

If you enter the Program Load command with the *New* or *Append* parameter, the following qualifiers are available:

| | |
|--------------|--|
| All | Both the program image and program symbols to be loaded. |
| Code_Only | Only the program image is loaded. |
| Symbols_Only | Only the program symbols are loaded. |
| Pc_Set | The program counter is set from the transfer address in the load file. |
| No_Pc_Set | The program counter is not reset. |

Using the All or Symbols_Only qualifiers along with the Pc_Set qualifier resets static variables for a complete restart.

The optional root parameter (< root>) allows you to specify an alternate name for the root of the symbol tree.

The base address (&< base_addr>) allows PC relative code to be shifted upon loading.

The section list (< section>) enables partial loading of absolute file sections, i.e., prog, data, const, etc. The symbols for all sections will be reloaded.

Resetting Program Variables

To reset static and global program variables after entering a Debugger Execution Reset_Processor or Program Pc_Reset command, you must reload your program by using the Program Load command. For faster loading, specify Program Load New Code_Only. The debugger retains symbol information. You do not have to reload symbol information if symbol addresses have not changed.

The address where the object module will be loaded is specified at link time. However, the address can be changed by specifying a new base address.

See Also

Debugger Execution `Reset_Processor`
Program `Pc_Reset`
Debugger Option `General_Demand_Load`

Examples

To load absolute file 'ecs', remove all existing program symbols, reset the program counter, and load the full symbol set:

```
Program Load Default ecs
```

To load only the program image of the prog section of absolute file 'ecs' without resetting the program counter:

```
Program Load New Code_Only No_Pc_Set ecs;prog
```

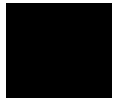

Program Pc_Reset

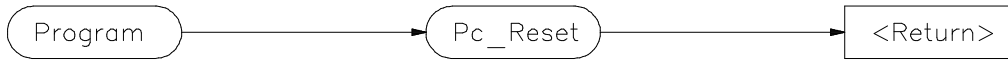

The Program Pc_Reset command resets the program counter to the transfer address from the absolute file. This causes the next Program Run or Program Step command to restart execution at the beginning of the program. The command does not clear breakpoints.

See Also Debugger Execution Reset_Processor
 Program Load
 Program Run

Example To reset the program counter to the transfer address from the absolute file:
`Program Pc_Reset`



Program Run

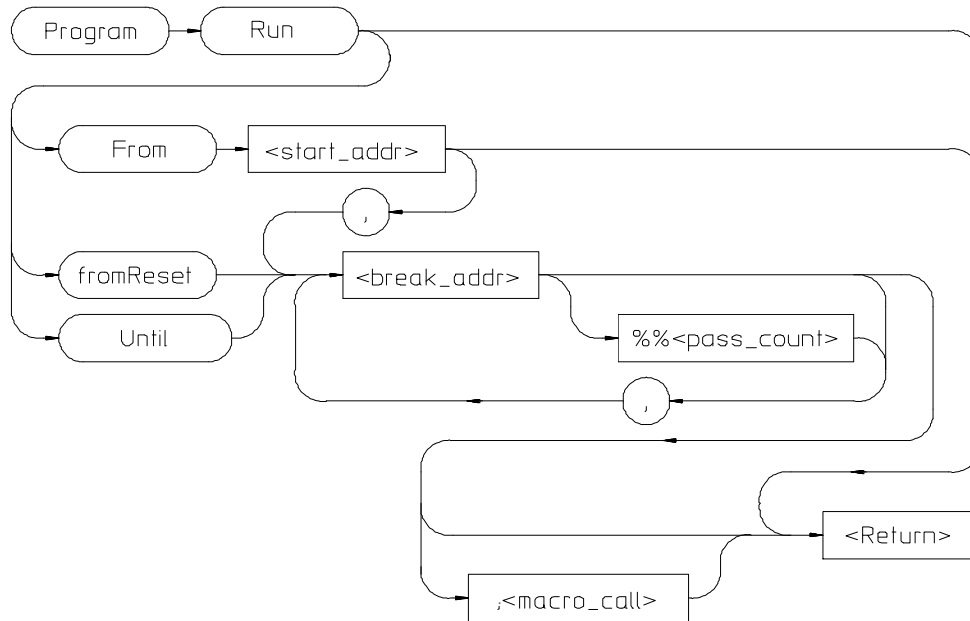

The Program Run command starts or continues target program execution. The program runs until it encounters a permanent or temporary breakpoint, an error, or a stop instruction, or until you press **CTRL C**.

The Program Run command may be used to resume execution after program execution has been suspended.

Program Run From

The Program Run From command begins program execution at the specified start address `< start_addr >` .

Using the Program Run From command to specify a starting address in high-level mode may cause unpredictable results if the compiler startup module is bypassed.

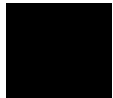

Program Run fromReset

Resets processor and then starts execution as the processor does when reset.

Program Run Until

The Program Run Until command begins program execution at the current program counter address and breaks at the specified address.

Break Address

The break address (< break_addr>) acts as a temporary instruction breakpoint. It is automatically cleared when program execution is halted. Multiple break addresses are ORed. For example, the command

```
Program Run Until #20,#90 Return
```

causes the program to run until either line 20 or line 90 is encountered, whichever occurs first.

Note

The debugger/emulator implements instruction breaks using software breakpoints. Therefore, break addresses cannot be specified for addresses in target ROM.

Pass Count

The pass count (< pass_count>) specifies the number of times the break address is executed before the program is halted. For example, a pass count of three will cause the program to break on the fourth execution of the break address.

Macro Calls

If specified, a macro (< macro_name>) is invoked when the temporary break occurs.

See Also

Breakpt Access
Breakpt Clear_All
Breakpt Delete

Breakpt Instr
Breakpt Read
Breakpt Write
Program Pc_Set
Program Step

Examples

To execute the target program starting at address 'main':

Program Run From main

To begin program execution at the current program counter address and run until line 110 of the current module:

Program Run Until #110

To begin program execution at the current program counter address, run until the program returns to the calling function of the current function, and then execute the macro 'read_val':

Program Run Until @1;read_val()

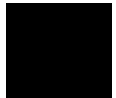

Program Step

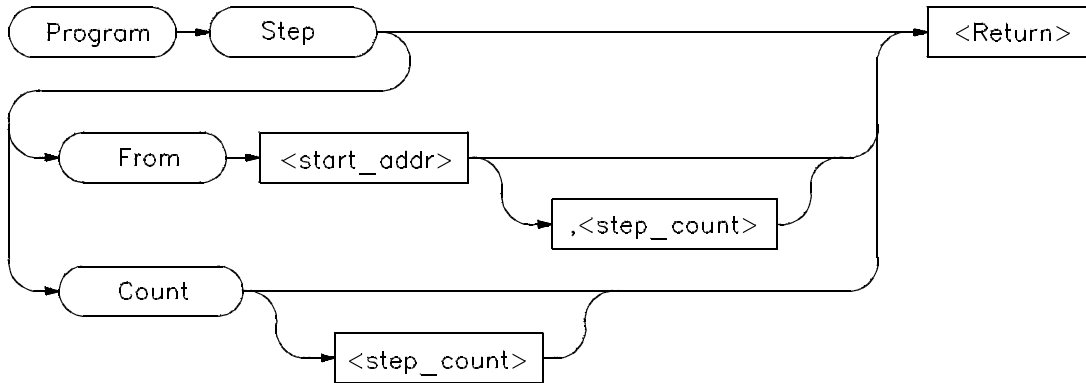

The Program Step command executes the specified number of instructions or lines, beginning with the location identified with `< start_addr >` . In high-level mode, single-stepping is done one C source line at a time. In assembly-level mode, single-stepping is done one machine instruction at a time. When the program calls a function, stepping continues in the called function.

If you do not specify a starting address, single-stepping begins at the address contained in the program counter.

If you do not specify a step count (`< step_count >`), the debugger will either step one C source line or one machine instruction.

Note

If the debugger steps into an HP library routine, you can then use the Program Run Until @ 1 (stack level 1) command to run to the end of the library routine.

Program Step From

The Program Step From command executes one instruction or line, beginning with the location specified by `< start_addr >` . If you do not specify the optional step count (`< step_count >`), the debugger executes one line or one instruction.

Program Step Count

The Program Step Count command executes the specified number of either instructions or lines, starting at the location pointed to by the program counter.

The debugger updates the screen after each instruction or line is executed. If a breakpoint is encountered, single-stepping is halted.

You can also use function key *F7* to single-step.

See Also

Breakpt Instr
Program Run
Program Step Over
Program Step With_Macro

Examples

To step four source lines, starting at line 39:

```
Program Step From #39,4
```

To step ten source lines (high-level mode) or ten processor instructions (assembly-level mode), starting at the program counter address:

```
Program Step Count 10
```

To step one source line (high-level mode) or one processor instruction (assembly-level mode), starting at the program counter address:

```
Program Step
```

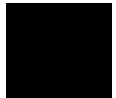

Program Step Over

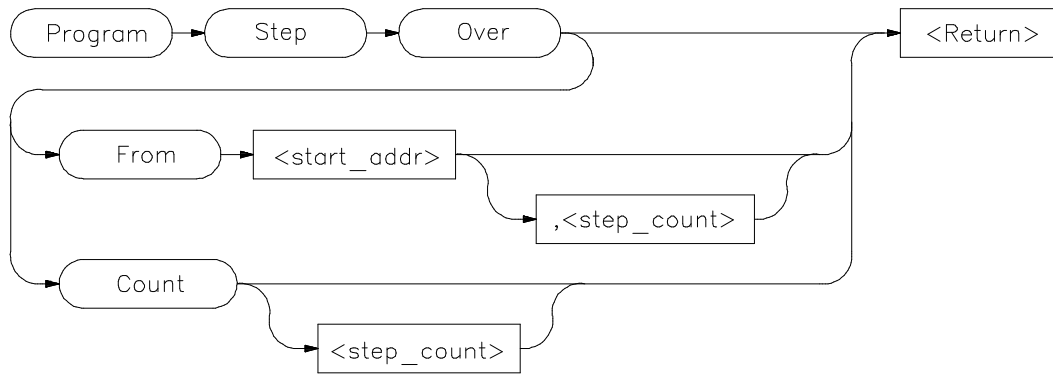

The Program Step Over command executes the number of instructions or lines specified, but executes through function calls, that is, the called function is executed without stepping through it. Execution begins at the specified starting address.

When the debugger encounters a C function or assembly-level JSR instruction, it stops stepping, executes the function or JSR, and then continues stepping when the called subroutine returns.

In high-level mode, the debugger executes one C source line at a time. In assembly-level mode, the debugger executes one microprocessor instruction at a time.

If you do not specify a starting address, single-stepping begins at the address contained in the program counter.

If you do not specify a step count (< step_count >), the debugger will either step one C source line or one machine instruction.

Program Step Over From

The Program Step Over From command executes one instruction or line, beginning with the location specified by < start_addr > . If you do not specify the optional step count (< step_count >), the debugger executes one line or one instruction.

Program Step Over Count

The Program Step Over Count command executes the specified number of either instructions or lines, starting at the location pointed to by the program counter. The debugger updates the screen after each instruction or line is executed. If the debugger encounters a breakpoint, it halts single-stepping.

You can also use function key *F8* to single-step over functions.

See Also

Breakpt Instr
Program Run
Program Step Count
Program Step From
Program Step With_Macro

Examples

To step four source lines, starting at line 39, and execute through any function calls:

```
Program Step Over From #39,4
```

To step ten source lines (high-level mode) or ten processor instructions (assembly-level mode), starting at the program counter address, and execute through any function calls:

```
Program Step Over Count 10
```

To step one source line (high-level mode) or one processor instruction (assembly-level mode), starting at the program counter address, and execute through any function calls:

```
Program Step Over
```

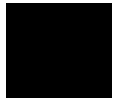

Program Step With_Macro



The Program Step With_Macro command single steps through the program and executes the specified macro (*<macro_call>*) after each instruction or high-level line. Program execution continues if the macro returns a nonzero value.

Single-stepping is done by C source line in high-level mode and by microprocessor instruction in assembly-level mode.

See Also

Program Run
Program Step From
Program Step Over

Example

To step through the program one source line (high-level mode) or one processor instruction (assembly-level mode) at a time, executing the macro `read_var` after each step:

```
Program Step With_Macro read_var()
```

Symbol Add

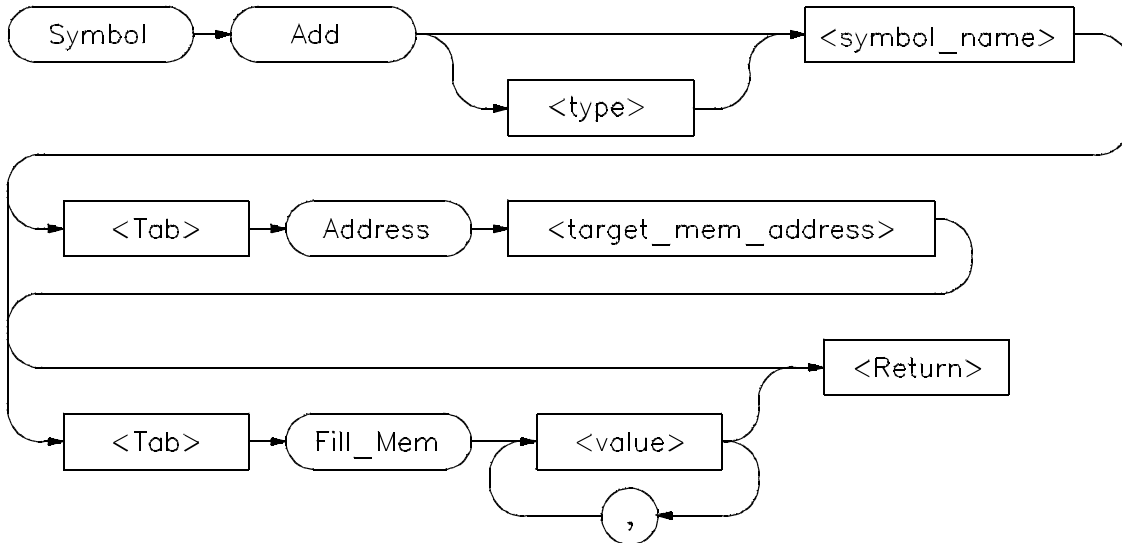

The Symbol Add command creates a symbol and adds it to the debugger symbol table. When defining a symbol, you must declare the symbol's name. It may be any name not previously used.

Type

You can optionally assign any valid C data type `< type >` to the symbol. If you do not assign a data type, the symbol type defaults to type `int`.

If the symbol type is a pointer, the initial value must be a data address. If the type is an array, the initial value must be a string of values separated by commas and/or enclosed in quotation marks. If fewer values are given than will fill the array, the pattern is repeated until the entire array is filled.

When initializing symbols, the symbol type is not used. Only the size is used. If a char array is defined, it is filled with the specified pattern in the same way as with the Memory Block_Operation Fill command. A zero is not appended to char arrays. The size is not determined by the string as in C. Complex values such as floating point representation are not recognized.

Program Symbols

Program symbols are specified with a base address (Address < target_memory_address >). The base address references an address in target memory. Program symbols are identical to variables defined in a C or assembly language program. The value of a program symbol is placed in target memory. If an initial value is specified for the program symbol, the value is loaded in the memory location referenced by the symbol. If an initial value is not specified, the memory location referenced by the symbol is not changed.

Debugger Symbols

Debugger symbols are specified without a base address and are not associated with a target memory address. Debugger symbols may be used to aid and control the flow of the debugger. They are located at a fixed location in debugger memory. Only debugger commands and C expressions in macros can refer to debugger symbols. They cannot be referenced by the program in target memory.

If an initial value is specified for the debugger symbol, the value is loaded in the memory location referenced by the symbol. If an initial value is not specified, the memory location referenced by the symbol is set to zero.

See Also

Debugger Macro Add
Symbol Display
Symbol Remove

Examples

To add a program symbol of type int (default) at target memory address 9ff0h and set the memory location to value -1:

```
Symbol Add EOF Address 9ff0h Fill_Mem -1
```

To add a debugger symbol named str1 of type char referencing an eight-character array and fill the array with string 'abcdefgh':

```
Symbol Add char str1[8] Fill_Mem 'abcdefgh'
```

To add a debugger symbol of type short named s1 and fill the memory location with value 0x10203:

```
Symbol Add short s1 Fill_Mem 0x10203
```



In this example, we assigned a value to the symbol that is too large for the specified type. In this case, the debugger fills the memory location with the lower bytes of the specified value. Executing the command:

```
Expression Printf "%x",s1
```

shows that the value is 203, the lower two bytes of the specified value.

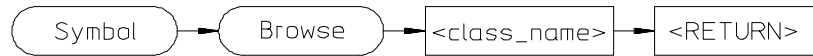

Symbol Browse



The Symbol Browse command displays the parents and children of a C++ class. The inheritance relationship is displayed in the Journal window.

Example

To display the parents and children of the C++ class *fruit*, type:

```
Symbol Browse fruit
```

Symbol Display

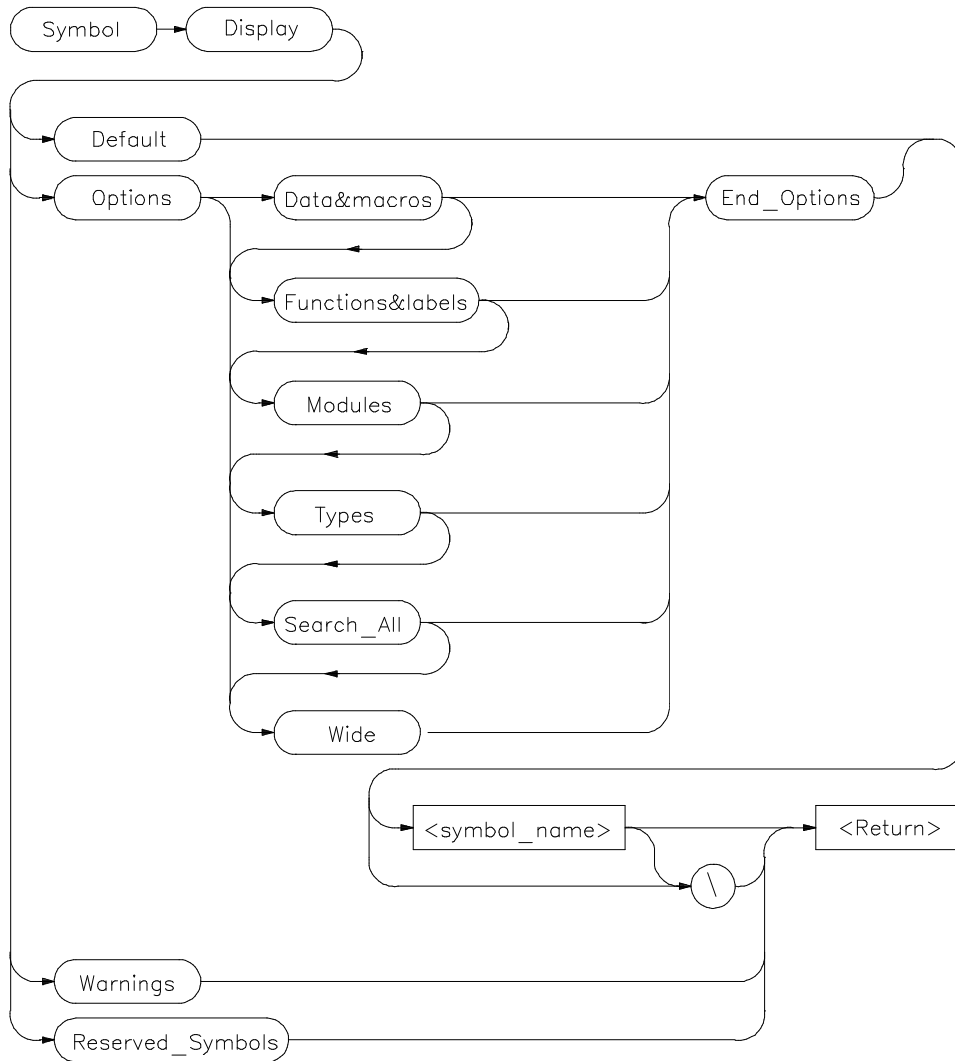

The Symbol Display command displays symbols and associated information in the Journal window.

Chapter 12: Symbol Display

To display symbols in all modules, specify a backslash as the command argument.

```
Symbol Display Default \
```

To displays all symbols in a specified module or function, enter a module name or function name followed by a backslash.

```
Symbol Display Default memset\
```

The wildcard character * may be placed at the end of a symbol name with any option. The * can be used to represent zero or more characters. If used with no symbol name, * is treated the same as \, that is, all symbols are displayed.

If you enter a symbol name without a module specification, the debugger looks for the symbol in the current module. If there is no module qualifier, all symbols with the specified name will be displayed, including global symbols and symbols local to the module. Global symbols are not attached to a module.

```
Symbol Display Default dest
```

If you specify a structure name using the Types option, the debugger shows all members in the structure and their types.

Default

If you specify Default, the debugger displays all types of symbols.

Options

The following options may be specified to display subsets of symbols.

| | |
|------------------|--|
| Data¯os | displays symbol name, storage class, data type, and addresses of data and macro symbols. |
| Functions&labels | displays symbol name, storage class, data type, return type, and addresses of functions and labels. |
| Modules | displays names, module type (high-level, assembly-level, or non-loaded), and section addresses of modules. |
| Types | displays all symbol types. |

Search_All displays symbols of all types in all roots (contexts).

Wide shows symbol names only in multicolumn (compressed)
 format.

If you do not specify any options, the debugger displays all symbols.

Warnings

When you execute the Symbol Display Warnings command, the debugger displays type mismatches. Mismatches occur when global variables are declared with different types in different modules or global functions are declared with different return types or argument counts in different modules. The command displays all mismatches and the names of the modules in which the symbols are declared.

Reserved_Symbols

If you specify Reserved_Symbols, the debugger displays processor reserved symbols, registers, and internal debugger variables.

See Also

Symbol Add
Symbol Remove

Examples

To display the symbol 'updateSys' in the current module:

```
Symbol Display Default updateSys
```

```
Symbol Display Default updateSys
  @ecs\\updateSys   : Type is High level module.
                   Code section = 00001436 thru 00001C21
```

To display all symbols in module 'updateSys':

```
Symbol Display Default updateSys\
```

```
> Symbol Display Default updateSys\
  Root is: updateSys
      @ecs\\updateSys   : Type is High level module.
                          Code section = 00001436 thru 00001C21
  updateSys\update_state_of_system
                          : Type is Global Function returning void.
                          Address = 00001436 thru 00001513
```

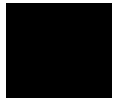

Chapter 12: Symbol Display

```
update_state_of\refresh
      : Type is Local int.
      Address = Frame + 8
update_state_of\interval_complete
      : Type is Local int.
      Address = Frame + 12
:
:
```

To display all modules in the current symbol tree:

```
Symbol Display Options Modules End_Options \
```

```
Symbol Display Options Modules End_Options \
Root is: @ecs
      31 source and 23 assembler modules, 28 source procedures.
      Filename = ecs.x

@ecs\main      : Type is High level module.
                Code section = 00001050 thru 00001121
                Code section = 00000100 thru 0000010B
@ecs\initSystem : Type is NON-LOADED module.
                Code section = 00001122 thru 00001435
:
:
```

To display all function and labels in module 'main':

```
Symbol Display Options Function&labels End_Options main\
```

To display all reserved symbols:

```
Symbol Display Reserved_Symbols
```

To display all symbols in module systemInt in compressed format (symbol names only):

```
Symbol Display Options Wide End_Options systemInt\
```

```
Symbol Display Options Wide End_Options systemInt\
Root is: systemInt

systemInt\      system_interrupt function
struct_system_clock hours      minutes
seconds
tick_clock function argument_1      system_interrupt
tick_clock      time      reg_param1
increment
```

To display all data and macros found within any symbol tree (that is, search \, @a.out\, @file1\, etc.):

```
Symbol Display Options Data&Macros Search_All  
End_Options \
```

```
Symbol Display Options Data&macros Search_All End_Options \  
Root is: @ecs  
  31 source and 23 assembler modules, 30 source procedures.  
  Filename = ecs.x  
  
update_state_of\refresh  
  : Type is Local int.  
  Address = Frame + 8  
update_state_of\interval_complete  
  : Type is Local int.  
  Address = Frame + 12
```

To display data type struct_temp_settings:

```
Symbol Display Options Types End_Options  
struct_temp_settings\  

```

```
Symbol Display Options Types End_Options struct_temp_settings\  
Root is: struct_temp_settings  
  
  @ecs\\struct_temp_settings  
  : Type is Type definition of Structure, size  
= 8.  
struct_temp_set\temp : Type is Member of type float.  
  Offset = 0  
struct_temp_set\humid : Type is Member of type int.  
  Offset = 4
```

To display any type mismatches detected in the user program during program loading, along with the address of the symbol that has the mismatch:

```
Symbol Display Warnings
```

```
2 mismatches.  
getOpInput\system_off: Type is Global Function returning void.  
  Address = 000024AE to 000025ED  
  ***1 modules mismatched ***  
  Modules: 'main'  
updateSys\write_output_command  
  : Type is Global Function returning void.  
  Address = 00001944 to 0000197B  
  *** 1 modules mismatched ***  
  Modules: 'getOpInput'
```

Symbol Remove

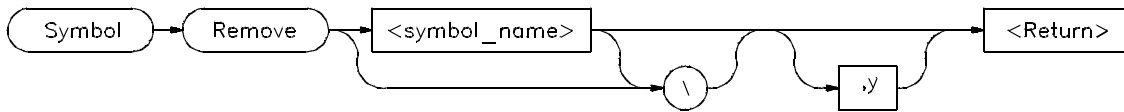

The Symbol Remove command removes the specified symbol from the symbol table. Only program symbols and user-defined debugger symbols can be deleted from the symbol table.

To delete all symbols within a named module or function, append a backslash (\) to the module or function name (< symbol_name>).

```
Symbol Remove updateSys\
```

Entering a backslash without a module or function name deletes all symbols in all modules.

```
Symbol Remove \
```

If you specify a symbol name without a module specification, the debugger looks for the symbol in the current module.

If you specify more than one symbol to be deleted or if the specified symbol has local symbols (for example, when a macro is deleted), the debugger requests confirmation. Entering ,y after the symbol name provides automatic confirmation of the request. This option is useful in command files.

The debugger lets you add a debugger symbol with the same name as a target module's local symbol or a predefined macro's local symbol. If you do add a debugger symbol with same name as a local symbol, you must specify the entire symbol name with the Symbol Remove command in order to remove it. For example, if you added the debugger symbol *alter_settings* when running the demonstration program, you must enter `\\alter_settings` instead of *alter_settings* to delete the symbol because there is a local symbol *alter_settings* in target module *updateSys*. Otherwise the error message *error # 152, Cannot delete: more than one symbol with this name* is displayed.

See Also

Symbol Add
Symbol Display

Examples

To delete symbol 'current_targets' in function 'alter_settings':

```
Symbol Remove alter_settings\current_targets
```

To delete all symbols in module 'updateSys':

```
Symbol Remove updateSys\
```

To delete symbol 'alter_settings' in module 'updateSys':

```
Symbol Remove updateSys\alter_settings
```

In this example, the symbol being removed is a function which contains other symbols. The debugger prompts you with the message 'This symbol has a sub-tree. Delete with sub-tree? (Y/N)'. Enter 'Y' to delete the symbol and its sub-tree. If you respond with 'N', the command is canceled.

To delete all symbols in all modules:

```
Symbol Remove \
```



Trace Again



The Trace Again starts a trace using the last (previous) trace specification. The trace starts on the next program run or step command.

If no trace has been previously specified, this command is equivalent to entering a *Trace Trigger Never* command, and states are collected until you enter a *Trace Halt* command.

Example

To start a new trace using the last trace specification:

```
Trace Again
```

Trace deMMUer

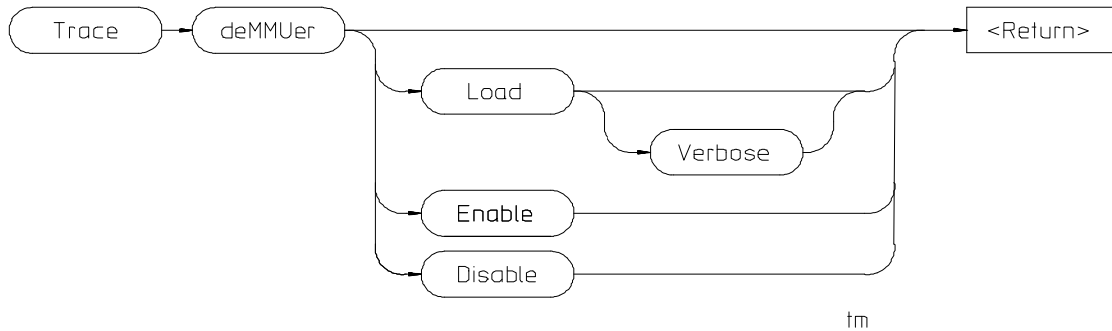

The Trace deMMUer command allows you to choose between tracing physical addresses and tracing logical addresses.

You must enable the MMU before tracing MMU activity. The *68020/030 Graphical User Interface User's Guide* describes how to use the emulator configuration commands and the TC register to enable the MMU.

Load

The Trace deMMUer Load command reads the MMU registers and MMU tables, and loads the deMMUer with the appropriate information to reverse-translate physical addresses to logical addresses.

The Verbose option shows a list of the physical addresses that can be translated by the deMMUer.

Enable

The Trace deMMUer Enable command turns on the deMMUer. Physical addresses on the emulation bus will be translated to logical addresses.

Disable

The Trace deMMUer Disable command turns off the deMMUer. Physical addresses on the emulation bus will not be translated.

Chapter 12:
Trace deMMUer

See Also

The "Using MC68030 Memory Management" chapter in the *68020/030 Graphical User Interface User's Guide*.

Examples

To translate physical to logical addresses, make sure that the MMU has been set up, then enter:

```
Trace deMMUer Load Verbose  
Trace deMMUer Enable
```

To stop translating physical to logical addresses, enter:

```
Trace deMMUer Disable
```

Trace Display

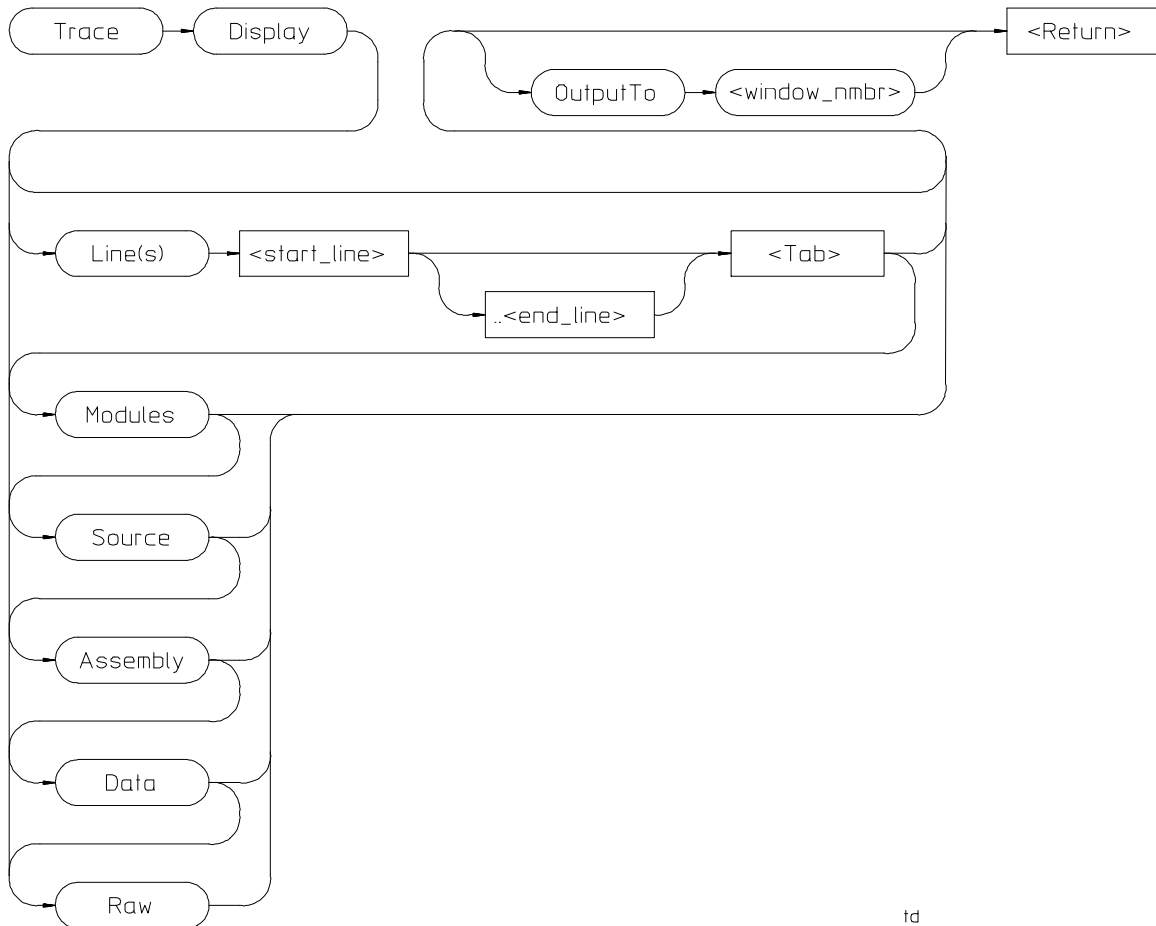

The Trace Display command displays trace information in the specified window. If no window is specified, the trace output will go to the Trace Mode window, and the debugger will enter "trace mode."

Chapter 12: Trace Display

Data may be displayed (interpreted) in several ways: from module and function entry and exit points, to raw bus data. The default display will show modules and source line references only.

Trace mode

In trace mode, the trace information is displayed in the View window. You cannot enter debugger commands from the command line while in trace mode. To return to debugger command mode, press the *ESC* key twice.

In trace mode, you can use the cursor keys to scroll the trace information in the View window. Use the Next and Prev keys to page through the trace output.

Function keys Function keys *F1*, *F3*, *F4* and *F5* do their normal functions when you are in trace mode. However, *F1* (Next Window) activates only the Code or Trace Mode windows. You can use the *F3* function key to switch between the high-level and assembly-level displays in the Code window when tracking trace data.

F2, *F6*, *F7*, and *F8* have special functions when in the trace mode. Function key *F2* lets you enter a new line number to display at the top of the trace list display. The *F6* function key changes the track direction (backward or forward) in the trace window. The *F7* function key scrolls the trace list up or down in the Trace Mode window and updates the Code window so that the highlighted line corresponds to the new first line displayed in the Trace Mode window. The *F8* function key toggles the top line high-level module identification on or off to allow an extra line of trace information to be displayed. The top line high-level module identification must be on to enable tracking.

Tracking source code The debugger gives you the capability to correlate the data in the trace display with source code displayed in the Code window. To view trace information in relationship to the source code, select a line in the trace list with the cursor and then press **F7** or the **Return** key. This updates the Code window so that the highlighted line in the code window corresponds to the first line displayed in the Trace Mode window. Pressing *F7* or the *Return* key again scrolls the trace list in the Trace Mode window and updates the Code window so that the highlighted line corresponds to the new first line displayed in the Trace Mode window.

Press the **F6** function key to change the track direction (backward or forward) in the Trace Mode window. The trace direction is indicated on the bottom

border of the Trace Mode window (^ or v). The symbols show which direction the search will proceed through the trace buffer to find the next high-level or assembly code line (depending on the Code window selected). If the trace window has no lines that correspond to code lines, the search will proceed to the end of the trace buffer.

If you have specified storage qualifiers, the trace data may not track sequentially with the lines in the code display.

Directing output to a specified window or file

Use the OutputTo keyword to redirect trace output to a window or file other than the View window. The following values are valid window numbers for trace output:

| | |
|----------|-------------------------------|
| 1 | high-level Journal window |
| 10 | assembly-level Journal window |
| 24 | View window |
| 28 | log file |
| 29 | journal file |
| 50 – 256 | user-defined windows |

Line(s) keyword

Use the Line(s) keyword to specify a range of lines to be copied from the trace buffer to the specified window. For example, to copy lines -110 through -90 from the trace buffer to the journal file, enter the command:

```
Trace Display Line(s) -110..-90 <Tab> OutputTo 29
```

You cannot specify a line range for trace output when entering trace mode. However, you may specify the first line to display in trace mode. For example, to display the trace buffer starting at line -110, enter the command:

```
Trace Display Line(s) -110
```

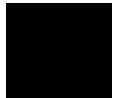

Chapter 12: Trace Display

Display qualifiers

The following display qualifiers let you select what information is written to the output window and how the information is formatted.

| | |
|----------|---|
| Line(s) | Specifies the starting line or the range of lines to display or copy. Line 0 is the trigger cycle. You cannot specify a range when entering trace mode. |
| Modules | Displays names of module the trace lines are in, entering, or re-entering. This is useful for showing general program flow. |
| Source | Display the source lines and line numbers corresponding to instruction fetches. |
| Assembly | Displays assembly language instructions. Information is displayed symbolically when possible. |
| Data | Displays address, value, and read/write status for data accesses. Information is displayed symbolically when possible. |
| Raw | Display the frame number, address, data and status for a bus cycle with no interpretation of the data. |

Displaying status information Status information is displayed mnemonically in the trace list. The following table describes the mnemonics that may be displayed.

| Mnemonic | Description |
|----------|-------------|
|----------|-------------|

Function Code Space

| | |
|------|------------------------------------|
| User | Cycle occurred in user space |
| Supv | Cycle occurred in supervisor space |
| Prog | Cycle occurred in program space |
| Data | Cycle occurred in data space |

| | |
|-----|----------------------------|
| FC0 | Cycle used function code 0 |
| FC3 | Cycle used function code 3 |
| FC4 | Cycle used function code 4 |
| CPU | Cycle refers to CPU space |

Cycle Type

| | |
|------------|-------------------------------|
| Code Fetch | Cycle was a code fetch |
| DMA cycle | Cycle was a DMA cycle |
| Read | Cycle was a read cycle |
| Write | Cycle was a write cycle |
| Copr | Cycle was a coprocessor cycle |

Termination

| | |
|------|--|
| ds8 | <u>DSACK</u> 8 bit port |
| ds16 | <u>DSACK</u> 16 bit port |
| ds32 | <u>DSACK</u> 32 bit port |
| strm | Synchronous termination (68030/68EC030 only) |

68030 MMU

| | |
|-----------|-------------------------------|
| tablewalk | Tablewalk cycle for 68030 MMU |
| log | Logical address |
| phy | Physical address |

Other

| | |
|------|--------------------------|
| Berr | Bus error cycle |
| Rtry | Retry cycle |
| bgnd | Background monitor cycle |
| Halt | Halt cycle (68020 only) |

Data size

| | |
|------|---------|
| Byte | 1 byte |
| Word | 2 bytes |
| Long | 4 bytes |
| 3byt | 3 bytes |

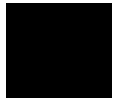

Trace status character When trace data is displayed, a trace status character may be displayed in front of the trace line. The following table defines the trace status characters.

Trace List Status Characters

| Character | Description |
|------------------|--|
| * | The indicated trace line is the trigger condition. |
| + | The indicated trace line is an assembly language statement within a high-level statement, that is, not the first assembly language statement in the high-level source statement. |
| ! | The data field in the trace buffer line does not match the data in memory. |
| ? | The trace line may be a prefetch. |

Examples

To display source lines, their corresponding assembly language instructions, and data read and write cycles:

```
Trace Display Modules Source Assembly Data
```

To copy the raw data in lines -20 through + 20 of the trace buffer to a log file you have opened:

```
Trace Display Lines -20..20 <Tab> Raw OutputTo 28
```

Trace Event Clear_All

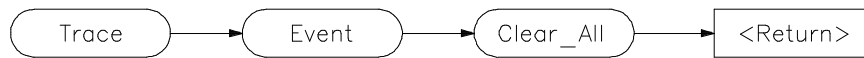

The Trace Event Clear_All command clears (removes) all specified events that are not used by the trigger or store qualifier.

See Also Trace Event Delete

Examples To clear (remove) all defined trace events:

Trace Event Clear_All

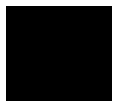

Trace Event Delete



The Trace Event Delete command deletes (removes) a previously defined event specification. You cannot delete an event that is used by the trigger or store qualifier.

See Also Trace Event Clear_All
 Trace Event Specify

Examples To delete event 2:

 Trace Event Delete 2

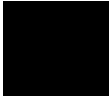

Trace Event List



The Trace Event List command lists the definition of the event specified by < event_nmbr> in the View window. The definition includes address, data, and status. The command used to define the event is listed, as well as an indication if the event is used by the trigger or qualifier.

See Also Trace Event Specify

Examples To list the definition of event 3 in the View window:

Trace Event List 3



Trace Event Specify

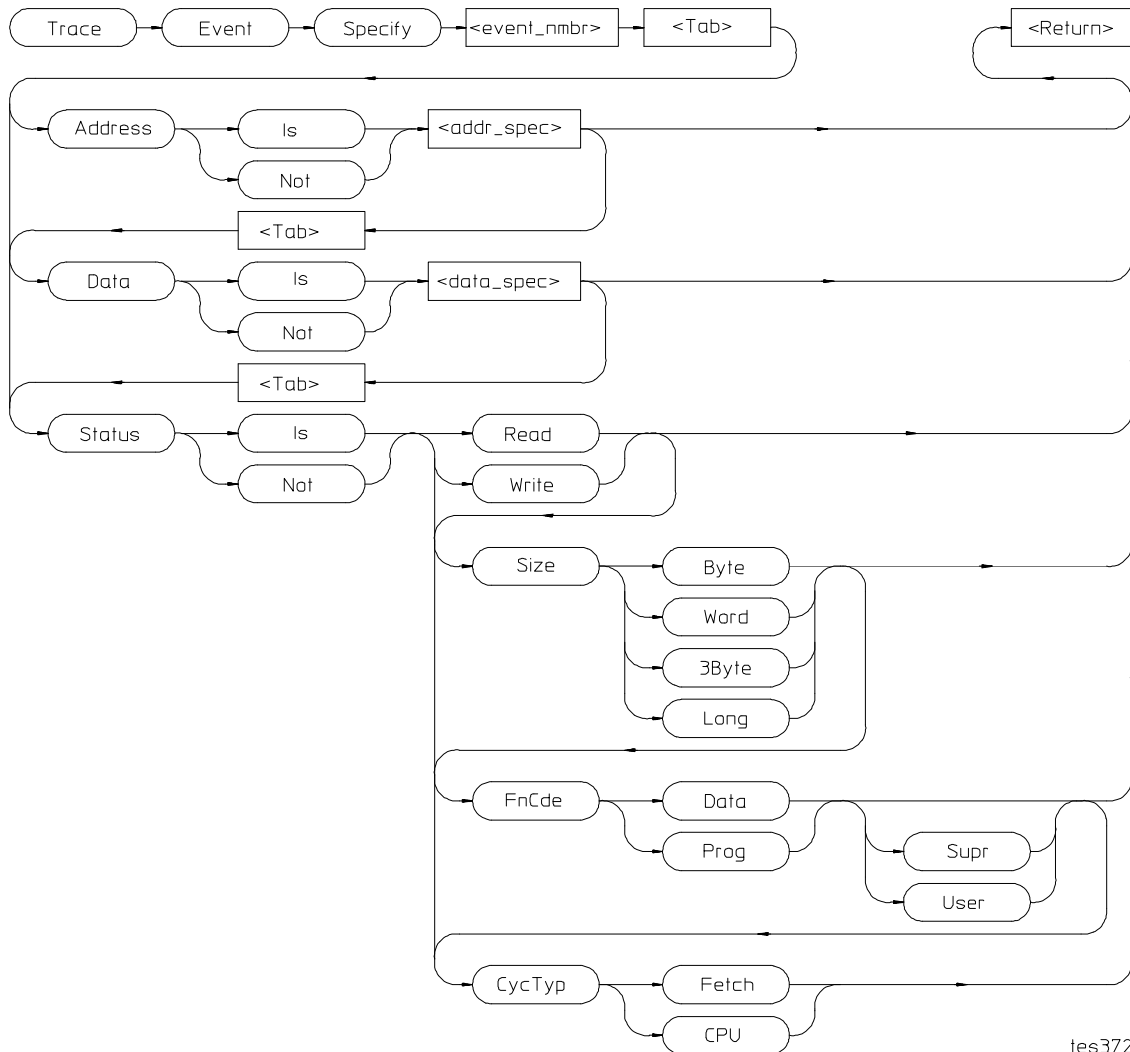

tes372

The Trace Event Specify command defines an event (detectable bus condition to be used for trace qualifying or triggering. The event number (< event_nmbr>) must be a number between 1 and 30 inclusive. Bus

conditions may be address values, data values, or status values. The event is true if all of the terms defined in the event are true at the same time.

Event conditions

Three types of conditions can be specified in an event definition. The three condition types are:

| | |
|---------|---|
| Address | The value that appears on the address bus. The address term matches an address, range of addresses, or out-of-range addresses. |
| Data | The value that appears on the data bus. The data term matches a data value or range of values. The data size is that of the data field as specified by the analyzer. This typically matches the processor bus size. |
| Status | The type of bus activity, for example: instruction fetch, read, write, CPU, etc. |

If you use the keyword **Is**, the event is defined as the specification that follows. If you use the keyword **Not**, the event is defined as the logical NOT of the specification that follows, that is, any condition that does not match the specification. For example, if you enter the specification:

```
Trace Event Specify 1 <Tab> Address Is 0x10b6..0x123d
```

event 1 is defined to be any address in the range 0x10b6 through 0x123d. If you enter the specification:

```
Trace Event Specify 1 <Tab> Address Not 0x10b6..0x123d
```

event 1 is defined to be any address **outside** the range 0x10b6 through 0x123d.

Address and data values

Address values (<addr_spec>) and data values (<data_spec>) are specified as 32-bit values or a range of 32-bit values denoted by (..). You can specify address values using module names, symbols, and high-level line numbers. See the “Expressions and Symbols in Debugger Commands” chapter for detailed information on how to specify addresses.

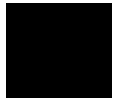

Chapter 12: Trace Event Specify

A mask can be used to specify a range with a 32-bit value that marks valid bits in addresses or data. For example, to specify only addresses in the range *000015xxh* (where *xx* are "don't care" values), you could enter the command:

```
Trace Event Specify 4 <Tab> Address Is  
0x1500 &= 0xffffffff00
```

The `&=` is the bit mask operator. This range could also have been specified as `0x1500..0x15ff`.

Status values

Status conditions are the types of bus activities you wish to specify. The following keywords are used to specify the status condition:

| | |
|--------|---|
| Read | specifies read operation |
| Write | specifies write operation |
| Size | specifies access size (byte, word, or long) |
| FnCde | specifies function code (data or program, supervisor or user mode) |
| CycTyp | specifies cycle type (Fetch or CPU) |

Addresses specified with a `CycTyp` of `Fetch` will be masked to the size specified by Debugger Option `Trace Fetch_Align`.

See Also

Trace Event `Clear_All`
Trace Event `Delete`
Trace Event `List`
Debugger Option `Trace Fetch_Align`

Examples

To define event 1 to be the address of function `update_state_of_system`:

```
Trace Event Specify 1 <Tab> Address Is  
update_state_of_system
```

To define event 2 to be any bus cycle corresponding to an instruction fetch from supervisor memory space:

```
Trace Event Specify 2 <Tab> Status Is FnCde Supr CycTyp  
Fetch
```

To define event 3 to be a write access of variable current_humid:

```
Trace Event Specify 3 <Tab> Address Is  
&current_humid <Tab> Status Is Write
```

If an 8-bit wide I/O port at 0fxxx0010h has a "data valid" bit at bit 3, you can specify a trace event when the "data valid" bit is read by entering:

```
Trace Event Specify 5 <Tab> Address Is  
0f0000010 &= 0xf000ffff <Tab> Data Is 0x8 &= 0xff
```

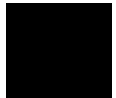

Trace Event Used_List



The Trace Event Used_List command lists the numbers of the events that are currently defined and whether or not the event is being used (specified in a Trace Trigger or Trace StoreQual definition).

See Also

Trace Event Specify
Trace Trigger Event
Trace StoreQual Event

Examples

To list the currently defined events and their status (used or not used):

```
Trace Event Used_List
```

Trace Halt



The Trace Halt command stops (terminates) the trace currently being executed. If a trace is not in progress, this command has no effect. After executing this command, you can display any trace data collected.

See Also Trace Again

Examples To stop the current trace:

`Trace Halt`

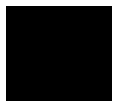

Trace StoreQual

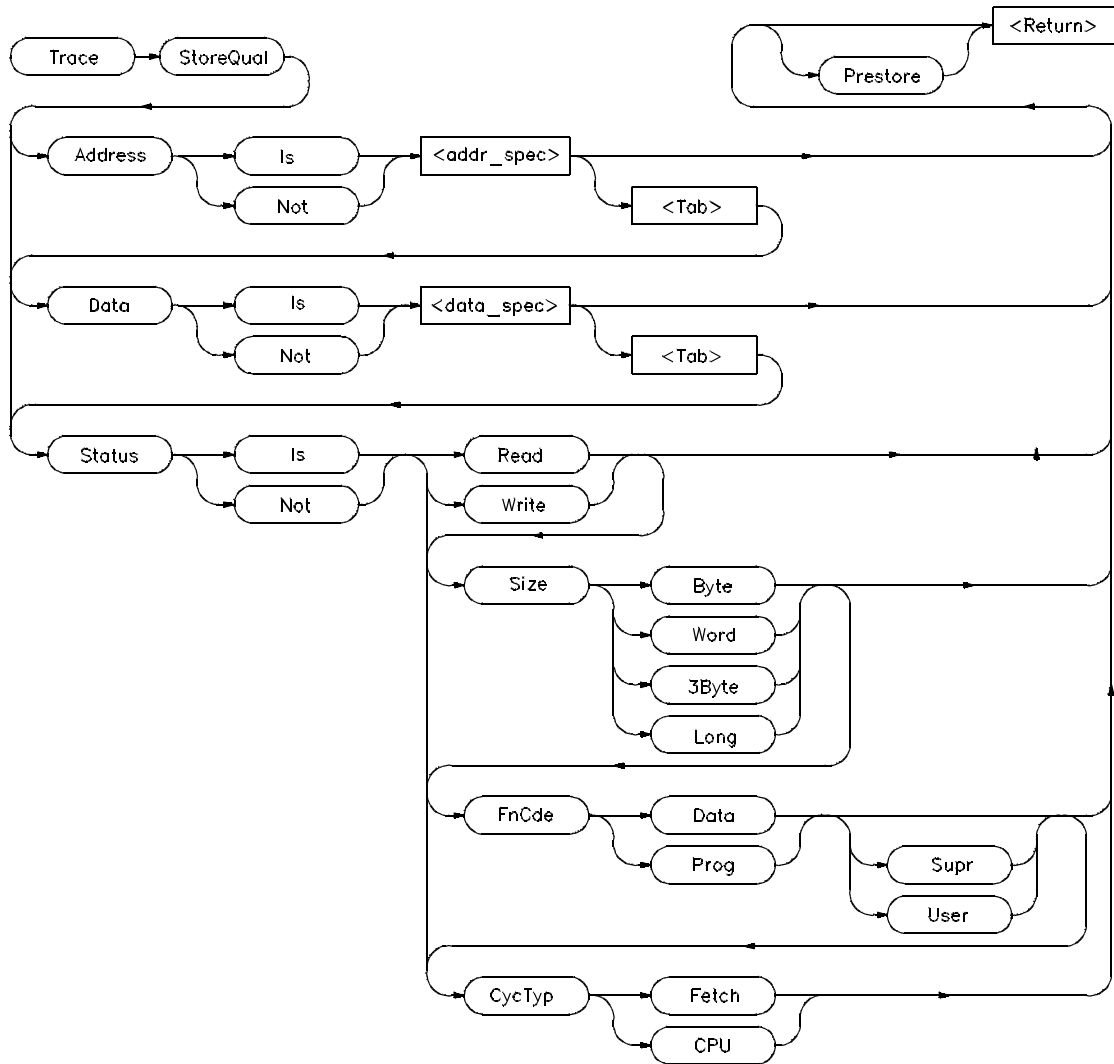

The Trace StoreQual command immediately specifies the bus conditions to be stored (captured) in the trace buffer. Bus conditions may be address values,

data values, or status values. When you define a storage qualifier, you are essentially defining an event. You can also use the *Trace Event Specify* command to define an event, and then use the *Trace StoreQual Event* command to use the specified event as a storage qualifier term.

Storage qualifier conditions

Three types of conditions can be specified as storage qualifiers. The three condition types are:

| | |
|---------|--|
| Address | The value that appears on the address bus |
| Data | The value that appears on the data bus |
| Status | The type of bus activity, for example, instruction fetch, read, write, CPU, etc. |

If you use the keyword **Is**, bus cycles matching the specification that follows are stored in the trace buffer. If you use the keyword **Not**, the storage qualifier is defined as the logical NOT of the specification that follows, that is, any bus cycles that do not match the specification are stored in the trace buffer. For example, if you enter the specification:

```
Trace StoreQual Address Is 0x10b6..0x123d
```

the storage qualifier is defined to be any address in the range 0x10b6 through 0x123d. If you enter the specification:

```
Trace StoreQual Address Not 0x10b6..0x123d
```

the storage qualifier is defined to be any address **outside** the range 0x10b6 through 0x123d.

Address and data values

Address values (*<addr_spec>*) and data values (*<data_spec>*) are specified as 32-bit values or a range of 32-bit values denoted by (..). You can specify address values using module names, symbols, and high-level line numbers. See the “Expressions and Symbols in Debugger Commands” chapter for detailed information on how to specify addresses.

A mask can be used to specify a range with a 32-bit value that marks valid bits in addresses or data. For example, to store only addresses in the range

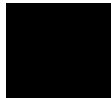

Chapter 12:
Trace StoreQual

0x000015xx (where xx are "don't care" values), you could enter the command:

```
Trace StoreQual Address Is  
0x1500 &= 0xffffffff00
```

where `&=` is the bit mask operator.

This format is used because the C language does not have a way to represent a don't care literal.

Note

Execute the *Debugger Execution Environment Unrestricted* command before specifying an event with an address to ensure that the analyzer interprets the chip selects properly for the address. See the description of the *Debugger Execution Environment Unrestricted* command.

Status values

Status conditions are the types of bus activities you wish to specify. The following keywords are used to specify the status condition:

| | |
|--------|---|
| Read | specifies read operation |
| Write | specifies write operation |
| Size | specifies access size (byte, word, or long) |
| FnCde | specifies function code (data or program, supervisor or user mode) |
| CycTyp | specifies cycle type (Fetch or CPU) |

Addresses specified with a CycTyp of Fetch will be masked to the size specified by Debugger Option Trace Fetch_Align.

Prestore

Specifying *Prestore* in your storage qualifier definition causes the trace function to store up to two instruction fetch cycles preceding the qualified condition being stored. This lets you view the instructions leading up to the qualified state.

See Also

Trace StoreQual Event
Trace StoreQual List
Trace StoreQual None
Debugger Option Trace Fetch_Align

Examples

To store accesses to *update_state_of_system* along with the two bus cycles immediately preceding the accesses.

```
Trace StoreQual Address Is update_state_of_system  
Prestore
```

To store only instruction fetches with an opcode value of *4e5x* where *x* is a don't care value:

```
Trace StoreQual Data Is 0x4e50 &= 0xffff0 <Tab> Status  
Is CycTyp Fetch
```

The don't care condition is specified by specifying a mask in the data specification. *&=* is the mask operator. This value corresponds to the LINK and UNLK instructions.

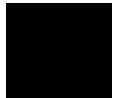

Trace StoreQual Event

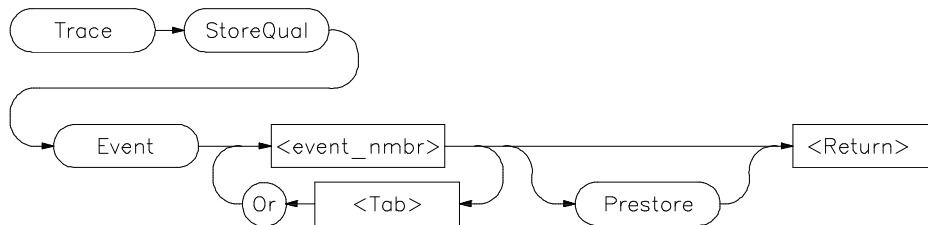

The Trace StoreQual Event command lets you specify an event or combination of events defined with the *Trace Event Specify* command as the storage qualifier.

Events

Each event that you define using the Trace Event Specify command is assigned an event number between 1 and 30. This number (< event_nmbr >) is used to assign an event to be a storage qualification term. The storage qualification term can be a single event or a logically OR'ed combination of events.

Prestore

Specifying *Prestore* in your storage qualifier definition causes the trace function to store up to two instruction fetch cycles preceding the qualified condition being stored. This lets you view the instructions leading up to the qualified state.

See Also

Trace StoreQual
Trace StoreQual List
Trace StoreQual None

Examples

To store only states matching event 1 defined with the Trace Event Specify command and the last two instruction fetches preceding each of these states:

```
Trace StoreQual Event 1 <Tab> Prestore
```

Chapter 12:
Trace StoreQual Event

To store only states matching event 1 or event 2 defined with the Trace Event
Specify command:

Trace StoreQual Event 1 <Tab> Or 3



Trace StoreQual List



The Trace StoreQual List command displays the current storage qualification definition in the View window.

See Also

Trace StoreQual
Trace StoreQual event

Examples

To list the current storage qualification definition in the View window:

```
Trace StoreQual List
```

Trace StoreQual None

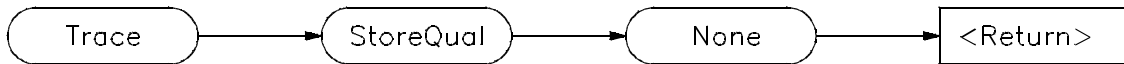

The Trace StoreQual None command causes the trace function to store all bus cycles (no trace qualification).

See Also Trace StoreQual
 Trace StoreQual event

Examples To store all bus cycles (no trace qualification):
 Trace **S**to**r**eQual **N**one

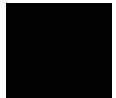

Trace Trigger

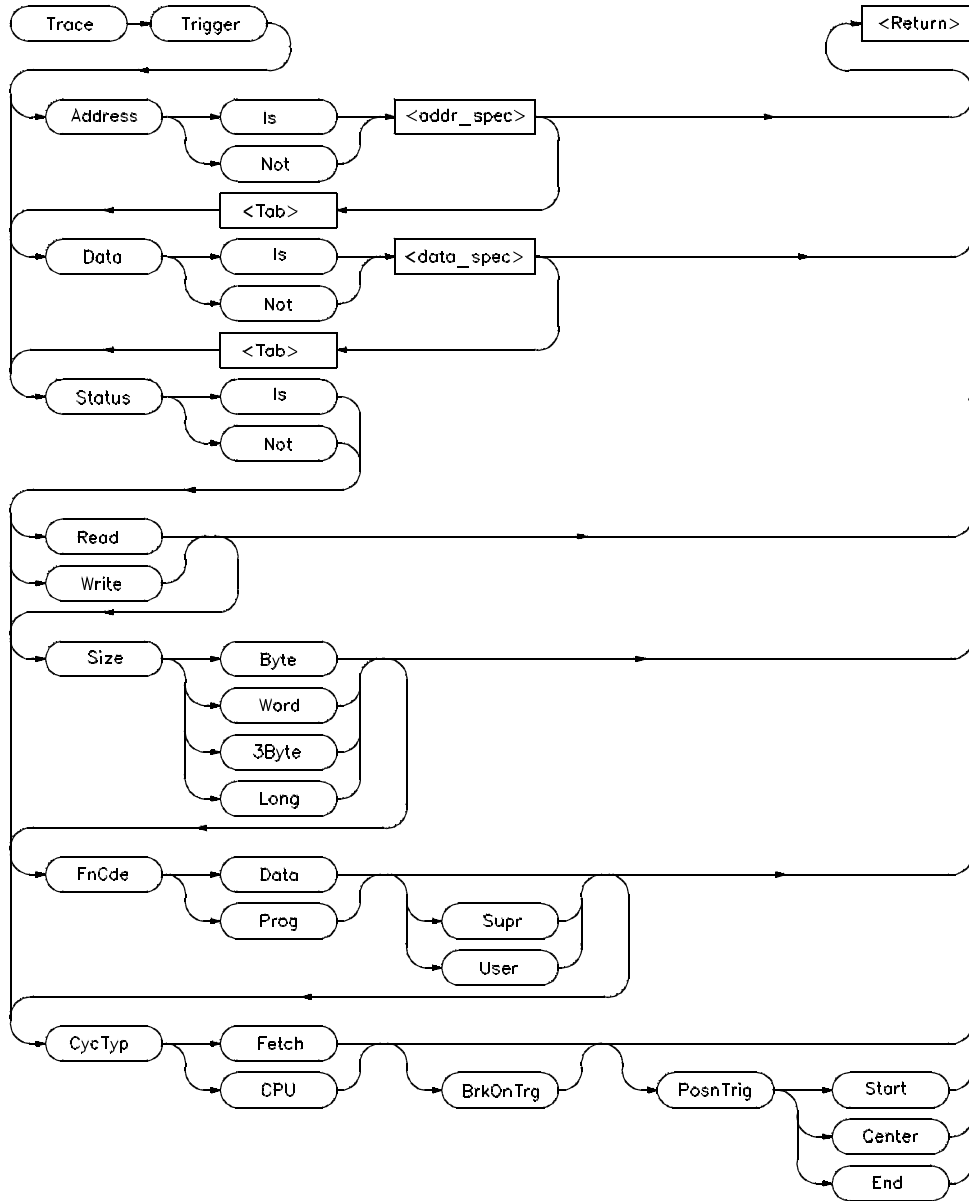

The Trace Trigger command specifies the bus conditions to be used as the trigger condition. Bus conditions may be address values, data values, or status values. When you define a trigger, you are essentially defining an event. You can also use the *Trace Event Specify* command to define an event, and then use the *Trace Trigger Event* command to use the specified event as the trigger event.

Trigger conditions

Three types of conditions can be specified in triggers. The three condition types are:

| | |
|---------|--|
| Address | The value that appears on the address bus |
| Data | The value that appears on the data bus |
| Status | The type of bus activity, for example, instruction fetch, read, write, interrupt acknowledge, etc. |

If you use the keyword **Is**, bus cycles matching the specification that follows are used as the trigger event. If you use the keyword **Not**, the trigger is defined as the logical NOT of the specification that follows, that is, any bus cycle that does not match the specification is the trace trigger. For example, if you enter the specification:

```
Trace Trigger Address Is 0x10b6..0x123d
```

the trigger is defined to be any address in the range 0x10b6 through 0x123d. If you enter the specification:

```
Trace Trigger Address Not 0x10b6..0x123d
```

the trigger is defined to be any address **outside** the range 0x10b6 through 0x123d.

Address and data values

Address values (*<addr_spec>*) and data values (*<data_spec>*) are specified as 32-bit values or a range of 32-bit values denoted by (..). You can specify address values using module names, symbols, and high-level line numbers. See the “Expressions and Symbols in Debugger Commands” chapter for detailed information on how to specify addresses.

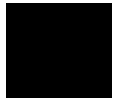

Chapter 12: Trace Trigger

A mask can be used to specify a range with a 32-bit value that marks valid bits in addresses or data. For example, to trigger only on addresses in the range *0x000015xx* (where *xx* are "don't care" values), you could enter the command:

```
Trace Trigger Address Is
0x1500 &= 0xffffffff00
```

where *&=* is the bit mask operator.

Status values

Status conditions are the types of bus activities you wish to specify. The following keywords are used to specify the status condition:

| | |
|--------|---|
| Read | specifies read operation |
| Write | specifies write operation |
| Size | specifies access size (byte, word, or long) |
| FnCde | specifies function code (data or program, supervisor or user mode) |
| CycTyp | specifies cycle type (Fetch or CPU) |

Addresses specified with a *CycTyp* of *Fetch* will be masked to the size specified by Debugger Option *Trace Fetch_Align*.

Breaking on triggers

Enter the *BrkOnTrg* keyword to cause the user program to halt when the trigger term is detected.

Trigger position

Enter the *PosnTrig* keyword to specify the position of the trigger condition in the trace buffer. You can specify the trigger position to be one of the following:

Start The trigger is at the start of the trace buffer.

Center The trigger is centered in the trace buffer.

End The trigger is at the end of the trace buffer.

The trigger state will always be line number 0 in the trace list.

Interaction with trace commands

The Trace Trigger, Breakpt Access, Breakpt Read, and Breakpt Write commands all require use of emulation analyzer resources. If access breakpoints are active (indicated by the message *TRC: BrkRWA* on the status line), then a Trace Trigger command may not be entered. If a trace trigger is active, access breakpoints may not be entered.

The Breakpt commands set up a trace with the trigger at the end of the trace buffer, using the current storage qualification. You can display the trace after the break occurs to see the cycles leading up to the break.

See Also

Breakpt Access
Breakpt Read
Breakpt Write
Trace Trigger Event
Trace Trigger List
Trace Trigger None
Debugger Option Trace Fetch_Align

Examples

To trigger the trace measurement on entry into function *update_state_of_system* and position the trigger state in the center of the trace memory buffer:

```
Trace Trigger Address Is update_state_of_system Status  
Is FnCde Prog PosnTrig Center
```

To trigger the trace measurement on the occurrence of a write to variable *time_struct.seconds*, and halt (break) program execution on detection of the trigger condition:

```
Trace Event Specify 6 <Tab> Address Is  
&time_struct.seconds <Tab> Data Is 0x3c Status Is Write  
<Tab> BrkOnTrg
```

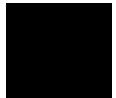

Trace Trigger Event

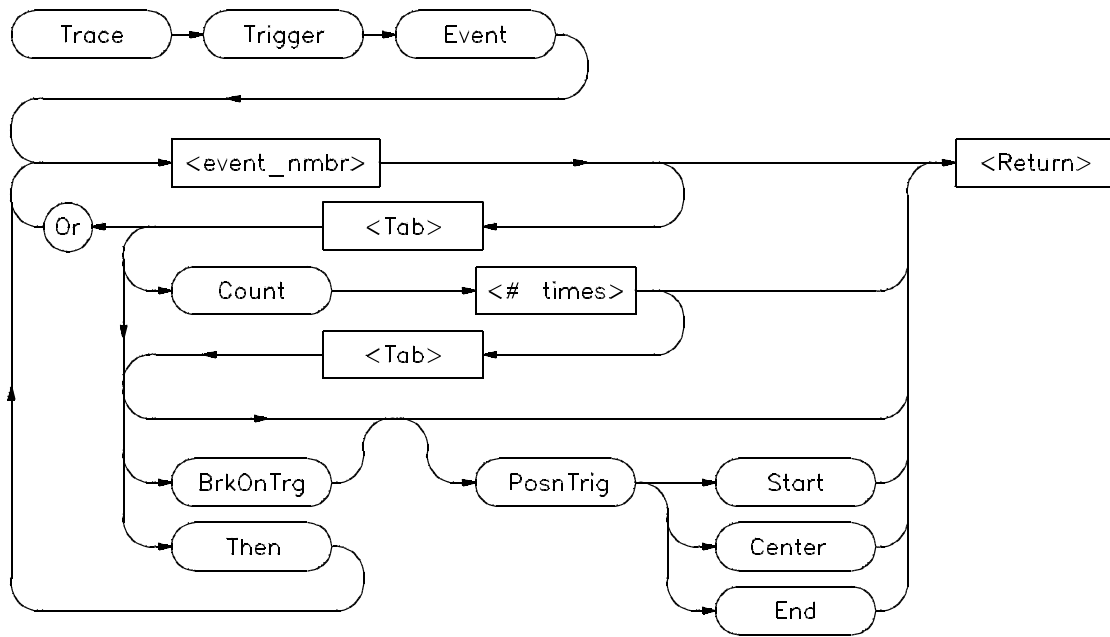

The Trace Trigger Event command lets you specify an event or combination of events defined with the *Trace Event Specify* command as a trigger condition. The trigger condition can be a single event, a logically OR'ed combination of events, a specified number of occurrences of an event or combination of events, or a sequence of the preceding conditions. The complexity of the specification is limited by the analyzer.

Event Number

Each event that you define using the Trace Event Specify command is assigned an event number between 1 and 30. This number (< event_nmbr >) is used to assign an event to be a trigger term.

Keywords

| | |
|----------|--|
| Or | The <i>Or</i> keyword lets you specify a logically OR'ed combination of events as the trigger condition. |
| Count | The <i>Count</i> keyword specifies the number of times (< <i>nmbrr_times</i> >) an event or OR'ed combination of events must occur before the debugger proceeds to the next trigger sequence term or before the trigger condition is completed. < <i>nmbrr_times</i> > must be a value in the range of 1 to 65535. |
| Then | The <i>Then</i> keyword lets you specify a sequence of terms in the trace specification. |
| BrkOnTrg | The <i>BrkOnTrg</i> keyword causes the user program to halt when the trigger term is detected. |
| PosnTrig | The <i>PosnTrig</i> keyword is used with the Start Center, and End keywords to specify the position of the trigger condition in the trace buffer. |
| Start | The <i>Start</i> keyword specifies the start of the trace buffer as the trigger position. |
| Center | The <i>Center</i> keyword specifies the center of the trace buffer as the trigger position. |
| End | The <i>End</i> keyword specifies the end of the trace buffer as the trigger position. |

The trigger state will always be line number 0 in the trace list.

See Also

Trace Trigger
Trace Trigger List
Trace Trigger None



Examples

To trigger on the occurrence of event 1 which has been previously defined with the Trace Event Specify command:

Chapter 12:
Trace Trigger Event

```
Trace Trigger Event 1
```

To trigger on the occurrence of either event 1 or event 3 (events 1 and 3 must have been previously defined with the Trace Event Specify command):

```
Trace Trigger Event 1 <Tab> Or 3
```

To trigger on the fifth occurrence of event 3 following an occurrence of event 1 (events 1 and 3 must have been previously defined with the Trace Event Specify command):

```
Trace Trigger Event 1 <Tab> Then 3 <Tab> Count 5
```

Trace Trigger List

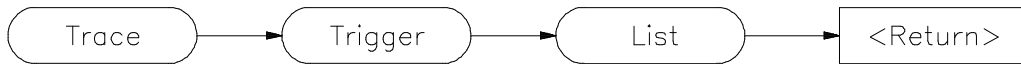

The Trace Trigger List command displays the current trigger definition in the View window.

See Also

Trace Trigger
Trace Trigger List
Trace Trigger None

Examples

To list the current trigger definition in the View window:
`Trace Trigger List`



Trace Trigger Never

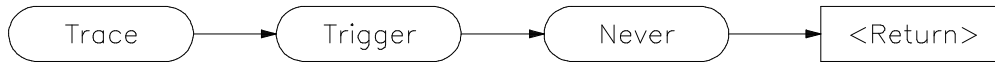

The Trace Trigger Never command sets the trace function up to collect states until you stop the trace using the Trace Halt command. Collection starts on the next program run or step command.

See Also

Trace Halt

Examples

To collect states continuously until the trace is stopped using the Trace Halt command:

`Trace Trigger Never`

Collection starts on the next program run or step command.

Window Active

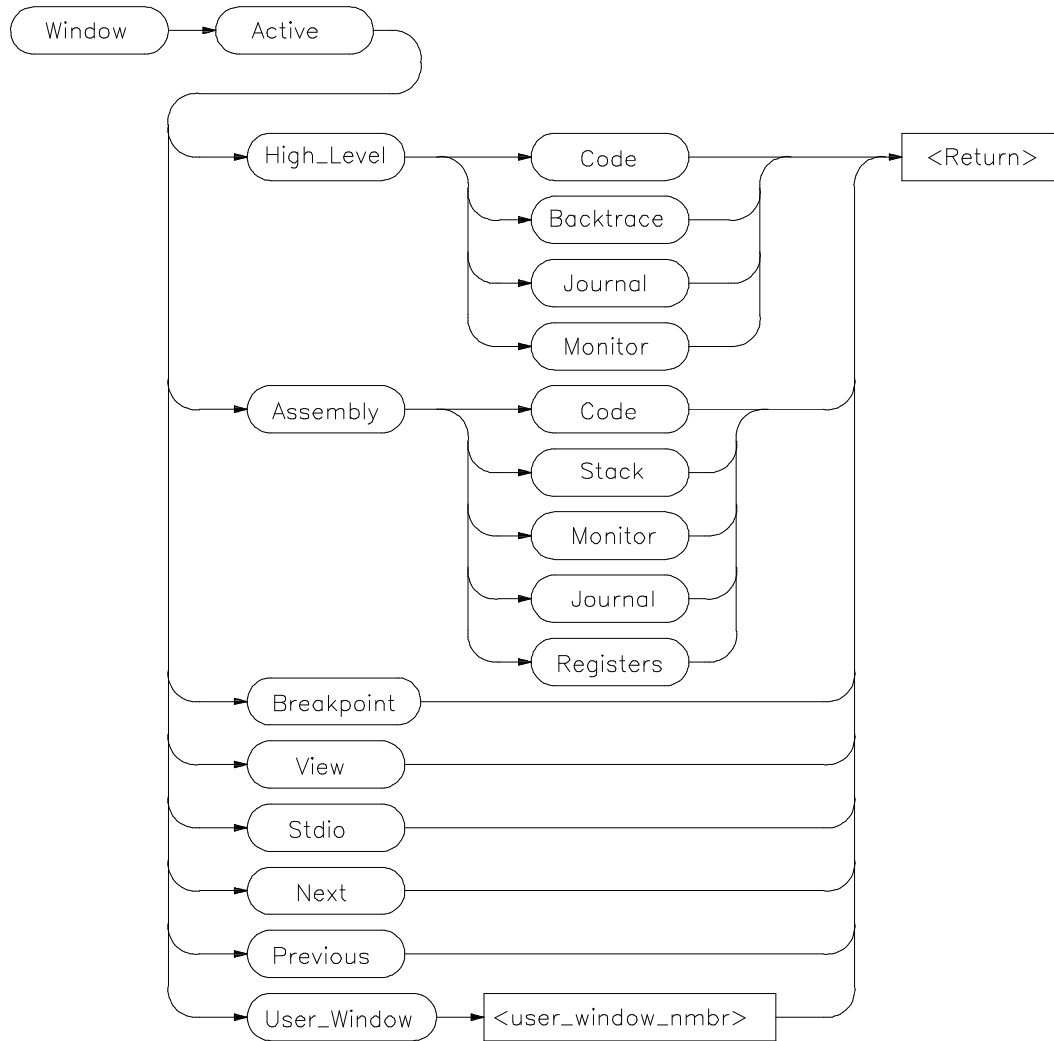

The Window Active command activates the specified window. The border of the active window is highlighted. The Code window is active by default within the high level and low level screens.

Chapter 12:
Window Active

The `Next` and `Previous` parameters specify the next higher-numbered or lower-numbered window relative to the active window.

The cursor keys and the F4 function key only operate in the active window.

The Error, Help, and Status windows cannot be made active.

See Also

Window Cursor
Window Delete
Window Erase
Window New
Window Resize
Window Screen_On
Window Toggle_View

Examples

To make the high-level Backtrace window active:

```
Window Active High_Level Backtrace
```

To make the assembly Code window active:

```
Window Active Assembly Code
```

To make user window 57 active:

```
Window Active User_Window 57
```

Window Cursor

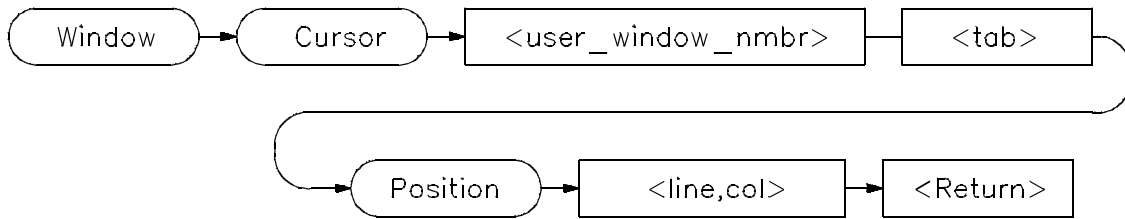

The Window Cursor command sets the cursor position in the window specified by < user_window_nmbr> . The top left corner of the window is represented by coordinates 0,0.

Subsequent output to the window begins at the cursor position.

Only user-defined windows and the standard I/O window (window No. 20) may be specified with this command.

See Also

Window Active
Window Delete
Window Erase
Window New
Window Resize
Window Screen_On
Window Toggle_View

Examples

To move the cursor to line 5, column 22 in the Stdio window:

```
Window Cursor 20 Position 5,22
```

To move the cursor to line 3, column 0 in user window 57:

```
Window Cursor 57 Position 3,0
```

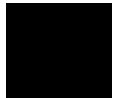

Window Delete

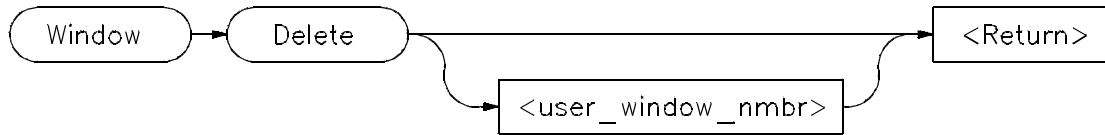

The Window Delete command removes a window (possibly a screen) defined previously with the Window New command. Remove a window by entering the window's associated window number. If you do not specify a window number or if you specify 0, the active window is removed.

Remove screens by removing all windows associated with that screen. For example, if a user-defined screen has three windows and you delete all three windows, the screen will be deleted as well. See the "Displaying Screens" and "Displaying Windows" sections of the "Viewing Code and Data" chapter for more information about window and screen numbers. Predefined debugger windows and screens cannot be removed.

Files opened with the File User_Fopen command may also be closed with this command.

See Also

File User_Fopen
File Window_Close
Window Active
Window Cursor
Window Erase
Window Open
Window Resize
Window Screen_On
Window Toggle_View

Example

To delete user window 57:

Window Delete 57

Window Erase

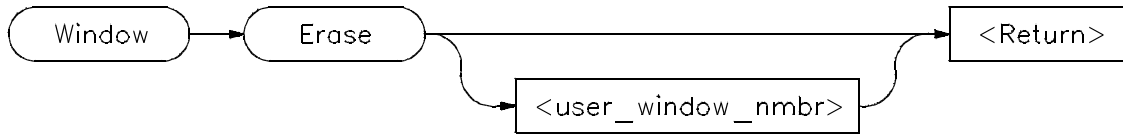

The Window Erase command clears all displayed information in the specified window. It then places the cursor in the specified window to the 0,0 position. If you do not specify a window number or if you specify 0, the active user-defined window is cleared. Only user-defined windows and the standard I/O screen (window No. 20) can be cleared. This command is primarily for use within macros.

See Also

Window Active
Window Cursor
Window Delete
Window New
Window Resize
Window Screen_On
Window Toggle_View

Examples

To clear all displayed information in the Stdio window:

```
Window Erase 20
```

To clear all displayed information in user window 57:

```
Window Erase 57
```



Window New

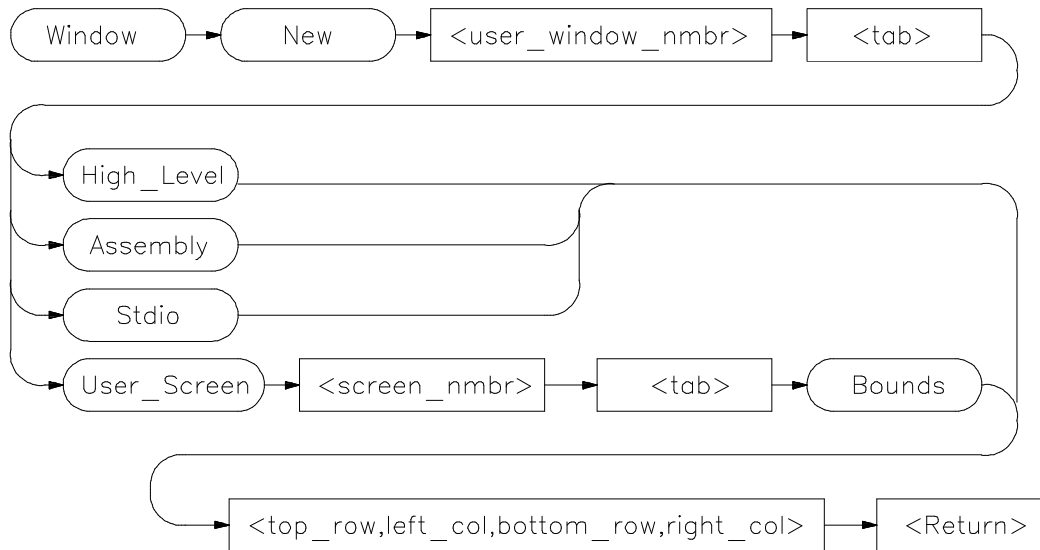

The Window New command makes (creates) new windows and screens. It may also be used to move existing windows to a new location within a screen. Windows must be assigned a number between 50 and 256 inclusive. Numbers 1 through 49 are reserved for predefined debugger windows. The bounds parameter specifies both the window size and location on the screen.

Window coordinates 0,0 correspond with the upper-left corner of the screen.

Note

When making new window, be careful not to enter coordinates that will result in a window that will cover the status line and command line.

On a standard 80-column by 24-row terminal display, a row coordinate may be between 0 and 23. However, creating a window whose bottom row coordinate is greater than 18 will cause part or all of the status line to be covered.

Command Parameters

Definition of the Window New command parameters are as follows:

| Parameter | Definition | Range |
|---------------------|-------------------------|---------------------|
| < user_window_nmbr> | Window number | 50 to 256 inclusive |
| < user_screen_nmbr> | User_Screen | 4 to 256 inclusive |
| < top row> | Upper row coordinate | 0 to N-1 inclusive |
| < left col> | Left column coordinate | 0 to N-1 inclusive |
| < bottom row> | Lower row coordinate | 0 to N-1 inclusive |
| < right col> | Right column coordinate | 0 to N-1 inclusive |

N is the number of rows or columns on your display. The value of N is dependent on display type.

Note The Window New command will fail if row or column coordinates are greater than the screen boundary. For example, the command *Window New 15 Assembly 36,1,39,80* will fail if you have an 80 column by 40 row screen. The command *Window New 15 Assembly 36,0,39,79* will work.

Alternate Window Views

To create alternate views of a user-defined window, follow the procedure outlined below.

- 1 Execute the **Window New** command to define a window with specific size parameters.
- 2 Execute the **Window Toggle_View** command, or press function key **F4**.
- 3 Execute the **Window Resize** command to redefine the previously defined window with new size parameters. The new size parameters must be smaller than the previously assigned parameters.

See Also

- Expression Fprintf
- File User_Fopen
- Window Active
- Window Cursor
- Window Delete
- Window Erase
- Window Resize



Chapter 12:
Window New

Window Screen_On
Window Toggle_View

Examples

To make a new user window, number it 57, and display it in user screen 4 with upper-left corner at coordinates 5,5 and the lower right corner at coordinates 18,78:

```
Window New 57 User_Screen 4 Bounds 5,5,18,78
```

To make a new user window, number it 55, and display it in the high-level screen with upper-left corner at coordinates 5,5 and the lower right corner at coordinates 10,20:

```
Window New 55 High_Level 5,5,10,20
```

To move the high level status line window to the top of the display in the standard interface:

```
Window New 5 High_Level 0,0,3,78
```

For this command to execute, the high-level window must be displayed and the difference between the bottom row coordinate and top row coordinate (3 – 0) must equal three (3). You cannot move the status line if you are using the graphical interface.

Window Resize



The Window Resize command lets you change the size and position of the active window interactively. The cursor keys (left, right, up, and down arrows) move either the top left corner, or the bottom right corner of the window.

To reposition the top left corner, press **T** and position the top left corner of the window using the cursor control keys.

To reposition the lower right corner of the window, press **B** and use the cursor control keys to position the lower right corner.

To move the window without resizing it press **M** and use the cursor control keys to move the window on the screen.

Press the **Return** key to save the new coordinates.

Press **CTRL C** or **Esc Esc** to restore the previous coordinates.

If an alternate window view is selected, the size alterations are made to the alternate view.

Note

The Window Resize command can be used to alter the size of any existing window, including the predefined debugger windows, with the exception of the Status Line or View window. In the standard interface (but not in the graphical interface), the Status Line window can be moved or resized using the Window New command.

See Also

Expression Fprintf
File User_Fopen
other Window commands



Window Screen_On

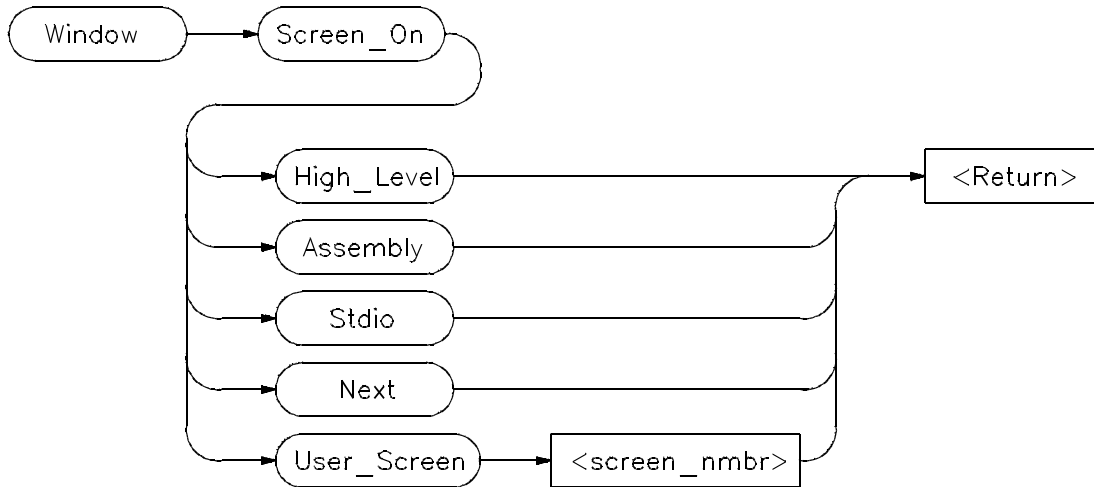

The `Window Screen_On` command displays the selected screen. You can also use function key `F6` to display a screen.

If the high level screen is displayed, the debugger is placed in the high level mode. Likewise, when you display the assembly level screen, the debugger is placed in the low level mode.

See Also

| | |
|---------------|--------------------|
| Window Active | Window New |
| Window Cursor | Window Resize |
| Window Delete | Window Toggle_View |
| Window Erase | |

Example

To activate the Assembly-level screen and place the debugger in low level mode:

```
Window Screen_On Assembly
```

Window Toggle_View

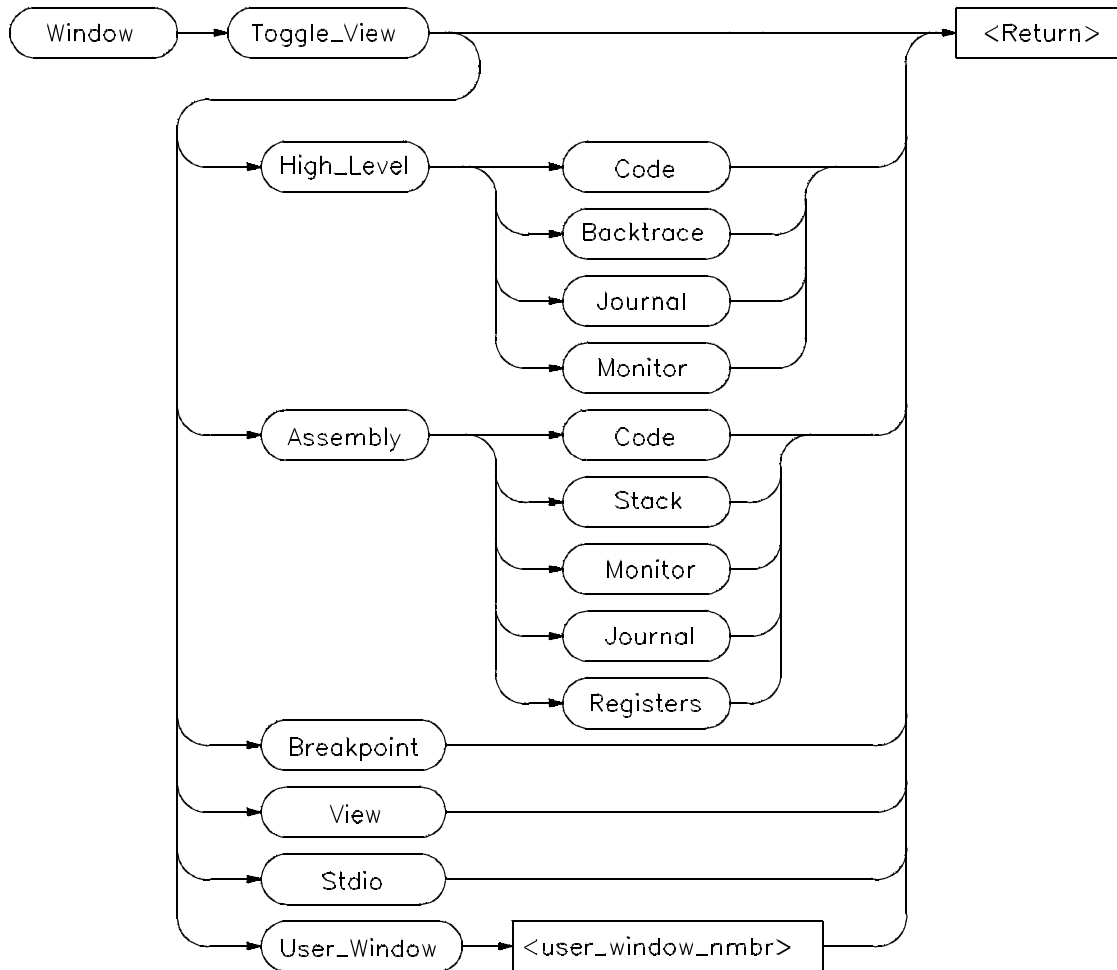

The Window Toggle_View command selects the alternate view of a window. Typically, this is an enlarged view of the window. If you do not specify a window number or if you specify 0, the active window is the default.

When you execute the Window Toggle_View command, the display alternates between the two views of the window.

Chapter 12:
Window Toggle_View

You can also use the *F4* function key to alternate views of the active window.

To create alternate views of a user-defined window, follow the procedure outlined in the Window New command description.

See Also

Window Active
Window Cursor
Window Delete
Window Erase
Window New
Window Resize
Window Screen_On

Examples

To display the alternate view of the active window:

```
Window Toggle_View
```

To display the alternate view of the high-level Code window:

```
Window Toggle_View High_Level Code
```

To display the alternate view of user window 57:

```
Window Toggle_View User_Window 57
```

13

Expressions and Symbols in Debugger Commands

A description of the expressions and symbols you can use in debugger commands.

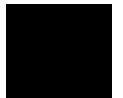

Expressions and Symbols in Debugger Commands

This chapter discusses the following language elements used in debugger commands:

- Expression elements.
- Formatting expressions.
- Symbolic referencing.

Debugger commands use standard C operators and syntax. This chapter describes the elements of C expressions and how expressions are structured. It also discusses memory and variable referencing.

Expression Elements

Most debugger commands require simple C expressions that evaluate to a scalar value. Simple C expressions are the same as standard algebraic expressions. These expressions evaluate to a single scalar value. Expressions consist of the following elements:

- operators
- constants
- program symbols
- debugger symbols
- built-in symbols
- macros
- keywords
- registers
- addresses
- address ranges
- line numbers

Debugger commands allow any legal C expression. The following paragraphs describe elements of C expressions used in debugger commands.

Operators

The debugger supports most standard C language operators and special debugger operators.

C Operators

C operators include arithmetic operators, relational operators, assignment operators, and structure, union, and array operators. The following table lists these operators in order of precedence (first line of the table is the highest precedence).

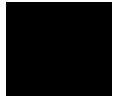

Supported C Operators

| Operators | Order of Association |
|-----------------------------------|----------------------|
| () [] -> . | Left to right |
| ~ ! ++ -- sizeof (type) - * & | Right to left |
| * / % | Left to right |
| + - | Left to right |
| << >> | Left to right |
| < <= > >= | Left to right |
| == != | Left to right |
| & | Left to right |
| ^ | Left to right |
| | Left to right |
| && | Left to right |
| | Left to right |
| = += -= *= /= %= &= ^= = <<= >>= | Right to left |
| ',' | Left to right |

C++ Operators

The debugger also supports C++ operators: ::, ., ->, and &.

Debugger Operators

The debugger uses some characters as special debugger operators. These debugger operators and their descriptions are listed in the following table:

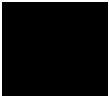

Debugger Operators

| Operator | Description |
|-----------------|---|
| [] | References the contents of a memory location. For example: <code>Expression Display_Value [0x20b0]</code> |
| # | Identifies a line number. For example: <code>Program Run Until #82</code> |
| @ | Identifies a stack level, reserved symbols, or symbol tree root. For example: <code>Program Display_Source @2</code> <i>(stack level)</i> <code>Expression Display_Value @module</code> <i>(reserved symbol)</i> <code>Symbol Display Default @ecs\\</code> <i>(symbol tree root)</i> |
| ' ' | Identifies a character constant. |
| " " | Identifies a character string constant. |
| \ | Qualifies a symbol reference. For example: <code>Program Run Until updateSys\#20</code> |
| \\ | Specifies an executable file as the root of a symbol tree. The specified file must be loaded into the debugger. For example: <code>Program Context Set @ecs\\main</code> |

Constants

A constant is a fixed quantity. Constants may be integers, floating point values, or character string constants.

Integer Constants.

An integer constant may be defined as a sequence of numeric characters optionally preceded by a plus or minus sign. If unsigned, the debugger assumes the value is positive.

Positive integer constants may range between 0 and $2^{31}-1$. When a constant is negative, its two's complement representation is generated. Negative integer constants may range to -2^{31} .

Constants can be specified as binary, decimal, or hexadecimal values. This is done by placing a prefix or suffix descriptor before or after the constant. The following table lists the legal prefixes or suffixes that may be specified with integer constants to denote a specific base.

| Integer Constant Prefixes and Suffixes | | | | |
|--|-------------------|-------------------|------|---------------|
| Constant Type | Prefix Descriptor | Suffix Descriptor | Base | Digit |
| Binary | | b, B | 2 | 0-1 |
| Decimal | | t, T | 10 | 0-9 |
| Hexadecimal | 0x,0X | h, H | 16 | 0-9, A-F, a-f |

Hexadecimal constants starting with the letters A through F (or a through f) must be prefixed with a zero. Otherwise, the debugger attempts to interpret the value as a symbol name.

By default, the debugger interprets integer constants as decimal values. To change the radix default to hexadecimal, you can use the Debugger Option General Radix Hexadecimal command.

If you change the radix default to hexadecimal, you must terminate any number you want interpreted as a decimal value with a *T* or *t*. (For example, specify decimal 32 as 32T).

Note

You cannot use binary numbers when the radix is hexadecimal.

The debugger truncates values larger than that which can be contained in an element of an expression or command. The debugger extends values less than that allowed in the element. The truncation and extension are both implemented according to the rules of C.

The examples given in the following table show the use of prefix and suffix descriptors.

| Prefix and Suffix Descriptor Examples | | |
|--|---------------------|-------------------------|
| Constant | Decimal Mode | Hexadecimal Mode |
| 73T | Decimal | Decimal |
| 0EFF1h | Hexadecimal | Hexadecimal |
| 10b | Binary | Hexadecimal |
| 0x2214 | Hexadecimal | Hexadecimal |
| 23C3 | Illegal | Hexadecimal |
| 123 | Decimal | Hexadecimal |

Floating Point Constants

The debugger represents floating point constants internally in standard IEEE binary format. All floating point calculations follow the rules of C. The debugger treats all floating point constants as double precision values internally.

Floating point constants specified on the debugger command line must have the following syntax:

[sign] integer_part.[fractional_part] [exponent]

where *sign* is an optional plus (+) or minus (–) sign.

integer_part consists of one or more decimal digits.

. is a decimal point.

fractional_part may be zero or more decimal digits.

exponent is an optional exponent, which is letter E (or e) followed by an integer part.

When specifying a floating point constant, the debugger uses a more restrictive syntax than the C language. The debugger always requires an integer part and a decimal point.

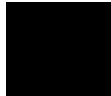

| | | | |
|-----------|---------|-------|--------|
| Examples: | 76.3e-1 | 76.3 | -0.3e1 |
| | 76.3E+0 | 76.e5 | 0.3 |
| | 76.3E2 | 76. | 0. |

Character Strings and Character Constants

Character Strings. A character string is a sequence of one or more ASCII characters enclosed in double quotation marks or two or more characters enclosed in single quotes. If the string has more than one character, subsequent ASCII characters are stored in consecutive bytes.

When a character string is referenced in a C expression, the debugger substitutes an address pointer to the string in the expression.

Character Constants. A character constant is a single character enclosed in single quotation marks.

When a character constant is referenced in a C expression, the debugger substitutes the actual ASCII character value in the expression, not the address of the character.

Non-printable characters. Some non-printable characters may be embedded in both character strings and character constants enclosed in double quotation marks (") by using the escape sequences listed in the table which follows. Escape sequences are indicated by a backslash (\).

The backslash is interpreted as a character in character strings enclosed in single quotation marks (').

Any characters other than those listed in the following table are interpreted literally if preceded by a backslash. For example, to have literal double quotation marks in a string, enclose the string in double quotation marks and use the escape sequence for double quotes shown above. For example:

```
"This is a \"string\" using embedded double quotation marks"
```

To have literal single quotation marks in a character string, enclose the string in double quotation marks. For example:

```
"This is a string that's using a single embedded quotation mark"
```

Non-Printable Character Escape Sequences

| Sequence | ASCII Name | Hex Value | Description |
|-------------------------|-------------------|------------------|---------------------|
| <code>\b</code> | BS | 08 | Back Space |
| <code>\f</code> | FF | 0C | Form Feed |
| <code>\n</code> | NL | 0A | New Line |
| <code>\r</code> | CR | 0D | Carriage Return |
| <code>\t</code> | HT | 09 | Horizontal Tab |
| <code>\"</code> | " | 22 | Double Quote |
| <code>\\</code> | \ | 5C | Backslash |
| <code>\xnumber</code> * | — | xnumber | Hex Character Value |

* `\xnumber` must be entered in the format `\xnn` where `nn` is a two digit hexadecimal value. For example: `\x0f`, not `\xf`

Note

The debugger automatically terminates character strings enclosed in quotation marks with a null character. However, when you use a character string with a Memory Assign or Memory Block_Operation (Fill, Search, or Test) command, the debugger uses only the characters within the quotation marks (null characters are not added).

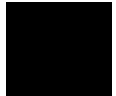

Symbols

A symbol (also called an identifier) is a name that identifies a location in memory. It consists of a sequence of characters that identify program and debugger variables, macros, keywords, registers, memory addresses, and line numbers.

Symbols may be up to 40 characters in length. The first character in a symbol must be alphabetic, an underscore (`_`), or an at sign (`@`). The characters allowed in a symbol include upper and lower case alphabetic characters, numeric characters, dollar signs (`$`), at signs (`@`), or underscores (`_`). No other characters may be used in symbols. The debugger differentiates between upper case and lower case characters in a symbol.

The following sections describe the different categories of symbols used by the debugger.

Program Symbols

Program symbols are identifiers associated with a source program. They consist of symbolic variable data names and function names that the programmer defined when writing the source program. All symbols that were defined in the source program can be passed to the debugger and referenced during a debugging session. Note that preprocessor names are not symbols.

The compiler includes all program symbol information in the resulting output object module file by default. When you load an executable file for debugging, the debugger places all program symbols into the debugger symbol table by default. The debugger preserves symbol types and treats the symbols according to their type.

The debugger may be instructed to load only global symbols at load time, loading local symbols as they are referenced. This behavior is known as *symbols on demand*. Refer to the description of the Debugger Option General Demand_Load command in the “Debugger Commands” chapter for more information on *symbols on demand*.

Normally, the compiler prefixes a leading underscore to all global program symbols. This is done to distinguish program symbols from reserved assembler names. If the debugger has loaded all symbols, two symbols will be available; the high-level symbol (for example, *main*), and its low-level

counterpart(*_main*). However, with symbols on demand, only the high-level symbol is available (*main*).

Debugger Symbols

Debugger symbols can be added during a debugging session using the Symbol Add command. The debugger treats debugger symbols as global symbols. When you create a debugger symbol, you must assign it a name. You may optionally assign it a type. An initial value may also be given to a debugger symbol. If you do not specify an initial value, the initial value defaults to zero.

Debugger symbols are stored in the debugger's memory and are not associated with the processor target memory.

Macro Symbols

You can use macros to:

- Create complex user commands.
- Patch your source code temporarily.
- Display information in user-defined windows.

A macro is similar to a C function. It has a name, return type, optional arguments, optional macro local symbols, and a sequence of statements.

There are two types of macro symbols:

- Macro names.
- Macro local symbols.

Macro Names

Macro names identify a macro. You assign macro names with the Debugger Macro Add command.

Macro Local Symbols

Macro local symbols are local variables and parameters defined within macros. They are declared when you create a debugger macro with the Debugger Macro Add command. A macro local symbol can be accessed only by the macro in which it is defined. It is created when the macro is executed. The macro local symbol has an undefined initial value.

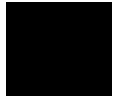

Reserved Symbols

Reserved symbols are reserved words that represent processor registers, status bits, and debugger control variables. These symbols are always recognized by the debugger. You can use reserved symbols any time during a debugging session. Reserved symbols have special meanings within the debugger command language. They cannot be defined and used for other purposes. To avoid conflict with other symbols, the names of all reserved symbols begin with a commercial at sign (@).

See the “Reserved Symbols” chapter for a complete list of reserved symbols and their descriptions.

Line Numbers

Line numbers can be used to refer to lines of code in your original source program. The compiler generates line numbers by default.

Line number references must be preceded by a pound sign (#). For example:

```
Program Run Until #82
```

When you refer to a source line number, the debugger translates it to the address of the first instruction generated by the compiler for that C statement. If a C source line did not generate executable code, a reference to that line number actually refers to the next line that did generate executable code.

To reference a line number that is in a module other than the current one, precede the line number with a module name. For example:

```
Breakpt Instr updateSys\#332
```

If supported by your compiler, you can debug multiple statements on one line. A dot qualifier (.) identifies the sequence of a statement on the source line. A colon qualifier (:) identifies a column number within the source line. Hewlett-Packard cross assemblers do not support multi-statement debugging.

Addresses

An address may be represented by any C expression that evaluates to a single value. The C expression can contain symbols, constants, line numbers, and operators.

Code Addresses

Code addresses refer to the executable portion of a program. In high level mode, expressions that evaluate to a code address cannot contain numeric constants or operators.

Data and Assembly Level Code Addresses

Data addresses refer to the data portion of a program. Data address and assembly level code address expressions may be represented by most legal C expressions. There are no restrictions on constants or operators.

Address Ranges

An address range is a range of memory bounded by two addresses. You specify an address range with a starting address, two periods (..), and an ending address. These addresses can be actual memory locations, line numbers, symbols, or expressions that evaluate to addresses in memory.

You can also specify a byte offset as the ending address parameter. If you specify a byte offset, the debugger adds the specified number of bytes to the starting address and uses the resulting address as the ending address. You must precede a byte offset with a plus sign (+).

You may specify module names before symbols and line numbers to override the default module.

The following examples show how to specify address ranges.

To set instruction breakpoints starting at line number 80 and ending at line number 90:

```
Breakpt Instr #80..#90
```

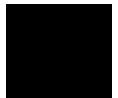

Chapter 13: Expressions and Symbols in Debugger Commands Addresses

To display code as bytes starting at line number 82 and ending at address 10d0 (hex):

```
Memory Display Byte #82..0x10d0
```

To display code as bytes, starting at memory location *tick_clock* and ending at 20 bytes past *tick_clock*:

```
Memory Display Byte tick_clock..+20
```

Keywords

Keywords are macro conditional statements that can be used in a macro definition. These keywords are very similar to the C language conditional statements. You cannot redefine keywords or use them in any other context. The debugger keywords are listed below.

- IF
- ELSE
- FOR
- WHILE
- DO
- BREAK
- CONTINUE
- RETURN

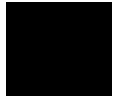

Forming Expressions

The debugger groups expressions into two classes:

- Assembly language expressions used in assembly level mode.
- Source language expressions used in either assembly level mode or high level mode.

When you use a source language expression to express a code address in high level mode, it can consist only of a single symbol or a single line number. Source language expressions cannot contain numeric constants or operators. This restriction reduces confusion when entering high level expressions. There are no restrictions on source language expressions that evaluate to data addresses or on assembly language expressions.

Examples of legal and illegal source language code expressions in high level mode are shown below.

Legal # 80
 main

Illegal # 80+ 3
 main+ 10

With several commands, the size of an expression can be specified by size qualifiers. The size qualifiers are explained in the “Debugger Commands” chapter.

You may use C++ classes in expressions.

Floating point calculations follow the rules of C. Single precision numbers are converted to double precision, the specified operation is done, and the result is translated back to single precision.

Note

Any value can be treated as an address. For example, a character value (byte) can be treated as an address. You should be careful when using values as addresses.

Examples of valid expressions are shown in the following table.

Valid Expressions

| Expression | Meaning |
|--------------------|---|
| # 7 | Line number reference (code address) |
| i | Symbol reference (value or address) |
| x+ (y*5) | Arithmetic operation (value or address) |
| default_targets[2] | Array reference (value or address) |
| assign_vectors | Function name reference (code address) |

Expression Strings

An expression string is a list of values separated by commas. The expression string can contain expressions and ASCII character strings enclosed in quotation marks. For several commands, each value in an expression string can be changed to the size specified by the size qualifiers. If you change the size, the debugger pads elements that do not fit evenly. Examples of expression strings are shown in the following table.

Expression String Examples

| String | Results |
|--------------------|--|
| 1,2,"abc" | Values 1 and 2, and ASCII values of abc. |
| 3+ 4, time, mac1() | Value 7, value of time, results of calling the macro 'mac1'. |
| '1xyz123' | ASCII values. |

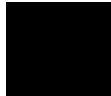

Symbolic Referencing

The debugger references symbols in a different manner than the standard C language definition. Therefore, understanding how variables are allocated and stored in memory is important. The following sections describe symbol storage classes and data types. These sections are followed by a discussion on:

- Referencing symbols with root, module, and function names.
- Making stack references.

In the following paragraphs, the notion of a 'module' is synonymous with a file in C. In fact, the module name is simply the basename of the source file with no suffix.

Storage Classes

All variables and functions in a C source program have a storage class that defines how the variable or function is created and accessed. The storage classes are:

- extern (global)
- static
- automatic
- register

C preprocessor symbols are not available to the debugger. The following paragraphs describe each storage class used in a C source program.

Extern (global)

Global variables in a C program are declared outside of a function and are accessible to all functions. Storage for these variables is allocated only once. Thereafter, references are made to the previously allocated space.

Global functions can be called from any other function.

Static

Static variables in a C program are allocated permanent storage and can be local to a module or local to a function.

In C, static variables local to a module can only be accessed by functions in that module. In the debugger, static variables local to a module can be accessed either when a function is active in that module or when the variable is qualified by the module name in which it is defined. A static variable that is local to a function can only be accessed by the function in which it was declared, unless it is qualified by the module and function in which it is defined.

Static functions can only be accessed when the function is in the current module, unless the function is qualified by the module in which it is defined.

Automatic

Automatic variables are declared inside a function and are accessible only to that function. Storage for these variables is allocated on the stack when the function is called and released when the function returns. Automatic variables do not have an initial value (their values are not retained between function calls).

You can access an automatic (local) variable when it is local to the current function, or when its function is on the stack. Use the stack-level prefix `@ <stack_level>` to access an automatic variable in a function on the stack.

Register

Register variables are also declared inside a function and are accessible only to that function. Storage for these variables is allocated in a specific hardware register when the function is called and released when the function returns. Register variables do not have an initial value (their values are not retained between function calls).

A register variable is accessible when it is local to the current function, or when its function is on the stack.

Note

Breakpoints cannot be set on accesses to register variables. If you need to set breakpoints on a variable, make sure that it is allocated on the stack by declaring its type as automatic.

Data Types

All symbols and expressions have an associated data type. Assembly language modules may contain variables with the types BYTE, WORD, or LONG. The

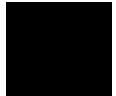

Chapter 13: Expressions and Symbols in Debugger Commands

Symbolic Referencing

debugger treats these types as unsigned char, unsigned short int, and unsigned long, respectively. A segment attribute indicates whether a variable was defined in a code segment or a data segment.

Source language modules may contain any valid C language data type. The data types for each type of module are listed in the following tables. The ranges of values are decimal representations.

Assembly Level Data Types

| Type | Size | Range |
|---------------------------|-------------------|-----------------|
| BYTE (unsigned char) | 8 bits, unsigned | 0 to 255 |
| WORD (unsigned short int) | 16 bits, unsigned | 0 to 65535 |
| LONG (unsigned long) | 32 bits, unsigned | 0 to 4294967295 |

High Level Scalar Data Types

| Type | Size | Range |
|--------------------|---------------------|--|
| char | 8 bits, signed | -128 to 127 |
| unsigned char | 8 bits, unsigned | 0 to 255 |
| short int | 16 bits, signed | -32768 to 32767 |
| unsigned short int | 16 bits, unsigned | 0 to 65535 |
| int | 32 bits, signed | -2147483648 to 2147483647 |
| unsigned int | 32 bits, unsigned | 0 to 4294967295 |
| long | 32 bits, signed | -2147483648 to 2147483647 |
| unsigned long | 32 bits, unsigned | 0 to 4294967295 |
| enum | 8-32 bits, unsigned | 0 to 4294967295 |
| pointer | 32 bits, unsigned | 0 to 4294967295 |
| float | 32 bits | 1.18×10^{-38} to $3.4 \times 10^{+38}$ |
| double | 64 bits | 9.46×10^{-308} to $1.79 \times 10^{+308}$ |

High Level Complex Data Types

| Type | Size |
|-------------|--|
| struct | Combined size of members (plus possible padding) |
| union | Size of largest member |
| array | Combined size of elements |

Type Conversion

The debugger does data type conversions under the following conditions:

- When two or more operands of different types appear in an expression, the debugger does data type conversion according to the rules of C.
- When arguments are passed to a macro function, the debugger converts the types of the macro's arguments to the types defined in the macro.
- When the data type of an operand is forced by type casting, the debugger converts the data type.
- When a specific type is required by a command, the value is converted by the debugger according to the rules of C.

Type Casting

Type casting forces the conversion of a debugger symbol or expression to a specified data type. The debugger converts the resulting value of the expression to the specified data type, as if the expression was assigned to a variable of that type. The debugger does not alter the contents of the variable.

You can cast debugger symbols and expressions into different types using the following syntax:

(typename) expression

For example, the following symbol is cast to type char:

(char) prime

The following example casts the variable expression ptr__char to type int:

(int) ptr__char

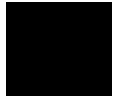

Chapter 13: Expressions and Symbols in Debugger Commands

Symbolic Referencing

Unlike C, the debugger allows casting to an array. The following example casts the address of the symbol `int_value` to an array of four chars:

```
(char[4]) &int_value
```

This type of casting to an array can be used with both the `Expression Display_Value` and `Expression Monitor_Value` commands.

Special Casting

In addition to the standard C type casts, the following assembly level casts are also recognized by the debugger's expression handler.

(Q S)

This type cast coerces an expression into a quoted string. For example, assuming the symbol `int_val` has a value of `0x61626364`,

```
Expression Display_Value (Q S) &int_val
```

causes `int_val` to be displayed as "abcd". Note that the expression evaluates to an address because the (Q S) type cast is semantically synonymous with the C type cast (`char *`).

(I A)

This type cast coerces an expression into an instruction address. For example, assuming the symbol `int_val` has a value of `0x400`,

```
Breakpt Instr (I A) int_val
```

sets an instruction breakpoint at address `0x400`.

(H D)

This type cast coerces an expression into a long word (4 bytes) and displays the value in hexadecimal format. For example, assuming the symbol `char_val` has a value of `0x3F`,

```
Expression Display_Value (H D) char_val
```

will cause `char_val` to be displayed as `0x0000003F`.

(H W)

This type cast coerces an expression into a word (2 bytes). For example, assuming the symbol `int_val` has the value `0x12345678`,

```
Expression Display_Value (H W) int_val
```

will cause `int_val` to be displayed as `0x5678`.

(H B)

This type cast coerces an expression into a byte. For example, assuming the symbol `int_val` has a value of `0x12345678`,

```
Expression Display_Value (H B) int_val
```

will cause `int_val` to be displayed as `0x78`.

Scoping Rules

References to symbols follow the standard scoping rules of C. For example, if the symbol 'x' is referenced, the debugger searches its symbol table for 'x' using the following priority:

- A variable local to the current macro (if any).
- A variable local to the current function (if any).
- A variable static to the current module (if any).
- A global variable or debugger symbol.

Referencing Symbols

Symbols are qualified (and therefore referenced) according to their context. Context in the debugger is defined by a symbol tree and, if applicable, by a module and function name.

Root Names

Within the debugger, the symbol table is represented as a hierarchical tree, with each level representing a scoping level. There are two types of symbol trees which exist within the debugger:

- non-program symbol tree
- program symbol tree

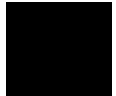

Chapter 13: Expressions and Symbols in Debugger Commands

Symbolic Referencing

Non-program symbol tree. This tree is composed of non-program symbols.

Only one non-program symbol tree exists. This tree is made up of:

- debugger symbols (@pc, @sp, etc.)
- macros
- user-defined debugger symbols

The root name of this tree is \.

Program symbol tree. The second type of symbol tree is the program symbol tree. The debugger allows up to 30 program trees. This tree is made up of symbols which exist in the target program. Since there may be multiple program trees within the debugger, the root of a program tree is specified as @*absfile*\, where *absfile* is the name of the executable file with its suffix stripped. For example, the root name of the program tree associated with the executable file a.out.x would be @a_out\.

Note

Any embedded '.' characters in a file name are converted to underscores. This prevents conflicts with the '.' structure operator. For example, the module name of source file myfile.bar.c would be myfile_bar.

There is no method for generating a list of multiple program trees.

If two or more executable files with the same name are loaded, the debugger appends an underscore and number to one of the files to make the root names unambiguous. For example, loading two a.out.x files would result in the creation of two program trees, with root names a_out and a_out_1.

Whenever the PC is pointing to the code space of a program, the root name of the program's symbol tree is the *current* root. A shorthand notation for specifying the current root is the symbol \. For example, if the debugger is invoked without loading an executable file, the current root would be \, which would be synonymous with \. However, once an executable file (a.out.x) is loaded with the PC set to an address within the executable's code space, the current root becomes @a_out\, which would be synonymous with \.

The reserved symbol "@root" points to a character string representing the name of the current root, and the symbol "@file" points to the name of the file containing the current PC. These may be empty strings ("") if the PC is outside of any defined symbol database.

Module Names

The C language does not contain the concept of a module. Within the context of the debugger, a module is a scoping level which is identical to the scoping level of a file in C. Module names (which are generated by the compiler), are derived from source file names by removing the suffix of the source file. For example, the module name associated with the source file `myfile.c` would be `myfile`. Module names are used to qualify symbol references within the program symbol tree. When used as such, they are separated from any following function name by a `\`.

Note

If files in two directories have the same name, they will have identical module names. Since the debugger cannot distinguish between the two modules, all references will resolve to the last loaded module.

Assembly level modules with multiple code sections. If assembly language modules have more than one code section, the debugger breaks the module down into sub-modules. For example, if the source file `myfile.s` had three code sections, the modules `myfile`, `myfile_2`, and `myfile_3` would appear in the program's symbol tree. This module separation only affects the address ranges of the module, not the scoping, i.e. all symbols scoped under the file `myfile.s` would be scoped under module `myfile`.

Context. Some symbol references are dependent on the current context. See the examples in the following tables. The current context is based on the PC and consists of the current root, current module, and current function. To display the current context, execute the command:

`Program Context Display Return`

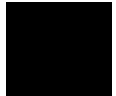

Symbolic Referencing With Explicit Roots

| Example | Comment |
|--|---|
| Symbol Display Default \\ | Display symbols scoped under the non-program root. |
| Symbol Display Default @a_out\\ | Display symbols scoped under the program root <i>a_out</i> . |
| Symbol Display Default \ | Display symbols scoped under the current root. |
| Symbol Display Default @a_out\\mod1 | Display symbol information for module <i>mod1</i> scoped under program root <i>a_out</i> . |
| Symbol Display Default \mod1 | Display symbol information for module <i>mod1</i> scoped under the current root. |
| Symbol Display Default @a_out\\mod1\ | Display symbols scoped under module <i>mod1</i> in program root <i>a_out</i> . |
| Symbol Display Default \mod1\ | Display symbols scoped under module <i>mod1</i> in the current root. |
| Breakpt Instr @a_out\\mod1\func1 | Set a breakpoint at the entry point to function <i>func1</i> in module <i>mod1</i> in program root <i>a_out</i> . |
| Breakpt Instr \mod1\func1 | Set a breakpoint at the entry point to function <i>func1</i> in module <i>mod1</i> in the current root. |
| Symbol Display Default @a_out\\mod1\func1\ | Display symbols scoped under function <i>func1</i> in module <i>mod1</i> in program root <i>a_out</i> . |
| Symbol Display Default \mod1\func1\ | Display symbols scoped under function <i>func1</i> in module <i>mod1</i> in the current root. |
| Breakpt Access @a_out\\mod1\func1\j | Set a breakpoint on accesses of variable <i>j</i> scoped under function <i>func1</i> in module <i>mod1</i> in program root <i>a_out</i> . |
| Breakpt Access \mod1\func1\j | Set a breakpoint on accesses of variable <i>j</i> scoped under function <i>func1</i> in module <i>mod1</i> in the current root. |

Symbolic Referencing With Explicit Roots

| Example | Comment |
|----------------|----------------|
|----------------|----------------|

Notes:

The variable *mod1* must be a module name.
The variable *func1* must be a function name.
The example pairs are equivalent if the current root is *a_out*.

Symbolic Referencing Without Explicit Roots

| Example | Comment |
|--|---|
| <code>Symbol Display Default x</code> | Display symbol information for all symbols named <i>x</i> at any scoping level in any root. |
| <code>Breakpt Access x</code> | Set a breakpoint at the <i>x</i> found using the scoping rules described in this chapter. |
| <code>Symbol Display Default x\</code> | Display symbol information for global symbol <i>x</i> in the current root and all symbols scoped under <i>x</i> . <i>x</i> may be a variable, function, or module name. |
| <code>Breakpt Instr x\#18</code> | Set a breakpoint at line 18 of module <i>x</i> . |
| <code>Symbol Display Default x\y</code> | Display symbol information for local variable <i>y</i> in function <i>x</i> (or function <i>y</i> in module <i>x</i>) in the current context. |
| <code>Symbol Display Default x\y\</code> | Display symbol information for local variable <i>y</i> in function <i>x</i> (or function <i>y</i> in module <i>x</i>) in the current context and for all symbols scoped under <i>x\y</i> . |
| <code>Breakpt Access x\y\j</code> | Set a breakpoint at local variable <i>j</i> in function <i>y</i> in module <i>x</i> in the current root. |

Evaluating Symbols

The debugger evaluates symbols in expressions using the rules of the C language as follows:



Chapter 13: Expressions and Symbols in Debugger Commands

Symbolic Referencing

- Function names and labels evaluate to addresses.
- Variables generally evaluate to the contents of the memory location at the address of the variable (the exception is unsubscripted array names which evaluate to addresses.)

The examples in the following table show the differences in evaluation of these symbol types.

| Symbol Evaluation Examples | |
|----------------------------|---|
| Example | Comment |
| Breakpt Instr foo | The symbol <i>foo</i> is a function name. The breakpoint is set at the address of <i>foo</i> . |
| Breakpt Access &i | <i>i</i> is a variable. Therefore, the debugger evaluates the symbol as the value of <i>i</i> rather than the address of <i>i</i> . The & operator causes the breakpoint to be set on the address of <i>i</i> . |
| Breakpt Access a | <i>a</i> is an array. The breakpoint is set at the address of the first element of the array. |
| Breakpt Access a[3] | A breakpoint is set at the address specified in <i>a[3]</i> , not the address of <i>a[3]</i> . |
| Breakpt Access &a[3] | A breakpoint is set at the address of <i>a[3]</i> . |

Stack References

When a function is invoked in C, space is allocated on the stack for local variables. If one function calls another function, all information is saved on the stack to continue execution when the called function returns. The caller function is now nested.

You can reference variables and functions on the stack implicitly or explicitly.

Implicit Stack References

The default compiler setting allocates storage for all local variables in a C program in registers, if possible. Variables that cannot be stored in registers are allocated storage on the stack. With the debugger, you can implicitly reference variables on the stack as follows:

- To refer to variables on the stack in the current function, specify the name of the variable. For example: *x*.
- To refer to a local variable in a nested function, specify the function name followed by a backslash and then the name of the local variable, for example, *main\i*.

Explicit Stack References

A function is allocated storage on the stack when it is executing, or when it has called another function. To refer to functions and variables on the stack explicitly, you must specify the function's nesting level preceded by a commercial at sign (@). The backtrace window in high-level mode displays nesting level information (for example, if the current function is @0, its calling function is @1, etc.). You may reference functions on the stack as follows:

- To refer to the address that the function will continue to execute from, specify the function nesting level preceded by an at sign (@). For example, the command *Program Run Until @1* executes the program until the current function returns to its caller.
- To refer explicitly to a local variable in a nested function, specify the function nesting level followed by a backslash and then the name of the variable. For example, the command *Expression Display_Value @3\str* references the local variable 'str' of the function at nesting level 3.
- To reference a function itself, enter the command *Program Context Expand* followed by a space and then the function nesting level. For example, the command *Program Context Expand @7* displays all information about the function at the specified level for that particular invocation. This information includes the name of the function, the current line number, and all local variables in the function and their values. See the *Program Context Expand* command syntax description in the "Debugger Commands" chapter for more information.

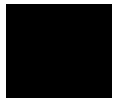

Chapter 13: Expressions and Symbols in Debugger Commands
Symbolic Referencing

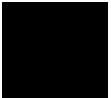

14

Reserved Symbols

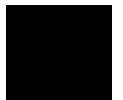

Chapter 14: Reserved Symbols

The symbols listed in this chapter are predefined, reserved symbols for the 68020/030 debugger/emulator. Symbols identified with an asterisk (*) are used only with the 68030 processor. Reserved symbols cannot be deleted by the user.

Note that reserved symbols may be entered in either upper or lower case characters.

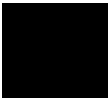

| Reserved Symbols | | |
|------------------|--|---------------|
| Symbol | Meaning | Maximum Value |
| @A0-A7 | Address Registers | 0xFFFFFFFF |
| @AC0 | Access Control Register 0 (68EC030 only) | 0xFFFFFFFF |
| @AC1 | Access Control Register 1 (68EC030 only) | 0xFFFFFFFF |
| @ACUSR | Access Control Unit Status Register (68EC030 only) | 0xFFFF |
| @C | Carry Flag | 1 |
| @CAAR | Cache Address Register | 0xFFFFFFFF |
| @CACR | Cache Control Register | 0xF |
| @CCR | Condition Codes Register | 0x1F |
| @CRP_H* | CPU Root Pointer (upper 32-bits) (68030 only) | 0xFFFFFFFF |
| @CRP_L* | CPU Root Pointer (lower 32-bits) (68030 only) | 0xFFFFFFFF |
| @D0-D7 | Data Registers | 0xFFFFFFFF |
| @DFC | Destination Function Code | 7 |
| @ENTRY | Address of first executable statement in function | |
| @FILE | Name of file containing current PC, | |
| @FUNCTION | Pointer to current function name | |
| @HLPC | High-Level Program Counter(line number) | 32767 |
| @I | Interrupt Mask | 7 |
| @ISP | Interrupt Stack Pointer | 0xFFFFFFFF |
| @M | Master/Interrupt Flag | 1 |
| @MMUSR* | MMU Status Register (68030 only) | 0xEE47 |
| @MODULE | Pointer to current module name | |
| @MSP | Master Stack Pointer | 0xFFFFFFFF |
| @N | Negative Flag | 1 |
| @PC | Program Counter | 0xFFFFFFFF |
| @ROOT | Name of root of symbol tree represented by PC | |
| @S | Supervisor State Flag | 1 |
| @SFC | Source Function Code | 0xFFFFFFFF |
| @SP | Stack Pointer | 0xFFFFFFFF |
| @SR | Status Register | 0xFFFF |
| @SRP_H* | Supervisor Root Pointer (upper 32-bits) (68030 only) | |
| @SRP_L* | Supervisor Root Pointer (lower 32-bits) (68030 only) | |
| @SSP | Supervisor Stack Pointer | 0xFFFFFFFF |
| @T0 | Trace 0 Flag | 1 |
| @T1 | Trace 1 Flag | 1 |
| @TC* | Translation Control Register | |
| @TT0* | Transparent Translation Register 0 (68030 only) | |
| @TT1* | Transparent Translation Register 1 (68030 only) | |
| @USP | User Stack Pointer | 0xFFFFFFFF |
| @V | Overflow Flag | 1 |

Chapter 14: Reserved Symbols

| Reserved Symbols | | |
|-------------------------|---------------------|----------------------|
| Symbol | Meaning | Maximum Value |
| @VBR | Vector Base Address | 0xFFFFFFFF |
| @X | Extend Flag | 1 |
| @Z | Zero Flag | 1 |

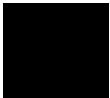



Predefined Macros



Predefined Macros

Predefined macros are provided with the debugger. These predefined macros provide commonly used functions to help in debugging your program. The predefined macros available for your use are listed in the “Predefined Debugger Macros” table and are described on the following pages.

The following predefined debugger macros provide services to the SIMIO system and internal debugger functions. They are not designed for use by the debugger user. These names will be displayed if you check the debugger’s predefined macro list using the Symbol Display command:

- bbaunload
- emul_special
- hpsimio
- hp_redirect
- hpnosimio
- hpioctl
- hpeofkbd
- hpioreport
- hpsimlock
- load_config
- quit_debugger
- shell_escape

| Predefined Debugger Macros | |
|-----------------------------------|--|
| Macro | Description |
| break_info | Display information about a breakpoint |
| byte | Return a byte value at the specified address |
| call | Call target function (not implemented in this product) |
| close | Close a UNIX file |
| cmd_forward | Send a command to another attached emulator interface |
| dword | Return a long value at the specified address |
| error | Display error message |
| fgetc | Reads character from file |
| fopen | Open a file and associate it with a user window |
| key_get | Get (read) a key from the keyboard |
| key_stat | Check keyboard for availability of key |
| memchr | Search for character in memory |
| memset | Clear memory bytes |
| memcpy | Copy characters from memory |
| memset | Set the value of characters in memory |
| open | Open a UNIX file for reading and/or writing |
| pod_command | Pass a command to the emulator terminal interface |
| read | Read from a system file |
| reg_str | Get the register value using the register name in the string |
| showversion | Show the software version number for the debugger product |
| strcat | Concatenate two strings |
| strchr | Locate first occurrence of a character in a string |
| strcmp | Compare two strings |
| strcpy | Copy a string |
| stricmp | Comparison of two strings without case distinction |
| strlen | String length |
| strncmp | Limited comparison of two strings |
| until | Run until expression is true |
| when | Break when expression is true |
| word | Return a word value at the specified address |
| write | Write to a system file |

break_info

Function

Return information about a breakpoint

Synopsis

```
int break_info (addr)
unsigned long *addr;
```

Description

The `break_info` macro returns the address and type of a breakpoint if it is called when a breakpoint is encountered. The macro returns the 32-bit representation of the breakpoint address used by the debugger and the following values for breakpoint type:

- | | |
|----|--|
| -1 | The cause of the breakpoint is unknown. |
| 0 | A breakpoint did not cause this macro call. |
| 1 | The breakpoint was caused by a read from the address. |
| 2 | The breakpoint was caused by a write to the address. |
| 3 | The breakpoint was caused by an access (read/write status unknown) of the address. |
| 4 | The breakpoint was caused by an instruction breakpoint. |

Diagnostics

None.

Example

If you have the following code segment:

```
main()
{
    auto i,j,k;
    i = 1;
    j = 3;
    k = i + j;
}
```

and you execute the following command file:

```
Debugger Macro Add int print_info()
{
    unsigned long address;
    int reason;

    reason = break_info(&address);
    $Expression Printf "Breakpoint at %8x. Reason: %d\n",
    address,reason;
    return(1);
}
.

Program Run Until main
Program Step
Breakpt Read &i;print_info()
Breakpt Write &k;print_info()
Breakpt Access &j;print_info()
Program Run
```

the debugger will display the breakpoint address and type value in the journal window.

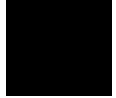



byte

Function

Return a byte value at the specified address

Synopsis

```
unsigned char byte (addr)  
void *addr;
```

Description

The `byte` macro returns a byte value of the memory contents at the specified address. The value of the expression `addr` is computed and used as the address.

Diagnostics

The byte value of the memory contents at the specified address is returned.

close

Function

Close a UNIX file

Synopsis

```
int close(fildes)
int    fildes;
```

Description

The close macro closes a UNIX file. This macro is an interface to the UNIX system call *close(2)*. Refer to the *HP-UX Reference Manual* for detailed information.

Diagnostics

If the system call to close(2) is successful, 0 is returned. Otherwise, -1 is returned and a system generated error message is written to the journal window of the debugger.

Example

The following command file segment defines two global debugger symbols and includes the definition of a user-defined macro that uses close().

```
Symbol Add int infile
Symbol Add int outfile

Debugger Macro Add int close_files(infile, outfile)
int    infile;    /* file descriptor to close */
int    outfile;   /* file descriptor to close */
{
    /* close input file */
    infile = close(infile);
    if (infile == -1)
        return 0;    /* close failed */

    /* close output file */
    outfile = close(outfile);
    if (outfile == -1)
        return 0;    /* close failed */

    return 1;    /* both files were closed successfully */
}
```

cmd_forward

Function

Send a comand to another attached emulator interface.

Synopsis

```
int cmd_forward (ui_id, command)
char *ui_id;
char *command;
```

Description

This macro sends the string *command* to the interface *ui_id*. Interface *ui_id* will then interpret *command* as input to its command line.

This macro provides a way for the target program to send commands to an emulator interface, as well as allowing control of all interfaces from a common point.

The interfaces that are currently supported are:

| | |
|-------|---|
| Emul | Emulator/analyzer interface. If several emulator interfaces are sharing the emulator, the command will be forwarded to the most recently started interface. |
| Perf | Software Performance Analyzer. |
| BMS | Broadcast Message Server (the Softbench Gateway). |
| Debug | Debugger. This sends a command back to the debugger you are using. |

If an interface of the type specified is currently running, the command will be executed there and any errors will be displayed there.

Diagnostics

A zero is returned if *ui_id* is not attached to the emulator. A one is returned if *ui_id* is attached.

Examples

To start execution of an emulator interface command file at the beginning of sub-program *main5*, enter:

```
Breakpoint Instr main5; cmd_forward ("emul",  
"my_command_file")
```

To provide a target function to send a command to a user interface, compile the following function into your target program:

```
void send_command (ui, cmd)  
    char *ui, *cmd;  
{  
    return;  
}
```

Then set a breakpoint with a macro call:

```
Breakpoint Instr send_command\@ENTRY; cmd_forward  
(ui,cmd)
```

When execution reaches the first statement in *send_command()* the command *cmd* will be sent to user interface *ui*. Execution will halt if *ui* was not attached, and will continue otherwise.



dword

Function

Return a long value at the specified address

Synopsis

```
unsigned long dword (addr)  
void *addr;
```

Description

The `dword` macro returns a LONG (4-byte) value of the memory contents at the specified address. The value of the expression *addr* is computed and used as the address.

Diagnostics

The LONG value of the memory at that address is returned.

error

Function

Display error message

Synopsis

```
void error(level, text, parm)
int level;
char *text;
long parm;
```

Description

The `error()` macro is used to display error messages due to errors generated within macros. *level* must have a value of 1, 2, or 3. *text* is a string which can contain one `%d` format character, where *parm* is the associated integer value.

level can be used to indicate the severity of the error by its value. The following explains the values available for *level*, and the associated action taken by `error()`.

- 1 *text* is displayed in the journal window.
- 2 *text* is displayed in the journal window and the macro halts program execution.
- 3 An error box pops up, *text* is displayed within the box, and the macro halts program execution.



fgetc

Function

Reads character from file

Synopsis

```
int fgetc(vp_num)
int vp_num;
```

Description

The macro `fgetc()` returns the next character in the file associated with the window number `vp_num`. The window number must be a result of the `File User_Fopen` command. The value `-1` is returned on end of file.

fopen

Function

Open a file and associate it with a user window

Synopsis

```
int fopen(vp_num, filename, mode)
int  vp_num;
char *filename;
char *mode;
```

Description

The macro `fopen()` opens a file and associates it with a user-defined window. This macro is equivalent to the File User_Fopen debugger command. *filename* is the name of the file to be opened. *mode* is a string that specifies the mode in which the file is opened. Valid modes are:

| | |
|-----|--|
| "r" | Open file for reading only |
| "w" | Open file for reading and/or writing (existing file contents are erased) |
| "a" | Open file for appending |

Diagnostics

If successful, a window number is returned. The error code `-27` indicates that the window is already open or that the window number is out of range. The error code `-101` is returned for other errors; for example, if the file to be read does not exist.



key_get

Function

Get a key from the keyboard

Synopsis

```
unsigned short key_get()
```

Description

The macro `key_get()` reads a key from the keyboard. It returns only after a key is available. The return value is the value of the key.

key_stat

Function

Check keyboard for availability of key

Synopsis

```
unsigned short key_stat()
```

Description

The `key_stat()` macro checks the keyboard to see if a key is available to read. It returns 0 if no key is available. The first pending key is returned if any keys are available.

Diagnostics

The value -1 is returned if the macro fails.

memchr

Function

Search for character in memory

Synopsis

```
char *memchr (str1, byte_value, count)
char   *str1;
char   byte_value;
unsigned count;
```

Description

The `memchr` macro locates the character *byte_value* in the first *count* bytes of memory area *str1*.

Diagnostics

The `memchr` macro returns a pointer to the first occurrence of character *byte_value* in the first *count* characters in memory area *str1*. If *byte_value* does not occur, `memchr` returns a NULL pointer. For debugger variables, -1 (0xFFFFFFFF) is returned if *byte_value* does not occur.

memclr

Function

Clear memory bytes

Synopsis

```
char *memclr (dest, count)
char  *dest;
unsigned count;
```

Description

The `memclr` macro sets the first *count* bytes in memory area *dest* to zero.

Diagnostics

The `memclr` macro returns *dest*.

memcpy

Function

Copy characters from memory

Synopsis

```
char *memcpy (dest, src, count)
char  *dest,
char  *src
unsigned count;
```

Description

The memcpy macro copies *count* characters from memory area *src* to *dest*.

Diagnostics

The memcpy macro returns *dest*.

memset

Function

Set the value of characters in memory

Synopsis

```
char *memset (dest, byte_value, count)
char  *dest;
char  byte_value;
unsigned count;
```

Description

The `memset` macro sets the first *count* characters in memory area *dest* to the value of character *byte_value*.

Diagnostics

The `memset` macro returns *dest*.

open

Function

Open a UNIX file for reading and/or writing

Synopsis

```
int open(path, oflag)
char *path;
int oflag;
```

Description

The *open()* macro opens a UNIX file, returning an UNIX file descriptor. *path* is the name of the file to be opened. *oflag* is the mode in which the file will be opened. The possible modes may be found in the header file */usr/include/fcntl.h*. Some useful modes are:

| | |
|------------|-----------------------------|
| read only | 0 |
| write only | 1 |
| read/write | 2 |
| no delay | 4 |
| append | 8 |
| create | 256 (HP-UX) or 512 (SunOS) |
| truncate | 512 (HP-UX) or 1024 (SunOS) |

These modes may be combined by adding the appropriate values together.

This macro is an interface to the UNIX system call *open(2)*. Refer to the *HP-UX Reference Manual* for detailed information.

Diagnostics

If the system call to *open(2)* is successful, the system file descriptor is returned. Otherwise, *-1* is returned and a system generated error message is written to the journal window of the debugger.

Example

The following command file segment defines two global debugger symbols and includes the definition of a user-defined macro that uses open().

```
Symbol Add int infile
Symbol Add int outfile

Debugger Macro Add int open_files(infile, outfile)
char    *infile;    /* file to read from */
char    *outfile;   /* file to write to */
{
    /* open input file in read only mode */
    infile = open(infile, 0);
    if (infile == -1)
        return 0;    /* open failed */

    /* create output file in read/write mode */
    outfile = open(outfile, 258);
    if (outfile == -1)
        return 0;    /* open failed */

    return 1;    /* both files were opened successfully */
}
```



pod_command

Function

Send terminal interface commands to the emulator

Synopsis

```
int pod_command(command, response)
char *command, *response;
```

Description

The `pod_command` macro sends the string in *command* to the emulator, and puts any response text in *response*. If multiple lines of text are returned, the lines are separated in *response* with a new line (**\n**) character. If *response* is a null pointer (**0**), any response is ignored.

Caution

This macro is primarily for diagnostic purposes. Use of this macro to send terminal interface commands that change the state of the emulator or analyzer may produce unexpected and **UNSUPPORTED** behavior.

Diagnostics

If the command produces no error, this macro returns a one (1). Otherwise, the macro returns a zero (0) and the debugger displays the error or errors in the debugger error window.

Make sure that the *response* string is large enough to hold any data returned from the emulator. Responses put into debugger variables will be truncated to the maximum length of the debugger string. The debugger will not give an error indication.

Examples

To get the first 99 characters of emulator version information:

```
Symbol Add char resp[100]
Debugger Macro Call pod_command("ver",resp)
Expression Printf "%s",resp
```

To send the emulator "help" command and ignore output:

```
Debugger Macro Call pod_command("help",0)
```

To send an invalid command to the emulator:

```
Debugger Macro Call pod_command("silly",0)
```

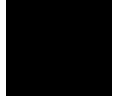

read

Function

Read from a system file

Synopsis

```
int read(fildes, buf, nbyte)
int    fildes;
char   *buf;
unsigned nbyte;
```

Description

The read macro reads from a system file. This macro is an interface to the UNIX system call *read(2)*. Refer to the *HP-UX Reference Manual* for detailed information.

Diagnostics

If the system call to read(2) is successful, the number of bytes read is returned. Otherwise, *-1* is returned and a system generated error message is written to the journal window of the debugger.

Example

The following command file segment defines two global debugger symbols and includes the definition of a user-defined macro that uses read().

```
Symbol Add int infile
Symbol Add int outfile
Debugger Macro Add int foo(infile, outfile)
int    infile;    /* file descriptor to read from */
int    outfile;   /* file descriptor to write to */
{
    char buf[80];

    while (!read(infile, buf, 80))
        write(outfile, buf, 80);
}
```

reg_str

Function

Get register value

Synopsis

```
unsigned long reg_str(str1)
char *str1;
```

Description

The `reg_str` macro gets the contents of a register using a string variable representation of its name. This is not possible using standard debugger commands. The register value is returned by the macro.

Diagnostics

If the string does not contain a valid register name, an unknown value will be returned and the debugger will display an error message in the debugger error window.

Examples

To display the value of register D0:

```
Symbol Add char reg_name[10]
Debugger Macro Call strcpy(reg_name, "@D0")
Expression Display_Value reg_str(reg_name)
```

To display the value of register D1:

```
Expression Display_Value reg_str("@D1")
```

To display the value of register D1:

```
Expression C_Expression reg_str("@D1")
```



showversion

Function

Show the software version number for the debugger product

Synopsis

```
void showversion ()
```

Description

The showversion macro lists the software version number for your debugger product.

strcat

Function

Concatenate two strings

Synopsis

```
char *strcat (dest, src)
char *dest, *src;
```

Description

The `strcat` macro appends a string to the end of another string. The string in `src` is appended to the string in `dest` and a pointer to `dest` is returned.

Diagnostics

No checking is done on the size of `dest`.

strchr

Function

Locate first occurrence of a character in a string

Synopsis

```
char *strchr (str1, byte_value)
char *str1;
char byte_value;
```

Description

The `strchr` macro returns a pointer to the first occurrence of the character *byte_value* in the string *str1*, if *byte_value* occurs in *str1*.

Diagnostics

If the character *byte_value* is not found, `strchr` returns a NULL pointer. For debugger variables, -1 (0xFFFFFFFF) is returned if *byte_value* does not occur.

strcmp

Function

Compare two strings

Synopsis

```
unsigned long strcmp (str1, str2)
char *str1,
char *str2;
```

Description

The `strcmp` macro compares strings in lexicographic order. Lexicographic order means that characters are compared based on their internal machine representation. For example, because an ASCII 'A' is 41 hexadecimal and an ASCII 'B' is 42 hexadecimal, 'A' is less than 'B'.

The strings *str1* and *str2* are compared and a result is returned according to the following relations:

| relation | result |
|-------------------------|------------------|
| <code>s1 < s2</code> | negative integer |
| <code>s1 = s2</code> | zero |
| <code>s1 > s2</code> | positive integer |

Diagnostics

Strings are assumed to be NULL terminated or to be within the array boundaries. The comparison is always signed, regardless of how the string is declared.

strcpy

Function

Copy a string

Synopsis

```
char *strcpy (dest, src)
char *dest,
char *src;
```

Description

The `strcpy` macro copies *src* to *dest* until the NULL character is moved. (Copying from the right parameter to the left resembles an assignment statement.) A pointer to *dest* is returned.

Diagnostics

No checking is done on the size of *dest*.

stricmp

Function

Comparison of two strings without case distinction

Synopsis

```
unsigned long stricmp (str1, str2,)  
char *str1;  
char *str2;
```

Description

The `stricmp` macro compares *str1* with *str2* without case distinction. This means that the strings "ABC" and "abc" are considered to be identical.

The strings *str1* and *str2* are compared and a result is returned according to the following relations:

| relation | result |
|-------------------------|------------------|
| <code>s1 < s2</code> | negative integer |
| <code>s1 = s2</code> | zero |
| <code>s1 > s2</code> | positive integer |

Diagnostics

Strings are assumed to be NULL terminated or to be within the array boundaries because the comparison is limited to the number of stated characters. The comparison is always signed, regardless of how the string is declared.

strlen

Function

String length

Synopsis

```
unsigned long strlen (str1)  
char *str1;
```

Description

The `strlen` macro returns the length of a string. It returns the length of *str1*, excluding the NULL character.

Diagnostics

If *str1* is not properly terminated by a NULL character, the length returned is invalid.

strncmp

Function

Limited comparison of two strings

Synopsis

```
unsigned long strncmp (str1, str2, count)
char *str1;
char *str2;
unsigned count;
```

Description

The `strncmp` macro compares strings in lexicographic order. Lexicographic order means that characters are compared based on their internal machine representation. For example, because an ASCII 'A' is 41 hexadecimal and an ASCII 'B' is 42 hexadecimal, 'A' is less than 'B'.

The *count* in the synopsis above specifies the maximum number of characters to be compared.

The strings *str1* and *str2* are compared and a result returned according to the following relations:

| relation | result |
|-----------------|------------------|
| $s1 < s2$ | negative integer |
| $s1 = s2$ | zero |
| $s1 > s2$ | positive integer |

Diagnostics

Strings are not required to be NULL terminated or to fit within the array boundaries because the comparison is limited to the number of stated characters. Less than *count* characters will be compared if the strings are smaller than *count* characters. The comparison is always signed, regardless of how the string is declared.

until

Function

Run until expression is true

Synopsis

```
char until (boolean)  
int boolean;
```

Description

The `until` macro returns a zero when *boolean* is nonzero. The `Until` macro is used with the `Program Run` and `Program Step With_Macro` commands. It halts execution when the expression passed is true, and continues when the expression passed is false. Any C expression resulting in a value may be used.

Example

```
Program Run Until #3 ,#17 ,printf ;until (i==3 || x < y)
```

The command above sets temporary breakpoints at line numbers 3 and 17 in the current module and at entry to the function `printf`. When any one of these locations is encountered by the executing program, the debugger will stop and check the *until* conditional statements. If the variable *i* is equal to 3, or the variable *x* is less than *y*, a break will occur. Otherwise, program execution continues.

when

Function

Break when expression is true

Synopsis

```
char when (boolean)  
int boolean;
```

Description

The `when` macro returns a zero when *boolean* is nonzero; it returns a one when *boolean* is zero. This macro is used with the `Breakpt Instr` command. When used with this command, program execution will halt when the stated expression is true, and will continue when the stated expression is false. Any C expression resulting in a value may be used.

Example

```
Breakpt Instr strcpy;when(*str==0)
```

This command sets a breakpoint at the entry point of the routine `strcpy`. Each time the breakpoint occurs, the `when` macro is executed. The macro causes program execution to stop when the byte pointed to by *str* is zero.



word

Function

Return a word value at the specified address

Synopsis

```
unsigned short int word (addr)  
void *addr;
```

Description

The `word` macro returns a `WORD` (2-byte) value of the memory at the specified address. The value of the expression `addr` is computed and used as the address.

Diagnostics

The `WORD` value of the memory at that address is returned.

write

Function

Write to a system file

Synopsis

```
int write(fildes, buf, nbyte)
int  fildes;
char  *buf;
unsigned nbyte;
```

Description

The write macro writes to a system file. This macro is an interface to the UNIX system call *write(2)*. Refer to the *HP-UX Reference Manual* for detailed information.

Diagnostics

If the system call to write(2) is successful, the number of bytes written is returned. Otherwise, *-1* is returned and a system generated error message is written to the journal window of the debugger.

Example

The following command file segment defines two global debugger symbols and includes the definition of a user-defined macro that uses write().

```
Symbol Add int infile
Symbol Add int outfile
Debugger Macro Add int foo(infile, outfile)
int  infile; /* file descriptor to read from */
int  outfile; /* file descriptor to write to */
{
    char buf[80];

    while (!read(infile, buf, 80))
        write(outfile, buf, 80);
}
```





Debugger Error Messages

A list of the error messages generated by the debugger.

Chapter 16: Debugger Error Messages

The debugger displays the error window whenever it detects a command error. The debugger displays an error message and a pointer to the location where it detected the error.

This chapter lists and describes the error messages and warnings issued by the debugger. These errors are listed numerically with possible error solutions.

- 4 **Invalid characters follow command.**
A command was entered with incorrect characters or with more characters than were expected. Check the command name and re-enter the command.
- 5 **This command is not implemented yet.**
The command specified is currently not supported, but will be implemented in a later release.
- 6 **Unknown switch.**
An attempt was made to specify a switch that does not exist. Check the command syntax for the switches supported.
- 7 **Argument missing, expected.**
A command was entered without an argument that is required to execute the command. Check the syntax description for the command and enter the command again with the correct argument specification.
- 8 **Invalid argument, expected.**
The argument specified is not valid for this command. Check command syntax and re-enter the command with a valid argument.
- 9 **Unexpected separator encountered.**
The argument separator is not valid in this context. Check the syntax and enter the correct separator.
- 10 **Unknown expression character.**
The specified expression character is not recognized by the debugger. Check the syntax and enter the correct expression character.
- 11 **Missing ')', ']', or '}' in expression.**
The matching right parentheses, right bracket, or right curly brace in the specified expression is missing. Check the expression and add the appropriate right delimiter.

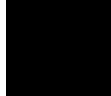

12 **Missing '(', '[', or '{' in expression.**

The matching left parentheses, left bracket, or left curly brace in the specified expression is missing. Check the expression and add the appropriate left delimiter.

13 **Missing end quote.**

The second quotation mark for a character string is missing at the end of the line. Terminate the character string with an ending quotation mark.

14 **Invalid expression element.**

An expression element was specified incorrectly. The error window will display the expression specified and place a pointer at the position where the invalid element is located. Check the syntax description and re-enter the command. Possible errors include: invalid value, missing operand, missing operator, and unknown operand combination.

15 **Invalid filename.**

The filename specified could not be created. Valid filenames are dependent upon your host computer system.

16 **Invalid line number.**

The line number specified is not valid. Line numbers must be preceded with a pound sign (#), and must be in a valid range. This error will occur if you enter a pound sign followed by zero or if you enter a pound sign without a number.

17 **Invalid address value.**

This error indicates that a value was used for an address that cannot be interpreted as an address (for instance, a floating point number).

18 **Invalid structure member.**

A member name was given that is not a member of the specified structure. Member names must be members of the specified structure.

- 19 **Invalid instruction address.**
- This error occurs mainly in high-level mode. In high-level mode, this error will occur if the instruction address is not a function name or line number. Code addresses in high-level mode may not be numeric or expressions. In assembly-level mode, most instruction address values are legal.
- 20 **Invalid port value.**
- The specified port does not exist, or the port value was not specified with the Memory Inport Assign command. Port values must be specified with the Memory Inport Assign command.
- 21 **The values are not correct for this expression.**
- An attempt was made to use an operand type that is not allowed for this operator. Operators must match operands according to the C language specifications.
- 22 **Upper bound less than lower bound.**
- An attempt was made to specify a lower bound that is greater than the upper bound. The upper bound must be greater than the lower bound.
- 23 **Upper bound missing.**
- An attempt was made to specify a lower bound without an upper bound. The upper bound must be specified.
- 24 **Function symbol ranges not allowed.**
- An attempt was made to specify a range from one function to another in high-level mode. Function to line number is allowed.
- 25 **Range not of addresses.**
- A print or trace command was entered, but the specified range contained a value instead of an address. Place an ampersand (&) before the symbol name in the range.

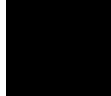

26

Invalid screen specification.

The command entered contains a screen specification that does not correspond to the screen where the specified window is located, or the specified screen does not exist. The screen number should be verified.

27

Invalid window specification.

You tried to create or alter the size of a window, but the screen number, window number, or size coordinates were illegal. See the Window Open command for valid window specifications.

28

Invalid cast. Must use format '(type)'.

This error indicates that type casting was attempted outside of an expression, or without being enclosed in parentheses. Types can only be used in expressions as casts, and must be enclosed in parentheses.

29

Unknown special key.

A key was pressed that the debugger does not recognize.

30

Start line invalid.

The starting line for the Program Find_Source command may be omitted, or may be any valid line optionally within a module.

31

Invalid exception vector.

You tried to specify an exception vector that is invalid. In a Program Interrupt Add command, the optional exception vector must be in the range of 0 to 255.

32

Invalid trace speed.

An attempt was made to specify a step speed with the debugger Option General Step_Speed command that is not in the valid range. Tracing speed ranges from 0 to 100.

33

Must be ON or OFF.

An attempt was made to specify an invalid argument with an option. Options can be switched to ON or OFF.

- 34 **Cannot divide by zero.**
An attempt was made to divide by zero within an expression of Expression Display_Value or Expression C_Expression.
- 51 **This command cannot be used in this mode.**
A command that is not supported in the current mode was issued. The Program Display_Source command is only supported in high-level mode, and the Memory Display Mnemonic command is only supported in assembly-level mode.
- 52 **Switches cannot be used together.**
Two switches of the same group were given. Only one switch per group may be specified.
- 53 **Invalid switch given for this command.**
The specified qualifier is not associated with the specified command. Check the command syntax and re-enter the command.
- 54 **Value too large.**
A value that is out of range was specified. Values must be in the valid range for the command.
- 55 **Instruction expressions are invalid in this mode.**
An expression was used for a code address in high-level mode. Only a single line number or function symbol may be used in high-level mode.
- 56 **Module not found.**
The specified module name does not exist. Specify a valid module name.
- 57 **Line number not found.**
The line number specified does not exist in the current module. If the line number exists in a different module, the module name must be specified.

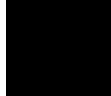

- 58 **Symbol not found.**
The symbol name was entered incorrectly, or the symbol does not exist. The symbol name may have been mistyped.
- 59 **Macro not found.**
The specified macro has not been defined, or an invalid macro name was entered. Check the macro name, or define the macro and re-enter the macro name.
- 60 **File not found.**
The specified file does not exist in the current directory, or in the search directories. Check the current directory for the filename that was specified. A typing error may have occurred.
- 61 **Structure member not found.**
The specified structure member does not exist in the specified structure. Check the structure definition for the member that was specified. A typing error may have occurred.
- 62 **Numeric addresses not allowed in this mode.**
An attempt was made to specify an invalid address value.
- 63 **Line numbers from different modules.**
Line numbers from different modules were specified. Only one module specification may be given.
- 64 **Range addresses of different types.**
Not used.
- 65 **Port input does not come from file or string.**
You cannot rewind an input port that does not get its input from a file or a string.

- 66 **Port output does not go to a file.**
Only port output directed to a file may be rewound with the Memory Port Rewind Output command.
- 67 **This breakpoint is already set.**
An attempt was made to set a breakpoint that already exists. The current breakpoint must be deleted before it can be reset.
- 68 **Port value not found.**
A port was specified that has not been created with the Memory Inport Assign or Memory Outport Assign command.
- 69 **Address in range already specified as Read_Only or Guarded.**
An address that was previously specified with a Memory Map Read_Only or Memory Map Guarded command was specified. Memory Map Read_Only and Memory Map Guarded commands can only act on Write_Read areas.
- 70 **Arguments do not match any Read_Only or Guarded area.**
The arguments specified with a Memory Map Write_Read command do not match the corresponding Memory Map Read_Only or Memory Map Guarded command. The arguments must match exactly. Entering a Memory Map command without arguments gives a map of Read_Only and Guarded areas.
- 71 **Address range contains unacceptable breakpoints.**
An illegal breakpoint was specified.
- 72 **Bad size specification for window.**
An illegal size specification was given for a window. See the Window New command for the correct size specifications.
- 73 **Cannot repeat a cycle count of zero.**
A Program Interrupt Add command qualifier cannot request that an interrupt occur every zero cycles; this would cause an infinite loop.

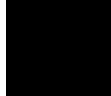

74 **Invalid level number. Must be 1 to 7.**

The Program Interrupt Add command, as well as the 68020 family of microprocessors, permit 7 levels of interrupts.

75 **Attempt to delete nonexistent breakpoint(s).**

You tried to clear a breakpoint that was not previously set. Check that the breakpoint was set, or not already cleared.

76 **Symbol not available from this scope unreferenced.**

You must reference the symbol with a qualified function or module name.

77 **Symbol with this name already exists.**

You tried to define a symbol that was previously defined. Another name should be used.

78 **Cannot create this symbol.**

An error occurred when trying to create the symbol. Check that it is valid as a symbol name.

79 **Symbol is not a module.**

An attempt was made to enter a symbol when a module was expected.

80 **Invalid stack level.**

This error indicates that a stack level was specified that is greater than the current stack nesting.

81 **Not a source procedure.**

An attempt was made to enter an illegal function with the Program Context Set command. The Program Context Set command requires either a module name or a source procedure name.

82 **Cannot delete this symbol.**

Registers and predefined symbols cannot be deleted.

- 83 **Invalid processor name.**
This error indicates that you specified a processor other than one supported by your debugger. See your user's guide for a list of supported microprocessors.
- 84 **Breakpoint limit exceeded.**
The number of breakpoints allowed has been exceeded. This breakpoint has not been set.
- 91 **Internal command/expression processor error.**
An internal memory error has occurred.
- 92 **Not enough memory for expression.**
The expression specified requires more memory than there is available. Try clearing breakpoints or deleting macros to obtain more memory.
- 93 **Invalid memory/register address.**
An attempt was made to read or write to inaccessible target memory. Target memory that is protected cannot be read from or written to.
- 94 **Source is not available for this module.**
An attempt was made to access source code in an assembly language module. Use the Debugger Level command or the **F3** function key to switch to assembly-level mode to display this module.
- 95 **Cannot build source table.**
There is not sufficient memory available to build the source table for source display.
- 96 **Cannot read absolute file.**
An attempt was made to load a file that is not an absolute object module. The code may need to be compiled, assembled, or linked.

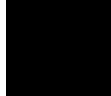

- 97 **Cannot build disassembly table.**
There is not sufficient memory available to build the disassembly table for up-arrow and page-up support in the disassembler.
- 98 **Cannot split monitor lines.**
An attempt was made to monitor different elements on the same line. Only one element per line may be monitored.
- 99 **No empty lines available.**
An attempt was made to specify a line number with the Expression Monitor Value command, but the entire window is already filled. The number of lines in the data window is limited to 17. Use the Expression Monitor Delete command to delete some of the lines.
- 100 **No available windows.**
This error indicates that the numbers allocated for user-defined windows have all been used. Some windows must be deleted before creating another user-defined window.
- 101 **Cannot open file.**
An attempt was made to open a file that does not exist.
- 102 **Local variable not alive.**
A local variable was specified, but the function containing the variable is not active (current or nested).
- 103 **No source level information available.**
The source file for the specified source module cannot be found.
- 104 **A log or journal file is already open.**
An attempt was made to open a new log file when one is already in use. Close the existing log file with the File Log Off command before opening a new log file.

- 105 **Not a color monitor.**
Not used.
- 106 **Not enough memory.**
This error indicates that not enough memory was available for the specified command.
- 107 **Terminated when processing absolute file.**
This error indicates that an invalid control value was encountered in loading the ".x" file.
- 108 **At start of function, no local variables yet.**
This error indicates that arguments and local variables are not available to the debugger at this time. They are available when the prolog to the function has been executed.
- 109 **Local already defined.**
This error indicates that a local variable has been defined twice in a macro definition. One definition of the variable must be deleted.
- 110 **This argument not defined.**
This error indicates that an argument was declared that was not defined on the command line with the Debugger Macro Add command.
- 111 **This macro is in use already.**
Macros cannot be called recursively.
- 112 **This is not allowed outside of a macro.**
Keywords are allowed in macros only.
- 113 **Cannot begin execution from a macro.**
Program Run, Program Step With_Macro, Program Step, and Program Step Over are not allowed from within macros. The PC may be altered with the Memory Register @PC= command.

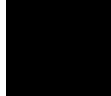

- 114 **This command not allowed from a macro.**
Some commands are not allowed from a macro, such as Debugger Host_Shell and Debugger Macro Add.
- 115 **Invalid float expression, results in NAN.**
A floating point expression resulted in a non-number.
- 116 **Cannot convert float value.**
Float value is too large to convert to an integer.
- 117 **Help file unavailable.**
This error indicates that the help file, "db68k.hlp", was not found.
- 118 **Unsupported float type.**
A floating point type other than 32 or 64 bit has been defined.
- 119 **Cannot get address of register or constant.**
An attempt was made to find the address of a register or constant. One example is: Expression Display_Value &@a1.
- 121 **Cannot open command file for reading.**
This error indicates that the command file specified cannot be found.
- 122 **Include file name too long.**
This error indicates that the filename specified (including its pathname) is too long to be handled by the debugger's internal buffers. Limit the number of characters in the filename specification, or move the file to the default directory.
- 123 **Could not read source line.**
This error indicates that there was an error reading the C source file.

- 124 **Cannot create file for logging.**
This error indicates that there was an error when trying to create the specified log file or that the current directory does not have write permission.
- 125 **Write error occurred while writing to a file.**
This error indicates that the disk is probably full.
- 126 **Cannot open startup file < startupfile> .**
This error indicates that the debugger could not open the specified setup file. The filename may have been misspelled, or the filename does not exist.
- 127 **Invalid number of arguments for macro.**
This error indicates that an incorrect number of arguments was specified in the call or too many parameters were used in the macro definition.
- 128 **Cannot show built-in macros.**
This error indicates that predefined macros cannot be shown with the Debugger Macro Display command. They have no text.
- 129 **Runtime error in macro.**
This error indicates that an error occurred when executing a macro.
- 130 **Command not implemented in simulator version.**
This error indicates that the command entered will not work in this version of the debugger.
- 131 **'option chip' not implemented in this version.**
This error indicates that "option chip" will not work in this version of the debugger.
- 132 **Breakpoint adjusted to location.**
This error indicates that the breakpoint has been moved to an address at the start of an instruction. See the Debugger Option General Align_Bp command syntax description in the "Debugger Commands" chapter.

- 133 **Error return from child process.**
- This error indicates that an error was returned when interacting with the host system through the Debugger Host_Shell command.
- 134 **This command cannot be executed from batch mode.**
- This error indicates that the command entered will not work in batch mode.
- 135 **No search string available.**
- The command Program Find_Source Next was entered without previously entering the Program Find_Source Occurrence command.
- 136 **Cannot open file for logging; file in use for commands.**
- The file specified for logging is currently open and being used to read commands from. Choose another name for the log file.
- 137 **Cannot open file for logging; file in use for logging.**
- The file specified to read commands from is open and being used as a log file. Turn off logging with the File Log OFF command or choose another name for the command file.
- 141 **Miscellaneous error.**
- All available error information is displayed on the screen. Any one of a number of error messages may be displayed on your screen.
- One possible error message is:
- No valid BBA spec file for <processor> processor**
- You must have the HP Branch Validator product for your processor installed on your system in order to use the Memory Unload_BBA command.
- 142 **Miscellaneous warning.**
- All available warning information is displayed on the screen. Any one of a number of warning messages may be displayed on your screen.

- 143 **Miscellaneous note.**
All available information is displayed on the screen. Any one of a number of notice messages may be displayed on your screen.
- 145 **Too many interrupts pending.**
Too many Program Interrupt commands have been given without a sufficient number of interrupts being processed. The current limit on pending interrupts is 16.
- 146 **Void has no value.**
This error message is returned when certain commands are attempted on voids.
- 147 **Invalid suboption.**
This suboption does not work with this command. Refer to the "Debugger Commands" chapter of this manual for valid suboptions for various commands.
- 148 **Invalid option.**
This option does not work with this command. Refer to the "Debugger Commands" chapter of this manual for valid options for various commands.
- 149 **No temporary breakpoints for the macro.**
The command Program Run From < addr> ;< macro> will return this error because a temporary breakpoint has not been specified.
- 150 **Invalid type for this argument, expecting a target address.**
The command was expecting an address. Re-enter the command with a target memory address.
- 151 **Invalid type for this argument, expecting a number.**
The command was expecting a number. Re-enter the command with a number.
- 152 **Cannot delete more than one symbol with this name.**
Multiple symbols with the same name exist. More fully qualify the symbol to make it unique and then retry the command.

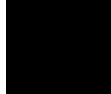

- 153 **Cannot save into this address (not 'lvalue').**
This command can only save at an address which is an 'lvalue'. Check the address and then retry the command.
- 154 **Invalid type for macro argument.**
This is an invalid type for the macro argument. Refer to the chapter on macros for more information on valid types for macro arguments.
- 155 **Stopped by user.**
The execution of this command was halted by the user.
- 156 **Not a logical expression (= , != , < , > , <= , >= , !).**
The expression entered is not a logical expression. Refer to the "Expressions and Symbols in Debugger Commands" chapter for more information on logical expressions and then re-enter the command.
- 157 **Cannot create log file.**
Unable to open the specified file as a journal file.
- 159 **Interrupted during I/O.**
Keyboard I/O was in cooked mode and a read from the keyboard was interrupted.



Debugger Versions

Information about how this version of the debugger differs from previous versions.

Version A.05.00

Graphical User Interface

The debugger now has a graphical user interface. Some of the many features of the graphical interface include:

- pull-down and pop-up menus
- user-definable action keys
- a mouse-driven command line
- improved on-line help
- powerful macro editing
- interactive emulator configuration

The debugger's old standard interface may still be used.

New Product Number

The old product number of this debugger was HP 64372 for HP 9000 Series 300 computers. The new number is HP B1476.

New Reserved Symbols

@ENTRY is the address of the first executable statement in a function. For example, `func1\@ENTRY` is the first executable statement of *func1*. If you set a breakpoint at `func1\@ENTRY` rather than at `func1`, the local variables in *func1* will be active.

@ROOT is the name of the root of the symbol tree represented by the program counter.

@FILE is the name of the file containing the current program counter (if any).

New Predefined Macro

The `cmd_forward()` macro allows you to send commands to other interfaces (such as the emulator interface) which are connected to the emulator. You can even use this macro to let your target code control the debugger.

Environment Variable Expansion

Operating system environment variables will now be expanded when they appear in a debugger command.

For example, "Debugger Directory Change_working \$HOME/test" will now work as expected.

Target Program Function Calls

You may now reference target program functions in C expressions.

Target and debugger variables may be passed by value, and target variables may be passed by reference.

C+ + Support

The debugger now supports C+ + name mangling/de-mangling and object/instance breakpoints for the Microtec Research Inc. C+ + compiler.

Simulated Interrupts Removed

The debugger/emulator no longer supports simulated interrupts.

Simulated I/O Changes

The debugger/emulator's simulated I/O features are now compatible with the emulation interface's simulated I/O.

Simulated I/O now requires the setting up of simulated I/O polling and addresses in the emulator configuration.

Support for 68030 with MMU

Previous versions of this debugger supported the 68020 and 68EC030 processors. This version adds support for the 68030 processor.

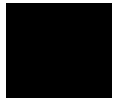

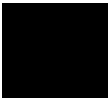

Part 5

Installation Guide



Part 5



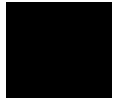

Installation

How to install the debugger software on your computer.

Installation at a Glance

The debugger/emulator is a tool for debugging C programs for 68020/030 series microprocessors in an emulation execution environment.

Follow these steps to install the debugger/emulator:

- 1 Install the software on your computer.
- 2 Install the emulator hardware.
- 3 Set up your software environment to run the debugger.
- 4 Verify the software installation.

Supplied interfaces

When an X Window System that supports OSF/Motif interfaces is running on the host computer, the debugger/emulator has a *graphical interface* that provides pull-down and pop-up menus, point and click setting of breakpoints, cut and paste, on-line help, customizable action keys and pop-up recall buffers, etc.

The debugger/emulator also has a *standard interface* for several types of terminals, terminal emulators, and bitmapped displays. When using the standard interface, commands are entered from the keyboard.

The installation procedure described in this chapter shows you how to install both debugger/emulator interfaces and verify the installation.

Supplied filesets

As you install the software, you will see a list of the filesets on the tape. The filesets are identified by their HP product number.

The tape may contain several products. Usually, you will want to install all of the products on the tape.

However, to save disk space, or for other reasons, you can choose to install selected filesets. For example, if you plan on using the debugger/emulator's standard interface instead of the graphical interface, you can save about 3.5 megabytes of disk space by not installing the XUI suffixed filesets. (Also, if you choose not to install the graphical interface, you will not have to use the "-t" command line option to start the standard interface.)

If you are using only the 68020, you do not need the filesets for the 68030 (these filesets have the 64747 prefix). Likewise, if you are using only the 68030, you do not need to install the filesets for the 68020 (64748 prefix).

Emulator/Analyzer Compatibility

If you are using both the debugger's graphical interface and the emulator/analyzer interface, check that you have an up-to-date version of the emulator/analyzer software. Your emulator/analyzer software should have the same revision number as the debugger software: 5.xx.

If the emulator/analyzer software has a revision number of 4.xx or earlier, the following restrictions apply:

- Do not run the debugger at the same time as the emulator/analyzer window. However, you may use them nonconcurrently.
- Use the debugger interface, not the emulator/analyzer interface, to load and modify the emulation configuration. Thus, be sure to start your session from the debugger.

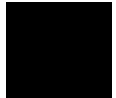

To install software on an HP 9000 system

Required Hardware and Software

To install and use the debugger/emulator's graphical interface, you need:

- HP 9000 Series 300/400 computer running HP-UX version 7.03 or later, or HP 9000 Series 700 computer running HP-UX version 8.01 or later.

To check the HP-UX operating system version, enter the **uname -a** command at the HP-UX prompt. If the version number of the HP-UX operating system is less than 7.03, you must update the operating system to version 7.03 or higher before you can use the debugger. (Refer to the "Updating HP-UX" chapter of the *HP-UX System Administration Tasks* manual for detailed information concerning updating your system.

Motif/OSF. For HP 9000 Series 700 workstations, you must also have the Motif 1.1 dynamic link libraries installed. They are installed by default, so you do not have to install them specifically for this product, but you should consult your HP-UX documentation for confirmation and more information.

Hardware and Memory. The debugger/emulator's graphical interface requires workstations to have a minimum of 16 megabytes of memory. Series 300 workstations should have a minimum performance equivalent to that of a HP 9000/350. A color display is also highly recommended.

- Approximately 3 Mbytes of disk space.
- The emulator hardware.
- HP B1476B debugger/emulator software.

Step 1. Install the software

During the install process, you have some choices about how much you load from the product media. As a general rule, you should load everything from the media. However, to save disk space, or for other reasons, you can choose to install selected filesets.

There are several reasons why you might want to install selected filesets:

- You are using only 68020 processor or only a 68030 processor. In this case, you can exclude the files for the processor you will not be using.
- You were shipped the HP B1471 64000-UX Operating Environment instead of the HP B1471 64700 Operating Environment, you were shipped files that are not necessary to the operation of the debugger/emulator. Excluding these files will save you about 4.5 megabytes of disk space.
- You will not be using the debugger's graphical interface. In this case, you should exclude the filesets that contain the graphical interface because:
 - You will save about 3.5 megabytes of disk space.
 - If you are using X Windows, the graphical interface is the default interface. If you load the graphical interface, but do not use it, you will have to use a special command line option each time you start the standard interface.

The following sub-steps assume that you may want to exclude partitions or filesets. Perform the following sub-steps to load the software on your system:

- 1 Become the root user on the system you want to update.
- 2 Make sure the tape's write-protect screw points to SAFE.
- 3 Put the product media into the tape drive that will be the *source device* for the update process.
- 4 Confirm that the tape drive BUSY and PROTECT lights are on.

If the PROTECT light is not on, remove the tape and make sure the tape's write-protect screw points to SAFE. If the BUSY light is not on, check that

To install software on an HP 9000 system

the tape is installed correctly in the drive and that the drive is operating correctly.

- 5 When the BUSY light goes off and stays off, start the update program by entering

```
/etc/update
```

at the HP-UX prompt.

- 6 When the HP-UX update utility main screen appears, confirm that the source and destination devices are correct for your system. Refer to your HP-UX System Administration documentation if you need to modify these values.

- 7 Select the choice on the update menu that allows you to view the product partitions.

Except for the debugger/emulator partition and the 64700 Operating Environment partition, mark all other partitions with “y” to confirm that you want these partitions loaded. (Do not mark B1471 with “y” if you marked it with “n” in the last step.)

The debugger/emulator partition will be named something like “68020/030 Series debugger/emulator”.

- 8 If you plan to install and use the debugger’s graphical interface, do the following:

- Mark the debugger/emulator partition and the 64700 Operating Environment partition with “y” to confirm the installation of these partitions.

- 9 *If you do not want to install the debugger’s graphical interface*, do the following:

- View the filesets for the 64700 Operating Environment.
- Mark the **XUI** fileset with “n” to exclude it from installation.
- Mark all other filesets in the partition with “y” to confirm installation.
- Return to the partition screen.

Chapter 18: Installation
To install software on an HP 9000 system

- View the filesets in the emulator-specific partition (named something like 68020/030 Series debugger/emulator).
 - Mark the **XUI** fileset with “n” to exclude it from installation.
 - Mark all other filesets in the partition with “y” to confirm installation.
 - Return to the partition screen.
- 10** From the partition screen, choose the update utility softkey that starts the installation process.

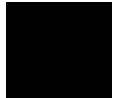

To install the software on a Sun SPARCsystem™

Required Hardware and Software

To install and use the debugger/emulator's graphical interface, you need:

- Sun SPARCsystem computer running SunOS version 4.1 or 4.1.1 or greater. The tape uses the QIC-24 data format.
To check the SunOS operating system version, enter the **uname -a** command at the UNIX prompt. If the version number of the SunOS operating system is less than 4.1, you must update the operating system to version 4.1 or higher before you can use the debugger. For instructions on updating your system, see the Sun *Installing SunOS* manual.
- System V software. To find out whether the System V environment is already installed on your system, check that the directory `/usr/5bin` exists. For instructions on installing System V, see the Sun *Installing SunOS* manual.
- System V IPC facilities (semaphores). To find out whether the IPC facilities are installed on your system, type **ipcs**. For instructions on installing the IPC facilities, see the Sun *System and Network Administration* manual.
- At least 16 megabytes of memory (for the graphical user interface).
- Color display (optional, but recommended for the graphical user interface).
- Approximately 3 Mbytes of disk space.
- The emulator hardware.
- HP B1476B debugger/emulator software.

Step 1: Install the software

For instructions on how to install software on your SPARCsystem, refer to the *HP 64000-UX for SPARCsystems—Software Installation Guide*.

Normally you should install all of the filesets on the tape. If you do not wish to install the graphical interface, install everything except the XUI suffixed filesets. This will save about 3.5 megabytes of disk space.

Step 2: Map your function keys

If you are using the character-based Standard Interface, map your function keys by following the steps below:

- 1 Copy the function key definitions by typing:

```
cp $HP64000/etc/ttyswrc ~/.ttyswrc
```

This creates key mappings in the `.ttyswrc` file in your `$HOME` directory.

- 2 Remove or comment out the following line from your `.xinitrc` file:

```
xmodmap -e 'keysym F1 = Help'
```

If any of the other keys F1-F8 are remapped using `xmodmap`, comment out those lines also.

- 3 Add the following to your `.profile` or `.login` file:

```
stty erase ^H  
setenv KEYMAP sun
```

The erase character needs to be set to backspace so that the Delete key can be used for "delete character."

To install the software on a Sun SPARCsystem™

If you want to continue using the F1 key for HELP, you can use use F2-F9 for the Softkey Interface. All you have to do is set the KEYMAP variable. If you use OpenWindows, type:

```
setenv KEYMAP sun.2-9
```

If you use xterm windows (the xterm window program is located in the directory /usr/openwin/demo), type:

```
setenv KEYMAP xterm.2-9
```

Reminder: If you are using OpenWindows, add /usr/openwin/bin to the end of the \$PATH definition, and add the following line to your .profile:

```
setenv OPENWINHOME /usr/openwin
```

To install the emulator hardware

- 1 If necessary, install the emulator hardware into the HP 64700 Card Cage.

Turn to the *HP 64700 Series Installation/Service Guide* and follow the instructions for installing emulator, memory, or analyzer cards in the HP 64700 Series Cardcage. It may be that you already have installed the cards in the cardcage or your cardcage came with cards already installed.

- 2 Configure the HP 64700 for the communication channel.

Turn to the *HP 64700 Series Installation/Service Guide* and follow the instructions for configuring the emulator to communicate via LAN, RS-422, or RS-232. (RS-422 and RS-232 are only supported on HP 9000 Series 300/400 machines.)

- 3 Connect the HP64700 to your host computer.

Turn to the *HP 64700 Series Installation/Service Guide* and follow the instructions for connecting the emulator to your system. You can connect the emulator via LAN, RS-422, or RS-232.

When you have installed the emulator hardware, continue with Step 3 of these instructions.

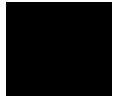

To set up your software environment

Follow these steps to prepare your computer to run the debugger:

- 1 Start the X server.
- 2 Set the necessary environment variables.

To start the X server

If you are not already running the X server and a window manager, do so now. The X server is required to use the Graphical User Interface because it is an X Windows application. A window manager is not required to execute the interface, but, as a practical matter, you must use some sort of window manager with the X server.

- If you are using an HP workstation, start the X server and the Motif window manager by entering:

```
x11start
```

- If you are using a Sun workstation, enter:

```
/usr/openwin/bin/openwin
```

Consult the X Window documentation supplied with the operating system documentation if you do not know about using X Windows and the X server. The chapter “Using X Resources” in this book also discusses X Windows and the X server.

To start HP VUE

If you will be using the X server under HP VUE and have not started HP VUE, do so now.

HP VUE differs slightly from other window managers in that it does not read your `.Xdefaults` file to find resources you may want to customize. Instead, it uses resources from the X resource database. In order to customize resources for the Graphical User Interface under HP VUE therefore, you must either merge a file of customized resources with the X resource database, or set an environment variable that causes the X resource manager to read a file of customized resources. For ease of use, choose the `.Xdefaults` file as your merge file.

- To merge the file `.Xdefaults` with the X resource database, enter

```
xrdb -merge .Xdefaults
```

at the HP-UX prompt.

Customized resources will be merged with the X resource database and will be available for retrieval by the Graphical User Interface.

- To enable the graphical interface to find the `.Xdefaults` file directly, enter the following commands:

```
XENVIRONMENT=$HOME/.Xdefaults
```

```
export XENVIRONMENT
```

The graphical interface will be able to find and read the file in order to retrieve customized resources.

To set environment variables

The following instructions show you how to set these variables at the UNIX prompt. Modify your “.profile”, “.login”, or “.vueprofile” file if you wish these environment variables to be set when you log in.

- Set the DISPLAY environment variable.
- Set the HP64000 environment variable.
- Set the PATH environment variable to include the **usr/hp64000/bin** directory.
- Set the HP64_DEBUG_PATH environment variable.

For the ksh login shell (most HP systems), set a variable by entering
`export <variable>=<value>`

For the csh login shell (most Sun systems), set a variable by entering
`setenv <variable> <value>`

The DISPLAY environment variable must be set before the debugger’s graphical interface will start. Consult the X Window documentation supplied with the UNIX system documentation for an explanation of the DISPLAY environment variable.

Set the HP64000 environment variable if you installed the software in a directory other than “/usr/hp64000” (that is, if you told the installation script to use a path other than “/”).

Also, you should modify the PATH environment variable to include the “\$HP64000/bin” directory and the HP64_DEBUG_PATH environment variable to specify search paths. Including **usr/hp64000/bin** in your PATH relieves you from prefixing HP 64700 executables with the directory path. If HP64_DEBUG_PATH is defined, the debugger only searches for files in the paths specified, in the order in which they are listed.

Examples

These examples use ksh syntax. If you are using csh as your login shell, then use the **setenv** style instead.

If your system is named "myhost," set the display variable by typing:

```
export DISPLAY=myhost:0.0
```

If you installed the HP 64000 software in the root directory, "/", enter:

```
export HP64000=/usr/hp64000
```

```
export PATH=$PATH:$HP64000/bin
```

If you installed the software in the directory /users/team, enter:

```
export HP64000=/users/team/usr/hp64000
```

For example, to cause the debugger to first search the directory /users/proj/src, then the directory /users/proj/mysrc, and finally the location of the source files recorded in the absolute file:

```
export  
HP64_DEBUG_PATH=/users/proj/src:/users/proj/mysrc:%
```

The % character included in the path causes the debugger to search the location of the source files recorded in the absolute file.

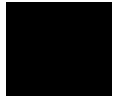

To find the logical name of your emulator

The *logical name* of an emulator is a label associated with a set of communication parameters in the `/usr/hp64000/etc/64700tab.net` file. The `64700tab.net` file is placed in the directory as part of the installation process.

- 1 Display the `64700tab.net` file by entering **more /usr/hp64700/etc/64700tab.net** at the HP-UX prompt.
- 2 Page through the file until you find the emulator you are going to use.

This step will require some matching of information to an emulator, but it should not be difficult to determine which emulator you want to address.

If you find the emulator listed in the file, note its name. If the emulator is not listed, you must modify the file (see the next page) in order for the debugger to access the emulator.

Examples

A typical entry for a 68020 emulator connected to the LAN would appear as follows:

```
#-----  
# Channel | Logical | Processor | Remainder of Information for the Channel  
# Type   | Name   | Type     | (IP address for LAN connections)  
#-----  
lan:    emul68k   m68020    21.17.9.143
```

A typical entry for an emulator connected to an RS-422 port would appear as follows:

```
#-----  
# Channel | Logical | Processor | Host | Physical | Xpar | Parity | Flow | Stop | Char  
# Type   | Name   | Type     | Name | Device   | Mode |        |      | Bits | Size  
#       |        |         |      |          | OFF  | NONE   | XON | 2    | 8  
#-----  
serial:  emul68k   m68020    myhost /dev/emcom23 OFF  NONE   RTS  2    8
```

To add an emulator to the 64700tab.net file

- 1 Make up a logical name for the emulator.

You will use this name to identify the emulator whenever you start the debugger. The name *emul68k* is used as an example throughout this manual.

- 2 If the emulator is connected to a LAN, find out the Internet Address (IP address) of the emulator. (You will also need the LAN address to list the emulator in the */etc/hosts* file.)

If the emulator is connected using a serial port, find out the name of the computer to which the emulator is connected, the device file name for the emulator, the baud rate of the serial channel, and the flow control protocol of the serial channel.

- 3 Edit the */usr/hp64000/etc/64700tab.net* file and add a line for the emulator. The new line should look like one of the examples given on the previous page.

See Also

The *HP 64700A Card Cage Installation/Service Guide*.

The 64700tab on-line manual page.

To add an emulator to the `/etc/hosts` file

- If the emulator is connected via a LAN, edit the `/etc/hosts` file to add a line consisting of the emulator's Internet Address (IP Address) and name.

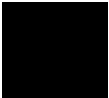

To verify the software installation

A number of new filesets were installed on your system during the software installation process. This step assumes that you chose to load the filesets for the debugger/emulator's graphical interface.

You can use this step to further verify that the filesets necessary to successfully start the graphical interface have been loaded and that customize scripts have run correctly. Of course, the update process gives you mechanisms for verifying installation, but these checks can help to double-check the install process.

- 1 Verify the existence of the **HP64_Debug** file in the **/usr/lib/X11/app-defaults** subdirectory by entering

```
ls /usr/lib/X11/app-defaults/HP64_Debug
```

at the HP-UX prompt.

Finding this file verifies that you loaded the correct fileset and also verifies that the customize scripts executed because this file is created from other files during the customize process.

- 2 Examine **/usr/lib/X11/app-defaults/HP64_Debug** near the end of the file to confirm that there are resources specific to your microprocessor.

Near the end of the file, there will be resource strings that contain references to specific microprocessors. For example, if you installed the debugger/emulator's graphical interface for the 68020/030 series microprocessors, resource name strings will have "debug*m68020" embedded in them.

To remove software

- 1 Find the fileset name of the product you wish to remove.

To see a list of the fileset names which you can remove, on an HP-UX system type:

```
ls /etc/filesets
```

Or, on a Sun system, type:

```
ls $HP64000/etc/filesets
```

Each file in this directory contains a list of files which were installed for that fileset.

- 2 Log in as root.
- 3 At the operating system prompt, type:

```
sysrm <product_number>
```

Sometimes you may wish to remove all of the files which were installed for a certain product. For example, maybe you have finished a software development project and you need to make more free space on your hard disk.

To make removing software easier, the installation script creates two files. The first file is a list of all of the files installed for a certain product. The list is stored by product number in the /etc/filesets directory. The second file is the sysrm script, which is stored in the \$HP64000/usr/hp64000/bin directory. The sysrm script removes the files listed in /etc/filesets for the specified product.

Example

If you wish to remove all of the files which were installed for the B1460 product, type:

```
sysrm B1460
```

Configuring Terminals for Use with the Debugger

If you are using the debugger's graphical interface, you do not need to read this section.

This section shows you how to:

- Configure HP terminals or bit-mapped displays.
- Configure DEC VT100 terminals.
- Configure DEC VT220 terminals.
- Set the TERM environment variable.
- Set up control sequences.
- Resize X terminal emulation windows running the standard interface.

Supported Terminals

The following table lists the terminals and bit-mapped display devices supported by the debugger. The environment variable TERM is the variable which most UNIX applications (such as the debugger) use to customize the application for a particular terminal, display or window. In /bin/sh and /bin/ksh, the TERM variables setting may be queried by typing:

```
echo $TERM
```

The term variable is usually set by the login process (usually by /etc/profile). See the *HP-UX System Administration Task Manual* for more information on adding Peripheral Devices (terminals and modems).

The following table shows the supported configurations for:

- RS-232 terminals.
- bit-mapped displays.
- X-Window support.

Chapter 18: Installation
Configuring Terminals for Use with the Debugger

Supported Terminals TERM Settings¹

| Terminal/Driver Card | RS-232 Terminal | Bit Mapped Display | X-Windows (using client hpterm) |
|---------------------------|-----------------|-------------------------|------------------------------------|
| HP 2392 | TERM= 2392 | | |
| HP 700/92 | TERM= 70092 | | |
| HP 700/94 | TERM= 70094 | | |
| VT100 | TERM= vt100a | | |
| VT220 | TERM= vt220 | | |
| HP 700/22 | TERM= vt220 | | |
| HP 64020A ⁴ | TERM= 2392 | | |
| HP 98544[AB] ⁴ | | TERM= 300h ² | TERM= X-hpterm ³ |
| HP 98547A ⁴ | | TERM= 300h ² | TERM= X-hpterm ³ |
| HP 98548A ⁴ | | TERM= 98548 | TERM= X-hpterm ³ |
| HP 98550A ⁴ | | TERM= 98550 | TERM= X-hpterm ³ |

Notes:

¹ TERMINFO= /usr/hp64000/lib/terminfo.

² On Bit Mapped Displays, you may need to set the function keys to *user* mode by holding down the **shift** key and then pressing the **user** key.

³ TERM may be set to X-hpterm, hpterm, hp2622, or 2392 (see note following this table).

⁴ Supported only on HP 9000 Series 300 computers.

RS-232 Terminals. RS-232 terminals interface to HP-UX by means of HP 98626, HP 98642, or HP 98629 RS-232 interface cards.

RS-232 terminals and bit mapped displays should be added to HP-UX according to the instructions in the *HP-UX System Administration Task Manual* for adding Peripheral Devices (terminals and modems).

Note

If TERM is set to 2392, the debugger attempts to draw solid lines using an alternate character set. For HP terminals, the debugger assumes this character set is the HP line drawing character set. The X11 command "hpterm" has the capability to shift in and out of an alternate character set. However, it defaults this character set to a font other than the HP line drawing font unless the line drawing font is explicitly specified as the alternate character set when the window is started. The alternate character set can be specified using an hpterm command line option or an X11 resource specification. See your HP-UX X11 documentation for more information.

Availability of fonts depend on the X11 server, not the X client program (hpterm). Only one HP line drawing font is available with HP-UX X11 servers. This font is "line.8x16". It must be used with the primary font "hp8.8x16" because the primary and alternate fonts must have the same dimensions. Refer to the "hpterm" manual page for more information.

Example: The following command starts an hpterm window with a primary font of hp8.8x16 and an alternate font of line.8x16.

```
hpterm -fn hp8.8x16 -fb line.8x16
```

Bit-Mapped Displays. Bit-mapped displays are listed by the boot up display as ITE (Internal Terminal emulator). They are high resolution display tops running without a window manager such as HP Windows or X Windows. Bit-mapped displays are supported only on HP 9000 computers.

X-Windows. X Windows refers to applications running on a bit-mapped display with X Windows managing the display top. Within X Windows, *hpterm* is a good general purpose HP terminal emulator for applications which are not specially customized for the X environment.

DEC Terminal ANSI Keypad Functions

The following figures show the ANSI keypad functions and the mapping of the top row of function softkeys.

Chapter 18: Installation
Configuring Terminals for Use with the Debugger

| | | | |
|------------------------|----------------------|----------------------|-----------------------|
| PF1 Softkey F1 | PF2 Softkey F2 | PF3 Softkey F3 | PF4 Softkey F4, |
| 7 Softkey F5 | 8 Softkey F6 | 9 Softkey F7 | - Softkey F8, |
| 4 Roll Up | 5 Next Page | 6 Insert Char | ” Delete Char, |
| 1 Roll Down | 2 Prev Page | 3 Unused | Enter CR, |
| 0 Command Recall | | Clear Line | ^ , |

DEC Terminal Top Row Function Keys

| | | | | | | | | | |
|---------------|---------------|---------------|---------------|---------------|--|---------------|---------------|---------------|---------------|
| F6 | F7 | F8 | F9 | F10 | | F11 (ESC) | F12 (BS) | F13 (LF) | F14 |
| Softkey F1 | Softkey F2 | Softkey F3 | Softkey F4 | Softkey F4 | | Softkey F5 | Softkey F6 | Softkey F7 | Softkey F8 |

To configure HP terminals or bit-mapped displays

- 1 Press the **System** key. (New function labels appear.)
- 2 Press the **Config Keys** key. (New function labels appear.)
- 3 Press the **Terminal Config** key.
- 4 Use the **Tab** key to select fields.
- 5 Choose the appropriate options for:

| | |
|--------------|----------------|
| LocalEcho | OFF |
| CapsLock | OFF |
| SPOW(B) | NO |
| InhEolWrp(C) | NO |
| ReturnDef | ^c r |

The screenshot shows a terminal window titled "TERMINAL CONFIGURATION". At the top, there are two empty rectangular input fields. Below these, the screen is divided into several sections. On the left, there are four empty input fields. In the center, there are four settings: "LocalEcho" with a box containing "OFF", "CapsLock" with a box containing "OFF", "SPOW (B)" with a box containing "NO", and "InhEolWrp (C)" with a box containing "NO". To the right of these, there are two more empty input fields. At the bottom right, "ReturnDef" is set to a box containing "C" over "R". At the very bottom of the screen, there is a row of eight function keys: [F1] SAVE CONFIG, [F2] NEXT CHOICE, [F3] PREVIOUS CHOICE, [F4] DEFAULT VALUES, [F5] (empty), [F6] (empty), [F7] DISPLAY FUNCTNS, and [F8] config keys.

Chapter 18: Installation
Configuring Terminals for Use with the Debugger

- 6 Save the configuration by pressing the **SAVE CONFIG** key.

All other terminal configuration options are user-definable.

Note

With bit-mapped displays, you may need to set the function keys to *user* mode by holding down the **shift** key and then pressing the **user** key.

To configure the DEC VT100 terminal

You must configure two menus in order for the VT100 display to work properly: SET-UP A and SET-UP B.

SET-UP A

- 1 Press **SET-UP** to enter the setup menu.
- 2 Press **80/132 COLUMNS** to select 80 columns per line. The columns per line must be set to 80.
- 3 Press **SET-UP** to exit SET-UP A.

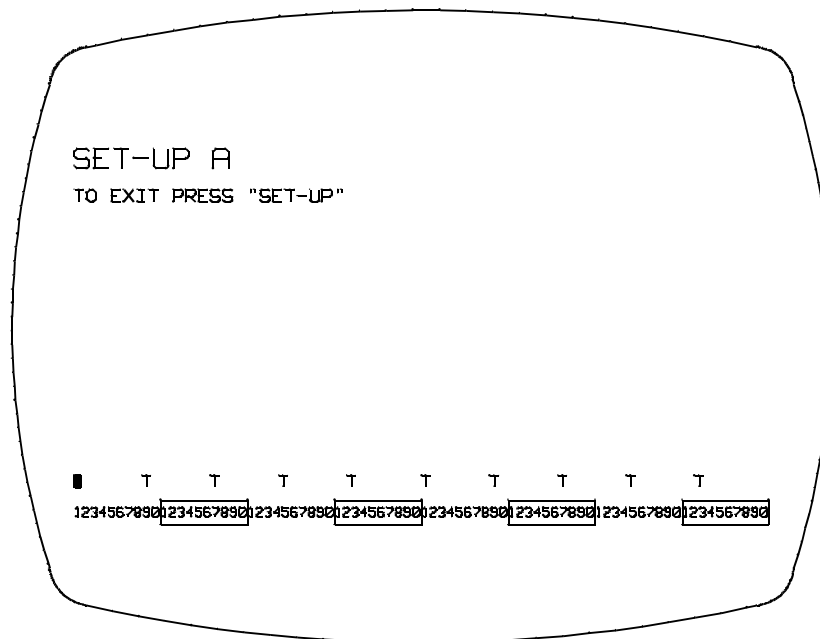

SET-UP B

- 4 Press **SET-UP** to enter the setup menu, then press **SETUP A/B**.

Chapter 18: Installation
Configuring Terminals for Use with the Debugger

- 5 Using the arrow keys, position the cursor at the SET-UP feature to be changed.
- 6 Press **TOGGLE 1/0** to select the feature. Do this for the four features shown below:
- 7 Press **SET-UP** to exit SET-UP B.

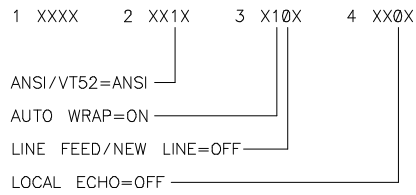

An "X" indicates a user-definable terminal/computer dependency option.

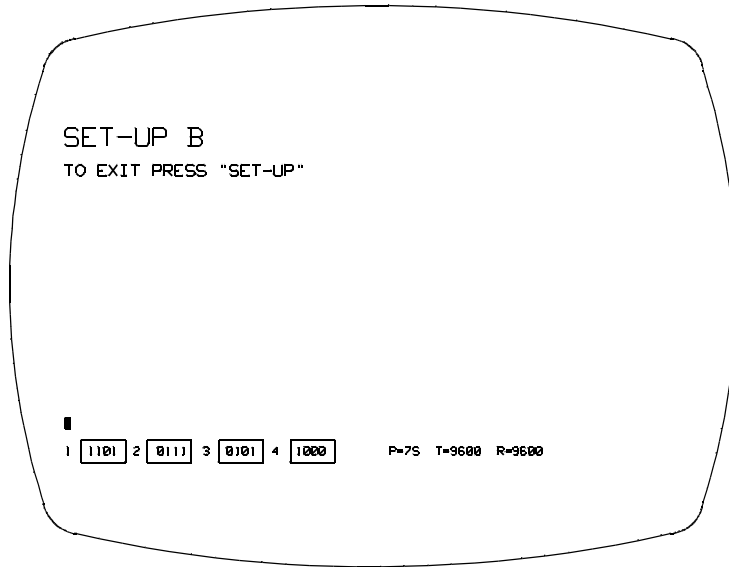

To configure the VT220 terminal

There are three menus that you must set up in order for the VT220 display to work properly:

- Display
- General
- Comm

From the power-on condition, press the **SET-UP** key to move into the initial SET-UP directory.

Note

To change fields within the menus, position the cursor at the desired field and press the **Enter** key.

Follow these steps to set up all three menus:

- 1 Press the **SET-UP** key to enter the setup directories.
- 2 With the cursor at the *Display* field, press the **Enter** key.

Use the arrow keys to move the cursor to the *Columns* field. This must be set for 80 columns. If 80 columns is not the selection displayed, press the **Enter** key.

Position the cursor at the *Auto Wrap* field. This field must be set to *Auto Wrap*.

Position the cursor at the *To Directory* field. Press **Enter**.

- 3 Position the cursor at the *General SET-UP* field. Press **Enter**.

Position the cursor at the *VT200 Mode* field. This field must be set to *VT200 Mode, 7-Bit Controls*.

Position the cursor at the *New Line* field. This field must be set to *No New Line*.

Position the cursor at the *To Directory* field. Press **Enter**.

Chapter 18: Installation
Configuring Terminals for Use with the Debugger

- 4 Position the cursor at the *Comm SET-UP* field. Press **Enter**.

Position the cursor at the *Local Echo* field. This field must be set to *No Local Echo*.

- 5 Position the cursor at the *To Directory* field. Press **Enter**. At this point, if you want to permanently save the selections you have made, position the cursor to the *Save* field and press **Enter**. Otherwise, press **SET-UP** to exit the menus and return to the normal operating mode.

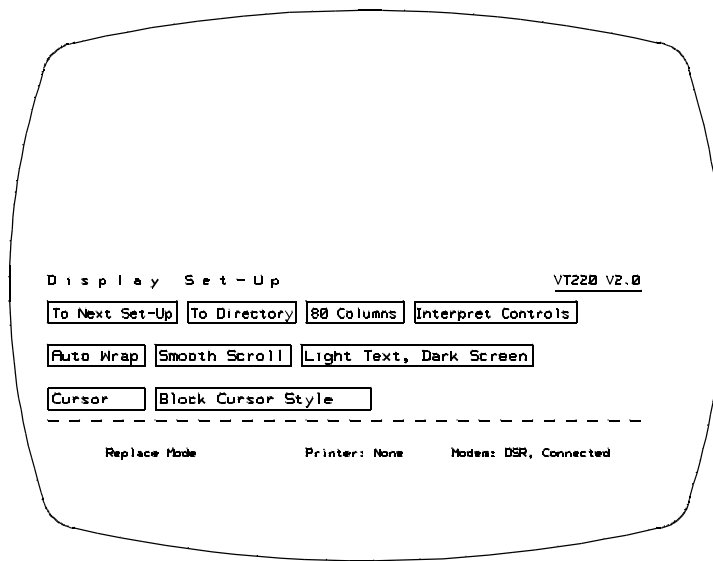

Chapter 18: Installation
Configuring Terminals for Use with the Debugger

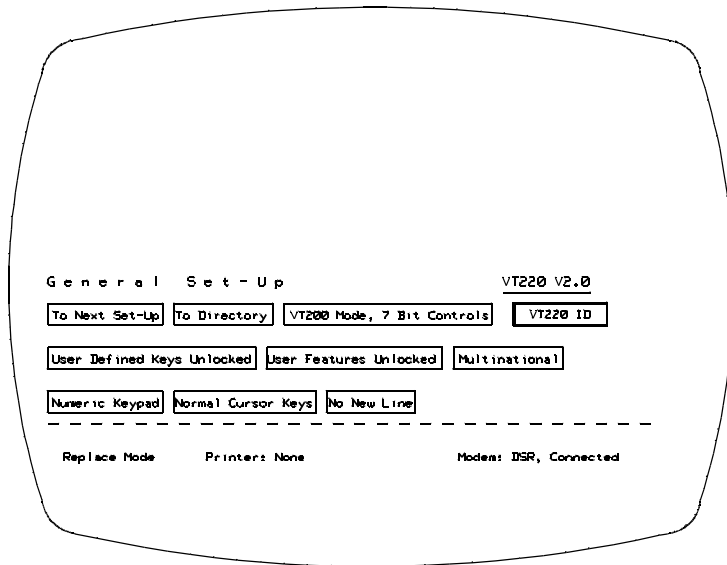

General Set-Up VT220 V2.0

To Next Set-Up To Directory VT220 Mode, 7 Bit Controls VT220 ID

User Defined Keys Unlocked User Features Unlocked Multinational

Numeric Keypad Normal Cursor Keys No New Line

Replace Mode Printer: None Modem: DSR, Connected

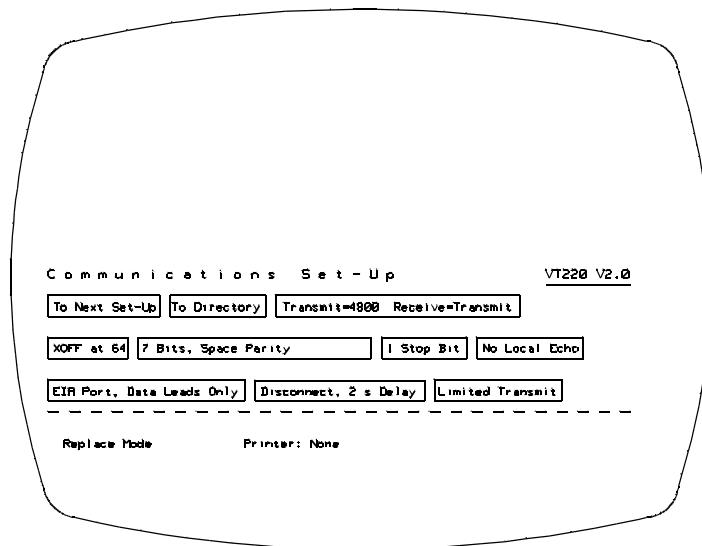

Communications Set-Up VT220 V2.0

To Next Set-Up To Directory Transmit=4800 Receive=Transmit

XOFF at 64 7 Bits, Space Parity 1 Stop Bit No Local Echo

EIR Port, Data Leads Only Disconnect, 2 s Delay Limited Transmit

Replace Mode Printer: None

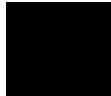

To set the TERM environment variable

- If you are using the *ksh* shell, use the **export** command to set the TERM environment variable.

Or:

- If you are using the *cs* shell, use the **setenv** command to set the TERM environment variable.

Find the appropriate setting for the TERM environment variable in the previous table.

Examples

To set the TERM environment variable for a color bit-mapped display top using the HP 98547A driver card:

```
export TERM=300h
```

To set the TERM environment variable for a HP 2392 terminal:

```
export TERM=2392
```

To define and export the TERM environment variable for the VT220 terminal:

```
export TERM=vt220
export TERMINFO=/usr/hp64000/lib/terminfo
```

To define and export the TERM environment variable for the VT100 terminal:

```
export TERM=vt100a
export TERMINFO=/usr/hp64000/lib/terminfo
```

To set up control sequences

- Configure the stty settings in either /etc/profile or in \$HOME/.profile.

The control characters for most HP applications should be set as follows. If the control characters get changed, you can reset them by typing the commands shown below after you have logged in to the system.

```
stty intr  \^c  (sets intr to CTRL c)
```

```
stty kill  \^u  (sets clear inputline to CTRL u)
```

```
stty quit  \^\\  (sets quit to CTRL \)
```

```
stty eof   \^d   (sets end of file to CTRL d)
```

For the HP terminals and bit-mapped displays:

```
stty erase \^h  (sets erase character to backspace)
```

For the DEC VT100 and VT220 terminals:

```
stty erase \^?  (sets erase character to delete (DEL))
```

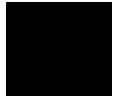

To resize a debugger window in an X-Window larger than 24 lines by 80 columns

The following procedure describes how to resize a debugger window in an X-Window larger than 24 lines by 80 columns.

- 1 Check to see that the *LINES* and *COLUMNS* shell environment variables are correctly set for the window that you are working in so that the debugger knows what the screen limits are. By default, hpterm will set the screen limits correctly when a window is created. However, if you change its size, you should execute the command:

```
eval ` /usr/bin/X11/resize `
```

from your shell. See the man page for `resize(1)` for details about how this works.

To resize a debugger window in a window larger than 24 lines by 80 columns

The following procedure describes how to resize a debugger window in a window larger than 24 lines by 80 columns.

- 1 Check to see that the `stty` settings for *rows* and *columns* are correct for the window that you are working in so that the debugger knows what the screen limits are. Do this by entering the command:

```
stty size
```

The first number given is rows, the second number is columns. By default, the screen limits are set correctly when you change the size of the window. However, if the values for rows and columns are not correct for your window, you can set them by entering the `stty` command from your shell. For example, the command

```
stty rows 40 columns 100
```

will define a window to be 40 rows by 100 columns.

- 2 Start the debugger and load an executable file.

You need an executable in order to move windows in the source-level screen.

- 3 Move the status windows (command line) first. Start with the high-level status window (window number 5). For example, the command:

```
Window New 5 High_Level 46,0,49,79
```

will place the command line at the bottom of a window with 50 rows.

Then move the assembly-level status window (window number 15) to the bottom of the window. For example:

```
Window New 15 Assembly 46,0,49,79
```

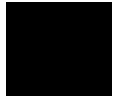

Configuring Terminals for Use with the Debugger

You can edit the previous command to save some typing. Remember the following information when moving the status windows:

- 1 The coordinates start from (0,0) in the upper left.
- 2 The maximum width of the command line is 80.
- 3 The `top_row` and `bottom_row` coordinates must be exactly three apart.
- 4 Move and resize the remainder of the windows by selecting each window and using the `Window Resize` command. Don't forget to resize the alternate view of each window. Use the `Window Toggle_View` command to select the alternate view.
- 5 You may want to set the `View` options of the `Stdio`, `View`, and `Breakpoint` windows to `On` (the windows swap by default). See the command description for the `debugger Option View` command for details.
- 6 Save your changes by executing the `File Startup` command. For example, the command:

```
File Startup YourNameHere
```

will create a startup file named `YourNameHere.rc`. You can then use your custom window configuration by using the `-s YourNameHere` command.

The debugger will also automatically look in `./db68k.rc` or `./db68030.rc` for a startup file if you don't want to use the `-s` command line option.

Glossary

absolute file An executable module generated by compiling, assembling, and linking a program. Absolute files must have an extension of .x.

action key User-definable hotkeys that give you the ability to customize the interface.

application default file A file containing default X resource specifications for an X Window System application.

background monitor An emulation monitor program that does not execute as part of the user program. See “emulation monitor”.

BBA The Hewlett-Packard Branch Validator. It is a software tool you can use to analyze your testing, create more complete test suites, and measure your level of testing.

breakpoint A location in the program at which execution should stop.

cascade menu A secondary menu that appears when you select an item from a pull-down menu.

click To press and release a mouse button. The term comes from the fact that pressing and releasing the buttons of most mice makes a clicking sound.

command file An ASCII file containing debugger commands.

command line An area at the bottom of the debugger window where commands may be entered using softkeys or pushbuttons. All **standard interface** commands are entered using the command line.

command token The smallest part into which a command may be broken—usually one word. Command tokens appear as pushbuttons on the command line.

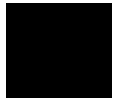

concurrent usage model Describes an interface in which the user can perform most commands at the same time that code is being executed under emulation.

configuration file See “emulator configuration file”.

cooked keyboard I/O mode The I/O mode in which keyboard input is processed. This lets you type and then edit the line to correct errors.

cut buffer A synonym for “entry buffer”.

dialog box Sometimes called a secondary window, the dialog box is called by the user from the application’s main window. A dialog box contains controls or settings, and sometimes prompts for text entry.

display area The part of the debugger window which shows windows containing information such as high-level code and breakpoints.

double-click To press the mouse button twice, quickly.

E/A The Emulator/Analyzer window.

emul700dmn The UNIX background process which coordinates the actions and message traffic of the major emulation interfaces.

emulation memory Memory provided by the emulator to be used in place of target system memory.

emulation monitor A program that is executed by the emulation processor that allows the emulation controller to access target system resources. For example, when you display target system memory locations, the monitor program executes the microprocessor instructions that read the target memory locations and send their contents to the emulation controller. See also “foreground monitor” and “background monitor”.

emulator An instrument that performs just like the microprocessor it replaces, but at the same time, it gives you information about the operation of the processor. An emulator gives you control over target system execution and allows you to view or modify the contents of processor registers, target system memory, and I/O resources.

emulator configuration file A file that contains configuration settings and memory map definitions for the emulator.

entry area A section of the **command line** area where commands are built. When you use menus or softkeys, the actual command which the debugger will execute appears in the entry area.

entry buffer The part of the graphical interface which contains "input" for commands. The symbol for the entry buffer is "()".

foreground monitor An emulation monitor program that executes as part of the user program. See "emulation monitor".

graphical interface The debugger interface program that uses graphics-oriented software such as windows, menus, and icons to make interaction easy.

host shell A UNIX command interpreter.

iconify The act of turning a window into an icon.

journal file A file that contains commands entered during a debug session and any output generated by the debugger. Journal files contain everything that is written to the debugger's journal window.

log file A command file that is created by the debugger when you record commands.

macro A C-like function consisting of debugger commands and C statements and expressions. Macros are most often used to patch C source code, create conditional breakpoints, return values to expressions, or execute a set of commands.

menu bar The row of words at the top of the graphical interface window. Clicking on the menu bar will display a menu of debugger commands.

monitor See "emulation monitor".

patch A small, temporary change to executable code.

PITS cycle Programming In The Small cycle. The repeating process of editing, compiling, and executing code to eliminate bugs.

pointer The symbol on your computer's screen which shows where the mouse is pointing. The pointer may be a hand, an arrow, or another shape.

pop-up menu A menu that pops up when you press and hold the right mouse button. Pop-up menus are available whenever the mouse pointer changes to a "hand-cursor".

predefined macro See also "macro".

pull-down menu A menu that appears to "pull down" from the menu bar at the top of the interface window.

pushbutton A graphic control that simulates a real-life pushbutton. Use the pointer and mouse to push the button and immediately start an action.

raw keyboard I/O mode The I/O mode in which each keystroke produces a character that is sent to the target program that is reading from the keyboard.

recall buffer A text entry field which remembers its previous value.

resource See "X resource".

scheme file A file that contains X resource specifications for a particular group of resources, for example, for a particular type of display, computing environments, or language.

scroll bar A scroll bar is used to move a window so that you can see information beyond the window's edge.

sequential usage model Describes a user interface in which user code execution must be stopped before the interface can perform most commands.

shell See "host shell".

simulated I/O The debugger feature that lets user programs read input from, and write output to, the same keyboard and display (respectively) that are used

to control the debugger. Simulated I/O also lets user programs use the UNIX file system and run UNIX commands.

simulated program interrupt User program interrupts that are simulated by the debugger. Simulated interrupts can be one-time interrupts or periodic interrupts.

simulator A software tool that simulates a microprocessor system for the purpose of debugging user programs.

SPA The HP Software Performance Analyzer.

standard interface The traditional debugger interface designed for use with several types of terminals, terminal emulators, and bitmapped displays. When using the standard interface, commands are entered from the keyboard.

startup file A file that contains information regarding debugger options and screen configurations.

state file A file that contains the CPU state (including register values) and a memory image. This file is saved within a debugger session and can be loaded at a later time to return to a particular state of execution.

status line A line which displays debugger information such as the CPU type, the current module name, and the current debugger operation.

sticky slider A scrollbar slider which is designed for local navigation in a large file. Moving the slider moves the contents of the active window just a few pages at a time.

storage qualifier A bus cycle state description that causes only particular states to be stored in the analyzer trace.

trace A collection of states captured on the emulation bus (in terms of the emulation bus analyzer) or on the analyzer trace signals (in terms of the external analyzer) and stored in trace memory.

trace event A bus state consisting of a combination of address, data, and status values.

Glossary

trigger The captured analyzer state about which other captured states are stored. The trigger state specifies when the trace measurement is taken.

window A window inside the debugger's display area. See also "X window".

working directory The current directory from which the debugger loads and saves files.

X resource A piece of data that controls an element of appearance or behavior in an X application.

X server A program that controls all access to input devices (typically a mouse and a keyboard) and all output devices (typically a display screen). It is an interface between application programs you run on your system and the system input and output devices.

X window A window on your computer's display. The debugger's graphical interface runs inside an X window. See also "window".

Index

() entry buffer, **655**
/dev/simio/display reserved symbol, **174**
/dev/simio/keyboard reserved symbol, **174**
6400tab.net file, **632–633**
68851 MMU, not supported, **149**
68881 coprocessor, **149**
@, **323**

- A** absolute file, **653**
absolute files, **95–96**
access breakpoints, using with trace, **187**
action keys, **7, 653**
 custom, **278**
 operation, **67**
 with command files, **278**
 with entry buffer, **66–67**
activating windows, **15**
active window
 changing, **141**
 displaying the alternate view of, **142**
 viewing information in, **143–144**
active window, description of, **141**
add bit-mapped displays to HP-UX, **638**
add configured terminals to HP-UX, **638**
add symbol, **130**
adding an emulator, **632–633**
Address for read cycles?, **304**
address operator, **30**
address ranges, **533**
address registers @A0-A7, **553**
addresses, **533–534**
 assembly level code, **533**
 code, **533**
 data, **533**
 displaying variable, **30**
 logical, **475–476**

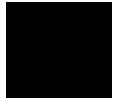

- addresses (continued)
 - physical, **475–476**
 - ranges, **533**
- alignment
 - tracing instructions, **392**
- analysis breakpoints, **105**
- analyzer
 - configuring the clock, **323**
- ANSI keypad functions, **639**
- app-defaults directory
 - HP 9000 computers, **336**
 - Sun SPARCsystem computers, **336**
- append programs, **97**
- application default file, **653**
- application resource
 - See X resource*
- arguments for macros, **223**
- assembly code
 - in source display, **255**
- assembly level code addresses, **533**
- assembly-level screen
 - description of, **135**
 - displaying, **136**
- assembly-level status window
 - moving, **264**
- attribute options, **311**
- B**
 - background monitor, **302, 305, 653**
 - backtrace
 - display of bad stack frames, **251**
 - backtrace window
 - backtrace information, **155**
 - description of, **153–156**
 - frame status characters, **154**
 - function name, **155**
 - function nesting level, **154**
 - halting at stack level, **115**
 - module name, **155**
 - batch mode option, **245**
 - BBA, **653**
 - bindings, mouse, **9–11**
 - bit-mapped displays, **639**

- bit-mapped HP displays
 - configuring, **641**
 - set control sequences for, **649**
- blocks
 - comparing, **216**
 - copying, **215**
 - filling, **216**
- Branch Validator, **126**
- break conditions, **295**
- break on access to a variable, **31, 48**
- Break processor on write to ROM?, **320**
- break_info macro, **558–559**
- breakpoint, **653**
- breakpoint commands, summary of, **353**
- breakpoint window
 - address field, **113**
 - command argument, **114**
 - description of, **113**
 - line number field, **114**
 - module/function field, **113**
 - number field (#), **113**
 - type field, **114**
- breakpoints
 - analysis, **105**
 - automatic alignment, **250**
 - C++ , **109–110**
 - checking definitions of, **112**
 - controlling program execution with, **105–115**
 - deleting, **25**
 - hardware, **105**
 - removing, **111–112**
 - setting, **21**
 - software, **108**
 - use macros with, **232**
- Breakpt Access command, **358–359**
- Breakpt Clear_All command, **360**
- Breakpt Delete command, **361**
- Breakpt Instr command, **362–363**
- Breakpt Read command, **364**
- Breakpt Write command, **365**
- bus width, **392**



button names, **9–11**

byte macro, **560**

bytes

changing, **214**

C C operators, **523**

C source code

displaying, **146**

C++

breakpoints, **109–110, 362**

browse command, **165, 466**

classes, **466, 536**

displaying class members, **162**

displaying member values, **162**

functions, **109–110, 146**

inheritance, **466**

object instance, **109**

objects, **162**

operators, **524**

overloaded functions, **110, 362**

protection, **162**

this pointer, **158**

cache address register @CAAR, **553**

cache control register @CACR, **553**

calling a macro, **221**

carry flag @C, **553**

cascade menu, **653**

casting, special, **542**

cautions

target system could be damaged, **297**

change active window, **141**

changing

directory context in configuration window, **288**

character constants, **528**

character string constants, **528**

characters, non-printable, **528**

check breakpoint definitions, **112**

check simulated I/O resource usage, **178**

class name, X applications, **335**

class name, Xresource, **333**

classes (C++)

displaying members of, **162**

- clear breakpoints, **111–112**
- click, **653**
- client, X, **270, 332**
- close macro, **561**
- cmd_forward macro, **562–563**
- code addresses, **533**
- code patching
 - deleting C source lines from your program, **212–213**
 - inserting lines of C code into your program, **212**
 - patching a line, **211**
- color scheme, **272, 276, 339**
- column numbers, **532**
- Command (debugger status), **84**
- command file, **653**
 - comments in, **239**
 - logging commands to, start, **238**
 - logging commands to, stop, **240**
 - playback, **240**
- command file option, **240, 245**
- command files
 - description of, **237–246**
 - echoing commands, **250**
- command language
 - address ranges, **533**
 - addresses, **533–534**
 - assembly level code addresses, **533**
 - C operators, **523**
 - C++ operators, **524**
 - character constants, **528**
 - character string constants, **528**
 - code addresses, **533**
 - constants, **525**
 - data addresses, **533**
 - data types, **539**
 - debugger operators, **524**
 - debugger symbols, **531**
 - description, **521–550**
 - evaluating symbols, **547**
 - explicit stack references, **549**
 - expression elements, **523–529**
 - expression strings, **537**



- command language (continued)
 - floating point constants, **527**
 - forming expressions, **536**
 - global (extern) storage classes, **538**
 - hexadecimal constants, **526**
 - identical module names, **544**
 - identifiers, **530**
 - implicit stack references, **548**
 - integer constants, **526**
 - keywords, **535**
 - legal characters allowed in symbols, **530**
 - line numbers, **532**
 - local storage classes, **539**
 - macro local symbols, **531**
 - macro names, **531**
 - macro symbol types, **531**
 - macro symbols, **531**
 - module names, **545**
 - non-printable characters, **528**
 - operators, **523**
 - program symbols, **530**
 - referencing symbols, **543**
 - register storage classes, **539**
 - reserved symbols, **532**
 - root names, **543**
 - scoping rules, **543**
 - special casting, **542**
 - stack references, **548**
 - static storage classes, **538**
 - storage classes, **538**
 - symbol length, **530**
 - symbolic referencing, **538–550**
 - symbolic referencing with explicit roots, **546**
 - symbolic referencing without explicit roots, + , **547**
 - symbols, **530–532**
 - type casting, **541**
 - type conversion, **541**
- command line, **7, 653**
 - command line recall operation, **81**
 - Command Recall dialog box, operation, **77**
 - copy-and-paste to from entry buffer, **66**

- command line (continued)
 - editing entry area with keyboard, **81**
 - editing entry area with pop-up menu, **77**
 - editing entry area with pushbuttons, **76**
 - entering commands, **75**
 - entry area, **655**
 - executing commands, **75**
 - help, **78**
 - how to display, **32**
 - recalling commands with command line recall, **81**
 - recalling commands with dialog box, **77**
 - turning on or off, **74, 273**
- command line, description of, **79–83**
- Command Recall dialog box operation, **68**
- command select button, **9–10**
- command token, **653**
- command tokens, description of, **79**
- commands
 - editing in command line entry area, **76–77, 81**
 - entering, **55, 57–88**
 - entering from keyboard, **79**
 - entering in command line, **75**
 - executing in command line, **75**
 - function key, **57**
 - logging to command file, start, **238**
 - logging to command file, stop, **240**
 - playback from command file, **240**
 - recalling with command line recall, **81**
 - recalling with dialog box, **77**
- comments in macros, **222**
- communication between interfaces, **562**
- compare blocks of memory, **216**
- compile programs for the debugger, **90–93**
- compiler h option, effects of, **90**
- concurrent usage model, **654**
- condition codes register @CCR, **553**
- configuration, **248**
 - emulator, **283, 285–328**
- configuration context
 - displaying from configuration window, **289**

- configuration file, **654**
 - creating, **292**
 - if an error occurs while loading, **292**
 - loading, **290**
 - modifying, **292**
- configuration sections, **288**
- configuration, emulator
 - exiting the interface, **289**
 - modifying a section, **286**
 - starting the interface, **285**
 - storing, **287**
- configure DEC terminals, **637**
- configure HP bit-mapped displays, **641**
- configure HP terminals, **641**
- configure the emulator, **290**
- configure VT100 terminal, **643**
- configure VT220 terminal, **645**
- configured terminals, adding to HP-UX, **638**
- configuring terminals for use with debuggers, **637–652**
- constants, **525**
 - character, **528**
 - character string, **528**
 - floating point, **527**
 - hexadecimal, **526**
 - integer, **526**
- context
 - changing directory in configuration window, **288**
 - displaying directory from configuration window, **289**
- control blocking of reads, **176**
- control character functions
 - list of, **58**
 - using, **58**
- control program execution with breakpoints, **105–115**
- control sequences for HP terminals, setting up, **649**
- cooked mode, **654**
- coprocessor
 - 68881, **149**
- coprocessor support, **149**
- copy block of memory, **215**
- copy demonstration files, **41**
- copy macros, **226**

- copy window, **145**
 - copy-and-paste
 - addresses, **64**
 - from entry buffer, **66**
 - multi-window, **64, 67**
 - symbol width, **64**
 - to entry buffer, **63**
 - CPU root pointer @CRP, **553**
 - create a configuration file, **292**
 - current working directory, displaying, **152**
 - cursor control key functions, **143**
 - cursor keys
 - End (Shift_Home) Key Functions, **144**
 - Home Key Functions, **144**
 - cut buffer, **654**
- D**
- data addresses, **533**
 - data registers @D0-D7, **553**
 - data types, **539**
 - db68k options
 - b batch mode, **245**
 - c command file, **240, 245**
 - d demand loading of symbols, **98**
 - I load only symbolic information, **97**
 - j journal file, **242**
 - l log commands, **238**
 - s startup_file, **268**
 - debug/trace options, modifying, **320**
 - debugger commands, summary of, **353**
 - Debugger Directory command, **366**
 - Debugger Execution Display_Status command, **367**
 - Debugger Execution Environment FwdCmd command, **368**
 - Debugger Execution Environment Load_Config command, **369**
 - Debugger Execution Environment Modify_Config command, **370**
 - Debugger Execution IO_System command, **371–373**
 - Debugger Execution Load_State command, **374**
 - Debugger Execution Reset_Processor command, **375**
 - Debugger Help command, **378**
 - Debugger Host_Shell command, **376–377**
 - Debugger Level command, **379**
 - Debugger Macro Add command, **380–382**
 - Debugger Macro Call command, **383**

Debugger Macro Display command, **384**
debugger macros, **219–246**
debugger operators, **524**
Debugger Option Command_Echo command, **385**
Debugger Option General command, **386–388**
Debugger Option List command, **389**
Debugger Option Symbolics command, **390–391**
Debugger Option Trace command, **392**
Debugger Option View command, **393–395**
debugger options dialog box, **249**
Debugger Pause command, **396**
Debugger Quit command, **397–398**
debugger symbols, **130, 531**
DEC terminals, configuring, **637**
decimal, **252**
default trace specification, **185**
Define (debugger status), **84**
define macros, **222, 225–228**
 interactively, **225–227**
define user screens and windows, **264**
delete all command, **314**
delete breakpoints, **111–112**
delete C source lines from your program, **212–213**
delete macros, **236**
delete symbol, **132–135**
delete trace events, **194**
deleting breakpoints
 See breakpoints, deleting
demand load symbols, **98**
demand loading, **252**
demand loading of symbols option, **98**
demonstration program description, **11, 40**
demos
 setting up, **280**
destination function code @DFC, **553**
dialog box, **68, 654**
 Command Recall, operation, **68, 77**
 Directory Selection, operation, **68, 71**
 Entry Buffer Recall, operation, **65, 68**
 File Selection, operation, **68, 70**

- dialog boxes
 - debugger options, **249**
 - macro operations, **225**
- directory (current working), displaying, **152**
- directory context
 - changing in configuration window, **288**
 - displaying from configuration window, **289**
- Directory Selection dialog box operation, **68, 71**
- disable simulated I/O, **175**
- disassembly
 - automatic alignment, **250**
- display a trace, **192**
- display address values, **30, 47**
- display alternate view of a window, **142**
- display alternate view of the active window, **142**
- display area, **7, 654**
 - lines, **274**
- display area windows
 - See* windows
- display assembly-level screen, **136**
- display blocks of memory, **49**
- display command line, **32**
- display help window, **82**
- display high-level screen, **136**
- display next screen, **137–140**
- display screens, **134**
- display source code of macros, **235**
- display standard I/O screen, **137**
- display user-defined screen, **265**
- display variable, **27**
- display variables in their declared type, **47**
- displaying
 - pull-down menus with keyboard, **61**
 - pull-down menus with mouse, **59–60**
- displaying functions, **18**
- displays
 - bit-mapped, **639**
 - configuring HP bit-mapped, **641**
 - setting up HP bit-mapped, **649**
- do statement, **224**



Do you want periodic read accesses while in background monitor?, **303**
double-click, **654**
dword macro, **564**

E E/A, **654**

editing

command line entry area with keyboard, **81**
command line entry area with pop-up menu, **77**
command line entry area with pushbuttons, **76**
copying memory, **215**
file, **208–209, 273**
file at address, **209, 273**
file at program counter, **209**
macros, **228**
memory contents, **214**

editing memory contents, **214**

else statement, **224**

emul700dmn, **654**

emulation memory, **654**

emulation memory installation configurations, **310**

emulation monitor, **654**

emulator, **124, 654**

adding, **632**

configuration, **283, 285–328**

configuration introduction, **284**

configuring, **290**

enable one wait state for memory, **299**

installing, **627**

memory allocation, **294**

modifying pod configuration, **316**

monitor introduction, **294**

restrict commands, **295**

restrict to real-time run, **297**

emulator configuration

examining, **288**

exiting the Emulator Configuration dialog box, **289**

modifying a configuration section, **286**

starting the Emulator Configuration dialog box, **285**

storing, **287**

emulator/analyzer
 version requirement, **619**

emulator/analyzer interface, **124**

Enable signal interlocking on monitor accesses?, **306**

enable simulated I/O, **174**

enable the 68020 instruction cache?, **298**

enable the 68030 instruction & data cache?, **298**

Enable the DSack Interlock?, **306**

End (Shift_Home) Key Functions, **144**

end command, **314**

end debugging session, **36, 51–52**

enter commands from the keyboard, **79**

enter debugger commands, **55, 57–88**

enter monitor after configuration?, **296**

entries (X resource), **279**

entry area, **655**

entry buffer, **7, 655**
 address copy-and-paste to, **64**
 clearing, **63**
 copy-and-paste from, **66**
 copy-and-paste to, **63**
 editing, **66**
 Entry Buffer Value Selection dialog box, operation, **65**
 multi-window copy-and-paste from, **67**
 multi-window copy-and-paste to, **64**
 operation, **66**
 recalling entries, **65**
 setting initial value, **279**
 symbol width and copy-and-paste to, **64**
 text entry, **63**
 with action keys, **66–67**
 with pull-down menus, **66**

Entry Buffer Recall dialog box operation, **68**

environment dependent files, **90**

environment variable
 HP64_DEBUG_PATH, **94**

environment variables
 TERM, setting, **648**

erase information in standard I/O window, **265**

erase information in user-defined window, **265**

error macro, **565**

- error window, description of, **594**
- evaluating symbols, **547**
- Execute (debugger status), **84**
- executing UNIX commands from within the debugger, **123**
- execution
 - run from current program counter address, **102**
 - run from start address, **102**
 - run until stop address, **103**
- execution (program), controlling, **100–104**
- exiting the debugger, **36**
- explicit stack references, **549**
- Expression C_Expression command, **399**
 - modifying variables with, **50**
 - using, **50**
- expression commands, summary of, **354**
- Expression Display_Value command, **400–402**
- expression elements, **523–529**
- Expression Fprintf command, **403–407**
- Expression Monitor Clear_all command, **408**
- Expression Monitor Delete command, **409**
- Expression Monitor Value command, **410–412**
 - using, **50**
- Expression Printf command, **413–414**
- expression strings, **537**
- expressions
 - changing C variables, **210**
- expressions, forming, **536**
- extend flag @X, **554**
- F**
 - fgetc macro, **566**
 - file
 - comments in command, **239**
 - editing, **208–209**
 - editing at address, **209**
 - editing at program counter, **209**
 - emulator configuration, **287**
 - logging commands to, start, **238**
 - logging commands to, stop, **240**
 - playback command file, **240**
 - File Command command, **415**
 - file commands, summary of, **354**
 - File Error_Command command, **416**

File Journal command, **417**
File Log command, **418–419**
File Selection dialog box operation, **68, 70**
File Startup command, **420–422**
File User_Fopen command, **423–424**
File Window_Close command, **425**
files
 6400tab.net, **632–633**
 absolute, **95–96**
 appending, **97**
 command, **237–246**
 copying demonstration, **41**
 environment dependent, **90**
 journal, **242**
 log, **238**
 macro, **229**
 saving window contents, **145**
 source file location, **94**
 startup, **267**
 state, **118–119**
fill block of memory, **216**
floating point constants, **527**
fopen macro, **567**
foreground monitor, **294, 302, 306, 655**
 types, **302**
foreground monitor limitations to trace, **188**
foreground monitor mapping for MC68030 MMU, **326–328**
fork a UNIX shell, **122**
forming expressions, **536**
FPU support, **149**
frame status character, **154**
Function code for read cycles?, **304**
function key commands, **57**
 list of, **57**
function keys, top row layout, **640**
functions
 breaking on call, **21**
 displaying, **18**
 stepping over, **27**
functions, stepping over, **101**

- H** half-bright video, **259**
- halt program execution on access to a specified memory location, **105**
- halt program execution on instruction at a specified memory location, **107**
- hand pointer, **62**
- hardware
 - HP 9000 memory needs, **620**
 - HP 9000 minimum performance, **620**
 - HP 9000 system requirements, **620**
 - SPARCsystem memory needs, **624**
 - SPARCsystem minimum performance, **624**
 - SPARCsystem minimums overview, **624**
- hardware breakpoints, **105**
- hardware locking, **397**
- help
 - command line, **78**
 - help index, **72**
 - to use, **35**
- help index
 - displaying, **72**
- help window
 - description of, **82**
 - displaying, **82**
- hexadecimal, **252**
- hexadecimal constants, **526**
- high-level program counter @HLPC, **553**
- high-level screen
 - description of, **134**
 - displaying, **136**
- high-level status window
 - moving, **263**
- highlighting, setting, **259**
- Home Key Functions, **144**
- Host_Shell command, **122**
- HP 9000
 - 700 series Motif libraries, **620**
 - HP-UX minimum version, **620**
 - system requirements, **620**
- HP-UX
 - minimum version, **620**
- HP64_DEBUG_PATH file search path, **94**

- I**
 - iconify, **655**
 - identifier, **530**
 - if statement, **224**
 - implicit stack references, **548**
 - Include (debugger status), **84**
 - increase simulated I/O file resources, **179–180**
 - indicator characters, **85**
 - initialized variables
 - re-initializing, **217**
 - InMon (debugger status), **84**
 - Input (debugger status), **84**
 - input scheme, **272, 339**
 - insert lines of C code into your program, **212**
 - install the emulator, **627**
 - installation
 - at a glance, **618–619**
 - SPARCsystem specific instructions, **624–626**
 - instance name, X applications, **335**
 - instance name, X resource, **333**
 - instruction alignment, **392**
 - integer constants, **526**
 - interface, emulator configuration
 - exiting, **289**
 - modifying a section, **286**
 - starting, **285**
 - interfaces
 - emulator/analyzer, **124**
 - interpret keyboard reads as EOF, **176**
 - interrupt mask @I, **553**
 - Interrupt priority level for default foreground monitor?, **304**
 - Interrupt priority level for user foreground monitor?, **304**
 - interrupt stack pointer
 - presetting, **317**
 - interrupt stack pointer @ISP, **553**
 - inverse video, **259**
 - graphical interface demo/tutorial files, **281**
 - Is speed of external clock faster than 25 MHz?, **299**
- J**
 - J indicator character, **85**
 - journal file, **655**
 - journal file option, **242**
 - journal file window, description of, **166**

- journal file, displaying current, **152**
- journal files, **242**
- journal window, description of, **58**
- K**
 - key names, **10–11**
 - key_get macro, **568**
 - key_stat macro, **569**
 - keyboard
 - choosing menu items, **61**
 - keyboard I/O
 - control blocking, **176**
 - cooked mode, **175**
 - interpret keyboard reads as EOF, **176**
 - raw mode, **175**
 - set mode to cooked, **175**
 - set mode to raw, **175**
 - setting mode, **175**
 - simulated I/O processing, **175**
 - keyboard key names, **10–11**
 - keywords, **535**
- L**
 - L indicator character, **85**
 - label scheme, **272, 276, 339**
 - LANG environment variable, **339**
 - level, stack, **115**
 - libraries
 - Motif for HP 9000/700, **620**
 - line numbers, **532**
 - lines in main display area, **274**
 - literals
 - radix, **252**
 - load programs, **95–96**
 - using the db68k command, **95**
 - using the program load command, **95**
 - load symbols, **97**
 - loading and executing programs, **89, 91–128**
 - locking mechanism, emulation, **397**
 - log commands options, **238**
 - log file, **655**
 - log file window, description of, **166**
 - log file, displaying current, **152**
 - log files, **238**

logging
 commands to command file, start, **238**
 commands to command file, stop, **240**

M macro, **655**
Macro (debugger status), **85**
macro arguments, **223**
macro comments, **222**
macro control flow statements
 do, **224**
 else, **224**
 if, **224**
 while, **224**
macro limits
 maximum number of characters on a line, **222**
 maximum number of lines in a macro, **222**
 maximum number of parameters in a macro, **222**
macro local symbols, **531**
macro names, **531**
macro properties, **221**
macro return statements, **224**
macro return values, **224**
macro symbol types, **531**
 macro local symbols, **531**
 macro names, **531**
macro symbols, **531**
macro variables, **223**
macros, **219–246**
 arguments, **223**
 calling, **221**
 calling from an expression, **231**
 calling from within macros, **231**
 calling on execution of a breakpoint, **232**
 calling with debugger macro call command, **230**
 calling with Program Step With_Macro command, **234**
 comments in, **222**
 containing debugger commands, **224**
 copying, **226**
 debugger, **219–246**
 defining, **222, 225–228**
 defining interactively, **225–227**
 defining outside the debugger, **228**

- macros (continued)
 - deleting, **236**
 - dialog box, **225**
 - displaying source code of, **235**
 - do statement, **224**
 - editing, **228**
 - else statement, **224**
 - example of 'when', **359, 363–365**
 - if statement, **224**
 - loading, **229**
 - maximum number of lines in a macro, **381**
 - parameter checking, **255**
 - patching C source with, **211–213**
 - predefined, **555, 557–592**
 - properties of, **221**
 - renaming, **226**
 - return statement, **224**
 - return values, **224**
 - saving, **222, 229**
 - simulated I/O, **556**
 - stopping execution, **235**
 - templates, **226**
 - using with breakpoints, **232**
 - variables in, **223**
 - while statement, **224**
- macros containing debugger commands, **224**
- main(), displaying, **16**
- make windows active, **141**
- making trace measurements, **183–206**
- master stack pointer @MSP, **553**
- master/interrupt flag @M, **553**
- mcc68k
 - See* Microtec
- memchr macro, **570**
- memclr macro, **571**
- memcpy macro, **572**
- memory
 - change configuration, **299**
 - changing, **214**
 - comparing, **216**
 - copying, **215**

- memory (continued)
 - filling, **216**
- memory allocation, **294**
- Memory Assign command, **426–427**
- Memory Block_Operation Copy command, **428**
- Memory Block_Operation Fill command, **429–430**
- Memory Block_Operation Match command, **431–432**
- Memory Block_Operation Search command, **433–434**
- Memory Block_Operation Test command, **435–436**
- memory commands, summary of, **355**
- memory configurations in emulation probe, **310**
- Memory Display command, **437–438**
- Memory Management Unit, **120–121**
- memory map
 - assigning terms, **308**
- memory recommendations
 - HP 9000, **620**
 - SPARCsystem, **624**
- Memory Register command, **439–440**
- Memory Unload_BBA command, **441–443**
- memset macro, **573**
- menu bar, **655**
- menus
 - editing command line with pop-up, **77**
 - hand pointer means pop-up, **62**
 - pull-down operation with keyboard, **61**
 - pull-down operation with mouse, **59–60**
- Microtec
 - compiler, **93**
- middle button, **9**
- MMU, **85, 120–121, 295, 475–476**
 - 68851 not supported, **149**
 - enabling in the MC68030, **300**
- MMU mapping tables modified for map monitor, **327**
- MMU Status Register @MMUSR, **553**
- MMU, mapping 1:1 for use with MC68030, **326–328**
- modify a configuration file, **292**
- Modify debug/trace options?, **320**
- Modify emulator pod configuration?, **316**
- Modify interactive measurement specification?, **325**
- modify memory configuration?, **299**

- modify registers, **217–218**
- Modify simulated I/O configuration?, **324**
- modify variables, **50**
- module names, **545**
- module names, identical, **544**
- monitor, **655**
 - foreground, **294**
 - introduction, **294**
 - select and configure for MC68030, **301**
- Monitor filename?, **304**
- monitor variables, **50**
- monitor window, description of, **163**
- Monitor's base address?, **305**
- monitor, to map 1:1 for use with MC68030 MMU, **326–328**
- more display, **259**
- More prompt, **144**
- Motif
 - HP 9000/700 requirements, **620**
- mouse
 - choosing menu items, **59–60**
- mouse button names, **9–11**
- move assembly-level status window, **264**
- move high-level status window, **263**
- move status window, **263**
- multi-statement debugging, **532**
- multi-window
 - copy-and-paste from entry buffer, **67**
 - copy-and-paste to entry buffer, **64**
- N**
 - names of modules, identical, **544**
 - negative flag @N, **553**
 - next screen, displaying, **137–140**
 - non-printable characters, **528**
- O**
 - objects (C++)
 - displaying member values, **162**
 - open macro, **574–575**
 - operating system
 - HP-UX minimum version, **620**
 - SunOS minimum version, **624**

- operators
 - C, **523**
 - C++ , **524**
 - debugger, **524**
- optimizing modes
 - effects of, **91**
 - using, **91**
- options, **248**
- Output (debugger status), **85**
- overflow flag @V, **553**
- overloaded C++ functions, **110, 146**
- overview
 - installation, **618–619**
- P**
 - paging (screen), **259**
 - parameters
 - checking, **255**
 - patch, **655**
 - patching code
 - See* code patching
 - patching source code, **210**
 - Paused (debugger status), **85**
 - PC register, **124**
 - PITS cycle, **656**
 - platform
 - HP 9000 memory needs, **620**
 - HP 9000 minimum performance, **620**
 - SPARCsystem memory needs, **624**
 - SPARCsystem minimum performance, **624**
 - platform differences, **10–11**
 - platform scheme, **272, 340**
 - playback
 - command file, **240**
 - pod_command macro, **576–577**
 - pointer, **656**
 - pointer to current function @FUNCTION, **553**
 - pointer to current module @MODULE, **553**
 - pop-up menu, **656**



pop-up menus
 command line editing with, 77
 hand pointer indicates presence, 62
 shortcuts, 63
 using, 62

predefined macros, 555, 557–592
 break_info, 558–559
 byte, 560
 close, 561
 cmd_forward, 562–563
 dword, 564
 error, 565
 fgetc, 566
 fopen, 567
 key_get, 568
 key_stat, 569
 memchr, 570
 memclr, 571
 memcpy, 572
 memset, 573
 open, 574–575
 pod_command, 576–577
 read, 578
 reg_str, 579
 showversion, 580
 strcat, 581
 strchr, 582
 strcmp, 583
 strcpy, 584
 stricmp, 585
 strlen, 586
 strncmp, 587
 until, 588
 when, 589
 word, 590
 write, 591–592

predefined windows, 139

printf
 using in debugger, 32

problems, simulated I/O, 181–182

processor

- block target system interrupts, **295**
- disable cache memory, **295**
- enable cache memory, **298**

processor, resetting, **116**

product version, displaying, **152**

program commands, summary of, **356**

Program Context Display command, **444**

Program Context Expand command, **445**

Program Context Set command, **446**

program counter

- presetting, **317**

program counter @PC, **553**

program counter address, run from current, **102**

program counter, resetting, **116**

Program Display_Source command

- description, **447**

program execution

- halt on access to a specified memory location, **105**
- halt on an instruction at a specified memory location, **107**

program execution, controlling, **100–104**

Program Find_Source Next command, **448**

Program Find_Source Occurrence command, **449–450**

Program Load command, **451–453**

Program Pc_Reset command, **454**

Program Run command, **455–457**

Program Step command, **458–459**

program step over, **46**

Program Step Over command, **460–461**

Program Step With_Macro command, **462**

program stepping, **26, 46**

program symbols, **130, 530**

program symbols, symbols on demand, **530**

program variables, resetting, **117**

programs

- loading, **95–96**
- loading using the db68k command, **95**
- loading using the program load command, **95**
- restarting, **116–117**
- run from a specified address, **102**
- run from the current program counter address, **102**

- protrams (continued)
 - run until a specified stop address, **103**
 - running, **100–104**
 - step through, **100**
- pull-down menu, **656**
- pull-down menus
 - choosing with keyboard, **61**
 - choosing with mouse, **59–60**
- pushbutton, **656**
- Q** quick start, **37, 39–52**
 - graphical interface, **3–36**
 - quitting the debugger, **36**
- R** R indicator character, **85**
- radix
 - selecting, **252**
- raw mode, **656**
- re-initialize variables, **217**
- read macro, **578**
- Reading (debugger status), **85**
- recall buffer, **656**
 - initial content, **279**
- recalling
 - commands with command line recall, **81**
 - commands with dialog box, **77**
 - entry buffer entries, **65**
- redirect I/O, **177**
- referencing symbols, **543**
- reformat screens, **262**
- reg_str macro, **579**
- register window, description of, **152**
- registers
 - changing, **217–218**
 - modifying, **124**
- remote control of interfaces, **562**
- remove breakpoints, **111–112**
- remove user-defined screens and windows, **266**
- reserved symbols, **532, 551–554**
 - /dev/simio/display, **174**
 - /dev/simio/keyboard, **174**
 - simulated I/O, **173**

- reserved symbols (continued)
 - stderr, **174**
 - stdin, **173**
 - stdout, **174**
 - Reset map (change of monitor type requires map reset)?, **303**
 - reset processor, **116**
 - reset program counter, **116**
 - reset program variables, **117**
 - Reset value for Interrupt Stack Pointer?, **318**
 - Reset value for Program Counter?, **318**
 - reset vector
 - reset stack pointer, **296**
 - resize windows, **262**
 - resize windows larger than 24 by 80, **651**
 - resize X_windows larger than 24 by 80, **650**
 - resource
 - See* X resource
 - See* X resources
 - resource, X, **270**
 - Respond to target system interrupts?, **317**
 - restart programs, **116–117**
 - restrict to real-time runs?, **297**
 - return statement, **224**
 - return values in macros, **224**
 - root names, **543**
 - root symbol, **544**
 - RS-232 terminals, **638**
 - run from current program counter address, **102**
 - run from reset, **295**
 - run from start address, **102**
 - run programs, **100–104**
 - run until stop address, **103**
- S**
- save file
 - using with emulation, **118**
 - save window and screen settings, **267**
 - scheme file, **656**
 - scheme files, **271**
 - scheme files (for X resources), **336, 338**
 - color scheme, **272, 276, 339**
 - custom, **276, 340**
 - input scheme, **272, 339**

- scheme files (continued)
 - label scheme, **272, 276, 339**
 - platform scheme, **272, 340**
 - size scheme, **272, 339**
- scoping rules, **543**
- screen settings, saving, **267**
- screens, **134**
 - assembly-level, **135**
 - displaying, **134**
 - high-level, **134**
 - predefined, **134**
 - reformatting, **262**
 - standard I/O, **135**
 - working with, **134**
- scroll bar, **7, 17, 656**
- scroll display, **144**
- scrolling, **17**
 - setting amount of, **260**
- sequential usage model, **656**
- server, X, **270, 332, 658**
- session control commands, summary of, **353**
- set control sequences for HP bit-mapped displays, **649**
- set keyboard I/O mode, **175**
- set keyboard mode to cooked, **175**
- set keyboard mode to raw, **175**
- set up control sequences for HP terminals, **649**
- set up control sequences for vt220 terminals, **649**
- settings, **248**
- shell, **655**
 - forking, **122**
- showversion macro, **580**
- simulated I/O, **656**
 - check resource usage, **178**
 - communication with the debugger, **172**
 - connections to host system, **172**
 - control address buffers, **171**
 - description of, **171**
 - disabling, **175**
 - display, **172**
 - enabling, **174**
 - how it works, **171**

- simulated I/O (continued)
 - increase file resource, **179–180**
 - keyboard, **172**
 - keyboard I/O, **175**
 - keyboard I/O processing, **175**
 - macros, **556**
 - problems, **181–182**
 - processing, **172**
 - redirecting I/O, **177**
 - reserved symbols, **173**
 - special symbols, **173**
 - stderr, **177**
 - stdin, **177**
 - stdout, **177**
 - UNIX Files, **172**
 - UNIX processes, **173**
 - user program symbols, **173**
 - using, **171**
- simulated I/O description, **171**
- simulator, **657**
- size scheme, **272, 339**
- skid, **358**
- skipping functions, **27**
- slider, sticky, **657**
- software
 - installation for SPARCsystems, **624–626**
- software breakpoints, **108**
 - defining the vector, **321**
- source code
 - displaying, **146**
 - in assembly display, **255**
 - patching, **210**
- source files, location of, **94**
- source function code @SFC, **553**
- SPA, **657**
- SPARCsystems
 - installing software, **624–626**
 - minimum system requirements overview, **624**
 - SunOS minimum version, **624**
- special casting, **542**

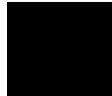

special symbols, simulated I/O, **173**
specify source file location, **94**
specify trace events, **193**
speed setting (step), **253**
stack frames
 display of bad frames, **251**
stack information, using, **115**
stack pointer, **296**
stack pointer @SP, **553**
stack references
 explicit, **549**
 implicit, **548**
stack window, description of, **140**
standard I/O screen
 description of, **135**
 displaying, **137**
standard I/O window, erasing information in, **265**
standard interface, **657**
start
 logging commands to command file, **238**
start a trace, **190**
start address, run from, **102**
start debugger, **13–14, 42**
startup file, **657**
startup file option, **268**
startup file used, displaying, **152**
startup files, **267**
 loading, **268**
state file, **657**
state files, **118–119**
status
 entry on status line, **84**
status line, **7, 657**
status line, description of, **84**
status register @SR, **553**
status window
 moving, **263**
stderr reserved symbol, **174**
stdin reserved symbol, **173**
stdio
 displaying, **137**

- stdout reserved symbol, **174**
- step over functions, **27, 46, 101**
- step speed, setting, **253**
- step through a program, **100**
- stepping, **26, 46**
- sticky slider, **657**
- stop
 - logging commands to command file, **240**
- stop a trace, **191**
- stop address, run from, **103**
- stopping the debugger, **36**
- storage classes
 - automatic, **539**
 - global (extern), **538**
 - local, **539**
 - register, **539**
 - static, **538**
- storage qualification, trace measurement, **186**
- storage qualifier, **657**
- storage qualifiers, specify, **194–195**
- strcat macro, **581**
- strchr macro, **582**
- strcmp macro, **583**
- strcpy macro, **584**
- stricmp macro, **585**
- strlen macro, **586**
- strncmp macro, **587**
- structures
 - displaying members, **161**
- subroutines
 - See* functions
- subwindows
 - activating, **15**
- SunOS
 - minimum version, **624**
- supervisor stack pointer @SSP, **553**
- supervisor state flag @S, **553**
- supported terminals, **637**
- switch between high-level and assembly-level screens, **136**
- switching
 - directory context in configuration window, **288**

- Symbol Add command, **463–465**
- Symbol Browse command, **466**
- symbol commands, summary of, **356**
- Symbol Display command, **467–471**
- symbol evaluation, examples of, **548**
- Symbol Remove command, **472–473**
- symbolic information only option, **97**
- symbolic referencing, **538–550**
- symbolic referencing with explicit roots, **546**
- symbolic referencing without explicit roots, **547**
- symbols
 - assembly code, **254**
 - debugger, **531**
 - demand loading, **98, 252**
 - displaying, **131**
 - evaluating, **547**
 - keywords, **535**
 - legal characters, **530**
 - length, **530**
 - line numbers, **532**
 - loading, **97**

 - macro, **531**
 - program, **530**
 - referencing, **543**
 - reserved, **532**
- symbols on demand, **530**
- symbols, reserved, **551–554**
- symbols, debugger, **130**
- symbols, program, **130**
- system requirements
 - HP 9000 overview, **620**
 - HP-UX minimum version, **620**
 - OSF/Motif HP 9000/700 requirements, **620**
 - SPARCsystem overview, **624**
 - SunOS minimum version, **624**

- T** target program
 - control of emulator interfaces, **562**
- target system
 - disabling interrupts, **317**
 - setting memory access size, **319**

- template, macro, **226**
- TERM environment variable
 - setting, **648**
- TERM variable
 - description of, **637**
- terminal settings table, **638**
- terminals
 - adding configured terminals to HP-UX, **638**
 - configure HP, **641**
 - configuring DEC, **637**
 - configuring for use with debuggers, **637–652**
 - configuring VT100, **643**
 - configuring VT220, **645**
 - RS-232, **638**
 - set control sequences for the VT102, **649**
 - set control sequences for vt220, **649**
 - set up control sequences for HP, **649**
 - supported, **637**
 - TERM settings for, **638**
- token, **653**
- trace, **657**
 - bus width, **392**
 - timing information, **392**
- trace 0 flag @T0, **553**
- trace 1 flag @T1, **553**
- Trace background or foreground operation?, **322**
- trace commands, summary of, **357**
- Trace deMMUer command, **475–476**
- Trace Display command, **477–482**
- trace event, **657**
- Trace Event Clear_All command, **483**
- Trace Event Delete command, **484**
- Trace Event List command, **485**
- Trace Event Specify command, **486–489**
- Trace Event Used_List command, **490**
- trace events, **185**
 - address values, **185**
 - data values, **185**
 - delete, **194**
 - specify, **193**
 - status values, **185**

Trace Halt command, **491**
trace limitations when triggering on C variables, **188**
trace limitations when triggering on instruction fetches, **189**
trace measurement
 access breakpoints, **187**
 address and data values, **185**
 breakpoint interaction, **359**
 complex breakpoint, **202**
 default, **185**
 delete trace events, **194**
 disable storage qualifiers, **198**
 disable triggers, **198**
 display a trace, **192**
 fetch mask, **261**
 foreground monitor limitations, **188**
 halt program on occurrence of trigger, **197**
 limitations, **188**
 limitations when triggering on C variables, **188**
 limitations when triggering on instruction fetches, **189**
 remove storage qualifiers, **198**
 remove triggers, **198**
 specify storage qualifiers, **194–195**
 specify trace events, **193**
 specify triggers, **196**
 start a trace, **190**
 status indicators, **86**
 status values, **185**
 stop a trace, **191**
 storage qualification, **186**
 timing information, **260**
 trace code execution before and after entry into a function, **199**
 trace counts, **260**
 trace data written to variable, **199**
 trace events, **185**
 trace modules, **203–204**
 trace resources, **186**
 trace status, **186**
 trace trigger, **185**
 trace write to a variable, **201**
 trace writer of data, **200**
 what it does, **184**

- trace measurements
 - making, **183–206**
 - trace resources, **186**
 - Trace Start command, **474**
 - trace status, **86, 186**
 - Trace StoreQual command, **492–495**
 - Trace StoreQual Event command, **496–497**
 - Trace StoreQual List command, **498**
 - Trace StoreQual None command, **499**
 - trace trigger, **185**
 - Trace Trigger command, **500–503**
 - and breakpoints, **359**
 - Trace Trigger Event command, **504–506**
 - Trace Trigger List command, **507**
 - Trace Trigger Never command, **508**
 - trace trigger, specify, **196**
 - Translation Control Register @TC, **553**
 - Transparent Translation Register 0 @TT0, **553**
 - Transparent Translation Register 1 @TT1, **553**
 - trigger, **658**
 - TT0/TT1 used to map foreground monitor 1:1, **328**
 - tutorials
 - setting up, **280**
 - type casting, **541**
 - type conversion, **541**
- U**
- unknown module in backtrace window, **155**
 - until macro, **588**
 - use C type print commands, **32, 48**
 - use Expression C_Expression command, **50**
 - use Expression Monitor Value command, **50**
 - use macros with breakpoints, **232**
 - use simulated I/O, **171**
 - user interfaces, **562**
 - User memory access size?, **319**
 - user program symbols
 - simulated I/O, **173**
 - systemio_buf, **173**
 - user stack pointer @USP, **553**
 - user-defined macros
 - See* macros

- user-defined screens
 - defining, **264**
 - displaying, **265**
 - removing, **266**
- user-defined windows
 - defining, **264**
 - erasing information in, **265**
 - removing, **266**
- using macros with breakpoints, **232**
- using simulator and emulator together, **125**

V variables

- breaking on access, **31**
- displaying, **27**
- displaying address of, **30**
- initializing, **217**
- modifying, **210**

variables in macros, **223**
variables, modifying, **50**
vector base address @VBR, **554**
Vector number for software breakpoint (1..7)?, **321**
version (product), displaying, **152**
version numbers, **619**
view information in the active window, **143–144**
view window, description of, **152**
viewing text, **17**
VT100 terminal

- configuration selections for SET-UP A menu, **643**
- configuration selections for SET-UP B menu, **643**
- configuring, **643**
- set control sequences for, **649**

VT220 terminal

- configuring, **645**
- set control sequences for, **649**

W W indicator character, **85**
when macro, **589**

- example, **359, 363–365**

while statement, **224**
widget resource

- See* X resource

window, **658**

Window Active command, **509–510**
window commands, summary of, **357**
Window Cursor command, **511**
Window Delete command, **512**
Window Erase command, **513**
Window New command, **514–516**
Window Resize command, **517**
Window Screen_On command, **518**
window settings, saving, **267**
Window Toggle_View command, **519–520**
window, X, **658**
windows, **139**

- copying to file, **145**
- active, **141**
- backtrace, **115, 153–156**
- breakpoint, **113**
- description of, **139**
- displaying alternate view, **142**
- error, **594**
- help, **82**
- journal, **58**
- journal file, **166**
- log file, **166**
- making active, **141**
- monitor, **163**
- moving, **262**
- predefined, **139**
- register, **152**
- resizing, **262**
- resizing large, **651**
- scrolling, **17**
- setting behavior of, **257**
- stack, **140**
- view, **152**
- working with, **139**

word macro, **590**
words

- changing, **214**

Working (debugger status), **85**
working directory, **658**
workstation

windows (continued)
 HP 9000 memory needs, **620**
 HP 9000 minimum performance, **620**
 SPARCsystem memory needs, **624**
 SPARCsystem minimum performance, **624**
 write macro, **591–592**

- X** X client, **270, 332**
 X resource, **270, 332**
 \$XAPPLRESDIR directory, **337**
 \$XENVIRONMENT variable, **338**
 .Xdefaults file, **336**
 /usr/hp64000/lib/X11/HP64_schemes, **339**
 app-defaults file, **336**
 application-specific, **332**
 class name for applications defined, **335**
 class name for widgets defined, **333**
 command line options, **338**
 commonly modified graphical interface resources, **272**
 Debug.BW, **339**
 Debug.Color, **339**
 Debug.Input, **339**
 Debug.Label, **339**
 Debug.Large, **339**
 Debug.Small, **339**
 defined, **332**
 general form, **333**
 instance name for applications defined, **335**
 instance name for widgets defined, **333**
 loading order, **337**
 modifying resources, generally, **272, 342**
 RESOURCE_MANAGER property, **337**
 scheme file system directory, **339**
 scheme files, debugger's graphical interface, **338**
 scheme files, named, **339**
 schemes, forcing interface to use certain, **340**
 wildcard character, **334**
 xrdb, **337**
 xrm command line option, **338**
 X resources, **331–344, 658**
 X server, **270, 332, 658**
 X window, **658**

X-windows
 resizing large, **650**
X-windows, running on bit-mapped displays, **639**

Z zero flag @Z, **554**

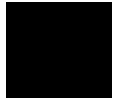

Index



Certification and Warranty

Certification

Hewlett-Packard Company certifies that this product met its published specifications at the time of shipment from the factory. Hewlett-Packard further certifies that its calibration measurements are traceable to the United States National Bureau of Standards, to the extent allowed by the Bureau's calibration facility, and to the calibration facilities of other International Standards Organization members.

Warranty

This Hewlett-Packard system product is warranted against defects in materials and workmanship for a period of 90 days from date of installation. During the warranty period, HP will, at its option, either repair or replace products which prove to be defective.

Warranty service of this product will be performed at Buyer's facility at no charge within HP service travel areas. Outside HP service travel areas, warranty service will be performed at Buyer's facility only upon HP's prior agreement and Buyer shall pay HP's round trip travel expenses. In all other cases, products must be returned to a service facility designated by HP.

For products returned to HP for warranty service, Buyer shall prepay shipping charges to HP and HP shall pay shipping charges to return the product to Buyer. However, Buyer shall pay all shipping charges, duties, and taxes for products returned to HP from another country. HP warrants that its software and firmware designated by HP for use with an instrument will execute its programming instructions when properly installed on that instrument. HP does not warrant that the operation of the instrument, or software, or firmware will be uninterrupted or error free.

Limitation of Warranty

The foregoing warranty shall not apply to defects resulting from improper or inadequate maintenance by Buyer, Buyer-supplied software or interfacing, unauthorized modification or misuse, operation outside of the environment specifications for the product, or improper site preparation or maintenance.

No other warranty is expressed or implied. HP specifically disclaims the implied warranties of merchantability and fitness for a particular purpose.

Exclusive Remedies

The remedies provided herein are buyer's sole and exclusive remedies. HP shall not be liable for any direct, indirect, special, incidental, or consequential damages, whether based on contract, tort, or any other legal theory.

Product maintenance agreements and other customer assistance agreements are available for Hewlett-Packard products.

For any assistance, contact your nearest Hewlett-Packard Sales and Service Office.