

ABSOLUTE BINARY PROGRAM NO. 12962-16001
DATE CODE 1805

HP 79XX/13037 DISC MEMORY DIAGNOSTIC

reference manual

For HP 7905/7906/7920/7925 Disc Drive, 13037A/B Controller and
2100-Series Interface



HEWLETT-PACKARD COMPANY
11000 WOLFE ROAD, CUPERTINO, CALIFORNIA, 95014

MANUAL PART NO. 12962-90001
MICROFICHE PART NO. 12962-90002

Printed: JAN 1978
Printed in U.S.A.

LIST OF EFFECTIVE PAGES

Changed pages are identified by a change number adjacent to the page number. Changed information is indicated by a vertical line in the outer margin of the page. Original pages do not include a change number and are indicated as change number 0 on this page. Insert latest changed pages and destroy superseded pages.

Change 0 (Original) JAN 1978

All pages in this edition are original.

NOTICE

The information contained in this document is subject to change without notice.

HEWLETT-PACKARD MAKES NO WARRANTY OF ANY KIND WITH REGARD TO THIS MATERIAL, INCLUDING, BUT NOT LIMITED TO, THE IMPLIED WARRANTIES OF MERCHANTABILITY AND FITNESS FOR A PARTICULAR PURPOSE. Hewlett-Packard shall not be liable for errors contained herein or for incidental or consequential damages in connection with the furnishing, performance or use of this material.

Hewlett-Packard assumes no responsibility for the use or reliability of its software on equipment that is not furnished by Hewlett-Packard.

This document contains proprietary information which is protected by copyright. All rights are reserved. No part of this document may be photocopied, reproduced or translated to another program language without the prior written consent of Hewlett-Packard Company.

Copyright © 1978 by HEWLETT-PACKARD COMPANY

**Library Index Number
2DIAG.070.12962-90001**

CONTENTS

	Page
BASIC OPERATING PROCEDURE.....	v
Section I	
INTRODUCTION	
General.....	1-1
Required Hardware.....	1-1
Required Software.....	1-2
Diagnostic Limitations.....	1-3
Section II	
PROGRAM DESCRIPTION	
General Organization.....	2-1
Initialization (Diagnostic Configuration).....	2-1
Start.....	2-1
Test Sections.....	2-3
Test Section 1.....	2-3
Test Section 2.....	2-15
Test Section 3.....	2-16
Test Section 4.....	2-17
Test Section 5.....	2-19
Test Section 6 (OPDSN).....	2-19
Error Summary Section.....	2-19
Diagnostic Messages.....	2-21
Execution Time.....	2-22
Section III	
OPERATING PROCEDURE	
Diagnostic Operating Procedures.....	3-1
Preparation For Diagnostic Run.....	3-3
Running the Diagnostic.....	3-3
Using the Diagnostic as a Troubleshooting Aid.....	3-5
Operator Design Procedure (OPDSN).....	3-6
Multiple CPU Testing (MCPU).....	3-8
Operator Instruction List.....	3-8
Helpful Hints.....	3-19
Appendix A	
HALT CODES AND ERROR AND INFORMATION MESSAGES.....	A-1

Appendix B	Page
BIT 2 DIALOGUE.....	B-1
Appendix C	Page
STATUS, OFFSET, AND FILE MASK DEFINITIONS.....	C-1
Appendix D	Page
DIAGNOSTIC ORGANIZATION FLOWCHART.....	D-1

ILLUSTRATIONS

Title	Page
Load/Start Procedure Flowchart.....	3-2

TABLES

Title	Page
Halt Code Summary.....	A-1
Select Code and DMA Channel Option.....	3-3
Diagnostic Switch Register Options.....	3-4

BASIC OPERATING PROCEDURE

The following instructions are basic operating procedures for loading and running the disc diagnostic from paper tape. Refer to the Diagnostic Configurator Reference Manual, part no. 02100-90157, for loading the disc diagnostic from any other media.

Note: When running the diagnostic, use a scratch cartridge/pack if data on the current cartridge/pack is to be saved since all information on the cartridge/pack used may be replaced. Refer to the TS and CP instruction in the OPDSN portion of this manual for saving/restoring data on a fixed surface.

Note: On a 7905/7906 Drive, set the LOWER DISC PROTECT switch if data on the fixed disc is to be saved.

a. Load the Diagnostic Configurator into memory as follows:

(1) For a 2100A/S, load a starting address of X7700 (octal) into the P-register, where:

X = 3 for 16K words of memory

X = 5 for 24K words of memory

X = 7 for 32K or more words of memory

(2) For a 21MX M-Series or 21MX E-Series, set bits 11-6 of Switch Register (clear Switch Register if 2100A/S is used) to the octal select code of the paper tape reader.

(3) Press PRESET (INTERNAL and EXTERNAL).

(4) Press IBL (LDR ENABLE).

(5) Press RUN. The computer should halt with 102077 (octal) displayed in the Display Register, indicating a successful load. Refer to the Diagnostic Configurator Reference Manual for any other halts.

b. Configure the Diagnostic Configurator and load the HP 79XX/13037 Disc Memory Diagnostic into memory as follows:

(1) Load a starting address of 100 (octal) into P-register.

(2) Set S-register to 00XXYY (octal), where:

XX = bits 11-6 = select code of paper tape reader

YY = bits 5-0 = select code of console

- (3) Press PRESET (INTERNAL and EXTERNAL).
 - (4) Press RUN. The computer will halt with 102077 (octal) displayed in the Display Register indicating a successful configuration and load. (A HALT 102022 (octal) indicates an invalid console select code or the console was not ready.)
- c. Configure the diagnostic program as follows:
- (1) Load a starting address of 100 (octal) into the P-register.
 - (2) Set bits 5-0 of Switch Register to octal select code of I/O channel containing the controller interface PCA. Set bit 14 to select DMA channel 7, otherwise DMA channel 6 is the default channel.
 - (3) Press PRESET (INTERNAL and EXTERNAL).
 - (4) Press RUN. The computer will halt with 102074 (octal) displayed in the Display Register, indicating proper select code entered. (A HALT 102073 (octal) indicates an invalid select code was entered above.)
- d. Run disc controller test (short pass), or disc media test (long pass) on unit 0 as follows:
- (1) Power-up drive and load heads, thus ensuring the correct default values for the head table are used in the diagnostic.
 - (2) Load a starting address of 2000 (octal) into the P-register.
 - (3) Set Switch Register to 040141 (octal) (bits 14,6,5, and 0) for short pass, or to 040001 (octal) (bits 14 and 0) for long pass.
 - (4) Press PRESET (INTERNAL and EXTERNAL).
 - (5) Press RUN. Introductory message H0 79XX/13037 Disc Memory Diagnostic is output. If execution is not a restart, message UNIT TABLE: 01 DRIVE(S) 0 followed by H25 WISH TO CHANGE? is output. Respond NO <return> if the unit table is not to be changed. Otherwise, respond YES <return> and change as desired.
 - (6) After completion of a sufficient number of passes, set bit 15 of the Switch Register to halt the diagnostic.

Refer to error messages listed in Appendix A of this manual if errors occur. Refer to section II of this manual if the step where the error occurred is output.

	SECTION
INTRODUCTION	I

1-1. GENERAL

This manual describes the loading and use of the HP 79XX/13037 Disc Memory Diagnostic (hereafter called the diagnostic). The program confirms proper input, output, and control functions for a disc subsystem which includes an HP 7905, 7906, 7920, or 7925 Disc Drive. The diagnostic provides rapid checkout of the controller and exhaustive testing of the drive.

The diagnostic can be executed automatically or manually in which case the operator defines his own tests with console and switch register options.

A maximum of eight drives can be tested sequentially and interaction between drives is also tested. Any combination of 7905, 7906, 7920, and 7925 Drives may be tested at one time.

The diagnostic also tests the drives in a very limited manner in a multiple CPU environment. It does not test more than one controller nor more than one CPU interface at a time. Refer to paragraph 3-6 for further details.

The diagnostic is available on media which includes paper tape, cartridge tape, and disc.

1-2. REQUIRED HARDWARE

The following hardware is required:

- a. An HP 2100A/S, 21MX M-Series, or 21MX E-Series Computer (referred to as "2100-Series") with at least 16K-words of memory and DMA/DCPC.
- b. A disc subsystem consisting of an HP 7905, 7906, 7920, or 7925 Disc Drive, an HP 13037A/B Disc Controller, and an HP 2100-Series Interface PCA.
- c. A program loading device.
- d. A console device.
- e. A line printer (optional).
- f. A punch device (required if paper tape dump routine is used).

Introduction

1-3. REQUIRED SOFTWARE

The following software is required:

- a. The Diagnostic Configurator, absolute binary program, part no. 24296-60001, date coded 1627 or later. Reference Manual, part no. 02100-90157.
- b. HP 79XX/13037A/B Disc Memory Diagnostic, absolute binary program, part no. 12962-16001.

The diagnostic serial number (DSN) for this diagnostic is 151403 (octal) and is contained in memory location 126 (octal).

1-4. DIAGNOSTIC LIMITATIONS

Unexpected interrupts form a special class of errors; no message is output. The interrupts are a result of an interrupt on an I/O select channel not being used by the diagnostic. Each interrupt trap cell contains 1060XX (octal), where XX is the trap location. Analysis of these errors is beyond the scope of this diagnostic. No recovery mechanism is provided.

Interface capability for receiving, passing, and denying interrupt priority (priority string logic) is not usually tested by the diagnostic. A partial test of this is to remove an interface of a lower select code than that of the controller interface and run the diagnostic. The interface will not receive priority on an interrupt and error message E6 NO INTERRUPT will be output.

Whenever the heads load on any unit while running the diagnostic, except in test section 1, step 15, an unexpected interrupt will occur (the controller channel flag on the interface is set). This interrupt is not expected by the diagnostic and is reported as an error. The error message that results and the number of errors output depend on what the diagnostic is doing at the time of the unexpected interrupt.

Note: Step 15 expects the heads to load, thus an error is not reported.

Whenever PRESET is pushed (PRESET sends a clear command to the controller when jumpers are placed to allow it), the controller will cause an unexpected attention, except in test section 1, step 20.

The controller function "Load TIO Register" is not tested since it is not used in the 2100-Series environment.

All STATUS-1 and STATUS-2 word indications are forced except for the following:

I/O program error

Access not ready during data operation

Drive fault

PROGRAM DESCRIPTION	SECTION II
---------------------	---------------

2-1. GENERAL ORGANIZATION

The diagnostic is divided into four areas:

- * Initialization (Diagnostic Configuration)
- * Start
- * Test Sections
- * Error Summary

The test sections are divided into steps which describe tests performed by the diagnostic. A list of possible causes for errors that occur, during that particular step, are given immediately following each step.

The following paragraphs give a detailed description of each area. See Appendix D for a flowchart of the diagnostic organization.

2-2. INITIALIZATION (DIAGNOSTIC CONFIGURATION)

The initialization (INIT) area configures the diagnostic by ensuring that all I/O instructions contain the appropriate select code for the controller interface and determines which DMA/DCPC channel has been selected. The operator enters the controller select code (bits 5-0) and DMA channel identification (bit 14, clear for DMA channel 6 and set for DMA channel 7) into the Switch Register in the diagnostic configuration sequence.

The diagnostic uses the INIT area as a write buffer during execution if only 16K of memory is available. Thus the diagnostic must be reloaded before reconfiguration can be accomplished if any writes have been attempted to the disc during the current diagnostic run. If more than 16K of memory is present the diagnostic does not have to be reloaded before reconfiguration.

Note: Reconfiguring is required only if the controller interface is moved to a different I/O select code or a different DMA/DCPC channel is to be used.

2-3. START

The entire START area is considered as step zero. The START area of the diagnostic performs the following:

- a. Outputs the preamble (H0 79XX/13037 DISC MEMORY DIAGNOSTIC).

Program Description

- b. Initializes trap cells by placing 1060XX (XX = trap cell location) in location 2 through 77 (octal). When an interrupt occurs on an I/O select code channel not used by the diagnostic, a halt 1060XX occurs. The value in the P-register is the memory address in the diagnostic at the time of the interrupt. The diagnostic is in need of repair and should be reloaded if the value in the P-register is equal to XX plus one for a halt 1060XX. If the halt is 106005 the problem is probably due to either a parity error or a memory protect violation. To determine which of the two problems it is, place 102505 (octal) (LIA 5) into memory location 5. Set the P-register equal to 000005 and press RUN. The computer should halt with 106006 displayed. A parity error is implied if bit 15 of the A-register is set, otherwise, a memory protect violation occurred. Bits 14-0 of the A-register indicate the address of the location in error. (A memory protect error probably indicates a CPU hardware error since the diagnostic does not use the memory protect feature.)
- c. Initializes variables used in the diagnostic.
- d. Tests the FIFO (First-In First-Out) buffer on the interface card by issuing a clear command from the interface to the controller. If the command is accepted and acknowledged correctly, the FIFO counter on the interface is reset and the FIFO test begins. If the command is not accepted, an E103 DISC SUBSYSTEM DOES NOT RESPOND message is output. See Appendix A for possible causes of these errors. The FIFO test consists of entering numbers from -(N-1) to zero, where N = the number of levels in the FIFO. This number is determined by the diagnostic and will be either three or 16, depending on the revision of the interface card used. Values are then read back from the FIFO and checked to determine that they are the correct values. If an error occurs message E127 INTERFACE FIFO MALFUNCTION is output indicating a bad FIFO or FIFO counter on the interface card.
- e. Tests the ability of the CPU to set and clear the controller channel flag on the disc interface card.
- f. Performs a screen test (sets channel flags on all other channels from 10 thru 77 (octal) except that of the disc controller and determines if the controller channel flag is affected).
- g. Tests interrupt operation of the disc interface card, but does not test the interrupt chain. The interrupt system is temporarily turned on, but is not used at any other time during the diagnostic.
- h. Clears attention on all drives and waits for all units to be ready, which is indicated by the two least significant bits of the STATUS-2 word from each unit.
- i. Requests status from all possible units to determine the drive type and status of each drive.

- j. Issues a seek to units that are ready and an address record to all others in order to clear any seek status that the drive might have.
- k. Performs bit 2 dialogue if Switch Register bit 2 is set. Bit 2 dialogue outputs message H140 ENTER:(U)NIT,(?)ERRS,(H)EAD,(O)UTPUT,(P)ATT,(S)OFT,(C)YL,(M)CPU,(E)XIT and allows the operator to change the areas specified. Exits bit 2 dialogue when (E)XIT is typed in response to message H25 WISH TO CHANGE?. (Refer to Appendix B, BIT 2 DIALOGUE for more information.)
- l. Branches to operator design (OPDSN, test section 6) area of the diagnostic if Switch Register bit 3 is set. The OPDSN area allows the operator to write his own programs to test portions of the disc subsystem. (Refer to paragraph 3-5 for further details.)
- m. Checks that the first unit listed in the unit table is present.
- n. Controls test section execution and outputs the pass message.

2-4. TEST SECTIONS

The following paragraphs describe the six test sections in the diagnostic.

2-5. TEST SECTION 1. This section of the diagnostic tests controller functions by performing short writes and reads, and executes the interactive tests (steps 3 thru 20) when Switch Register bit 4 is set. The interactive tests check operations that relate to pack addressing and tests the front panel switches on the drive. The tests occur in the following sequence:

STEP	DESCRIPTION
1	Gets and checks status for zero to ensure that a normal complete is returned and that no unexpected status conditions occurred.
2	Issues a recalibrate to the drive to ensure that the heads are positioned correctly. Check the following for possible cause of errors: <ul style="list-style-type: none"> a. Servo board b. Track follower board

Note: Skip to step 21 if Switch Register bit 4 is clear.

Program Description

3 Asks operator to set drive FORMAT switch (FORMAT switch may already be set). Checks to see that FORMAT bit (STATUS-2 word, bit 5) is set. Check the following for possible cause of errors:

- a. Drive format switch
- b. Harness
- c. I/O sector board
- d. Data cable may not be properly attached if WAC fault results.
- e. Preamp
- f. Drive control board
- g. Mother board

4 Writes one track of random data on cylinder zero. Sets protect bit in preamble of each sector. Reads the last sector written on the track and compares it against the values written onto it. Verifies all the sectors on the track. Check the following for possible cause of errors:

- a. If 7905 and heads 0 and 1, and weak upper index pulse:
 - (1) Transducer clearance too great
 - (2) Transducer may be weak or faulty
 - (3) I/O sector board
- b. If 7920 or head 2 of 7905, may be the track follower board. Execute the following OPDSN program to verify this:

SK,X	Seek to cylinder X.
RF	Read a full sector.
DR,0,2	Display Read Buffer words 0, 1, 2.
LP	Loop on program.

The expected result is: 0000: 100376 CYL HD/SEC

where 100376 = sync word, CYL = X, and the HD/SEC = the head and sector addressed by the seek. This result should be the same on all lines. To halt the program, toggle Switch Register bit 3.

- 5 Writes one track of random data on cylinder one with the defective cylinder bit in the preamble set. Attempts to read the track in step 7.
- 6 Asks operator to clear drive FORMAT switch. Checks to see that FORMAT switch bit (STATUS-2 word, bit 5) is clear. Bit 5 set indicates the switch may be defective. Check the drive FORMAT switch for possible cause of errors.
- 7 Reads last sector of cylinder one which was written in step 5 and checks for the defective track indication in the STATUS-1 word. (STATUS-1 word is 0304XX (octal), where XX = unit number of the current drive.)
- 8 Attempts to write on cylinder zero and checks the STATUS-1 word for an indication of an attempt to write on a protected track. This track was flagged protected in step 4. (STATUS-1 word is 0530XX (octal), where XX = unit number of current drive.)
- 9 Seeks to cylinder zero and issues an initialize data command to the controller. Before executing the command, the controller checks to see that the drive FORMAT switch is set and the drive PROTECT or the READ ONLY switch is clear. The FORMAT switch is off (operator should have cleared it in step 6) and a STATUS-2 error should be returned from the controller to the diagnostic as the termination status in the STATUS-1 word. Any other status will result in an error message being output.
- 10 Asks operator to set drive FORMAT switch. Writes random data on cylinder zero and checks that the write attempt on the protected track with the FORMAT switch set is possible.
- 11 Initializes each track that is accessed by any of the heads in the head table for the unit specified. Each track initialized in this step is verified in step 12 before the next track is initialized.
- 12 Verifies each track initialized in step 11.
- 13 Asks operator to place drive RUN/STOP switch in STOP position.
- 14 Checks STATUS-2 word from the drive for attention, not-ready, and busy bits (bits 7, 1, 0, respectively) set. Issues a seek to check that the controller sets the controller channel flag on the interface card immediately if the disc drive is not ready. This step reports a status error when looped. Check the I/O Sector board for possible cause of errors.

Program Description

- 15 Asks operator to place RUN/STOP switch in the RUN position. Clears controller channel flag on the interface card and waits for the controller to set it. Requests STATUS-2 word from the drive and checks that bit 3 of the STATUS-2 word (first status) is set indicating the heads have been loaded. Check the Drive Control board for possible cause of errors.
- 16 Asks operator to set the drive READ ONLY switch if the current unit is not a 7905 or 7906 Drive, otherwise set UPPER/LOWER DISC PROTECT switch to correspond with the heads which are in the head table for the unit specified. (Steps 16 thru 19 are repeated if all heads are selected and if the unit specified is a 7905 or 7906 Drive.) Check the following for possible cause of errors:
- a. Harness
 - b. I/O Sector board
- 17 Performs a seek operation to cylinder zero and requests status from the drive. Checks for protect bit (STATUS-2 word, bit 6) set. The protect bit should be set from step 16. The UPPER/LOWER DISC PROTECT switch on a 7905 or 7906, or the READ ONLY switch on a 7920 or 7925 is probably defective in case of errors.
- 18 Attempts to write data on the disc and checks that data was not transferred. Checks for STATUS-2 error. See step 17 for possible cause of errors.
- 19 Asks operator to clear appropriate drive DISC PROTECT (7905 or 7906) or READ ONLY (7920 or 7925) switch. See step 17 for possible cause of errors.
- 20 Sets file mask to cylinder mode and asks operator to press PRESET. If the PRESET functions properly and the computer interface jumper is set correctly (i.e., so that pushing PRESET will cause the controller to reset), the controller will be reset and the file mask in the controller will be set to zero indicating the drive is in surface mode rather than cylinder mode. This is checked by writing two sectors starting at the last sector on a track and checking the status for an end of cylinder indication (STATUS-1 word is 006000 (octal)). Errors during this step may be the result of a defective PRESET switch or the preset jumpers may be set incorrectly. Check the following for possible cause of errors:
- a. See that interface jumper is positioned such that PRESET, when pressed, issues a CLEAR command to the controller.
 - b. Defective PRESET switch
 - c. Device Controller board

21 Seeks to cylinder zero. After the seek is complete, seeks to the last cylinder on the unit specified. Checks that the busy bit (STATUS-2 word, bit 0) is set. The check occurs approximately 2 msec after the seek is issued to the last cylinder. (The busy bit should be set since the head positioner on the drive should still be seeking to the last cylinder.) Check the following for possible cause of errors, if the head positioner moves, but the busy bit is clear:

- a. Device Controller board
- b. I/O Sector board
- c. Drive Servo board

Check the following for possible cause of errors, if the arm does not move:

- a. I/O Sector board
- b. Drive Servo board

22 Issues a recalibrate from the last cylinder. Check the following for possible cause of errors:

- a. Seek times too fast as set on the drive Servo board
- b. Track Follower board
- c. Drive Servo board
- d. A faint high pitched sound may indicate a faulty coil.
- e. Carriage (linear motor) problems
- f. Servo code on servo service

23 Seeks to the following illegal disc addresses and issues a status command after each seek to check that the seek check bit (STATUS-2 word, bit 2) is set.

DRIVE	CYLINDERS	HEAD	SECTOR
7905	411/414/442/474	3	48
7906	411/414/442/474	---	48
7920	823/830/886/950	5	48
7925	823/830/886/950	9	64

Check the Drive Servo board for possible cause of errors, if the carriage moves and crashes into the crash stops.

Check the following, if the carriage does not move:

- a. I/O Sector board
- b. Error Correction Code (ECC) board

Program Description

- c. Device Controller board
 - d. Microprocessor
 - e. Interface card
- 24 Seeks to the first entry in the cylinder table and writes one sector of random data at sector zero. This data is read in steps 26 and 36. This is the first write performed in the diagnostic if Switch Register bit 4 is clear. Check the following for possible cause of errors:
- a. Reformat the cartridge/pack.
 - b. HD/SEC compare errors may indicate a defective data cable.
 - c. WAC fault indicates the data cable is not connected or a defective head
 - d. Drive control
 - e. Preamp
- 25 Writes two sectors beginning at sector 7 of the same track as in step 24.
- 26 Reads one sector at sector zero and compares against data that was written in step 24.
- 27 Reads two sectors beginning at sector 7 and compares against data that was written in step 25. The read without verify command is used. (This step is skipped if this cylinder is flagged defective or spare and Switch Register bit 0 is set.)
- Note: Skip to step 31 if heads 0 and 1 are not in the head table for the unit specified.
- 28 Issues a set file mask to the controller to select cylinder mode in the drive. Write four sectors beginning at sector 45, head 0, and the first cylinder in the cylinder table. If a status check reveals an end of cylinder error, it is probable the set file mask command failed, or the file mask flip-flop in the controller, which designates cylinder mode, is not functioning properly. Check the Device Controller board for possible cause of errors.
- Note: Skip step 29 if all heads for the unit specified are not in the head table.

- 29 Verifies the sectors listed below. Each group starts at cylinder, head, and sector zero. An end of cylinder (STATUS-1 word, bits 11 and 10 set) from the controller should be indicated only for the EOC sectors listed. (Cylinder mode was set in step 28.)

DRIVE	SECTORS VERIFIED	EOC
7905	1/2/4/8/16/32/64/128/144/145	145
7906	1/2/4/8/16/32/64/128/192/193	193
7920	1/2/4/8/16/32/64/128/240/241	241
7925	1/2/4/8/16/32/64/128/432/433	433

Check the Device Controller board or the ECC board for possible cause of errors.

- 30 Reads the four sectors written in step 28 and compares the data read against that which was written.
- 31 Writes and then reads one sector beginning at sector 7 with DMA/DCPC off. A data overrun error will occur on both the read and the write which is indicated by STATUS-1 word, bits 11, 10, and 9 set. Check the following for possible cause of errors:
- Computer interface card
 - Device Controller board

Note: Skip step 32 if the last head for the unit specified is not in the head table.

- 32 Write four sectors of random data beginning at sector 45 on the last head for the cylinder. Checks status for an end of cylinder condition (STATUS-1 word, bits 11 and 10 set).
- 33 Issues illegal commands to the controller. Checks status for an illegal op code indication (STATUS-1 word, bit 8 set). Check the following for possible cause of errors:
- Device Controller board
 - Microprocessor
 - ECC board
 - Computer interface card

Note: Skip step 34 if the last head for the unit specified is not in the head table.

- 34 Reads four sectors beginning at sector 45 on the last head for the cylinder. Checks status for an end of cylinder condition (STATUS-1 word, bits 11 and 10 set). Data in sectors 45, 46, and 47 is compared against that written in step 32.

Program Description

- 35 Checks the first cylinder in the cylinder table and verifies that sector addresses on each sector of the track are correct for each head in the head table for the unit specified. Check the following for possible cause of errors:
- a. I/O Sector board
 - b. Microprocessor
- 36 Seeks to the last cylinder available (cylinder zero if first entry in cylinder table is the last cylinder) then issues a seek to the first entry in the cylinder table and immediately follows this with a Read command without waiting for the flag to be set on the controller channel. The controller should see a command waiting for it as it is about to set the flag on the controller interface card. Instead of setting the flag, the controller should take the Read command waiting on the controller interface and execute it. The flag on the interface should not be set until the Read command is complete. The data read is compared against that written in step 24. Check the following for possible cause of errors:
- a. Device Controller board
 - b. Computer interface card

Note: Skip step 37 if heads 0 and 1 are not in the head table.

- 37 Tests the time-out timer in the controller. The first part of the test sets the file mask in the controller to cylinder mode and waits one second. The controller will not poll after receiving the set file mask command. The diagnostic then writes two sectors beginning at the last sector of a random track and checks that a normal status is returned indicating the timer did not time-out and that the file mask was not reset.
- The second part of the test sets the file mask in the controller to cylinder mode and waits 2.8 seconds. The controller will not poll after receiving the set file mask command and should time-out after the 2.8 seconds. The file mask in the controller is reset when the time-out occurs, which puts the controller back into surface mode. Following the wait, the diagnostic writes two sectors beginning at the last sector of a random track and checks that an end of cylinder condition is returned indicating the timer timed-out and the file mask was reset. Check the following for possible cause of errors:
- a. Device Controller board
 - b. Incorrect configuration of Diagnostic Configurator. Bits 15-12 of memory location 115 (octal) should be as follows:

0111 for 2100A/S

1000 for 21MX M-Series

1001 for 21MX E-Series

Note: Skip to step 45 if the SPD (spare, protect, and defective) field of either of the first two entries in the cylinder table do not equal zero, or if the drive FORMAT switch is off.

Note: Skip to step 39 if the first two entries in the cylinder table are equal and the SPD field equals zero and the FORMAT switch is on.

38 Forces cylinder compare error. Performs a Read Full Sector at sector zero of the second entry in the cylinder table. Writes the full sector read onto sector zero of the first entry in the cylinder table. Reads sector one of the first entry in the cylinder table. Since the controller verifies the sector immediately preceding the sector to be read, a cylinder compare error (STATUS-1 word, bits 10, 9, and 8 set) should occur (an incorrect cylinder address was placed into sector zero). The cylinder address in sector zero is corrected before proceeding to the next step. Check the following for possible cause of errors:

- a. Device Controller board
- b. Microprocessor

39 Forces a head-sector compare error with a bad sector address. Performs a Read Full Sector at sector one of the first entry in the cylinder table. Writes the full sector read onto sector zero of the same cylinder. Reads sector one of the first entry in the cylinder table. Since the controller verifies the sector immediately preceding the sector to be read, a head-sector compare error (STATUS-1 word, bits 11 and 8 set) should occur (an incorrect sector address was placed into sector zero). The sector address in sector zero is corrected before proceeding to the next step. Check the following for possible cause of errors:

- a. Device Controller board
- b. Microprocessor
- c. I/O Sector board
- d. Track Follower board

Note: Skip to step 41 if heads 0 and 1 are not in the head table.

Program Description

- 40 Forces a head-sector compare error with a bad head address. Performs a Read Full Sector at sector zero, head one of the first entry in the cylinder table. Writes the full sector read onto sector zero, head zero of the first entry in the cylinder table. Reads sector one, head zero of the first entry in the cylinder table. Since the controller verifies the sector immediately preceding the sector to be read, a head-sector compare error (STATUS-1 word, bits 11 and 8 set) should occur (an incorrect head number was placed into sector zero). The head number in sector zero is corrected before proceeding to the next step. Check the following for possible cause of errors:
- a. Drive preamp
 - b. Drive Control board
 - c. I/O Sector board
- 41 Forces a correctable data error. (The error correction circuitry will correct up to a 32-bit burst error (i.e., the distance between any two bits in error is less than or equal to 32 bits) in each sector.) Reads two full sectors from the first entry in the cylinder table. Selects a random location N ($0 < N < 255$) in the buffer of the first of two consecutive words to be modified. Replaces these two words with two random words which are different from those originally there. Writes into the two sectors read from with a Write Full Sector of 278 words. Reads the same two sectors. Checks status for a possibly correctable data error (STATUS-1 word, bits 11, 10, 9, and 8, set). Checks that the syndrome returned would correct the error. (The syndrome returns seven words from the error correction circuitry to correct the data error.) The sectors are corrected before proceeding to the next step. Check the following for possible cause of errors:
- a. ECC board
 - b. Microprocessor
- 42 Forces an uncorrectable data error (an error not correctable by the error correction circuitry). This step is basically the same as step 41 except four consecutive words in one of the two sectors are replaced by random words. Checks status for an uncorrectable data error (STATUS-1 word, bit 11, set). Check the following for possible cause of errors:
- a. ECC board
 - b. Microprocessor
- Note: Skip to step 45 if the two tracks selected in step 43 are equal, or if the SPD field of either track is not zero.

43 Tests sparing. Selects two random tracks A and B. Sets file mask to surface mode, no spare and no auto seek. Initializes track B defective with address A. Initializes track A spare with address B. Verifies track B (should be defective). Verifies track A (should get illegal access to spare track). Sets file mask to surface mode, sparing, and no auto seek. Writes a random sector through defective track B to spare track A. Reads back and checks. Sets file mask to surface mode, no spare, and no auto seek. Initializes track B. Reads from track A using false B address and checks data. Initializes track A. Check the following for possible cause of data errors:

- a. Device Controller board
- b. Microprocessor
- c. ECC board

45 Forces unit unavailable status. Issues a seek to unit 11. Checks status for a unit unavailable status (STATUS-1 word, bits 12, 10, 9, and 8, set). Check the following for possible cause of errors:

- a. New firmware (dated after 9/70) used with a diagnostic dated before 9/70.
- b. Microprocessor

Note: Skip to step 47 if unit specified is not equal to zero, or if cylinder zero on the selected head is defective, or if all the heads for a 7905 are not in the head table, or if heads 0, 1, 2, 3 for any other type drive are not in the head table.

46 Tests cold load read on unit zero. Selects a random cylinder from the drive, or if Switch Register bit 6 is set, selects a random cylinder from the cylinder table. Selects a random head (0-3) from the head table and selects a random sector. Reads from cylinder zero and the head and sector selected above. Seeks to the cylinder selected above. Issues a Cold Load Read to the selected head and sector. Compares the two buffers to check that data read is the same in both instances.

Note: Skip to step 47 if both heads 0 and 1 are not in the head table.

The Cold Load Read resets the file mask to spare enable, incremental seek not allowed, and surface mode. Reads two sectors beginning at the last sector of the track. Checks for an end of cylinder condition (STATUS-1 word, bits 11 and 10, set). Check the following for possible cause of errors:

- a. Device Controller board

Program Description

b. Microprocessor

c. ECC board

Note: Skip to step 48 if cylinder table (0) does not equal cylinder table (1) minus 1.

47 Sets the file mask to surface mode, no spare, and increment. Writes two sectors at sector 47, cylinder table (0). Reads back and verifies. Reads second sector only and verifies (only if cylinder table (0) is not defective, or spare and Switch Register bit 0 is set). Sets file mask to surface mode, no spare, and decrement. Writes two sectors beginning at sector 47, cylinder table (1). Reads back and verifies. Reads second sector only and verifies (only if cylinder table (1) is not defective, or spare and Switch Register bit 0 is set). Check the following for possible cause of errors:

a. Device Controller board

b. Microprocessor

48 Checks the disc address on a random sector by issuing a Request Sector Address after seeking to a random sector and checking that the head sector address returned is the same as that to which the seek was issued. Uses reads with cylinder offset = 350 microinches, cylinder offset = -350 microinches, clock delay = 10 nanoseconds, and clock advance = 10 nanoseconds. For ACCESS NOT READY DURING DATA OPERATION or CYLINDER COMPARE ERROR, check the following:

a. Servo board

b. Track follower

c. I/O Sector board

Check the following for possible cause if data errors occur:

a. Current cartridge/pack previously formatted on misaligned drive

b. Device Controller board

c. Preamp

d. Drive Control board

2-6. TEST SECTION 2. This section writes and reads back patterns checking for bad packs, or marginal heads. The tests occur in the following sequence:

Note: The steps in test section 2 are performed for each pattern in the pattern table. The direction to follow through the cartridge/pack or cylinder table (if Switch Register bit 6 is set) is reversed between each pattern.

STEP	DESCRIPTION
55	Selects next cylinder on the cartridge/pack or in the cylinder table according to bit 6 of the Switch Register. (Only uses the twelve cylinders in the cylinder table for bit 6 set. Uses all the cylinders on the cartridge/pack for bit 6 clear.) Performs a seek operation.

Note: Skip to test section 3 if Switch Register bit 5 is set.

Note: Execute steps 56 and 59 for each head selected before selecting the next cylinder in step 55.

56 Writes a given pattern, derived from the pattern table onto a track. (See Appendix B, (P)ATT.)

59 Reads the track written in step 56. Compares the pattern read against the pattern from the pattern table. A read with offset = 350 microinches is used initially (normal read on any retries) for the ninth pattern. A read with offset = -350 microinches is used initially (normal read on any retries) for the tenth pattern. Check the following for possible cause of errors:

- a. Device Controller board
- b. Preamp
- c. Drive Control board
- d. Noisy track follower
- e. Servo board if the single cylinder seek time is greater than 5.2 milliseconds.
- f. Power board (7905/7906) or PMR (7920/7925)

Note: Return to step 55 until all cylinders to be tested have been tested for all ten patterns.

Program Description

Note: Timing message giving the average single cylinder seek time is output if Switch Register bit 12 is set.

In general, the following are possible causes of errors which may occur in test section 2:

- a. A faulty head will usually cause errors on the high numbered tracks.
- b. The preamp may cause random data errors for a particular head, however all the heads may be faulty.
- c. The Drive Control board may cause random data errors on any head.
- d. Repeated data errors on a specific cylinder, head, and sector indicate a bad spot on the media. If errors occur on all the heads a defective servo code (needs re-servo formatting) is indicated.
- e. A WAC fault may indicate any part (boards, data cable, heads, etc.) in the write path circuitry is faulty, and is probably heat sensitive.
- f. A Timeout fault may indicate a heat sensitive power board.

2-7. TEST SECTION 3. This section writes and reads back random data from random locations to check seek and data transfer operations. The random location includes a head randomly selected from the head table. A cylinder number is randomly selected from the cylinder table for Switch Register bit 6 set and from the drive for bit 6 clear. The tests occur in the following sequence:

Note: Perform steps 70 through 72, 1024 times (64 times if Switch Register bit 5 is set).

STEP	DESCRIPTION
70	Seeks to a random cylinder, head, and sector. Generates a random word count between 1 and 1023. Checks the word count and ensures (by continually reducing the word count by a factor of 2) that a write of this magnitude will not exceed the end of the cylinder. A buffer of random data of this length is now generated.

- 71 Writes the buffer of random data and random length into the random locations chosen in step 70.
- 72 Reads and compares against data written in step 71. Word count is incremented if sector fill was necessary on write in step 71. Check the following if errors concerning cylinder, head, and sector information, occur:
- a. Servo board
 - b. Track Follower board
 - c. Servo head lead
 - d. Inspect the Servo code
- Check the following if data errors occur:
- a. Device Controller board
 - b. Computer interface card

In test section 3, AGC faults may be caused by the Track Follower board, or by the Servo board.

2-8. TEST SECTION 4. This section fills the pack full of checksummed data and checks the checksum of the cylinder, head and sector number. Each sector is checksummed separately. The entire sector sums to zero. The first two words sum to the cylinder number. The next two words sum to the head/sector number.

Note: Use all cylinders on the cartridge/pack if Switch Register bit 0 is clear and use the twelve cylinders in the cylinder table if bit 0 is set.

STEP	DESCRIPTION
75	Seeks to the next cylinder according to Switch Register bit 0.
76	Generates a buffer of checksummed data and writes the checksummed random data onto the entire track. Note: Execute steps 79 and 80 only when the current cylinder also occurs in the cylinder table and the current head is head 2.

Program Description

79 Reads sector zero with offset = +63 (decimal). Checks only the STATUS-2 word to ensure a drive fault did not occur. Check the track follower for possible cause of errors.

80 Read sector 33 with offset = -63 (decimal). Checks only the STATUS-2 word to ensure a drive fault did not occur. Check the track follower for possible cause of errors.

Note: Return to step 76 until all heads in the head table have been selected. Then return to step 75 to select a new cylinder until all cylinders have been selected.

Note: Data is accumulated to calculate average random cylinder seek time if Switch Register bit 12 is set in steps 81 and 82 and if Switch Register bit 5 is clear.

Note: Steps 81 and 82 are repeated 8192 times (256 times if Switch Register bit 5 is set).

81 Seeks to a random cylinder, head and sector according to Switch Register bit 6.

82 Reads and verifies checksummed data of one sector for the cylinder, head, and sector written in step 76. Check the following if an error concerning cylinder, head, and sector information occurs:

- a. Servo
- b. Track follower
- c. Servo head lead
- d. Inspect Servo code

Check the following if data errors occur:

- a. Device Controller board
- b. Computer interface card

In test section 4, AGC faults may be caused by the Track Follower board or the Servo board. Seek errors are likely to happen here if the Servo board has heat sensitive counting problems.

2-9. TEST SECTION 5. This section runs multiple unit test if at least two units are present and no errors occurred for any unit in test section 4. The multiple unit test is not run until each unit under test has run through test section 4.

STEP	DESCRIPTION
85	Checks overlapping seeks by issuing seeks to random locations on each drive present, one after another. As the seek is completed, the data read is checked as in step 82 to ensure the checksums agree with those written in step 76. (See step 81 for selection of the random locations.) Possible cause of errors is the RAM on the device controller.

Errors only in test section 5 may indicate faulty multi-unit hook-up.

STEP 90 ↓

2-10. TEST SECTION 6 (OPERATOR DESIGN). This section of the diagnostic is not part of the standard sequence of tests and must be specifically selected to execute. This section allows the operator to write special test routines to test specific drive functions and to perform multiple CPU testing. Set Switch Register bit 3 to enter this section. (Refer to paragraph 3-5 for detailed operator design procedures.)

2-11. ERROR SUMMARY SECTION

The Error Summary section is used after the diagnostic has run. To enter this section, load a starting address of 16000 (octal) into the computer P-register and press RUN. Error summary data is output followed by a halt 77 (octal). (Pressing RUN at this time will clear the error summary data and will cause a branch to memory location 2000 (octal) and the diagnostic will begin execution.) The following is an explanation of what the Error Summary section will output and an explanation of the sample output listed at the end of this paragraph. The Error Summary section will output the following:

- a. Dumps the cylinder/head table. This table consists of up to 150 different cylinder/head combinations on which data errors occurred, and gives the number of errors which occurred at each cylinder/head combination. Only those cylinders with errors are dumped (cylinders 734, 761, and 768 of the example are shown). Only the first 150 cylinder/head combinations are recorded due to memory space limitations, however this is adequate for any cartridge/pack which meets specifications. The number of data errors which occur for the 151 and greater cylinder/head pairs are accumulated and output as being the "OVERFLOW" amount. The total number of both data errors and non-data errors (i.e., NO FLAG, ACCESS NOT READY), which have occurred since the diagnostic was last started by setting the P-register to 2000 (octal), are output as the "ALL ERRORS". Each line dumped shows all data errors made on a particular cylinder

Program Description

- b. Dumps the head/sector table. This table consists of up to 150 different head/sector combinations on which data errors occurred, and gives the number of errors which occurred at each head/sector combination. Only those sectors with errors are dumped (head 0, sectors 24 and 26, and head 4, sector 0 in the example). Only the first 150 head/sector combinations are recorded. The number of errors which occur for the 151 and greater head/sector pairs are accumulated and output as the "OVERFLOW" amount.
- c. Dumps the head/unit table. This is a 5 by 8 matrix. All data errors since the diagnostic was started are shown. Lines which show no errors are suppressed. Only those heads that had errors are shown. (The head number is followed by an E.)
- d. Dumps a line showing fatal errors. These are shown by the unit which was running when the error occurred.
- e. Dumps a line showing the number of long passes completed for each unit.
- f. Dumps a matrix showing the number of usable tracks for each head. Lines which show no use (head not selected) are suppressed. (The head number is followed by a C.) A track is not usable if it is flagged defective.
- g. Dumps a line showing if each drive meets specification (no fatal errors, 406 good cylinders on 7905/7906 and 815 good cylinders on 7920/7925, cylinder zero good, and less than one data error in every one billion (10^9) bits transferred. (Unit 0 in the example failed because of the fatal error that occurred.)
- h. Dumps a list of all address errors (up to 151 errors). Shown is the starting cylinder address (OLD CYL), intended cylinder address (CYL), actual cylinder address (ACTUAL CYL), and actual head and unit. These errors result when a seek completes on a cylinder other than where it was suppose to.

Example:

```

CYL   HD0  HD1  HD2  HD3  HD4
0734 0001
0761                0005
0768 0001
TOTAL 0002 0000 0000 0000 0005

```

OVERFLOW=0000;ALL ERROR=0009

```

HEAD 00 SECTORS 24 -31 0001 0000 0001 0000 0000 0000 0000 0000
HEAD 04 SECTORS 00 -07 0005 0000 0000 0000 0000 0000 0000 0000

```

```

HEAD UNIT 0 UNIT 1 UNIT 2 UNIT 3 UNIT 4 UNIT 5 UNIT 6 UNIT 7
00-E 0002 0000 0000 0000 0000 0000 0000 0000
04-E 0000 0005 0000 0000 0000 0000 0000 0000

```

FATAL 0001 0000 0000 0000 0000 0000 0000 0000

PASS 0010 0010 0000 0000 0000 0000 0000 0000

```

00-C 0821 0823 0000 0000 0000 0000 0000 0000
01-C 0823 0823 0000 0000 0000 0000 0000 0000
02-C 0823 0823 0000 0000 0000 0000 0000 0000
03-C 0823 0823 0000 0000 0000 0000 0000 0000
04-C 0823 0823 0000 0000 0000 0000 0000 0000

```

OK? NO OK

OLD ACTUAL

```

CYL   CYL   CYL  HEAD UNIT
0822 0821 0819 00   1
0793 0792 0796 00   1
0792 0791 0793 00   1
0791 0790 0784 00   1

```

2-12. DIAGNOSTIC MESSAGES

Two types of messages are output by the diagnostic: error and information messages. Error messages are used to inform the operator when the interface, controller, or drive fails to respond properly to a command sequence. The diagnostic outputs an error summary information message, H65, at the end of each pass:

H65 LONG (SHORT) PASS XXXX, HEAD YYYYYYYYY, UNIT X, AAAA ERRORS-BBBB SOFT (,MULTI-UNIT)

where: AAAA = Fatal and non-fatal errors.
BBBB = Non-fatal errors.

Errors which would probably cause an operating system to irrecoverably fail or have to be restarted are fatal errors. Examples of this type of error are as follows:

- a. No flag from the controller indicating completion of a command from the CPU.

Program Description

- b. An uncorrectable data error (fatal only if repeated five consecutive times on the same sector). (This may be the result of errors introduced during a write function.)
- c. Reading a sector of known data which has an error in it, which is not reported as a data error by the disc subsystem.

Non-fatal errors are divided into "data" and "non-data" errors. Data errors are those which cause the controller to return either a possibly correctable data error or an uncorrectable data error status. When you suppress soft errors (Appendix B, step f), you are suppressing non-fatal data errors (non-data errors are still reported). Data errors that occur frequently at a given location on the disc (hard errors) are probably caused by a bad track on the disc media and should be flagged defective (refer to example 8 in the Helpful Hints portion of this manual).

Information messages are used to inform the operator of the progress of the diagnostic or to instruct the operator to perform an operation. If an associated halt occurs, the operator must press RUN to continue execution of the diagnostic. The printed message will be preceded by the letter E (error) or the letter H (information) and a number (in octal).

All messages are suppressed by setting Switch Register bit 11 and information messages are suppressed by setting Switch Register bit 10.

A halt code summary and complete explanations of individual error information messages appear in Appendix A.

2-13. EXECUTION TIME

Time to execute a pass will depend on operator intervention, error retries, and message suppression. Approximate execution times for a long pass of the diagnostic (040001 (octal) loaded in S-register as desired options) and all heads selected are given below for the various disc drive, CPU, and memory size configurations:

DRIVE	7905		7906		7920		7925	
	32K	64K	32K	64K	32K	64K	32K	64K
CPU								
2100A/S	0:40	0:33	0:52	0:40	1:45	1:10	3:53	2:46
2105/08/12	0:38	0:29	0:47	0:35	1:43	1:08	3:45	2:27
2109/13	0:37	0:28	0:45	0:33	1:25	0:58	3:09	2:05

NOTE: Times are given as, hours:minutes.

OPERATING PROCEDURE	SECTION III
---------------------	----------------

3-1. DIAGNOSTIC OPERATING PROCEDURES

A flowchart of the operating procedures for loading and starting the Diagnostic Configurator and this diagnostic is provided in figure 3-1 on the following page. Refer to the Diagnostic Configurator Reference Manual, part no. 02100-90157, or to the Basic Operating Procedures at the front of this manual, for the procedures specified in figure 3-1.

Table 3-1 is used in conjunction with the flowchart to configure the diagnostic program.

Table 3-2 (paragraph 3-3) is used during execution of the diagnostic to allow the operator to select desired options.

Note: If the diagnostic has been run, it can only be reconfigured if 40K-bytes or more of memory is available.

Operating Procedure

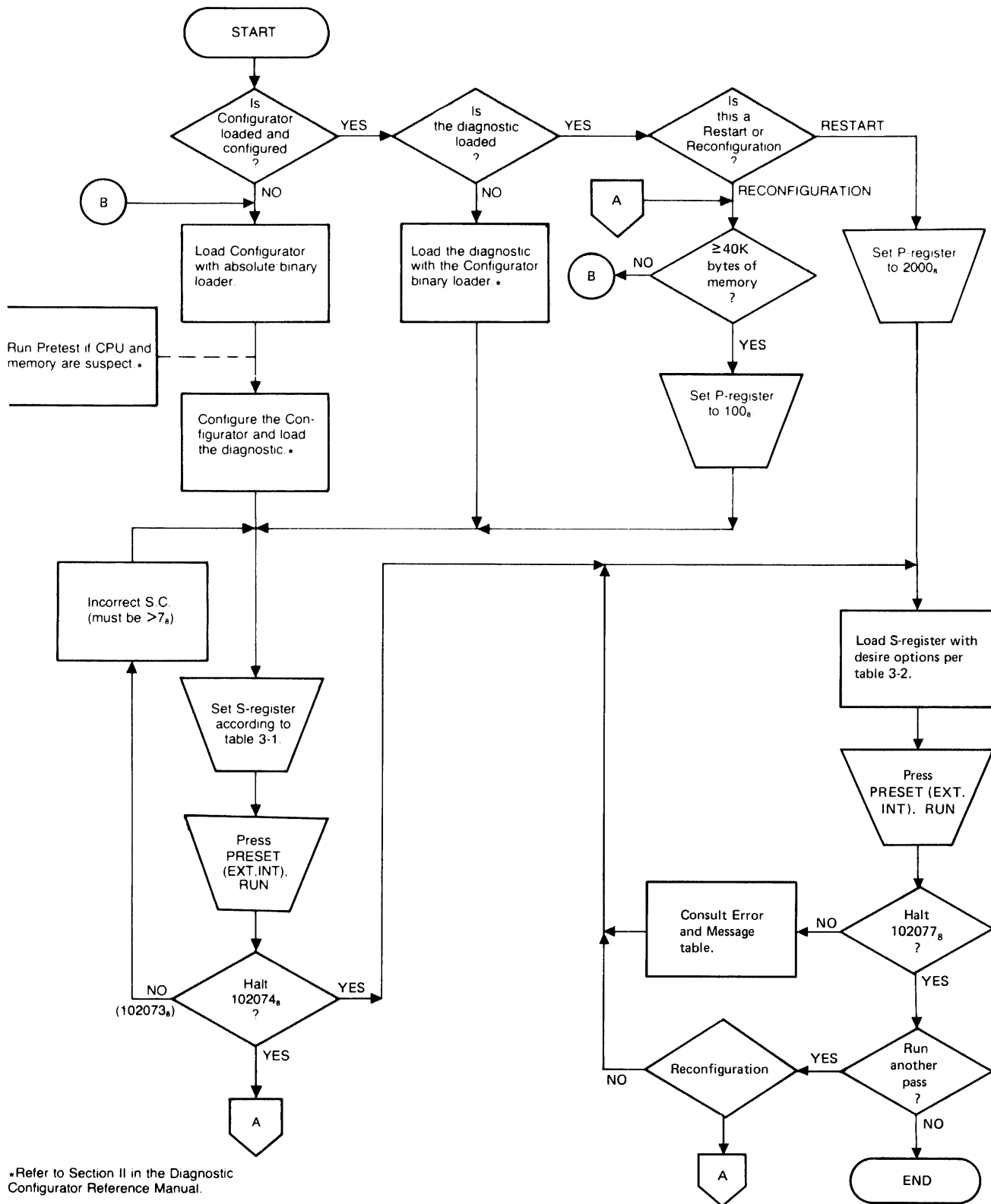

7700-145

Figure 3-1. Load/Start Procedure Flowchart

Table 3-1. Select Code and DMA Channel Option

BIT	COMMENT
0-5	Set to select code of I/O channel containing the interface PCA.
14	Set for DMA channel 7; clear for DMA channel 6.
Note: Bits 6-13, and 15 are spares.	

3-2. PREPARATION FOR DIAGNOSTIC RUN

When running the diagnostic, use a scratch cartridge/pack if data on the current cartridge/pack is to be saved since all information on the cartridge/pack used will be lost.

On a 7905/7906 Drive, set the LOWER DISC PROTECT switch if data on the fixed disc is to be saved.

3-3. RUNNING THE DIAGNOSTIC

- a. Load a starting address of 2000 (octal) into the P-register.
- b. Select desired options from table 3-2 by setting the appropriate bits of the Switch Register.
- c. If Switch Register bit 2 is set (bit 2 dialogue) message H140 ENTER: (U)NIT, (?)ERRS, (H)EAD, (O)UTPUT, (P)ATT, (S)OFT, (C)YL, (M)CPU, (E)XIT is output and the operator is allowed to change the specified areas. Type E in response to message H25 WISH TO CHANGE? to exit the bit 2 dialogue. Refer to Appendix B, BIT 2 DIALOGUE, for more information.
- d. If Switch Register bit 3 is set, control is given to the operator design (OPDSN) portion of the diagnostic (refer to paragraph 3-5).
- e. After the diagnostic has run, a summary (refer to paragraph 2-11) of all data errors may be output by performing the following:
 - (1) Load a starting address of 16000 (octal) into the P-register.
 - (2) Press RUN.

Table 3-2. Diagnostic Switch Register Options

BIT	COMMENT
<i>NO</i> 0	Allow defective and spare tracks (i.e., tracks flagged spare or defective will not cause an error when the diagnostic is run) and flag a track defective in step 12 or in step 90 if five consecutive attempts to verify that track are unsuccessful, when set.
1	Skip to end of current test section when set.
<i>NO</i> 2	Allow operator to alter the unit table, unit removal threshold, head table, determine status heading, alter pattern table, change decision on printing soft errors alter cylinder table, and decide whether or not MCPU mode is entered, when set. (Refer to Appendix B.)
3	Enter operator design portion (OPDSN, test section 6) of the diagnostic, when set.
<i>NO</i> 4	Execute test section 1, steps 3 thru 21, when set. These steps are not performed elsewhere in the program since operator assistance is required.
<i>NO</i> 5	Skip test section 2 and shorten test in test sections 3, 4, and 5. (Refer to Appendix D.)
6	Select cylinder numbers from the cylinder table when set; from all those available on drive, when clear.
<i>NO</i> 7	Loop on current test section when set.
<i>NO</i> 8	When set, eliminate all blank lines between messages output and output the pass message H05 if an error occurs during a pass in which bit 10 is set.
<i>NO</i> 9	Halt (10201X) after each test section of the diagnostic is complete when set. Push RUN and the diagnostic will continue from where it left off.
<i>NO</i> 10	Suppress all non-error messages (i.e., H... messages), when set. Exceptions are current operation messages when an error occurs, the cylinder, head, and sector where the error occurs, and the pass message H65 on each pass where the error occurs, when bit 8 is set.

for diagnostic



Test section 1



when set



Table 3-2. Diagnostic Switch Register Options (Cont)

BIT	COMMENT
11	All messages are suppressed when set.
12	Print timing messages in test sections 2 (H53 AVERAGE SINGLE CYLINDER SEEK TIME X.XX) and 4 (H54 AVERAGE RANDOM SEEK TIME XXXX.X, LENGTH XXXX.X), when set.
13	Loop on current step when set.
14	Program will not halt after each error when set.
15	Halt (102004) after the current step is complete, when set. If in OPDSN when set, the current OPDSN program will halt, and if bit 3 is set OPDSN instructions may be entered, otherwise the diagnostic will begin execution.

3-4. USING THE DIAGNOSTIC AS A TROUBLESHOOTING AID

During the execution of the diagnostic, various information and error messages are output by the diagnostic. These messages can be used to determine the cause of errors, if they are interpreted correctly. The following steps describe the procedures for using the diagnostic as a troubleshooting aid:

- a. Carefully read each and every line output by the diagnostic and be sure you understand it.
- b. If a step number is given, turn to the explanation of that step which is given in section II of this manual. The explanations for the various steps in the diagnostic have been expanded to give a more thorough explanation of what is being done. In some cases it may be necessary to read a few steps preceding or following the step in error to get a full understanding of what is being done. Along with this explanation, several of the steps include probable causes as to what might be malfunctioning. These are given starting with the most likely device.
- c. Turn to Appendix A of this manual for an explanation of the various messages output by the diagnostic. Possible causes of these messages are given in several cases.

Note: It is very important to look at each of the status bits in the E64 message which gives the two status words obtained and the two values showing what they should be. Special attention should be focused on those bits which differ.

Operating Procedure

3-5. OPERATOR DESIGN PROCEDURE

To enter test section 6 (OPDSN) of the diagnostic perform the following:

- a. Load a starting address of 2000 (octal) into the P-register.
- b. Set Switch Register bit 3 in conjunction with any other bits for the desired diagnostic options.
- c. Press PRESET (INTERNAL and EXTERNAL).
- d. Press RUN. An introductory message "H55 ENTER INSTRUCTIONS (CURRENT UNIT = XX)" is output. (XX = unit currently being addressed by diagnostic and to which all commands will be issued unless changed, by a SD,N instruction (N = new current unit)).

Note: The units addressed in an OPDSN program are not required to be in the unit table.

Note: Clear Switch Register bit 3 to give control to START area of the diagnostic when the current OPDSN instruction is complete.

- e. The following contain information needed to create an operator design program:

- (1) Enter instructions from paragraph 3-7 in the desired execution sequence. Commas separate fields. Fields are defaulted if excluded from instructions or skipped by the instruction.

Example: The form for a seek command is SK, Cylinder, Head, Sector.

SK Seeks to cylinder 0, head 0, and sector 0.

SK,,1 Seeks to cylinder 0, head 1, and sector 0.

SK,7,2,3 Seeks to cylinder 7, head 2, and sector 3.

- (2) If an error occurs in instruction entry, the message H31 INPUT ERROR is output. The erroneous entry has been rejected and must be typed again.
- (3) Erase present instruction entry before LINEFEED has been sent by using RUBOUT/DELETE.
- (4) Erase last line in input string with operator instruction EE (Erase Entry). Repeat the instruction N times to erase the last N lines.
- (5) Erase operator design program completely with operator instruction EP (Erase Program).

- (6) Shorten the operator design program following an HI6 OVERFLOW message with an EE or an EP operator instruction.
- (7) Labels are exactly two characters. All printing characters are legal. Spaces are skipped.
- (8) Add instructions to the operator design program, beginning from the end, with an AI instruction.
- (9) Restart operator design programs with an RI operator instruction.
- (10) The CL, CR, DS, ID, IS, RC, RD, RF, RO, RS, RW, SK, VF, WD, and WF operator instructions include a software status check unless they are followed by a SC, VS, VP, or VD operator instruction. The expected status for software status check is default status (00000000000000YYY) for STATUS-1 word (YYY = unit number) and 0AAAAAA000X00000, where AAAAAA = drive type = 000010 for 7905, 000000 for 7906, 000001 for 7920, and 000011 for 7925. X = don't care. SC allows expected status to be specified. VS, VP, and VD are specific status which look for spare, protected, and defective tracks, respectively.
- (11) An EN, LP, or LS operator instruction will be rejected if undefined labels exists in the operator design program.

(12) Field limits are as follows:

$0 \leq \text{Cylinder} \leq \text{ZZ}$	$\text{ZZ} = 410 \text{ for } 7905/7906 \text{ and } 822 \text{ for } 7920/7925$
$0 \leq \text{Head} \leq \text{X}$	$\text{X} = 2 \text{ for } 7905, 3 \text{ for } 7906, 4 \text{ for } 7920, \text{ and } 8 \text{ for } 7925$
$0 \leq \text{Sector} \leq \text{Y}$	$\text{Y} = 47 \text{ for } 7905/7906/7920 \text{ and } 63 \text{ for } 7925$
$1 \leq \text{Read Buffer Size} \leq \text{W}$	$\text{W} = 1024 \text{ for } 32\text{K-bytes of memory and } 8192 \text{ for } 64\text{K-bytes}$
$1 \leq \text{Number of Sectors Verified} \leq 32767$	
$-63 \leq \text{Cylinder Offset} \leq +63$	
$1 \leq \text{Define Buffer Size} \leq \text{W}$	$\text{W} = 1024 \text{ for } 32\text{K-bytes of memory and } 8192 \text{ for } 64\text{K-bytes}$

Limit checks are not made on Cylinder Offset. If the limits are exceeded, fields may merge and produce unusual results. To disable limit check of cylinder, head, and sector variables, use the DC command prior to the desired seek in the OPDSN program.

Operating Procedure

3-6. MULTIPLE CPU TESTING

This test should be used only after each CPU has been checked out thoroughly with the rest of the disc subsystem in a single CPU environment.

Multiple CPU testing is accomplished with the OPDSN command MC. The MC command may also be executed in a single CPU environment, however, the purpose of the command is to test the setting and clearing of the hold bit and the functioning of the WAKEUP command, which are useful only in a multiple CPU environment.

Because the more complex multiple CPU protocol is not used throughout the program, a major portion of the diagnostic cannot be run in a multiple CPU environment without errors. A bit 2 option of the diagnostic occurs in the START area of the diagnostic and tells you whether or not you are in MCPU mode. The diagnostic then asks you if you wish to change the mode of operation. If you respond YES, it changes from whatever mode you are in to the other mode, (i.e., you are either in MCPU mode or you are not in MCPU mode).

When in MCPU mode, the only parts of the diagnostic which may be executed are a small portion of the START area (excluding portions which send commands to the controller) and OPDSN. OPDSN only works on a limited set of its regular commands when in MCPU mode. All unacceptable commands are rejected at the time of entry into OPDSN programs. (Refer to the MC instruction in paragraph 3-7 for the commands which may be used when in MCPU mode.)

To exit from MCPU mode, return to the bit 2 dialogue. This may be accomplished by clearing Switch Register bit 3 during OPDSN execution or by typing IX during OPDSN program entry. To the bit 2 question concerning MCPU mode, respond that you wish to change by typing YES. This will remove you from MCPU mode.

Note: All CPU's executing on the same disc subsystem must be in MCPU mode if more than one CPU is operating.

Note: Errors in hold bit setting and clearing or faulty operation of a WAKEUP command are usually indicated by either SEEK CHECK errors in the STATUS-2 word received from the drive or by the messages:

H127 NEVER GOT FLAG ON WAKEUP UNIT = XX

E63 NO FLAG

3-7. OPERATOR INSTRUCTION LIST

Note: Brackets in the following instruction list indicate fields that may be omitted.

INSTRUCTION	FUNCTION
AI	Add Instructions. Allows operator to add to the list of instructions last executed. The terminating instruction EN, LP, or LS,N is deleted from the previous program. The AI instruction is undefined if the previous program has been lost (any of test sections 1 thru 5 have run).
ARI,[CCC] [,H] [,SS]]	Address Record. This instruction sets up the disc address in the controller. Default condition sets the disc address to zero. (CCC = cylinder, H = head, SS = sector).
CA,LL	Call subroutine LL. This instruction transfers control to the subroutine LL. Subroutine LL need not be defined before the CA,LL instruction is entered into the OPDSN program. (Also see SB,LL and LV,LL instructions.)
CB [,XXXX] [,YY]]	Compare Buffers. The indicated number of words of the write buffer are compared with the corresponding words of the read buffer. (XXXX = word count, YY = allowed number of error printouts). Default case is 128 words and the first compare error that occurs is output in message E47 DATA WORD XXXX IS YYYYYY SHOULD BE ZZZZZZ. If a data error occurs the syndrome (error correction information) is requested and message H116 DATA ERROR CORRECTED is output if all the errors are corrected.
CC [,N]	Change cylinder variable in diagnostic by N modulo number of cylinders on the currently addressed drive. To notify the controller of this change follow the CC instruction with a RL instruction. (Default = 1)
CH [,N]	Change head variable in diagnostic by N modulo number of heads on the currently addressed drive. To notify the controller of this change follow the CH instruction with a RL instruction. (Default = 1)
CL	Clear. A clear command is issued to the drive.

Operating Procedure

CP,X,Y Compare surface X with surface Y. This command is intended primarily for checking the transfer of one surface to another. It should follow all TS or TC instructions as a check of the transfer. All 138 words of the sector are checked. If an error occurs on any cylinder a TC,CCC,X,Y instruction should be used to transfer that cylinder again.

Note: The PROTECT switch should be off during the CP instruction.

Note: The second program in example 6 of the Helpful Hints portion of this manual is an equivalent OPDSN program for the CP,X,Y instruction.

CR [, [XXXX] [, [H] [, SS]]]

Cold load read. Issue a cold load read to unit 0, head H, and sector SS. (XXXX = word count.) Default head and sector is 0. Default word is 128. $0 \leq H \leq 3$

CS [,N]

Change sector variable in diagnostic by N modulo number of sectors on the currently addressed drive. This only changes the value in the processor. To notify the controller of this change, follow the CS instruction with a RL instruction. (Default = 1)

CW,X,Y

Change word X (decimal) of the write buffer to Y (octal). $0 \leq X \leq 1023$ for 32K-bytes of memory and 8191 for 64K-bytes

DA

Request Disc Address. The two words returned from the controller contain the current cylinder, head, and sector stored in the controller. The two words are placed in the first two words of the read buffer. To display the two words, follow the DA instruction with DR,0,1. The values displayed are octal values. The first word is the current cylinder; the second word has the head and sector in the upper and lower bytes, respectively.

DB [, [XXXX] [, YYYYYY [, C]]]
I

Define Buffer. The write buffer has the indicated number of words filled with the indicated pattern. Default case fills 128 words. Default pattern causes each word to be random. (XXXX = word count, YYYYYY = pattern word in octal).

If "C" is present the pattern is complemented in successive words. If "I" is present the pattern is

- incremented in successive words. When the "C" or "I" option is used, the default pattern is zero.
- DC Disable checking. Disable checking for legality of cylinder, head, and sector addresses sent to the controller at run time.
- DL [,N] Delay N milliseconds before proceeding to the next OPDSN instruction to be executed.
- DR,X [,Y] Display Read buffer contents starting from word X to word Y. If Y is not given, the contents of word X are displayed. $0 \leq X \leq 1023$ for 32K-bytes of memory and 8191 for 64K-bytes, $0 \leq Y \leq 1023$ for 32K-bytes and 8191 for 64K-bytes, $X < Y$
- DS [, [CCC] [, [H] [,SS]]] Decrement Seek. This instruction will do an initial seek to the location specified in this instruction and will decrement the cylinder by 1 each time it is executed until it reaches cylinder zero. Following cylinder zero, it will seek to last cylinder of current unit (cylinder 410 of 7905/7906 and cylinder 822 of 7920/7925). Default condition sets the disc address to zero. The initial value CCC,H,SS is reset if the OPDSN program is restarted.
- DW,X [,Y] Display write buffer contents starting from word X to word Y. If Y is not given, only the contents of word X are displayed. $0 \leq X \leq 1023$ for 32K-bytes of memory and 8191 for 64K-bytes, $0 \leq Y \leq 1023$ for 32K-bytes and 8191 for 64K-bytes, $X \leq Y$
- EE Erase Entry. Last instruction entered into OPDSN program is erased.
- EN [,LL] End. This instruction terminates operator design instruction entry. The label portion of this instruction is the start address for operator design execution. In the default case, the program will execute from the first instruction (LL = label). This instruction begins execution of operator design program.
- EP Erase Program. Erases present program and outputs message H55 ENTER INSTRUCTIONS (CURRENT UNIT = XX).
- EX Exit. Turns off Switch Register bit 3 and goes to step 1 of diagnostic when entered into the OPDSN program.
- FH Format all heads in head table for current unit. Same as FN, but for each head in the head table.

Operating Procedure

FN Format surface N (N = head 0-2 for 7905, 0-3 for 7906, 0-4 for 7920, and 0-8 for 7925). This instruction is the same as:

```
LB,AA
IS,,N
ID
IS,,N
VF,SS               SS = 48 for 7905/7906/7920 and
                    64 for 7925
RT,AA,ZZ           ZZ = 410 for 7905/7906 and
                    822 for 7920/7925
```

GO,LL GOTO. Branches to label LL in program.

HT [,XXXXXX] Halt. This instruction halts and displays value in A-register. Zero is displayed in the default case. (XXXXXX = display value in octal).

ID [, [XXXX] [,S]]
 D
 P

Initialize Data. This instruction requires that the FORMAT switch, in front of drive be ON to allow access to the sector address words on the disc. This command results in the disc address being placed in the sector currently referenced. If the defective track indication (D) is added to this instruction each sector is tagged defective. If the protect track indication (P) is added to this instruction, each sector is tagged as protected. If the spare track indication (S) is added to this instruction, each sector is tagged spare. This process is repeated on as many sectors as the word count allows. The default case for a 7905/7906/7920 writes 6144 words from the write buffer which is equal to 48 sectors of 128 words each; for a 7925, 8192 words are written which is equal to 64 sectors of 128 words each. (XXXX = word count.)

IS [, [CCC] [, [H] [,SS]]]

Incremental Seek. This instruction will do an initial seek to the location specified in this instruction (default = 0) and will increment the cylinder by one each time it is executed until it reaches cylinder XXX. Following cylinder XXX it will seek to cylinder 0. (Note that IS instructions are independent of one another when two or more are used in the same program.) The initial value of CCC,H,SS is reset if the OPDSN program is restarted. (XXX = 410 for 7905/7906 and 822 for 7920/7925.)

- LB,LL Label. Associates a particular location in the program with a label. (LL = label).
- LP [,LL] Loop. (Similar to EN.) Program starts at location LL, but loops to beginning of program when LP is executed. A program ending with LP may run indefinitely unless computer is halted, Switch Register bit 3 is cleared, or bit 15 is set.
- LS,N Loop on Step N. Terminates OPDSN instruction entry and begins execution of OPDSN program when entered into the OPDSN program. When LS,N instruction is executed, the OPDSN program is halted, Switch Register bit 3, is cleared, and the diagnostic begins execution at step 1. Execution of step N sets Switch Register bit 13 and the diagnostic loops on step N. If N is not a valid step number, LS will be executed without the looping feature.
- LV,LL Leave subroutine LL. This instruction transfers control from subroutine LL to the instruction following the last CA,LL instruction executed. (Also see SB,LL and CA,LL instructions.)
- MC [, [CCC] [, [H] [,SS]]]

Multiple CPU Check. Tests the hold bit and wakeup command in a multi-CPU environment. Issues a wakeup command to current drive to check availability. Performs seek to specified cylinder, head, and sector with hold bit set. Sets file mask equal to four which enables track sparing. Verifies one sector, selected during seek, without hold bit set. Issues a NOP (Poll) to controller.

Note: Instruction MC without a comma (no address specified) will cause a random seek. Instruction MC, (with a comma) will cause a seek to cylinder 0, head 0, sector 0.

Note: When executing an operator design program containing a MC instruction all computers must be halted, or they must be executing an operator design program containing only the following instructions:

AI	CS	DR	EP	LP,LL	RT,LL,X
CA	CW	DW	EX	LS	SB
CC	DB	EE	HT	LV	SD,X
CH	DC	EN	LB,LL	RI	TB

Operating Procedure

Note: One test is to connect two or more CPU's to a common controller and execute the following operator design program in all the CPU's:

```
SD,0
MC
LP
```

For a more extensive test, write an OPDSN program in each CPU which issues at least one MC command to each drive in the system and looping each program by ending it with the LP command.

Example: SD,0 If more than one disc drive is used by
MC more than one CPU (up to eight), the
SD,1 program may be placed in each CPU and all
MC of them executed simultaneously as long as
 each CPU is in the MCPU mode.
 .
 .
 .
SD, <n>
MC
LP

NO Nop. Issues a NOP (or end or poll) command to the disc. Tells the controller to continue polling.

PR,SS Output the two character symbol SS followed by an integer number which is incremented each time the command is executed. SS may be any valid two characters. The increment counter is initialized to zero each time the OPDSN program is restarted.

Example: LB,XX
PR,A1
RT,XX,2
PR,17
RT,XX,1
EN

Output is:

```
A1 000001
A1 000002
A1 000003
17 000001
A1 000004
A1 000005
A1 000006
17 000002
```

- RA Request Sector Address. The word returned from the controller containing the logical address of the sector currently passing under the heads of the specified unit is placed in the read buffer. Follow this command with a DR,0 to display the value returned.
- RC Recalibrate. A recalibrate command is issued to the disc.
- RD [,XXXX] Read Data. Transfer the number of words indicated from the disc to the read buffer. Default case is 128 words. (XXXX = word count.) Maximum word count is 1024 if 32K-bytes of memory or 8192 if 64K-bytes. End of cylinder may occur if data to be read is not on the same cylinder and the file mask is not set appropriately (i.e., either in cylinder mode and/or incremental or decremental seek mode).
- RF [,XXXX] Read Full Sector (similar to RD). A read full sector command is performed for XXXX words. Default word count is 138. Maximum word count is 966 (seven full sectors) if 32K-bytes of memory or 8192 (59 full sectors) if 64K-bytes.
- RI Run instructions. Will cause the set of previously entered instructions to run again. This instruction is undefined if the program has been destroyed (any of test sections 1 through 5 have run).
- RL Reload. Issues a seek to the controller with the same cylinder, head, and sector as currently assigned in the OPDSN program.
- RN Restore the cylinder, head, and sector which was stored by the last SN instruction executed in the OPDSN program (i.e., R2 will restore the value saved by S2). (N = 0, 1, or 2)
- RO[, [XXXX] [, [±CC] [, A]]]
D
- Read with Offset. Issues a read with offset command to the disc. XXXX = word count (default = 128). CC = cylinder offset (must have sign). A = Advance clock. D = Delay clock. Default is no offsets. End of cylinder may occur.
- RS Random Seek. This instruction will cause a random cylinder-head-sector combination to be generated and will then seek to the random location. Switch Register bit 6 is used to randomly select from the cylinder table. Head is selected from the head table.

1284 (one word)

Operating Procedure

RT,LL,X Return. Return to the indicated label (LL = label) in the OPDSN program X number of times. The label returned to must precede the RT instruction in the OPDSN program. The initial value of X is reset if the OPDSN program is restarted. (X = 32767 maximum.)

RW Read without verify. Similar to RD but the previous sector is not verified by the disc controller.

SB,LL Subroutine LL. This instruction defines the beginning of a subroutine; it must occur in the program before the LV,LL instruction occurs (LV,LL is leave subroutine LL). The instruction immediately following the subroutine call instruction is the next instruction executed when leaving a subroutine. Each subroutine must have a unique label. Any valid label may be used as a subroutine name. Subroutines may be nested to any level, but they must not be recursive. An SB,LL instruction can only be executed as a result of a CA,LL instruction. Therefore all subroutines must be preceded by a command which transfers control to some other OPDSN instruction. This may be done with a GO,XX or LV,XX instruction. (Also see LV,LL and CA,LL instructions.)

SC[,(TTTTTTTTTTTTTTTT) [,TTTTTTTTTTTTTTTT]]

Status Check. The last hardware status (STATUS-1 and STATUS-2) is checked bit by bit against the expected status represented by the two sixteen bit strings (TTTTTTTTTTTTTTTT). Each bit may be a 0, 1 or X (for don't care). If they do not compare, an error message is reported. Default status is 00000000000000YY (YYY = unit number) and 0AAAAA000X00000. (AAAAAA = drive type). Any status may be specified but the unit number and drive type will be "inclusive or'ed". This instruction does not change the current operation message output by the diagnostic on an error.

SD,X Select Drive. Drive X becomes current unit to which OPDSN instructions will be issued.

SK[, [CCC] [, [H] [, [SS]]]

Seek. Seeks to cylinder, head, and sector specified in SK instruction. Default condition is zero. (CC = cylinder, H = Head, SS = sector)

SM [,XXXXXX]	Set File Mask. Controller file mask (Appendix C) is set to XXXXXX (octal). Default case is 000002 (octal) which equals cylinder mode.
SN	Saves the current cylinder, head, and sector for use at a later time. The value saved may be recalled with a RN instruction. (N = 0, 1, or 2)
ST	Status. Issues a status command to controller to obtain new values for STATUS-1 and STATUS-2 words.
TB [,N]	Transfer Buffer. Transfer first N words of read buffer to write buffer. (N = number of words transferred.) $0 \leq N \leq 1024$ for 32K-bytes of memory and 8192 for 64K-bytes
TC,CCC,X,Y	Transfer cylinder CCC from surface X to surface Y. This instruction can only be used on a 7905 or 7906 Drive and is intended primarily for transferring those cylinders which were not transferred correctly with the TS instruction. (Refer to the TS instruction for further information.)

Note: The PROTECT switch must be ON for surface X and OFF for surface Y, and the drive FORMAT switch must be ON.

TS,X,Y	Transfer surface X to surface Y. This instruction can only be used on a 7905 or 7906 and is intended primarily for saving and restoring the fixed surface. The information transferred from surface X to surface Y includes the 128 data words in each sector and the sync, cylinder, head/sector, CRC, and six ECC words. (This is accomplished by using the Read Full Sector and Write Full Sector instructions.) As a result, an attempt to read or verify surface Y will result in a "head/sector compare" error unless the head address written in the sector preamble is equal to the physical head being addressed.
--------	--

Before transferring surfaces, check that the drive can read from the fixed surface by performing the read operation in example 4 of the Helpful Hints portion of this manual.

Note: Set the PROTECT switch to ON for surface X and OFF for surface Y and the drive FORMAT switch to ON when executing the TS,X,Y instruction.

Note: A CP,X,Y instruction should be used following a TS,X,Y instruction to check that the information was transferred correctly. The PROTECT switch must be OFF during the CP instruction. Any cylinders for which errors occur during a CP command should be retransferred using the TC,CCC,X,Y instruction; the CP instruction should then be executed again.

Operating Procedure

Note: Example 6 in the Helpful Hints portion of this manual is an equivalent OPDSN program for the TS,X,Y instruction.

Note: The removable cartridge contains surfaces 0 and 1. The fixed surface is surface 2 on 7905 and, 2 and 3 on 7906. To save the fixed surface, set the LOWER PROTECT switch to ON and enter the following OPDSN program:

```
TS,X,Y          X = fixed surface
                 Y = removable surface
EN
```

To check the transfer, clear the LOWER PROTECT switch and enter the following OPDSN program:

```
CP,X,Y          X = fixed surface
                 Y = removable surface
EN
```

To restore the fixed surface, set the UPPER PROTECT switch and enter the following OPDSN program:

```
TS,Y,X          Y = removable surface
                 X = fixed surface
EN
```

To check the information restored, clear the UPPER PROTECT switch and enter the following OPDSN program:

```
CP,Y,X          Y = removable surface
                 X = fixed surface
EN
```

If any errors occur during the CP instruction refer to the TC instruction.

VD Verify Defective. Check last status received from controller. Output message H141 CYL = XXXX, HD = XX, UNIT =XX DEFECTIVE if defective bit of STATUS-1 word is set.

VF[,XXXX] Verify. A verify command is issued for XXXX sectors. Default is one sector.

VH Verify Heads. Verifies all heads in head table. Same as VN, but for each head in the head table.

VN Verify surface N (N = head 0-2 for 7905, 0-3 for 7906, 0-4 for 7920, and 0-8 for 7925). This instruction is the same as:

LB,AA

IS,N

VF,SS

SS = 48 for 7905/7906/7920 and
64 for 7925

RT,AA,ZZ

ZZ = 410 for 7905/7906 and
822 for 7920/7925

VP	Verify Protected. Check last status received from controller. Output message H141 CYL = XXXX, HD = XX, UNIT = XX PROTECTED, if protected bit of STATUS-1 word is set.
VS	Verify Spare. Check last status received from controller. Output message H141 CYL = XXXX, HD = XX, UNIT = XX SPARE if spare bit of STATUS-1 word is set.
WD [,XXXX]	Write Data. Transfer indicated number of words from write buffer to disc. Default case is 128 words. (XXXX = word count.) End of cylinder may occur as in RD instruction.
WF [,XXXX]	Write Full Sector (similar to WD). A write full sector command is performed for XXXX words. Default word count is 138.

3-8. HELPFUL HINTS

The examples described in this paragraph are as follows:

- * Loop on step/test section.
- * Test specific cylinders, long seeks, and heads.
- * Test read operation.
- * Test for properly formatted disc.
- * Determine spare, protected, or defective tracks.
- * Disc copy program.
- * Possible causes of miscellaneous problems.
- * Flag a track defective.
- * Generate a correctable data error.

Example 1. Loop on step/test section.

This example may be used to verify that a particular step or section is executing, or to execute a particular test or series of tests.

To loop on a particular step during diagnostic execution, set Switch Register bit 3 and the diagnostic will transfer control to the OPDSN section of the diagnostic.

Operating Procedure

Enter the OPDSN instruction LS,N (where N = the step to be looped on) and press RETURN. The diagnostic begins execution at START (step 0) of the diagnostic and will loop on step N when executed, at which time Switch Register bit 13 is set.

For example, to test the ability of the controller to correct correctable data errors, type LS,41 when in OPDSN, since step 41 of the diagnostic performs this test.

To loop on a particular test section (one test or a series of tests may be in more than one step), type LS,N (N = the number of any step in that section) when in OPDSN, which will cause the diagnostic to loop on step N when executed. When the diagnostic sets Switch Register bit 13 indicating the diagnostic is looping, set Switch Register bit 7 and clear bit 13, which will cause the diagnostic to loop on the desired test section.

If N is not a valid step number, the diagnostic will not loop on any diagnostic step and execution will continue as usual. The following OPDSN program illustrates this:

FH	Format all heads in the head table for the current unit.
LS,100	Loop on step 100.

The diagnostic begins execution when all the specified heads have been formatted. Since step 100 does not exist, the diagnostic will begin execution as per the switch register options.

This approach may be used for any OPDSN program; it is not limited to format instructions.

Example 2. Test specific cylinders, long seeks, and heads.

To test a particular band of cylinders (e.g., cylinders 300 thru 410) place the following cylinders in the cylinder table via the bit 2 dialogue, set Switch Register bit 6 (only those cylinders in the cylinder table are referenced), and execute the diagnostic: 300, 310, 320, 330, 340, 350, 360, 370, 380, 390, 400, 410.

To test the execution of long seeks on a 7905, place the following cylinders in the cylinder table via the bit 2 dialogue, set Switch Register bit 6, and execute the diagnostic: 0, 410, 0, 410, 0, 410, 0, 410, 0, 410, 0, 410

Note: Use 822 in place of 410, if using a 7920.

To test one particular head, place only that head number in the head table via the bit 2 dialogue.

Note: An RS command in an OPDSN program or any random seek will only access the heads that are in the head table for the desired drives.

Example 3. Test for properly formatted disc.

To determine if a disc is formatted correctly check the preamble, CRC, and ECC words of a sector by executing the following OPDSN program:

Note: A read full sector (RF) instruction reads 138 words which consist of the following:

word 0 = sync word = 100376
 word 1 = address of cylinder
 word 2 = bit 15 = set if track is spare
 bit 14 = set if track is protected
 bit 13 = set if track is defective
 bits 12-8 = address of head
 bits 7-0 = address of sector
 words 3-130 = 128 data words
 word 131 = Cyclic Redundancy Code (CRC)
 words 132-137 = Error Correction Code (ECC)

SK,CC,HH,SS	Seek to cylinder CC, head HH, and sector SS.
RF	Read one full sector of 138 words.
DR,0,2	Output sync, cylinder, and head/sector words.
DR,131,137	Output CRC and ECC words.
DR,3,130	Output entire data sector from 3 to 130.
DR,3,7	Output first five words of data sector.
EN	End of OPDSN program.

Note: A read (RD) instruction reads in 128 words (0 thru 127), which does not include the sync, cylinder, head/sector, CRC or ECC words.

Operating Procedure

SK,CC,HH,SS Seek to cylinder CC, head HH, and sector SS.
RD Read one sector of 128 words.
DR,Ø,127 Output entire sector from Ø to 127.
EN End of OPDSN program.

Example 4. Test read operation.

To determine if a problem is due to read or write problems, or possibly to a data cable (defective or not connected), execute the following OPDSN program where cylinders 1Ø and 2Ø are not spare, protected, or defective:

SK,10,2 Seek to cylinder 10, head 2.
RF Read a full sector (i.e., 138 words).
DR,Ø,2 Display the sync, cylinder, and head/sector words just read.
SK,20,2 Seek to cylinder 20, head 2.
RF Read a full sector.
DR,Ø,2 Display the sync, cylinder, and head/sector words just read.
EN End of OPDSN program.

The output should be as follows:

```
0000: 100376 000012 001000
0000: 100376 000024 001000
```

If the words output from each track do not agree with those shown above, errors may be due to a defective data cable or the data cable is not connected.

Example 5. Determine spare, protected, or defective tracks.

To determine which tracks are spare, protected, or defective, enter the following OPDSN program:

LB,A0	Define label A0.
IS	Seek to the next cylinder on head zero.
LB,A1	Define label A1.
RL	Seek to the cylinder, head, and sector currently used by the diagnostic.
VF	Verify one sector to obtain S, P, D information from the track.
VD	Check if the track is defective.
VF	
VS	Check if the track is spare.
VF	
VP	Check if the track is protected.
CH,1	Change the head addressed by the diagnostic by one modulo number of heads on the drive.
RT,A1,2	Return to label A1, two times, to check all three heads in 7905. (Replace 2 by 3 for 7906, 4 for 7920, and 8 for 7925.)
RT,A0,410	Return to label A0, 410 times, to check all 411 cylinders. (Replace 410 by 822 for a 7920/7925.)
EN	End of OPDSN program.

Example 6. Disc copy program.

Note: Before performing this procedure, check that the drive can read from the fixed surface by performing the read operation in example 4 of the Helpful Hints portion of this manual.

The following two programs are included to illustrate the use of several of the new OPDSN instructions and to show the equivalent OPDSN programs for the IS,X,Y and CP,X,Y OPDSN instructions.

The following two programs can be used to copy or restore the data on a fixed platter on a 7905 to or from a removable cartridge, and to check that the data is transferred correctly.

The first program makes an exact copy of one surface to another, thus the address portion of the copied version is the same as it was on the original surface. Due to this, a regular read rather than a read full sector will result in a head sector compare error. In performing the copy, each sector to be copied is read twice to ensure the data is read correctly. The data is then written to the other surface and read back to ensure the data has been transferred correctly. Proceed as follows:

Note: This program will cause several error messages to be output if the surface being copied or the surface being copied to has

Operating Procedure

tracks which cannot be written on or read from consistently.
 (Some other method of copying the surface should be used.)

- a. Protect the surface to be copied from by setting the proper UPPER/LOWER DISC PROTECT switch.
- b. The following table applies to the following two OPDSN programs and are not the values used in the IS or CP OPDSN instructions. Insert the following values into the OPDSN program wherever the letters W, Y, or Z occur:

COPY				
FROM HEAD	TO HEAD	W	Y	Z
0	2	2	1	0
1	2	1	2	1
2	0	1	2	2
2	1	2	1	2

Note: Head 2 is for the fixed platter.

Special attention should be given to those tracks on which errors occur to ensure they are copied correctly.

- c. The OPDSN program is as follows:

GO,BB Skip over subroutines to label BB.

SB,A1 Start of subroutine A1.

RL Issue a seek to the cylinder, head, and sector currently used by the diagnostic.

SC,XXX1111100000000,000000000XX00000

Check for drive attention due to seek completion and disregard the format or protect switches.

RF,828 Perform a read full sector (for six sectors).

SC,0000000000000000,000000000XX00000

Check status for NORMAL COMPLIT. Disregard format or protect switches.

LV,A1 Leave subroutine A1.

SB,A0 Start of subroutine A0.

LB,A3 Define label A3.

CA,A1 Call subroutine A1 to perform a seek and a read full sector for six sectors.

TB,828 Transfer the six sectors read from the read buffer to the write buffer.

CA,A1 Call subroutine A1 to perform a seek and a read full sector for six sectors.

CH,W Change the head currently used by the diagnostic by W modulo number of heads on the drive. (Refer to the table in step b for the value of W.)

RL Issue a seek to the cylinder, head, and sector currently used by the diagnostic.

SM Issue a set file mask command to the drive. This is to return a STATUS-1 word equal to zero which is what is expected by the following CB instruction.

CB,828,3 Compare 828 words of the read and write buffers to check that they are equal. Output up to the first three words in error.

WF,828 Write the six full sectors read from the initial surface onto the second surface.

SC,0000000000000000,0000000000XX00000
 Check for NORMAL STATUS returned and disregard the protect and format switches.

CA,A1 Call subroutine A1 to perform a seek and a read full sector of six sectors.

RL Perform a seek to the cylinder, head, and sector currently used by the diagnostic.

SM Issue a set file mask command to the drive. This is to return a STATUS-1 word equal to zero which is what is expected by the following CB instruction.

CB,828,3 Compare the 828 words of the read and write buffers to check that they are equal. Output up to the first three words in error.

CS,6 Change the sector currently used by the diagnostic by six.

Operating Procedure

CH,Y Change the head currently used by the diagnostic by Y modulo number of heads on the drive. (Refer to the table in step b for the value of Y.)

RT,A3,7 Return to label A3 seven times so that all eight groups of six sectors each are copied.

LV,A0 Leave subroutine A0.

LB,BB Define label BB.

IS,,Z Issue incremental seek to head Z. (Refer to the table in step b for the value of Z.)

SC,XXX1111100000000,000000000IX00000

Check status for drive attention due to previous seek and the appropriate DISC PROTECT switch on.

CA,A0 Call subroutine A0.

RT,BB,410 Return to label BB 410 times.

EN End of OPDSN program.

The following program should now be run to compare the two surfaces against each other. The second program which compares the two surfaces of a 7905 is as follows:

Note: The drive protect switches must not be on.

GO,BB Skip over subroutine to label BB.

SB,A0 Start of subroutine A0.

LB,AA Define label AA.

RL Seek to the cylinder, head, and sector currently used by the diagnostic.

RF,828 Perform a read full sector for six sectors.

TB,828 Transfer the six full sectors read, to the write buffer.

CH,W Change the head currently used by the diagnostic by W modulo number of heads on the drive. (Refer to the table in step b for the value of W.)

RL Seek to the cylinder, head, and sector currently used by the diagnostic.

RF,828	Perform a read full sector for six sectors from the other surface.
CB,828,3	Compare the two sets of six sectors read. Output up to the first three errors.
CS,6	Change the sector currently used by the diagnostic by 6 modulo number of sector per track.
CH,Y	Change the head used by the diagnostic by Y modulo number of heads on the drive. This restores the original head number. (Refer to the table in step b for the value of Y.)
RT,AA,7	Return to label AA seven times.
LV,A0	Leave subroutine A0.
LB,BB	Define label BB.
IS,,Z	Perform a seek to head Z and seek to the next cylinder each time it is executed. (Refer to the table in step b for the value of Z.)
CA,A0	Call subroutine A0.
RT,BB,410	Return to label BB 410 times.
EN	End of OPDSN program.

Example 7. Possible causes of miscellaneous problems.

Almost any error which occurs can be caused by defective firmware, thus the ECC board should be checked.

PROBLEM	POSSIBLE CAUSE
Intermittant data errors traceable to controller.	Check operation of fan on left side.
Linear motor loads all the way to crash stops, then retracts.	Missing AGC on Track Follower. Absent Servo Code on platter. Servo head disconnected from Track Follower PCA.
Spindle motor does not turn.	Disc Pack Jamming Spindle. IL Fault.

Operating Procedure

Spindle does not rotate at correct speed.	Receiver warped.
Heads load and then retract.	Disconnected Display PCA.
	Door not tightly closed.
	Pack-in-place (cartridge-in-place) switch faulty.
	Control PCA faulty.
Brush motor inoperative.	Power board.
	Track Follower board.
	DOOR UNLOCKED light burned out.
	Spindle motor defective if heads will not load below 110V ac.
	26V ac fuse blown on Power board.
	Brush Back switch misadjusted.
	Power board.
	Brush motor not plugged into mother board.
Spindle motor spinning, heads do not load and there is no Drive Fault.	Brush cycle did not occur.
	Defective Spindle Encoder board.
	Power board.
	Faulty Spindle motor.
Heads do not load plus a T.O. Fault.	Open velocity (tach) coil.
	Disconnected tach coil.
	Carriage solenoid misadjusted or faulty.
	Control board
	Servo board
C.B. Fault	Defective CB photoswitch.
	Switch tab bent or missing on linear motor.

T.O. Drive Fault

Coil band to barrier block loose.

Sticky carriage solenoid.

Abraded coil band.

Faulty tach coil.

Power board.

Control board.

Servo board.

WAC Fault

Control board.

Open head winding.

Preamp board.

Data cable open or disconnected.

Mother board.

IL Drive Fault

Faulty fuse cap/holder.

Blown fuse.

Any regulated supply shorted.

Spindle Encoder board connector loose.

Any board not fully inserted.

26V ac fuse on Power board blown.

Defective Heat Sense switch on Power board.

Blower failure.

AGC Drive Fault

Intermittant tach coil.

Coil band shorting to centerplate.

"Crap in Gap" on linear motor (bits of steel captured by magnet scraping thru the epoxy cover on linear motor coil.

Track Follower board.

Servo board.

Operating Procedure

Intermittant IL Fault

Intermittant seek errors and
WAR Faults accompanied by erratic
seek times using the DSU.

5 volt supply crowbarred (blower
motor runs, but no Unit Select
light).

Brush motor runs continuously.

-24V fuse blown (located on
Power board).

Intermittant head unloading.

Linear motor will not emergency
retract.

Linear motor crashes to stops
and then retracts.

Linear motor oscillates.

Loose connections on filter
capacitors.

Faulty fuse holder/cap.

Loose lower disc.

Defective mother board.

5V shorted on card cage board.

Connector on display board missing
or misaligned.

Misadjusted Brush Back microswitch.

Power board.

Jammed pack prevents spindle from
turning (SPD must be false or Brush
motor will continue to run).

Blown capacitor (0.8 microfarads) on
Preamp PCA (located bottom center).

Power board.

Spindle Encoder PCA.

Intermittant microswitches.

Low ac line voltage.

Power board.

Shorted velocity transducer.

Faulty Servo PCA.

Faulty coil capacitor (replace
actuator).

Faulty Servo code.

Abraded coil band.

Tach coil.

Tach Rod.

Incompatibility of two drives.

Do not receive "Drive Ready".

Linear motor tries to retract instead of load.

Intermittant SPU.

AC power lost.

Excessive errors on one head.

Does not format.

Drive faults after or during a seek to the last cylinder.

Uneven and/or hesitation of needle swing during head alignment.

Read with offset errors.

Heads vibrate and lose "Drive Ready".

Seek Check errors.

Could not align sector transducer.

Sector transducer on one drive misaligned past 4 microseconds.

Encoder board.

IC on time delay board.

Velocity transducer unplugged or open.

Adjust "door closed" switch.

Check cartridge-in-place (pack-in-place) microswitch.

Intermittant "carriage back" switch.

Defective spindle motor.

Check line filter.

Replace head.

Bad surface.

Device controller.

Microprocessor.

Mother board.

Seek time as set on Servo board may be too low (fast).

Servo board may be miscounting.

Track follower may be faulty (not sending correct signals to Servo board).

The Servo formatted information may be defective.

Track Follower board.

Track Follower board.

Track Follower board.

I/O Sector board.

I/O Sector board.

Operating Procedure

Example 8. Flag a track defective.

To flag track C1,H1 defective and spare it to C2,H2, execute the following OPDSN program:

```
SK,C1,H1      C1 = cylinder, H1 = head.
AR,C2,H2
ID,,D        Flag track C1,H1 defective and spare to
             C2,H2.
SK,C2,H2
AR,C1,H1
ID,,S        Flag track C2,H2 spare for C1,H1.
EN
```

Example 9. Generate a correctable data error.

To generate a correctable data error, execute the following OPDSN program:

```
SK,C1,H1,S1   C1 = cylinder, H1 = head, S1 = sector.
RF           Read full sector.
TB,138       Transfer 138 words of read buffer to
             write buffer.
RL           Reseek to same location.
RD           Read data portion of sector.
DW,NN        Print value of word NN (3 < NN < 130).
CW,NN,XXXXXX Change word NN of sector to XXXXXX.
RL           Reseek to same location.
WF           Write a full sector with one word changed.
TB,128       Transfer data portion to write buffer.
RL           Reseek to same location.
RD           Read modified sector.
CB,128,3     Compare buffers and verify that the data
             was corrected.
EN
```

Note: NN is a full sector number and will be three (3) more than the value reported in the message from the CB instruction.

Table A-1. Halt Code Summary

HALT (octal)	MEANING
102001	Error halt; indicates non-information type messages.
102002	Operating instruction or comment; indicates operator action is required.
102004	Orderly halt at end of current step.
102005	(See information message H1.) Push RUN to restart diagnostic.
102006	Push RUN to restart diagnostic. (See messages E50 and E103.)
10201X	Halt between sections (X = section number).
102073	Control halt. Illegal select code during configuration of the diagnostic.
102074	Control halt. Halt at end of diagnostic configuration.
1060XX	Control halt. Trap cell interrupt. P-register = memory address when interrupted, XX = trap cell location. (Refer to paragraph 2-3, step b for further details.)
<p>Note: For any other halts, refer to the Diagnostic Configurator Reference Manual, part no. 02100-90157.</p>	

Appendix A

A-1. ERROR AND INFORMATION MESSAGES

	MESSAGE	COMMENT
H0	79XX/13037 DISC MEMORY DIAGNOSTIC	Preamble. Output at beginning of diagnostic.
H1	UNIT X REMOVED FROM UNIT TABLE	Unit has been removed from the unit table. Removal results from number of errors/pass exceeding the number specified (see Appendix B, (?)ERRS). Halt occurs if unit table is empty. (Default = 40)
E2	CLF or SFS FAILED	Test the ability of the computer to clear the controller channel flag on the interface card. Error occurred in the START area of the diagnostic. Possible causes of error are the interface card or the computer. Ensure the proper select code was used during configuration.
H3	READ FULL SECTOR IN STEP X	Current operation is read full sector.
H4	CLEAR IN STEP X	Current operation is clear.
E5	SFS FAILED WITH FLAG SET	Test the ability to set controller channel flag on interface card. Possible causes of error are the interface card or the computer.
E6	NO INTERRUPT	No interrupt occurred on controller channel when expected. Test interrupt capability. Check the interface card or the computer. Ensure that all I/O slots, in the computer, of lower select code number than the controller interface have something in them.
E7	WRONG RETURN ADDRESS	Return address stored when interrupt occurred is incorrect. Possible causes of error are the interface card or the computer.
E10	NO FLAG FOLLOWING OPERATION	The flag on the controller interface card, which indicates the completion of a command, was not set within 100 milliseconds. Possible causes of error are: a. Device Controller board b. Microprocessor

- c. Error Correction Code
- d. I/O Sector board
- e. Drive Control board
- f. Track Follower board

E11 LATE FLAG

The device flag on the controller interface card, which acknowledges some input from the computer, was not set until after 100 milliseconds, or the computer was expecting a non-DMA transfer from the controller (i.e., status words, syndrome) in response to a command and the flag was set after 100 milliseconds. This may occur between any of the words transferred in a multi-word, non-DMA transfer. (The flag was eventually set.) Possible causes of error are:

- a. Microprocessor
- b. Device Controller board
- c. Drive Control board
- d. I/O Sector board
- e. Track Follower board

E12 NO FLAG (GETTING STATUS)

Same as E11, except the flag was never set and the two words to be returned were the two status words. Possible causes of error are:

- a. Device Controller board
- b. Microprocessor
- c. I/O Sector board
- d. Drive Control board
- e. Error Correction Code (ECC) board

E13 XXXX WORDS
TRANSFERRED
YYYY EXPECTED

When the operation complete flag occurred (i.e., the flag was set) on the controller interface card, the DMA transfer was not complete.

Note: This message is output only if a data transfer error does not occur in the last sector transferred.

Possible causes of error are:

Appendix A

- a. If termination status is "NORMAL COMPLETE" or "OVERRUN", check the DCPC in the computer or the interface.
 - b. Drive Control board
 - c. Preamp
 - d. I/O Sector board
- E14 NO FLAG (USING DMA)
- A transfer using DMA was in progress, and a controller channel flag on the interface indicating operation complete did not occur. Possible causes of error are:
- a. Device Controller board
 - b. Microprocessor
 - c. I/O Sector board
 - d. Track Follower board
 - e. Drive Control board
- H15 ADDRESS RECORD IN STEP X
- Current operation is address record. Check the microprocessor if errors occur.
- H16 OVERFLOW
- Work space for OPDSN program is full (36000-36477 (octal) if 32K-bytes, 36000-37777 (octal) if less than 64K-bytes, and 34000-35777 (octal) if 64K-bytes).
- H17 DUPLICATE LABEL
- Last label input in OPDSN program with an LB,LL or SB,LL has been previously defined.
- H20 UNDEFINED INSTRUCTION
- Last instruction input in OPDSN program is not valid.
- E21 INVALID UNIT
- An invalid unit has raised attention following overlapping seeks. See message H33 for the order of attentions. Error occurred in test section 5, step 85. Possible cause of error is the system cable connections.
- H22 VERIFY IN STEP X
- Current operation is verify. Check the following if errors occur:
- a. Preamp
 - b. Drive Control board

c. Heads

d. Data cable attachment

H23	XXXXXX ERRORS/PASS ALLOWED	XXXXXX = unit removal threshold; the number of errors allowed per pass on a given unit before it is removed from the unit table.
H24	CYLINDER TABLE FOR DRIVE TYPE 79XX XXX, XXX, XXX, XXX, XXX, XXX, XXX, XXX, XXX, XXX, XXX, XXX	Contents of cylinder table. Only these cylinders will be read or written to if Switch Register bit 6 is set during test sections 1 thru 5.
H25	WISH TO CHANGE?	Operator types: (Y)ES or (N)O, or (E)XIT, or any of the valid inputs for the bit 2 dialogue, (U)NIT, (?)ERRS, (H)EAD, (O)UTPUT, (P)ATT, (S)OFT, (C)YL, (M)CPU, except when the diagnostic gives the default unit table entry and asks if you wish to change.
H26	ENTER CYLINDERS SEPARATED BY COMMAS	Operator types the desired cylinders, all on one line. (Refer to Appendix B, (C)YL.)
H27	PATTERN TABLE XXXXXX XXXXXX XXXXXX XXXXXX XXXXXX XXXXXX XXXXXX XXXXXX XXXXXX XXXXXX	Contents of pattern table. (XXXXXX = pattern in octal.) (See Appendix B, (P)ATT.)
H30	ENTER PATTERNS SEPARATED BY COMMAS	Operator types desired patterns, all on one line. (Refer to Appendix B, (P)ATT.)
H31	INPUT ERROR	Bad input from console device.
H32	ENTER ERRORS/PASS	Operator types number of errors/pass allowed on a unit before removing it from the unit table. (Refer to Appendix B, (?)ERRS).
H33	SEEK-STATUS XXXXXX YYYYYY XXXXXX YYYYYY . . .	XXXXXX = STATUS-1 word following each seek complete. YYYYYY = STATUS-2 word for the unit determined from STATUS-1 word. All values are octal. Any error terminates process. Refer to Appendix C for status definitions.
H34	ENTER UNIT NUMBERS (0-7) SEPARATED BY COMMAS	Operator types desired unit number(s), all on one line, which are placed in the unit table.

Appendix A

H35	STATUS IN STEP X	Current operation is status command.
H36	INITIALIZE DATA IN STEP X	Current operation is initialize data (write address). Check the following if errors occur: a. Drive FORMAT switch not ON. b. Bad spot on media. c. Device Controller board d. Microprocessor e. Preamp f. Drive Control board g. Data cable
H37	UNIT TABLE: XX DRIVE(S) A,B...	Contents of unit table. XX = number of drives. A,B... = units selected.
H40	SET READ ONLY SWITCH, PUSH RUN	Operator sets READ ONLY switch on front panel of drive.
H41	CLEAR READ ONLY SWITCH, PUSH RUN	Operator clears READ ONLY switch on front panel of drive.
H42	UNIT X ATTENTION SET-STATUS IS Y AND Z	Interrupt was unexpected; came from unit X. Y = STATUS-1 word. Z = STATUS-2 word. Check the following if errors occur: a. Device Controller board b. Microprocessor
E43	DMA MISSING	Possible causes of errors are: a. DMA/DCPC missing b. Interface
H44	SEEK IN STEP X	Current operation is seek. Check the following if errors occur: a. Device Controller board b. Microprocessor c. Check ribbon cable connection if seek executes with the DSU, but not with the computer.

- H45 WRITE IN STEP X Current operation is write. Check the following if errors occur:
- a. Device Controller board
 - b. Microprocessor
- H46 READ IN STEP X Current operation is read. Check the following if errors occur:
- a. Device Controller board
 - b. ECC board
- E47 DATA WORD XXXX IS
YYYYYY SHOULD BE
ZZZZZZ The data returned on a read operation did not match the expected data. This message is typed only for the first three erroneous words in the buffer (except for CB in test section 6). Check the Device Controller board for possible cause of error.
- E50 UNIT X MISSING-
PRESENT A,B---
(NONE) This message is output whenever the selected unit X is not ready. Any other units found to be ready are shown. Halt occurs if on first pass. Error occurs in START area. Possible causes of error are:
- a. Desired unit is not connected.
 - b. Device Controller board
 - c. I/O Sector board
 - d. Microprocessor
- H51 START CCCC/HH/SS-
LAST CCCC/HH/SS
WORD COUNT XXXXX,
OLD CYL XXXX,
UNIT XX CCCC = cylinder, HH = head, and SS = sector. Word count equals number of sectors to be verified if current operation was a verify, otherwise it equals the number of words to be transferred between the controller and the computer. The old cylinder is the previous cylinder to which a seek was issued.
- E52 BUFFER CHECKSUM
XXXXXX CYL XXXXXX
(YYYY)HD/SXXXXXX
(H=YY S=YY) The checksum should be zero and the address in parenthesis (decimal) should match the one typed out in the next H51 message. (XXXXXX = values in octal). Either the wrong sector was read or a data error occurred. Possible causes of error are:

- a. Device Controller board
- b. Microprocessor
- c. Interface

Note: Each sector is checksummed separately. The entire sector sums to zero. This six-digit octal sum is reported as the buffer checksum.

The first two words sum to the cylinder number. This six-digit octal sum is reported as the CYL. In addition, the four-digit decimal equivalent is shown in parenthesis. This equivalent is meaningless if the sum is an invalid cylinder number.

Words two and three sum to the head/sector number. The head is in the upper byte of the word and the sector is in the lower byte. This six-digit octal sum is reported as the HD/S. The decimal equivalent for each is shown in parenthesis. These values may also be meaningless for an invalid head or an invalid sector.

H53	AVERAGE SINGLE CYLINDER SEEK TIME X.XX	Time is in milliseconds. Seek covers one cylinder (length = 1). (The data is obtained in step 55.) Check the servo board or the actuator if the seek time exceeds five milliseconds and Switch Register bit 6 is clear.
H54	AVERAGE RANDOM SEEK TIME XXXX.X, LENGTH XXXX.X	Time is in milliseconds and length is in cylinders. (The data is obtained in step 81.) Check the servo board if errors occur.
H55	ENTER INSTRUCTIONS (CURRENT UNIT = XX)	Request for input in operator design section. XX = the unit to which commands will be issued unless changed by a SD instruction.
H56	UNDEFINED LABEL XX	Operator must define label or erase reference.
E57	SCREEN TEST ERROR	The flag on the disc channel sets when some other channel is referenced with a STF instruction (i.e., when the flag is set on some other channel). Check the interface for possible causes of error.
H60	SET FILE MASK IN STEP X	Current operation is set file mask. Check the following if errors occur:

		a. Device Controller board
		b. Microprocessor
H61	-----	Used to report current operation messages (not seen by operator).
H62	HEAD TABLE; UNIT XX 79XX ,N HEAD(S) A,B...	N = number of heads selected. A,B... = the head(s) which is (are) selected.
E63	NO FLAG	The device flag on the controller interface card which signifies the completion of an operation was never set. Possible causes of error are:
		a. Microprocessor
		b. Device Controller board
		c. Interface
		d. ECC board
E64	STATUS IS Z Z Z ZZZZ ZZZZ ZZZZ / SHOULD BE Z ZZZZZ Z Z Z Z Z Z Z Z	A status command did not return the expected status. Values are in ternary (X = don't care). See Appendix C for description of status words.
H65	LONG (SHORT) PASS XXXX, HEAD YYYYYY, UNIT X, AAAA ERRORS BBBB SOFT (,MULTI- UNIT)	Short replaces long if SR bits 1, 5 or 6 have been set during pass. Multi-unit is added if step 85 is run. A pass is once through test section 1 to 5. All values are decimal. AAAA = total fatal and soft errors during this pass. BBBB = number of soft errors during this pass.
H66	SET FORMAT SWITCH ON UNIT XX, PUSH RUN	Operator request in test section 1. Switch is on the front of the drive.
H67	CLEAR FORMAT SWITCH ON UNIT XX, PUSH RUN	Operator request in test section 1. Switch is on the front of the drive.
H70	UNLOAD UNIT XX, PUSH RUN	Operator should place the indicated unit off-line by setting the RUN/STOP switch on front of the drive to the STOP position.
H71	READ WITH OFFSET =YYYYYY IN STEP X	Current operation is read with offset. Current offset is YYYYYY in octal. Check the following if errors occur:

- a. Device Controller board
 - b. Track Follower board
 - c. Heads
 - d. I/O Sector board
- E72 UNIT X NOT READY
- Not ready bit in status word indicates drive is not ready for one of the following reasons:
- a. Drive not on line.
 - b. Drive not up to speed or heads not yet loaded.
 - c. Drive fault.
- Error occurs in START area.
- E73 COMMAND REJECTED
= XXXXXX
- Disc controller is not busy when it should be. The computer issues a command to the controller which sets the controller interface flag in the computer acknowledging the command. The busy bit on the controller interface is set if the command is interpreted correctly. This is tested with the SFC command. Possible causes of error are:
- a. Cables incorrectly connected to controller, or the controller crowbarred, clear the controller by turning the controller power off for a few seconds then turning it on again.
 - b. Microprocessor
 - c. Device Controller board
 - d. Interface
 - e. ECC board
- H74 SEEK WITHOUT WAIT
IN STEP X
- The current error occurred while attempting to issue a seek immediately followed by a data operation. This results in a flag being set on the controller interface, indicating the end of operation only after the data operation is complete. Check the microprocessor if an error occurs.

- E75 ADDRESS IS XXXXXX (YYYY) AND ZZZZZZ, OLD CYL = AAAA This message is output when address errors occur. XXXXXX = cylinder address read from disc (in octal). YYYY = same value in decimal. Upper byte of ZZZZZZ (which is octal) is the head read from the disc. Lower byte of ZZZZZZ is the current unit number. AAAA = the cylinder at which the heads were at before the seek was attempted. Check the servo board or track follower for possible cause of error.
- H76 RECALIBRATE IN STEP X Current operation is recalibrate. Check the following if errors occur:
- a. Microprocessor
 - b. Device Controller board
- E77 NO FLAG GETTING SYNDROME While obtaining the error syndrome with a request syndrome command, the disc interface flag failed to set within 400 milliseconds. Same as E63, except the command was request syndrome. Possible causes of error are:
- a. ECC board
 - b. Microprocessor
 - c. I/O Sector board
- H100 REQUEST SYNDROME IN STEP X Current operation is request syndrome. Check the ECC board or microprocessor if errors occur.
- H101 WRITE FULL SECTOR IN STEP X Current operation is write full sector.
- E102 NO FLAG GETTING ADDRESS While obtaining the disc address with a request disc address command, the disc interface flag failed to set within 400 milliseconds. Same as E63, except command was request disc address. Possible causes of error are:
- a. Microprocessor
 - b. I/O Sector board
 - c. Drive Control board

Appendix A

E103 DISC SUBSYSTEM DOES NOT RESPOND (S.C. = XX)	XX = select code diagnostic was configured for. Possible causes of error are: a. Controller power off or crowbarred. b. Disc select code configured wrong. c. Dirty edge connectors. d. Device Controller board e. Microprocessor f. Interface board g. Ribbon cable connection between error correction board and microprocessor board not made. h. Cable connection between computer and controller not made.
H104 REQUEST SECTOR ADDRESS IN STEP X	Current operation is request sector address. Check the microprocessor if errors occur.
E105 SECTOR ADDRESS ERROR	Address returned by request sector address not correct. Error occurred in test section 1, step 35. Possible causes of error are: a. I/O Sector board b. Microprocessor
H106 ENTER HEADS SEPARATED BY COMMAS	Operator types heads to be entered into the head table, all on one line.
H107 READY UNIT XX	Load heads on unit XX. Message from section 1, step 15.
H110 PRESS PRESET(S), PRESS RUN	Message from test section 1, step 20.
H114 CYLINDER XXXX HEAD YY FLAGGED DEFECTIVE	Track has been flagged defective at test section 1, step 12, or in OPDSN instruction FH due to excessive errors.
H115 COLD LOAD READ IN STEP X	Current operation is cold load read. Check the ECC board if errors occur.
H116 DATA ERROR CORRECTED	This message is output if the words read have been corrected by the syndrome.

H117 READ WITHOUT VERIFY IN STEP X	Current operation is read without verify. Check the microprocessor if errors occur.
E120 FATAL ERROR	This error is sufficient to crash an operating system.
H121 WARNING - FORMAT SWITCH OFF	The controller is more thoroughly tested when the FORMAT switch is on.
H122 END IN STEP X	Current operation output to controller is END/POLL command.
H123 REQUEST DISC ADDRESS IN STEP X	Current operation is request disc address. Check the following if errors occur: <ul style="list-style-type: none"> a. Microprocessor b. ECC board
E124 DISC ADDRESS ERROR	A seek was issued to the controller. This was followed by a request disc address command which returned a cylinder, head/sector combination different from that to which the seek was issued. Value returned is shown as "last" in H51 message. Check the microprocessor or device controller if error occurs.
H125 EXCESSIVE BAD TRACKS	There are fewer than 406 useable tracks on a surface for a 7905/7906, or 815 useable tracks for a 7920/7925. A track is determined defective and not useable if after being initialized, the diagnostic is not able to verify it in any of five attempts. Errors occurred in test section 6. Replace the cartridge/pack currently being used.
H126 SOFT ERRORS WILL (NOT) BE PRINTED	The (not) part is deleted if soft errors are printed during diagnostic execution. (Soft errors are always printed during OPDSN execution.)
E127 INTERFACE FIFO MALFUNCTION	Error is probably due to a faulty FIFO on the interface card. Error occurred in the START area.
H130 NO UNITS IN THE UNIT TABLE ARE CONNECTED	Ensure that correct unit number has been selected on front of drive.

Appendix A

H131	WARNING: DRIVE TYPE OF UNIT HAS CHANGED	It may be necessary to revise drive dependent parameters (unit and head tables) via bit 2 dialogue. Drive type associated with a given unit has changed from one drive type to another between passes of the diagnostic. This message is output if a unit which was off line comes on line, or vice versa.
H132	TYPE UNITS YOU WISH TO CHANGE SEPARATED BY COMMAS	Operator types the unit number for those units whose head table is to be changed. (See Appendix B.)
H133	UNIT XX IS NOT CONNECTED	Unit XX is in unit table, but is not connected to controller.
H134	EXPANDED OUTPUT (NOT) USED FOR STATUS	For expanded output, message H135 is used in addition to E64 message.
H135	S P D TSTAT XXXX UNIT / E DRTYPE X A P F DF FS SC NR B	Status of last sector transferred to controller. S = spare bit indicator on sector, P = protect bit indicator on sector, D = defective bit indicator on sector, TSTAT = termination status, XXXX = not assigned, E = (refer to Appendix C, STATUS-2 word), DRTYPE = 000010 for 7905, 000000 for 7906, 000001 for 7920, and 000011 for 7925, X = not assigned A = drive attention, P = PROTECT switch on drive set, F = FORMAT switch on drive set, DF = Drive Fault, FS = first status to appear after the heads load, SC = Seek Check, NR = Drive Not Ready, B = drive busy.
H136	TERMINATION STATUS WILL (NOT) BE PRINTED	Defines termination status. Refer to Appendix C, STATUS-1 word, for definition. Message H137 is output when status is printed.
H137	TERMINATION STATUS IS XXXXXX SHOULD BE XXXXXX	Refer to Appendix C, STATUS-1 word, for definition. The "SHOULD BE..." statement is omitted if it is the same as the "STATUS IS..." statement. XXXXXX = the abbreviated definition.

- H140 ENTER:(U)NIT,
(?)ERRS,(H)EAD,
(O)UTPUT,(P)ATT,
(S)OFT,(C)YL,
(M)CPU,(E)XIT Enter the contents of the parentheses to
modify that specific table.
Example - Type U to modify the unit
table.
- H141 CYL = XXXX, HD =
XX, UNIT = XX
(PROTECTED)
(DEFECTIVE)
(SPARE) Designates spare, defective, or protected
track. This is the result of VP, VD, and
VS command in an OPDSN program.
- H142 PROTECT X/D,
PUSH RUN Operator sets the specific PROTECT
switch.
- H143 CLEAR X/D PROTECT,
PUSH RUN Operator clears the specific PROTECT
switch.
- H144 NEVER GOT FLAG ON
WAKEUP UNIT = XX Attempted to output WAKEUP command to
unit XX, however, did not receive flag
indicating its acceptance. Check to make
sure all other CPU's running are in MCPU
mode. If no problems occurred in single
CPU testing, the problem may be due to
the device controller.
- H145 UNEXPECTED
INTERRUPT WHEN
TRYING XXXXXX
COMMAND An interrupt occurred on the controller
channel when attempting to output one
of the commands in the command
sequence for the MC OPDSN command.
- H146 CURRENTLY (NOT)
IN MCPU MODE Used in telling operator the mode of
operation of the diagnostic. If no
problems occurred in single CPU testing,
the problem may be due to the device
controller.

BIT 2 DIALOGUE	APPENDIX B
----------------	---------------

Set Switch Register bit 2 to enter the bit 2 dialogue. (The diagnostic will complete the current test section before branching to the dialogue.)

Bit 2 dialogue outputs message H140 ENTER:(U)NIT,(?)ERRS,(H)EAD,(O)UTPUT,(P)ATT,(S)OFT,(C)YL,(M)CPU,(E)XIT.

Select the area to be changed or examined by typing the letter in the parenthesis.

In response to the message, H25 WISH TO CHANGE?, type (Y)ES, or (N)O, or (E)XIT, or any of the above letters in parenthesis in the H140 message to change that specific area.

Each area of message H140 is defined as follows:

- a. (U)NIT is the unit table. The units to be tested by the diagnostic are listed in this table. The unit table must be totally reconstructed with each change (i.e., to add unit 2 to units 0 and 1 currently in the unit table, type: 0,1,2).
(Default at initial diagnostic load = unit 0)
- b. (?)ERRS is the unit removal threshold per pass. When the number of errors per pass listed in the error table is reached during diagnostic execution, the unit being tested is removed from the unit table.
(Default = 40 errors per pass)
- c. (H)EAD is the head table. The heads used in the diagnostic are listed in this table. A separate head table exists for each unit in the unit table (the unit must be ready at the beginning of the current pass). The head table for a given unit must be totally reconstructed with each change.
(Default at initial diagnostic load = heads 0 and 1 for 7905/7906, 0-4 for 7920, and 0-8 for 7925)
- d. (O)UTPUT allows the operator to determine the heading (H135 S P D TSTAT... and E64 STATUS IS... or just E64 alone) to be used when status is output.
(Default = messages H135 and E64)

Bit 2 Dialogue

It also allows the operator to determine whether or not message H137 TERMINATION STATUS IS XXXXX SHOULD BE XXXXX is output.

(Default = H136 TERMINATION STATUS WILL BE PRINTED)

- e. (P)ATT is the pattern table (the ten patterns used in test section 2). The patterns are replaced in the order that they are entered. Consecutive commas imply no change.

Example: In response to message H30 TYPE PATTERNS YOU WISH TO CHANGE SEPARATED BY COMMAS, type: 123232,,,177777

Pattern table before change:

155555	177777	125252	055555	007417
.

Pattern table after change:

123232	177777	125252	055555	177777
.

When the first pattern of the pattern table is used by the diagnostic, the pattern is transposed into a 48-bit pattern by making the second word of the pattern the same as the first, but rotated left one bit (133333). The third word is the same as the second, but it is rotated left one bit with the last bit equal to zero (066666). This results in each sector having the bit pattern 110 repeated throughout it. If the first pattern in the pattern table is changed, some other 48-bit pattern will be generated.

(Default pattern table at initial diagnostic load =

155555	177777	125252	055555	007417
170360	162745	000000	163346	022222)

- f. (S)OFT allows the operator to determine whether or not soft errors are printed.

(Default at initial diagnostic load = H126 SOFT ERRORS WILL BE PRINTED)

- g. (C)YL is the cylinder table (contains twelve cylinder numbers). A separate cylinder table exists for each drive type. The cylinders are replaced in the order that they are entered. (See example in step e, (P)ATT.)

(Default = For 7905/7906: 0, 1, 2, 4, 8, 16, 32, 64, 128, 192, 256, and 410. For 7920/7925: 0, 1, 2, 5, 8, 17, 32, 65, 128, 257, 512, and 822)

- h. (M)CPU tells you whether or not you are in MCPU (multiple CPU testing) mode.

This test should be used only after each CPU has been checked out thoroughly with the rest of the disc subsystem in a single CPU environment. Refer to paragraph 3-5 for information concerning multiple CPU testing.

(Default = not in MCPU mode)

- i. (E)XIT resets Switch Register bit 2 and causes the diagnostic to branch out of the bit 2 dialogue and begins to execute the diagnostic as indicated by the Switch Register options.

STATUS, OFFSET, AND
FILE MASK DEFINITIONS

APPENDIX

C

STATUS-1 WORD

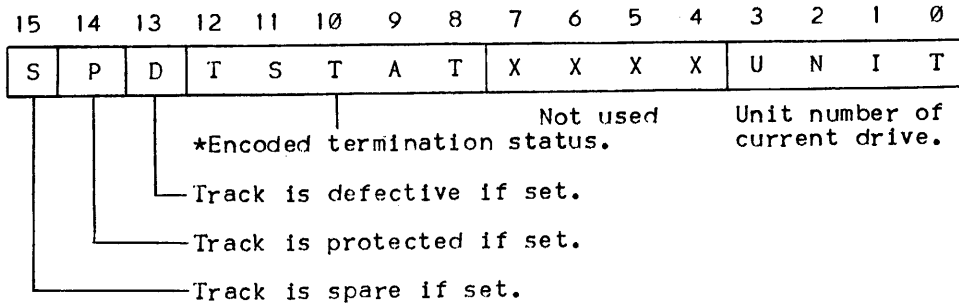

*Encoded termination status

STATUS-1 WORD (octal)	TSTAT (binary)	DEFINITION
000000	00000	No errors. (NORMAL COMPLET)
000400	00001	Illegal opcode. (ILLEGAL OPCODE)
001000	00010	Unit available. (UNIT AVAILABLE)
003400	00111	Cylinder compare error. (CYL CMP ERR)
004000	01000	Uncorrectable data error. (UNCOR DATA ERR)
004400	01001	Head-sector compare error. (HD/SEC CMP ERR)
005000	01010	I/O program error.
006000	01100	End of cylinder. (END OF CYLNDER)
007000	01110	Data overrun. (OVERRUN)
007400	01111	Possibly correctable data error. (POSS CORR DATA)
010000	10000	Illegal access to spare track. (SPR TRK ACCESS)
010400	10001	Defective track. (DEFECTIVE TRK)
011000	10010	Access not ready during data operation. (ACCSS NR DATOP)
011400	10011	Status-2 error. (STATUS-2 ERROR)
013000	10110	Attempt to write on protected or defective track. (WRT PROTEC TRK)
013400	10111	Unit unavailable. (UNIT UNAVAIL)
017400	11111	Drive attention. (DRIVE ATTENTION)

STATUS-2 WORD

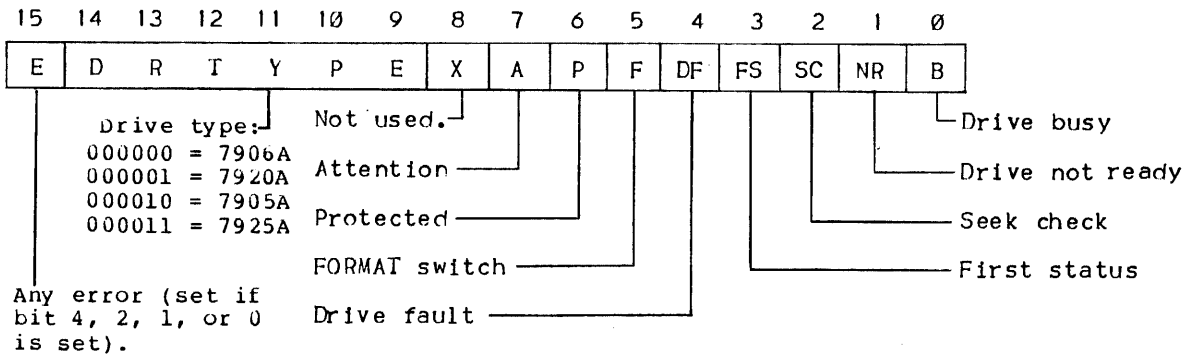

OFFSET WORD

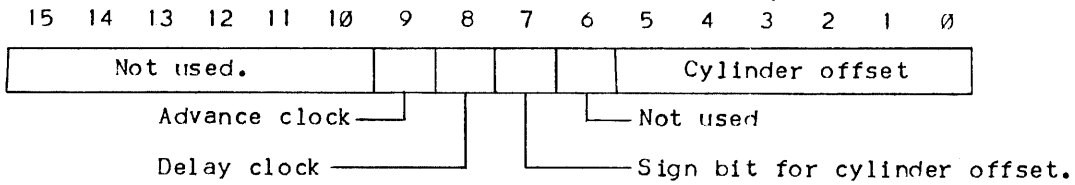

MASK

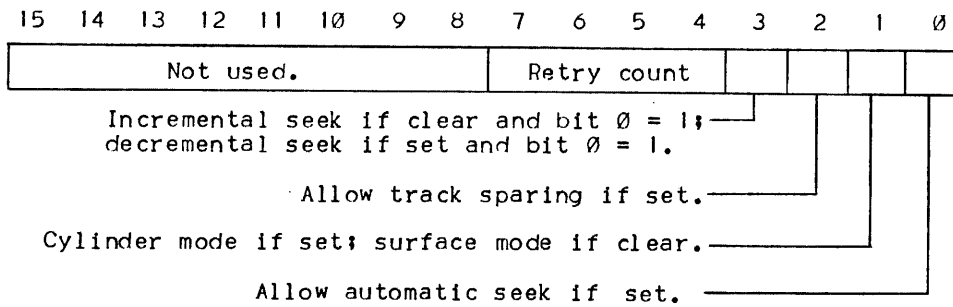

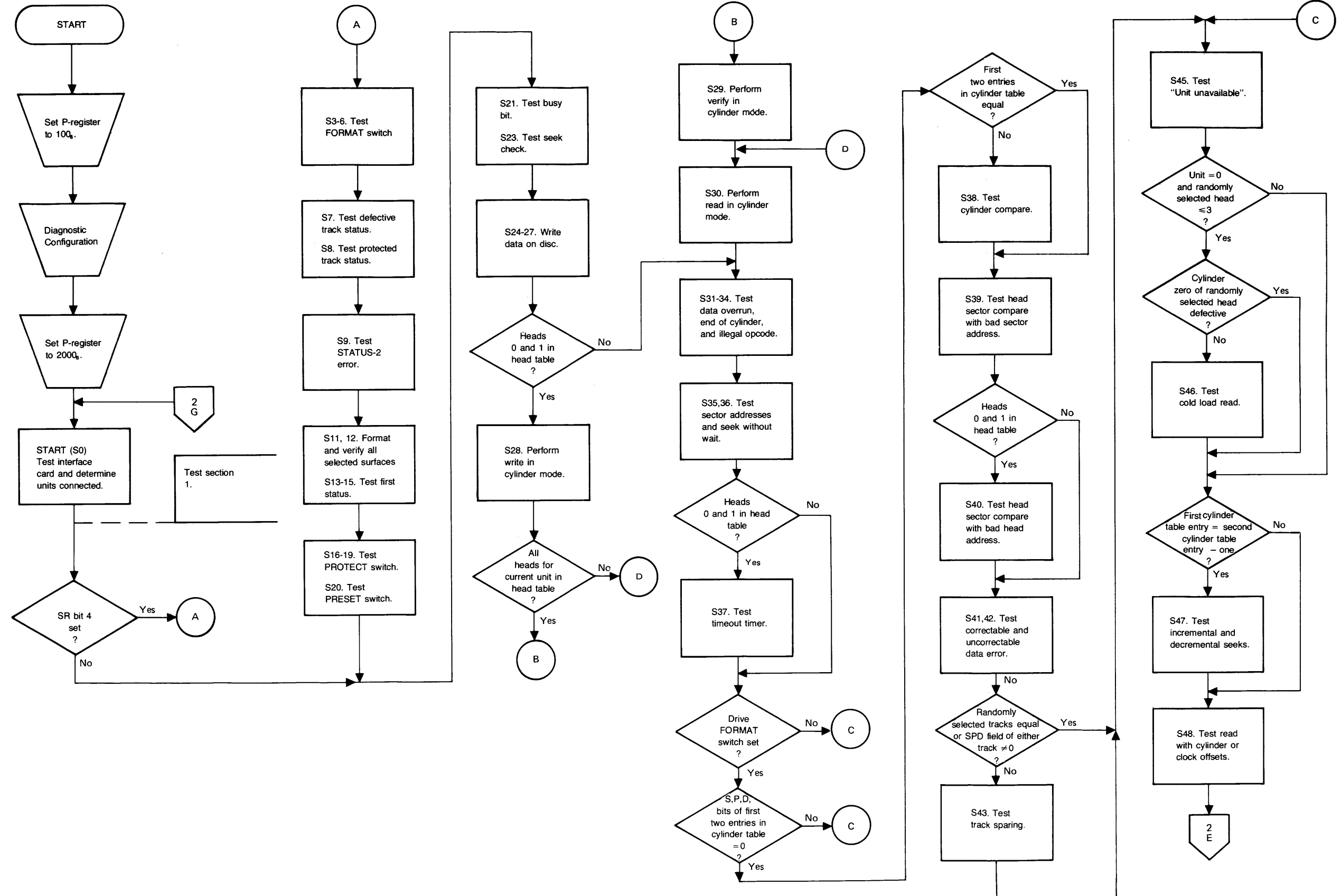

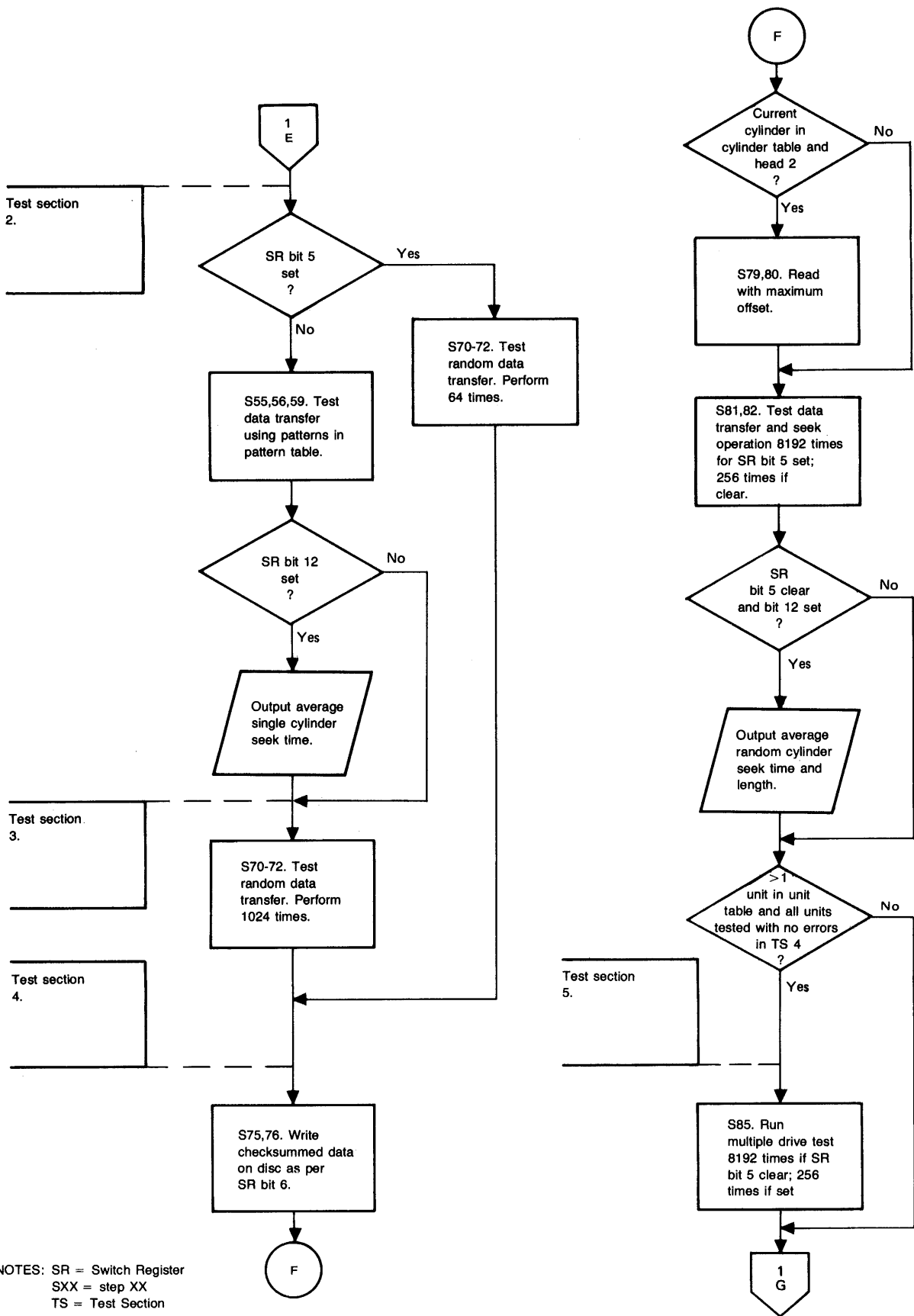

NOTES: SR = Switch Register
 SXX = step XX
 TS = Test Section