

MODEL HP 2000
COMPUTER SYSTEM

HP PART NUMBER 22687-90005

MICROFICHE NO. 22687-90006



5303 STEVENS CREEK BLVD., SANTA CLARA, CALIFORNIA, 95050

LIST OF EFFECTIVE PAGES

The List of Effective Pages gives the most recent date on which the technical material on any given page was altered. If a page is simply re-arranged due to a technical change on a previous page, it is not listed as a changed page. Within the manual, changes are marked with a vertical bar in the margin.

Pages	Effective Date
Title	Apr 1977
ii to ix.	Apr 1977
1-0 to 1-13.	Apr 1977
2-1 to 2-4.	Apr 1977
2-1 to 2-4.	Apr 1977
3-1 to 3-48.	Apr 1977
4-1 to 4-25.	Apr 1977
5-1 to 5-11.	Apr 1977
6-1 to 6-32.	Apr 1977
7-1 to 7-11.	Apr 1977
A-1 to A-12	Apr 1977
B-1 to B-18	Apr 1977
C-1 to C-3	Apr 1977
D-1 to D-3	Apr 1977
E-1 to E-6	Apr 1977
F-1 to F-3	Apr 1977
G-1 to G-6	Apr 1977
H-1 to H-8	Apr 1977
I-1 to I-7	Apr 1977

PRINTING HISTORY

New editions incorporate all update material since the previous edition. Update packages, which are issued between editions, contain additional and replacement pages to be merged into the manual by the customer. The date on the title page and back cover changes only when a new edition is published. If minor corrections and updates are incorporated, the manual is reprinted but neither the date on the title page and back cover nor the edition change.

First Edition	Sep 1975
Update Number 1	Oct 1975
Second Edition	May 1976
Update Number 1	Jul 1976
Update Number 2	Sep 1976
Update Number 3	Jan 1977
Third Edition	Apr 1977

This manual is planned primarily for use by a system operator. It explains how to generate and operate an HP 2000 Computer System. We have also included information of particular interest to a system manager because the operator often assumes the duties of a manager as well. This manual does not include information about operating and maintaining each system hardware component; it presents information that is relevant to system operation in general.

By dividing this manual into seven sections and five appendices, and then subdividing each section many times, we have created a Table of Contents suitable for quick reference. To also aid you in locating information, there is an index containing many additional entries.

After reading this manual you may want to refer to the following publications:

- *Learning Timeshare BASIC* part number 22687-90009
This manual introduces you to BASIC language programming on Hewlett-Packard timesharing systems.
- *HP 2000 BASIC Reference Manual* part number 22687-90001
This user's reference manual is the primary source of reference for those programming in BASIC on an HP 2000 Computer System. It contains functional descriptions of the BASIC language and specifications for every command and statement.
- *HP 2000 BASIC User's Pocket Guide* part number 22687-90003
This is a concise BASIC User's reference card.
- *HP 2000 System Operator's Pocket Guide* part number 22687-90007
This reference card summarizes operator commands and frequently used operating procedures.

CONTENTS (continued)

System Death Procedure	5-1	User Icode Organization	7-2
Warmstart Procedure	5-2	Account Accessing Capabilities	7-3
Salvage Dump	5-2	Private Library — Private User	7-4
System Halts — System Unresponsive	5-3	Group Library — Group Master	7-4
Parity Error	5-3	System Library — System Master	7-4
I/O Processor Halted	5-3	Library Manipulations	7-5
Main Processor Halted	5-4	System Purge	7-5
Both Processors Halted	5-4	Selective Dump, Load, and Restore	7-6
Neither Processor Halted — Devices		System Usage Documentation	7-7
Do Not Respond	5-5	System Backup Schemes	7-8
Diagnostic Error Messages	5-5	Organizing Tape Storage	7-9
Cold Dump Routine	5-7	Tape Requirements	7-9
Obtaining an IOP Memory Map Listing	5-8	Rotating Backup Tapes	7-9
Obtaining an IOP Memory Dump	5-9	Reloading From Backup Tapes	7-10
Power Failures	5-10	New Systems	7-11
Power Failure During Shutdown	5-11		
Power Failure During Startup	5-11	Appendix A	Page
Power Failure While System is Shut Down	5-11	CONFIGURING THE I/O PROCESSOR	A-1
		Configuration Guidelines	A-1
Section VI	Page	Dialogue Conventions	A-3
DATA COMMUNICATIONS		Configuration Dialogue	A-4
Facility Requirements	6-1		
Remote Job Entry Communications	6-4	Appendix B	Page
RJE Operator Commands	6-8	HALT CODES AND ERROR MESSAGES	B-1
System Connect Command	6-8		
Device Assignment Command	6-10	Appendix C	Page
Start Reader Command	6-11	DISC ERRORS	C-1
Restart Reader Command	6-12	System Loading or Shutdown Disc Errors	C-1
Terminate Reader Command	6-13	Disc Errors During System Operation	C-1
Remote Command	6-13		
System Disconnect Command	6-16	Appendix D	Page
Error Report Command	6-16	BBL LOADING	D-1
Load Command	6-18		
Terminate Printer Command	6-18	Appendix E	Page
Transfer to Printer Command	6-19	DISC ADDRESS CONVERSION TABLES	E-1
Read Transparent Command	6-19		
Using RJE	6-20	Appendix F	Page
Host System Control Statements	6-20	CONVERT (HP 2000 FILE CONVERSION	
Entering a Job	6-21	PROGRAM)	F-1
Job Output	6-21	CONVERT Operating Procedure	F-1
2000 to 2000 Communications	6-23	File Protection	F-3
2000 to 2000 Operator Commands	6-24		
System Connect Command	6-25	Appendix G	Page
Device Assignment Command	6-25	GLOSSARY	G-1
Start Reader Command	6-26		
Restart Reader Command	6-27	Appendix H	Page
Terminate Reader Command	6-27	FORMS	H-1
Remote Command	6-28	Copy and Bestow Requests Form	H-3
Error Report Command	6-28	Load, Restore and Dump Requests Form	H-5
System Disconnect Command	6-29	Problem Report Form	H-7
Using the 2000 to 2000 Facility	6-30		
2780 to 2780 Communication	6-31	Appendix I	Page
2780 to 2780 Operator Commands	6-31	INDEX	I-1
Section VII	Page		
THE SYSTEM MANAGER			
Supervisory Planning	7-1		
Operating Considerations	7-2		

ILLUSTRATIONS

Title	Page	Title	Page
HP 2000 Computer System Organization.....	1-0	Elements of an HP 2000 Data	
Typical Processor Placement.....	1-2	Communications Facility.....	6-2
Examples Illustrating Format Conventions.....	3-1	Host Function Organization.....	6-5
A Sample Device Listing.....	3-14	Establishing an MRJE W/S Communication Link.....	6-19
A Sample Directory Listing.....	3-16	IBM-MRJE/WS Forms Assignment.....	6-21
A Sample Report Listing.....	3-29	Idcode/Group Account Structure.....	7-3
A Sample Roster Listing.....	3-31	A Four-week Backup Tape Rotation Scheme.....	7-10
Status Listing Format.....	3-34	A Two-week Backup Tape Rotation Scheme.....	7-11
A Sample Status Listing.....	3-36	A Sample I/O Processor Configuration	
Operating Procedures Overview,		Dialogue.....	A-10
Flow Diagram.....	4-2	Basic Binary Loader (BBL) Listing.....	D-2
Pre-Cold Dump Procedure.....	5-6	Conversion Dialogue — Restore Example.....	F-2
A Program That Reads from		Conversion Dialogue — Dump Example.....	F-2
Magnetic Tape.....	5-9		

TABLES

Title	Page	Title	Page
Disc Drive Model Combinations.....	1-3	MRJE and 2770/2780/3780 Emulator.....	6-16
Terminal Features Required by HP 2000		CDC Communication Error Report Items.....	6-16
Computer System.....	1-5	Local and Remote 2000 Host Function	
Terminal Models Representative of		Organization.....	6-22
Terminal Types.....	1-6	Summary of 2000 to 2000 Operator Commands.....	6-23
Terminal Characteristics.....	1-7	2000 to 2000 Error Report Items.....	6-28
Data Set Options Compatible with HP 2000		2000 to 2000 System Disconnect Codes.....	6-29
Computer System.....	1-8	Main Processor Halt Codes.....	B-1
I/O Devices Supported by HP 2000		I/O Processor Halt Codes.....	B-3
Computer System.....	1-10	Device Status Messages.....	B-4
I/O Processor Interface Slot Requirements.....	1-12	Command Error Messages.....	B-5
HIBERNATE Procedures.....	3-20	Data Communications Error Messages.....	B-9
SLEEP Procedures.....	3-33	Master Program Error Messages.....	B-10
Compatible Operating Systems.....	6-2	I/O Processor Configurator Error Messages.....	B-11
HP 2000 Modem Specifications for		System Load/Shutdown Error Messages.....	B-13
Data Communications.....	6-3	Warmstart Diagnostic Messages.....	B-17
Host Functions for MRJE Workstations.....	6-4	HP 2883 Disc Relative Block Numbers.....	E-3
HP 2000 ASCII Job Function Designators.....	6-5	HP 7900 Disc Relative Block Numbers.....	E-4
A Summary of RJE Operator Commands.....	6-6	HP 7905 Disc Relative Block Numbers.....	E-5
Summary of IBM 360 HASP Remote Commands ..	6-13	HP 7920 Disc Relative Block Numbers.....	E-6
Summary of Some IBM ASP Remote Commands ..	6-13	Security After RESTORE from 2000/F Files.....	F-3
Summary of CDC EXPORT/IMPORT Remote		Security After DUMP from HP 2000 BASIC	
Commands.....	6-14	Formatted Files.....	F-3
RJE System Disconnect Codes.....	6-15		

CONVENTIONS USED IN THIS MANUAL

NOTATION	DESCRIPTION
[]	An element inside brackets is <i>optional</i> . Several elements stacked inside a pair of brackets means the user may select any one or none of these elements. Example: $\begin{bmatrix} A \\ B \end{bmatrix}$ user may select A or B or neither
{ }	When several elements are stacked within braces the user must select one of these elements. Example: $\left\{ \begin{array}{l} A \\ B \\ C \end{array} \right\}$ user must select A or B or C.
italics	Lowercase italics denote a parameter which must be replaced by a user-supplied variable. Example: CALL <i>name</i> <i>name</i> one to 15 alphanumeric characters.
underlining	Dialogue: Where it is necessary to distinguish user input from computer output, the input is underlined. Example: NEW NAME? <u>ALPHA1</u>
superscript C	Control characters are indicated by a superscript C Example: Y ^C
<i>return</i>	<i>return</i> in italics indicates a carriage return
<i>linefeed</i>	<i>linefeed</i> in italics indicates a linefeed
...	A horizontal ellipsis indicates that a previous bracketed element may be repeated, or that elements have been omitted.

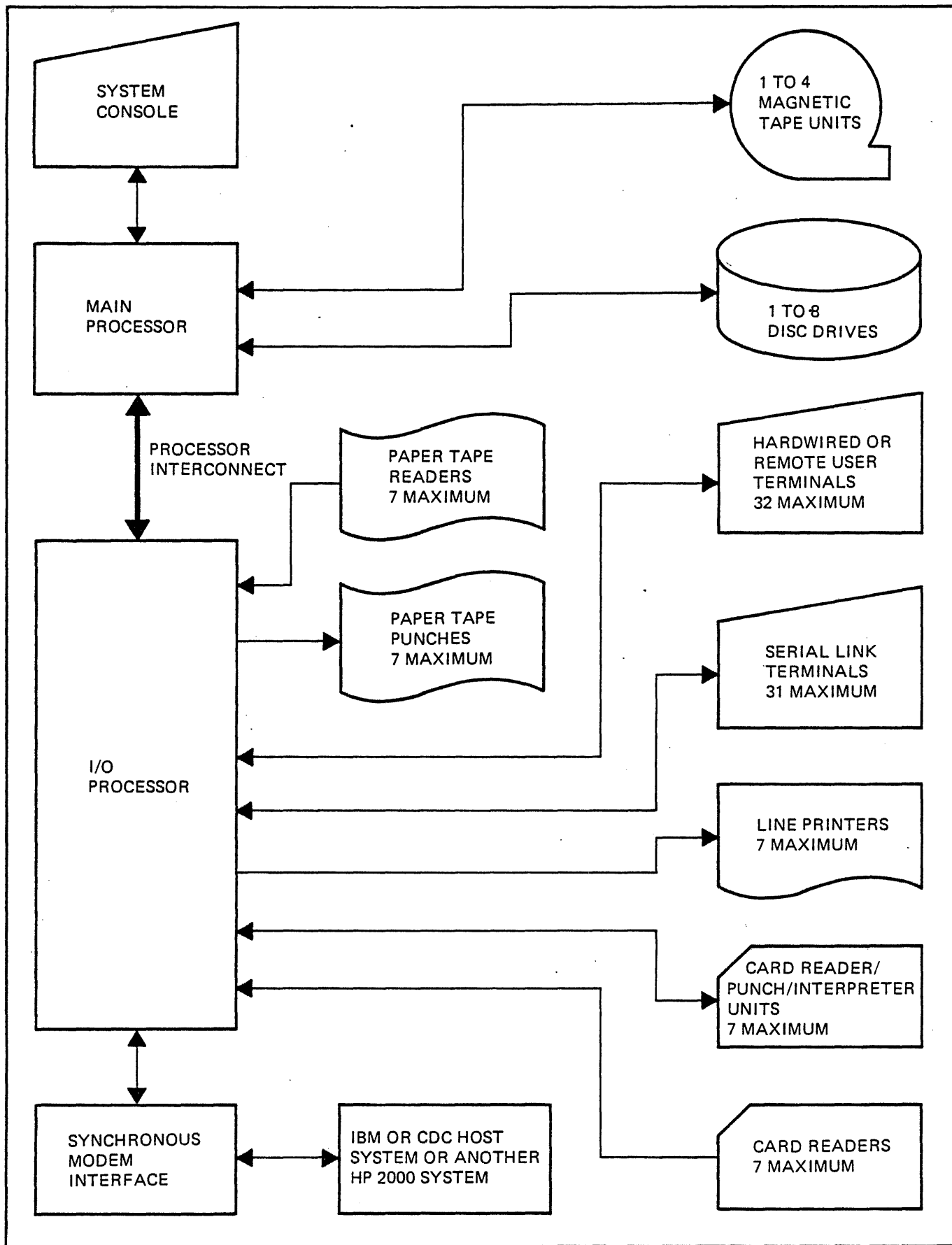

Figure 1-1. HP 2000 Computer System Organization

INTRODUCTION

SECTION

I

This section introduces you, the system operator, to an HP 2000 Computer System. We present overviews of system capabilities; the hardware and how it is organized; and the software.

THE HP 2000 COMPUTER SYSTEM

The Hewlett-Packard 2000 Computer System is a timesharing system; up to 32 users can simultaneously access the system from local or remote terminals. Users interact conversationally with the system to develop programs, store and retrieve data, receive computer assisted instruction, or perform any of a long list of multi-terminal activities. The 2000 System includes a Data Communications facility, making it possible for users to pass data between two 2000 Systems or to submit jobs from the HP 2000 for processing on another computer.

An HP 2000 facility includes not only system hardware and software, but also the personnel who supervise and control the system. Generally, two people are responsible for operating the system: a system manager and a system operator. The system manager establishes how system resources will be utilized and plans overall operating procedures to assure smooth, efficient daily activities. (Section VII of this manual is devoted to the system manager and his duties.) You, the system operator, are responsible for executing the system manager's plans. You control the equipment, produce reports, aid timesharing users and generally perform all the tasks involved with keeping a system running. Sometimes you will also serve as an operator for the Data Communications facility. This system feature allows users to remotely access another computer system. Your duties as Data Communications operator are discussed in Sections II and VI.

Central to system hardware are two processing units. The main processor executes BASIC programs, and the communications processor (also known as the I/O processor) handles input/output operations. Additionally, the system uses magnetic tape units, disc drives, a system console, and various optional input/output devices.

The HP 2000 Operating System software (HP 22687A) resides in both processors. It controls the system, accumulates system usage information, maintains a multi-level library, and handles all I/O operations for terminal users and the Data Communications facility. A significant system feature permits programmable access to input/output devices. As a result, users can initiate I/O operations on devices other than their own terminals.

Commands are used for communicating with the system. Some commands are entered by you at the system console. Others can be entered only through a terminal by the system master or the system operator. Still others can be entered by any logged-on user. The operator's commands are presented alphabetically in Section III of this manual, while the user commands are presented in the *HP 2000 BASIC Reference Manual* (part number 22687-90001).

SYSTEM HARDWARE

Five general categories of hardware are discussed in the following paragraphs. They are:

- Processors
- Mass storage devices
- The system console
- User terminals
- Input/output devices

Since it is possible to include many different components in a system (refer to figure 1-1), system configurations vary widely from one installation to another. For this reason, the following hardware descriptions are general and you should obtain actual device operating procedures from the manual supplied with each device.

PROCESSORS

Two interconnected computers jointly handle processing. The primary computer (called either the main or system processor) operates with 32K words (64K bytes) of memory to control the system, execute user programs and handle I/O for discs and magnetic tape devices. The communications processor (subsequently called the I/O processor) operates with 16K, 24K, or 32K words of memory. It handles operations involving user terminals, modems, I/O devices and data communications. The processors are always two of a kind — meaning the system is always configured with either two HP 2100 processors, two HP 21MX processors, or two HP 21MX E-Series processors. (Whenever 21MX processors are mentioned, the reference is intended to include 21MX E-Series processors as well, unless specific differences are pointed out.)

Because the processors are always two of the same type, the question of distinguishing between the two arises. Figure 1-2 illustrates the positions the processors occupy in system cabinets. Although all components might not be mounted exactly as shown, the processors will usually be mounted in the same relative locations (that is, the main processor above the I/O processor).

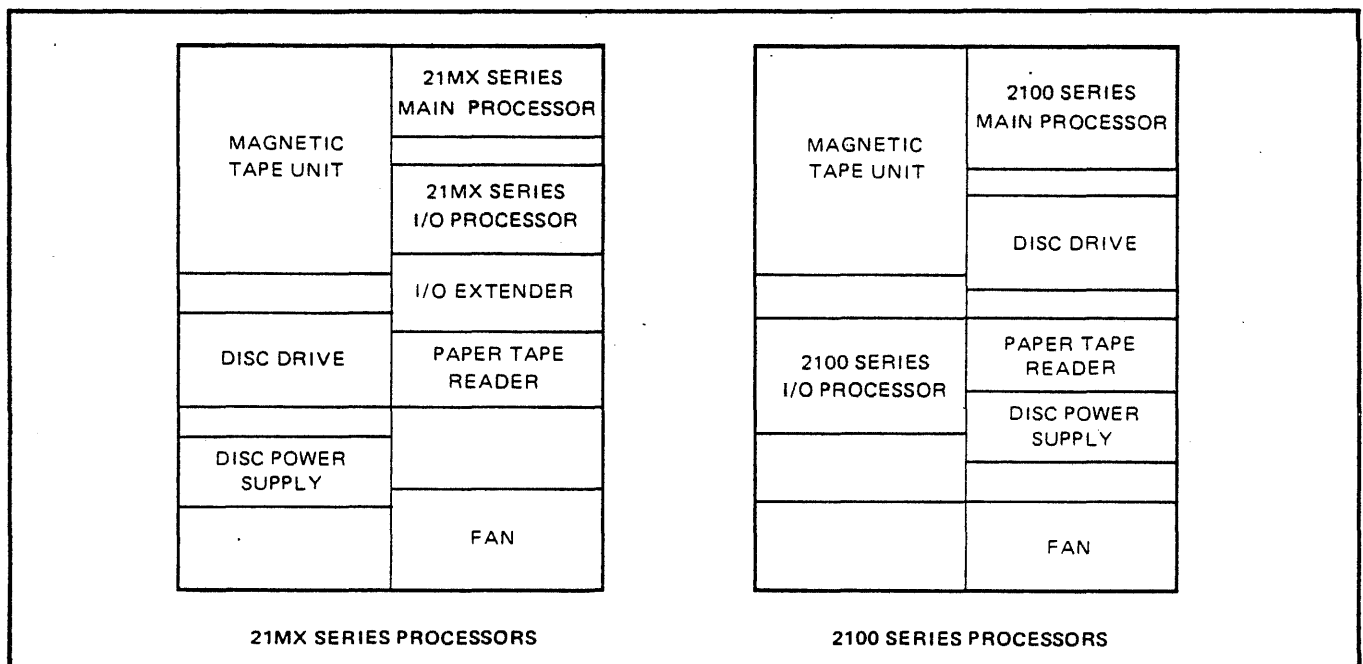

Figure 1-2. Typical Processor Placement

Main Processor

A main processor operates with the following:

- 32K words of memory (1K = 1024 decimal)
- Direct Memory Access (DMA) or Dual Channel Port Controller (DCPC)
- A time base generator
- Floating point hardware
- Processor interconnect kit

After initial system configuration, the main processor operates virtually without intervention.

I/O Processor

The I/O processor operates with the following:

- 16K, 24K or 32K words of memory depending on your system's I/O device configuration (1K = 1024 decimal)
- Direct Memory Access (DMA) or Dual Channel Port Controller (DCPC)
- A time base generator
- One asynchronous channel multiplexer for each 16 user terminals
- One data set control interface for each 16 user terminals
- One module of microcode in ROM's (part number 13206A) for HP 2100 I/O processors; or two modules of microcode in ROM's (part number 13207A) for HP 21MX I/O processors; or one module of microcode in ROM's (part number 22702A) for HP 21MX E-Series I/O processors.

During normal operation, the I/O processor requires no intervention.

MASS STORAGE — DISC DEVICES

HP 2000 Computer System storage can consist of from one to eight disc drives. The disc units provide storage for system programs and tables and for user libraries. A disc drive can be an HP 7905, HP 7900, HP 7920 or HP 2883 model. Table 1-1 lists the combinations possible within a configured system. Note that a system never operates with both 2883's and 7900's.

Table 1-1. Disc Drive Model Combinations

Any combination of HP 2883, 7900, 7905 and 7920 disc drives is allowed except a combination that includes 7900's and 2883's. A maximum of eight disc drives is allowed on a system.		
all 2883's all 7900's all 7905's all 7920's	2883's and 7905's 2883's and 7920's 7900's and 7905's 7900's and 7920's 7905's and 7920's	2883's, 7905's and 7920's 7900's, 7905's and 7920's
Disc Controller	Each Disc Controller Handles	Each Disc Controller Requires
2883	2 disc drives	2 I/O slots
7900	4 disc drives	2 I/O slots
7905/7920	8 disc drives	1 I/O slot

Introduction

A controller interfaces a disc drive to the computer. It passes commands to the disc and transfers data in both directions. One controller can support up to four HP 7900 devices, two HP 2883 devices, or a mixture of up to eight HP 7905 and 7920 devices. Disc controllers plug into I/O slots inside the main processor. Those for HP 7900 and 2883 discs require two I/O slots while a controller for HP 7905 and 7920 discs requires only one slot.

SYSTEM CONSOLE

The system console is often called the operator's console because it is used exclusively by the system operator to generate, load, update, monitor, and control the system. You enter commands, respond to system prompts, and record all system activity on either an HP 2762A or an HP 2754A/B teleprinter.

The system normally prints a log on the console reflecting both terminal and system activity. Each time a user logs on or off, the system records his identification code, port number, and the current time. System activity messages printed on the console inform you of I/O device status (for instance, when a line printer is out of paper), disc errors, and console keyboard entry errors. If your system console is an HP 2654A/A teleprinter, the activity log may also be optionally punched on paper tape.

The HP 2000 system operator's console also serves as the Data Communications console when your system communicates with a remote IBM, CDC, or another HP 2000 System.

USER TERMINALS

The system handles 32 terminals operating concurrently. A terminal can be either a hardcopy or CRT type. An HP 7260A Optical Card Reader can also be connected in parallel with a terminal to add card reading capability. Individuals use terminals to execute programs, and to communicate with the system, with I/O devices and with you, the system operator. Terminals communicate with the system over telephone lines or through hardwired connections.

Different terminal makes and models can be connected to your system so long as they provide features required by the HP 2000 Operating System software. A terminal is of a particular type according to the features it provides. When a user logs on the system he includes a number defining the *type* of terminal he is using. Features expected of each terminal type are listed in table 1-2. Models representative of each terminal type are listed in table 1-3. Terminal characteristics are listed in table 1-4.

Terminals equipped with the automatic linefeed feature (user selectable) must be operated with this feature OFF. Although cursor, form feed, horizontal and vertical tabulation, and various special function keys might be provided on a terminal, these capabilities are available only under the control of a user's application program.

Multiplexers and Data Set Controls

Terminals are connected to the I/O processor through asynchronous multiplexers. Two multiplexers can be installed in the processor I/O slots; each capable of supporting up to 16 ports. In addition, one data set control interface associated with each multiplexer allows remote terminals to be connected through data sets or equivalent modems. Any combination of 16 hardwired terminals and data sets or modems may be connected and operated concurrently through each asynchronous multiplexer. The data sets listed in table 1-5 are compatible with the HP 2000 Operating System software.

Data Transfer Rates

Data transfers from the I/O processor to a terminal and from a terminal to the I/O processor occur at the same rate. The following transmission rates are supported: 110, 134.5, 150, 300, 600, 1200, and 2400 bits per second. The system automatically detects each terminal transmission rate and character parity when a user presses the return and linefeed keys prior to typing the HELLO command.

Table 1-2. Terminal Features Required by HP 2000 Computer System

TERMINAL TYPE	DELAYS*						CHARACTER ECHOED ON RECEIPT OF CONTROL-H
	110	150	300	600	1200	2400	
0	1,0	0,0	0,0	0,0	0,0	0,0	backarrow (←) or underline (_)
1	0,0	0,0	0,0	0,0	0,0	0,0	none
2	0,0	0,0	0,0	0,0	0,0	0,0	none
3	0,0	0,0	0,0	0,0	4,0	4,0	control-Y
4	0,3	0,5	0,9	0,0	0,36	0,0	none
5	0,0	1,0	0,0	0,0	0,0	0,0	backarrow (←)
6	4,0	0,0	12,0	0,0	0,0	0,0	backarrow (←)
7	2,1	4,1	6,1	0,0	0,0	0,0	none
8	0,0	2,0	4,0	0,0	0,0	0,0	none

*Delays are listed according to transmission rates (bits per second). The two numbers in each column under each baud rate are the number of fill characters sent to that particular terminal type after a carriage return (first number) and after a linefeed (second number). The 134.5 bits-per-second transmission rate is not shown because it corresponds to the IBM 2741 Communication Terminal which is handled differently.

Table 1-3. Terminal Models Representative of Terminal Types

TERMINAL TYPE	REPRESENTATIVE TERMINAL
0	HP 2749A Teleprinter Terminal Teletype ® model 33 ASR Terminal Teletype ® model 38 ASR Terminal HP 3071A Transaction Terminal
1	HP 2640A Interactive Display Terminal HP 2644A Interactive Display Terminal
2	HP 2640A Interactive Display Terminal (in block mode) HP 2644A Interactive Display Terminal (in block mode)
3	HP 2600A Keyboard-Display Terminal
4	HP 2762A/B Terminal General Electric TermiNet 300 General Electric TermiNet 1200
5	Teletype ® model 37 ASR Terminal
6	General Electric TermiNet 30
7	Texas Instruments Silent 700 Series KSR Electronic Data Terminal
8	Execuport 300 Data Communications Transceiver Terminal
9	IBM 2741 Communication Terminal

A terminal type (0-8) entered with the HELLO command is associated with each of the nine ASCII code terminals. Type 9 is associated with non-ASCII generating terminals; this type need not be specified, but is returned if requested by the SYS function.

Table 1-4. Terminal Characteristics

SPEED (cps)	CHARACTER COMPOSITION	BIT RATE (baud)	CHARACTER SIZE (bits)
<u>STANDARD TERMINALS</u>			
10	1 start bit + 8 data bits + 2 stop bits	110	11
15	1 start bit + 8 data bits + 1 stop bit	150	10
30	1 start bit + 8 data bits + 1 stop bit	300	10
60	1 start bit + 8 data bits + 1 stop bit	600	10
120	1 start bit + 8 data bits + 1 stop bit	1200	10
240	1 start bit + 8 data bits + 1 stop bit	2400	10
<u>SPECIAL TERMINALS (IBM 2741 with CALL/360 or PTTC/EBCD code)</u>			
14.9	1 start bit + 7 data bits + 1 stop bit	134.5	9

Table 1-5. Data Set Options Compatible with HP 2000 Computer System

BELL 103A3/E/G/H

This data set model replaces the 103A2 (which is also compatible). The model 103 works with another 103 or with model 113.

OPTION	SPECIFICATION	
	COMPUTER END	TERMINAL END
Answer Mode Indication	CE off	CE off
Send Disconnect	Yes	Yes
Space Disconnect	None	None
CC Indication (Data Set Ready)	Early	Early
Loss of Carrier Disconnect	Yes	Yes
CB and CF Indications	Common	Common
Dialing Features	Customer option	Customer option
Automatic Answer	Permanently wired	Key controlled

BELL 113A/B

The model 113 works with a 103 or another 113 data set. The 113A is "originate" only and must be used at the terminal end. The 113B is "answer" only and must be used at the computer end.

OPTION NUMBER	OPTION	SPECIFICATION
	Dummy Load	Required
A2*	Common Signal Ground to Frame Ground	Not Installed
B3*	Common CB and CF	Installed
C5*	CN Control (Line Busy)	Installed
	Make Busy Implementation	Installed
D7*	Terminal Control of Disconnect	Installed

*When ordering a Bell 113A/B explicitly request these options.

INPUT/OUTPUT DEVICES

I/O devices supported by the system include magnetic tape units, line printers, card readers, reader/punch/interpreter units, paper tape readers, paper tape punches, link terminals, and one Asynchronous Modem Interface. An I/O device is sometimes called a non-sharable device because it can be controlled by only one user at a time. For example, a line printer is non-sharable because it prints output for one program at a time; while a disc is a sharable device because it performs I/O for many programs at the same time. Once a user initiates an I/O operation on a non-sharable device, no other user can perform I/O on the same device until the first user's operation has terminated or aborted. I/O devices can be dedicated to one user or to a group of users.

Magnetic Tape Units

The HP 2000 Computer System requires one tape drive. However, it can support four nine-track HP 7970B drives, or four nine-track HP 7970E drives. On systems using multiple drives, the drives must be of the same model, operating at the same speed, and must be connected to the same controller.

A magnetic tape unit is used during system generation, shutdown and subsequent reload. System programs and tables, and user libraries are stored on tape for backup purposes. Tape units can be made available to system users for I/O operations.

Paper Tape Readers

On systems configured with 21MX processors, paper tape readers are optional non-sharable devices accessible by users for input operations. On systems configured with 2100 processors, one paper tape reader is required for reading the magnetic tape bootstrap program and the cross loader (used to cross load the bootstrap program into the main processor memory). At other times, the required reader plus additional optional paper tape readers can be made accessible to users.

Other I/O Devices

Optionally, other peripheral equipment may be attached to the system by configuring the I/O processor program accordingly. Table 1-6 lists the I/O devices supported by the HP 2000 Computer System.

Table 1-6. I/O Devices Supported by HP 2000 Computer System

INPUT/OUTPUT DEVICES	REQUIRED UNITS	OPTIONAL UNITS	TOTAL UNITS (MAXIMUM)
MAGNETIC TAPE UNITS HP 7970B or E (9 track)	1	3	4
PAPER TAPE READERS HP 2748A or B (used with 21MX processors)	0	7	7
HP 2748A or B (used with 2100 processors)	1	6	7
LINE PRINTERS HP 2607A, HP 2610A, HP 2613A, HP 2614A, HP 2617A, HP 2618A, HP 2767A, HP 2778A	0	7	7
CARD READERS HP 2892A, HP 7261A	0	7	7
CARD READER/PUNCH/INTERPRETER UNITS HP 2894A	0	7	7
PAPER TAPE PUNCHES HP 2753B, HP 2895A	0	7	7
LINK TERMINAL HP 3070A	0	31	31
SYNCHRONOUS MODEM INTERFACE HP 12618A	0	1	1

HARDWARE CONFIGURATION

Every external device is connected by cable directly to an interface board (called a device controller). The interface board, in turn, plugs into a processor input/output slot. Each slot has a fixed address called a select code used by the processor to communicate with a specific device. A select code is an octal number that reflects its priority; the smaller the number, the higher its priority.

Before a system can be generated or regenerated, you must determine the slots where the interface boards are installed so that you are prepared to enter select codes when the system prompts for them. At times you are asked to supply the select code of a device that actually occupies multiple slots. Always enter the lowest number (highest priority) of the slots occupied by the device.

The following information on configuring interface boards in the processors is provided so that you can configure your system properly and then correctly answer prompts when generating the software system.

MAIN PROCESSOR CONFIGURATION

Main processor interface assignments follow.

OCTAL SELECT CODE	PRIORITY	DEVICE
10 and 11	Highest	Processor interconnect
12		System console
13		Time base generator
14		First disc controller. Refer to table 1-1 for number of slots required for each disc controller. If your system combines 7905 or 7920 discs with 7900 or 2883 discs, the 7905/7920 disc controller must be assigned to channel 14.
<i>n</i>		Lowest

where *n* = first available select code after the disc controllers.

I/O slots 10 through 14 must be assigned as shown. These are system requirements.

Additional disc controllers for HP 7900's and HP 2883's can be assigned to any pair of I/O slots up to 24-25, provided no preceding slots are left empty. We recommend that you assign additional disc controllers to consecutive slot-pairs adjacent to the first disc controller. Refer to table 1-1 for disc models that can be combined.

The magnetic tape device controller can be assigned to any two free I/O slots up to 24-25 — but no preceding empty slots are permitted.

Note: After the I/O processor program has been configured (refer to Appendix A), you must reconfigure it if you alter the magnetic tape unit's select code. Reconfiguring would be necessary, for instance, when adding additional disc controllers because the magnetic tape interface boards would have to be moved to different slots.

I/O PROCESSOR CONFIGURATION

I/O processor configuration depends upon the peripheral options chosen and the number of user terminals supported.

Some I/O devices require two I/O slots while others require only one. Table 1-7 lists components in the recommended order of assignment and the number of slots required by each.

Slot assignments always begin with select code 10, and they are always contiguous. If more than 16 ports are to be generated into your system, then the two sets of multiplexers and data set control interfaces must occupy consecutive I/O slots. Optionally, interface boards for seven each card readers, reader/punch/interpreter units, line printers, paper tape readers, and paper tape punches and serial link controllers can be installed in any order; but the assignments must be to contiguous slots. We recommend assignments be made in the same order shown in table 1-7.

Table 1-7. I/O Processor Interface Slot Requirements

SLOTS REQUIRED	PRIORITY	DEVICE
2	Highest  Lowest	Synchronous modem interface (optional)
1		Time base generator
2		1st Multiplexer
1		1st Data set control interface
2		2nd Multiplexer (optional)
1		2nd Data set control interface (optional)
2		Processor interconnect
1		Optional I/O devices; 1 or 2 slots for each, in any order

EXAMPLES:

The following typical I/O processor interface assignments are for a system having between 17 and 32 user terminals, and the I/O devices shown.

OCTAL SELECT CODE	DEVICE
10 and 11	Synchronous modem
12	Time base generator
13 and 14	1st Multiplexer
15	1st Data set control interface
16 and 17	2nd Multiplexer
20	2nd Data set control interface
21 and 22	Processor interconnect
23	Line printer interface
24	Card reader interface
25	Card reader interface

The following typical I/O processor interface assignments are for a small HP 2000 Computer System.

OCTAL SELECT CODE	DEVICE
10	Time base generator
11 and 12	Multiplexer
13	Data set control interface
14 and 15	Processor interconnect
16	Line printer interface

SYSTEM SOFTWARE

HP 2000 Operating System software (HP 22687A) is distributed on a single magnetic tape. This master tape contains:

- A Master Program used to direct software configuration and loading.
- An I/O Processor Configurator Program (IOPC) used for configuring the I/O processor.
- The I/O processor relocatable modules.
- The system processor loaders.
- The system processor program.
- A system recovery program named Warmstart.
- A 2000/F to HP 2000 File Conversion Program.

A magnetic tape bootstrap program is required to load the Master Program into main memory. With 21MX processors, the magnetic tape bootstrap loader program is supplied in a ROM. Systems using 2100 processors require not only the magnetic tape bootstrap program but also: a cross loader program, the special purpose Basic Binary Loader (BBL) described in Appendix D, and a standard Loader/Loader Program. The magnetic tape and cross loader programs are supplied on one paper tape while the BBL and Loader/Loader are provided on an additional paper tape. The BBL is first loaded into protected IOP memory using the Loader/Loader. Subsequently, the BBL allows other loader programs to be loaded from paper tape or from the Processor Interconnect Kit.

During system generation the magnetic tape bootstrap loader places the Master Program into memory. From that point, system software supervises all configuration, reload, update, and operating sequences. After you bring the system to its normal operating condition, the system recognizes properly identified users, acknowledges legitimate requests, and permits controlled access to libraries, I/O devices, and remote computer systems.

SYSTEM OPERATOR'S JOB

SECTION

II

The system operator supervises day-to-day operation of an HP 2000 Computer System. As an operator, you monitor and control timesharing, RJE, and 2000 to 2000 activities from the system console. Occasionally, you may act as system master. In this case, you must have available a user terminal so that you can log on to the system using idcode A000.

In general, this manual deals with a timesharing operator's duties. However, Chapter VI describes your duties with respect to data communications while the section titled "System Library—System Master", in Chapter VII, describes duties of a system master.

Functioning as the system operator, you must be able to:

- Generate and update the system.
- Alter system configuration.
- Use all system commands.
- Maintain a reliable system backup.
- Monitor and control device allocation.
- Operate non-sharable devices.
- Maintain complete system activity records.
- Maintain complete user activity records.
- Perform error recovery procedures.
- Respond to user requests.

Functioning as the RJE operator, you must be able to:

- Connect your system to a host system.
- Operate non-sharable devices in order to transmit batch jobs to the host.
- Monitor non-sharable devices as they receive batch jobs from the host.
- Make operator inquiries and control job flow via RJE commands.
- Allocate host resources.
- Disconnect your system from the host system.
- Request communications error reports.

Functioning as the 2000 to 2000 operator, you must be able to:

- Connect your system to another HP 2000 system.
- Operate non-sharable devices in order to transmit data to another 2000 system.
- Operate non-sharable devices as they receive data from another 2000 system.
- Disconnect your system from another 2000 system.
- Request communications error reports.

COMMUNICATION

The system communicates with you primarily through messages or prompts printed at the system console and, to a much lesser extent, through lights on the processor front panels. You communicate with the system by typing commands on the console keyboard.

Communication between the system and the operator is extensive during startup, consisting largely of a dialogue initiated by the system requesting specific information from you. During normal operation you may request reports from the system or request on-line changes to system status.

STANDARD OPERATING MESSAGES

Standard operating messages make requests for input or action and provide a record of current system activity. Messages from the system appear frequently during system generation, update, backup and reload procedures. You will also receive messages from users during normal operation. These messages might contain requests for information or assistance.

SYSTEM HALTS

If the system halts, it is important to note which lights in the display register are lighted. The combinations of ON/OFF lights form what are known as halt codes. The codes have specific meanings as explained in Section V and Appendix B.

SYSTEM ERROR MESSAGES

System error messages inform you of errors that occur during system generation, update, or reload — as well as during system execution. System error messages and descriptions are listed in Appendix B.

DISC ERROR MESSAGES

Disc error messages can occur during the transfer of data to or from the disc. The disc error messages that you might encounter during system startup are explained in Section IV (the section on system generation and update). All other disc error messages are discussed in Appendix C.

DEVICE STATUS MESSAGES

Since I/O devices will frequently be under your exclusive control, device messages (for example, line printer paper fault, card reader pick failure, etc.) are sent to your console as well as to the terminals of the programs initiating the I/O operation. Device status messages are listed in Appendix B.

POWER FAILURE MESSAGE

If power supplied to your system momentarily fails, power failure/power recovery sequences can occur. Sometimes the duration of these failures is too short to be noticed by a system operator. Thus, you are explicitly notified via the message POWER FAILURE - *hhmm*, where *hhmm* is the hour and minute when the power failed.

OPERATING THE SYSTEM CONSOLE

The system operator's console can be an HP 2754A/B Teleprinter or an HP 2762A Terminal Printer. Before you load a 2000 system, console switches must be set as follows:

HP 2754A/B SWITCH SETTINGS

The Status Switch must be set to ON LINE.

The Mode Switch must be set to either:

- KT to print all system messages at the console and punch LOGON and LOGOFF messages on paper tape. (This the normal setting.)
- K to print all system messages at the console, but not punch any messages on paper tape.
- T to print all system messages at the console and punch all messages on paper tape.

HP 2762A SWITCH SETTINGS

The AUTO LINEFEED switch must be set to OFF.

The ALL CAPS switch must be set to ON.

The ONLINE switch must be set ON (lighted) for the processor to communicate with the console. **Both the ONLINE and the READY switches must be lighted for the operator to communicate with the system.**

The Channel Type switch must be set to FULL (for full-duplex operation).

The RATE switch must be set to 30 cps.

Note: You should be familiar with the HP 2762A escape sequences and control codes. Refer to Operator's Manual 2762A Terminal Printer (part number 02762-90011).

KEYBOARD ENTRIES

You communicate with the system or with a user terminal by typing entries on the console keyboard. The following paragraphs explain system features governing keyboard operation.

Note: Except to terminate a report, you cannot make any keyboard entries when bit 0 of the S-register on the main processor is set (lighted).

The system ignores blanks within an entry unless they are embedded in a message. A line of input may contain 72 characters (including *all* blanks and the final carriage return). A carriage return must follow each entry.

During dialogue with the system loader, a carriage return may be used to imply a NO response when a YES or NO answer is expected.

If you enter a command that does not produce output on the console, the system prints a linefeed to indicate the command executed successfully. If you enter a command improperly or the command could not execute, the system prints an appropriate error message.

During normal operation, if the system cannot interpret a keyboard entry, three question marks (???) are printed at the system console. Retype your entry.

Except for I/O select codes and portions of the I/O processor configuration report, all numbers entered or printed on the console are decimal integers. The select codes, specifying the location of hardware I/O devices, are always octal integers.

Deleting a Character

If you err while typing an entry, use H^c to make deletions. Hold down the *control* key and strike the H key once for each previous character to be deleted. For example, the sequence ABC__DE__F is equivalent to the sequence ADF. Note that each time H^c is pressed, the system prints an underline to provide a visual record of the action taken. The underline may appear as a backarrow (←) on some consoles.

Deleting a Line

To delete an entire command (so long as you have not entered the terminating carriage return), type X^c. When the system encounters this control character, it ignores the line just typed and prints a backslash (\) followed by a carriage return and linefeed. (Note the system also prints a backslash if you enter a line that exceeds 72 characters.)

Delaying Messages to the Console

Occasionally, the system interrupts current console activity with messages. You can delay or halt such messages by pressing any key except *return* or *linefeed*. If you press a key while a line is being printed, that entire line is completed before a pause occurs. Note that a 15-second delay begins immediately upon striking the key and continues until you press another key, press *return*, or until 15 seconds have elapsed. Striking a second key resets timing and the pause continues for an additional 15 seconds. Messages to the console are delayed so long as you continue to strike keys. When you allow timing to expire or press *return*, queued messages are immediately printed.

Terminating a Report

Pressing any key while the console is printing output resulting from the DEVICE, REPORT, DIRECTORY, ROSTER, or STATUS commands causes the listing to terminate at the end of the current line, command execution to abort, and 15-second delay timing to begin.

OPERATOR COMMANDS

SECTION

III

Operator commands for the HP 2000 System are described in this section. The format chosen to present the commands is designed for both quick reference and detailed learning. The format is:

- COMMAND** describes briefly what the command does, shows the format of the command and defines the variables that you can supply.
- COMMENTS** describes in detail the command and related special considerations.
- ERROR MESSAGES** lists and defines system error messages associated with the command.
- EXAMPLES** shows the command in use.

In the format descriptions, full commands are shown in uppercase letters. In examples, only the required first three characters of the command are shown.

Parameters associated with the commands are shown in lowercase letters and are separated from the command by a hyphen. Some parameters are noted as being positional. This means the sequence and presence of the parameters is significant. They must be entered in the order shown and missing parameters must be represented by commas if the following parameters are to be recognized. Brackets enclose optional parameters; you must choose one parameter from those enclosed by braces (refer to figure 3-1).

There are three types of commands discussed in this section:

- The system commands entered from the system console during normal system operation.
- The loader commands entered from the system console as responses to loader queries. These are used only during system generation and other loading procedures.
- The special commands shared by the system operator and the system master. These special commands may be entered on-line from a user terminal by the system master or by the operator (logged on the A000 account).

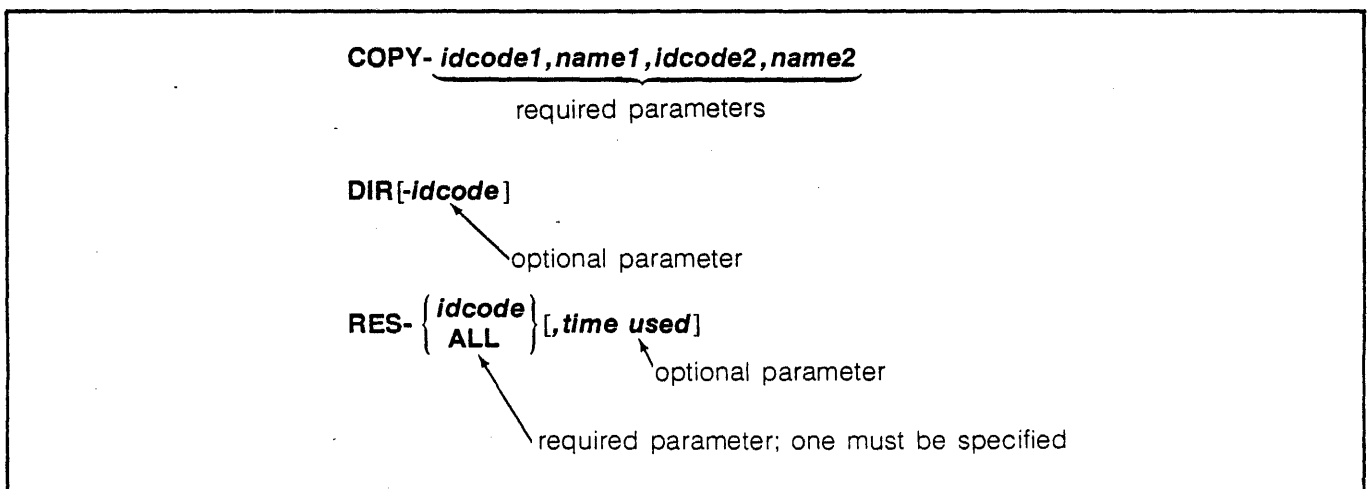

Figure 3-1. Examples Illustrating Format Conventions

SYSTEM COMMANDS

The commands listed are the commands you may enter from the system console during normal system operation. Individual command descriptions follow the list.

ANNOUNCE	DEVICE	NEWID
ASSIGN	DIRECTORY	PHONES
AWAKE	DISCONNECT	PURGE
BANNER	DUMP	REPORT
BESTOW	HIBERNATE	RESET
BREAK	KILLID	RJE
CHANGEID	MLOCK	ROSTER
COPY	MUNLOCK	SLEEP
		STATUS

ANNOUNCE

You may use the ANNOUNCE command to send a one-line message to a designated port or to all ports.

ANNOUNCE- $\left\{ \begin{array}{l} \textit{port number} \\ \text{ALL} \end{array} \right\}, \textit{character string}$

- port number*** is a decimal value from 0 to 31 designating a user port. If selected, the character string is transmitted to this port only.
- ALL** requests that the character string be transmitted to all currently logged on ports.
- character string*** is any one-line message. The message is transmitted to the port or ports specified by the first parameter. The message (including blanks) is printed exactly as it was entered.

COMMENTS

Enter this command to warn users shortly before you plan to sleep or hibernate the system; or use it to answer a MESSAGE from a user. Note the command can require a full minute to complete execution. Also, the command should be used with great care because: (1) output being printed at a user's terminal is interrupted by the ANNOUNCE message, (2) the message suspends timing in users' currently executing ENTER statements, and (3) all other system activity is temporarily suspended until the ANNOUNCE message has been sent.

Note that any user currently employing one or more I/O devices receives the messages only on his terminal.

ERROR MESSAGES

ILLEGAL FORMAT

This message indicates the command entry did not conform to format rules.

EXAMPLES

ANN-ALL, SYSTEM WILL BE SHUT DOWN AT 10 A.M. FOR APPROXIMATELY 30 MIN.

All users are warned of approaching system shutdown.

ANN-10, REQUESTED FILE SPACE IS GRANTED.

This example informs a user at port 10 that the file space he requested (perhaps via the MESSAGE user command) is now available.

ASSIGN

The ASSIGN command assigns an I/O device to a particular idcode or group of idcodes. It can also be used to deactivate an I/O device.

ASSIGN-specific device,

$\left. \begin{array}{c} \text{idcode} \\ \text{ALL} \\ \text{NONE} \\ \text{RJE} \end{array} \right\}$

specific device

is any specific device designator selected from the table of system supported non-sharable devices. (A copy of the table can be obtained by issuing a DEVICE command.)

idcode

is the identification code of the user who is to have exclusive use of the specific I/O device.

ALL

permits all authorized idcodes and the data communications facility to use the designated *specific device*.

NONE

denies use of the designated *specific device* to all users. The non-sharable device is logically removed from the system. Issue this command with caution because it aborts the program of the current device user.

RJE

reserves the designated peripheral for exclusive use by the data communications facility.

COMMENTS

Entering an idcode, ALL or RJE parameter does not interrupt activity on the designated device: assignment becomes effective when the current user's operation terminates.

To free a device so that others may again access it, use the ALL parameter.

Note that there is no designator associated with the disc. This device is always available to all users. Thus it can never be assigned.

ERROR MESSAGES

ILLEGAL FORMAT

Command entry did not conform to format rules.

NO SUCH DEVICE

The specified device is not configured on the system.

EXAMPLES

```
ASS-LP1,B123
```

This example reserves the line printer designated LP1 for exclusive use by the owner of idcode B123.

```
ASS-LP1,NONE
```

The example deactivates LP1.

AWAKE

Use this command to restart a suspended program after you receive the console message *xxx-ATTENTION NEEDED*; or use it to restart a program which suspended itself through programmatic use of the PAUSE command (described in the *HP 2000 BASIC Reference manual*).

AWAKE — { *specific device*
port number }

specific device is the specific device designator taken from the ATTENTION NEEDED message.

port number is the number of the port suspended through programmatic use of the PAUSE command.

COMMENTS

Ordinarily, the *xxx-ATTENTION NEEDED* message indicates a need for the AWAKE command. Frequently this message results from invalid hole patterns in punched cards or from a magnetic tape unit that was off line when first referenced.

Because the system does not automatically inform the operator when a user programmatically suspends his program, it is necessary for the system manager, users and you to agree on the action to be taken when this situation arises.

ERROR MESSAGES

DEVICE NOT IN USE

The device designator supplied does not correspond to an allocated device.

INCORRECT DEVICE

You supplied a device designator corresponding to a device that is active; or to a device other than the one that caused a user's program to be suspended.

NO SUCH DEVICE

The specified device designator does not correspond to any device in the current system configuration.

ILLEGAL FORMAT

Command entry did not conform to format rules.

USER NOT SUSPENDED

Specified user is not suspended by a PAUSE command.

EXAMPLES

AWA-CR0

This example restarts the program accessing card reader zero.

AWA-10

This example restarts the program suspended at port 10.

BANNER

This command is used to generate a one-line message to be displayed to each user at logon.

BAN [-*character string*]

character string is any one-line message. Omit this parameter to cancel a previous banner message.

COMMENTS

The message included in the BANNER command is displayed just prior to HELLO messages (when they exist) each time a user logs on the system. Users continue to receive the message until you issue a new BANNER command containing a new message or until you type BAN (with no message) to cancel the previous message. A system update or magnetic tape reload cancels the current BANNER message.

ERROR MESSAGES

DISC ERROR; CAN'T DO IT

The system cannot enter your message because there was a disc error.

ILLEGAL FORMAT

Command entry did not conform to format rules.

EXAMPLES

BAN-SYSTEM WILL SHUT DOWN AT 10 A.M. FOR APPROXIMATELY 30 MIN.

This message will be printed at the terminal when a user logs on.

BESTOW

This command transfers programs or files from the library of one user to that of another.

BESTOW-*idcode1*,*idcode2* [*,name*]

idcode1 is the identification code of the current owner of the program or file being transferred.

idcode2 is the identification code of the destination library.

name is an optional parameter indicating the name of a specific program or file to be transferred from *idcode1* to *idcode2*. If omitted, the system transfers the entire library of *idcode1* to the library of *idcode2*.

COMMENTS

The BESTOW command initiates the removal of one element or all elements from the library of the user designated by *idcode1*, and the placement of the elements into the library of *idcode2*. The owner of the original account must be given the opportunity to authorize a BESTOW request since ownership of the element or elements is transferred. The sample BESTOW request form printed in Appendix H can be used for this purpose.

When users are logged on the system, you can bestow one library element by including its name. However, if you attempt to bestow an entire library (by omitting the name parameter) while users are logged on, the command will not execute. In this case, the system prints USERS ARE LOGGED ON.

The system will not bestow locked or private programs or files.

ERROR MESSAGES

DUPLICATE ENTRY/ENTRIES

One or more entries cannot be bestowed because their names are already present in the destination account.

ILLEGAL FORMAT

Command entry did not conform to format rules.

INVALID NAME

Program or file name was specified in illegal form.

LIBRARY SPACE FULL

No room in new idcode library. Some of the entries may have been bestowed.

NO ENTRIES BESTOWED

System cannot find named program or file, or the specified old idcode library is empty.

NO SUCH ID

One of the idcodes specified does not exist.

PROPRIETY ITEM(S) NOT BESTOWED

One or more entries cannot be bestowed because they are locked or private; or because they were not properly created.

USERS ARE LOGGED ON

You cannot bestow entire account libraries when users are logged on the system. Individual library entries must be bestowed one at a time.

EXAMPLES

```
BES-D123,B324
```

This example transfers the entire library of user D123 to the library of user B324.

```
BES-B444,C227,AAAAA
```

This example transfers a program or file named AAAAA from the library of user B444 to the library of user C227.

BREAK

The BREAK command permits you to enable the BREAK key at the designated port. The command is used only when an executing user program is in an infinite loop and the owner's terminal break key has been disabled by a program.

BREAK-port number

port number

is a decimal value from 0 to 31 designating a specific user terminal (port).

COMMENTS

Entering this command does not itself terminate the user's program; it enables the user to do so. The BREAK command remains in effect until either the user's program has run to completion, the program terminates because of an execution error, the user terminates the program with the BREAK key, the user breaks the communication connection by hanging up the telephone or turning off the terminal, or the system is slept or hibernated. No indication that you have entered the BREAK command appears on the user's terminal.

ERROR MESSAGES

ILLEGAL FORMAT

Command entry did not conform to format rules.

USER NOT LOGGED ON

The port number specified is not an active port.

EXAMPLES

```
BRE-25
```

The example enables the BREAK key at port 25.

CHANGEID

This command modifies any or all parameters of an existing user identification code.

```
CHANGEID-idcode, [password ], [time limit ], [disc space ] [ ,PFA ] [ ,FCP ]
[ ,NOPFA ] [ ,NOFCP ]
[ ,MWA ] [ ,gen dev1 ] [ ,gen dev2 ]
[ ,NOMWA ] [ ,NO gen dev1 ] [ ,NO gen dev2 ] . . . .
```

- idcode*** is the identification code assigned to a specific user (via the NEWID command).
- password*** consists of 1 to 6 printing or non-printing characters. The designated word becomes the new password associated with the specified *idcode*. If omitted, the password remains unchanged. This is a **positional parameter**.
- time limit*** becomes the new terminal usage time limit (in minutes) associated with the specified *idcode*. The value may not exceed 65535 minutes. If omitted, the time limit is not changed. This is a **positional parameter**.
- disc space*** becomes the new disc space size limit associated with the specified *idcode*. The value cannot exceed 65535 blocks. (A block is 256 words long.) If this parameter is omitted, the allotted disc space remains unchanged. This is a **positional parameter**.
- PFA** stands for program/file access. The parameter endows the library of the designated *idcode* with program/file access capability. This means that programs and files within the user's library can be accessed to the limit of their restrictions by all other users.
- NOPFA** removes the program/file access capability from the library of the specified *idcode*. No other *idcode* may access the library. If PFA and NOPFA are both omitted, the previously established access capability remains unchanged.
- FCP** stands for file create/purge. This parameter is meaningful only when the *idcode* specified is that of a group master account (any *idcode* ending with 00). When specified, the group master account is endowed with the capability to create, read, write or purge locked BASIC-formatted files within the library of any group member account having the PFA capability.
- NOFCP** removes the file create/purge capability from the specified *idcode*. If both FCP and NOFCP are omitted, the previously established capability remains unchanged.

Operator Commands

MWA

stands for multiple-write access. If included, MWA gives the designated idcode the capability to assign SWA and MWA status to files within the idcode's library.

NOMWA

prohibits the specified idcode from assigning SWA and MWA status to files within the idcode's library. If both MWA and NOMWA are omitted, the capability remains unchanged.

general device

can be any of the following general device designators. You may include eleven designators in any order.

PR	paper tape reader
MT	magnetic tape units
PP	paper tape punches
LP	line printers
CR	line printers
RP	card reader/punch/interpreter units
JT	job transmitters
JL	job line printers
JP	job punches
JI	job inquiry
JM	job message device
LT	link terminals

All I/O devices of the class represented by the designator are made available for use by the specified idcode. If omitted, access capability remains unchanged. Removal of access to a class of devices is achieved by prefixing the general device designator with NO (for example, NOLP).

COMMENTS

At least one parameter other than the idcode should be specified. The first four parameters must be in the order shown. A comma must be entered as a place holder for each omitted positional parameter. When included, any of the remaining parameters may be entered in any order.

ERROR MESSAGES

ILLEGAL FORMAT

Command entry did not conform to format rules.

NO SUCH ID

The specified idcode does not exist or is not recognized by the system.

EXAMPLES

CHA-Q123,BASIC

This command changes the password of user Q123 to BASIC. The time limit and disc space limitations remain unchanged.

```
CHA-Q123,,,500
```

This command changes the disc space allocation for user Q123 to 500 blocks. The other positional parameters (represented by commas) remain unchanged.

```
CHA-Q123,,,PFA,MWA,LP
```

In this example, all positional parameters remain unchanged. However account Q123 will now be able to use the PFA, MWA and line printer accessing features.

```
CHA-Q123,,,NOLP
```

Account Q123 can no longer use a line printer for his output.

COPY

This command copies an element (program or file) from the library of one user into the library of another user. The copied program or file remains in the original library.

```
COPY-idcode1,name1,idcode2,name2
```

<i>idcode1</i>	is the identification code of the user library containing the element being copied.
<i>name1</i>	is the name of the element to be copied to another user's library.
<i>idcode2</i>	is the identification code of the destination library.
<i>name2</i>	is the new name of the library element as it will appear in the library of user <i>idcode2</i> .

COMMENTS

Ownership of the library element is not transferred. The original owner retains the element identified by *name1* while the destination owner has a copy identified by *name2*. Generally, the owner of the library element should be given the opportunity to authorize a COPY request. The sample COPY request form printed in Appendix H can be used for this purpose. The system will not COPY locked or private library elements. Also, the system will not COPY files longer than 200 blocks if users are logged on the system.

ERROR MESSAGES

ILLEGAL FORMAT

Command entry did not conform to format rules.

DUPLICATE ENTRY

name2 already exists in the library of *idcode2*.

INVALID NAME

The program or file name does not conform to the rules for element names.

LIBRARY SPACE FULL

There is no room in the new *idcode* library for additional entries.

NO SUCH ENTRY

The system cannot find the named program or file.

NO SUCH ID

One of the specified *idcodes* does not exist.

PROPRIETARY ITEM NOT COPIED

The program or file to be copied is either protected or locked; or it was improperly created.

SYSTEM OVERLOAD

There is either no directory space or no disc space available for the new entry.

UNSUCCESSFUL

A disc error occurred during the copy operation.

USERS ARE LOGGED ON

A file greater than 200 blocks in length cannot be copied while any users are logged on the system.

EXAMPLES

COP-G476,ABC,M935,NEW

This example produces a copy of the element named ABC (residing in the library of user G476) in the library of user M935. The copy is named NEW.

COP-E722,MINE,B079,MINE

This example produces a copy of the element named MINE (residing in the library of user E722) in the library of user B079. The copy and the original have the same name.

DEVICE

You may use the **DEVICE** command to obtain information concerning non-sharable devices supported by the system.

DEVICE

COMMENTS

Figure 3-2 illustrates a device report as it would appear on the system console. The first line has the following format:

system-id	is the system identification furnished by the operator during system generation.
date	is in the form <i>ddd/yy</i> . <i>ddd</i> is the current Julian date and <i>yy</i> represents the last two digits of the current year.
time	is in the form <i>hhmm</i> where <i>hh</i> is the current hour (24-hour clock) and <i>mm</i> is the current minute of the hour.

In a device report the information is printed in columns (refer to figure 3-2). An explanation of the information follows.

DEVICE DESIGNATOR lists each non-sharable device configured on the system. A non-sharable device is one that cannot be utilized simultaneously by several executing programs. For example, a line printer can print for only one user's program at a time while a disc may be shared by many programs executing concurrently.

Each non-sharable device supported by the system has assigned to it a unique designator known as a **specific designator**. The specific device designator is a **general device designator** with a unit number appended. These numbers were assigned when the I/O processor program was configured.

The type of I/O device is represented by a general device designator as follows:

PR	paper tape reader
MT	magnetic tape units
PP	paper tape punches
LP	line printers
CR	card readers
RP	card reader/punch/interpreter units
JT	job transmitters
JL	job line printers
JP	job punches
JI	job inquiry device
JM	job message device
LT	link terminals

Note in figure 3-2 that column one of the **DEVICE** report lists specific device designators; thus making it possible for you to determine both the type of I/O device and its number.

Operator Commands

- SELECT CODE** is the select code assigned to each device at system generation.
- MAXIMUM RECORD SIZE** lists the maximum record size in words (1 word = 2 characters) as established at system generation.
- ASSIGNMENT** lists the current accessibility of each device as established by the ASSIGN command. System default is ALL, meaning the device is available for use by all authorized idcodes and the data communications facility.
- USER** lists the idcode and port number of the current user of each device. When there is no current user the field is blank.

ALPHA 204/75 1748				
DEVICE DESIGNATOR	SELECT CODE	MAXIMUM RECORD SIZE	ASSIGNMENT	USER
CRO	25	40	RJE	
LPO	24	66	RJE	
LP1	23	66	ALL	A000-05
PP0	26	64	A433	A433-03
JM0	00	60	A000	
JIO	00	36	A000	
JP0	00	41	ALL	
JP1	00	41	ALL	
JP2	00	41	ALL	
JP3	00	41	X400	
JP4	00	41	ALL	
JP5	00	41	ALL	
JP6	00	41	ALL	
JL0	00	67	ALL	
JL1	00	67	ALL	
JL2	00	67	ALL	
JL3	00	67	X400	
JL4	00	67	ALL	
JL5	00	67	ALL	
JL6	00	67	ALL	
JT0	00	40	ALL	
JT1	00	40	ALL	
JT2	00	40	ALL	
JT3	00	40	X400	
JT4	00	40	ALL	
JT5	00	40	ALL	
JT6	00	40	ALL	
MT0	20	256	ALL	Y300-06
PRO	13	64	NONE	

Figure 3-2. A Sample Device Listing

DIRECTORY

This is a special command available to both the system operator and the system master. Use the command to obtain a printed list of library programs and files according to idcode.

DIRECTORY [-idcode]

idcode is the identification code assigned to a user. If specified, the directory listing begins with this idcode and continues through the end of the directory entries. If omitted, the listing includes all entries in the directory.

COMMENTS

Figure 3-3 is a sample directory listing as it would appear on the system console. System identification, the current date, and the current time head the report. The columns are:

ID lists owners of the programs and files by idcode.

NAME lists the elements (programs or files) within the library of each idcode.

DATE is the date this library element was last referenced (*day-of-year/last two digits of year*).

element type and status are the two unlabeled columns following the date. The first character represents the type of program or file as follows:

F BASIC file with SWA
 M BASIC file with MWA
 A ASCII file (on disc or on a device)
 C semi-compiled program
 blank uncompiled program

The second character represents the status of the program or file as follows:

U unrestricted status
 P protected status
 L locked status
 blank private status

LENGTH is the program or file length expressed in decimal notation as the number of blocks.

DEV/ADDR is the disc location (the logical block number) in decimal notation; or it is the specific or general device designator associated with a file name (refer to the DEVICE command).

RECORD is the size of records (in words) of an ASCII file or the size of a BASIC file (when its record size is other than 256 words).

ERROR MESSAGES**ILLEGAL FORMAT**

Command entry did not conform to format rules.

ALPHA 053/75 1443						
ID	NAME	DATE		LENGTH	DEV/ADDR	RECORD
A000	AAA	024/75	FL	00002	000516	
	BUDGET	019/75	A	03431	000968	256
	C	032/75	F	00031	000982	
	HELLO	020/75	C	00128	001512	
	XY	043/75	AL		CR	80
A111	ATEST	042/75	L	00029	001896	
	FILE2	042/75	F	00012	001897	
	MYFILE	042/75	FP	00012	001909	
B111	APRIN	042/75	C	00024	003972	
	ASST	042/75	A		LPO	66
	COMI	041/75		00016	003974	
	TAR	048/75		00595	003975	
	TARGET	048/75	C	00624	003978	
B122	A	047/75	FU	00003	003981	
	CHARF	047/75	F	00001	003984	
	CHARP	047/75	MU	00032	003985	
	CHARX	047/75		00055	003986	

Figure 3-3. A Sample Directory Listing

DISCONNECT

This command is used to log users off the system.

```
DISCONNECT - { port number
                ALL }
```

port number is the number of the port to be disconnected.

ALL is the parameter to enter if you plan to log off all active users.

COMMENTS

Both hardwired and remote terminals can be disconnected with this command. You should exercise caution when disconnecting users because their data can be lost. We suggest you first use the ANNOUNCE command to alert them of the impending disconnect.

ERROR MESSAGES

ILLEGAL FORMAT

Command entry did not conform to format rules.

EXAMPLES

```
DIS-ALL
```

This example disconnects all active terminals.

```
DIS-16
```

This example disconnects port 16.

DUMP

The DUMP command is used during normal system operation to allow the system master to dump selected portions of the system.

```
DUMP-integer
```

integer

is any value 0 through 60 (inclusive). The value establishes the number of minutes a system dump request will be accepted.

COMMENTS

The system master is not allowed to dump the system unless you enter this command each time the system is brought up. Specifying the integer zero negates any previous DUMP command and prevents the system master from using the diagnostic dump facility.

ERROR MESSAGES

ILLEGAL FORMAT

Command entry did not conform to format rules.

EXAMPLE

DUM-10

The example makes it possible for the system master to initiate a dump of selected portions of the system. The opportunity to dump terminates when 10 minutes have elapsed.

HIBERNATE

The HIBERNATE command is used to create a complete copy of the system and user libraries on magnetic tape. It provides transfer verification if you so request and calls for additional tapes until the complete system is dumped. All programs and files are retained on the disc and duplicated on tape.

HIBERNATE [-*character string*]

character string

is any message up to 68 characters in length (including blanks and non-printing characters). The message is printed on all active terminals.

COMMENTS

Because this command initiates system shutdown, it is appropriate to first obtain a Roster and then use the ANNOUNCE command to ask users to log off the system. You might also want to use the BANNER command to warn users who log on the system after your announcement. If RJE is connected, it should be disconnected using the RJE-SD command.

When the HIBERNATE command executes, the following actions result. If specified, a message is sent to active users; the system immediately disconnects all users; operating non-sharable devices are deactivated; and the 2000 Operating System, along with all libraries, is copied on magnetic tape.

In the event of a power failure during a hibernate, the system processor halts with 102004₈ displayed. The system must be brought up from disc and the hibernate must be restarted in order to obtain proper system backup.

Note the difference between a HIBERNATE and a SLEEP. During a hibernate, the system and all programs and files are copied to magnetic tape. During a sleep the option exists to copy to magnetic tape the system and only those programs and files changed or created since the last hibernate.

ERROR MESSAGES

PUT MAG TAPE ON-LINE. PRESS RETURN

Magnetic tape unit must be on-line before the hibernate can proceed. Put unit on-line, then press return on the system console.

ILLEGAL FORMAT

Command entry did not conform to format rules.

EXAMPLES

HIB

The example initiates a HIBERNATE with no communication to active users.

HIB-GOODBYE. SYSTEM WILL BE SHUT DOWN UNTIL 8 A.M.

This example also initiates a HIBERNATE but active ports receive a message.

A console log of a typical hibernate dialogue follows. Note from the underlined operator input that responses may be abbreviated. Table 3-1 presents the procedure as step-by-step instructions.

```

HIB
MOUNT REEL NUMBER 1. PRESS RETURN
VERIFY? Y
DONE

```

```

SYSTEM DUMP OR RELOAD?R
LOAD OR DUMP COMMANDS? return
DATE? 119/76
TIME? 1410
HP22687A-1644

```

Table 3-1. HIBERNATE Procedures

STEP NUMBER	PROCEDURE
1	At the system console type HIB. The computer responds MOUNT REEL NUMBER 1. PRESS RETURN.
2	Ensure that a write ring is installed on the correct HIBERNATE tape. (Refer to Back-up Recommendations for a suggested tape rotation scheme.) Mount the tape on the magnetic tape unit and position at the load point. Select unit-0 and place the tape drive on-line. If you have multiple tape drives, ensure only the drive you intend to use for the hibernate is selected as unit-0.
3	Press <i>return</i> at the system console.
4	<p>The computer asks VERIFY? Respond YES to rewind and compare the tape or NO to bypass verification.</p> <p>If tape verification fails, the system prints TAPE BAD. CORRECT AND PRESS RETURN. To try the dump again, mount either the same tape or a new reel, place the tape drive on-line, and press <i>return</i> on the system console.</p> <p>If more than one tape is required, the system calls for more tapes until dumping is complete. Any additional tapes must not be mounted until requested. Do not remove each reel until a new message is printed on the console.</p>
5	<p>After a successful hibernate, the system prints</p> <p>DONE SYSTEM DUMP OR RELOAD?</p> <p>Respond DUMP if you want another backup copy. The entire hibernate procedure is repeated.</p> <p>A <i>return</i> or a NO response causes the main computer to halt with 102077, displayed in the main processor's display register. If desired, the system may now be powered down.</p> <p>Respond RELOAD to immediately resume timesharing. After you type RELOAD, the loader prompts LOAD OR DUMP COMMANDS? Respond NO or <i>return</i> to reload the system. Otherwise respond LOAD, RESTORE, or DUMP (refer to Sections IV and VII).</p>
6	After a NO response to the LOAD or DUMP COMMANDS? prompt, the system prints DATE? Type the Julian day/year followed by a carriage return. For example: 119/76 represents April 28, 1976.
7	The system asks for the current TIME? Type your response using the 24-hour clock and follow it with a carriage return. For example: 1410 represents 2:10 P.M.
8	The system prints HP22687A-date code. Users may now log on.

KILLID

This command allows you to remove a user identification code from the system.

KILLID-*idcode*

idcode is the identification code of the user being removed from the system. A000 (idcode of the system master) may not be entered.

COMMENTS

The command removes the designated user idcode from the system directory. Any disc files or programs assigned to the user are removed and the space returned to the system. If any user is currently logged on a terminal, the command does not execute.

When a group master (B000, C200, etc.) is removed from the system, the group library for that idcode is also removed.

ERROR MESSAGES

A000 NOT ALLOWED

System master's idcode may not be removed.

NO SUCH ID

Specified idcode does not exist.

USERS ARE LOGGED ON

The KILLID command is not permitted while users are logged on the system. The command did not execute.

ILLEGAL FORMAT

Command entry did not conform to format rules.

EXAMPLES

```
KIL-Q123
```

The example removes the user assigned identification code Q123 from the system.

```
KIL-C300
```

This example removes group master C300 (along with the associated library) from the system.

MLOCK

(system and loader command)

The MLOCK command allows you to make disc blocks unavailable to the system. The command can be used during initial system generation, during restart from magnetic tape (refer to Section IV), and during normal system operation.

MLOCK - *block1* [,*block2*]

block1 is the number of the first or only block being removed from the system. The value must be greater than 3 (because the first four blocks on each disc cannot be MLOCKED). The maximum depends on the total disc capacity of the system.

block2 is the number of the last block to be locked in a range beginning at *block1*. The value must be greater than 3; but the maximum depends on the total disc capacity of the system. If specified, *block2* must be greater than or equal to *block1*. If omitted, *block1* is the only block MLOCKED.

COMMENTS

This command is used primarily to eliminate physically faulty areas on a disc. Bad block numbers can be determined in two ways: (1) When disc errors occur during transfer of data to or from a disc, the system prints a message on the system console. This message contains the disc block number (where the error occurred) and the number of blocks involved. (2) When bad blocks are discovered by the system during disc formatting, a disc diagnostic is used to locate the exact hardware addresses of the bad areas. You then convert these addresses to the block numbers required by the HP 2000 — using the tables printed in Appendix E.

Any blocks (except the first four on each disc) can be locked. However, at least 150 blocks on logical disc-0 must not be locked because portions of the system software must reside on this disc.

Each disc maintains a table of its locked blocks. Once the MLOCK command executes, these blocks remain locked until they are unlocked via a MUNLOCK command. This is true even if a different HP 2000 System is initiated.

If an MLOCK command references an area containing user programs and files, the programs and files are lost. If a referenced area contains system tables, the command is rejected; system tables cannot be removed without destroying the system. Any referenced blocks already locked are unaffected by this command.

ERROR MESSAGES

LOCK FEWER BLOCKS

The block specification infringes on system requirements. Reenter command with a smaller specification.

CAN'T LOCK *fffff* TO *uuuu*

The blocks in the range indicated cannot be locked because they are required for system use.

DISC ERROR; CAN'T DO IT

A disc error occurred during command execution.

ILLEGAL FORMAT

Command entry did not conform to format rules.

ILLEGAL PARAMETER

Some of the blocks specified do not exist; or they overlap from one disc to another; or they are indicated in the wrong order (first block number greater than last block number).

LOCKED BLOCKS TABLE FULL

There is no room in the system table of locked blocks for your entry.

NONEXISTENT DISC

The blocks requested do not exist on any disc in the system configuration.

EXAMPLES

MLO-525

The example locks block 525.

MLO-525,530

This example locks disc blocks between 525 and 530 (inclusive).

MUNLOCK

(system and loader command)

This command is used to unlock disc blocks locked by the MLOCK command, thereby making them available to the system. The command can be used during initial system generation, during restart from magnetic tape (refer to Section IV), and during system timesharing.

MUNLOCK - *block1* [,*block2*]

block1 is the number of the first or only block being unlocked. The value must be greater than 3 (because the first four blocks on each disc cannot be MUNLOCKED). The maximum depends on the total disc capacity of the system.

block2 is the number of the last block to be unlocked in a range beginning at *block1*. If specified, *block2* must be greater than or equal to *block1*. If omitted, *block1* is the only block MUNLOCKED.

COMMENTS

Any previously unlocked blocks referenced in the MUNLOCK command remain unaffected.

ERROR MESSAGES

DISC ERROR; CAN'T DO IT

A disc error occurred during command execution.

ILLEGAL FORMAT

Command entry did not conform to format rules.

ILLEGAL PARAMETER

Some of the blocks specified do not exist; or they overlap from one disc to another; or they overlap from one disc to another; or they are indicated in the wrong order (first block number greater than last block number).

LOCKED BLOCKS TABLE FULL

There is no room in the system table of locked blocks. You unlocked an area in the middle of a previously locked area, causing the previous entry to become two entries.

NONEXISTENT DISC

The blocks requested do not exist on any disc in the system configuration.

EXAMPLES

MUN-525

The example unlocks disc block 525, thus returning it to the system.

MUN-525,530

This example unlocks disc blocks between 525 and 530 (inclusive).

NEWID

This command enters a new user into the system.

```
NEWID-idcode, [password], time limit, disc space [, PFA] [, FCP] [, MWA]
      [, general dev1] [, general dev2] . . . .
```

- idcode*** is the identification code assigned to a user. It consists of a letter followed by three decimal digits.
- password*** is a word consisting of 1 to 6 printing or non-printing characters. Note that this is a **positional parameter**. If you do not assign a password, the system default is a null password (a password containing no characters). In this case, when the user types the HELLO command, a comma must be typed after the *idcode* (as a placeholder for the missing password).
- time limit*** is the maximum number of minutes (decimal) of terminal time the user is allowed to accumulate. The value may not exceed 65535 minutes.
- disc space*** is the number of disc blocks (decimal) permitted the user for storage of programs and files. The value may not exceed 65535 blocks. (A block is 256 words long.)
- PFA** stands for program/file access. This parameter, when included, endows the *idcode* library with program/file access capability. This means that programs and files within the user's library can be accessed to the limit of their restrictions by all other users. NOPFA is the system default for this parameter — automatically establishing that other users cannot access the library belonging to the *idcode*.
- FCP** stands for file create/purge. This parameter is meaningful only when the *idcode* specified is that of a group master (any *idcode* ending with 00). When FCP is included, the group master designated by *idcode* is endowed with the capability to create, read, write or purge locked BASIC-formatted files within the library of any member having the PFA capability. NOFCP is the system default — the group master designated by *idcode* does not have FCP.
- MWA** stands for multi-write access. If included, MWA gives the designated *idcode* the capability to assign SWA and MWA status to files within the *idcode*'s library. NOMWA is the system default for this parameter — automatically barring the *idcode* from assigning multi-write status to files within its library.
- general device*** can be any of the following general device designators. You can include eleven designators in any order. If included, all I/O devices of the class represented by the designator are made available for use by the specified *idcode*.
- PR paper tape reader
 - MT magnetic tape units
 - PP paper tape punches

LP	line printers
CR	card readers
RP	card reader/punch/interpreter units
JT	job transmitters
JL	job line printers
JP	job punches
JI	job inquiry device
JM	job message device
LT	link terminals

COMMENTS

The first four parameters must be entered in the order shown. When a password is omitted, a comma must be entered in the command as a place holder.

Characters in the password can be specified as non-printing characters by holding down the *control* key while entering the character. A non-printing character is symbolized by a superscript "C" following that character, for example Z^c. This feature can be used to assign a password that will not be printed on a user's terminal.

Note: Because the HP 2000 handles the following characters in a special way, do not use them in passwords: line cancel (CAN - X^c), null (NUL - @^c), carriage return (CR - M^c), linefeed (LF - J^c), x-off (DC3 - S^c), rubout (DEL), character delete (BS - H^c), comma, and space. Because some terminals require that certain control characters be reserved for their own use, you may also not be able to use ESCAPE, ENQ (E^c), FF (L^c), and others.

ERROR MESSAGES

DUPLICATE ENTRY

The specified idcode already exists.

SYSTEM OVERLOAD

The table space allocated for entries is full.

ILLEGAL FORMAT

Command entry did not conform to format rules.

EXAMPLES

```
NEW-G362,,65535,65535
```

The example enters user G362. No password was assigned and the maximum terminal time limit and maximum disc space was allowed.

```
NEW-B100,GROUP,6000,150,FCP
```

This example enters a user as a group master having the idcode B100. The group master is assigned the password GROUP with 6000 minutes (100 hours) of terminal time available, 150 blocks of disc storage space permitted and FCP capability.

```
NEW-Q123,BASiCc,100,200 MWA
```

The example enters user Q123 with the password BASIC. Only the letters B, A and S appear at the user's terminal. This user can accumulate 100 minutes of terminal time, can use 200 blocks of disc storage space and may assign to his files MWA and SWA status.

PHONES

You may use the PHONES command to reset the time permitted users for logging on the system.

PHONES-*nnn*

nnn

is a decimal value from 0 to 255 (inclusive) representing the number of seconds allowed to log on the system. A zero value prevents users from logging on the system.

COMMENTS

After a user establishes connection with the system he is allowed a predetermined amount of time to log on. If the user fails to log on within the allotted time, a disconnect occurs. Log-on time is initialized to 120 seconds each time the I/O processor program is loaded. The PHONES command can be used to change the time permitted.

ERROR MESSAGES

ILLEGAL FORMAT

Command entry did not conform to format rules.

EXAMPLES

PHO-90

The example allows users 1-1/2 minutes to log on after the system acknowledges a call.

PHO-0

This example prevents users from logging on the system.

PURGE

You may use the PURGE command to remove library programs and files from the system directory. The command does not execute when users are accessing files.

PURGE-*ddd/yy*

- ddd** is the Julian day of a year. The value must be less than or equal to the current day.
- /** is required to separate the parameter elements.
- yy** represents the last two digits of a year. The value must be less than or equal to the current year.

COMMENTS

It is customary to eliminate from the system outdated or obsolete programs and files. The system manager establishes what is considered a reasonable time for a library element to remain inactive. If it has not been referenced since the data specified in the command, it is automatically purged from the system when this command executes.

Users should be notified of purge schedules to prevent inadvertent loss of seldom referenced programs and files.

The system does not inform you of the programs and files being removed. Thus for documentation purposes, we recommend using the DIRECTORY command both before and after a system purge.

There may be a program named HELLO in the library of the system master (idcode A000). This program is not purged. Each time a PURGE command is executed, the last date HELLO was referenced is changed to the current date.

ERROR MESSAGES

BUSY FILES

Users are currently accessing files. The command did not execute.

ILLEGAL FORMAT

Command entry did not conform to format rules.

ILLEGAL PARAMETER

Either the year or day of year is not acceptable as entered.

EXAMPLES

PUR-32/74

The example results in the removal of any library programs or files not referenced since February 1, 1974.

REPORT

You may use the REPORT command to obtain information concerning system users. The command is also available to the system master (refer to the special commands discussed at the end of this section).

REPORT [-idcode]

idcode is the identification code of a specific user. If this optional parameter is included, the report begins with this idcode and continues through the last entry in the directory. If omitted, the report lists the entire directory.

COMMENTS

Figure 3-4 illustrates a REPORT listing. The first line has the following format:

system-ld is the system identification furnished by the operator during system generation.

date is given in the form *ddd/yy*. *ddd* is the current Julian day of the year and *yy* represents the last two digits of the current year.

time is given in the form *hhmm* where *hh* is the current hour (24-hour clock) and *mm* represents the current minute of the hour.

The following information appears under each column heading:

ID is the user identification code.

TIME is the terminal time (in minutes) accumulated by the idcode.

SPACE lists the number of disc blocks occupied by the idcode's library.

CAPABILITIES lists program/file access capabilities assigned to the idcode.

DEVICE DESIGNATORS lists the type of non-sharable devices available for use by the idcode. These are the general device designators you assigned via the NEWID or CHANGEID commands.

ID	TIME	SPACE	CAPABILITIES			DEVICE DESIGNATORS
ALPHA	045/75	1418				
A000	01455	03141				LP,CR
A200	00000	00000		FCP		LP,CR
A233	00000	00000	PFA		MWA	PP,PR,LP,CR
A433	00005	00010	PFA		MWA	JT,JL,JP,JI,JM,MT,PP,PR,LP
A525	00000	00000				
B100	00002	00000	PFA	FCP	MWA	JT,JL,JP,JI,JM,PP,LP,CR
C001	00219	01805	PFA		MWA	PR,LP,CR

Figure 3-4. A Sample Report Listing

RESET

The system maintains a record of total terminal time used by each idcode. The RESET command changes the value within system tables for a designated user or for all users.

```
RESET - { Idcode
          ALL } [, time used]
```

idcode is the identification code of a particular user. If this parameter is selected, the *time used* value is changed for that account only.

ALL is the parameter to enter if you plan to change the *time used* value for ALL users.

time used can be any decimal value from 0 to 65535 representing minutes of time used. If included, this value replaces the current *time used* value. When this parameter is omitted, the value is set to zero.

COMMENTS

The feature provides a means for determining total terminal time used by individual idcodes. It is employed primarily to reset to zero the *time used* values in the system tables. The system manager can schedule REPORTS and then reset the system records to zero; thus producing the periodic terminal usage totals needed for accounting purposes.

The reset feature can also be used to extend more time to an individual terminal user on a temporary basis. The time limit established by the NEWID or CHANGEID commands remains unchanged. Only the records are altered.

ERROR MESSAGES

ILLEGAL FORMAT

Command entry did not conform to format rules.

NO SUCH ID

The specified idcode does not exist.

EXAMPLES

```
RES-Q123,20
```

The example changes the system record of idcode Q123 to indicate twenty minutes of terminal time accumulated.

```
RES-ALL
```

This example resets to zero the time used records for all idcodes.

RJE

The RJE command is used to transmit information to the system's data communication facility (refer to Section VI). If your system has no RJE or 2000 to 2000 Communications facility, this command is not recognized and you receive the message RJE COMMAND NOT APPROPRIATE.

ROSTER

You may use the ROSTER command to obtain a list of currently active ports.

ROSTER

COMMENTS

Up to 32 users can be logged on the system at one time. The port roster is a list appearing in four rows of eight items each. Each item corresponds to a port. The first row reads left to right and represents ports 0 through 7; the second row, ports 8 through 15; the third row, 16 through 23 and the fourth row, ports 24 through 31.

An active port is denoted by the user's identification code. An inactive port is denoted by four consecutive dots (. . . .). The same identification code can be active at more than one port.

Figure 3-5 illustrates a roster listing as it would appear on the system console. Note that user B453 is logged on port 1, Z999 on port 6, A000 on ports 8 and 15, T707 on port 19, F913 on port 24 and J325 on port 31. The remaining ports are inactive.

....	B453	Z999
A000	A000
....	T707
F913	J325

Figure 3-5. A Sample Roster Listing

SLEEP

The SLEEP command is used to copy the operating system to disc. The dialogue following the SLEEP command allows you to copy to magnetic tape those library elements created or changed since the last hibernate. In this case, the system provides transfer verification (if you request it) and calls for additional tapes when they are needed.

SLEEP [-character string]

character string is any message up to 68 characters in length (including non-printing characters and blanks). The system prints the message on all active terminals.

COMMENTS

Because this command initiates system shutdown, it is appropriate to first obtain a Roster and then issue the ANNOUNCE command to ask users to log off the system. You might also want to use the BANNER command to warn users who log on the system after your announcement. If RJE is connected, it should be disconnected using the RJE-SD command.

When the SLEEP command executes, the following actions result: if specified, a message is sent to active users; the system immediately disconnects all users; operating non-sharable devices are deactivated; and the HP 2000 Operating System is copied on disc.

In the event of a power failure during a sleep, the system processor halts with 102004, displayed. The system must be restarted from disc and the sleep must be restarted in order to provide proper system backup.

Note the difference between a SLEEP and a HIBERNATE. During a sleep, the option exists to copy to magnetic tape those programs and files changed or created since the last hibernate. During a hibernate, the system and all programs and files are copied to magnetic tape.

A console log of a sleep dialogue follows. Note from the underlined operator input that responses may be abbreviated. Table 3-2 presents the same procedure as detailed instructions.

SLE

```
SYSTEM DUMP OR RELOAD? D
MOUNT REEL NUMBER 1. PRESS RETURN
VERIFY? Y
DONE
```

```
SYSTEM DUMP OR RELOAD? R
LOAD OR DUMP COMMANDS? return
DATE? 119/76
TIME? 1425
HP22687A-1644
```

Table 3-2. SLEEP Procedures

STEP NUMBER	PROCEDURE
1	At the system console type SLE. After a pause, the computer responds SYSTEM DUMP OR RELOAD?
2	At this point you can respond DUMP to create a backup sleep tape (to backup the system and libraries that are stored on disc). When you type DUMP, the system responds MOUNT REEL NUMBER 1. PRESS RETURN.
3	Ensure that a write ring is installed on the correct SLEEP tape. (Refer to Backup Recommendations for a suggested tape rotation scheme.) Mount the tape on the magnetic tape unit and position at the load point. Select unit-0 and place the tape drive on-line. If you have multiple tape drives, ensure only the drive you intend to use for the sleep is selected as unit-0.
4	Press <i>return</i> on the system console.
5	<p>The computer asks VERIFY? Respond YES to rewind and compare the tape or NO to bypass verification.</p> <p>If tape verification fails, the system prints TAPE BAD. CORRECT AND PRESS RETURN. To try the dump again, mount either the same tape or a new reel, place the tape drive on-line, and press <i>return</i> on the system console.</p> <p>If more than one tape is required, the system calls for more tapes until dumping is complete. Any additional tapes must not be mounted until requested. Do not remove each reel until a new message is printed on the console.</p>
6	<p>After a successful dump or verify, the system prints</p> <p style="padding-left: 40px;">DONE SYSTEM DUMP OR RELOAD?</p> <p>Respond DUMP if you want another backup copy. The entire sleep procedure is repeated.</p> <p>A <i>return</i> or a NO response causes the main computer to halt with 102077, displayed in the main processor's display register. If desired, the system may now be powered down.</p> <p>Respond RELOAD to immediately resume timesharing. After you type RELOAD, the loader prompts LOAD OR DUMP COMMANDS? Respond NO or <i>return</i> to reload the system. Otherwise, respond LOAD, RESTORE, or DUMP (refer to Sections IV and VII).</p>
7	After a NO response to the LOAD OR DUMP COMMANDS? prompt, the system prints DATE? Type the Julian day/year followed by a carriage return. For example: 119/76 represents April 28, 1976.
8	The system asks for the current TIME? Type your response using the 24-hour clock and follow with a carriage return. For example: 1425 represents 2:25 P.M.
9	The system prints HP22687A-date code. Users may now log on.

ERROR MESSAGES

PUT MAG TAPE ON-LINE.

You specified a DUMP to magnetic tape but either unit-0 is not selected on the tape drive or the tape drive is not on-line. Make the necessary correction(s) and press *return* on the system console.

ILLEGAL FORMAT

Command entry did not conform to format rules.

EXAMPLES

```
SLE
```

The example initiates a SLEEP, with no communication to active users.

```
SLE-GOODBYE, SYSTEM WILL BE SHUT DOWN UNTIL 8 A.M.
```

This example also initiates a SLEEP but a message tells active ports what is happening.

STATUS

You may use the STATUS command to obtain information about disc devices and disc organization.

```
STATUS
```

COMMENTS

Normally, you issue this command each time the system is restarted to provide system disc locations. Such information is necessary for diagnostic purposes in case of system problems.

```
system-id  date  time

DISCS
LOGICAL   SELECT  UNIT   FIRST  LAST
UNIT      CODE    NUMBER BLOCK  BLOCK

LOCKED DISC BLOCKS

DISC ALLOCATION
IDT
ADT
DIREC
SYSTEM
USERS
```

Figure 3-6. Status Listing Format

The format shown in figure 3-6 is the format used for STATUS reports (refer to the sample in figure 3-7). An explanation of the headings follows:

<i>system-id</i>	is the system identification furnished by the operator at system generation.
<i>date</i>	is the current date in the form <i>ddd/yy</i> . <i>ddd</i> is the Julian day and <i>yy</i> is the last two digits of the current year.
<i>time</i>	is given in the form <i>hhmm</i> where <i>hh</i> is the current hour (24-hour clock) <i>mm</i> represents the current minute of the hour.

Note: Disc addresses are printed as logical block addresses of six decimal digits.

DISCS

LOGICAL UNIT
SELECT CODE
UNIT NUMBER
FIRST BLOCK
LAST BLOCK

Information about each disc in the system is printed under these headings. The first four blocks (0 through 3) of each disc are reserved for system information and are omitted from the status report.

LOCKED DISC BLOCKS	lists the disc blocks that were locked with the MLOCK command.
DISC ALLOCATION	is divided into five categories: the HP 2000 System idcode table (IDT), available disc table (ADT), directory track addresses (DIREC), system area addresses (SYSTEM), and user swap area addresses (USERS).
IDT, ADT, DIREC	These reports are given in the form <i>aaaaaa-www</i> where <i>aaaaaa</i> is the address of the starting block and <i>www</i> is the used length (decimal) in words .
SYSTEM	is reported in the form <i>aaaaaa-bbb</i> where <i>aaaaaa</i> is the address of the starting block and <i>bbb</i> is the length (decimal) in blocks .
USERS	is reported in the form <i>aaaaaa</i> where <i>aaaaaa</i> is the starting block address of each user swap area. Swap areas are 42 blocks long.

ERROR MESSAGES

DISC ERROR; CAN'T DO IT

This message is printed when disc errors occur during command execution.

ALPHA		134/75		0958	
DISCS					
LOGICAL	SELECT	UNIT	FIRST	LAST	
UNIT	CODE	NUMBER	BLOCK	BLOCK	
0	15	0	000004	046689	
1	15	1	046694	093379	
LOCKED DISC BLOCKS					
DISC ALLOCATION					
IDT					
000135-1452					
ADT					
000167-0099 000230-0093					
DIREC					
000262-3084 000294-3036 000326-3024 000358-3024 000390-3024					
000422-3024 000460-3036 000492-3108					
SYSTEM					
000524-113 000004-001 000005-004 000009-001 000010-002					
000012-017 000029-016 000045-016 000061-016 000077-011					
000088-001 000089-003 000092-002 000094-013 000107-022					
000129-002 000131-004					
USERS					
000637 000690 000732 000774 000816 000858 000920 000962					
001004 001046 001088 001150 001192 001234 001276 001318					
001380 001422 001464 001506 001548 001610 001652 001694					
001736 001778 001840 001882 001924 001966 002008 002070					

Figure 3-7. A Sample Status Listing

LOADER COMMANDS

The loader commands listed are the commands you may enter from the system console as responses to loader queries. They are used during system generation and other loading procedures. Individual command descriptions follow the list.

DISC	MLOCK	} These are both system and loader commands.
DUMP	MUNLOCK	
FORMAT	RESTORE	
LOAD		

DISC (loader command)

The DISC command is used for adding disc drives to the system or for removing them. This command can be used only during system generation or during restart from magnetic tape — in response to the DISC OR FORMAT COMMANDS? query.

DISC - *disc number,select code,unit number*

disc number is a value 1 to 7 designating the logical disc number.

select code is an octal value designating the lower-numbered select code (I/O channel) of the controller to which the disc is connected.

unit number is a value indicating the disc's physical unit number on the controller.

COMMENTS

System information and user libraries are stored on discs. The system references information on the discs as a linear sequence of blocks; each block is 256 words in length. The HP 2000 System requires approximately 1250 blocks (0.64 megabytes) for a 16-port system or 2000 blocks (1.1 megabytes) for a 32-port system. The remainder of the disc space is available for user libraries.

Block number assignments within the system are dynamic, depending upon the logical discs configured into the system and their types (models). Thus whenever a logical disc is added, removed, or changed in type (for instance, when you substitute a 2883 disc for a 7905 in a mixed-disc configuration), system block numbers are automatically renumbered to reflect the change in available disc space. If the logical disc numbers are not contiguous, the missing discs contribute "zero blocks" to the system block numbering scheme.

To remove a disc from the system, enter the DISC command with a select code value of zero. In this case, the unit number parameter and preceding comma are not permitted. Note that disc-0 is always present on the system. Note also that if you configure any 7905 or 7920 discs on the system, their select code must be 14.

Operator Commands

Using the DISC command to add or remove discs is a logical operation that does not effect hardware configuration. If, at the same time, you also add or remove the associated disc controller boards (refer to Section I), then you may have to reconfigure the I/O processor program. Reconfiguring the IOP will be necessary, for instance, when you add additional disc controllers because you will also have to move the magnetic tape interface boards to different slots. This changes the magnetic tape unit's select code which is required by the configured I/O processor program.

ERROR MESSAGES

ILLEGAL FORMAT

Command entry did not conform to format rules.

EXAMPLES

```
DIS-1,21,2
```

The example adds disc-1 to the system. The disc is associated with the controller in I/O slot 21-22 and is unit-2 on the controller.

```
DIS-1,0
```

This example removes disc-1 from the system.

DUMP (loader command)

This DUMP command is a loader command used to selectively copy programs and files to magnetic tape. You may use this command during any of the restart procedures (refer to figure 4-1).

```
DUMP
```

COMMENTS

At one point in a restart dialogue the loader query LOAD OR DUMP COMMANDS? is printed on the system console. At this time you may respond DUMP, or simply DUM, to selectively dump programs and files. We again discuss selective dumping in Sections IV and VII.

FORMAT

(loader command)

You must format new disc packs and cartridges before introducing them into the system. During system generation or during restart from magnetic tape, dialogue with the loader program includes a DISC OR FORMAT COMMANDS? query. To accomplish formatting, respond with this command.

FORMAT - *disc number*

disc number

is a value from 0 to 7 (inclusive) designating the logical unit number of the disc drive. The disc number you specify must be an existing logical disc that was defined previously in a DISC command.

COMMENTS

Formatting can take up to four minutes for a single disc pack. If the disc cartridge (or pack) contains bad tracks, disc failure messages are printed. Since these messages can also result from a malfunctioning disc drive, it will be necessary to run the general purpose disc diagnostic furnished with your system to ascertain exact bad track locations and to ensure the problem is with the disc rather than with the disc drive. Use the tables in Appendix E to convert the hardware locations (returned by the diagnostic) into the block numbers required by the HP 2000 System. These block numbers can next be used to lock the bad tracks via the MLOCK command.

ERROR MESSAGES

DISC PROTECTED

The specified disc drive has its switches set to the protected state. Correct the condition and reenter the command.

FORMAT ABORTED

There is an excessive number of bad tracks on the disc being formatted. Formatting was not completed.

EXAMPLES

```
FOR-1
```

The example requests formatting of disc-1.

LOAD

(loader command)

This loader command may be used to selectively load programs or files from sleep, hibernate, and dump tapes. You may use this command during any of the restart procedures (refer to figure 4-1).

LOAD

COMMENTS

At one point in the startup or restart dialogue the loader query LOAD OR DUMP COMMANDS? is printed on the system console. At this time you may respond LOAD, or simply LOA, to selectively load programs and files. We again discuss selective loading in Sections IV and VII.

MLOCK

(loader and system command)

The MLOCK command allows you to make disc blocks unavailable to the system. The command can be used during initial system generation, during restart from magnetic tape (refer to Section IV), and during system timesharing.

MLOCK - *block1* [,*block2*]

block1

is the number of the first or only block being removed from the system. The value must be greater than 3 (because the first four blocks on each disc cannot be MLOCKED). The maximum depends on the total disc capacity of the system.

block2

is the number of the last block to be locked in a range beginning at *block1*. The value must be greater than 3; but the maximum depends on the total disc capacity of the system. If specified, *block2* must be greater than or equal to *block1*. If omitted, *block1* is the only block MLOCKED.

COMMENTS

This command is used primarily to eliminate physically faulty areas on a disc. Bad block numbers can be determined in two ways. (1) When disc errors occur during transfer of data to or from a disc, the system prints a message on the system console. This message contains the disc block number (where the error occurred) and

the number of blocks involved. (2) When bad blocks are discovered by the system during disc formatting, a disc diagnostic is used to locate the exact hardware addresses of the bad blocks. You then use the tables printed in Appendix E to convert these addresses to the block numbers required by HP 2000.

Any blocks except the first four on each disc can be locked. However, at least 150 blocks on logical disc-0 must not be locked because portions of the system software must reside on this disc.

Once the MLOCK command executes, the disc blocks remain locked until they are unlocked via an MUNLOCK command. This is true even if a different HP 2000 System is initiated because each disc maintains a table of its locked blocks.

If an MLOCK command references an area containing user programs and files, the programs and files are lost. If a referenced area contains system tables, the command is rejected; system tables cannot be removed without destroying the system. Any referenced blocks already locked are unaffected by entry of this command.

ERROR MESSAGES

LOCK FEWER BLOCKS

The block specification infringes on system requirements. Reenter the command with a smaller specification.

CAN'T LOCK *fffff* TO *uuuu*

The blocks in the range indicated cannot be locked because they are required for system use.

DISC ERROR; CAN'T DO IT

A disc error occurred during command execution.

ILLEGAL FORMAT

Command entry did not conform to format rules.

ILLEGAL PARAMETER

Some of the blocks specified do not exist; or they overlap from one disc to another; or they are indicated in the wrong order (first block number greater than last block number).

LOCKED BLOCKS TABLE FULL

There is no room in the system table of locked blocks for your entry.

NONEXISTENT DISC

The blocks requested do not exist on any disc in the system configuration.

EXAMPLES

MLO-525

The example locks block 525.

MLO-525,530

This example locks disc blocks between 525 and 530 (inclusive).

MUNLOCK

(loader and system command)

This command is used to unlock disc blocks locked by the MLOCK command, thereby making them available to the system. The command can be used during initial system generation, during restart from magnetic tape (refer to Section IV), and during system timesharing.

MUNLOCK - *block1* [,*block2*]

- block1*** is the number of the first or only block being unlocked. The value must be greater than 3 (because the first four blocks on each disc cannot be MUNLOCKED). The maximum depends on the total disc capacity of the system.
- block2*** is the number of the last block to be unlocked in a range beginning at *block1*. If specified, *block2* must be greater than or equal to *block1*. If omitted, *block1* is the only block MUNLOCKED.

COMMENTS

Any unlocked blocks referenced in the MUNLOCK command remain unaffected.

ERROR MESSAGES

DISC ERROR; CAN'T DO IT

A disc error occurred during command execution.

ILLEGAL FORMAT

Command entry did not conform to format rules.

ILLEGAL PARAMETER

Some of the blocks specified do not exist; or they overlap from one disc to another; or they are indicated in the wrong order (first block number greater than last block number).

LOCKED BLOCKS TABLE FULL

There is no room in the system table of locked blocks. You unlocked an area in the middle of a previously locked area, causing the previous entry to become two entries.

NONEXISTENT DISC

The blocks requested do not exist on any disc in the system configuration.

EXAMPLES

MUN-525

The example unlocks disc block 525, thus returning it to the system.

MUN-525,530

This example unlocks disc blocks between 525 and 530 (inclusive).

RESTORE

(loader command)

This loader command is used to selectively replace existing programs and files. You can enter this command. You may use this command during any of the restart procedures (refer to figure 4-1).

RESTORE

COMMENTS

At one point in a startup dialogue the loader query LOAD OR DUMP COMMANDS? is printed on the system console. At this time you may respond RESTORE, or simply RES, to selectively replace existing programs and files. We again discuss the selective restore feature in Sections IV and VII.

SPECIAL COMMANDS

The special commands listed are commands shared by the system operator and the system master. They can be entered at a user terminal after logging on the A000 account. Individual command descriptions follow the list.

DIRECTORY
DUMP
REPORT

DIRECTORY (A000 on-line)

This command lists library programs and files according to user idcodes.

```
DIRECTORY*OUT=file name*[idcode]  
DIRECTORY [-idcode]
```

file name is the name of an ASCII file. The file must have been previously defined and associated with an I/O device via the FILE command. When *OUT=*file name** is included, the Directory is sent to the associated I/O device.

idcode is the identification code assigned to a user. If specified, the Directory listing begins with this idcode and continues through to the end of the Directory entries. If omitted, the listing includes all entries in the Directory.

COMMENTS

An explanation of a Directory report plus a sample Directory listing has been included with the system commands.

ERROR MESSAGES

ILLEGAL FORMAT
Command entry did not conform to format rules.

EXAMPLES

```
DIR-B000
```

This example lists, on the user's terminal, Directory entries beginning with idcode B000 and continuing through to the end of all Directory entries.

```
FIL-LINPR,LP  
DIR *OUT = LINPR*B000
```

This example lists the same Directory entries as the first example, but the entries are printed on a line printer.

```
DIR
```

This command prints all Directory entries on the user's terminal.

DUMP (A000 on-line)

This command can be issued by the system master to dump selected portions of the system processor or I/O processor memory contents. The command is also used to dump the contents of the user swap area and the Available Disc Table.

$$\text{DUM} - \left\{ \begin{array}{l} \text{SYS } [, \textit{starting word}] \\ \text{SWA } [, \textit{port number } [, \textit{starting word}]] \\ \text{IOP } [, \textit{starting word}] \\ \text{ADT } [, \textit{starting track}] \end{array} \right\}$$

$$\text{DUM*OUT} = \textit{file name} * \left\{ \begin{array}{l} \text{SYS } [, \textit{starting word}] \\ \text{SWA } [, \textit{port number } [, \textit{starting word}]] \\ \text{IOP } [, \textit{starting word}] \\ \text{ADT } [, \textit{starting track}] \end{array} \right\}$$

file name is the name of an ASCII file. The file must have been previously defined and associated with an I/O device via the FILE command. When *OUT = *file name** is included, the dump will be printed on the associated I/O device.

SYS When SYS is selected, the system processor memory is dumped.

SWA When SWA is selected, user swap areas are dumped.

IOP When IOP is selected, the I/O processor memory is dumped.

ADT When ADT is selected, each track of the Available Disc Table is dumped.

port If a port number (0-31) is included with the SWA parameter, the swap area dump starts with the indicated port and continues through to the end of all swap areas for all the remaining ports.

starting word When a starting address (in octal) is included, the dump begins at the indicated address and continues to the end of the system processor memory, I/O processor memory, or user swap areas.

starting track When a starting track (0-7) is included, the dump begins at the indicated track and continues to the last track.

COMMENTS

This command may be used only when the DUMP facility is enabled by the system operator via the system console DUMP command. Using this command affects neither users at other terminals nor general system operation. The system master can stop a dump at any time by pressing the break key.

ERROR MESSAGES

DUMP IS NOT ENABLED

The dump feature has not been enabled at the system console (using the system operator DUMP command).

SWAP AREA CANNOT BE DUMPED BY USER

The portion of system processor memory containing the swap area cannot be dumped (any requested portion outside this area is dumped).

UNABLE TO READ ADT TRACK

A disc error prevents dumping an ADT track.

UNABLE TO READ SWAP TRACK

A disc error prevents dumping a swap track.

ILLEGAL FORMAT

A decimal number was entered where only an octal digit is permitted or the command entry did not conform to the format rules.

EXAMPLES

```
DUM-ADT
```

This is a request for a dump of the Available Disc Table onto the user terminal.

```
FIL-LINPR,LP  
DUM*OUT=LINPR*ADT
```

This example makes the same request as the first example, except the output will be sent to a line printer.

```
DUM-SWA,12
```

This example requests a dump of the user swap area starting with user port number twelve and continuing through all ports configured on the system.

REPORT (A000 on-line)

The system master may use this command to obtain information concerning users of the system.

```
REPORT*OUT =file name* [idcode ]  
REPORT [-idcode ]
```

file name is the name of an ASCII file. The file must have been previously defined and associated with an I/O device via the FILE command. When *OUT=*file name** is included, the Report will be printed on the associated I/O device.

idcode is the identification code assigned to a user. If specified, the Report listing begins with this idcode and continues through to the end of all idcodes assigned on the system.

COMMENTS

An explanation of a Report and a sample listing has been included with the system commands.

EXAMPLES

```
REP
```

This example lists, on the user's terminal, all idcodes along with the terminal time used, disc space used, account accessibility, and I/O device accessing capability for each idcode.

```
FIL-LINPR,LP  
REP*OUT=LINPR*
```

This example lists all idcodes and the associated information on a line printer. LINPR is the file name.

```
REP-C100
```

This example lists, on the user's terminal, idcodes and the associated information beginning with idcode C100 and continuing until all idcodes have been listed.

```
FIL-LINPR,LP  
REP*OUT=LINPR*C100
```

This example produces the same Report as example three, but this time the list is sent to a line printer.

SYSTEM STARTUP/RESTART

SECTION

IV

The operating procedures in this section are used to generate a system and then to maintain it. Throughout the entire section you will notice numbers within rectangles, for example, **4** . These numbers are used as keys to the operations overview presented in figure 4-1.

OVERVIEW OF OPERATING PROCEDURES

Operating procedures usually involve one of the following:

- Generating an initial operating system (before there are users or libraries).
- Updating or changing an existing operating system.
- Restarting a system after shutdown or after a failure.

When establishing a new system, both the system (main) processor and the I/O processor programs must be configured and loaded. When updating a system, the system program is always reconfigured and reloaded. However, the IOP may or may not be reconfigured, depending upon circumstances discussed later. Restart procedures usually involve nothing more than reloading the system processor program from disc, or reloading both processors and all libraries from backup magnetic tapes.

SYSTEM STARTUP

Most system startup sequences begin by loading the Master Program from the master magnetic tape **1** . At one point in the ensuing dialogue, the console types LOAD WHICH MODULE? If you intend to configure or load both the I/O processor program and the system processor program, the I/O processor program must be configured or loaded first. In other words, the I/O processor program must be running before you can perform any operations involving the system processor program **2** .

During I/O processor configuration, options exist to dump a copy of the configured IOP onto the master tape or onto a separate stand-alone magnetic tape. If a copy of the configured IOP exists on the master tape and no changes are desired, you can instruct the Master Program to reload the IOP from the master tape **3** . In all other cases when the I/O processor program is to be loaded (initial system generation, absence of a previously configured I/O processor program, or when the I/O processor must be reconfigured), you can use the Master Program to build an I/O processor according to your directions. As the program is configured, it is transmitted to the I/O processor memory and then dumped (if requested) to the master tape or to a stand-alone magnetic tape copy **4** .

Ordinarily, a 2100 I/O processor requires reloading only when changes are desired. The same is true for 21MX I/O processors so long as battery power is sustained during shutdowns and power failures.

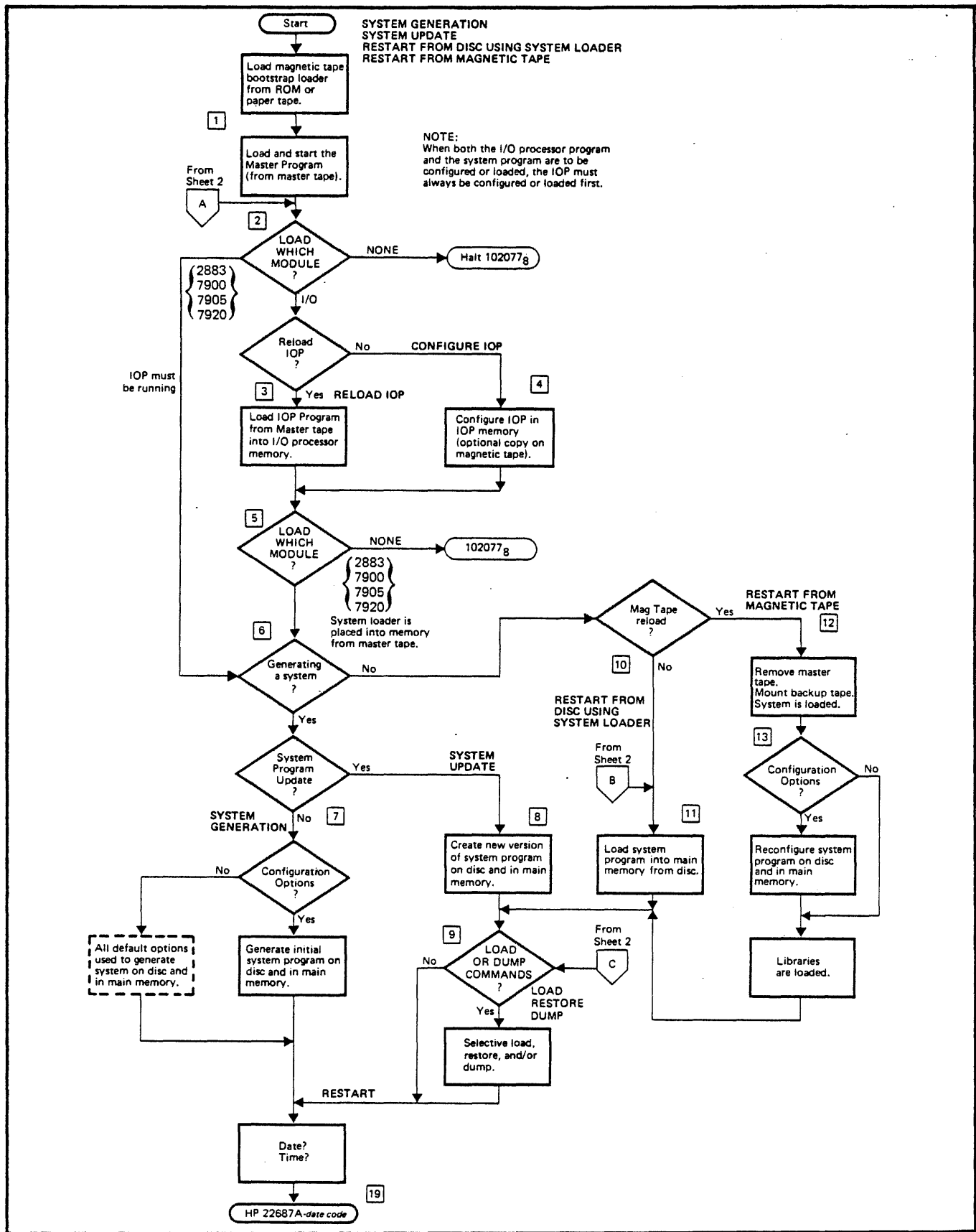

Figure 4-1. Operating Procedures Overview, Flow Diagram (Sheet 1 of 2)

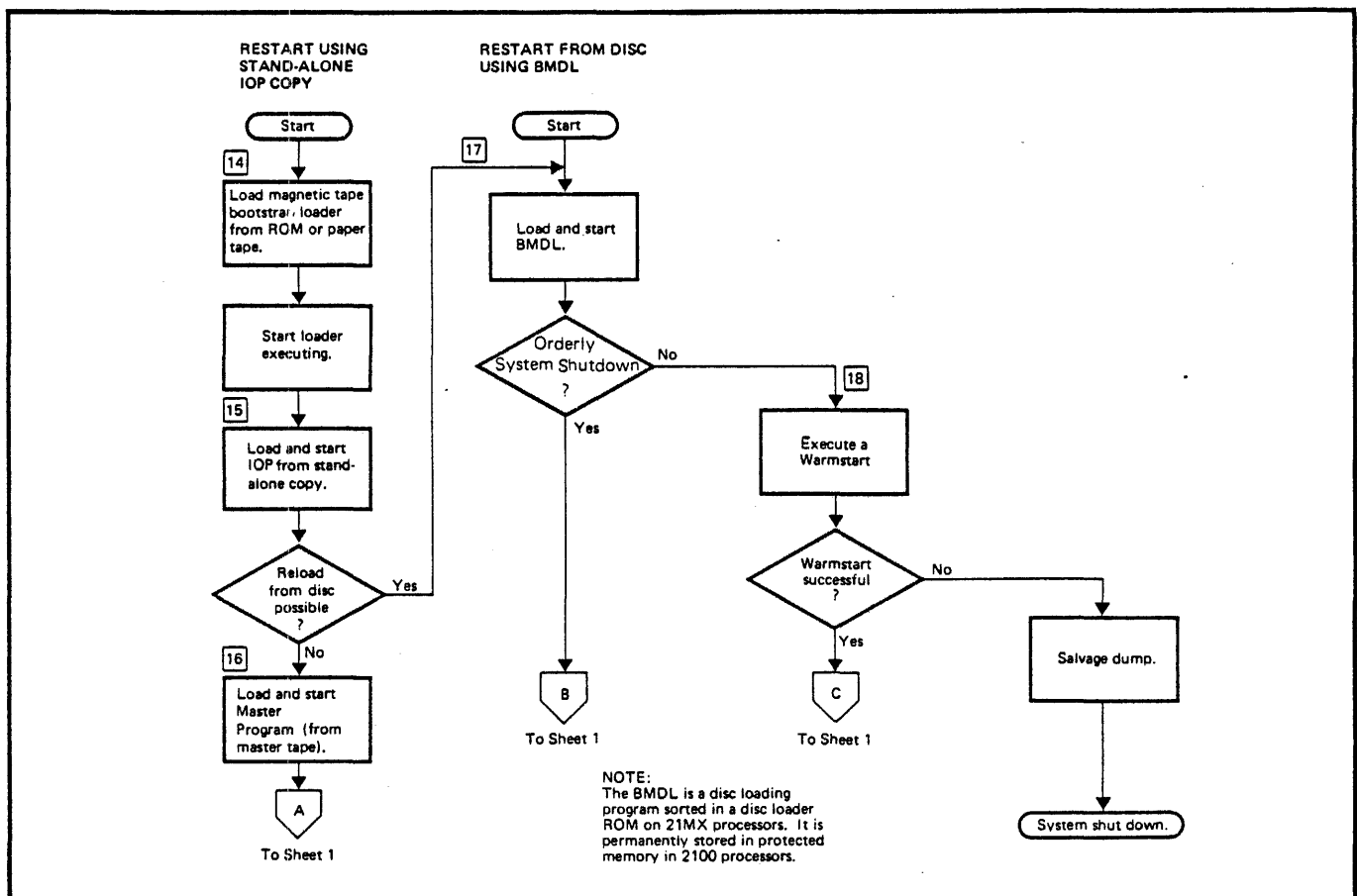

Figure 4-1. Operating Procedures Overview, Flow Diagram (Sheet 2 of 2)

Following completion of (or in place of) I/O processor loading, you can request the Master Program to execute one of the system processor loaders [5]. These programs generate a new system program [7], perform a system program update [8], or reload a previously configured system from disc [11] or from magnetic tape [12]. During an update, the previous system program (on disc) is replaced with a new one while user libraries are retained. In the process, the loader allows you to selectively load, dump, or restore programs and files [9]. Upon completion, the loader automatically initiates HP 2000 operation [19].

SYSTEM SHUTDOWN

Entering a SLEEP or HIBERNATE command on the system console initiates an orderly system shutdown. (Refer to Section III, HIBERNATE or SLEEP for the appropriate step-by-step procedures.) The I/O processor is notified to deactivate and deallocate all non-sharable peripherals and to halt all user terminal activity. After logging any active users off the system, the phone boards are set to a "ring forever" condition. As a last step, the shutdown program asks if you want to dump or reload the system. A DUMP or RELOAD response automatically initiates the requested procedure; a carriage return or NO response halts the main processor (but not the I/O processor).

SYSTEM RESTART

Under normal operating procedures you will periodically sleep or hibernate the system to minimize information loss in the event of system failure. Most times you will immediately resume timesharing activities and not shut down the system. Occasionally you may respond NO or *return* to the DUMP OR RELOAD? prompt and the main processor halts. So long as nothing changes on the system during the shut down period, you can press RUN to restart it. Generally, however, you shut the system down to make changes thus necessitating a restart from disc using the BMDL [17]. BMDL stands for Basic Moving-head Disc Loader. This disc loader program is permanently stored in protected memory of 2100 processors or in a disc loader ROM on 21MX processors. If a problem develops with the BMDL, you can reload the system from master tape and disc by following the procedure described in "Restart from Disc Using the System Loader." [10]

Occasionally it is necessary to restore the system from backup magnetic tapes. You can do this by following the procedure described in "Restart From Magnetic Tape." [12] The procedure requires dismounting the master tape and mounting the first backup reel when it is requested by the loader. The Master Program then proceeds to reload the system and libraries requesting additional reels as needed.

Sometimes you might restart operations using a stand-alone magnetic tape copy of a previously configured I/O processor program [14]. In this case, you first load the magnetic tape bootstrap loader program from a ROM if your system has 21MX processors or from a paper tape if your system has 2100 processors. Then you load the magnetic tape copy, start the IOP running, and reload the system program using either the system loader [16] or the BMDL [17].

Note in figure 4-1 that all normal restart sequences provide the opportunity to request selective loading, restoring, or dumping of libraries entries [9]. Also note that they terminate by automatically initiating system operation [19].

OPERATING PROCEDURES

Before any system activity can take place, you must verify certain hardware conditions on the processors.

HARDWARE DIAGNOSTICS FOR HP 21MX E-SERIES PROCESSORS ONLY

Four firmware diagnostic tests are performed automatically on 21MX E-Series processors; tests 1 and 3 are executed on a cold power-up, and tests 1, 2, and 4 are executed whenever the IBL-TEST switch on the operator panel is pressed. Possible error conditions that may be detected and indicated as a result of these self-tests are shown in table 4-1. If any of the errors occur, contact an HP representative for assistance.

Table 4-1. HP 21MX E-Series Self-Test Firmware Diagnostics

Test	Description	Error Condition
1	Tests most of the computer registers and functions.	Error condition sets all display registers, indicator bits, and the overflow register.
2	Checks presently enabled memory space.	Error condition is usually accompanied by a parity error indication and sets all display registers and indicator bits, and clears the overflow register.
3	Tests all memory installed in the computer.	Same as Test 2.
4	Tests load of ROM into memory.	Error condition is indicated if the overflow light is on. This occurs if the select code is less than 10 (octal) or if a memory hardware fault is detected.

BOTH HP 21MX and HP 2100 PROCESSORS

- Ensure the power switches are in the ON position. (Diagnostics are automatically performed on 21MX E-Series processors, and if successful the T-register is automatically selected for display.)
- On HP 7900 disc drives, the Protect/Override switch must be set to OVERRIDE. On HP 7905 disc drives, both the Upper and Lower Disc Protect switches must be set to the down position (the discs are not protected). On HP 2883, 7905 and 7920 disc drives, set the format switch to ON. On 7920 disc drives set the Read Only switch to the OFF position.

HP 21MX PROCESSORS

- The ARS/ $\overline{\text{ARS}}$ switch on the rear of each processor PCA must be set to the ARS position.
- Switch S1 on the rear of each processor PCA must be set to the HALT position.

HP 2100 PROCESSORS

- The Automatic Restart switch on the I/O control board (A6) in each processor must be set to the ARS position.
- The Parity Error switch on the I/O data board (A7) in each processor must be set to the HALT position.

Other than the power switches, the above settings are never altered during normal system operation.

MASTER PROGRAM LOADING

1. Mount the master magnetic tape on the tape drive connected to the main processor. Set the tape at the load point, select unit-0 and press ON-LINE.
2. For 21MX processors, perform the following at the main processor:
 - a. Press HALT and PRESET.
 - b. Select the S-register and clear the display. For 21MX E-Series processors, set bits 14 and 0; for other 21MX processors, set bits 15 and 0. Set bits 11 through 6 to the low number (high priority) octal select code of the magnetic tape device controller. Press STORE.
 - c. Select the A-register and clear the display. Set bit 0. Press STORE and IBL. The contents of the magnetic tape loader ROM are loaded into processor memory. Diagnostics are automatically performed on 21MX E-Series processors when IBL is pressed.
 - d. Press RUN. The Master Program is read from magnetic tape and the processor displays a 102077_8 halt code.
 - e. Check to be certain the system console is ON (and READY if you are using an HP 2762A console).
 - f. Do not alter the S-register. Rather, select the P-register and clear the display. Set bit 10 (002000_8).
 - g. Press STORE and RUN. Continue with step 3.

For 2100 processors, perform the following:

Note: See Appendix D to verify you have the proper BBL installed in the I/O processor.

- a. You were supplied a single paper tape containing two programs: a magnetic tape bootstrap loader and a cross loader program. Place this tape into the paper tape reader, ensuring the feed holes on the tape are inserted toward the front panel. Set the POWER and READ switches.
- b. On the I/O processor, press HALT, INTERNAL PRESET, and EXTERNAL PRESET.
- c. On the I/O processor, select the P-register and clear the display. Set the bits according to the memory size of your I/O processor as follows:

memory	location	set bits
16K	037750	13 through 5, 3
24K	057750	14, 12 through 5, 3
32K	077750	14 through 5, 3

- d. On the I/O processor, press LOADER ENABLE and then RUN. The first program is read from the paper tape and the processor halts with 102077₈ displayed. Any other halt codes indicate failure to read the paper tape properly. In this case, restart the procedure at step a.
 - e. On the main processor, press HALT, INTERNAL PRESET, and EXTERNAL PRESET.
 - f. On the main processor, select the P-register and clear the display. Set bits 14 through 6 (077700₈).
 - g. On the main processor, press LOADER ENABLE and RUN. Nothing happens.
 - h. On the I/O processor, select the P-register and clear the display. Set bit 1 (000002₈).
 - i. On the I/O processor, press RUN. The second program is read from the paper tape into main processor memory. Both processors halt with 102077₈ displayed. Any other halt codes indicate a failure and the procedure should be restarted at step a.
 - j. Check to be certain the system console is ON (and READY if you are using a 2762A console).
 - k. On the main processor, select the P-register and clear the display. Set bit 10 (002000₈). Press RUN.
 - l. The system console types MAG TAPE SELECT CODE? Respond with the lower number (high priority) octal select code of the magnetic tape device controller. The Master Program is read from the magnetic tape and control is automatically transferred to it.
3. The system console types 2754? Answer YES if you are using the HP 2754A/B model teleprinter as a system console. If the console is an HP 2762A, answer NO or press *return*.
 4. The Master Program now asks LOAD WHICH MODULE? 2. The response to this query depends on whether you intend to load the I/O program, the system program, or the 2000/F to 2000 Conversion Program. (Remember, when you intend to load the I/O program it must be loaded first.) Answer precisely with no preceding or embedded blanks one of these: I/O to load the IOP; 7900, 7905, 7920 or 2883 to load the system program; NONE to halt the main processor; or CONV to load the Conversion Program. CONV is covered in Appendix F so nothing more is said about it in this section. Program loading is discussed in following sections of this chapter.

I/O PROCESSOR PROGRAM LOADING

There are three ways to load an I/O processor program into memory.

- Configure the program using the Master Program. In this case, the program is placed into IOP memory concurrent with configuration **4**.
- Load a previously configured I/O processor program from the master tape. The program was copied onto the master tape at configuration **3**.
- Load a previously configured I/O processor program from a stand-alone copy. The copy was made when the program was configured **14**.

Normally the I/O processor program is configured once and saved on magnetic tape. It should not require reconfiguring unless system I/O devices are changed or the I/O processor program itself is to be updated. Occasionally, you might want to generate multiple versions of the I/O processor program to facilitate reconfiguring your system. One version might include RJE with IBM, while another might include RJE with CDC.

If you plan to configure or reconfigure the I/O processor, refer to Appendix A of this manual. If you plan to load a previously configured IOP, use one of the two procedures that follow.

Loading the IOP From Master Tape

First load the Master Program from the master magnetic tape as described previously. This procedure terminated with the query LOAD WHICH MODULE? **2**. Reply I/O. Next the system prints:

```
HP 2000 ACCESS I/O PROCESSOR CONFIGURATOR
RELOAD?
```

1. Respond YES to the reload query. (The NO response is used when you plan to configure or reconfigure the IOP. Refer to Appendix A.) The system console prints START IOP PROTECTED LOADER. PRESS RETURN.
2. **For HP 21MX processors**, perform the following at the I/O processor:
 - a. Press HALT and PRESET.
 - b. Select the S-register and clear the display. Place the low number (high priority) octal select code of the interconnect kit in bits 11 through 6.
 - c. Press STORE and IBL. Automatic firmware diagnostics are performed on 21MX E-Series processors.

For HP 2100 processors, perform the following at the I/O processor:

- a. Press HALT, INTERNAL PRESET, and EXTERNAL PRESET.
- b. Select the S-register and clear the display.

- c. Select the P-register and clear the display. Set bits according to the memory size of your I/O processor as follows:

memory	location	set bits
16K	037700	13 through 6
24K	057700	14, 12 through 6
32K	077700	14 through 6

- d. Press **LOADER ENABLE**.

3. Press **RUN** on the I/O processor. Nothing happens until you press *return* on the system console.
4. After a delay during which the configured I/O processor is located on the master tape, the system reads the program from magnetic tape and the I/O processor halts with 102077₈ displayed. If no halt occurs, or if any other halt occurs, refer to "Startup/Restart Storage Diagnostic Messages" (also in this section).
5. The system prints (I/O PROCESSOR MAY BE STARTED AT LOCATION 2).
6. Select the I/O processor P-register, clear the display and set bit 1 (000002₈). For 21MX only, press **STORE**. Press **RUN**. At this point the I/O processor has been loaded and is running.

Control returns to the Master Program which again asks **LOAD WHICH MODULE?** Proceed to "System Program Loading."

Loading the IOP From a Stand-Alone Tape 14

1. Mount the magnetic tape copy of a previously configured I/O processor program on the magnetic tape unit. Set the tape at the load point, select unit-0 and press **ON-LINE**.
2. **For 21MX processors**, perform the following at the main processor:
 - a. Press **HALT** and **PRESET**.
 - b. Select the S-register and clear the display. For 21MX E-Series processors, set bits 14 and 0; for other 21MX processors, set bits 15 and 0. Set bits 11 through 6 to the low number (high priority) octal select code of the magnetic tape device controller. Press **STORE**.
 - c. Select the A-register and clear the display. Set bit 0. Press **STORE** and **IBL**. The contents of the magnetic tape loader ROM are loaded into memory. Firmware diagnostics are performed automatically on 21MX E-Series processors.
 - d. Press **RUN**. The program that will read the magnetic tape and load the IOP is loaded into memory and the processor displays a 102077₈ halt code.
 - e. Check to be certain the system console is **ON** (and **READY** if you are using a 2762A console).
 - f. Select the P-register and clear the display. Set bit 10 (002000₈).
 - g. Press **STORE** and **RUN**. Continue with step 3.

For 2100 processors, perform the following:

- a. Place the paper tape containing the magnetic tape bootstrap and cross loader programs into the paper tape reader. Ensure the feed holes on the tape are inserted toward the front panel. Set the POWER and READ switches.
- b. On the I/O processor, press HALT, INTERNAL PRESET, and EXTERNAL PRESET.
- c. On the I/O processor, select the P-register and clear the display. Set bits according to the memory size of your I/O processor as follows:

memory	location	set bits
16K	037750	13 through 5, 3
24K	057750	14, 12 through 5, 3
32K	077750	14 through 5, 3

- d. On the I/O processor, press LOADER ENABLE and then RUN. The first program is read from the paper tape and the processor halts with 102077₈ displayed. Any other halt codes indicate failure to read the paper tape properly. In this case, restart the procedure at step a.
 - e. On the main processor, press HALT, INTERNAL PRESET, and EXTERNAL PRESET.
 - f. On the main processor, select the P-register and clear the display. Set bits 14 through 6 (077700₈).
 - g. On the main processor, press LOADER ENABLE and RUN. Nothing happens.
 - h. On the I/O processor, select the P-register and clear the display. Set bit 1 (000002₈).
 - i. On the I/O processor, press RUN. The second program is read from the paper tape. Both processors halt with 102077₈ displayed. Any other halt codes indicate a failure and the procedure should be restarted at step a.
 - j. Check to be certain the system console is ON (and READY if you are using a 2762A console).
 - k. On the main processor, select the P-register and clear the display. Set bit 10 (002000₈). Press RUN.
 - l. The system console types MAG TAPE SELECT CODE? Respond with the lower number (high priority) octal select code of the magnetic tape device controller.
3. The system types START IOP PROTECTED LOADER. PRESS RETURN.
 4. **For HP 21MX processors, perform the following at the I/O processor:**
 - a. Press HALT and PRESET.
 - b. Select the S-register and clear the display. Place the low number (high priority) octal select code of the interconnect kit in bits 11 through 6.
 - c. Press STORE and IBL. Firmware diagnostics are performed automatically on 21MX E-Series processors.

For HP 2100 processors, perform the following at the I/O processor:

- a. Press HALT, INTERNAL PRESET, and EXTERNAL PRESET.
- b. Select the S-register and clear the display.
- c. Select the P-register and clear the display. Set bits according to the memory size of your I/O processor as follows:

memory	location	set bits
16K	037700	13 through 6
24K	057700	14, 12 through 6
32K	077700	14 through 6

- d. Press LOADER ENABLE.
5. Press RUN on the I/O processor. Nothing happens until you press *return* on the system console.
 6. The system reads the configured I/O processor program from magnetic tape and the I/O processor halts with 102077₈ displayed. If no halt occurs, or if any other halt occurs, refer to "Startup/Restart Storage Diagnostic Messages" (also in this section).
 7. The system prints (I/O PROCESSOR MAY BE STARTED AT LOCATION 2)
 8. Select the I/O processor P-register, clear the display and set bit 1 (000002₈). For the 21MX only, press STORE. Press RUN. At this point the I/O processor is running and the main processor is halted with 102077₈ displayed 15.
 9. For 2100 processors only, if you wish to access the master tape, mount the tape as usual on the magnetic tape drive. Next clear the P-register on the main processor and set bit 11 (004000₈). Press RUN. The system now issues the MAG TAPE SELECT CODE? prompt described in "Master Program Loading."

SYSTEM PROGRAM LOADING

Five different methods can be used to place a system program into system processor memory.

- Generate and load an initial program using the Master Program 7.
- Update and load a newer version of a system program using the Master Program 8.
- Restart system activity using the BMDL to reload a previously configured system program from disc 17.
- Restart system activity using the system loader to reload a previously configured system program from disc 11.
- Restart system activity by reloading a previously configured system program from backup magnetic tape 12.

When you plan to generate an initial system program or to update an existing one, you must first load the Master Program using the procedures already explained. If the I/O processor was configured as part of this procedure, it completed by returning control to the Master Program. In either case, the Master Program is waiting for a reply to LOAD WHICH MODULE? . Proceed as follows:

1. Respond 7900 LOADER, 2883 LOADER, 7905 LOADER or 7920 LOADER as appropriate for the model of disc drive configured as disc-0. Note the word LOADER is optional. (If you respond NONE, the main processor halts with 102077₈ displayed.)

If you respond 7905 LOADER or 7920 LOADER then the query 7900 OPTION? is printed. Respond YES if any 7900 discs are also in the system configuration. Otherwise, respond NO or a carriage return.

If you respond NO or a carriage return then the query 2883 OPTION? is printed. Respond YES if any 2883 discs are in the system configuration. Otherwise, respond NO or a carriage return.

Note: Make certain that you don't respond YES to either 7900 OPTION? or 2883 OPTION? if neither of these disc types are on the system; otherwise you will not get the most efficient disc driver for your system configuration.

There is now a pause; the designated system loader is being read from the magnetic tape.

2. The loader asks the question SYSTEM GENERATION? . Respond YES. (A NO response is used when reloading a previously configured system program during a restart from disc or magnetic tape.) There is no default for this question. You must answer explicitly.
3. The system console now types UPDATE? If a previously configured system processor program is to be replaced, retaining existing user data, respond YES and proceed to "Updating a System Program." If generating a system for the first time, respond NO and continue with "Generating An Initial System Program."

Generating an Initial System Program

1. The Loader prints SYSTEM IDENTIFICATION?
Since a new system is being generated, it has no identification. Type any unique name of up to ten printing characters (blanks may be included as characters) to differentiate this system from any other system being used on the same hardware or at the same facility. This name is displayed in the first line of output resulting from DIRECTORY, REPORT, DEVICE, DUMP, and STATUS commands. Note that a carriage return alone signifies that no system identification is desired.
2. The loader prints CONFIGURATION OPTIONS?
Respond YES. The loader starts a sequence of questions that help establish the new system.
Note: If NO or a carriage return (implied NO) is typed here, the loader assumes all the default conditions described below and skips to step 7.
3. The loader starts by asking DISC OR FORMAT COMMANDS?
You may enter a DISC or FORMAT command (refer to Section III). As previously explained, selecting a loader in response to the LOAD WHICH MODULE? prompt defines to system software the model of disc-0. The DISC command must now be used to establish the model and location of any additional discs present on the system (disc-1 through disc-7). After you enter each command, the loader repeats the question. Terminate the sequence of commands by typing either NO or a carriage return. At this point, the loader reads the label on each disc and may type the following messages:

DISC NUMBER *n* NOT LABELED FOR TSB
DO YOU WANT IT LABELED?

The above message indicates the disc was not last used on this system. Sometimes the additional message (NOW LABELED FOR DOS) appears indicating the disc was last used on an HP DOS system. If you respond YES, logical disc-*n* is given an HP 2000 label that includes the system identification, logical disc number, and other information. If the response is NO, and *n* is zero, the loader prints the message DISC 0 MUST BE PRESENT and repeats the previous question. If the response is NO, and *n* is non-zero, the disc is removed from the system.

4. The loader prints MLOCK OR MUNLOCK COMMANDS?
You may now enter an MLOCK or MUNLOCK command (refer to Section III). The loader repeats the question after each command has executed. Terminate the sequence by typing either NO or a carriage return.
5. The loader prints NUMBER OF DIRECTORY TRACKS PER DISC?
Respond with a decimal integer between 1 and 10, inclusive, to indicate how many tracks should be reserved per disc for the system directory. (The directory can accommodate 682 entries per track.) If you enter a carriage return alone, the following default values are assumed: the value 1 for systems with only 7900 disc drives; the value 6 for all other system configurations.
6. The loader prints NUMBER OF ID TRACKS?
Respond with a decimal integer between 1 and 10, inclusive, to indicate the number of tracks to be reserved for the idcode-table. Each track can accommodate 682 user idcodes and related information. A carriage return alone is interpreted as 1.
7. After loading the system program from the magnetic tape, the loader prints DATE?
Respond with the date in the form: *ddd/yy*, where *ddd* is the current day-of-year (up to three digits) and *yy* is the last two digits of the current year. For example, April 28, 1976 is entered: 119/76.
8. The loader prints TIME?
Respond with the current time of day (24-hour clock) as a four digit integer, two each for the hour and minute. For example, 2:15 p.m. is entered: 1415.
9. Finally, the system prints HP22687A-*date code*, indicating that loading is complete and the system is running [19]. (Because *date code* reflects the current level of your system software, it is important to include this number when reporting system problems to your HP representative.) After the tape automatically rewinds, dismount it.

Updating a System Program [8]

1. If the reply to the UPDATE? prompt was YES, the loader replaces the existing system processor program but retains any user libraries which may exist. The updating procedure is used to replace an existing system program with a new one.
2. After a YES response, the loader replaces the system on disc with a new one from the master tape. After the tape begins rewinding, the loader prints LOAD OR DUMP COMMAND? [9]. Respond LOAD, RESTORE, or DUMP if you plan to selectively load, restore, or dump library entries. (Refer to the section titled "Load, Restore and Dump Options.") Otherwise, type NO or a carriage return and continue at step 3.

3. The loader prints DATE?
Respond with the date in the form: *dd/yy* where *ddd* is the current day-of-year (up to three digits) and *yy* is the last two digits of the current year. For example, April 28, 1976 is entered: 119/76.

Note: There will be a short pause just prior to the printing of DATE? while the loader adjusts various tables on the disc.

4. The loader prints TIME?
Respond with the current time of day (24-hour clock) as a four digit integer, two each for the hour and minute. For example, 2:15 p.m. is entered: 1415
5. The loader checks the entered date and time against the date and time the system was last shut down. Any discrepancy (for example, a date and time earlier than those of the last shutdown, or a date more than five days later than that of the last shutdown) results in the loader printing ARE YOU SURE THAT'S TODAY'S DATE?

Respond YES or NO. If the response is YES, the specified date and time are accepted; if NO or a carriage return, the date and time request is printed again.

6. Finally, the system prints HP22687A-*date code*, indicating that loading is complete and the system is running 19.

RESTART PROCEDURES

If the system was properly shut down at the end of the last operating session using the SLEEP or HIBERNATE command and if all the equipment is operating properly, system restart consists of reading the system program from disc storage into main processor memory 17. This procedure involves starting the BMDL executing as soon as all system devices are ready. However, when the system program is to be generated or updated, restart must be initiated using the Master Program 1.

Restart From Disc Using the BMDL 17

When the system was last shut down with the HIBERNATE or SLEEP command, essential portions of the loader were written to the system disc. If the disc has not been disturbed, use the following steps to restart the system.

Note: If the following procedure fails repeatedly, use the procedure described under "Restart From Disc Using System Loader."

1. Ensure that both computers and all peripheral equipment have power and that the hardware configuration is correct.
2. Ensure that the same discs (either cartridge or disc packs) used when the system was last shut down are in place on the same disc devices and that the disc device select codes have not been changed. In addition, the disc drives must be up to full operating speed.
3. The I/O processor program must be running. (If the I/O processor program has been disturbed, refer to "I/O Processor Program Loading" at the beginning of this section.)

4. For HP 21MX processors, perform the following at the main processor:

- a. Press HALT and PRESET.
- b. Select the S-register and clear the display. Set the address in the S-register as follows:

Note: 0 = off; 1 = set

BITS	15	14	13	12	11	10	9	8	7	6	5	4	3	2	1	0
ADDRESS	C		A		0	0	1	1	0	0	0	0	0	0	0	B

A Specifies disc drive model configured as disc-0

- 0 0 7900 disc drive
- 0 1 7905 and 7920 disc drives
- 1 0 2883 disc drive

B Specifies appropriate subchannel

- 0 2883, 7905 and 7920 disc drives
- 1 7900 disc drive

C Specifies ROM disc loader

- 0 1 21 MX all disc drives
- 1 0 21MX E 7900, 7905 and 7920 disc drives
- 1 1 21MX E 2883 disc drive

- c. Press STORE and IBL. Firmware diagnostics are performed automatically on 21MX E-Series processors.

For HP 2100 processors, perform the following at the main processor:

- a. Press HALT, INTERNAL PRESET, and EXTERNAL PRESET.
- b. Select the P-register and clear the display. Set bits 14 through 5 and bit 3 (077750₈). This is the BMDL disc loader starting address.
- c. Press the LOADER ENABLE.

Press RUN on the main processor. The system program is read into memory from disc and the computer halts with 102077₈ displayed. If no halt occurs, or if any other halt occurs, refer to "Startup/Restart Storage Diagnostic Messages" (also in this section). If a HIBERNATE or SLEEP command was not used to shut down the system, then you receive the message:

**SYSTEM NOT SLEPT; FOR WARMSTART ATTEMPT, LOAD MASTER TAPE
AND PRESS RETURN. OTHERWISE MUST RELOAD FROM MAG TAPE**

This message is an indication the system program could not be read into memory from disc. In this case, follow the warmstart procedure outlined in Section V.

6. If the correct halt occurred in step 5, press RUN on the main processor. The loader begins executing.
7. The loader prints LOAD OR DUMP COMMANDS? 9 When you plan to selectively load, restore or dump library entries, type the appropriate response (LOAD, RESTORE, or DUMP) and go to the section titled "Load, Restore and Dump Options." Otherwise, type NO or a carriage return and continue at step 8.
8. The loader prints DATE?
Respond with the date in the form: *ddd/yy* where *ddd* is the current day-of-year (up to three digits) and *yy* is the last two digits of the current year. For example, April 28, 1976 is entered: 119/76.

Note: There will be a short pause just prior to the printing of DATE? while the loader adjusts various tables on the disc.

9. The loader prints TIME?
Respond with the current time of day (24-hour clock) as a four digit integer, two each for the hour and minute. For example, 2:15 p.m. is entered: 1415
10. The loader checks the entered date and time against the date and time the system was last shut down. Any discrepancy (for example, a date and time earlier than those of the last shutdown or a date more than five days later than that of the last shutdown) results in the loader printing ARE YOU SURE THAT'S TODAY'S DATE?

Respond with YES or NO. If the response is YES, the specified date and time are accepted; if NO or a carriage return, the date and time request is printed again.

11. The system prints HP22687A-*date code* indicating that loading is complete and the system is running. Users may now log on.

Restart From Disc Using System Loader

1. Ensure that both computers and all peripheral equipment have power and that the hardware configuration is correct.
2. Ensure that the same discs (either cartridge or disc pack) used when the system was last shut down are in place on the same disc drives and that the disc select codes have not been changed. In addition, the disc drives must be ready.
3. The I/O processor should be in the RUN mode. (If the I/O processor program has been disturbed, refer to "I/O Processor Program Loading" at the beginning of this section.)
4. Load the Master Program from magnetic tape as explained under "Master Program Loading."
5. The system console has typed LOAD WHICH MODULE? Since you want to load the system processor program, type either 7900 LOADER, 2883 LOADER, 7905 LOADER or 7920 LOADER as appropriate for the model of the disc drive configured as logical disc-0. Note the word LOADER is optional 5 .

If you respond 7905 LOADER or 7920 LOADER then the query 7900 OPTION? is printed. Respond YES if any 7900 discs are also in the system configuration. Otherwise, respond NO or a carriage return.

If you respond NO or a carriage return, then the query 2883 OPTION? is printed. If there are any 2883 discs on the system, reply YES; otherwise reply NO or a carriage return.

There is now a pause. The designated loader is being read from the magnetic tape.

6. The system console types SYSTEM GENERATION? Respond NO (a response of YES is used for system configuration, as explained previously) 6 . No default response exists for this question. You must answer explicitly.
7. The system console now asks MAG TAPE RELOAD? Respond NO (a response of YES is used when reloading the system from magnetic tape) 10 .

At this point you may receive the message:

SYSTEM NOT SLEPT; FOR WARMSTART ATTEMPT, LOAD MASTER TAPE
AND PRESS RETURN. OTHERWISE MUST RELOAD FROM MAG TAPE.

This message is printed when you attempt to reload the system program from disc but the system was not shut down using a HIBERNATE or SLEEP command. It indicates there was an abnormal system shutdown. In this case, follow the warmstart procedure outlined in Section V.

8. The loader prints LOAD OR DUMP COMMANDS? 9
If libraries are to be selectively loaded, restored, or dumped, type the appropriate response (LOAD, RESTORE or DUMP) and refer to the section titled "Load, Restore and Dump Options." Otherwise, type NO or a carriage return and continue.
9. The loader prints DATE?
Respond with the date in the form: *ddd/yy* where *ddd* is the current day-of-year (up to three digits) and *yy* is the last two digits of the current year. For example, April 28, 1976 is entered: 119/76.

Note: There will be a short pause just prior to the printing of DATE? while the loader adjusts various tables on the disc.

10. The loader prints TIME?
Respond with the current time of day (24-hour clock) as a four digit integer, two each for the hour and minute. For example, 2:15 p.m. is entered: 1415
11. The loader checks the entered date and time against the date and time the system was last shut down. Any discrepancy (for example, a date and time earlier than those of the last shutdown or a date more than five days later than that of the last shutdown) results in the loader printing ARE YOU SURE THAT'S TODAY'S DATE?

Respond with YES or NO. If the response is YES, the specified date and time are accepted; if NO, the date and time request is printed again.

12. The system prints HP22687A-*date code* indicating that loading is complete and the system is running. Users may now log on. Remove and store the master magnetic tape.

Note: Entering a STATUS command immediately after starting the system provides a map showing where copies of vital system information are located in mass storage. Such information is useful in diagnosing system failures.

Restart From Magnetic Tape

If system information cannot be read from disc storage, the following magnetic tape procedure must be used. When the last system backup was a hibernate, use those tape(s). If it was a sleep, use the sleep tape(s). In both cases, if a salvage dump was obtained, use that tape last; loading it with RESTORE and the ALL option.

1. Ensure that both computers and all peripheral equipment have power and that the hardware configuration is correct.
2. Make certain the disc drives are ready. In addition, if you plan to use the Alternate Allocation Option, ensure that the same discs (either cartridge or disc pack) used when the system was last shut down are installed on the same disc drives; and that the disc select codes have not been changed.
3. The I/O processor should be in RUN mode. (If the I/O processor program has been disturbed, see "I/O Processor Program Loading" at the beginning of this section).
4. Load the Master Program from magnetic tape as explained under "Master Program Loading."
5. The system console has typed LOAD WHICH MODULE? Type either 7900 LOADER, 7905 LOADER, 7920 LOADER or 2883 LOADER as appropriate for the model of disc drive configured as logical disc-0. Note the word LOADER is optional 5.

If you respond 7905 LOADER or 7920 LOADER then the query 7900 OPTION? is printed. Respond YES if any 7900 discs are also in the system configuration. Otherwise, respond NO or a carriage return.

If you respond NO or a carriage return, then the query 2883 OPTION? is printed. If there are any 2883 discs on the system, reply YES; otherwise reply NO or a carriage return.

There is now a pause. The designated loader is being read from the magnetic tape.

6. The system console types SYSTEM GENERATION? 6. Respond NO (a response of YES is used for system generation or update). No default is permitted; you must answer explicitly.
7. The system console now asks MAG TAPE RELOAD? Respond YES. (A NO response is used when reloading the system from disc. Refer to "Restart From Disc With System Loader.")

The loader types MOUNT REEL NUMBER 1. PRESS RETURN

Dismount the HP 2000 master tape and mount the first reel of backup tape on the magnetic tape unit (a write ring is not required) 12. Use the most recent set of sleep tapes before using any hibernate tapes. When mounted, type a carriage return to signal the loader to proceed.

8. The loader prints CONFIGURATION OPTIONS? 13
If the current system program configuration is to be retained, type NO or a carriage return (implied NO). The loader reads in the system program from magnetic tape and skips to step 16.

To change the system program configuration, type YES and continue.

9. The loader prints SYSTEM IDENTIFICATION?
If the current system identification is to be retained, type a carriage return. To change the system identification, enter a string of up to 10 printing characters (blanks may be included as characters) followed by a carriage return.

10. The loader prints DISC OR FORMAT COMMANDS?

You may enter a DISC or FORMAT command (refer to Section III). Selecting a loader in response to the LOAD WHICH MODULE? prompt defines the model of disc-0 to system software. The DISC command must be used to establish the model and location of any additional discs present on the system (disc-1 through disc-7). After you enter each command, the loader repeats the question. Terminate the sequence of commands by typing either NO or a carriage return. At this point, the loader reads the label on each disc and may type the following messages:

DISC NUMBER n NOT LABELED FOR TSB
DO YOU WANT IT LABELED?

This message indicates disc- n was not last used by this system. Sometimes the additional message (NOW LABELED FOR DOS) might appear, indicating the disc was last used on an HP Disc Operating System. If you respond YES to the labeling question, logical disc- n is given a 2000 system label which includes the system identification, logical disc number, and other information. If the response is NO and n is zero, the loader prints the message DISC 0 MUST BE PRESENT and repeats the previous question. If the response is NO and n is non-zero, the disc is logically removed from the system.

11. The loader prints MLOCK OR MUNLOCK COMMANDS?

You may now enter an MLOCK or MUNLOCK command (refer to Section III). The loader repeats the question after each command is entered. Terminate the sequence by typing either NO or a carriage return (implied NO).

12. The loader prints NUMBER OF DIRECTORY TRACKS PER DISC?

Respond with a decimal integer between 1 and 10, inclusive, to indicate how many tracks should be reserved per disc for the system directory. (The directory can accommodate 682 entries per track.) A carriage return alone causes the number of directory tracks per disc specified on the magnetic tape to be retained.

13. The loader prints NUMBER OF ID TRACKS?

Respond with a decimal integer between 1 and 10, inclusive, to specify how many tracks should be reserved for the idcode-table. (Each track can accommodate 682 user idcodes and related information.) A carriage return alone causes the current number of tracks specified in the system on magnetic tape to be retained.

14. The loader prints ALTERNATE ALLOCATE OPTION?

- a. If you type NO or just a carriage return at this point, the loader obtains disc space in the normal manner for the files and programs it reads from magnetic tape. That is, the number of programs and files is divided as evenly as possible among the available discs with adjacent directory entries on different discs, if possible. In addition, the programs and files are compacted toward the beginning of each disc. The only spaces between files and programs on each disc are those caused by locked blocks.
- b. If you type YES at this point, each file and program is put back onto the same logical disc where it resided when the system was last shut down. Each entry will be placed before or after any locked areas on the disc, just as they were when the system was last shut down. Within these constraints, entries are compacted as much as possible toward the beginning of each disc. This procedure guarantees that a system shut down with either the SLEEP or HIBERNATE command can be reloaded if the following conditions are met:

System Startup/Restart

- The same discs are present in the same logical positions on the system.
- No new areas on these discs have been locked.
- The number of ports on the system has not been altered.
- No more directory and idcode-table tracks are present than existed on the shutdown version of the system.

The YES option requests alternate allocation and should be selected if the normal method was attempted but failed to find disc space for all programs and files. The alternate allocation option may also be used if a new disc has been added to the system and it is desired to keep this disc free for new entries.

15. When either response is made to the ALTERNATE ALLOCATION OPTION? query, the loader reads in the system from magnetic tape. Any of the magnetic tape error messages listed in the section titled "Startup/Restart Storage Diagnostic Messages" may be printed during loading from magnetic tape.
16. After the system and libraries have been read, the loader prints LOAD OR DUMP COMMANDS?
 Respond NO to bypass loading and dumping and continue at step 17. Otherwise, respond LOAD, RESTORE, or DUMP to selectively perform one of these operations. If the system previously stopped abnormally and a salvage dump was obtained, you should do a restore using that tape and the ALL option in order to recover changed programs and files that are not on the most recent sleep and hibernate tapes.
17. The loader prints DATE?
Respond with the date in the form: *ddd/yy* where *ddd* is the current day-of-year (up to three digits) and *yy* is the last two digits of the current year. For example, April 28, 1976 is entered: 119/76.

Note: There will be a short pause just prior to the printing of DATE? while the loader adjusts various tables on the disc.

18. The loader prints TIME?
Respond with the current time of day (24-hour clock) as a four digit integer, two each for the hour and minute. For example, 2:15 p.m. is entered: 1415
19. The loader checks the entered date and time against the date and time the system was last shut down. Any discrepancy (for example, a date and time earlier than those of the last shutdown or a date more than five days later than that of the last shutdown) results in the loader printing ARE YOU SURE THAT'S TODAY'S DATE?

Respond with YES or NO. If the response is YES, the specified date and time are accepted; if NO, the date and time request is printed again.

20. The system prints HP22687A-*date code* indicating that loading is complete and the system is running. Users may now log on. Remove and store the master magnetic tape.

Note: Entering a STATUS command immediately after starting the system provides a map showing where copies of vital system information are located in mass storage. Such information is useful in diagnosing system failures.

Load, Restore and Dump Options 9

Note: Procedures for using the LOAD, RESTORE, and DUMP commands follow. You can read an expanded discussion of operating considerations involving these commands in Section VII under the heading "Library Manipulations."

Each time the system is restarted you are given the opportunity to selectively load, restore, or dump library entries. The following sequence occurs:

1. The loader prints LOAD OR DUMP COMMANDS?
If you do not plan to selectively load, restore, or dump programs and files, type NO or a carriage return and continue at step 2. Otherwise, type LOAD, RESTORE, or DUMP as described in the following paragraphs.

CAUTION

Do not mount additional tapes until they are requested by the system. Also, never interrupt operations during a selective load or restore as this necessitates a restart from backup tapes.

- a. Type **LOAD** to selectively load additional programs and files from sleep, hibernate, or dump tapes. During selective loading, the loader searches for the specified entries on the magnetic tape you provide. Entries that duplicate names already in the libraries are not loaded. Only additional entries for a specified account, or for all accounts, are loaded.
- b. Type **RESTORE** to selectively restore programs and files from backup and dump tapes. During selective restoring, the loader searches for the specified entries. When duplicate entries are located, the existing library entry is replaced by the entry from the magnetic tape. All additional magnetic tape entries for a specified account, or for all accounts, are also loaded.
- c. Type **DUMP** to selectively dump programs and files from the system to magnetic tape. The set of tapes thus obtained is similar to those produced by a **HIBERNATE** command; but in this case, the system file is not copied.
- d. In all cases, the loader prints **ENTER NAME LIST, ONE PER LINE, TERMINATE WITH 'END'**. For each program or file that is to be selectively loaded, restored, or dumped, enter the user identification code, a comma, and the entry name. If you enter only the *idcode*, all entries belonging to that user are loaded or restored into, or dumped from the associated library. Typing **ALL** is equivalent to having supplied a list of every *idcode* in the system.

The loader examines each line upon entry. If it is legitimate, the loader generates a linefeed and allows you to type another entry. (Illegal entries result in appropriate error messages.)

Terminate your list of entries by typing **ALL** or **END**.

- e. Mount the first reel of magnetic tape when requested. For dump, use a blank magnetic tape with a write-enable ring installed. For load or restore, mount the first (or only) reel of the appropriate tape set. Ready the magnetic tape unit and press *return* on the system console.

- f. When each load, restore, or dump operation is completed, the loader requests another load or dump command. To end this sequence, type NO or a carriage return.

EXAMPLES: *operator input is underlined*

```
LOAD OR DUMP COMMANDS? LOAD
ENTER NAME LIST, ONE PER LINE;TERMINATE WITH 'END'
C732,FILE1
M935
X222,PROG
END
MOUNT REEL NUMBER 1. PRESS RETURN
```

The LOAD command was issued to load an element named FILE1 associated with idcode C732 and an element named PROG associated with idcode X222 from magnetic tape into the account libraries associated with these idcodes. In addition, all of the elements associated with idcode M935 on magnetic tape are loaded into the library associated with idcode M935.

```
LOAD OR DUMP COMMANDS? DUMP
ENTER NAME LIST, ONE PER LINE;TERMINATE WITH 'END'
ALL
MOUNT REEL NUMBER 1. PRESS RETURN
VERIFY? YES
DONE
```

The DUMP command was issued to produce a copy of all user libraries on magnetic tape. Tape verification was requested; thus the tape was rewound and compared for transfer errors. (Note there is no default response for the VERIFY? query. You must answer explicitly.) In the example, the dump was successful and the loader printed DONE. However, if tape verification had failed, the message TAPE BAD. CORRECT AND PRESS RETURN would have been printed. If this happens, you should repeat the dump using the same tape or a new one. Again ready the magnetic device and press *return* on the system console. When you press *return* the data for the bad tape is repeated. For instance, if the third tape is bad, the dump restarts at the beginning of the third tape when you press *return*.

2. After a short pause (while the loader adjusts various tables on the disc), the loader prints DATE? Respond with the date in the form: *ddd/yy* where *ddd* is the current day-of-year (up to three digits) and *yy* is the last two digits of the current year. For example, April 28, 1976 is entered: 119/76.
3. The loader prints TIME?
Respond with the current time of day (24-hour clock) as a four digit integer, two each for the hour and minute. For example, 2:15 p.m. is entered: 1415.
4. The loader checks the entered date and time against the date and time the system was last shut down. Any discrepancy (for example, a date and time earlier than those of the last shutdown or a date more than five days later than that of the last shutdown) results in the loader printing ARE YOU SURE THAT'S TODAY'S DATE?

Respond with YES or NO. If the response is YES, the specified date and time are accepted; if NO, the date and time request is printed again.

System Startup/Restart

5. The system prints HP22687A-*date code* indicating that loading is complete and the system is running. Users may now log on. Remove and store the master magnetic tape.

Note: Entering a STATUS command immediately after starting the system provides a map showing where copies of vital system information are located in mass storage. Such information is useful in diagnosing system failures.

PROTECTION CODES

A protection scheme involving codes exists for the HP 2000 Computer System. The codes are:

- A System Level Code which is assigned to the system loaders and to the system. This code uniquely identifies the system.
- A Feature Level Code which is assigned to the system to identify the level of features supported by the system.
- A Date Code which is assigned to the system and to system modules to prevent system operation with outdated software.

SYSTEM LEVEL CODES

Currently, HP timesharing systems are given System Level Codes as follows:

<u>System Level</u>	<u>Code</u>
2000/C (High-Speed Option)	2000
2000/F (Options 200/205/500/505)	3000
2000/F (Options 210/215/510/515)	3500
HP 2000 Operating System, Release A	5000
HP 2000 Operating System, Release B	6000

Each time a system is loaded, the loader verifies that it has the correct code for that option.

- At initial system generation or system update the loader verifies that the system contains its System Level Code.
- For a magnetic tape restart, the loader verifies that the set of magnetic tapes was generated by its system.
- For disc restart (bootstraps) the loader verifies that the system on the disc(s) is its system.

In any case, if the system being loaded is not acceptable, the loader prints ILLEGAL SYSTEM CODE, LOAD ABORTED and terminates the loading process.

FEATURE LEVEL CODES

Each system is assigned a Feature Level Code identifying the level of features it supports. Currently, codes are assigned as follows:

<u>Feature Level</u>	<u>Code</u>
2000/C (High-Speed Option)	200
2000/F (All Options)	200
HP 2000 Operating System, Release A	1000
HP 2000 Operating System, Release B	2000

Normally, systems with Feature Level Codes of 1000 or greater cannot access tapes from systems with Feature Level Codes of less than 1000 and vice versa. For exceptions to this rule, refer to conversion information in Appendix F.

Feature Level Codes are used to ensure you do not load programs and files that require features not supported by the current system. When selectively loading programs and files from magnetic tape, if the tapes were produced by a system with a higher Feature Level Code, the loader prints:

TAPE MAY CONTAIN FEATURES NOT SUPPORTED ON THIS SYSTEM (xxxx VS yyyy)
DO YOU TAKE RESPONSIBILITY?

where xxxx is the Feature Level code of the system and yyyy is the Feature Level code from the magnetic tape.

You may respond NO to bypass the load. In this case, you again receive the LOAD OR DUMP COMMANDS? prompt so that loading can continue. If you know in fact none of the programs or files on the tape contain unsupported features, you may respond YES and the selective load will be performed. Any other response causes the message DO YOU TAKE RESPONSIBILITY? to be repeated.

When performing a system update, if the Feature Level code of the disc-resident library is higher than that of the system being loaded, the loader prints:

DISC MAY CONTAIN FEATURES NOT SUPPORTED ON THIS SYSTEM (xxxx VS yyyy)
DO YOU TAKE RESPONSIBILITY?

where xxxx is the Feature Level code of the system which generated the library and yyyy is the Feature Level code of the system being loaded.

You may answer NO; the message LOAD ABORTED will be printed and loading terminates. If you respond YES, the update proceeds. Any other response causes the message DO YOU TAKE RESPONSIBILITY? to be repeated.

DATE CODES

A Date Code is assigned to the system software and to the modules which constitute the system. Each time you start or restart a system the compilation dates must agree. Otherwise, the loader prints:

IOP MAY CONTAIN FEATURES NOT SUPPORTED ON THIS SYSTEM (xxxx VS yyyy)
DO YOU TAKE RESPONSIBILITY?

xxxx reflects the date the system program was compiled while yyyy reflects the date the I/O processor was compiled. This message is a warning that you may be operating your system with outdated software. You may respond NO to abort the startup/restart procedure or respond YES to continue.

STARTUP/RESTART STORAGE DIAGNOSTIC MESSAGES

DISC DIAGNOSTIC MESSAGES

- Notes:
1. Disc errors not associated with system startup/restart procedures appear in Appendix C.
 2. An asterisk (*) indicates that only the Restart From Disc procedure can display the preceding problem.

If the main processor fails to halt within approximately five seconds after you initiate the startup procedure, press HALT. Ensure that a system disc is mounted on unit-0 of the controller in select code slot 14. Check that the drive is ready. Then restart the procedure from the beginning.*

System Startup/Restart

If the main processor halts with 102001₈ displayed, ensure that a system disc is mounted on unit-0 of the controller in select code slot 14. Check that the drive is ready and then restart the procedure from the beginning.*

If the main processor halts with 102002₈ displayed, a read error occurred while reading disc blocks 1 and 2. Press RUN to retry the read.* If the read fails again, refer to "System Recovery" (Section V).

If any blocks in question have been overwritten, the results are unpredictable. Repeated errors of the type described above imply that the "Restart From Disc with System Loader" procedure should be used.

At any time during startup or restart the system may print any of the following messages and then halt with 102000₈ displayed.

NOT READY SEL CODE *m* UNIT *n*

Indicates the specified disc drive is not in the READY condition. Correct the problem and press RUN.

READ ERROR SEL CODE *m* UNIT *n*

The label on the specified pack cannot be read. This may be due to a hardware problem with the disc drive or an unformatted pack. If the problem can be corrected, do so and press RUN.

PUT DISC *d* IN SEL CODE *m* UNIT *n*

A wrong pack has displaced the expected pack on the specified drive. Reinstall the correct pack on the drive and press RUN.

WRONG SYSTEM ID SEL CODE *m* UNIT *n*

The specified pack is not part of the system specified by logical disc-0. Load the correct one. Press RUN.

MAGNETIC TAPE DIAGNOSTIC MESSAGES

Any of the following messages may be printed by the loader while the system and library are being read from magnetic tape:

TAPE ERROR. *idcode name* LOST

The loader has not been able to read the specified entry from the tape, so it has not been recovered. It will have to be loaded from another tape if available.

UNEXPECTED END OF FILE. *idcode name* LOST

An entry on the magnetic tape does not correspond with directory expectations. The named entry is not recovered.

NO ROOM FOR *idcode name*

The loader has found the specified entry on the tape, but cannot find sufficient disc space for it. The entry will be deleted from the directory. If it is desired to put this particular entry on the system, the system must be brought up again with more discs or, if the current load is not using the alternate allocation option, the loading procedure may be attempted again using this option.

DISC *n* NOT PRESENT, LOAD ABORTED

The alternate allocation option was selected and a program or file is to be read from the tape, but the correct logical disc is not present. The loading procedure must be restarted.

MOUNT REEL NUMBER *n*. PRESS RETURN

The system being loaded occupies more than one reel of magnetic tape and the end of a reel (not the last one) has been reached. Mount the next reel in the series and press *return*. The loader checks for the correct reel and continues the loading process.

UNRECOVERED ENTRIES. ANOTHER SET AVAILABLE?

One or more entries residing in the tape directory have not been recovered. This situation usually occurs when you reload the system from backup tapes and the first ones loaded are sleep tapes. In this case, answer YES. Mount the first reel of the most recent hibernate set and press *return*. This situation could also occur because the loader could not read some entries on the set of tapes just loaded. If there is another set of tapes available (earlier sleep, hibernate, or dump tapes), type YES. Otherwise type NO or a carriage return (implied NO).

If the response to ANOTHER SET AVAILABLE? above was YES, the loader prints MOUNT REEL NUMBER 1. PRESS RETURN. Remove the tape just loaded from the tape drive and mount an earlier backup tape. The date of the newly mounted tape must be earlier than the reel just read or the loader types BAD DATE ORDER and repeats the previous question.

If the loader ascertains that it is the correct reel of an acceptable set, the loading process continues; if not, the loader types BAD TAPE LABEL and repeats the previous question. Once an acceptable set of tapes is found, the loader begins reading. Entries on the tape that have already been recovered and entries that do not appear in the directory of the first set of tapes are ignored.

If the response to ANOTHER SET AVAILABLE? above was NO, the loader prints FOLLOWING ENTRIES NOT FOUND: A list of those entries in the directory that have not been recovered from any of the tapes read is printed. In addition, these entries are deleted from the directory.

SYSTEM RECOVERY

SECTION

V

If the system experiences any sort of problem, it is important to avoid losing data unnecessarily. For this reason, there are recovery procedures initiated automatically by the system and, if these fail, there are procedures you can initiate. This section discusses aspects of system recovery and presents step-by-step recovery procedures.

EMERGENCY SLEEP PROCEDURE

An emergency sleep is a sleep performed automatically by the system after a disc problem develops. When addressing problems occur, the system generally prints messages on the system console informing you of the problem and any resulting system action. The message DISC FAILURE - SYSTEM EMERGENCY SLEPT indicates a sleep was performed automatically during recovery procedures. After an emergency sleep, the main processor halts with halt code 102077₈ in the display register.

Before attempting to restart, the cause of the disc failure should be isolated. Run the disc diagnostic program appropriate to the model of the failed disc. (These diagnostics were supplied with your system.)

CAUTION

In this and all following discussions, it is important *not* to destroy the contents of any of the discs attached to the system. All HP disc diagnostic programs may be executed without writing on the disc; if, to isolate a problem, you must write on the disc, be sure to insert a scratch cartridge or pack, making sure not to write on any portion of the fixed disc (non-removable portion of an HP 7900 or HP 7905 disc drive).

If the problem is a malfunctioning disc drive, an HP representative should be called to repair the unit. If the problem is only a few bad blocks on the surface of the disc, the bad blocks can be MLOCKed so long as they do not contain system information. If any user programs or files reside on the bad areas, they will be unavoidably lost in the MLOCK process.

When an emergency sleep is successful and the problem has been corrected without destroying system information on the disc, you should be able to restart your system from disc using the BMDL. An unsuccessful emergency sleep is discussed next.

SYSTEM DEATH PROCEDURE

When disc addressing problems result in an emergency sleep attempt but sleeping the system turns out to be impossible, you receive the message DISC FAILURE - RECOVERY MAY BE IMPOSSIBLE. The main processor halts with halt code 102034₈ displayed. Recovery action in this case consists of executing the disc diagnostic to isolate the problem. If the problem is a malfunctioning disc drive, it can be repaired. If there are bad areas on the disc surface itself, they can be MLOCKed. Occasionally, it may not be possible to MLOCK bad areas because they contain system information. In any case, attempt to warmstart the system. If the warmstart is successful, no data will be lost; but an unsuccessful warmstart means you should obtain a salvage dump (described later).

WARMSTART PROCEDURE

Warmstart is the name of a recovery program on the master tape. During execution, this program checks whether disc resident tables are in good order and consistent with each other. If they are, warmstart performs an automatic system restart from disc. Using warmstart is the preferred way to restart a failed system.

The first step in the warmstart procedure is to attempt to restart from disc. Because disc restart procedures can be used only if the system was shut down following a HIB OR SLE command, your attempt causes the message:

```
SYSTEM NOT SLEPT; FOR WARM START ATTEMPT, LOAD MASTER TAPE  
AND PRESS RETURN. OTHERWISE MUST RELOAD FROM MAG TAPE
```

Since a warmstart is desired, load the master tape onto the magnetic tape drive, set at load point, select unit-0, and press ON-LINE. Then press *return* on the system console. The warmstart program is loaded into memory and begins executing.

The first message ****WARMSTART PROGRAM**** is followed by the name of the first major check. If the test completes successfully, you receive the message OK, otherwise the reason for test failure is printed. (Failure messages you can receive are listed in table B-9 in Appendix B.) Subsequently, the name of each succeeding test is printed followed by the result. Finally, if the warmstart succeeds you receive the message ****WARMSTART CHECK COMPLETE**** and, after a short pause, the question LOAD OR DUMP COMMANDS? You may now elect to load, dump, or restore library entries (refer to "Load, Restore and Dump Options" in Section IV) or you may respond NO or *return* to receive the date and time prompts.

SALVAGE DUMP

Occasionally, warmstart determines system recovery is impossible and prints the message WARMSTART FAILURE - ATTEMPT SALVAGE DUMP? If you have current backup tapes available and no changes have been made to user programs and files since they were made, you can respond NO and the system halts with halt code 102077, displayed. Otherwise, respond YES or a carriage return to selectively dump all accessible programs and files to magnetic tape. After a YES response, you receive the message MOUNT REEL NUMBER 1. PRESS RETURN. At this point, mount a spare magnetic tape with a write enable ring installed, set at load point, select unit-0, and press ON-LINE. Then press *return* on the system console. When a salvage dump is only partially successful, i.e., some programs and files were lost, the system generally prints both the idcode and name of the first non-recoverable entry, and the idcode and name where the salvage dump resumed. Thus it is possible to compare this information with a copy of the directory to determine exactly which entries were lost. (Note however, there is a possibility that the type of failure precludes any explicit notification of lost entries.)

After a salvage dump, you receive the message:

```
DONE  
SYSTEM SHUT DOWN
```

Then the main processor halts with halt code 102077, displayed.

After a salvage dump, restart the system from backup magnetic tapes and do a selective restore from the salvage tape. Be sure to use the ALL restore option. (Refer to "Load, Restore and Dump Options" in Section IV.)

SYSTEM HALTS — SYSTEM UNRESPONSIVE

If the system fails to respond or halts, you must sometimes do some detective work to discover the cause. Basically, six situations can occur:

- Parity error.
- I/O processor halted.
- Main processor halted with no console message displayed.
- Both processors halted.
- Neither processor halted but system devices fail to respond.
- Diagnostic error message(s) followed by main processor halt.

Figure 5-0 illustrates procedures you should follow before performing a Cold Dump.

PARITY ERROR

If a parity error occurs on the IOP, you can try a panic sleep after the problem has been fixed. If either processor parity light is ON, a parity error has occurred. Contact your HP representative. After the problem has been isolated and corrected, reload the IOP from magnetic tape. Attempt to load the system from disc using the BMDL or master tape. This generates the SYSTEM NOT SLEPT. . . message. Mount the master tape and press *return* on the system console. The warmstart program determines whether or not the system is recoverable.

I/O PROCESSOR HALTED

1. On the Problem Report (a sample of the form is printed in Appendix H), record any known system activity prior to the time of the halt. Also, note any anomalous circumstances that precede the halt. Be as specific and comprehensive as possible.
2. Record the contents of all I/O processor registers on the Problem Report.
3. Halt the main processor. (For HP 2100 processors only, when the front panel lights labeled IND or EXECUTE are on, press the HALT button repeatedly until the FETCH light comes on. If it does not light, note the fact on the Problem Report.) Record the contents of all main processor registers on the Problem Report. Do not disturb any register settings. Press RUN.
4. On the I/O processor, select the P-register and clear the display. Set bit 10 (002000₈). For HP 21MX processors, press PRESET, STORE, and RUN. For 2100 processors, press INTERNAL PRESET, EXTERNAL PRESET, and RUN.
5. On the system console, type SLEEP. If the sleep is successful, the system prints SYSTEM DUMP OR RELOAD? Respond No or a carriage return and the main processor halts with 102077₈ displayed. If the sleep is unsuccessful, wait at least one minute for each logged on port and then halt the main processor. Record all the registers of both processors on the Problem Report.
6. Whether or not the sleep was successful, perform a cold dump as described later.
7. Reload the I/O processor program from the master tape or from the separate tape. (Refer to Section IV.)
8. If the sleep was successful, use the BMDL to restart the system. If the sleep was unsuccessful, attempt a warmstart.
9. Submit a copy of the system console log, the I/O processor memory map, and the Problem Report along with the cold dump tape to your local HP representative.

MAIN PROCESSOR HALTED

1. On the Problem Report, record system activity prior to the time of the halt. Also, note any anomalous circumstances that preceded the halt. Please be as specific and comprehensive as possible.
2. Record the contents of all main processor registers on the Problem Report. Do not disturb any register settings.
3. Halt the I/O processor. (For HP 2100 processors only, when the front panel lights labeled IND or EXECUTE are on, press the HALT button repeatedly until the FETCH light comes on. If it does not light, note the fact on the Problem Report.) Record the contents of all I/O processor registers on the Problem Report. Do not disturb any register settings.
4. On the I/O processor, select the P-register and clear the display. Set bit 10 (002000₈). For HP 21MX processors, press PRESET, STORE, and RUN. For 2100 processors, press INTERNAL PRESET, EXTERNAL PRESET, and RUN.
5. Perform a cold dump as described later.
6. Reload the I/O processor from the master tape or from a stand-alone copy. (Refer to Section IV.)
7. Follow the warmstart procedure.
8. Submit a copy of the system console log, the I/O processor memory map, and the Problem Report along with the cold dump tape to your local HP representative.

BOTH PROCESSORS HALTED

1. On the Problem Report record system activity prior to the time of the halt. Also, note any anomalous circumstances that preceded the halt. Please be as specific and comprehensive as possible.
2. Record the contents of all main processor registers on the Problem Report.
3. Record the contents of all I/O processor registers on the Problem Report.
4. On the I/O processor, select the P-register and clear the display. Set bit 10 (002000₈). For HP 21MX processors, press PRESET, STORE, and RUN. For 2100 processors, press INTERNAL PRESET, EXTERNAL PRESET, and RUN.
5. Perform a cold dump as described later.
6. Reload the I/O processor from the master tape or from a stand-alone copy. (Refer to Section IV.)
7. Follow the warmstart procedure.
8. Submit a copy of the system console log, the I/O processor memory map, and the Problem Report along with the cold dump tape to your local HP representative.

NEITHER PROCESSOR HALTED—DEVICES DO NOT RESPOND

1. Wait at least five minutes before performing any action because certain automatic recovery procedures could take that long to complete.
2. If the system console responds to the ROSTER command (**don't try any others!**), perform these steps:
 - a. Halt the I/O processor. Record the contents of all I/O processor registers on the Problem Report.
 - b. On the I/O processor, select the P-register and clear the display. Set bit 10 (002000₈). For HP 21MX processors, press PRESET, STORE, and RUN. For 2100 processors, press INTERNAL PRESET, EXTERNAL PRESET, and RUN.
 - c. On the system console, type SLEEP. If the sleep is successful, the system prints SYSTEM DUMP OR RELOAD? Respond NO or a carriage return and the main processor halts with 102077₈ displayed. If the sleep is unsuccessful, wait at least one minute for each logged on port and then halt the main processor. Record all the registers on the Problem Report and then perform a cold dump as described later.
 - d. Reload the I/O processor program from the master tape or from a separate tape. (Refer to Section IV.)
 - e. If the sleep was successful, use the BMDL or the master tape to restart the system from disc.
 - f. If the sleep was unsuccessful, follow the warmstart procedure.
3. If the system console does not respond to the ROSTER command, perform these steps:
 - a. Halt the main processor and record all registers on the Problem Report.
 - b. Halt the I/O processor and record all registers on the Problem Report.
 - c. On the I/O processor, select the P-register and clear the display. Set bit 10 (002000₈). For HP 21MX processors, press PRESET, STORE, and RUN. For 2100 processors, press EXTERNAL PRESET, INTERNAL PRESET, and RUN.
 - d. Perform a cold dump as described later.
 - e. Reload the I/O processor from the master tape or from a stand-alone copy. (Refer to Section IV.)
 - f. Follow the warmstart procedure.
4. Submit a copy of the system console log, the I/O processor memory map, and the Problem Report along with the cold dump tape to your local HP representative.

DIAGNOSTIC ERROR MESSAGES

If the system experiences addressing problems, it sometimes prints one or more messages on the system console and then halts. These diagnostic messages pinpoint the problem to facilitate system recovery. They are listed in Appendix B along with their meanings and recommended recovery procedures.

System Recovery

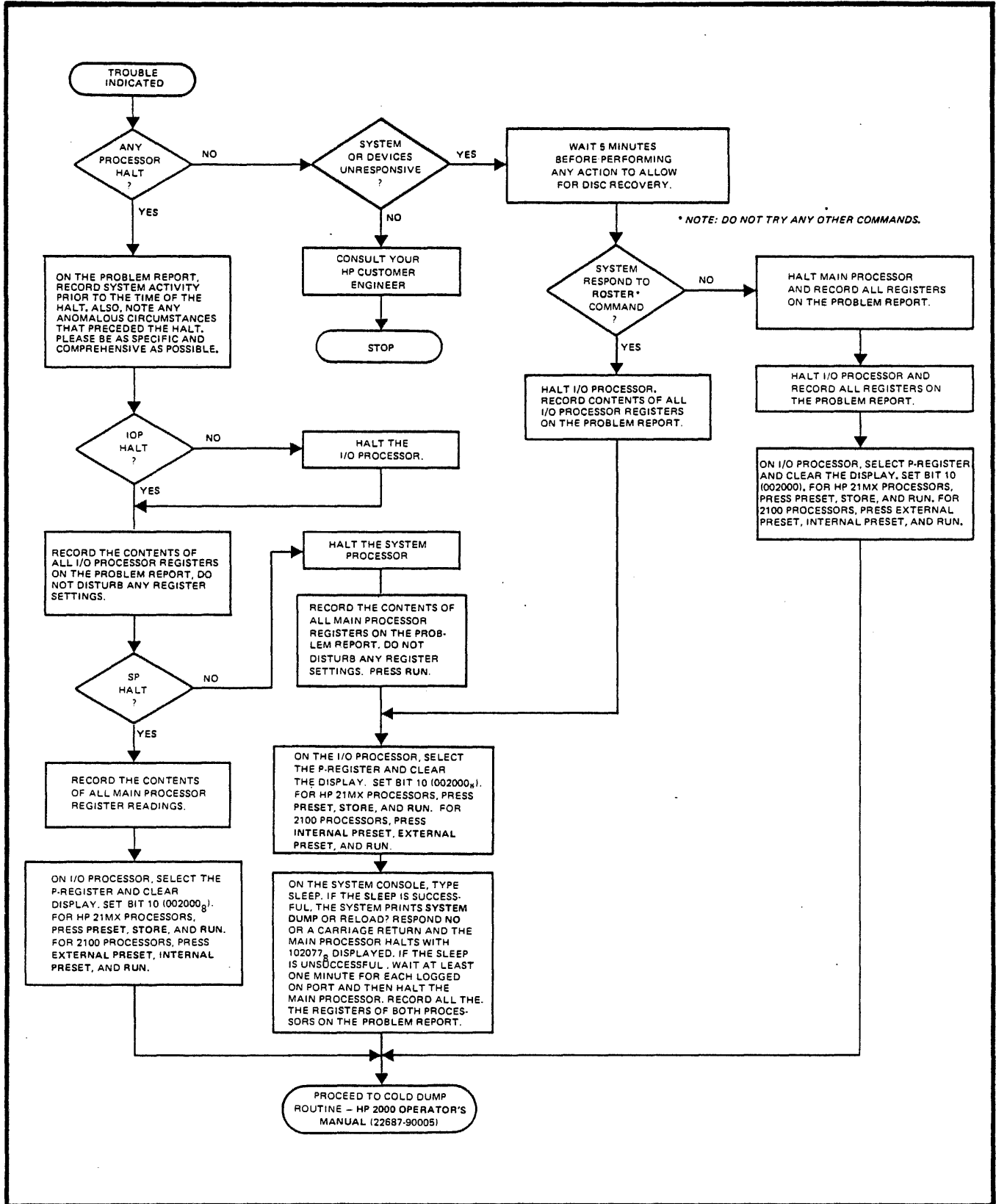

Figure 5-0. Pre-Cold Dump Procedure

COLD DUMP ROUTINE

The cold dump routine is a memory-resident program designed to assist in preserving information necessary to identify the cause of software failures. Correct usage minimizes system down-time because the routine captures essential data for subsequent off-line analysis. This feature allows recovery procedures to proceed in parallel with the fault diagnosis. Note that the cold dump routine generally is not useful for diagnosing hardware problems.

If software failures occur, it is important to record as much information as possible about the state of the system before the failure. A special report form provides space for data pertinent to the cold dump procedure; for example, register contents, time of failure, and anomalous circumstances preceding the failure. A sample Problem Report is included in Appendix H. Always fill out the report completely as part of the cold dump procedure.

If the system fails, halt codes may be displayed in the display register of the processors. In Appendix B, tables B-1 and B-2 list the halt codes, their meanings, and possible corrective action. When these halts require using the cold dump routine, follow the instructions below.

Note: A cold dump is not useful if either the main processor or I/O processor parity light is ON (indicating a parity error occurred). This is a hardware problem. Contact your HP customer engineer and then follow the recovery instructions listed in the previous section.

Before executing this procedure, be sure you have followed the appropriate procedure listed in the previous section.

1. Mount a reel of magnetic tape, with a write-enable ring installed, on the tape unit attached to the main processor. Note that a 600 foot reel is almost always long enough to capture a cold dump.
2. Select unit-0 on the tape drive being used for the cold dump. Press RESET, LOAD, and ON-LINE. If there are multiple drives, ensure only the one has unit-0 selected.
3. On the main processor, select the P-register and clear the display. Set bits 14 through 9 (077000₈). For HP 21MX processors only, press STORE. Press RUN.
4. The cold dump routine begins executing with results as follows:

Note An executing cold dump produces a "rocking" motion of the magnetic tape reels. This is to be expected and does not indicate a malfunction. The rocking motion normally continues for several minutes.

- a. If the cold dump successfully writes to the magnetic tape, the main processor halts with 102077₈ displayed and the I/O processor halts with 102061₈ displayed. After the tape rewinds, remove it and label with the appropriate identification. Be sure to label the tape with your business name and address so that it can be returned to you. Present the tape, the Problem Report, and a copy of the I/O processor memory map and system console log to your local HP representative.
- b. If the magnetic tape remains at load point (no activity) and the main processor halts, check for the following halt codes, and take corrective action:
 - 102033 Write not enabled. Remount the tape with a write-enable ring inserted and press RUN.
 - 102044 Magnetic tape unit off-line or not set to unit-0. Correct the condition and press RUN.
 If no halt appears, press HALT on the main processor only. Then refer to point d below.

- c. If the cold dump routine begins writing on the magnetic tape, but does not achieve a halt with 102077₈ displayed, check for the following halt codes and take corrective action:

102022 Logical disc-0 not ready. Correct this condition and press RUN.

102055 The magnetic tape is bad or too short. Replace the tape and press RUN. If the tape is too short, it should be submitted to your HP customer engineer along with the good cold dump tape.

- d. If the system does not halt, push HALT on the main processor. In case of a halt other than those described in points b and c, record the halt number. In either case, record the register values and then push RESET and REWIND on the tape drive. After rewind is complete, remove the magnetic tape and give it and the Problem Report to your HP representative.

Note: It is possible that a software failure can destroy the memory-resident portion of the cold dump routine. If this has happened, an attempt to run the routine may result in the symptoms stated in point d above.

- e. If the I/O processor does not achieve a halt 102061₈ and the reason for the cold dump was an I/O processor halt or a non-responsive system, then dismount the tape and record the contents of the I/O processor's registers on the Problem Report. If your system has a line printer, before reloading the system perform a stand-alone I/O processor memory dump (described later). Submit the cold dump tape, the Problem Report, and copies of the system console log, I/O processor memory dump and the I/O processor memory map to your local HP representative.

5. To restart your system following a cold dump, reload the I/O processor either from the master tape or from a stand-alone copy tape. Use the BMDL to restart from disc and perform a warmstart if the system prints the SYSTEM NOT SLEPT . . . message.

OBTAINING AN IOP MEMORY MAP LISTING

An IOP memory map records how your system is configured. After the configuration procedure the map was stored on the master tape or on the optional stand-alone IOP magnetic tape copy (if one was made). Your HP representative will need a copy of the map when diagnosing system problems.

In order to obtain a copy of the IOP memory map from the master tape or from a stand-alone copy, you must log on the system at a hardcopy terminal using an idcode with magnetic tape accessing capability. Mount the tape containing the configured IOP on the magnetic tape drive. Press RESET, LOAD, and ON-LINE. Then type a FILE command and the program illustrated in figure 5-1. When this program executes, it reads the memory map from magnetic tape and prints it on your terminal. If your system is configured with a line printer, you may use RUN*OUT=LP* to obtain a line printer listing of the map. Remember, however, that in order to use the RUN*OUT=LP* command the account you log on to must have line printer accessing capability. Also, you may have to create an ASCII file equated to the line printer (FIL-LP, LP).

```

FIL-MT,MT

10 FILES MT
20 DIM AS(255)
30 IF END #1 THEN 110
40 LINPUT #1;AS
50 IF AS(1,2)='10'10 THEN 90
60 PRINT #1;CTL(21)
70 GOTO 40
80 LINPUT #1;AS
90 PRINT AS
100 GOTO 80
110 END

RUN

```

Figure 5-1. A Program That Reads From Magnetic Tape

OBTAINING AN IOP MEMORY DUMP

Occasionally, the cold dump tape remains at load point because it is impossible to do a cold dump. If this happens, it is extremely helpful to HP representatives if you can supply a listing of a stand-alone IOP memory dump. This dump can be obtained only on systems having a line printer.

Following a cold dump failure, and before you restart the system, obtain an IOP dump using these instructions.

1. Halt the I/O processor if it is not already halted.
2. Select the P-register and clear the display. Set bits 10 and 0 (002001₈). For 21MX processors only, press STORE.
3. Select the A-register and clear the display. For 21MX processors only, press STORE.
4. Select the B-register and clear the display. Set bits according to the memory size of your I/O processor as follows:

memory	location	set bits
16K	037700	12 through 6
24K	057700	14, 12 through 6
32K	077700	14 through 6

On 21MX processors, press STORE.

5. Select the S-register and clear the display. Set bits 5 through 0 to the select code of your line printer. Set bit 15 if you are using an HP 2767 line printer; set bit 14 if it is an HP 2778.
6. For 21MX processors, press PRESET, STORE, and RUN. For 2100 processors, press EXTERNAL PRESET, INTERNAL PRESET, and RUN.
7. After the line printer finishes printing the dump, the I/O processor halts with 102000₈ displayed.

POWER FAILURES

During normal system operation, if electrical power fails completely or drops below the minimum required voltage, the system initiates an orderly power-down sequence. This includes issuing a System Disconnect command if the data communications facility is active at the time of the power failure.

CAUTION

DO NOT TOUCH THE COMPUTER FRONT PANEL SWITCHES at any time during power-down or power-up processing.

The processors remain in a halted condition until proper operating voltages are supplied to them. When power is restored, a restart routine automatically begins executing. In a few seconds or a few minutes the processors resume normal operation and the system restarts any mass storage transfers that were interrupted. Note however, that some I/O devices, modems, and data sets may become NOT READY and remain that way until you return them to the READY state. This is definitely the case for a 2762A system console. To enable the keyboard, you must press the ON-LINE button. The keyboard will be enabled when the READY light is lit.

After power is restored, the message POWER FAILURE—*hhmm* is sent to the system console. The parameter *hhmm* gives the hour and minute (in 24-hour clock format) when the power failed. This notification is important because power failures can last such a short time that they might otherwise go unnoticed. Thus, if you receive this message frequently, BEWARE. It warns of potential problems.

Depending on the type of processor, certain conditions must be met to effect a successful automatic restart. These conditions follow:

HP 21MX Processors

There are two conditions which will permit/prevent an automatic restart of the system after a power failure. These conditions are:

1. The Automatic Restart switch on the 21MX (at the rear of the central processor PCA) must have been set to the ARS position. If this switch is not set properly, there can be no automatic restart activity.
2. The 21MX battery automatically sustains the contents of memory upon power failure and line voltage drops. Only after the battery is drained does the main processor lose memory contents. Thus, a properly-connected and fully charged battery permits the automatic restart routine to execute.

HP 2100 Processors

The Automatic Restart switch on the I/O control board (A7) has two positions: ARS and ARS. This switch must be set to the ARS position for an automatic restart of the system to be performed.

For either a power failure or low line voltage, the panel lights remain out until proper power is restored.

POWER FAILURE DURING SHUTDOWN

If power fails during execution of a HIBERNATE or SLEEP command, a halt 103004_s occurs on the main processor when power is restored.

During a sleep procedure, if the message SYSTEM DUMP OR RELOAD? was printed or was in the process of being printed, system backup to disc was completed before the power failed and no special action is required. During a hibernate procedure, if you were requested to mount reel number 1 before the power failed, system backup to disc was completed and no special action is required. In both cases, you can reload the system from disc. If no message was begun, you should attempt to restart the system using the Warmstart Program.

If a hibernate was being performed when the power failed, you must reinitiate it in order to provide proper system backup. If a sleep to magnetic was being performed, we advise reinitiating the sleep to provide reliable system backup. Both of these actions involve restarting the system from disc using the BMDL and then re-entering the SLEEP or HIBERNATE command.

POWER FAILURE DURING STARTUP

A power failure during any type of startup causes a halt 103004_s when power is restored. The load procedure must be restarted from the beginning.

POWER FAILURE WHILE SYSTEM IS SHUT DOWN

The I/O processor is designed to operate continuously, whether or not the main processor is running. Shutting the power off after a normal system shutdown leaves the I/O processor program undisturbed. When power is restored, the IOP successfully performs its own power-up operation independent of the main processor.

DATA COMMUNICATIONS

SECTION

VI

This section presents an overview of data communications in an HP 2000 system environment, the operator commands you may use, and general operating procedures.

As system operator, you may support the data communications facility of your HP 2000 system. The facility provides data communications through:

- The Remote Job Entry (RJE) facility - which transmits jobs between an HP 2000 system and a remote host system. The HP 2000 emulates one of the following:
 - Multileaving RJE Workstation (MRJE W/S)
 - 2770/2780/3780 terminal
 - User 200 terminal
- 2000 to 2000 Communication - which transmits data between one HP 2000 system and another.
- 2780 to 2780 Communication - which transmits data between an HP 2000 system emulating a 2770, 2780 or 3780 terminal, and one of the following:
 - 2770, 2780 or 3780 terminal (with the same configurations as the Emulator)
 - another HP 2000 system running the 2770/2780/3780 Emulator
 - an HP 3000 system running the 2780/3780 Emulator
 - any other computer system emulating a 2770, 2780 or 3780 terminal (with the same configurations as the Emulator)

Table 6-1 lists the host computer operating systems that can be accessed by the RJE facility.

FACILITY REQUIREMENTS

Figure 6-1 presents a functional diagram of elements used for data communications. In order to use the RJE facility, 2000 to 2000 Communication facility, or 2780 to 2780 Communication facility, you must have:

- a minimum HP 2000 system.
- a synchronous data set interface, HP model 12618A.
- at least one modem compatible with both the 2000 and the remote system.

You may also configure optional additional peripheral equipment to enhance communication ability.

Systems are connected using modems and public telephone networks or leased private lines. Modems can be Bell Models 201A3, 201C, 208B or equivalent. Specifications for the modem models are given in Table 6-2. Communications to and from an HP 2000 system can occur at rates up to 9600 bits per second (approximately 960 characters per second).

Table 6-1. Host Operating Systems Compatible with RJE Facility

RJE EMULATOR	HOST SYSTEMS
Multileaving RJE Workstation	IBM 360/370 OS/MFT/HASP OS/MVT/HASP OS/MVT/HASP OS/VS1/JES/RES OS/VS2/JES2 OS/VS2/JES3
2770/2780/3780 Terminal	Any host system that supports a 2770, 2780 or 3780 terminal, as long as the host system is compatible with the exact terminal configurations emulated. (Refer to Table 6-16.)
User 200 Terminal	CDC 3300/6400/6600/Cyber 70 KRONOS/EXPORT/IMPORT SCOPE/INTERCOM

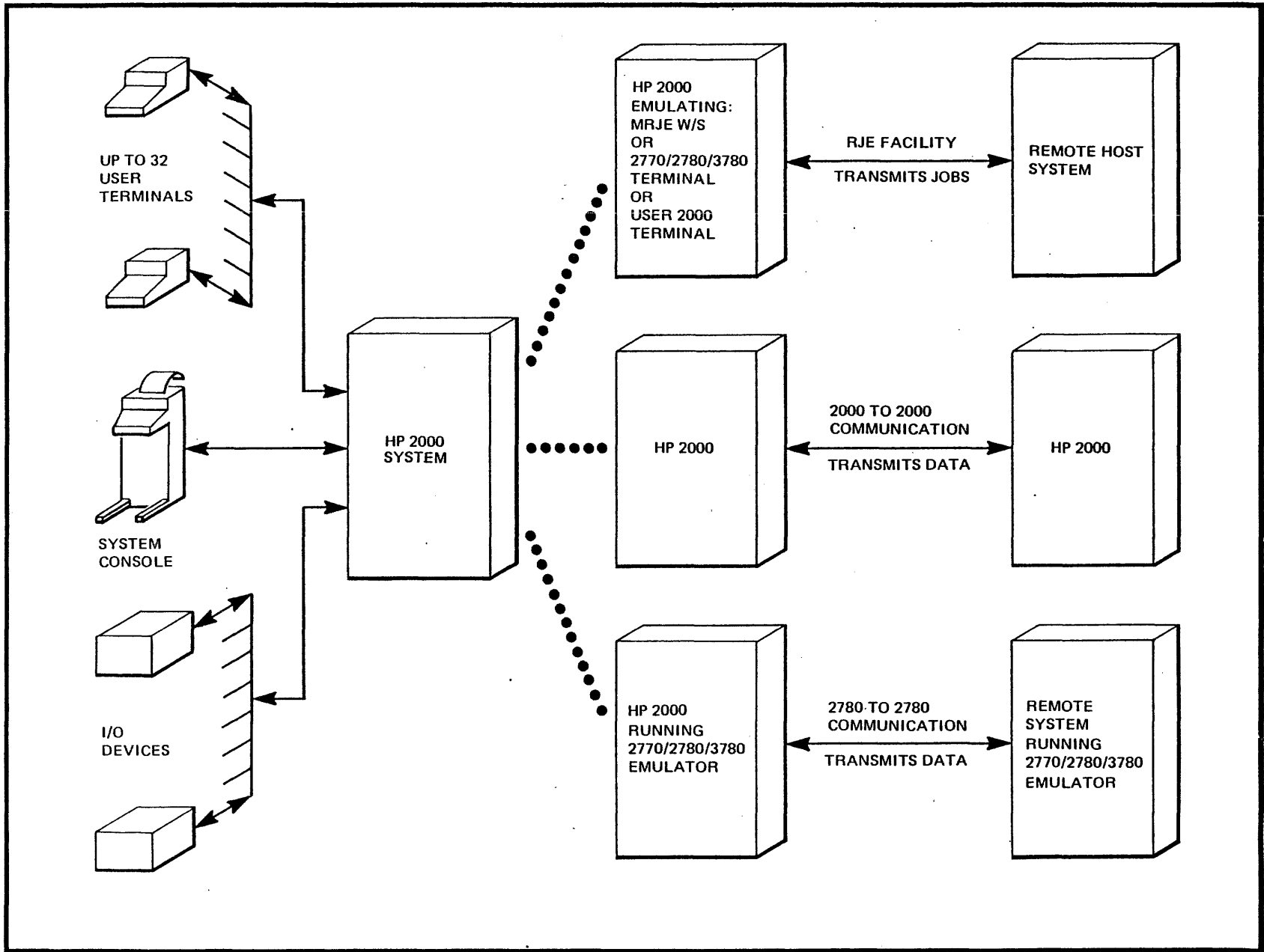

Figure 6-1. Elements of an HP 2000 Data Communications Facility

Table 6-2. HP 2000 Modem Specifications for Data Communications

MODEL	OPTIONS
Bell 201A3	EIA Interface With Alternate Voice Without New Sync Half Duplex
Bell 201C	New Sync not used Internal Transmitter Timing Automatic Answer (if the 2000 system serves as host) EIA Interface Use with DAS 828-Type
Customer selects either two-wire switched network or two-wire non-switched private line.	
Bell 208B	Automatic Answer (if the 2000 system serves as host) Internal Transmitter Timing RS-CS Interval 50 ms No 801-type Auto Call Unit

REMOTE JOB ENTRY COMMUNICATIONS

Remote Job Entry is a system feature that allows you or a user to submit jobs for processing on a host computer. When sending jobs to a host system, the 2000 system acts like a remote terminal or input device for the host; when receiving output from jobs, the 2000 system acts like a terminal or output device for that system.

Programs contained in jobs may be written in any language available on the host system. Programs may be assembled, compiled, or executed on the host system. The programs can retrieve data files from the host system and send them back to the 2000 system. The results of processing can be routed to peripheral devices associated with the host system, or returned to the local 2000 system for further processing, storage, or output.

When the Remote Job Entry facility is used with an IBM host system listed in Table 6-1 it emulates a Multi-leaving Remote Job Entry (MRJE) Workstation. An MRJE Workstation is a remote batch input/output port operating under the multileaving protocol. The remote port uses several data streams or functional lines (known as host functions) for simultaneous input, output, and control communication. Table 6-3 lists these host functions. There are seven host reader functions for accepting input; seven host lister functions for producing output; seven host punch functions for producing punched output; a host inquiry function for entering system requests or commands, and a host message function for receiving responses to system commands and messages.

Table 6-3. Host Functions for MRJE Workstations

<u>For Job and System Control</u>	
HI	Host inquiry, used when sending commands to the host system.
HM	Host message, used when receiving messages from the host system.
<u>For Jobs</u> (Available number of each is dependent upon the host system.)	
HR1-7	Host reader function (normally a card or paper tape reader), used for card-image job input. There can be a maximum of seven host readers.
HL1-7	Host lister function (normally a line printer), used for line-image job output. There can be a maximum of seven host listers.
HP1-7	Host punch function (normally a card reader/punch/interpreter or paper tape punch), used for card-image job output. There can be a maximum of seven host punches.

When the RJE facility is used with a host system that supports IBM 2770, 2780 or 3780 terminals, it emulates one of these terminals. The 2770/2780/3780 emulator is similar to the MRJE Workstation described previously, but uses only one host reader and one host lister. There are no host inquiry functions, host message functions, or host punch functions.

If the host system is an IBM operating system, and a choice exists between emulating an MRJE Workstation and a 2770, 2780 or 3780 terminal, the MRJE Workstation provides a more efficient choice.

When the RJE facility is used with one of the CDC host systems listed in Table 6-1, it emulates a CDC 200 User Terminal. The CDC 200 User Terminal is similar to the MRJE Workstation described previously but uses only one host reader, one host lister, one host inquiry, and one host message function. CDC does not provide a host punch function.

Remote Job Entry allows you, the operator, to use the system console, non-sharable I/O devices, and ASCII job function designators (JFD's) to communicate with a host. At system configuration you assign each host function (HR, HL, and HP) to a non-sharable I/O device or to an ASCII job function designator. Job function designators are listed in table 6-4. You might think of designators as buffers that serve as virtual non-sharable devices. They can be accessed by users as though they were physical I/O devices.

Assigning host functions to job functions allows you to configure the RJE facility with any mixture of the following devices equated to the available host functions.

- card readers
- card reader/punch/interpreter units
- line printers
- paper tape readers
- paper tape punches
- ASCII job function designators

Initial host function assignments are made during I/O processor configuration and can be changed during system operation via the RJE-DA command (Device Assignment command). This command causes a data stream to be switched either to a physical device or to an ASCII job function designator (illustrated in figure 6-2). Switching can be done only when the affected function is not in use or, for host lister or host punch functions, when no output is pending.

Table 6-4. HP 2000 ASCII Job Function Designators

<u>For Job and Stream Control</u>	
JIO	Job inquiry (write only), allows users to access the host inquiry function from an executing program.
JM0	Job message (read only), allows users to access the host message function from an executing program.
<u>For Jobs</u>	
JT0-JT6	Job transmitter (write only), allows users to access a host reader function from an executing program. There can be a maximum of seven job transmitter functions.
JL0-JL6	Job lister (read only), allows users to access a host lister function from an executing program. There can be a maximum of seven job lister functions.
JP0-JP6	Job punch (read only), allows users to access a host punch function from an executing program. There can be a maximum of seven job punch functions.

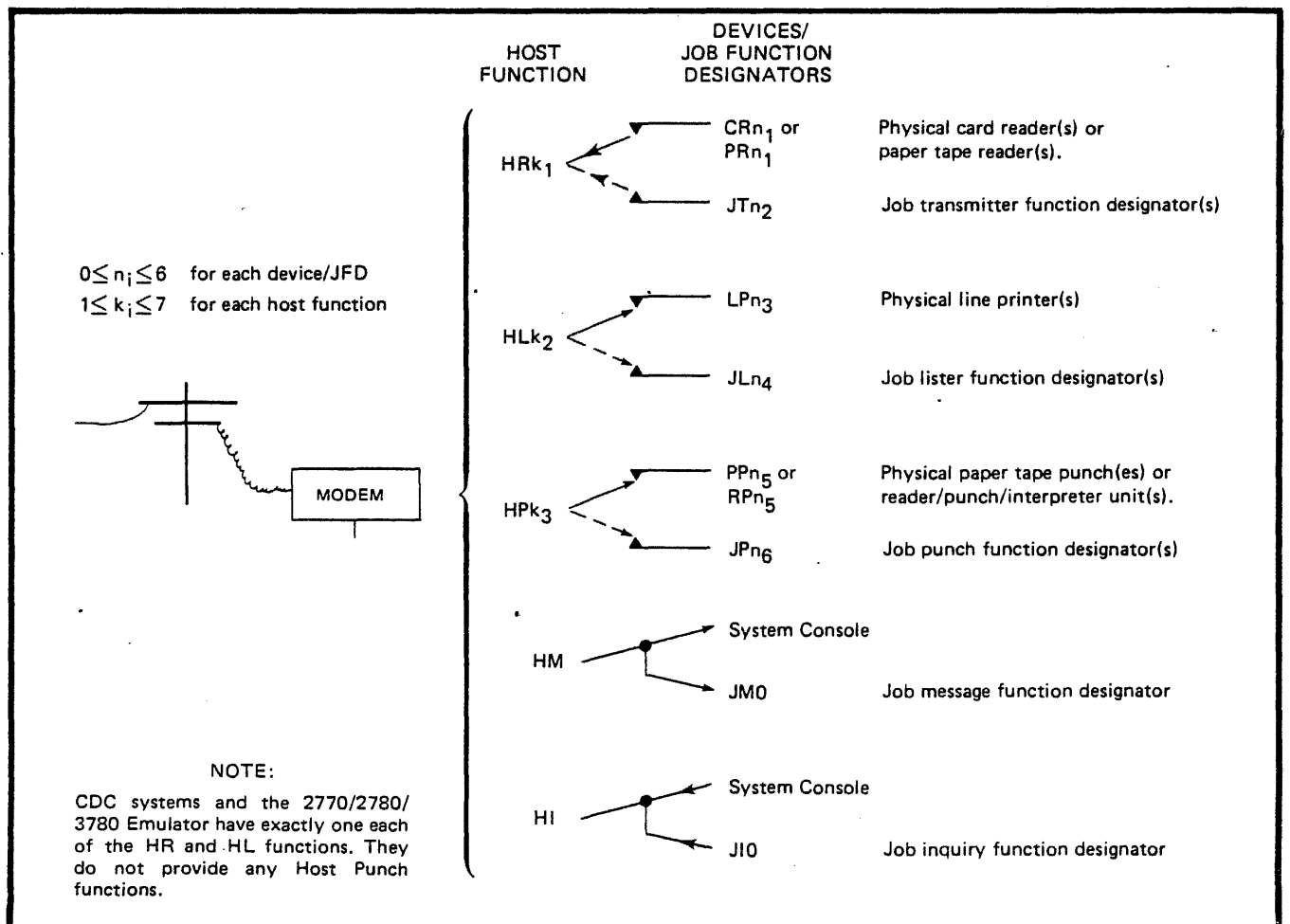

Figure 6-2. Host Function Organization

Table 6-5. A Summary of RJE Operator Commands

COMMAND	DESCRIPTION
RJE- $\left\{ \begin{array}{l} \text{SC} \\ \text{SCA} \end{array} \right\} \left\{ \begin{array}{l} ,n \\ ,n,m \\ ,,m \end{array} \right\}$	System Connect. This command links the 2000 system with the host system. SCA requests automatic restart after disconnect. <i>n</i> and <i>m</i> are determined by host system personnel.
RJE-DA, $hf \left\{ \begin{array}{l} < \\ > \end{array} \right\}$ device	Device Assignment. This command assigns specific system non-sharable devices or ASCII job function designators to host functions (data streams). When used without function or device parameters, this command generates a listing of the current device assignments.
RJE-SR <i>n</i>	Start Reader. This command is used to activate a reader associated with host reader function <i>n</i> (HR <i>n</i>).
RJE-TR <i>n</i>	Terminate Reader. This command is used to stop a reader associated with host reader function <i>n</i> (HR <i>n</i>).
RJE-RR <i>n</i>	Restart Reader. This command restarts a reader associated with host reader stopped due to a data error.
RJE-[RC,] <i>m</i>	Remote Command. This RJE command sends a command to the host system. The host system command is contained in <i>m</i> . Host commands (the <i>m</i> parameter) can also be sent from a user program via the job inquiry function (J10). RC is optional so long as the first two characters of the message are not SC, DA, SR, RR, TR, ER, SD, LO, or TP.
RJE-ER [,R]	Error Report. This command is used to obtain a listing of communication errors detected during operation of the RJE facility. When the optional R parameter is used, the current error counts are reset to 0 following the report.
RJE-SD [, <i>m</i>]	System Disconnect. This command ends an RJE session by terminating the communications link with the host system. The optional <i>m</i> parameter is a signoff message for IBM-MRJE/WS. With CDC host systems, <i>m</i> is not allowed. SD also terminates automatic retries if SCA is in effect.
RJE-LO	Load (for CDC use only). This command simulates the LOAD key on a hardware CDC 200 User Terminal. Proper use of this command depends on the specific host system. In general it is used to restart a job transmitter (card reader or JT <i>n</i>) which the host deactivated due to incorrect data.
RJE-TP1	Terminate Printer (for CDC use only). This command forcibly removes control of the printer from RJE. It is used only when the host is no longer sending output and the operator wants to allow use of the printer by time-sharing users.

Table 6-5. A Summary of RJE Operator Commands (Continued)

COMMAND	DESCRIPTION
RJE-RX	Read Transparent (for 2770/2780/3780 Emulator only). This command indicates transparent transmission for a real peripheral (such as a card reader). It is used before readying the device with input and prevails until the device goes to end-of-file.
RJE-TP	Transfer to Printer (for 2770/2780/3780 Emulator only). This command transfers output from the console to the line printer. It is used whenever output is to be redirected to the line printer.

RJE OPERATOR COMMANDS

A Remote Job Entry facility accepts the RJE commands summarized in table 6-5. These commands, along with their error messages and examples, are explained in the following paragraphs. Note that all commands and related responses begin with RJE. This visually separates RJE activity from timesharing activity.

If you enter an RJE command but it cannot be interpreted as one of the legal commands listed, the error message RJE COMMAND ERROR is printed on the system console. Also, some commands are inappropriate if entered while the RJE facility is not connected to a host system. When this occurs, the general message RJE COMMAND NOT APPROPRIATE is printed.

At all times while the RJE facility is activated you should be available to perform such tasks as loading forms, removing printer listings, and responding to error messages.

SYSTEM CONNECT COMMAND

This command is used to connect an HP 2000 System to a host system.

$$RJE-\left\{ \begin{array}{l} SCA \\ SC \end{array} \right\} \left\{ \begin{array}{l} ,n \\ ,n,m \\ ,m \end{array} \right\}$$

SCA requests the 2000 system be connected to the host with automatic restart enabled. When SCA is in effect, the system attempts to reestablish communications after a disconnection occurs. This feature is especially useful in a leased line environment because systems which are 'permanently' connected to a host do not require your assistance if the connection is broken by the host or other outside agents. With systems using modems, SCA makes the system always ready for a dial-up attempt.

SC requests the 2000 system be connected to the host without Automatic restart.

For IBM host systems supporting MRJE workstations:

- n* is a decimal number designating the maximum number of characters to be transferred to or from the host system. Host system personnel determine this number and generally refer to it as the teleprocessing or multileaving buffer size. *n* must always be in the range 100 to 2000. *n* is a positional parameter.
- m* is a signon message and optional password defined by host system personnel. When entering the command, you may type T^c followed by a two-digit integer (09-80) to specify the column where the message or password begins. For example, type
- ```
RJE-SC,/*SIGNONTc16REMOTE18Tc73PASSWORD
```
- to place REMOTE18 in columns 16 through 23 and PASSWORD in columns 73 through 80. Because control characters do not print, the line you type actually looks like the first example on page 6-8.

For host systems supporting 2770/2780/3780 terminals:

- n* specifies the terminal to be emulated (must be 2770, 2780 or 3780). You may specify ASCII code with the letter A following the terminal number. Otherwise, EBCDIC is assumed. For example,

```
RJE-SC,2780A
```

requests 2780 emulation using ASCII as the communications code.

- m* allows specification of a single card image which will be transmitted to the host after successful communications have been established with the host. *m* may be used as a signon message. When entering the command you may type T<sup>c</sup> followed by a two-digit integer (09-80) to specify the column where the next character begins. For example, type

```
RJE-SC,/*SIGNONTc16REMOTE31
```

to place REMOTE31 in column 16 of the signon card.

The signon message remains in effect during subsequent system connections, but can be returned to a null value by entering a new SC command. Refer to the default values listed below.

For CDC host systems:

- n* is an octal number designating the site address. Host system personnel determine this number (always within the range 160 to 177). *n* is a positional parameter.
- m* is one of the following transmission codes: ASCII, IBCD, or BCD.

Following any loading of the I/O processor, *n* and *m* will have the initial default values shown below. Thereafter, the default values are set to the last values used.

| RJE Emulator            | Initial Default Value<br>for <i>n</i> | Initial Default Value<br>for <i>m</i> |
|-------------------------|---------------------------------------|---------------------------------------|
| MRJE Workstation        | 400                                   | /*SIGNON REMOTE1<br>7 spaces          |
| 2770/2780/3780 Emulator | 2780 EBCDIC                           | null                                  |
| CDC                     | 160                                   | BCD                                   |

## EXAMPLES

```
RJE-SC,/*SIGNON16REMOTE1873PASSWORD
RJE-SCA
RJE-SC,200,/*SIGNON REMOTE1860PASSWORD
```

After entering this command, you may receive the message RJE SYSTEM ALREADY CONNECTED. This message indicates that a previous RJE connection is still in effect. You may accept this existing connection or force a disconnection (using RJE-SD) and then reenter the System Connect command.

Normally the system prints RJE SYSTEM READY and you can proceed to ready the communication line. This typically involves dialing the host system telephone number on a modem, waiting for an answer, and then placing the modem in data mode. If a dedicated or leased line is being used, no action is normally required to ready the line. If it is possible for the host system to call its remote stations and the modem being used has an auto-answer capability, you may ready the communications line by enabling the auto-answer function on the modem. When the host system calls, the RJE function then continues automatically.

As soon as the host system accepts the signon message, the message RJE COMMUNICATIONS ESTABLISHED is printed on the system console. At this point the RJE facility is available for use.

## DEVICE ASSIGNMENT COMMAND

A data source or destination device must be associated with each host reader (HR), lister (HL), and punch (HP) function that is configured on the system. Initial device assignments are made when the system is configured. However, you may use the Device Assignment command to change an assignment.

The physical I/O devices and ASCII job file designators you can assign to host functions are designated as follows:

```
CR n card reader
RP n card reader/punch/interpreter
LP n line printer
PR n paper tape reader
PP n paper tape punch
JT n job transmitter
JL n job lister
JP n job punch
```

where  $n$  can be a value 0 through 6.

Similarly, the individual host functions are designated as follows:



HR $n$  host reader function  
 HL $n$  host lister function  
 HP $n$  host punch function

where  $n$  can be a value 1 through 7.

When you enter a Device Assignment command, an association is made between one of the devices or ASCII JFD's and one of the host functions. Some assignments would not make sense, for example, a card reader with a printer function. Therefore, in order to assist you in making proper assignments, an arrow (<or>) is included in the command to show data flow direction. The general forms of the command follow:

$$\text{RJE-} \left\{ \begin{array}{l} \text{DA,function} < \text{device} \\ \text{DA,function} > \text{device} \\ \text{DA} \end{array} \right\}$$

**function** is one of the host functions (for instance, HR1).

**device** is one of the available I/O devices (for instance, CR0), or it is one of the ASCII job file designators (for instance, JL2).

The first of the general forms shown is used to assign devices to the host reader function. The arrow indicates flow of data from the device to the host. The second of the general forms shown is used to assign devices to the host lister or punch functions. Again the arrow indicates the flow of data, this time from the host to the device or ASCII JFD. The last of the general forms shown is used to produce a listing of all current device assignments. Responses will be of the forms:

RJE *function* < *device*  
 RJE *function* > *device*

Assignments can only be made when neither the affected host function nor the affected device or Job Function Designator is in use. The new assignment will have no effect until the host function becomes in use. For a host reader function, it and its assigned device or JFD becomes "in use" when you enter a System Connect or Start Reader command. Use ends when you enter a Terminate Reader or System Disconnect command and the designated host reader function completes transmission of any current job text. For a host lister or punch function, it and its assigned device or JFD become "in use" when data is received from the host. "Use" continues so long as output is pending and ends when output is complete. For CDC host systems, it may be necessary for the operator to use the TP1 command to inform the 2000 System that the host is no longer using the device (although in general this should not be the case).

## START READER COMMAND

An I/O device or ASCII job function designator assigned to host reader function number  $n$  is referred to as reader  $n$ . To activate the reader, use the following command.

**RJE-SR $n$** 

$n$  is the number of a specific host reader function.

If the reader is, or can be, assigned to the RJE function, the message RJE READER $n$  AVAILABLE is printed on the system console.

If the reader is active with some other function, the message RJE READER $n$  NOT AVAILABLE is printed.

Note that a Start Reader command is generated automatically when the host system accepts the signon message. After the reader is activated, it operates in a "hot" mode. That is, it remains active (ready to read). You need only to place cards in the input hopper and start the device for the data to be read. No other intervention is necessary unless errors occur.

Some host operating systems that support the IBM 2770/2780/3780 terminals (such as DOS/POWER) frequently interrupt transmissions from the Emulator to the host in order to reverse the flow from the host to the Emulator. If such interruptions occur, the Emulator automatically reinstates its reading operation and transmission at the next opportunity.

Two types of problems may occur at the card reader which require your attention. One type includes the normal physical errors such as card jams and failure to terminate the data with an EOF card. The second type of problem is detection of illegal hole punch combinations in cards.

When the first type of problem occurs, you receive the message RJE READER $n$  ATTENTION REQUIRED (bell). A typical situation occurs when users omit the 2000 End-of-File card from their input decks. (These cards contain colons (:)) in columns one and two.) With HP 2892 card readers, to correct the problem, push the END OF FILE button and the system assumes an EOF card when the hopper is empty. With other card readers you must punch an EOF card and place it in the reader. Note that the system ignores an EOF card at any point other than the last card in the input hopper.

The second type of problem occurs when the system detects an illegal hole punch combination in cards. For IBM, 256 valid EBCDIC codes can be read and transmitted to the host system. For CDC, the set of valid hole punch combinations depends upon the transmission code in use (BCD, IBCD, or ASCII). If illegal characters are detected, the reader halts and prints RJE READER $n$  DATA ERROR (bell). The card with the error is the last card in the output stacker. You may correct the card and replace it in the input hopper, or you may ignore it. In either case, you must use the Restart Reader command to continue reading the cards in the input hopper.

## RESTART READER COMMAND

This command is used to restart a card reader after it has halted due to an illegal punch in a card.

**RJE-RR $n$** 

$n$  is the number of a specific host reader function.

The Restart Reader command will not be accepted unless the RJE function is connected to a host. Entering the command when RJE is not connected causes the message RJE COMMAND NOT APPROPRIATE to be printed.

## TERMINATE READER COMMAND

To detach the host reader function from the RJE function, issue the following command.

**RJE-TR $n$**

$n$  is the number of a specific host reader function.

As soon as the reader finishes reading any remaining data, the message RJE READER $n$  NOT AVAILABLE is printed on the system console.

A Terminate Reader command is generated automatically when a system disconnect is performed.

## REMOTE COMMAND

Host systems generally have available a set of commands and inquiries which you may use. Host commands, inquiries, and messages to the host operator can be entered on the system console using the Remote Command instruction described next.

**RJE-[RC,] $m$**

**RC** stands for Remote Command. Must be included if the first two characters of the host's command ( $m$ ) correspond to some RJE command (for example, SC, SD, ER, TR, SR, RR, LO, or TP). If RC is included in command when using the 2770/2780/3780 Emulator, the output from the host is directed to the host list function; if RC is *not* included, the output is directed to the console.

$m$  is a string of characters making up one of the legal host system commands or inquiries.

The Remote Command will not be accepted unless the RJE facility is connected to a host system. If you enter the command but the RJE facility is not connected, the message RJE COMMAND NOT APPROPRIATE is printed on the console.

It is possible for users to transmit host commands programmatically via the job inquiry function (JI0). These commands will also be printed at the system console. However, the message at the console is preceded by RJE to provide a visual reminder that the command was sent by a user. For example, if the command XXX were entered at a user terminal, RJE\* RC,XXX would be printed on the system console.

In order to use the RJE Remote Command you must be familiar with commands available to the host system operator. Tables 6-6 through 6-8 summarize commands used for remote control on the IBM and CDC systems. Consult the appropriate host system reference manuals for commands used with the 2770/2780/3780 Emulator.

### EXAMPLES:

RJE-RC,\$DQ

RJE-\$DQ

The examples are equivalent. They request the host IBM system to display the number of jobs in each queue.

Table 6-6. Summary of IBM 360 HASP Remote Commands

| COMMAND                             | COMMENTS                                                                                                                    |
|-------------------------------------|-----------------------------------------------------------------------------------------------------------------------------|
| \$DA                                | Display status of active jobs                                                                                               |
| \$DF                                | Display information on jobs queued for printing with special forms                                                          |
| \$DN                                | Display names and status of all jobs                                                                                        |
| \$DQ                                | Display number of jobs in each queue type                                                                                   |
| \$C <i>Jn</i> or \$C' <i>name</i> ' | Cancel job with job number <i>n</i> or job with job name ' <i>name</i> '                                                    |
| \$D <i>Jn</i> or \$D' <i>name</i> ' | Display status of job with job number <i>n</i> or with job name ' <i>name</i> '                                             |
| \$P <i>Jn</i> or \$P' <i>name</i> ' | Cancel specified job after completion of current activity                                                                   |
| \$B <i>device</i>                   | Backspace <i>device</i>                                                                                                     |
| \$C <i>device</i>                   | Cancel current function on <i>device</i>                                                                                    |
| \$E <i>device</i>                   | Restart current function on <i>device</i>                                                                                   |
| \$F <i>device</i>                   | Forward space <i>device</i>                                                                                                 |
| \$I <i>device</i>                   | Interrupt current function on <i>device</i>                                                                                 |
| \$N <i>device</i>                   | Repeat current function on <i>device</i>                                                                                    |
| \$P <i>device</i>                   | Stop <i>device</i> after completion of the current function                                                                 |
| \$S <i>device</i>                   | Start <i>device</i>                                                                                                         |
| \$T <i>device</i>                   | Set device parameters (to indicate such things as type of forms loaded in a printer, or type of print character set in use) |
| \$Z <i>device</i>                   | Halt <i>device</i> immediately                                                                                              |

Table 6-7. Summary of Some IBM ASP Remote Commands

| COMMAND                              | COMMENTS                                                                               |
|--------------------------------------|----------------------------------------------------------------------------------------|
| X, <i>name</i> [, <i>message</i> ]   | Specifies to ASP system the name of the support program to be scheduled for execution. |
| C, <i>name</i>                       | Terminates currently active support function                                           |
| I,A                                  | Displays active jobs                                                                   |
| I,B                                  | Displays backlogged jobs                                                               |
| I,D                                  | Displays disposition of I/O devices                                                    |
| I,J= <i>job name</i>                 | Displays information about specific jobs                                               |
| I,J= <i>job number</i>               | Displays information about specific jobs                                               |
| Z, <i>console name</i> , <i>text</i> | Sends text message to another console                                                  |

Table 6-8. Summary of CDC EXPORT/IMPORT Remote Commands

| COMMAND | COMMENTS                                                                                               |
|---------|--------------------------------------------------------------------------------------------------------|
| ON      | Turns equipment logically on. Card readers are initially on, and output devices are initially off.     |
| OFF     | Turns equipment logically off.                                                                         |
| DEFINE  | Specifies the various attributes of an output device (print train, forms code, etc.).                  |
| WAIT    | Temporarily halts reading or printing.                                                                 |
| GO      | Resumes operation after a WAIT command.                                                                |
| BSP     | Backspaces a print file a specified number of sectors.                                                 |
| END     | Terminates current operations on the specified equipment.                                              |
| REP     | Used to specify the number of additional copies of the file in process to be printed.                  |
| REW     | Rewinds the print file in progress and turns the equipment logically off.                              |
| RTN     | Returns a print file to the appropriate queue with its present priority or a newly specified priority. |
| SUP     | Suppresses the spacing of a print file so that the remainder of the file is single spaced.             |
| DIVERT  | Allows the user to divert output files of a remote job to the central site or another terminal.        |
| DROP    | Allows a user to drop a job which is currently in execution.                                           |
| EVICT   | Allows a user to eliminate a job from the input and/or output queues.                                  |
| KILL    | Allows a user to kill a job which is currently in execution.                                           |
| PRIOR   | Allows a user to change the priority of a file in the output queue.                                    |
| REVERT  | Cancels the effect of a DIVERT                                                                         |
| H       | Displays the contents of the terminal's input and output queues.                                       |

## SYSTEM DISCONNECT COMMAND

Use the System Disconnect command to terminate an RJE session or to disable the automatic restart feature.

### RJE-SD [*m*]

*m* is an optional signoff message and/or password defined by host system personnel. As with the System Connect Command, the T<sup>c</sup> convention may be used to specify the column where the message and/or password begin. The default message for IBM systems is /\*SIGNOFF. The *m* parameter is not used for CDC systems.

As soon as current printing or card transmission is complete, the message RJE SYSTEM DISCONNECT (TYPE *n*) is printed on the system console. The *n* in the disconnect message indicates the type of disconnection that occurred. Note, this message will be printed if the RJE facility is disconnected for any reason. The types of disconnections possible are listed in table 6-9.

Table 6-9. RJE System Disconnect Codes

| <i>n</i> | IBM HOST SYSTEMS                                           | CDC HOST SYSTEMS                                                   |
|----------|------------------------------------------------------------|--------------------------------------------------------------------|
| 0        | Normal disconnection by the operator                       | Normal disconnection by the operator                               |
| 1        | Excessive errors (time outs or data checks)                | Line break or other failure in the communications equipment        |
| 2        | Line loss or other failure in the communications equipment | Apparent host failure (no reception from the host for two minutes) |
| 3        | Host system disconnect                                     | Power failure                                                      |
| 4        | Excessive buffer overruns or sequence errors *             |                                                                    |
| 5        | Power failure                                              |                                                                    |

\*Excessive buffer overruns or sequence errors, while connected to a host IBM system, can be caused by improperly specifying the *n* parameter (buffer length) in the System Connect command. When using the 2770/2780/3780 Emulator, this condition may occur if the host system assumes a 512 character buffer for the 2770, since the Emulator only supports a 256 character buffer for the 2770.

## ERROR REPORT COMMAND

To aid in checking the quality of your communications link with the host system, you can request a list of communications errors using the following command.

### RJE-ER [*R*]

*R* is an optional parameter. When it is included, the current error counts are reset to 0 following the report.

The Error Report command generates a list of several possible communication error types. The error formats for IBM are given in table 6-10, those for CDC are given in table 6-11. The *n* in the error report is the number of errors detected for each error type.

Table 6-10. MRJE and 2770/2780/3780 Emulator Communication Error Report Items

|                   |                                                                                                                                   |
|-------------------|-----------------------------------------------------------------------------------------------------------------------------------|
|                   | RJE <i>n</i> SEQUENCE ERRORS                                                                                                      |
|                   | RJE <i>n</i> RECEIVE OVERRUNS                                                                                                     |
|                   | RJE <i>n</i> TIME OUTS                                                                                                            |
|                   | RJE <i>n</i> NAKS                                                                                                                 |
|                   | RJE <i>n</i> DATA CHECKS                                                                                                          |
|                   | RJE <i>n</i> UNKNOWN RESPONSES                                                                                                    |
|                   | RJE <i>n</i> CARRIER LOSSES                                                                                                       |
| SEQUENCE ERRORS   | Data has been received out of sequence or has been lost.                                                                          |
| RECEIVE OVERRUNS  | More data was received than would fit in a buffer. This may be due to incorrect size specification in the System Connect Command. |
| TIME OUTS         | No data was received within the expected time interval.                                                                           |
| NAKS              | Negative acknowledgement from the host system indicating that it has detected a data error.                                       |
| DATA CHECKS       | The RJE facility detected an error in data received from the host.                                                                |
| UNKNOWN RESPONSES | An invalid character was received from the host system.                                                                           |
| CARRIER LOSSES    | The incoming data signal was lost before the entire message was received.                                                         |

Table 6-11. CDC Communication Error Report Items

|                             |                                                                                           |
|-----------------------------|-------------------------------------------------------------------------------------------|
|                             | RJE <i>n</i> ERRONEOUS STATION ADDRESSES                                                  |
|                             | RJE <i>n</i> ERRONEOUS CONTROL CODES                                                      |
|                             | RJE <i>n</i> CHARACTER PARITY ERRORS                                                      |
|                             | RJE <i>n</i> MESSAGE PARITY ERRORS                                                        |
|                             | RJE <i>n</i> CARRIER LOSSES                                                               |
|                             | RJE <i>n</i> MISSING WRITE CONTROL CODES                                                  |
| ERRONEOUS STATION ADDRESSES | The station address contained in the message was incorrect or for a non-existent station. |
| ERRONEOUS CONTROL CODES     | An invalid operation was received from the host system.                                   |
| CHARACTER PARITY ERRORS     | Bad parity was detected for a received character.                                         |
| MESSAGE PARITY ERRORS       | Bad parity (LRC) was detected for a received message.                                     |
| CARRIER LOSSES              | The communications carrier signal was lost before an ASCII end-of-text was received.      |
| MISSING WRITE CONTROL CODES | A write message was sent with no E1, E2, or E3 code.                                      |

## **LOAD COMMAND**

***(CDC Host Systems Only)***

Use this command to restart a job transmission that was aborted by the host CDC system.

### **RJE-LO**

Occasionally, a host CDC system terminates reception of a job due to unacceptable data (usually incorrect job control instructions). You must then issue the Load command to condition the host to accept a transmission restart. In such cases, the host will have discarded all previously read portions of the job text, so it must be retransmitted from the beginning to effect recovery. The host system does not indicate to you when a LOAD Command is required; you should confer with host personnel to establish the symptoms indicating a need for its use. Note that entering this command at an inappropriate time causes the 2000 System to discard images which otherwise would have been sent to the host.

## **TERMINATE PRINTER COMMAND**

***(CDC Host Systems Only)***

Use this command to force deallocation of the printer or JFD associated with the host lister function.

### **RJE-TP1**

A CDC host does not provide any special indication of the end of text output. Thus the 2000 System must take it upon itself to determine when to remove the printer from control of RJE (so that timesharing users can request it). When the host initiates output to the console, the 2000 System automatically deallocates the device assigned to the host lister. However, when there is no console output, the operator can choose to simulate it by entering the Terminate Printer Command. Clearly, this should only be done when the device is needed for timesharing purposes and when it is not in the process of outputting text from the host.



## **TRANSFER TO PRINTER COMMAND**

**(2770/2780/3780 Emulator Only)**

Use this command to transfer output from the console to the line printer.

### **RJE-TP**

By using the RC command you can direct output to the console rather than the assigned host list device (line printer). If excessive amounts of output reach the console, you can use the Transfer to Printer command to redirect the output to the line printer. (A small amount of output that is in process when you issue the command may still be received on the console.)

The TP command may also be used if you experience an irregularity of the 2770/2780/3780 Emulator which occasionally causes output destined for the line printer to be routed to the console instead. This anomaly occurs infrequently, and only when the console is expecting a response from a previously entered command. If this happens, you can use the Transfer to Printer command to reroute the output to the line printer.

## **READ TRANSPARENT COMMAND**

**(2770/2780/3780 Emulator Only)**

Use this command to indicate transparent transmission for a real peripheral (such as a card reader).

### **RJE-RX**

Normally, transmissions of data using the 2770/2780/3780 Emulator are non-transparent. Any illegal codes are automatically translated to the dollar sign character before transmission (for ease in detecting invalid codes). If you want to transmit all 256 valid EBCDIC codes (as, for instance with host object programs punched on cards) indicate transparent mode by using the RX command. The command is entered before readying the device with input and prevails until the device goes to end-of-file. If you enter the command when a device is active, the following message is generated:

**RJE REJECTED - READER BUSY**

Transparent transmissions are not allowed when ASCII line code is being used. If you enter the command while in ASCII mode, the following message is generated:

**RJE RX COMMAND NOT ALLOWED**

## USING RJE

The first step in using the RJE facility is to establish the communication link between the 2000 system and the host system. This may be done after a user requests you to make the connection or according to a work schedule established for your site. An example of a user request and the system connection procedure is given in figure 6-3.

Once the communications link is established from the system console, jobs may be entered from card readers and/or ASCII job transmitter functions that are assigned to host reader functions. The following paragraphs discuss the various ways in which jobs may be submitted.

| System Console Log<br>(Operator input is underlined) | Explanation                                                  |
|------------------------------------------------------|--------------------------------------------------------------|
| 01 PLEASE SET UP RJE CONNECTION                      | A user requests you to start RJE.                            |
| <u>RJE-SC,400,/*SIGNON</u> <u>REMOTE18</u>           | You enter this command at the system console.                |
| RJE SYSTEM READY                                     | HP 2000 system responds that it is ready.                    |
| RJE COMMUNICATIONS ESTABLISHED                       | The communications link is now functioning properly.         |
| RJE READER 1 AVAILABLE                               | The host reader function is available.                       |
| <u>ANN-1,RJE IS READY</u>                            | You inform the requesting user that RJE is ready for use.    |
| <u>BAN-THE RJE FACILITY IS AVAILABLE</u>             | You inform all users as they log on that RJE is functioning. |

Figure 6-3. Establishing an MRJE W/S Communication Link

## HOST SYSTEM CONTROL STATEMENTS

All jobs submitted to the RJE facility must include the control statements necessary to properly execute the job on the host system. Control statements either select functions to process a program, or call programs (stored on the host system) to process data. Examples of functions are: compilers, interpreters, loaders, etc. In addition, control statements can be used to control input/output operations. For instance, output can be directed to specific devices at either the host system or the 2000 system site.

Control statements vary with each host system. For this reason, you should obtain, from documentation about your host system, the specific control statements required to submit and process jobs. The term "job" refers to a unit of work for the host system. In most cases this will be a single program together with any needed data or host system statements. Multiple programs can be entered using a single EOF card at the end of the card deck.

## ENTERING A JOB

Normally, a job will be entered from a card deck through a card reader that has been assigned to a host reader (HR) function. After you enter the System Connect command, all you need do is place the card deck in the input hopper and enable the reader using the card reader controls.

## JOB OUTPUT

The device or job function designator associated with host system output function *n* is referred to as *device n* (printer *n* or punch *n*). The device assigned to a host function must be free for allocation before the 2000 System can accept data from the host. If this is not the case, the RJE function waits until the printer, punch, or JFD is available before accepting the data.

Whenever the RJE function cannot allocate the needed device, an appropriate message RJE AWAITING PRINTER $n$  or RJE AWAITING PUNCH $n$  is printed.  $n$  identifies the host lister or punch function associated with the unavailable device or JFD. RJE waits until the device is available and then automatically begins transferring data. (These messages will not appear for the JL and JP function designators unless one of them has been assigned as the device for two or more host functions and they are contending for the output facility.)

If a line printer malfunctions, or a JL file is closed by its activating program while it is receiving data from the host, the console reports RJE PRINTER $n$  ATTENTION REQUIRED. The affected host output function  $n$  remains blocked until the device is restored to operating status, or until the JL is reopened and the remainder of the host transmission has been accepted. Host punch files faced with similar circumstances cause the report RJE PUNCH $n$  ATTENTION REQUIRED.

Job output can be returned to a physical device or through an ASCII JFD to a program running at a user terminal. The host system normally returns job output to the first available host lister (HL) or host punch (HP) function. If a line printer, paper tape punch, or card reader/punch/interpreter is assigned to that host function, then the output will be generated when the device becomes available. If an ASCII function designator (JL $n$  or JP $n$ ) is assigned to the host function, then the first line of output will be held until requested by a user program. The 2000 System does not request additional data from the host system until the previous line has been read by a user program. The user program can then print the output on the terminal, output the data to a non-sharable I/O device, store it in a disc file, or do all three.

For IBM-MRJE/WS, you must use forms control commands to insure that output is returned to a specific host function. The host system allows you to designate specific host functions for certain output formats. This is done by issuing the RJE-RC command either at the system console or from a user program (via JI0).

An example of a forms assignment is given in Part A of figure 6-4. In this example, using an "X" or "#" in place of one or more digits of the forms number allows a group of form types to be routed to the same host function with a single command.

Once forms assignment has been made, the user can place host system job control statements in his job deck to specify that output be printed using a specific form. The output is then routed to the host function assigned to that form. The host function can in turn be assigned a specific device or job function designator (using the RJE-DA command). An example of host function assignment is given in Part B of figure 6-4.

RJE-RC, \$STR18.PR1, F=0005

This causes all printer output using form 0005 to be returned to Host Lister 1 (HL1)

RJE-RC, \$STR18.PU1, F=010#

This causes all punch output using forms 0100 through 0109 to be punched on Host Punch 1 (HP1).

(A)

RJE-DA, HL1 > LP3

This causes output on Host Lister 1 (HL1) to be sent to line printer 3.

RJE-DA, HP1 > JP2

This causes output on Host Punch 1 (HP1) to be sent to Job Punch file 2 (JP2).

(B)

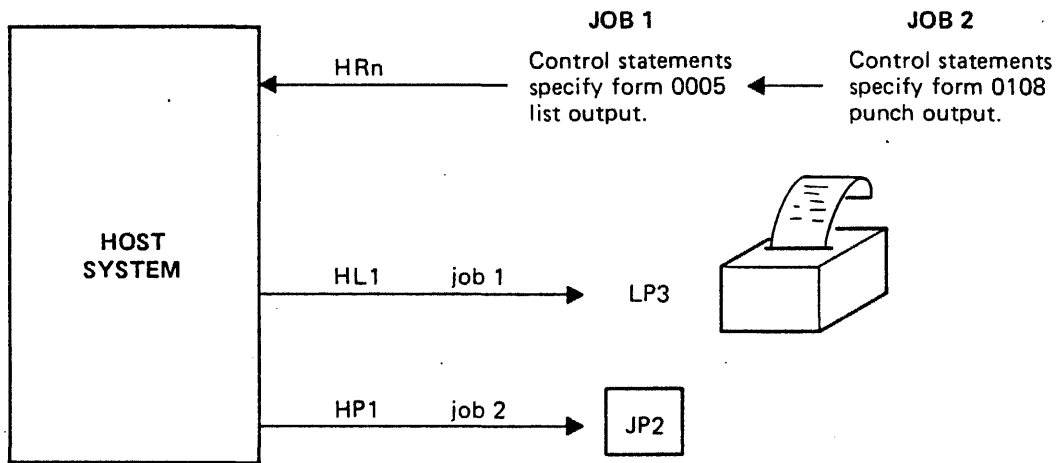

Figure 6-4. IBM-MRJE/WS Forms Assignment (Used to Route Output)

## 2000 TO 2000 COMMUNICATIONS

Communications between two HP 2000 Computer systems provide most of the features that are available with MRJE emulation. The main exceptions are:

- Only data can be transmitted from one HP 2000 system to another.
- 2000 to 2000 communication does not support a host punch function.
- The RJE Remote Command is used only for sending messages from one system to another.
- The System Connect command does not use a sign-on message.

When a local HP 2000 system uses RJE to communicate with a remote HP 2000 system, the remote system can be considered the host. However, when the host returns data to the local system, then the local system acts as host. Each 2000 system may use seven reader functions for accepting input and seven lister functions for producing output, an inquiry function for sending messages, and a message function for receiving messages. The punch functions are not used.

As with RJE communication, data can be placed directly into an input device that is equated to a host reader or it may be communicated programmatically using an ASCII file equated to a Job Transmitter function. Data may be received directly on a host lister equated to a line printer or programmatically through an ASCII file equated to a Job Lister function.

Table 6-12 illustrates the communications link between two HP 2000 Computer Systems. The host functions and job functions are those described earlier under "Remote Job Entry Communications."

Table 6-12. Local and Remote 2000 Host Function Organization

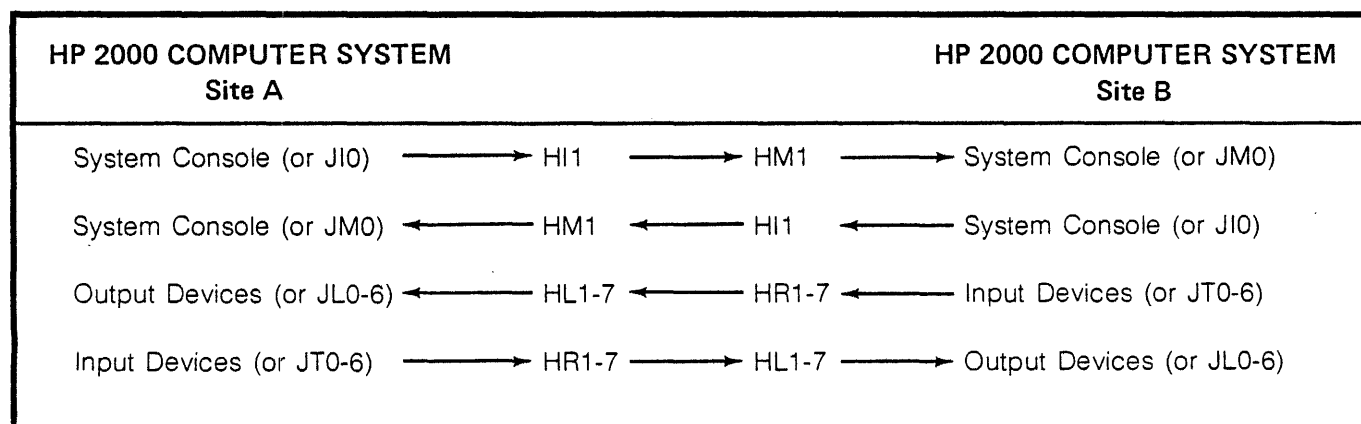

## 2000 TO 2000 OPERATOR COMMANDS

The 2000 to 2000 communications facility accepts the commands summarized in table 6-13. Some, however, are not acceptable if entered while the communication line is not connected and so cause the RJE COMMAND NOT APPROPRIATE message to be printed on your system console. As with the other types of remote communications, 2000 to 2000 commands and responses are prefixed by RJE to visually distinguish such activities from timesharing.

Table 6-13. Summary of 2000 to 2000 Operator Commands

|                                                                                  |                                                                                                                                                                                                                                                                              |
|----------------------------------------------------------------------------------|------------------------------------------------------------------------------------------------------------------------------------------------------------------------------------------------------------------------------------------------------------------------------|
| RJE- $\left\{ \begin{array}{l} \text{SC} \\ \text{SCA} \end{array} \right\} [n]$ | <b>System Connect.</b> This command links one HP 2000 Computer System to another. Must be typed by both systems. SCA requests automatic restart after disconnect.                                                                                                            |
| RJE-DA, $hf \left\{ \begin{array}{l} < \\ > \end{array} \right\} device$         | <b>Device Assignment.</b> This command assigns specific system non-sharable devices or ASCII job function designators to host functions (data streams). When used without function or device parameters, this command generates a listing of the current device assignments. |
| RJE-SR $n$                                                                       | <b>Start Reader.</b> This command is used to activate a reader associated with host reader function $n$ (HR $n$ ).                                                                                                                                                           |
| RJE-RR $n$                                                                       | <b>Restart Reader.</b> This command restarts a reader associated with host reader stopped due to a data error.                                                                                                                                                               |
| RJE-TR $n$                                                                       | <b>Terminate Reader.</b> This command is used to stop a reader associated with a host reader function $n$ (HR $n$ ).                                                                                                                                                         |
| RJE-[RC] $m$                                                                     | <b>Remote Command.</b> This RJE command sends a message to the other system's console. RC is optional so long as the first two characters of the message are not SC, DA, SR, RR, TR, ER, or SD.                                                                              |
| RJE-ER[,R]                                                                       | <b>Error Report.</b> This command obtains a listing of communication errors detected during data communications. When the optional R parameter is used, current error counts are reset to 0 following the report.                                                            |
| RJE-SD                                                                           | <b>System Disconnect.</b> This command ends a data communications session by terminating the link with the host system. It also terminates automatic retries if SCA is in effect.                                                                                            |

## SYSTEM CONNECT COMMAND

This command is used to connect one HP 2000 system to another.

$$\text{RJE-} \left\{ \begin{array}{l} \text{SC} \\ \text{SCA} \end{array} \right\} [ , n ]$$

*n* is the buffer size. Both systems must specify the same configuration because buffer overruns terminate the connection.

After one system operator types this command, the other system operator should type the same command and then follow dialing procedures necessary to make the connection. In a leased line environment, communications are automatically established after both operators enter this command; no dialing is necessary. Dial-up (switched network) communications require the first operator to dial the second system and the second system to be equipped with an auto-answer modem; or they require the operator at the second system to manually answer and press the DATA key.

Both systems must receive the RJE SYSTEM READY message before connections can be established. Once phone line connections are made, both sites should receive the RJE COMMUNICATIONS ESTABLISHED message and remote accessing activities can begin.

## DEVICE ASSIGNMENT COMMAND

A data source or destination device must be associated with each host reader (HR) and lister (HL) function that is configured on the system. Initial device assignments are made when the system is configured. However, you may use the Device Assignment command to change an assignment.

The physical I/O devices and ASCII job file designators you can assign to host functions are designated as follows:

CR*n* card reader  
 RP*n* card reader/punch/interpreter  
 LP*n* line printer  
 PR*n* paper tape reader  
 JT*n* job transmitter  
 JL*n* job lister  
 JP*n* job punch

Similarly, the individual host functions are designated as follows:

HR*n* host header function  
 HL*n* host lister function

When you enter a Device Assignment command, an association is made between one of the devices or ASCII JFD's and one of the host functions. Some assignments would not make sense, for example, a card reader with a printer function. Therefore, in order to assist you in making proper assignments, an arrow (< or >) is included in the command to show data flow direction. The general forms of the command follow:

$$\text{RJE-} \left\{ \begin{array}{l} \text{DA, function} < \text{device} \\ \text{DA, function} > \text{device} \\ \text{DA} \end{array} \right\}$$

**function** is one of the host functions (for instance, HR1).

**device** is one of the available I/O devices (for instance, CR0), or it is one of the ASCII job file designators (for instance, JL2).

The first of the general forms shown is used to assign devices to the host reader function. The arrow indicates flow of data from the device to the host. The second of the general forms shown is used to assign devices to the host lister functions. Again the arrow indicates the flow of data, this time from the host to the device or ASCII JFD. The last of the general forms shown is used to produce a listing of all current device assignments. Responses will be of the forms:

RJE *function* < *device*  
RJE *function* > *device*

Assignments can only be made when neither the affected host function nor the affected device or Job Function Designator is in use. The new assignment will have no effect until the host function becomes in use. For a host reader function, it and its assigned device or JFD becomes "in use" when you enter a System Connect or Start Reader command. Use ends when you enter a Terminate Reader or System Disconnect command and the designated host reader function completes transmission of any current job text. A host lister function and its assigned device or JFD become "in use" when data is received from the host. "Use" continues so long as output is pending and ends when output is complete.

## START READER COMMAND

An I/O device or ASCII job function designator assigned to host reader function number *n* is called reader *n*. To activate reader *n*, use the following command.

**RJE-SR*n***

***n*** is the number of a specific host reader function.

If the reader is, or can be, assigned for data communications activity, the message RJE READER*n* AVAILABLE is printed on the system console.

If the reader is active with some other function, the message RJE READER*n* NOT AVAILABLE is printed.

Note that a Start Reader command is generated automatically when communications are established. After the reader is activated, it operates in a "hot" mode. That is, it remains active (ready to read). You need only to place cards in the input hopper and start the device for the data to be read. No other intervention is necessary unless errors occur.



Two types of problems may occur at the card reader which require your attention. One type includes the normal physical errors such as card jams and failure to terminate the data with an EOF card. The second type of problem is detection of illegal hole punch combinations in cards.

When the first type of problem occurs, you receive the message RJE READER $n$  ATTENTION REQUIRED (bell). A typical situation occurs when users omit the 2000 End-of-File card from their input decks. (These cards contain colons (::) in columns one and two.) With HP 2892 card readers, to correct the problem, push the END OF FILE button and the system assumes an EOF card when the hopper is empty. With other card readers you must punch an EOF card and place it in the reader. Note that the system ignores an EOF card at any point other than the last card in the input hopper.

The second type of problem occurs when the system detects an illegal hole punch combination in cards. For 2000 to 2000, 256 valid EBCDIC codes can be read and transmitted to the host system. If illegal characters are detected, the reader halts and prints RJE READER $n$  DATA ERROR (bell). The card with the error is the last card in the output stacker. You may correct the card and replace it in the input hopper, or you may ignore it. In either case, you must use the Restart Reader command to continue reading the cards in the input hopper.

## RESTART READER COMMAND

This command is used to restart a card reader after it has halted due to an illegal punch in a card.

**RJE-RR $n$**

$n$  is the number of a specific host reader function.

The system will not accept the Restart Reader command unless the communication link is established. Entering this command when the link is not active causes the message RJE COMMAND NOT APPROPRIATE.

## TERMINATE READER COMMAND

To detach a host reader function from the communications function, issue the following command.

**RJE-TR $n$**

$n$  is the number of a specific host reader function.

As soon as reader  $n$  finishes reading any remaining data, the message RJE READER $n$  NOT AVAILABLE is printed on the system console.

A Terminate Reader command is generated automatically when a system disconnect is performed.

## REMOTE COMMAND

In 2000 to 2000 communications, this command is used to send messages from one system console to the other.

### RJE-[RC,] message

**RC** stands for Remote Command. RC must be included if the first two characters of your message correspond to an RJE command (for example, SC, SD, ER, TR, SR, RR)

Once the phone line is connected, use this command to send a one-line message to the other operator. If you enter the command but connection has not been made, the system prints RJE COMMAND NOT APPROPRIATE.

## ERROR REPORT COMMAND

To aid in checking the quality of your communications link with the host system, you can request a list of communications errors using the following command.

### RJE-ER [,R]

**R** is an optional parameter. When it is included, the current error counts are reset to 0 following the report.

The Error Report command generates a list of several possible communication error types. The error formats are listed in table 6-14. Note the *n* in the error report is the number of errors detected for each error type.

Table 6-14. 2000 to 2000 Error Report Items

|                   |                                                                                                                                   |
|-------------------|-----------------------------------------------------------------------------------------------------------------------------------|
|                   | RJE <i>n</i> SEQUENCE ERRORS                                                                                                      |
|                   | RJE <i>n</i> RECEIVE OVERRUNS                                                                                                     |
|                   | RJE <i>n</i> TIME OUTS                                                                                                            |
|                   | RJE <i>n</i> NAKS                                                                                                                 |
|                   | RJE <i>n</i> DATA CHECKS                                                                                                          |
|                   | RJE <i>n</i> UNKNOWN RESPONSES                                                                                                    |
|                   | RJE <i>n</i> CARRIER LOSSES                                                                                                       |
| SEQUENCE ERRORS   | Data has been received out of sequence or has been lost.                                                                          |
| RECEIVE OVERRUNS  | More data was received than would fit in a buffer. This may be due to incorrect size specification in the System Connect Command. |
| TIME OUTS         | No data was received within the expected time interval.                                                                           |
| NAKS              | Negative acknowledgement from the host system indicating that it has detected a data error.                                       |
| DATA CHECKS       | The communications facility detected an error in data received from the host.                                                     |
| UNKNOWN RESPONSES | An invalid character was received from the host system.                                                                           |
| CARRIER LOSSES    | The incoming data signal was lost before the entire message was received.                                                         |

## SYSTEM DISCONNECT COMMAND

Use the System Disconnect command to end a data communications session or to disable the automatic restart feature. The System Disconnect command should be used also before SLEEPing or HIBernating a system.

### RJE-SD

As soon as current printing or card transmission is complete, the message RJE SYSTEM DISCONNECTED (TYPE *n*) is printed on the system console. The *n* in the disconnect message indicates what caused the disconnection according to type. Causes and types are listed in table 6-15.

Table 6-15. 2000 to 2000 System Disconnect Codes

| TYPE | CAUSE                                                                                                                                  |
|------|----------------------------------------------------------------------------------------------------------------------------------------|
| 0    | Normal disconnection by the operator                                                                                                   |
| 1    | Excessive errors (time outs or data checks)                                                                                            |
| 2    | Line loss or other failure in the communications equipment                                                                             |
| 3    | The other system caused the disconnect                                                                                                 |
| 4    | Excessive buffer overruns or sequence errors; could be caused by improperly specifying the buffer length in the System Connect command |
| 5    | Power failure                                                                                                                          |

## USING THE 2000 TO 2000 FACILITY

The first step in establishing communications between two HP 2000 systems is to dial the telephone number of the remote system. Next enter an RJE-SC or RJE-SCA command. Once the communications line is active, data may be entered from a card reader or from user's files.

In many respects, 2000 to 2000 I/O operations are similar to those of RJE. You assign host functions to job functions or real devices for purposes of transmitting and receiving data; and you receive the same diagnostic messages (for example, RJE AWAITING PRINTER *n*). However, an interesting difference is the remote to local host function relationships. With RJE, the host system normally returns output on the first available host function. This necessitates using forms control to direct output to a specific job function or real device. With 2000 to 2000, the host system receives output only on the specific job function designator associated with the output file by a user issuing a FILE command.

## 2780 TO 2780 COMMUNICATION

This facility allows communication between an HP 2000 system emulating a 2770, 2780 or 3780 terminal, and one of the following:

- A 2770, 2780 or 3780 terminal (with the same configuration as the Emulator)
- Another HP 2000 system running the 2770/2780/3780 Emulator
- An HP 3000 system running the 2780/3780 Emulator
- Any other Computer System emulating a 2770, 2780 or 3780 terminal (with the same configuration as the Emulator)

Refer to Table 6-16 for the exact terminal configurations provided by the 2770/2780/3780 Emulator. In all three types of communications listed above, the terminal configurations being emulated on the HP 2000 system must match the terminal configurations being emulated on the other system.

2780 to 2780 Communication is similar to the process of Remote Job Entry except that only data, not jobs, can be transmitted. Data can be transmitted from one system to another through the job transmitter functions and received through the job lister functions.

As with RJE communication, input can be placed directly in a card reader equated to a host reader or data may be communicated programmatically using an ASCII file equated to a JT (Job Transmitter) function. Output may be received directly on a host lister or programmatically through an ASCII file equated to a JL (Job Lister) function. Except for the fact that only one reader function and one lister function are available, the capability is similar to the IBM MRJE workstation.

Table 6-16. Terminal Configurations of 2770/2780/3780 Emulator

|      |                                                                                                                                                                                                                                                                                                                                                                      |
|------|----------------------------------------------------------------------------------------------------------------------------------------------------------------------------------------------------------------------------------------------------------------------------------------------------------------------------------------------------------------------|
| 2770 | Buffer expansion (256 characters each), fifteen response retries, EBCDIC code, EBCDIC transparency, automatic answering, component selection. (Note that this is only usable by BASIC programs.)                                                                                                                                                                     |
| 2780 | Automatic answering, multiple record transmission (basic 400 character buffer), EBCDIC code, EBCDIC transparency, 144 character print lines. (Note that HP printers only support up to 132 character print lines), extended ENQ retry, component selection. (Note that this is only usable by BASIC programs.)                                                       |
| 3780 | EBCDIC code, EBCDIC transparency, automatic answering/disconnect, space compression/expansion, extended ENQ retry, 144 character print lines. (Note that HP printers only support up to 132 character print lines), component selection. (Note that this is only usable by BASIC programs.) The 3780 always runs as if the space compression/expansion switch is on. |

## 2780 TO 2780 OPERATOR COMMANDS

The 2780 to 2780 Communication facility accepts the commands summarized in table 6-17. The commands are used in the same way they are used in RJE facility communication discussed earlier.

Table 6-17. Summary of 2780 to 2780 Operator Commands

| COMMAND                                                                                                                                      | DESCRIPTION                                                                                                                                                                                                                                                                                                                                                   |
|----------------------------------------------------------------------------------------------------------------------------------------------|---------------------------------------------------------------------------------------------------------------------------------------------------------------------------------------------------------------------------------------------------------------------------------------------------------------------------------------------------------------|
| RJE- $\left\{ \begin{array}{l} \text{SC} \\ \text{SCA} \end{array} \right\} \left\{ \begin{array}{l} ,n \\ ,n,m \\ ,,m \end{array} \right\}$ | <b>System Connect.</b> This command links the 2000 system with the remote system. SCA requests automatic restart after disconnect. <i>n</i> and <i>m</i> are determined by host system personnel.                                                                                                                                                             |
| RJE-DA, <i>hf</i> $\left\{ \begin{array}{l} < \\ > \end{array} \right\}$ device                                                              | <b>Device Assignment.</b> This command assigns specific system non-sharable devices or ASCII job function designators to host functions (data streams). When used without function or device parameters, this command generates a listing of the current device assignments.                                                                                  |
| RJE-SR <i>n</i>                                                                                                                              | <b>Start Reader.</b> This command is used to activate a reader associated with host reader function <i>n</i> (HR <i>n</i> ).                                                                                                                                                                                                                                  |
| RJE-TR <i>n</i>                                                                                                                              | <b>Terminate Reader.</b> This command is used to stop a reader associated with host reader function <i>n</i> (HR <i>n</i> ).                                                                                                                                                                                                                                  |
| RJE-RR <i>n</i>                                                                                                                              | <b>Restart Reader.</b> This command restarts a reader associated with host reader stopped due to a data error.                                                                                                                                                                                                                                                |
| RJE-[RC,] <i>m</i>                                                                                                                           | <b>Remote Command.</b> This RJE command sends a command to the remote system. The host system command is contained in <i>m</i> . Host commands (the <i>m</i> parameter) can also be sent from a user program via the job inquiry function (J10). RC is optional so long as the first two characters of the message are not SC, DA, SR, RR, TR, ER, SD, or TP. |
| RJE-ER [,R]                                                                                                                                  | <b>Error Report.</b> This command is used to obtain a listing of communication errors detected during operation of the RJE facility. When the optional R parameter is used, the current error counts are reset to 0 following the report.                                                                                                                     |
| RJE-SD [, <i>m</i> ]                                                                                                                         | <b>System Disconnect.</b> This command ends an RJE session by terminating the communications link with the remote system. The optional <i>m</i> parameter is a signoff message. SD also terminates automatic retries if SCA is in effect.                                                                                                                     |
| RJE-RX                                                                                                                                       | <b>Read Transparent.</b> This command indicates transparent transmission for a real peripheral (such as a card reader). It is used before readying the device with input and prevails until the device goes to end-of-file.                                                                                                                                   |
| RJE-TP                                                                                                                                       | <b>Transfer to Printer.</b> This command transfers output from the console to the line printer. It is used whenever output is to be redirected to the line printer.                                                                                                                                                                                           |

# THE SYSTEM MANAGER

SECTION

VII

A system manager has the overall responsibility for developing plans to utilize an HP 2000 System. Typically, a system manager performs the following tasks:

- Defines operating guidelines
- Plans user account allocations
- Establishes account billing procedures
- Organizes a reliable system backup scheme
- Determines system documentation needs and filing procedures
- Interfaces with HP representatives
- Schedules daily report activities
- Monitors daily system operation

The system manager may have one or more system operators reporting to him or he may serve simultaneously as both manager and operator.

The system manager need not be a computer expert or programmer, but he must become familiar with the general concepts relating to the account numbering structure, storage allocations, system backup, and information security (to mention a few). He should be able to carry out simple operator tasks including backup and recovery after failures.

## SUPERVISORY PLANNING

The system manager is usually responsible not only for allocating system resources but also for supervising the physical layout of a facility. He must establish the working environment of the equipment, the operator, and the users. This includes such diverse tasks as planning the placement of system components, arranging telephone service and providing an adequate number of filing cabinets. The manager must also plan for smooth, efficient system operation by typically providing:

1. Procedures for purchasing supplies such as line printer paper, punch cards, magnetic tapes, etc.
2. Forms to be used for interoffice communications and system documentation.
3. Schedules for generating system activity reports (refer to the REPORT, DEVICE and DIRECTORY commands in Section III).
4. Official policy concerning new account assignments and account accessing capabilities.
5. Guidelines for performing library housekeeping tasks (refer to the COPY, BESTOW and PURGE commands in Section III).
6. Plans for system security including backup schedules, backup tape rotation schemes, and installation security.

## OPERATING CONSIDERATIONS

Because the system manager is responsible for establishing which user should be assigned what idcode and accessing capability, we include the following paragraphs about how idcodes are organized within the system and how they relate to library accessing capabilities. We have also included discussions about library manipulations, system usage documentation and backup schemes in an effort to aid the system manager in his overall planning.

### USER IDCODE ORGANIZATION

The system utilizes identification codes (idcodes) to identify every user. A unique password may be used along with each idcode to insure account security; but the system does not actually require its use. (Passwords are explained in Section III under the NEWID command.) The idcodes are organized by the system for accounting purposes, controlling accessing capabilities, data security and account privacy. A single alphabetic character followed by three decimal digits comprise an idcode. The range is from A000 to Z999 (inclusive); making a total of 26,000 distinct idcodes. Two thousand of these (all idcodes beginning with Y and Z) should be reserved for HP applications and for utility and miscellaneous programs. The remaining 24,000 idcodes are available for establishing individual user accounts. Note that although 26,000 idcode patterns exist, the system only provides space for 682 to 6820, depending upon the number of id tracks allocated.

The system groups idcodes, 100 to each group. For example, A000 through A099 constitute the first group, A100 through A199 comprise the second group and so on through the last possible group, Z900 through Z999. There can be 260 groups.

User organization is illustrated in figure 7-1. The three levels of libraries reflect the three types of idcodes as follows:

- The very first idcode within the system, A000, is assigned to the user who will serve as the system master and preside over the system library.
- The first idcode within each group (for instance, A100, D300, etc.) is assigned to the user who will serve as group master and preside over that group's library.
- All remaining idcodes can be assigned to private users.

Since A000 is both the first idcode in the system and the first idcode of the first group, the system master serves as group master for the first group.

When an idcode is created, an upper limit is set to the amount of disc space permitted to the idcode for storing programs and files. As the user allocates disc space to programs and files, he creates a "library" for his idcode.

Just as there are three types of users, so are there three types of libraries associated with those users. (1) The library assigned to the system master is referred to as the system library. (2) A library assigned to a group master is called a group library. (3) The library of an individual user is known as a private library. Each user can access elements in his own private library and, to the limit of any restrictions, programs and files in his group library and in the system library. A user cannot access other libraries unless these libraries have been given Program/File Access (PFA) capability.



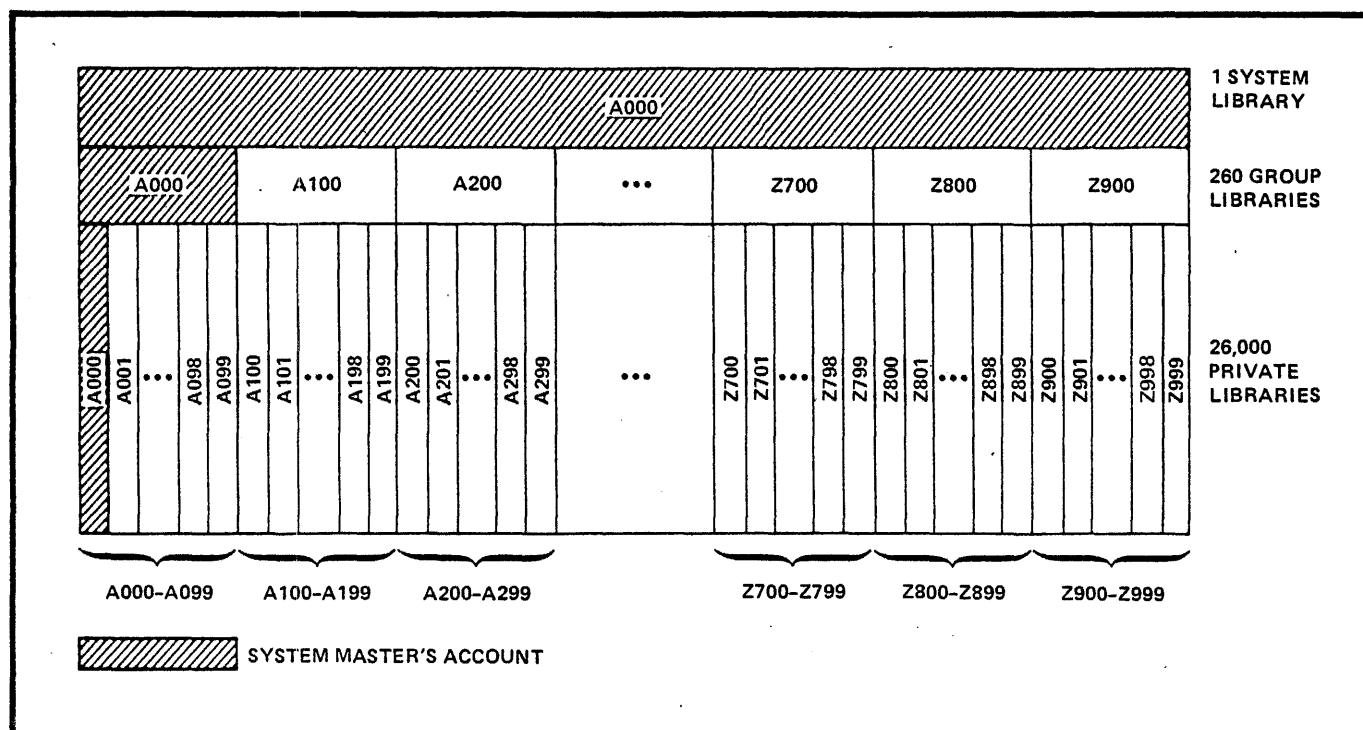

Figure 7-1. Idcode/Group Account Structure

## ACCOUNT ACCESSING CAPABILITIES

Thus far we have discussed the accessing capabilities the system automatically grants each idcode. However, there are other types of accessing capability not associated with the idcode/group structure. One is based on the account Program/File Access (PFA) capability as established by the operator via the NEWID or CHANGEID commands. When you assign an idcode to a user, you have the option of giving that account the Program/File Access capability (PFA). When an account has PFA, the owner may make elements in his library accessible to all other users, forming a virtual system library. In this way, a user may access private libraries in addition to his own group library and the system library.

An idcode may also be granted Multiple-Write Access (MWA) capability via the NEWID or CHANGEID commands. Account MWA capability makes it possible for an owner to declare his files to have MWA status. When no Multiple-Write Access capability has been granted to an account by the operator, files in the account library always have SWA status. SWA stands for Single-Write Access. When a file has SWA, only one user at a time can write on the file. When a file has MWA, several users can access and write to the file simultaneously.

When you create a group master idcode, an option exists for granting the account File Create/Purge (FCP) capability. With FCP, the group master has special accessing powers within the libraries of his own group members. His locked or private programs may create, give MWA status to, read, write, or purge locked BASIC-formatted files located in libraries of his own group members, so long as those libraries have Program File/Access capability. A group master's locked or private programs may also CHAIN to a specified line in a locked program resident in a group member's library.

Of course an owner can always limit access to his library by placing restrictions on individual programs and files. This is why the operator cannot always COPY or BESTOW library elements — they have been declared "locked" or "private" by their owners. Restrictions are discussed completely in the *HP 2000 BASIC Reference Manual* (part number 22687-90001).

Considering idcode/group accessing capabilities together with the PFA, FCP, and MWA accessing capabilities; it is possible to plan elaborate data security schemes for your installation. Remember that the ninety-nine accounts numbered A001 through A099 are unique on an HP 2000 system since they have the system library as their group library. This feature might be utilized in a number of ways. For example, an applications program can be a locked program in the system library. As such, it can have the right to programmatically create, manipulate, and purge files in the A0xx accounts, even when being run from some other account on the system. Since there are precisely ninety-nine unique account numbers available, they should not be assigned to just any users, but rather, should be reserved for special system library applications. Assigning these idcodes without careful consideration would waste the power of these accounts.

## **PRIVATE LIBRARY — PRIVATE USER**

A private library is created and maintained by each idcode. This library is completely controlled by the user assigned that idcode. The user can enter, modify, restrict access to, and delete programs and files within his private library. When the account has Program/File Access (PFA) capability, its library can (under certain circumstances) be accessed and altered by the group master or by other users.

## **GROUP LIBRARY — GROUP MASTER**

A group library is a common library normally accessible only to members of the group. However, when the account has PFA, all or part of the library can be made accessible to all other system users. The group master is responsible for creating, maintaining, deleting, and controlling access to the programs and files within this library. A group master's programs can create, give MWA status to, read, write, and purge locked BASIC-formatted files in the accounts of group members having PFA — if he has been given the File Create/Purge (FCP) capability by the system operator. A group master's locked or private programs may also CHAIN to a specified line in a locked program resident in a group member's library.

## **SYSTEM LIBRARY — SYSTEM MASTER**

The system library is a common library normally available to all users of the system. The system master may, however, place accessing restrictions on individual programs and files within this library.

Basic functions of the system master are similar to those of a group master, but more extensive. The system master can enter, modify, restrict access to, and delete programs and files in the system library. The system master is also the group master for accounts A001 through A099 and, as such, can be given File Create/Purge capability over their libraries.

Often the system operator serves as the system master but the functions and responsibilities of the two jobs are distinct. An operator controls the system but has little control over the system library. The system master has extensive control of the system library but no control over the system. If the operator serves as the system master, a user terminal independent of the system console must be available to the operator.

A system master may enter several commands at a terminal that are otherwise reserved for the system operator. The DIRECTORY, REPORT, and DUMP commands can be entered at a user terminal after logging on the A000 account. These commands are explained in Section III.

The system master is responsible for creating and maintaining the optional HELLO program within the system library. This BASIC language program transmits pertinent information to users at log-on time. The log-on message might inform users of the following:

- System identification
- Port number
- Date and time of log-on
- System hibernate and sleep schedules
- News for the day
- News about new applications programs

It is possible to use the HELLO program to create a dedicated environment. If an account is to execute only one particular application program, and not be permitted any other system activity, the HELLO program can channel the user to the application program immediately upon log-on. This might be accomplished in the following manner:

- a. For each account on the system, establish a file containing information about planned account usage. This file should reside in A000 and be locked; hence only available to locked system library programs.
- b. Write the HELLO program so that it determines the user's log-on idcode, scans the file previously established, and takes the user to the appropriate program. Or the HELLO program could CHAIN to some other program that performs this task.
- c. The application program should not re-enable the BREAK key at the user's terminal (HELLO execution automatically disables BREAK) and should execute a programmatic BYE command whenever it relinquishes control.

## LIBRARY MANIPULATIONS

The operator often manipulates the contents of various user libraries. He might copy, bestow, purge, load, restore, or dump programs and files as part of normal daily activities. Because it is desirable for the operator to document all activity from one library to another, we have included sample forms in Appendix H. These forms provide space for transfer approval and serve to permanently document operator activity.

### System Purge

The operator can enter the PURGE command to clear libraries of unused (thus presumably obsolete) elements. When this command executes, the system checks the date when each library entry was last accessed. If a date is earlier than the date supplied in the PURGE command by the operator, that entry is removed from the system. Thus purging schedules, along with the purge dates, should be well publicized so that users can take appropriate action to prevent inadvertent loss of their outdated programs and files. Since the system does not notify the operator of which programs and files were purged, the operator should use the DIRECTORY command both before and after a system purge to document exactly what transpired.

## Selective Dump, Load, and Restore

Procedures for a system update, magnetic tape reload, and disc reload allow selective dump, load, and restore operations. This facility provides a means for producing a copy of selected libraries, or for transferring programs and files from one 2000 system to another. We explain procedures involving the DUMP, LOAD, and RESTORE commands in Section IV under the heading "Load, Restore, and Dump Options." We explain the salient features of these commands in the following paragraphs.

**Selective Dump.** During a dump, the indicated portion of a library (or libraries) is dumped onto one or more reels of magnetic tape. Each idcode-name pair requests that a specific library entry be dumped. An idcode entered alone requests dumping of that account's entire library. If either the idcode or entry does not exist in the system, a diagnostic message informs the operator of that fact. The word ALL as an entry is treated as having supplied a list of every idcode in the system. When ALL terminates an entry list, an idcode-name pair is superfluous except to check if a particular entry exists. Note that ALL produces a set of tapes equivalent to those which a HIBERNATE command would produce, but the system file is omitted.

**Selective Load.** During selective load, new entries are merged into libraries from a set of tapes produced by a selective dump, sleep, or hibernate. (It is possible to use a set of tapes produced by other means if they follow the format of a selective dump set. Such tapes must be prepared with utmost care since the HP 2000 System cannot guarantee the validity of libraries loaded from such tapes. Hewlett-Packard cannot warrant the stability of a system in such cases.) Each idcode-name pair entered by the operator requests that a specific library entry be loaded from the tapes. The request will be rejected if an entry name already exists in the specified library. Entering an idcode alone requests loading of all entries belonging to that account. However, any entry found on the tapes whose name already exists in the library will be ignored without comment from the system. Entering ALL is treated as equivalent to having supplied a list of every idcode in the system. In this case, each preceding request for an idcode-name pair will ensure notification if the specified entry is not found on the tapes.

The system prints an appropriate message if a prospective entry is found on the tapes but cannot be recovered due to a tape error. An equivalent message appears for each entry on the tape that cannot be identified (also due to a tape error). If the end of a set of tapes occurs, but the requested entries were not found or tape errors prevented loading an entry, the loader asks if another set of tapes is available. Note that if the operator supplies another set, any additional entries found belonging to requested idcodes will also be loaded (not just those unrecovered from the previous set of tapes). The loader continues to request additional sets of tapes until it loads all desired entries. If the operator denies a request, the loader prints a list of the unrecovered entries, identified by idcode, name, and a note that they were deleted from the directory. If ALL terminated the original list of requested items, and entries were found on the tapes whose accounts do not exist in the system, a list of these account idcodes is printed.

**Selective Restore.** Restore has many parallels with selective load but must not be confused with it. Although, like selective load, it merges entries into libraries from a set of tapes, the primary purpose of the selective restore is to **replace** existing portions of libraries. The system decides to replace an entry by matching names. Thus a program can replace a file and vice versa, if the name on the tape matches a name already in the library. An important use of selective restore is in recovering from a system failure that resulted in a salvage dump (refer to "Warmstart Procedure" in Section V). After reloading the library from the latest sets of sleep and hibernate tapes, a selective restore is used with the salvage dump set to both recover programs and files created since the last normal sleep and to replace library entries thus recovered with their most recent versions (the versions on the salvage dump tapes). Another example of using the selective restore follows. A collection of programs and files representing an application package can be replaced in toto by issuing a restore against a set of tapes containing an updated version. Note however, entries in the library whose names are not found on the tapes remain. They are not purged.

The request list for a selective restore can specify both individual entries and entire libraries. Each idcode-name pair entered requests loading a new version of the named entry (replacing any existing entry of the same name). This differs from a selective load where requests are rejected if the name already exists in the given library. Entering an idcode alone requests loading all entries belonging to that account; new entries are added to the library and existing entries are replaced when matching names occur. Entering ALL is treated as equivalent to having supplied a list of every idcode in the system. In this case, each preceding request for an idcode-name pair will ensure notification if the specified entry is not found on the tapes.

As with selective load, if the loader finds a prospective library entry on the tapes but cannot load it due to a tape error, then the idcode-name pair is added to the notification list. Similarly, any entry that cannot be identified due to a tape error will produce a diagnostic message containing its idcode and name. Sometimes, the end of the set of tapes will be reached without finding all requested entries or without recovering one or more entries (due to tape errors). If this happens, additional sets of tapes are not requested because they might cause previously loaded entries to be replaced by yet older versions. Instead, the loader prints a list of unrecovered entries, giving the idcode and name of each. If the identification is followed by DELETED, then no version of the entry exists and its directory entry is purged. The absence of DELETED indicates that some entry of this name already existed in the library. In this case, the pre-existing entry is retained rather than being purged. The operator should inform the library owner of programs and files thus preserved as they could possibly be obsolete. If ALL terminated the list of requested items and entries are found whose accounts do not exist in the system, a list of these account idcodes is printed.

**Directory Overflow.** During selective load or selective restore of a heavily loaded system, it is possible to exhaust the available directory space. This condition is reported with the message NO ROOM IN DIRECTORY. If this occurs while loading from tapes, the operation continues to recover entries whose names already exist in the directory. In fact, the selective load asks for additional sets of tapes if one or more of the directory entries has not been recovered by the end of the set of tapes. However, this diagnostic message guarantees that at least one prospective entry was not loaded. It may be possible to continue through the date and time sequence; immediately sleep the system with a tape dump; perform a magnetic tape reload during which the number of directory tracks is increased; and repeat the selective load or selective restore to recover the rejected entries. If this is not or cannot be done (for example, because all potential directory tracks are already allocated), then the libraries will be in an indeterminate state, producing unpleasant surprises for affected users.

## SYSTEM USAGE DOCUMENTATION

The system provides system usage information in reports (refer to the REPORT command in Section III). Personnel at an installation can set up programs to monitor the report information for billing and system history purposes.

A system manager or the operator might issue the REPORT command nightly to record the amount of disc space and time used by each idcode. In conjunction with this, one data file for each day could be maintained. At the end of the month totals could be accumulated and times reset using the RESET command. Information thus obtained could be used according to the needs of the installation.

Many installations reserve one account for related usage information. For instance, records of each user idcode, password, address, telephone, etc. might be maintained in account U900 while records of installation personnel might be maintained in P000.

## SYSTEM BACKUP SCHEMES

Planning reliable backup procedures is an important facet of system management; and the HIBERNATE and SLEEP commands discussed in Section III are essential to that planning. A system operator can use these commands to initiate an orderly shutdown of the system. Either command causes the entire system to be written to disc storage.

When the HIBERNATE command executes, the contents of all discs are automatically dumped to magnetic tape. If you request verification, the system verifies the transferred data. Since data verification ensures the integrity of your system backup scheme, we recommend that it always be requested. During a hibernate, additional reels of magnetic tape are requested by the system until all discs are completely dumped.

The SLEEP command permits, but does not require, dumping to magnetic tape. If you elect to dump to magnetic tape, only system information and those user programs and files that have been created or changed since the last hibernate operation are transferred. Although backup sleep tapes are optional, their consistent use substantially improves system reliability. Thus if hardware problems make it impossible to regenerate the system from disc, an operator can use the latest sleep and hibernate tapes to recover to the point in time when the last sleep tape was written.

For added reliability, additional copies of either hibernate or sleep tapes can be produced immediately following completion of the original shutdown operation (refer to the HIBERNATE and SLEEP command descriptions). Sound backup schemes include provisions for storing several generations of both hibernate and sleep tapes — to provide additional backup in case the latest tapes are physically damaged or cannot be read. These additional copies should be stored in a place secured against fire, theft, vandalism, etc.

The two types of shutdown procedures are related to the storage capacity of a 2000 System. In a system with very large libraries, hibernating all the libraries is time consuming and can require several reels of tape. In these systems, if most of the libraries are used primarily for storage and are not changed frequently (meaning the elements are referenced but seldom altered), then sleeping the system could be accomplished quickly on a comparatively small amount of magnetic tape. In a small system, or in a system where most libraries are modified frequently, it makes little difference which shutdown command is used.

Frequency of shutdown depends on system application. Where the 2000 System is shut down daily and the hardware used for other purposes, a HIBERNATE or SLEEP command must be used daily. On a dedicated system operating around the clock, some down-time should be scheduled for these operations. But no matter what the application, always sleep the system once daily and hibernate it weekly to ensure that a minimum of work is lost if the system fails. In any case, a 2000 System must be hibernated at least once every six months for proper date verification.

The normal method of restarting an HP 2000 System is to reload from the disc. If it is not possible to read data from the disc, a hibernate tape (or tapes) must be used if the system was last shut down with a HIBERNATE command. If the system was last shut down with a SLEEP command, that sleep tape (tapes) plus the latest hibernate tape (tapes) must be used. If the most recent hibernate and/or sleep tapes cannot be read, the next most recent tapes should be used. Always, the backup tapes are loaded first and then a restore performed using salvage dump tapes (if they exist).

## Organizing Tape Storage.

All tapes written by a single SLEEP or HIBERNATE command must be labeled with the same set number. When more than one tape is required, tapes must be labeled in order, for example:

HIB Set 1, Reel 1  
HIB Set 1, Reel 2  
HIB Set 1, Reel 3

Sleep tapes should be identified as sleep tapes and, if more than one tape is required, kept in sets in the same manner. The number of tape sets stored depends upon the number of tape reels available and upon the amount of space devoted to tape storage.

Note: When loading the system from sleep and/or hibernate sets made up of more than one tape, all tapes must be from the same set and must be loaded in the same order in which they were written.

## Tape Requirements

In the worst hibernate case, 11,750 feet of magnetic tape are required to copy each HP 7920 disc. For comparison, note that an HP 7920 disc contains 65,520 blocks, an HP 2883 pack contains 46,690 blocks, an HP 7905 disc contains 29,592 blocks, and an HP 7900 disc contains 9,744 blocks. The minimum requirement is less than 100 feet if no programs or files exist in the user libraries.

Multiply the appropriate footage by the number of disc drives present to determine the total footage required for the hibernate set. When calculating the number of tape reels required, remember that each reel has 50 feet of leader and trailer (a 2400-foot reel has only 2350 usable feet of tape). In addition, reels may have footage stripped as bad spots develop. Commonly, the first 10 feet of a reel becomes unusable and is discarded, and a new load point marker affixed.

Tape footage required for system SLEEP is normally less than that required for HIBERNATE and can often be a single reel. The length of a sleep tape is determined by the amount of new or changed information on the system. If the system consists of frequently changed files, the set of sleep tapes may be as large as the set of hibernate tapes. In this case, the system backup should be restricted to hibernate tapes.

## Rotating Backup Tapes

Some installations may need to save a copy of sleep and hibernate tapes for long periods of time. The example in figure 7-2 illustrates a tape rotation scheme designed to assure four-week backup. It uses five hibernate sets (labeled H1, H2, H3, H4, and H5) and twenty-five sleep sets (labeled S1 through S25). In the scheme in figure 7-2, a hibernate set is used once every Saturday and a sleep set is used each weekday. Note that the oldest set is always the set that is overwritten.

In an installation where archival storage is not needed, schedules that reduce the requirements for tape storage can be implemented. However, such a reduction is usually accompanied by an increased confusion factor concerning which tape set is to be overwritten.

|        | Sat | Mon | Tues | Wed | Thur | Fri |
|--------|-----|-----|------|-----|------|-----|
| Week 1 | H1  | S1  | S2   | S3  | S4   | S5  |
| Week 2 | H2  | S6  | S7   | S8  | S9   | S10 |
| Week 3 | H3  | S11 | S12  | S13 | S14  | S15 |
| Week 4 | H4  | S16 | S17  | S18 | S19  | S20 |
| Week 5 | H5  | S21 | S22  | S23 | S24  | S25 |
| Week 6 | H1  | S1  | S2   | S3  | S4   | S5  |

Although this schedule provides complete four-week backup and a very simple calendar schedule, it requires a substantial tape inventory which may not be justifiable for all installations.

Figure 7-2. A Four-Week Backup Tape Rotation Scheme

It is desirable in producing tape rotation schedules to consider the possibility of tape read errors occurring. The usual procedure is to ensure that any single tape error will not cause the loss of any file or program that has been on the system more than one day. This requirement is usually coupled with the provision that a disc failure might occur while writing sleep or hibernate sets.

Subject to these constraints, the sample schedule in figure 7-3 has been prepared. It uses eight sets of tapes — the minimum number that can meet all of the requirements. Three of the sets are hibernate tapes labeled H1, H2, and H3 while the other five sets are sleep tapes labeled S1, S2, S3, S4, and S5. (Remember that each set may contain more than one tape.)

In figure 7-3 the first system backup is hibernate H1. At regular intervals the system is hibernated onto the next set in order (H2, H3, H1, H2, etc.), overwriting the contents of the oldest set. Hibernating once a week is recommended; do not exceed six months between hibernates because the date check will no longer operate properly.

In the example, the sleep command is issued each weekday. The tape set used is the oldest sleep set; except that the sleep set last used before a hibernate is saved until one more hibernate is taken. Note the two boxed **S5** entries in figure 7-3 illustrate this point.

### Reloading From Backup Tapes

An operator should always restore the system after a failure by using the most recent sleep and hibernate tapes. Assume that a hardware failure occurs before the S4\*\* tape is written (refer to figure 7-3); and assume that the system must be reloaded from magnetic tape. The first set to be used is S3. If the loader prints UNRECOVERED ENTRIES, ANOTHER SET AVAILABLE? at the end of the set, the operator must mount H1 and type YES at the system console. The remaining user library entries would be recovered from that set.



|        | Sat | Mon | Tues | Wed | Thur | Fri |
|--------|-----|-----|------|-----|------|-----|
| Week 1 | H1  | S1  | S2   | S3  | S4   | S5  |
| Week 2 | H2  | S1  | S2   | S3  | S4   | S1  |
| Week 3 | H3  | S5  | S2   | S3  | S4   | S5  |
| Week 4 | H1  | S1  | S2   | S3  | S4** | S1  |
| Week 5 | H2  | S5  | S2   | S3  | S4   | S5  |

The two-week backup this schedule provides is generally adequate for most installations.

Figure 7-3. A Two-Week Backup Tape Rotation Scheme

**Tape Errors.** If the loader indicates that an entry was lost because of a tape error, that entry might still be recovered from some of the other sleep or hibernate tapes.

**Errors While Reading Sleep Tapes.** Sleep tapes written after the last hibernate tape may contain copies of the lost entry. Always use the most recent tape first. Once a sleep tape is read without any errors, the most recent hibernate tape can be used next.

In the example in figure 7-3, if a tape error occurred while reading tape S3, S2 would be mounted next. If further errors were encountered (unlikely), S1 could be mounted.

**Error While Reading Hibernate Tapes.** Recovery here is similar to the procedures outlined for recovery when errors occur while reading sleep tapes. Always use the most recent set first (the loader demands the correct order). In the example in figure 7-3, an error while reading H1 would indicate that S5 and H3 would be tried. If after reading H3 there were still unrecovered entries, NO would be typed in answer to the UNRECOVERED ENTRIES, ANOTHER SET AVAILABLE? question. (Set H2 could be used in the event that tape errors occurred on both H1 and H3.)

If a tape error occurs, the file or program that is finally recovered is probably an earlier version and it is imperative that the user be notified of this possibility. Also be sure to notify library owners when their elements were unrecoverable and thus were deleted from the system.

## New Systems

If a hibernate tape is not significantly longer than a sleep tape, a situation common for new systems without large data bases, hibernate should be used instead of sleep because of the added backup at minimal cost.



# CONFIGURING THE I/O PROCESSOR

APPENDIX

A

When a new HP 2000 system is generated or when you alter hardware configuration on the existing system, the I/O processor program must be configured accordingly. To do this, you initiate a dialogue with the I/O processor configurator program (IOPC). The IOPC configures the I/O processor based upon your responses.

**Note:** Remember that hardware configuration is altered each time you change the select code of the magnetic tape unit (by moving its controller interface boards to different slots).

During configuration, an optional magnetic tape copy of the configured program can be made. The copy can be written on the master tape (in which case, you can use the master tape for reloading); or it can be written on a separate magnetic tape. Such a copy is suitable for stand-alone reloading and allows you to retain multiple I/O processor configurations.

After configuration is complete, the configurator automatically prints a memory map. However, printing this map is optional if you elect to make a copy of the configured I/O processor program. The map should be filed with other system documentation in the system log book that was supplied with your system. An HP customer engineer will refer to it when diagnosing system problems.

## CONFIGURATION GUIDELINES

Before starting the configuration procedure, you should determine the following:

- Is the I/O processor memory size 16K, 24K, or 32K words? Default is 16K.
- How many timesharing ports will the system include? Default is 32.
- What will be the size of the terminal buffers? Default is 60 words per port (individually configurable).
- What are the I/O select codes for all interface cards?
- Will the system hardware include IBM 2741 Terminals? Default is NO.
- When data communications facility is to be included, what host functions will be configured on this system? The type and number of functions? What are their device assignments?
- What non-sharable devices are to be included? Subtype and record size for each? Maximum record size is listed on the console during configuration dialogue.

The following list may provide some useful guidelines to configuring your system.

1. The configuration options open to you depend upon the amount of memory in the I/O processor. In general, a 16K system can easily support 16 user terminals. In addition, one or two non-sharable devices (line printer, card reader, tape punch) can be supported. This is especially true if the buffer length option is used to reduce the size of terminal buffers. Note that the magnetic tape function has negligible effect on memory in the I/O processor. If only this function is selected, then other options (for example, IBM 2741 support) may be included more easily. Any system including the RJE facility will definitely require at least 24K. If many non-sharable devices coexist with RJE, or if IBM 2741 Terminal support is chosen, 32K may be required.

Reducing the number of supported user terminals can also free much memory. For each terminal removed, approximately 50 words plus two times the terminal buffer size is saved. This memory can be used for other options.

2. The default buffer size for user terminals is 60 words for the following reasons. A line of syntax (a BASIC statement) entered from a terminal will be ignored if it exceeds the size of the input buffer (120 characters or 60 words). However, the user may omit blanks so that a long line of syntax will fit. If a paper tape copy of the program is later produced by the PUNCH command, the 2000 System will re-insert these blanks, and the line of syntax may not fit when the tape is reentered later. A 60-word buffer size reduces the possibility of this conflict. If the problem is of little significance in your installation, you can use a smaller buffer size (for example, 40 words) so as to allow for the inclusion of other features in the I/O processor software.
3. In order to use the 2000 to 2000 communications facility, your system should be configured with the IBM RJE option and should include at least one host reader function and one host lister function. Since the host reader and host lister functions are cross-tied to another 2000 system, it is necessary to have sufficient host lister functions in one system to cover all host reader functions in the other. If insufficient host lister functions are configured at site A, the affected reading functions at site B will not be operable since site A will be unable to accept the data.
4. When assigning real or virtual devices to the host reader functions (with IBM, CDC, or 2000 to 2000 communications), you may specify CR, RP, PR, or JT devices. A card reader/punch/interpreter may be linked to a host reader or host punch device, but not concurrently to both. When assigned to a host reader function, the reading mode is Hollerith to EBCDIC conversion; cards are read from hopper 1 and the stacker overflow mode is used. When a paper tape reader is assigned to a host reader function, ASCII data is read and parity is ignored. When assigning real or virtual devices to host list functions, you may specify LP or JL devices. Acceptable assignments to host punch functions are PP, RP, or JP. When using the card reader/punch/interpreter as a host punch device, blank cards are fed from hopper 1; cards are punched in Hollerith (EBCDIC to Hollerith conversion); and the stacker overflow mode is used.
5. If you select the IBM RJE or 2000 to 2000 communications component and multiple host reader functions are to be supported, some attention should be given to the association of ASCII job function designators (JFD's) with these host reader functions. The I/O processor software tends to give priority to transmissions from HR1 over HR2 over HR3, etc. Therefore, if both JT functions and physical card readers are to be associated with HR functions, it is probably better to assign the JT functions to lower numbered HR functions since they are for use by timesharing programs. Such assignments can later be changed in a running system.
6. It is not necessary to reload the IOP to change synchronous modems. Modem changes between RJE System Disconnect and RJE System Connect may be made as needed.
7. Different I/O processor program configurations may be used on one HP 2000 System at scheduled times. Thus, an IBM RJE I/O processor program may be configured on one stand-alone magnetic tape, while a CDC RJE I/O processor program could be configured on another. These could then be loaded and used at scheduled times. (This loading can only be done after a system shutdown.) Varying configurations for buffer sizes, peripherals, 2741 support, etc., might also be considered.
8. The number of card readers, card reader/punch/interpreter units, line printers, paper tape readers, and paper tape punches and serial link controllers is limited to seven of each, the number of link terminals is limited to 31; a mixture of device subtypes is allowed. Due to hardware considerations, simultaneously using several card readers results in "round-robin" access to each. The appearance is one of card readers taking turns.

Line printers and tape punches compete only for buffer space. Generally, given available memory, these devices should perform well. However, when the system is heavily loaded data communications may suffer since timesharing users are given a higher priority.

9. The mark sense capability of the HP 7261 card reader can be used, including the 40-column card capability. The reject hopper option is not supported.
10. Host functions are numbered relative to 1 in order to provide close association between the names used by the host and the functions in the I/O processor RJE component. Since the 2000 system assigns numbers to its specific device designators and to its job function designators relative to 0, there is an observable difference between the ranges of names used in the two systems. The apparent discrepancy should not cause any problems once you become practiced in using the RJE facility.
11. The IOP program configurator requires that the potential exist for all specified host functions to be simultaneously active. This requirement is met if there exists sufficient job function designators and physical devices (of appropriate types) such that one can be assigned to each host function without repetition. Specifically, this requirement can be stated as follows:
  - The number of Job Transmitters, card readers, card reader/punch/interpreter units, and paper tape readers together must equal or exceed the number of Host Readers.
  - The number of Job Listers and line printers together must equal or exceed the number of Host Listers.
  - The number of Job Punches, paper tape punches, and card reader/punch/interpreter units together must equal or exceed the number of Host Punches.

This ensures that all host functions can have unique devices (job function designators or physical devices) assigned to them concurrently. Note however, it is not mandatory for all host functions to have unique devices. The same device can be assigned to more than one host function simultaneously. In such a case, the host system is blocked from utilizing more than one of these host functions at any given time.

During IOP program configuration a default device must be assigned to each existing host function. In the normal case, a given device would be assigned to only one host function as its default. However, as stated previously, the same device can be the default for two or more host functions. Moreover, a given physical device or job function designator need not be assigned to any host function at all.

In summary: (1) The number of HR's, HL's, and HP's must correspond exactly with the host system's expectations. (2) Each HR, HL, and HP must have a default device (physical device or job function designator) assigned to it at configuration time. (3) Any given device can be the default assignment for none, one, or more than one host function (of the appropriate type). (4) There must exist a way in which devices could be assigned to host functions without repetition.

## DIALOGUE CONVENTIONS

If you respond incorrectly during I/O processor program configuration, the console prints an error message. (These error messages are explained in Appendix B.) You must reenter your response correctly before dialogue can continue.

A carriage return is the default response to any question. A question which may have a NO answer will take a default to mean NO. Any response beginning with Y or N is sufficient for interpretation as YES or NO. Control-H can be used to delete single character errors while control-X can be used to delete an entire response (if struck before the final carriage return of the response). If at any time during the dialogue you wish to abort the configuration procedure, enter a control-G and a carriage return as a response. The IOPC terminates immediately and returns control to the Master Program. In some cases, contradictory or conflicting specifications cause the IOPC to abort. When this happens, a reason is always printed on the system console.

## CONFIGURATION DIALOGUE

When configuring or reconfiguring the I/O processor program, the first step is to load the Master Program from the master tape.

1. Mount the master magnetic tape on the tape drive connected to the main processor. Set the tape at the load point, select unit-0 and press ON-LINE.
2. For 21MX processors, perform the following at the main processor:
  - a. Press HALT and PRESET.
  - b. Select the S-register and clear the display. For 21MX E-series processors, set bits 14 and 0; for other 21MX processors, set bits 15 and 0. Set bits 11 through 6 to the low number (high priority) octal select code of the magnetic tape device controller. Press STORE.
  - c. Select the A-register and clear the display. Set bit 0. Press STORE and IBL. The contents of the magnetic tape loader ROM are loaded into processor memory. Firmware diagnostics are performed automatically on 21 MX E-Series processors.
  - d. Press RUN. The Master Program is read from magnetic tape and the processor displays a 102077<sub>8</sub> halt code.
  - e. Check to be certain the system console is ON (and READY if you are using an HP 2762A console).
  - f. Do not alter the S-register. Rather, select the P-register and clear the display. Set bit 10 (002000<sub>8</sub>).
  - g. Press STORE and RUN. Continue with step 3.

For 2100 processors, perform the following:

Note: See Appendix D to verify you have the proper BBL installed in the I/O processor.

- a. You were supplied a single paper tape containing two programs: a magnetic tape bootstrap loader and cross loader program. Place this tape into the paper tape reader, ensuring the feed holes on the tape are inserted toward the front panel. Set the POWER and READ switches.
- b. On the I/O processor, press HALT, INTERNAL PRESET, and EXTERNAL PRESET.

- c. On the I/O processor, select the P-register and clear the display. Set the bits according to the memory size of your I/O processor as follows:

| memory | location | set bits            |
|--------|----------|---------------------|
| 16K    | 037750   | 13 through 5, 3     |
| 24K    | 057750   | 14, 12 through 5, 3 |
| 32K    | 077750   | 14 through 5, 3     |

- d. On the I/O processor, press **LOADER ENABLE** and then **RUN**. The first program is read from the paper tape and the processor halts with 102077<sub>8</sub> displayed.

Any other halt codes indicate failure to read the paper tape properly. In this case, restart the procedure at step a.

- e. On the main processor, press **HALT**, **INTERNAL PRESET**, and **EXTERNAL PRESET**.
- f. On the main processor, select the P-register and clear the display. Set bits 14 through 6 (077700<sub>8</sub>).
- g. On the main processor, press **LOADER ENABLE** and **RUN**. Nothing happens.
- h. On the I/O processor, select the P-register and clear the display. Set bit 1 (000002<sub>8</sub>).
- i. On the I/O processor, press **RUN**. The second program is read from the paper tape into main processor memory. Both processors halts with 102077<sub>8</sub> displayed. Any other halt codes indicate a failure and the procedure should be restarted at step a.
- j. Check to be certain the system console is **ON** (and **READY** if you are using a 2762A console).
- k. On the main processor, select the P-register and clear the display. Set bit 10 (002000<sub>8</sub>). Press **RUN**.
- l. The system console types **MAG TAPE SELECT CODE?** Respond with the lower number (high priority) octal select code of the magnetic tape device controller. The Master Program is read from the magnetic tape and control is automatically transferred to it.

3. The system console types 2754? Answer **YES** if you are using the HP 2754A/B model teleprinter as a system console. If the console is an HP 2762A, answer **NO** or press *return*.

4. The Master Program now asks **LOAD WHICH MODULE?** You should respond **I/O**.

5. The IOPC is loaded and prints:  
 HP 2000 I/O PROCESSOR CONFIGURATOR  
 RELOAD?  
 Respond **NO** and I/O processor configuration begins.

**Note:** Do not mount or dismount magnetic tapes until specifically instructed to do so.

6. **DATE?**  
 Reply with any text indicating the current date or other identifier for this configuration. Enter 1 to 20 characters of text. Since this information will be printed with the memory map, produced by IOPC, to identify this configuration it will be helpful if you enter the date and system identification.

7. MEMORY SIZE?

Reply 16, 24, or 32 as appropriate. Your response indicates the amount of memory in the I/O processor in thousands of words (multiples of  $1024_{10}$ ). Default is 16.

8. NUMBER OF PORTS?

Respond with the number of ports to be supported by the system. Default is 32.

9. BUFFER LENGTH OPTION?

Answer NO if 60 words per terminal buffer is acceptable and continue at step 10. If other buffer sizes are desired type YES. IOPC continues with:

ENTER PORT NUMBER, BUFFER LENGTH LIST: TERMINATE WITH 'END'

Enter your list in one of the following forms:

*ALL, number of words per buffer*  
(configures all ports)

*port number-port number, number of words per buffer*  
(configures all ports within the range specified)

*port number, number of words per buffer*  
(configures a single port)

Terminate the list of responses by typing END. Note that any respecification of a port will override its prior specification. Thus, ALL, 50 followed by 3,80 will cause all ports except port 3 to have 50 words per buffer. Port 3 will have 80-word buffers. The minimum specification is 40 words and the maximum is 128 words.

10. At this point IOPC requests several select codes:

TIME BASE GENERATOR SELECT CODE?

INTERCONNECT KIT SELECT CODE?

MULTIPLEXER SELECT CODE?

To each of these questions, respond with the appropriate low number (high priority) or only select code for the time base generator, interconnect kit, and multiplexers respectively. If your system has more than 16 ports, two sets of multiplexers are required. The multiplexer boards (six total) must occupy contiguous select codes. Refer to "I/O Processor Configuration" in Section I for an explanation of select code assignments.

11. 2741 TYPE TERMINALS?

Reply YES if IBM 2741 type terminals are to be used with the system. If no 2741 type terminals are to be supported, type NO. If you respond YES these questions follow:

CALL 360 CODE?

EBCD CODE?

Respond YES or NO to each question, (The default is NO.) At least one of these questions must be answered YES. The questions will be repeated until at least one of them receives a YES response. The CALL 360 code is used with an IBM Selectric 2741 having a type ball with part number 1167087. The EBCD code is used with an IBM PTTC/EBCD 2741 having a type ball with part number 1167963. A NO response to either question will result in the exclusion of that code. (An IBM PTTC/BCD 2741 may also be used interchangeably with the PTTC/EBCD version provided the 1167963 type ball is used. However, the keycaps will not correspond to actual printed characters in a few cases.)



## 12. INCLUDE RJE FUNCTION?

Respond YES, NO, or a carriage return (an implied NO), depending upon whether or not you plan to use the data communications facility of your 2000 system.

If you respond NO, the following question is asked:

## NON-SHARABLE DEVICES?

When no non-sharable devices are to be supported, reply NO (the default) and continue at step 15. This question is skipped if you respond YES to the RJE functions query because, in that case, two non-sharable devices are included automatically. These are the job inquiry (JI) and job message (JM) function designators.

If you respond YES to the RJE functions query, additional questions are asked:

## CDC UT200?

Respond YES if the host computer is a CDC system. Respond NO if you intend to use the 2000 to 2000 or 2000 to IBM data communications facility.

## IBM HASP?

Respond YES if you are using the IBM HASP emulator; respond NO if you are using the 2770/2780/3780 emulator.

## IBM 2770/2780/3780?

Respond YES if you are using the 2770/2780/3780 emulator.

## SYNCHRONOUS MODEM INTERFACE SELECT CODE?

Respond with the low number (high priority) select code of the synchronous modem interface.

If you respond NO to the CDC OPTION? prompt, three additional questions are asked:

## NUMBER OF Hx FUNCTIONS?

One question is asked for each type of host function which may be supported: HR, HL, or HP. The responses are dependent upon the configuration of the remote system and should reflect the number of each type of host function to be included. Each function defines a logical path to or from the remote system. (In the CDC case, one HR function and one HL function are included automatically.)

## 13. IOPC now begins to obtain details on the non-sharable devices to be supported. For each type of device, it asks the following series of questions.

## NUMBER OF xx DEVICES?

Respond with the number of devices to be supported. The default response is one. The xx indicates type as follows:

|    |                                                 |                                                           |
|----|-------------------------------------------------|-----------------------------------------------------------|
| MT | magnetic tape units (4 maximum)                 | } One of each assumed if the CDC RJE option was selected. |
| JT | job transmitters (7 maximum)                    |                                                           |
| JL | job listers (7 maximum)                         |                                                           |
| JP | job punches (7 maximum)                         |                                                           |
| JI | job inquiry device (1 assumed if RJE selected)  |                                                           |
| JM | job message device (1 assumed if RJE selected)  |                                                           |
| PR | paper tape readers (7 maximum)                  |                                                           |
| PP | paper tape punches (7 maximum)                  |                                                           |
| LP | line printers (7 maximum)                       |                                                           |
| CR | card readers (7 maximum)                        |                                                           |
| RP | card reader/punch/interpreter units (7 maximum) |                                                           |
| SL | serial link controllers (7 maximum)             |                                                           |
| LT | link terminals (31 maximum)                     |                                                           |

For RP, PP, LP, CR, RP, and SL devices, the select code is requested as follows:

xxn SELECT CODE?

Respond with the appropriate select code for the device. (Refer to Hardware Configuration in Section I for information about assigning select codes.) For LP and CR devices, the subtype of the device will also be requested.

**XX<sub>n</sub> SUBTYPE?**

Respond with the appropriate subtype of the device taken from the following list:

| Type | Subtype | Devices          |
|------|---------|------------------|
| LP   | 0       | 2607, 2610, 2614 |
| LP   | 1       | 2613, 2617, 2618 |
| LP   | 2       | 2767             |
| LP   | 3       | 2778             |
| CR   | 0       | 2892             |
| CR   | 1       | 7261             |

For PR, PP, LP, CR, and RP devices, the default record size in words is requested as follows:

**XX<sub>n</sub> DEFAULT RECORD SIZE? (MAXIMUM IS *xxxx*)**

Respond with the decimal number of words to be used for each record associated with the device in the default case. The *xxxx* in this question indicates the maximum value that may be specified for the particular device in question. A default response (carriage return only) to this question generally results in the maximum value. However, for a magnetic tape device, the default response yields a value of 256. For all devices, 0 is the only unacceptable minimum — but there should be some relationship to the medium involved. For example, consider the amount of data on cards, the width of paper used in printers, etc.

For LT devices the following extra information is requested:

**LT<sub>nn</sub> SERIAL LINK NUMBER (0-6)?**

Respond with the number of the SL device controlling that link terminal.

**TERMINAL'S ADDRESS (1-31)?**

Respond with a decimal number representing the value to which the link terminal's address switch is set.

**OPTIONS (return or I)?**

Respond with I if instruments are to be connected locally to the terminal's HPIB. Otherwise a CR response should be entered. The record size is automatically set to 40 words for devices with the I option and 20 words for devices with the standard option.

- If any data communications facility is included in the system, the default devices to be assigned to the various host functions must be determined. For each defined host functions, the following question is asked:

**H<sub>xx</sub> DEFAULT DEVICE ASSIGNMENT?**

Respond with the appropriate designator corresponding to the device that is to be associated with this host function at the time the I/O processor program is loaded. The specification must be taken from among those devices specified in step 13 (for example, JT0, CR0, PR0, etc.). One word of caution about the HR<sub>n</sub> functions. For the IBM RJE component, greater priority is given to the transmissions for HR1 than for HR2 than for HR3, etc. Therefore, these default device specifications should be made so as to yield the desired performance. (Refer to the "Configuration Guidelines" given previously in this Appendix.)

- MAGNETIC TAPE COPY?**

It is possible for you to make a copy of the configured I/O processor program on the master tape or on a separate stand-alone magnetic tape. If you do not want a copy, respond NO or a carriage return and proceed to step 16. Otherwise, respond YES and the system asks:

**SEPARATE TAPE?**

Respond NO or a carriage return to dump the configured IOP onto the master tape. Respond YES to dump the configured IOP to a stand-alone magnetic tape. (In this case, do not mount a copy tape until the system requests you to do so.)

**16. PRINT CONFIGURATION REPORT?**

We strongly recommend that you respond YES. This produces a printed record (a memory map) of the IOP. A copy of this map should accompany the Problem Report if you submit problems to an HP representative. If you don't want a printed copy of the configured IOP, respond NO or a carriage return. In either case, a copy of the report is automatically written on either the master tape or the separate tape, as the case may be.

**17. The system console prints START IOP PROTECTED LOADER. PRESS RETURN**

**For HP 21MX processors**, perform the following at the I/O processor:

- a. Press HALT and PRESET.
- b. Select the S-register and clear the display. Place the low number (high priority) octal select code of the interconnect kit in bits 11 through 6.
- c. Press STORE and IBL. Firmware diagnostics are performed automatically on 21MX E-series processors.

**HP 2100 processors**, perform the following at the I/O processor:

- a. Press HALT, INTERNAL PRESET, and EXTERNAL PRESET.
- b. Select the S-register and clear the display.
- c. Select the P-register and clear the display. Set bits according to the memory size of your I/O processor as follows:

| memory | location | set bits         |
|--------|----------|------------------|
| 16K    | 037700   | 13 through 6     |
| 24K    | 057700   | 14, 12 through 6 |
| 32K    | 077700   | 14 through 6     |

- d. Press LOADER ENABLE.

Press RUN on the I/O processor. Nothing happens until you press return on the system console. Now the IOPC begins to configure the program. When it has finished, the I/O processor halts with 102077<sub>8</sub> displayed. If no magnetic tape copy is to be produced, IOPC continues at step 19.

**18. The following message will be received if a separate magnetic tape copy is being produced:**

DISMOUNT MASTER TAPE

MOUNT IOP COPY TAPE. PRESS RETURN

Remove the master tape from the tape drive and mount the copy magnetic tape (with a write-enable ring installed). Ready the tape drive and then signal the IOPC to continue by pressing *return*.

When a magnetic tape copy is to be made (on either the master tape or a stand-alone tape), you receive the message:

START IOP AT LOCATION 2002

Never attempt to start the IOP at location 002002<sub>8</sub> until you receive this message. If you do, you will have to configure the IOP again. Select the I/O processor P-register, clear the display and set bits 10 and 1 (002002<sub>8</sub>). For the 21MX only, press STORE. Press RUN. When the tape copy is complete, the I/O processor performs a halt 102077<sub>8</sub>.

19. If no magnetic tape copy of the configured IOP program was made, or if you requested the optional configuration report, then IOPC produces a memory map of the configured IOP program and concludes with the message:

HP 2000 I/O PROCESSOR CONFIGURATION COMPLETE  
(I/O PROCESSOR MAY BE STARTED AT LOCATION 2)

20. To start the I/O processor, select the I/O processor P-register, clear the display and set bit 1 (000002<sub>8</sub>). For the 21MX only, press STORE. Press RUN.

Meanwhile on the system processor, control has returned to the Master Program which again asks LOAD WHICH MODULE? Refer to Section IV to continue generating or updating the system, or to continue performing a magnetic tape or a disc restart (but not a disc bootstrap reload).

```

2754? YES
LOAD WHICH MODULE? I/O

HP2000 ACCESS I/O PROCESSOR CONFIGURATOR
RELOAD?
DATE? 24JAN77
MEMORY SIZE? 32
NUMBER OF PORTS? 24
BUFFER LENGTH OPTION?
TIME BASE GENERATOR? SELECT CODE? 12
INTERCONNECT KIT SELECT CODE? 21
MULTIPLEXER SELECT CODE? 13
2741 TYPE TERMINALS? YES
CALL 360 CODE?
EBCD CODE? YES
INCLUDE RJE FUNCTION? YES
CDC UT200?
IBM HASP?
IBM 2770/2780/3730? YES
SYNCHRONOUS MODEM INTERFACE SELECT CODE? 10
NUMBER OF MT DEVICES? 1
MT0 DEFAULT RECORD SIZE? (MAXIMUM IS 1024)
NUMBER OF JT DEVICES? 1
JT0 DEFAULT RECORD SIZE? (MAXIMUM IS 0066)
NUMBER OF JL DEVICES? 1
JL0 DEFAULT RECORD SIZE? (MAXIMUM IS 0067)
NUMBER OF PR DEVICES? 0
NUMBER OF PP DEVICES? 0
NUMBER OF LP DEVICES? 1
LP0 SELECT CODE? 24
LP0 SUBTYPE? 0
LP0 DEFAULT RECORD SIZE? (MAXIMUM IS 0066)
NUMBER OF CR DEVICES? 1
CR0 SELECT CODE? 23
CR0 SUBTYPE? 0
CR0 DEFAULT RECORD SIZE? (MAXIMUM IS 0080)
NUMBER OF RP DEVICES? 0
NUMBER OF SL DEVICES? 1
SL0 SELECT CODE? 25
NUMBER OF LT DEVICES? 5
LT04 SERIAL LINK NUMBER (0-6) ? 0
TERMINAL'S ADDRESS (1-31) ? 5
OPTIONS (RETURN OR I) ?
LT03 SERIAL LINK NUMBER (0-6) ? 0
TERMINAL'S ADDRESS (1-31) ? 4
OPTIONS (RETURN OR I) ?
LT02 SERIAL LINK NUMBER (0-6) ? 0
TERMINAL'S ADDRESS (1-31) ? 3
OPTIONS (RETURN OR I) ?
LT01 SERIAL LINK NUMBER (0-6) ? 0
TERMINAL'S ADDRESS (1-31) ? 2
OPTIONS (RETURN OR I) ?
LT00 SERIAL LINK NUMBER (0-6) ? 0
TERMINAL'S ADDRESS (1-31) ? 1
OPTIONS (RETURN OR I) ?
HR1 DEFAULT DEVICE ASSIGNMENT? JT0
HL1 DEFAULT DEVICE ASSIGNMENT? JL0
MAGNETIC TAPE COPY? YES
SEPARATE TAPE? YES
PRINT CONFIGURATION REPORT? YES
START IOP PROTECTED LOADER. PRESS RETURN
DISMOUNT MASTER TAPE
MOUNT IOP COPY TAPE. PRESS RETURN
START IOP AT LOCATION 2002

```

Figure A-1. A Sample I/O Processor Configuration Dialogue (Sheet 1 of 3)

## I/O PROCESSOR MEMORY MAP - DATE=24JAN77

| I/O LINKAGE |        |      |       |      |       |
|-------------|--------|------|-------|------|-------|
| S.C.        | DRIVER | I.L. | I.E.  | U.N. | EQT   |
| 10          | D.50   | 1730 | I.50  | 13   | 64730 |
| 11          |        | 1731 | J.50  |      |       |
| 12          | D.43   | 1725 | I.43  | 07   | 64700 |
| 13          | D.51   | 0460 | I.51  | 11   | 64714 |
| 14          | HLT    |      |       |      |       |
| 15          |        | 1726 | K.51  |      |       |
| 16          |        | 0461 | L.51  |      |       |
| 17          | HLT    |      |       |      |       |
| 20          |        | 1727 | N.51  |      |       |
| 21          | D.61   | 0277 | I.61  | 10   | 64706 |
| 21          | D.63   | 0277 | I.61  | 12   | 64722 |
| 21          | D.62   | 0277 | I.61  | 14   | 64736 |
| 22          | HLT    |      |       |      |       |
| 23          | D.110  | 1732 | I.110 | 15   | 64744 |
| 24          | D.120  | 1733 | I.120 | 16   | 64752 |
| 25          | D.530  | 1734 | I.530 | 17   | 64760 |

BASE PAGE LINKS - 00026 - 01734  
 AVAILABLE MEMORY - 65022 - 77677

| ASCII FILES |            |        |      |             |
|-------------|------------|--------|------|-------------|
| L.U.        | DESIGNATOR | SELECT | CODE | RECORD SIZE |
| 00          | LT0        |        | 25   | 0020        |
| 01          | LT1        |        | 25   | 0020        |
| 02          | LT2        |        | 25   | 0020        |
| 03          | LT3        |        | 25   | 0020        |
| 04          | LT4        |        | 25   | 0020        |
| 05          | CR0-0      |        | 23   | 0080        |
| 06          | LP0-0      |        | 24   | 0066        |
| 07          | JL0        |        |      | 0067        |
| 10          | JT0        |        |      | 0066        |
| 11          | MT0        |        | 16   | 0256        |

| HOST     | DEFAULT |
|----------|---------|
| FUNCTION | DEVICE  |
| HR1      | JT0     |
| HL1      | JL0     |

| MODULE MAP |             |       |             |       |             |
|------------|-------------|-------|-------------|-------|-------------|
| MN         | 02000-03651 | DUMP  | 03652-04050 | TBGH  | 04051-04103 |
| ICKH       | 04104-15106 | MUXH  | 15107-15610 | MEMRY | 15611-15762 |
| IOC        | 15763-20012 | D.43  | 20013-20412 | D.61  | 20413-23707 |
| D.51B      | 23710-31212 | D.63  | 31213-32221 | D.62  | 32222-32533 |
| D50IH      | 32534-35435 | D.110 | 35436-35601 | D.120 | 35602-35642 |
| D.530      | 35643-35667 | D.11C | 35670-37262 | D.12C | 37263-40331 |
| D.53C      | 40332-42411 | .2741 | 42412-43337 | .274E | 43340-43540 |
| MNR1H      | 43541-45101 | D.04  | 45102-45442 | ASFH  | 45443-47515 |
| SYNIH      | 47516-53222 | CIOIH | 53223-54362 | HR0IH | 54363-55746 |
| HL0IH      | 55747-57344 | CR0   | 57345-57366 | LP0   | 57367-57407 |
| LT0        | 57410-57444 | LT1   | 57445-57501 | LT2   | 57502-57536 |
| LT3        | 57537-57573 | LT4   | 57574-57630 | CRC   | 57631-60410 |
| LPC        | 60411-61107 | LTC   | 61110-63411 |       |             |

Figure A-1. A Sample I/O Processor Configuration Dialogue (Sheet 2 of 3)

| QIT SUMMARY |       |            |       |            |       |            |       |
|-------------|-------|------------|-------|------------|-------|------------|-------|
| DESIGNATOR  | QIT   | DESIGNATOR | QIT   | DESIGNATOR | QIT   | DESIGNATOR | QIT   |
| TG0         | 63544 | IK0        | 63553 | MX0        | 63562 | AF0        | 63571 |
| SC0         | 63600 | SI0        | 63607 | CI0        | 63616 | HR0        | 63625 |
| HL0         | 63634 | CR0        | 63643 | LP0        | 63652 | LT0        | 63661 |
| LT1         | 63670 | LT2        | 63677 | LT3        | 63706 | LT4        | 63715 |

| ENTRY POINT MAP |       |       |       |       |       |       |       |
|-----------------|-------|-------|-------|-------|-------|-------|-------|
| .ALC.           | 15611 | .ALL  | 03267 | .ATOE | 43653 | .BSY  | 03506 |
| .BUFR           | 16735 | .C11R | 22544 | .CIOT | 20512 | .BTD. | 44377 |
| .COM.           | 63412 | .COMP | 43671 | .DA   | 03433 | .CCO. | 43541 |
| .DEAL           | 03311 | .DTB. | 44440 | .DUMP | 03653 | .DCOM | 44126 |
| .FIND           | 03333 | .FREB | 03061 | .DVTB | 64603 | .ETOA | 43662 |
| .LTC.           | 20255 | .LTS. | 20244 | .GETB | 02737 | .IOC. | 15766 |
| .PUTQ           | 02513 | .RTN. | 15656 | .MEM. | 02003 | .PURQ | 02664 |
| .UNS.           | 17011 | A.SI  | 26572 | .SEEQ | 02555 | .UBSY | 03564 |
| ASFHC           | 46232 | ASFHI | 45524 | ADV   | 31601 | ALB   | 31676 |
| CIOHC           | 53353 | CIOHI | 53223 | ASFHP | 45635 | CDONE | 21266 |
| CONST           | 45523 | CR0HC | 57352 | CIOHP | 53247 | CONSL | 54145 |
| CRCHI           | 57631 | CR0HP | 57350 | CR0HI | 57345 | CRCHC | 60144 |
| D.04            | 45102 | CRCHP | 57656 | CRQ   | 17223 | CTBP2 | 43340 |
| D.11C           | 35670 | D.04? | 45324 | D.04I | 45322 | D.110 | 35436 |
| D.51            | 23710 | D.120 | 35602 | D.12C | 37263 | D.50  | 32534 |
| D.62            | 32262 | D.530 | 35643 | D.53C | 40332 | D.61S | 21376 |
| DMAC2           | 15765 | D.63  | 31236 | DEATH | 23052 | DMAC1 | 15764 |
| DMTOM           | 23001 | DMAXF | 23153 | DRCMP | 23226 | DMTMX | 63541 |
| HR0HI           | 54363 | EATBA | 43670 | FMCG  | 03652 | HL0HP | 55747 |
| I.12C           | 37710 | HR0HP | 54374 | I.110 | 35575 | I.120 | 35604 |
| I.53C           | 40665 | I.43  | 20266 | I.50  | 34436 | I.530 | 35663 |
| ICNVR           | 42412 | I.61  | 21231 | ICKHC | 04714 | ICKHP | 04404 |
| L.51            | 25022 | ISPC  | 21313 | J.50  | 34465 | KDO   | 32040 |
| LPHI            | 61016 | LP0HC | 57374 | LP0HI | 57367 | LPHC  | 60645 |
| LT1HC           | 57452 | LPHP  | 60411 | LT0HC | 57415 | LT0HP | 57413 |
| LT2HP           | 57505 | LT1HI | 57445 | LT1HP | 57450 | LT2HI | 57502 |
| LT4HI           | 57574 | LT3HC | 57544 | LT3HI | 57537 | LT4HC | 57601 |
| LUT51           | 30033 | LT4HP | 57577 | LTCHC | 62355 | LTCHP | 61110 |
| MUXHC           | 15433 | LUT61 | 23250 | MAX   | 23106 | MUXEP | 24750 |
| OMTOM           | 22751 | MUXHI | 15141 | MUXHP | 15262 | N.51  | 27133 |
| P.43            | 20354 | P.110 | 35600 | P.11C | 36203 | P.120 | 35607 |
| P.61            | 22620 | P.50  | 35311 | P.51  | 27325 | P.530 | 35666 |
| PULPT           | 03264 | PANIC | 23017 | PCF   | 31550 | PHO   | 06121 |
| QITND           | 63724 | QHEAD | 17312 | QITAD | 63543 | QITAF | 63727 |
| RJEIN           | 22436 | QITNR | 63725 | QTOP  | 20375 | RDV   | 31621 |
| SIBAF           | 47427 | RJUNS | 32524 | RMTOM | 23006 | RSTRT | 02107 |
| SYNHC           | 51503 | SIBIK | 06227 | SINHP | 51025 | START | 02010 |
| TB0HC           | 04100 | SYNHI | 50013 | SYNHP | 50074 | T.12C | 40266 |
| UCT00           | 32134 | TB0HI | 04051 | TB0HP | 04067 | TB0HQ | 04057 |
| XRB             | 31770 | TB0HQ | 04057 | TB0HQ | 04057 | TTPTR | 02152 |
|                 |       | ULOAD | 21403 | WATSP | 20526 | WORD2 | 23107 |
|                 |       |       |       |       |       | XEQT  | 15763 |

HP2000 I/O PROCESSOR CONFIGURATION COMPLETE  
 (I/O PROCESSOR MAY BE STARTED AT LOCATION 2)

Figure A-1. A Sample I/O Processor Configuration Dialogue (Sheet 3 of 3)

# HALT CODES AND ERROR MESSAGES

APPENDIX

B

The following tables are included in this appendix.

|            |                                           | Page |
|------------|-------------------------------------------|------|
| Table B-1. | Main Processor Halt Codes                 | B-1  |
| Table B-2. | I/O Processor Halt Codes                  | B-3  |
| Table B-3. | Device Status Messages                    | B-4  |
| Table B-4. | Command Error Messages                    | B-5  |
| Table B-5. | Data Communications Error Messages        | B-9  |
| Table B-6. | Master Program Error Messages             | B-10 |
| Table B-7. | I/O Processor Configurator Error Messages | B-11 |
| Table B-8. | System Load/Shutdown Error Messages       | B-13 |
| Table B-9. | Warmstart Failures Messages               | B-17 |

The system halt codes in tables B-1 and B-2 are arranged in numerical order. All other tables are arranged alphabetically.

Table B-1. Main Processor Halt Codes

| HALT CODE | CAUSE/RECOMMENDED ACTION                                                                                                                                                                                                                                                                                                                                                                                                                                                                                                                                                                                                                                                                                                                  |
|-----------|-------------------------------------------------------------------------------------------------------------------------------------------------------------------------------------------------------------------------------------------------------------------------------------------------------------------------------------------------------------------------------------------------------------------------------------------------------------------------------------------------------------------------------------------------------------------------------------------------------------------------------------------------------------------------------------------------------------------------------------------|
| 102000    | <p>Disc reload failure (loader halt). This halt is accompanied by one of the following messages:</p> <p>NOT READY SEL CODE <i>m</i> UNIT <i>n</i><br/>Specified disc drive not ready. Correct the problem and press RUN.</p> <p>READ ERROR SEL CODE <i>m</i> UNIT <i>n</i><br/>Cannot read label on specified disc pack. May be a hardware problem or an unformatted disc. Correct problem and press RUN.</p> <p>PUT DISC <i>d</i> IN SEL CODE <i>m</i> UNIT <i>n</i><br/>Wrong pack is installed on specified drive. Reinstall the correct pack and press RUN.</p> <p>WRONG SYSTEM ID SEL CODE <i>m</i> UNIT <i>n</i><br/>Specified pack is not part of the system specified by logical disc-0. Load the correct pack and press RUN.</p> |
| 102001    | <p>Disc error while attempting to bring up the system (loader halt). Ensure that a system disc is mounted on unit-0 of the controller in select code slot 14. Check that the drive is ready. Restart the entire procedure from the beginning.</p>                                                                                                                                                                                                                                                                                                                                                                                                                                                                                         |

Table B-1. Main Processor Halt Codes (continued)

| HALT CODE                   | CAUSE/RECOMMENDED ACTION                                                                                                                                                                                                                                                                                                                                                                                                                                                                                                                                                                                                                                                                                                                                                                                                                                                                                                                                                                                                                                                                                                                                                                                                                     |
|-----------------------------|----------------------------------------------------------------------------------------------------------------------------------------------------------------------------------------------------------------------------------------------------------------------------------------------------------------------------------------------------------------------------------------------------------------------------------------------------------------------------------------------------------------------------------------------------------------------------------------------------------------------------------------------------------------------------------------------------------------------------------------------------------------------------------------------------------------------------------------------------------------------------------------------------------------------------------------------------------------------------------------------------------------------------------------------------------------------------------------------------------------------------------------------------------------------------------------------------------------------------------------------|
| 102001<br>(continued)       | <p>Load or Dump error (loader halt). When 102001 halt is a load or dump error, it is accompanied by one of the following messages:</p> <p><b>CHECKSUM ERROR, LOAD ABORTED</b><br/>The 2000 System program on the master tape is in error. Call your HP Customer Representative.</p> <p><b>DISC CONFIGURATION CHANGED, LOAD ABORTED</b><br/>During magnetic tape reload using the "alternate allocation option", loader discovers that one of the previously existing discs is missing, the existing disc is a different model (with less storage space), or the existing disc has a different set of locked blocks.</p> <p><b>ILLEGAL ADDRESS, LOAD ABORTED</b><br/>2000 System program on the master tape is incorrect. Call your HP Customer Representative.</p> <p><b>ILLEGAL SYSTEM CODE, LOAD ABORTED</b><br/>During system loading or system update, the loader discovers that the system program is not compatible with the system code.</p> <p><b>INSUFFICIENT TABLE SPACE ALLOCATED, LOAD ABORTED</b><br/>Table space allocation is not sufficient to reload the system from magnetic tape.</p> <p><b>OUT OF DISC SPACE, LOAD ABORTED</b><br/>There is insufficient disc space to accommodate the system and/or system library.</p> |
| 102002                      | <p>Software error (system halt). Refer to "Main Processor Halted" in Section V.</p> <p>Software error (loader halt). Consult your HP Customer Representative.</p> <p>Bootstrap failure (loader halt). A read error occurred while reading disc blocks 1 and 2. Press RUN to retry the read. If unsuccessful, consult your HP Customer Representative.</p>                                                                                                                                                                                                                                                                                                                                                                                                                                                                                                                                                                                                                                                                                                                                                                                                                                                                                    |
| 102011                      | <p>Processor interconnect problem. Refer to "System Recovery-Section V."</p>                                                                                                                                                                                                                                                                                                                                                                                                                                                                                                                                                                                                                                                                                                                                                                                                                                                                                                                                                                                                                                                                                                                                                                 |
| 102015                      | <p>Bit 15 of the switch register is ON when loading from magnetic tape (loader halt). Clear the S-register, press RUN.</p>                                                                                                                                                                                                                                                                                                                                                                                                                                                                                                                                                                                                                                                                                                                                                                                                                                                                                                                                                                                                                                                                                                                   |
| 102015<br>through<br>102027 | <p>Potential disc or magnetic tape problems. Refer to Appendix C and Section V.</p>                                                                                                                                                                                                                                                                                                                                                                                                                                                                                                                                                                                                                                                                                                                                                                                                                                                                                                                                                                                                                                                                                                                                                          |



Table B-1. Main Processor Halt Codes (continued)

| HALT CODE                               | CAUSE/RECOMMENDED ACTION                                                                                                                                                                                                                                                                                                                      |
|-----------------------------------------|-----------------------------------------------------------------------------------------------------------------------------------------------------------------------------------------------------------------------------------------------------------------------------------------------------------------------------------------------|
| 102030,<br>102031                       | Disc-related software problems. Refer to "System Recovery-Section V."                                                                                                                                                                                                                                                                         |
| 102032                                  | Disc hardware malfunction. Refer to Appendix C and Section V.                                                                                                                                                                                                                                                                                 |
| 102033                                  | Positive MWORD, software error. Call your HP Customer Representative.                                                                                                                                                                                                                                                                         |
| 102034                                  | Disc hardware malfunction. Refer to Appendix C and Section V.                                                                                                                                                                                                                                                                                 |
| 102036                                  | Power Fail has occurred. Verify ARS/ $\overline{\text{ARS}}$ switch in correct position.                                                                                                                                                                                                                                                      |
| 102037,<br>102040,<br>102042,<br>102044 | Software errors. If halt occurred during a load or shutdown, recover as for a power failure (halt 103004). Call your HP Customer Engineer. Otherwise, follow recovery procedures outlined in Section V.                                                                                                                                       |
| 102051                                  | Disc error during a warmstart. Repair disc and restart the warmstart procedure.                                                                                                                                                                                                                                                               |
| 102077                                  | Normal halt. Normally no action is needed since the halt resulted from task completion.                                                                                                                                                                                                                                                       |
| 103004                                  | Power failure (loader halt). If failure occurred during a load operation, restart the procedure. If failure occurred during system backup, then: (1) If SYSTEM DUMP OR RELOAD? or MOUNT REEL NUMBER1. PRESS RETURN message has been printed (or has started printing), use a restart from disc procedure. (2) Otherwise, attempt a warmstart. |
| 103005                                  | Parity error. Reset the parity interrupt switch to indicate parity halt. Call your HP Customer Representative.                                                                                                                                                                                                                                |

Table B-2. I/O Processor Halt Codes

| HALT CODE                              | CAUSE/RECOMMENDED ACTION                                                                                       |
|----------------------------------------|----------------------------------------------------------------------------------------------------------------|
| 102005                                 | Parity error. Reset the parity interrupt switch to indicate parity halt. Call your HP Customer Representative. |
| 102002,<br>102010<br>through<br>102076 | Software problems. Refer to "I/O Processor Halted" in Section V.                                               |
| 102077                                 | Normal halt. Normally no action is needed since the halt resulted from task completion.                        |

Table B-3. Device Status Messages

**CR<sub>n</sub> - ATTENTION NEEDED**

There is an illegal hole pattern in the last card read in the output stacker of card reader *n*. Correct the bad card and place it in the input hopper. Ready the reader and restart the user's program via the AWAKE command.

**CR<sub>n</sub> - DEVICE NOT READY**

There is a problem with card reader *n*. It could be out of cards, there might have been a pick failure, or the device is off-line. Correct the condition and then ready the reader.

**CR<sub>n</sub> - DEVICE ERROR**

Card reader *n* has misread the last card. Remove the last card from the output stacker and place it in the input hopper. Ready the reader.

**CR<sub>n</sub> - READ/WRITE FAILURE**

An attempt was made to print data to a card reader.

**JL<sub>n</sub> - READ/WRITE FAILURE**

**JP<sub>n</sub> - READ/WRITE FAILURE**

You attempted to print data to a job lister or job punch device.

**LP<sub>n</sub> - DEVICE NOT READY**

Line printer *n* is either out of paper, the paper is jammed, or the device is off-line. Correct the condition and ready the line printer.

**LT<sub>n</sub> - DEVICE NOT READY**

Link terminal is off-line or power is turned off. Correct the condition and ready the link terminal.

**LT<sub>n</sub> - ATTENTION NEEDED**

There is a problem with restarting an input operation. Correct the problem and restart the user's program via the AWAKE command.

**LT<sub>n</sub> - DEVICE ERROR**

Last input from link terminal was misread due to power failure. If power failure occurred at link terminal, correct the condition then press the RESTART key. Otherwise, correct power failure condition and re-enter the last line of input.

**MT<sub>n</sub> - ATTENTION NEEDED**

The referenced unit is not on-line and at load point; or there was a hardware malfunction; or you attempted to read a blank tape. The user's program is suspended and remains so until you correct the condition and restart the program via the AWAKE command.

**MT<sub>n</sub> - READ/WRITE FAILURE**

There was a power failure; or a timing or parity error occurred during a data transfer; or a user attempted to write on magnetic tape but there is no write ring installed. The condition occurred on magnetic tape unit *n* and is not recoverable by the operator.

**PP<sub>n</sub> - DEVICE NOT READY**

Paper tape punch *n* is out of blank paper tape or the punch is off-line. Correct the condition and ready the device.

**PRO - DEVICE NOT READY**

The paper tape reader is not ready or the tape in the reader has too much leader. Correct the problem and ready the reader.

**PRO - READ/WRITE FAILURE**

A power failure occurred, a tape with incorrect parity was used for a read or print operation, or an attempt was made to print to a paper tape reader. This condition is not recoverable by an operator.

**RP<sub>n</sub> - DEVICE NOT READY**

There is a problem with RP<sub>n</sub>. It could be off-line, powered off, have an empty hopper or full stacker, or there might have been a pick failure. Correct the condition and ready the device.

**RP<sub>n</sub> - ATTENTION NEEDED**

There is an invalid hole pattern in the last card read in the output stacker of RP<sub>n</sub> or an EOF card was not the last card in the input hopper. If the card was bad, correct it and place the new card in the input hopper. Otherwise, punch an EOF card (:: in the first two columns) and place in hopper. Ready the reader/punch/interpreter and restart user's program via the AWAKE command.

Table B-4. Command Error Messages

Specific error messages, along with the commands that generate them, are listed in this table. All commands produce the ILLEGAL FORMAT message when their parameter string is improperly constructed. This message is also generated by some commands when their parameters are properly formed but without meaning in the current system context. The messages listed here usually indicate a grammatically correct command that is refused for the reason explained.

Note: Any command will be ignored if it is entered while bit 0 of the switch register is set (ON). Only RJE commands can be entered while bit 15 of the switch register is set (and bit 0 is OFF). Entering a command other than an RJE command while bit 15 is set (ON) causes the message RJE ONLY.

**ASSIGN**

## NO SUCH DEVICE

The device designator supplied does not correspond to any device in the current system configuration.

**AWAKE**

## DEVICE NOT IN USE

The device designator supplied does not correspond to an allocated device.

## INCORRECT DEVICE

The device designator supplied either corresponds to a device already active or it is not the one that caused a user to be suspended.

## NO SUCH DEVICE

The device designator supplied does not correspond to any device in the current system configuration.

## USER NOT SUSPENDED

Specified user is not suspended by a PAUSE command.

**BANNER**

## DISC ERROR; CAN'T DO IT

The banner message cannot be placed in position due to a disc error.

**BESTOW**

## DUPLICATE ENTRY/ENTRIES

One or more entries cannot be bestowed because their names are already present in the recipient account library.

## INVALID NAME

Entry name specified is not a legal one.

## LIBRARY SPACE FULL

One or more entries cannot be bestowed because the recipient account library has insufficient space to accommodate them.

## NO ENTRIES BESTOWED

No entries found to be bestowed.

## NO SUCH ID

One of the idcodes specified does not exist.

Table B-4. Command Error Messages (Continued)

**BESTOW (cont)**

PROPRIETARY ITEM(S) NOT BESTOWED

One or more entries cannot be bestowed because they are locked or private; or because they are files that were not properly created.

USERS ARE LOGGED ON

Entire account libraries cannot be bestowed while any users are logged on the system. Individual library entries must be bestowed one at a time.

**BREAK**

USER NOT LOGGED ON

No user is logged on the specified port.

**CHANGEID**

NO SUCH ID

The idcode specified does not exist.

**COPY**

DUPLICATE ENTRY

The specified library entry name already exists in the recipient account library.

INVALID NAME

Entry name specified is not a legal one.

LIBRARY SPACE FULL

The recipient account library has insufficient space to accommodate the entry to be copied.

NO SUCH ENTRY

The entry to be copied does not exist.

NO SUCH ID

One of the specified idcodes does not exist.

PROPRIETARY ITEM NOT COPIED

The specified library item is locked or private; or is an improperly created file.

SYSTEM OVERLOAD

The system disc space is insufficient to make a copy of the specified library entry.

UNSUCCESSFUL

The copy failed due to a disc error.

USERS ARE LOGGED ON

A file greater than 200 blocks in length cannot be copied while any users are logged on the system.

Table B-4. Command Error Messages (Continued)

**DUMP (A000)**

## DUMP IS NOT ENABLED

The user dump command has not been enabled via the system console dump command; or it was enabled but the allotted time has expired.

## SWAP AREA CANNOT BE DUMPED BY USER

The portion of system processor memory containing the swap area cannot be dumped. Any requested portion outside this area is dumped.

## UNABLE TO READ ADT TRACK

A disc error prevents dumping an ADT track.

## UNABLE TO READ SWAP TRACK

A disc error prevents dumping a swap track.

**KILLID**

## A000 NOT ALLOWED

Account A000 cannot be killed.

## NO SUCH ID

The specified idcode does not exist.

## USERS ARE LOGGED ON

This command will not execute if any users are logged on the system.

**MLOCK**CAN'T LOCK *fffff* TO *uuuu*

The blocks in the range indicated cannot be locked since they belong to vital system tables or files.

## DISC ERROR; CAN'T DO IT

The locked blocks table for the disc affected by the command cannot be changed due to a disc error.

## ILLEGAL PARAMETER

Some of the blocks specified do not exist, overlap from one disc to another, or are apparently indicated in the wrong order (first block number greater than last block number).

## LOCK FEWER BLOCKS

Unable to process request as stated. Reenter it as a combination of smaller requests.

## LOCKED BLOCKS TABLE FULL

Processing the request would cause overflow of locked blocks table.

## NONEXISTENT DISC

The blocks requested do not exist on any disc in the system configuration.

Table B-4. Command Error Messages (Continued)

**MUNLOCK**

DISC ERROR; CAN'T DO IT  
ILLEGAL PARAMETER  
LOCKED BLOCKS TABLE FULL  
NONEXISTENT DISC

Each of these messages is explained under MLOCK.

**NEWID**

DUPLICATE ENTRY

The specified idcode already exists.

SYSTEM OVERLOAD

The table space allocated for account entries is full.

**PURGE**

BUSY FILES

This command is not accepted if any files are in use.

ILLEGAL PARAMETER

Either the year or day of year is not acceptable as entered.

**RESET**

NO SUCH ID

The specified idcode does not exist.

**RJE**

RJE MESSAGE STILL PENDING

The last-entered RJE message has not yet been accepted by the I/O processor.

Table B-5. Data Communications Error Messages

**RJE COMMAND NOT APPROPRIATE**

The communications line is not connected and therefore the command entered cannot be processed.

**RJE AWAITING PRINTER $n$** **RJE AWAITING PUNCH $n$** 

The messages do not indicate an error. Rather, the communication facility is ready to transmit data to printer  $n$  or to punch  $n$  but the required device is busy or not available. The communication facility waits until the device is not busy or available, but in the interim prints one of the above messages.

**RJE COMMAND ERROR**

The command you issued is not a legal command.

**RJE PRINTER $n$  ATTENTION REQUIRED (bell)****RJE PUNCH $n$  ATTENTION REQUIRED (bell)**

There is a hardware problem with the indicated device. It might be out of paper, out of blank cards, out of blank tape, or off-line. Correct the error condition and ready the device.

**RJE READER $n$  ATTENTION REQUIRED (bell)**

Reader  $n$  has a physical error. For example, the cards might be jammed, or there is no end of input card (::). Correct the problem and ready the reader.

**RJE READER $n$  DATA ERROR (bell)**

The card containing the punch error is the last card in the output stacker of card reader  $n$ . You may correct the card and replace it in the input hopper or you can ignore it. In either case, you must use the RJE Restart Reader command to continue reading the remaining cards.

**RJE SYSTEM DISCONNECTION (TYPE $n$ )**

The RJE function has been disconnected from the remote system. Type  $n$  indicates the reason for the disconnect as follows:

| <u><math>n</math></u> | <u>IBM and 2000 Systems</u>                                 | <u>CDC Systems</u>                                                 |
|-----------------------|-------------------------------------------------------------|--------------------------------------------------------------------|
| 0                     | Normal disconnection by the operator.                       | Normal disconnection by the operator.                              |
| 1                     | Excessive errors (time outs or data checks).                | Line break or other failure in the communications equipment.       |
| 2                     | Line loss or other failure in the communications equipment. | Apparent host failure (no reception from the host for two minutes) |
| 3                     | Host system disconnect                                      | Power failure                                                      |
| 4                     | Excessive buffer overruns or sequence errors*               |                                                                    |
| 5                     | Power failure                                               |                                                                    |

\*Excessive buffer overruns or sequence errors, when connected to a host IBM or Access system, can be caused by improperly specifying the  $n$  parameter (buffer length) in the System Connect command.

Table B-6. Master Program Error Messages

The following error messages can occur during the various system loading sequences or when configuring or loading an I/O processor program from the master tape.

**BAD TAPE FORMAT**

The master tape is improperly constructed or the tape mounted is not in fact a master tape.

**CAN'T USE TAPE**

The master tape cannot be used. (Normally preceded by another diagnostic indicating the reason.)

**ILLEGAL INPUT**

The response given is not among the acceptable choices.

**TAPE BAD**

The master tape contains unreadable information that is needed for the requested operation.

**PUT MAG TAPE UNIT ON-LINE. PRESS RETURN**

The magnetic tape unit is not on-line. Put it on-line and press *return* on the system console.

**WRITE NOT ENABLED. CORRECT AND PRESS RETURN**

Remount the current reel of magnetic tape with a write ring installed and press *return* on the system console.



Table B-7. I/O Processor Configurator Error Messages

The following messages should never occur. If they do, either the hardware is malfunctioning, or the master tape is incorrect. In any event, contact your HP representative.

BINARY FOR xxxxxx IS UNSUPPORTED  
 ENTRY POINT LIST OVERFLOW  
 ERROR IN BINARY FOR ???  
 REQUIRED ENTRY POINT MISSING xxxxxx  
 WARNING -- REQUIRED MODULES MISSING  
 xxxxxx IS A DUPLICATE ENTRY POINT

The following messages can occur during I/O processor program configuration.

#### ANSWER MUST BE YES OR NO

A question requiring a YES or NO answer did not receive such a response. Reenter the answer.

#### AVAILABLE BUFFER SPACE MAY BE INADEQUATE

This message is a warning only; the system will be configured. However, IOPC has determined that the amount of memory remaining for general purpose buffering may be inadequate, especially under heavy loading of the system. This message does not imply terminal user buffers are not available. Rather, other types of buffers, such as non-sharable device buffers, may be in short supply. This message appears after the configuration process rather than during the configuration dialogue.

#### CONFIGURATOR ABORTED

Configuration dialogue was aborted by entering a control-G (G<sup>c</sup>) on the system console.

#### CONFIGURATION EXCEEDS IOP MEMORY *n*

This is a fatal error. The options and specifications that you indicate result in a system which will not fit into the designated memory size for the I/O processor. Either more memory must be obtained or different options must be chosen which result in smaller memory requirements. This message appears while the program modules are being merged rather than during the configuration dialogue. The *n* in the message is either MM or BP to indicate that either main memory or base page respectively has been exhausted.

#### CONFIGURED I/O PROCESSOR NOT PRESENT

No configured copy of an I/O processor program exists on the master tape. An I/O processor program must be configured.

#### Hx FUNCTIONS EXCEED AVAILABLE DEVICES

This is a fatal error. The ASCII files which may be potentially assigned to the Hx functions are not adequate to ensure that every Hx function has a device. Thus, the system is over-configured.

#### ILLEGAL FORMAT

A response was not entered in the required form.

#### ILLEGAL NUMERICS

A response which is expected to contain only numeric characters contains non-numeric characters.

Table B-7. I/O Processor Configurator Error Messages (Continued)

**ILLEGAL OCTAL NUMERICS**

A response which is to be an octal select code contains an 8 or 9 or some non-numeric character. Do not specify the number in decimal terms.

**ILLEGAL SELECT CODE**

A specification for a select code exceeds the range of valid select codes.

**INSERT MAGNETIC TAPE WRITE RING**

**REMount TAPE. PRESS RETURN**

This is not a fatal error. The tape on which the optional IOP program copy is to be made was mounted without a write ring. Insert a write ring, remount the tape, and press return on the system console.

**INSUFFICIENT TAPE FOR IOP COPY**

This is a fatal error. In creating the optional copy of the configured I/O processor program, an insufficient amount of magnetic tape exists on which to make the copy. A larger reel of tape must be used.

**INSUFFICIENT TAPE FOR CONFIGURATION REPORT**

Non-fatal. However, if the configured IOP is being written to a stand-alone tape, a halt 102066<sub>9</sub> occurs. Remount master tape and repeat the configuration process using a longer tape for the stand-alone configured IOP program.

**INVALID TERMINAL ADDRESS**

This message indicates that the terminal address entered was already assigned and is in use. A correct specification must be re-entered.

**IOP IS NOT RESPONDING**

The basic binary loader in the I/O processor has apparently stopped accepting data from IOPC. This error can occur during both the configuration process and the reload process.

**MAX OR MIN EXCEEDED**

A specified value exceeds the range permissible for that value.

**NO IOP COPY - LOAD ABORTED**

You attempted to load a copy of the configured I/O processor program from the master tape but no such copy exists.

**NO SUCH MODULE**

Illegal response to LOAD WHICH MODULE? Response must be I/O, 7900 LOADER, 7920 LOADER, 2883 LOADER, 7905 LOADER, NONE or CONV.

**NOT HP 2000 SYSTEM TAPE**

Magnetic tape mounted is not an HP 2000 system master tape. Mount correct tape.

**SELECT CODE ALREADY ASSIGNED**

This message indicates that a select code just specified has been previously assigned or is a part of a multiple select code device which was previously assigned. The correct specification may be entered, or the IOPC can be aborted using control-G.

**SPECIFICATION NOT AMONG CHOICES**

The option specified was not taken from the available choices for that option.

**TAPE ERROR - LOAD ABORTED**

A tape error occurred while loading a configured I/O processor program from the master magnetic tape.

**UNDEFINED SERIAL LINK**

The serial link number specified does not correspond to any SL device. The correct specification must be re-entered.

Table B-8. System Load/Shutdown Error Messages

The following messages can appear during the various loading sequences or during a system shutdown (HIBERNATE or SLEEP):

**ARE YOU SURE THAT'S TODAY'S DATE?**

The date and/or time entered precede, or are significantly later than, the time when this system was last active.

**BAD DATE ORDER**

During a magnetic tape reload or selective load, an additional set of tapes has a more recent date than the preceding set.

**BAD DELIMITER**

An expected delimiter is missing, not recognized, or has had something else substituted for it in an operator response.

**BAD LOGICAL DISC NUMBER**

Specified logical disc number is illegal or out of range.

**BAD TAPE LABEL**

Alleged first tape of a set of magnetic tapes has a missing, unreadable, or incorrect label.

**CHECKSUM ERROR, LOAD ABORTED**

The HP 2000 System program on the master tape is in error.

**DIRECTORY TRACK LOST, FIRST ENTRY IN *idcode name***

During a salvage dump, one of the directory tracks could not be read. The entries beginning with the named one are not dumped. (Any following entries that were recovered are reported.)

**DISC ALREADY IN USE**

The physical disc specified in a DISC command (select code/unit number) is already in the system configuration.

**DISC 0 MUST BE PRESENT**

Logical disc-0 is not labeled for the 2000 System and the operator did not approve the request to so label it.

**DISC 0 NOT ALLOWED**

Logical disc-0 cannot be referenced in a DISC command.

**DISC *x* NOT READY, LOAD ABORTED**

Logical disc number *x* is not in the ready state (pertains only to 7905 and 7920 disc drives).

**DISC CONTROLLER UNRESPONSIVE, LOAD ABORTED**

The 7905/7920 disc controller is not replying to loader commands.

**DISC ERROR. *idcode name* LOST**

A hibernate, sleep, selective dump, or salvage dump to magnetic tape cannot retrieve the named entry from the disc. The dump continues. This may cause TAPE ERROR. *idcode name* LOST on subsequent use of that tape for system reloading or selective load/restore.

Table B-8. System Load/Shutdown Error Messages (continued)

DISC MAY CONTAIN FEATURES NOT SUPPORTED ON THIS SYSTEM (xxxx VS yyyy)  
DO YOU TAKE RESPONSIBILITY?

During system update, the loader notes that the feature level code of the system on disc is higher than that of the system being loaded. The operator may elect to assure the loader that the disc-resident user library does not contain entries that require features not supported by the system being loaded.

DISC PROTECTED

A FORMAT command references a disc that is protected. Unprotect the physical unit and reenter the command.

DISC RELOAD NOT POSSIBLE

System tables are not consistent. The system cannot be slept or hibernated. Attempt to warmstart the system.

DISC CONFIGURATION CHANGED, LOAD ABORTED

During a magnetic tape reload using the "alternate allocation option", the loader discovers that one of the previously existing discs is missing, is a different model (containing less storage), or has a different set of locked blocks.

ENTRY ALREADY PRESENT

The idcode-name entered for selective loading is already present in the system.

FIRST TAPE TOO SHORT. CORRECT AND PRESS RETURN

The first reel mounted for a system dump to magnetic tape is too short. Mount a longer tape and press *return* on the system console. Discard the reel that was too short.

FOLLOWING ENTRIES NOT FOUND:

*idcode name* DELETED

.  
.  
.

*idcode name* DELETED

A magnetic tape reload or selective load/restore has scanned all submitted tapes but has not found all expected entries. The unrecovered entries are listed. If the operation is a selective restore, some of the listed entries may not have the word DELETED following. This implies that no version was found on the tapes but a previous version remains in the user library.

FORMAT ABORTED

An excessive number of disc errors has occurred while trying to format a disc pack/cartridge. Replace pack/cartridge or run disc diagnostic to determine cause.

ILLEGAL ADDRESS, LOAD ABORTED

The HP 2000 system program on the master tape is incorrect.

ILLEGAL COMMAND

The response to a request for a command is other than NO, a carriage return or one of the commands appropriate at this point.

ILLEGAL DATE

The date was not entered in proper form or is not within the legal range.

Table B-8. System Load/Shutdown Error Messages (Continued)

**ILLEGAL INPUT**

The response to a request was illegal, ill-formed, or otherwise inappropriate.

**ILLEGAL SELECT CODE**

The specified select code is illegal or out of range.

**ILLEGAL SYSTEM CODE, LOAD ABORTED**

During system loading or system update, the loader discovers that the system program is not the one compatible with it.

**ILLEGAL TIME**

The time was not entered in the proper form or is not within the legal range.

**ILLEGAL UNIT NUMBER**

The specified unit number is illegal or out of range.

**INSUFFICIENT TABLE SPACE ALLOCATED, LOAD ABORTED**

The table space allocation is not sufficient to reload the system from magnetic tape. Increase the number of directory or ID tracks and retry.

**INVALID BLOCK NUMBER**

Specified block number is illegal or out of range.

**IOP MAY CONTAIN FEATURES NOT SUPPORTED ON THIS SYSTEM (xxxx' VS yyyy)  
DO YOU TAKE RESPONSIBILITY?**

This message appears during system startup or restart if the loader discovers the system and I/O processor programs were compiled on different dates. The message is a warning that you may be operating with outdated software. *xxxx* reflects the system program compilation date; *yyyy* reflects the I/O processor program compilation date. Respond NO to abort the procedure or YES to continue startup/restart.

**LOCKED BLOCKS TABLE FULL**

The MLOCK command or MUNLOCK command cannot be performed because the locked blocks table is full.

**MOUNT REEL NUMBER *nn*. PRESS RETURN**

During an operation involving loading or dumping magnetic tape, the system requests reel number *nn* of a set of tapes. This is also used as a diagnostic when the reel supplied is incorrect or unreadable. Supply the requested reel and press *return* on the system console.

**MUST RELOAD IOP, LOAD ABORTED**

The I/O Processor program must be reloaded.

**NO ROOM FOR *idcode name***

During a reload or selective load/restore from magnetic tape, a requested library entry cannot be loaded because of a lack of disc space to contain it.

**NO ROOM IN DIRECTORY**

The system directory is full. Additional library entries are not possible. If issued during a selective load/restore, the loader will continue to scan the tapes in search of entries whose directory entries already exist.

Table B-8. System Load/Shutdown Error Messages (continued)

NO SUCH ACCOUNT:

*idcode*

*idcode*

After completing a selective load/restore where ALL was specified, the loader prints a list of all *idcodes* which had entries on the magnetic tapes but no account record in the system.

NO SUCH ENTRY

The entry specified to be dumped does not exist.

NO SUCH ID

The specified *idcode* does not exist.

OUT OF DISC SPACE, LOAD ABORTED

There is insufficient disc space to accommodate the system and/or system library.

RESUMING DUMP AT *idcode name*

Following loss of a directory track during a salvage dump, at least one other directory track can be retrieved. Dumping of the user library resumes with the entry specified.

SYSTEM NOT SLEPT; FOR WARM START ATTEMPT, LOAD MASTER TAPE AND PRESS RETURN. OTHERWISE MUST RELOAD FROM MAG TAPE.

An attempt to perform a disc reload or system update cannot be honored since the system is in an unslept (unknown) state.

TAPE CANNOT BE READ, LOAD ABORTED

An attempt to reload the system from a system dump on magnetic tape cannot be honored due to an inability to read critical portions of the tape.

TAPE BAD. CORRECT AND PRESS RETURN

A write or verify failure occurred during a hibernate, sleep, selective dump, or salvage dump. Supply a useable tape and press *return* on the system console. Discard bad tape; the current reel is rewritten.

TAPE ERROR. *idcode name* LOST

During a magnetic tape reload or selective load/restore, a library entry cannot be recovered from the tape **or** the entry cannot even be identified to determine if it should be recovered.

TAPE MAY CONTAIN FEATURES NOT SUPPORTED ON THIS SYSTEM (xxxx VS yyyy)

DO YOU TAKE RESPONSIBILITY?

During a magnetic tape reload or selective load/restore, the loader notes that the feature level code of the system which produced the tape set is higher than that of the system on which the entries are being loaded. The operator may elect to assure the loader that the entries being loaded do not require any features not supported by the system.

TOO MANY DISC ERRORS, DUMP ABORTED

An attempt to perform a salvage dump, selective dump, hibernate, or sleep encounters an excessive number of otherwise ignorable disc errors.

UNEXPECTED END OF FILE. *idcode name* LOST

An entry on magnetic tape does not correspond with directory expectations during a system reload or selective load/restore.

**UNEXPECTED END OF FILE, LOAD ABORTED**

An end-of-file is found in the system portion of a hibernation or sleep tape during a magnetic tape reload.

**UNRECOVERED ENTRIES. ANOTHER SET AVAILABLE?**

The last set of magnetic tapes used in a system reload or selective load did not supply (or contained unreadable versions of) part of the user library expected to be present.

**Table B-9. Warmstart Diagnostic Messages**

**NOTE**

This table lists warmstart test titles, associated diagnostic messages, and their meanings. In general, when a test fails, follow the procedures outlined in Section V to perform a salvage dump and execute the cold dump routine. Subsequently contact your HP Customer Engineer and give him the completed Problem Report, the cold dump tape, and copies of both the I/O processor memory map and the system console log.

| TEST TITLE | MESSAGE AND MEANING                                                                                                                                  |
|------------|------------------------------------------------------------------------------------------------------------------------------------------------------|
| ADT Check  | <p><b>BAD TRACK LENGTH</b><br/>An ADT track length does not fall within the range -8193 to 0 or is not evenly divisible by 3.</p>                    |
|            | <p><b>BAD DISC ADDRESS</b><br/>The disc address for an ADT track is out of bounds.</p>                                                               |
| IDT Check  | <p><b>BAD TRACK LENGTH</b><br/>An IDT track is positive or not evenly divisible by 12.</p>                                                           |
|            | <p><b>TOO MANY ENTRIES ON TRACK</b><br/>The number of entries exceeds 682.</p>                                                                       |
|            | <p><b>BAD DISC ADDRESS</b><br/>The disc address for an IDT track is out of bounds.</p>                                                               |
|            | <p><b>INCONSISTENT ENTRY</b><br/>The IDEC table entry's idcode is not the same as the first idcode on the corresponding IDT track.</p>               |
|            | <p><b>ENTRY OUT OF ORDER</b><br/>An idcode has been found out of alphabetical order.</p>                                                             |
|            | <p><b>BAD IDCODE</b><br/>An impossible idcode has been found.</p>                                                                                    |
|            | <p><b>BAD TRACK COUNT</b><br/>The number of IDT track entries in the IDT table does not equal the number indicated by the equipment table entry.</p> |

Table B-9. Warmstart Diagnostic Messages (continued)

| TEST TITLE            | MESSAGE AND MEANING                                                                                                                                                                                                             |
|-----------------------|---------------------------------------------------------------------------------------------------------------------------------------------------------------------------------------------------------------------------------|
| Directory Check       | <b>BAD TRACK LENGTH</b><br>A Directory track is positive or not evenly divisible by 12.                                                                                                                                         |
|                       | <b>BAD DISC ADDRESS</b><br>Disc address for a Directory is out of bounds.                                                                                                                                                       |
|                       | <b>TOO MANY ENTRIES ON TRACK</b><br>The number of entries exceeds 682.                                                                                                                                                          |
|                       | <b>INCONSISTENT ENTRY</b><br>First entry on the directory does not match the corresponding DIREC entry.                                                                                                                         |
|                       | <b>ENTRY OUT OF ORDER</b><br>An idcode/name entry is out of alphabetical order.                                                                                                                                                 |
|                       | <b>BAD PROGRAM STARTING ADDRESS</b><br>A program's starting address does not fall in the range 2000 <sub>8</sub> to 26000 <sub>8</sub> .                                                                                        |
|                       | <b>BAD PROGRAM LENGTH</b><br>Program length not between -3 and -24000 <sub>8</sub> .                                                                                                                                            |
|                       | <b>BAD FILE LENGTH</b><br>File length not between 0 and 32767.                                                                                                                                                                  |
|                       | <b>BAD { INITIAL } PSEUDO ENTRY</b><br>Can't find the required psuedo entry.                                                                                                                                                    |
|                       | <b>BAD TRACK COUNT</b><br>The number of Directory track entries in the DIREC table does not equal the product of the equipment table entries for the number of discs on the system and the number of Directory tracks per disc. |
| Disc Space Used Check | <b>INCONSISTENT</b><br>The total disc space used summed from the IDT entries does not equal the total summed from the directory entries.                                                                                        |



# DISC ERRORS

APPENDIX

C

Errors that occur during transfers to and from the disc drives are handled by the system in various ways, depending on the nature of the information that cannot be read or written. Disc errors during the initial phases of a disc reload or bootstrap load are discussed under "Disc Diagnostic Messages" in Section IV. Any other disc error during system loading, system shutdown, or normal system operation causes one of the following messages to be printed on the system console:

```
DISC FAILURE SEEKING TO BLOCK xxxxxx. STATUS yyyyyy
DISC FAILURE READING nn BLOCKS AT xxxxxx. STATUS yyyyyy
DISC FAILURE WRITING nn BLOCKS AT xxxxxx. STATUS yyyyyy
```

(*xxxxxx* = disc block number; *yyyyyy* = hardware status of disc; *nn* = count of disc blocks (length of attempted transfer) Note: If *yyyyyy* = 177777, the disc interface did not respond to the request for disc service.)

While the system is running, disc error messages are queued to be printed whenever the system console is free. Thus notification of disc problems is not always immediately correlated with their occurrence. Certain system failures can cause two or more related error messages to be printed.

## SYSTEM LOADING OR SHUTDOWN DISC ERRORS

When a disc failure occurs during any form of system load or reload, the loader aborts itself by halting the computer. If the cause of the failure can be corrected, do so and restart the procedure originally attempted.

When a disc failure occurs during a sleep or hibernate procedure, the loader either issues a diagnostic message explaining what normal action has been skipped and continues, or it aborts itself by halting the computer. In the latter case, recovery depends on when the failure occurred. If the system has been successfully written to disc (this will be true if either the prompt SYSTEM DUMP OR RELOAD? or MOUNT REEL NUMBER 1. PRESS RETURN has appeared), then it may be possible to fully recover. The operator should attempt a system restart from disc by following the procedures in Section IV and, if successful, perform a sleep or hibernate to obtain a magnetic tape backup. If this also fails, then attempt a warmstart and perform a salvage dump. Perhaps it will be possible to salvage at least the user library. If these measures do not succeed, or if the failure occurred before the system was completely written to disc (no prompt was printed), then the system must be restored from the most recent successful sleep and/or hibernate tape sets.

If a disc error occurs during a warmstart attempt, the message DISC ERROR - CORRECT AND RETRY is printed. Then the main processor halts with 102051<sub>8</sub> displayed. The disc's status will be displayed in the A-register. Repair the disc and restart the warmstart program. If the disc is irreparable without destroying data, you must reload from the latest sleep and hibernate tape sets.

## DISC ERRORS DURING SYSTEM OPERATION

During normal system operation some disc failures can be local in effect and therefore not fatal. Nevertheless, the occurrence of multiple disc failure messages is a warning of potential disaster. In such a case, the next system shutdown had best include a magnetic tape dump to ensure preservation of the user library. Before

resuming system operation, it is advisable to run the general purpose disc diagnostic to isolate the extent of the problem. If only local portions of the disc are unusable, the system can be reloaded from the tapes. However, the operator must request configuration options and MLOCK the areas discovered to be unusable.

If an error occurs while a user is reading or writing one of his own files or programs, the user receives an appropriate diagnostic message. The task is terminated but the system continues to operate. This procedure applies to the user commands SAVE, CSAVE, EXECUTE, GET, CREATE, and APPEND; to executing CHAIN statements; and to reading from or writing to files. The system operator can lock the offending area using the MLOCK command. Because this purges the affected file or program, the operator should usually first attempt to discover if inaccessibility is permanent.

If an error occurs while a user's program is being written to or read from his swap area, that user's port becomes unavailable to any user until the system is reloaded. The user's current program and results are lost but overall system operation is not affected. The user receives the message PORT UNAVAILABLE, and the system console receives the message PORT # nn MADE UNAVAILABLE. Because such disc problems usually come in groups, it is wise to sleep the system as soon as possible and then run the disc diagnostic program to locate the bad disc areas.

Disc errors that occur while system segments or tables are being accessed usually cause the system to attempt an emergency sleep. In some cases involving non-vital information (for example, a directory track read error while a catalog or directory is being printed), the system does not shut down. Nevertheless, such an error indicates a problem with potentially serious effects later. Sometimes disc errors prevent any attempt to salvage the current state of the system. Users are informed of this type of shutdown with the message DISC FAILURE - SYSTEM DOWN.

If the system cannot read a library routine, the list of files in use, the account tables, part of the directory, or some other segment that it needs to continue operations, it prints on the system console any messages remaining in the message queue. Then it attempts to sleep the system to disc. If the sleep is successful, you receive the message DISC FAILURE - SYSTEM EMERGENCY SLEPT and the system shuts down. If the system is unable to complete the emergency sleep, it halts after printing the message DISC FAILURE - RECOVERY MAY BE IMPOSSIBLE. In either case, repair the disc and use the recovery procedures outlined in Section V to restart your system.

If the system has updated a portion of a table in memory, (such as a directory track) but cannot write it back correctly, then the system attempts to write the information in another unused disc area. If successful, it prints any messages remaining in the queue, followed by the notification SYSTEM TRACK MOVE. Although system operation continues, the disc may experience future problems, so it is wise to shut the system down and run the disc diagnostic to locate bad disc areas. If the salvage attempt fails, the system next attempts an emergency sleep as above. In either case, repair the disc and use the recovery procedures outlined in Section V to restart your system.

Certain routines involve updating the very system information needed to perform an emergency sleep. If a disc failure occurs during one of these routines, then the system has lost all knowledge of its own state and cannot attempt any form of recovery. In this case, the system prints any messages remaining in the console queue followed by HARDWARE FAILURE - RECOVERY IMPOSSIBLE. Then the system halts. This action is also taken when one of the other recovery procedures cannot be invoked due to disc errors.

A number of system segments are used for non-vital purposes and therefore do not warrant system shutdown if they become inaccessible. One such segment contains the banner message. Since it is referenced for each user log-on, a loss of access to the banner message produces an annoying number of disc failure messages. However, this does not otherwise impair system operation. Also, the fourth block of each disc contains its locked blocks table. This table is altered only by formatting the disc cartridge/pack, using the cartridge/pack on some other

system that overwrites the table, or issuing MLOCK and MUNLOCK commands. If the message DISC ERROR; CAN'T DO IT is received in response to one of these commands, then the contents of the table must be suspect and should be examined via the STATUS command (after the cause of the disc failure is corrected).

If disc errors occur involving an HP 7905 disc, the disc diagnostic messages printed by the 2000 System display the logical disc status. HP 7905 discs employ two status words designated status-1 and status-2. The status displayed in a diagnostic message is constructed by prefixing bits 12 through 8 of status-1 to bits 7 through 0 of status-2. Bits 15 through 13 of the displayed status are not used.

All disc diagnostics discussed thus far report disc transfer failures. In most cases, a failure causes several retries internally before it is adjudged permanent. If a retry does succeed, the preceding failures are ignored, except that the system operator receives a message of the following form:

```
DISC RETRY READING nn BLOCKS AT xxxxxx. STATUS yyyyyy
DISC RETRY WRITING nn BLOCKS AT xxxxxx. STATUS yyyyyy
```

Such messages do not require a response. However, frequent warnings of disc retries can signal impending trouble on the logical disc involved.



# BBL LOADING

**APPENDIX****D**

When system software operates on a system configured with HP 2100 processors, a special purpose Basic Binary Loader (BBL) must be stored in I/O processor protected memory. Refer to figure D-1 for a listing of the BBL.

To load the BBL, use the Loader/Loader Program (software part number 24353-16001, Revision Level 1615 and up) and follow the instructions in this appendix. These instructions are taken from the manual supplied with the Loader/Loader (manual part number 02100-90200).

1. Enter the following instructions into the given memory locations:

| Memory Address | Instruction       | Source Code    |
|----------------|-------------------|----------------|
| 2765           | 000000            | READ NOP       |
| 2766           | 002500            | CLA, CLE       |
| 2767           | 1037xx (see note) | STC RDR,C      |
| 2770           | 1023xx (see note) | SFS RDR        |
| 2771           | 026770            | JMP *-1        |
| 2772           | 001626            | ELA, ELA       |
| 2773           | 001626            | ELA, ELA       |
| 2774           | 1024xx (see note) | MIA RDR        |
| 2775           | 002040            | SEZ            |
| 2776           | 126765            | JMP READ,I     |
| 2777           | 026767            | JMP READ+2     |
| 3000           | 016765            | START JSB READ |
| 3001           | 073003            | STA *+2        |
| 3002           | 016765            | JSB READ       |

Note: Place your paper tape reader's select code in xx.

2. Place the Loader/Loader paper tape in the reader and make the device ready for operation.
3. Select the P-register and clear the display. Set bits 10 and 9 (003000<sub>8</sub>).
4. In the Switch register, set bits 15-12 to 0111; set bits 11-6 to the low number (high priority) select code of the interconnect kit; set bits 5-0 to the select code of the paper tape reader.
5. Press EXTERNAL PRESET, INTERNAL PRESET, LOADER ENABLE.
6. Press RUN. The Loader/Loader is read in and then configures the BBL loader. The machine halts with 102077<sub>8</sub> displayed.

## Error Halts

- 102001<sub>8</sub> - Illegal select code specified (less than 10<sub>8</sub>). The offending select code is displayed in the A-register.
- 102003<sub>8</sub> - An instruction was not stored correctly - possibly caused by not enabling the loader.

```

0156* VERSION 1.1545
0157*
0158*
0159* (C) COPYRIGHT HEWLETT-PACKARD COMPANY 1975.
0160*
0161* ALL RIGHTS RESERVED. NO PART OF THIS PROGRAM
0162* MAY BE PHOTOCOPIED, REPRODUCED OR TRANSLATED
0163* TO ANOTHER PROGRAM LANGUAGE WITHOUT THE PRIOR
0164* WRITTEN CONSENT OF HEWLETT-PACKARD COMPANY.
0165*
0166*
0167 03700 . ORG 3700B MUST START IN LAST 64 WORDS OF
0168* ODD NUMBERED PAGE
0169*
0170 03700 163774 BBL LDA ICK,I GET INTERCONNECT SELECT CODE
0171 03701 027751 JMP CONFG CONFIGURE I/O INSTRUCTIONS
0172 03702 107700 START CLC 0,C TURN OFF ALL DEVICES
0173 03703 002702 CLA,CCE,SZA PREPARE TO READ TAPE LEADER
0174 03704 063772 CONT LDA M26D 26 FEED FRAMES MEANS EOF
0175 03705 002307 EOTCH CCE,INA,SZA,RSS END OF FILE?
0176 03706 027760 JMP EOT YES
0177 03707 017736 JSB READ NO, READ ONE BYTE
0178 03710 007307 CMB,CCE,INB,SZB,RSS NULL CHARACTER?
0179 03711 027705 JMP EOTCH YES, READ ANOTHER BYTE
0180 03712 077770 STB COUNT NO, MUST BE WORD COUNT
0181 03713 017736 JSB READ READ SECOND BYTE OF WORD
0182 03714 017736 JSB READ READ STARTING ADDRESS
0183 03715 074000 STB A INITIALIZE CHECKSUM
0184 03716 077771 STB ADDR SAVE STARTING ADDRESS
0185 03717 067771 CHECK LDB ADDR IS ADDRESS BEYOND START
0186 03720 047773 ADB MAXAD OF PROTECTED LOADER?
0187 03721 002040 SEZ NO
0188 03722 102055 HLT 55B YES, INVALID ADDRESS
0189 03723 017736 JSB READ READ A WORD
0190 03724 040001 ADA B ADD TO CHECKSUM
0191 03725 177771 STB ADDR,I STORE WORD INTO MEMORY
0192 03726 037771 ISZ ADDR INCREMENT ADDRESS
0193 03727 000040 CLE SET TO READ A FULL WORD
0194 03730 037770 ISZ COUNT ALL WORDS READ?
0195 03731 027717 JMP CHECK NO, CHECK ADDRESS
0196 03732 017736 JSB READ READ CHECKSUM
0197 03733 054000 CPB A CHECKSUMS AGREE?
0198 03734 027704 JMP CONT YES, READ NEXT RECORD
0199 03735 102011 HLT 11B NO, CHECKSUM ERROR
0200 03736 000000 READ NOP
0201 03737 006600 CLB,CME CLEAR BUFFER, FLIP FLAG
0202 03740 103700 IOAD1 STC IOSC,C INITIATE READ OF BYTE
0203 03741 102300 IOAD2 SFS IOSC DONE?
0204 03742 027741 JMP *-1 NO
0205 03743 106400 IOAD3 MIB IOSC YES, MERGE BYTE
0206 03744 002041 SEZ,RSS READ ANOTHER BYTE?
0207 03745 127736 JMP READ,I NO, RETURN
0208 03746 005767 BLF,CLE,BLF YES, POSITION BYTE, CLEAR FLAG
0209 03747 027740 JMP IOAD1 READ NEXT BYTE

```

Figure D-1. Basic Binary Loader (BBL) Listing (Sheet 1 of 2)

```

0211 03750 163775 LDA PTR,I GET PHOTOREADER SELECT CODE
0212*
0213* CONFIGURE I/O INSTRUCTIONS
0214*
0215 03751 043765 CONFIG ADA SFS
0216 03752 073741 STA IOAD2
0217 03753 043766 ADA STC
0218 03754 073740 STA IOAD1
0219 03755 043767 ADA MIB
0220 03756 073743 STA IOAD3
0221 03757 027702 JMP START
0222*
0223 03760 063777 EOT LDA PTRSC SAVE SELECT CODES WHERE CROSS-
0224 03761 067776 LDB ICKSC LOADER CAN FIND THEM
0225 03762 102077 HLT 77B END OF FILE, GOOD HALT
0226 03763 027702 JMP START PRESS 'RUN' TO READ NEXT FILE
0227*
0228* CONSTANTS AND TEMPORARIES
0229*
0230 03764 000000 NOP
0231 03765 102300 SFS SFS IO5C
0232 03766 001400 STC OCT 1400
0233 03767 002500 MIB OCT 2500
0234 03770 000000 COUNT OCT 0 WORD COUNT VARIABLE
0235 03771 000000 ADDR OCT 0 ADDRESS TO BE LOADED VARIABLE
0236 03772 177746 M26D DEC -26 CORRESPONDS TO SYSTEM PROCESSOR
0237 03773 140100 MAXAD ABS -LDRAD LOADER ADDRESS (2'S COMPLEMENT)
0238 03774 003776 ICK DEF ICKSC INTERCONNECT SELECT CODE POINTER
0239 03775 003777 PTR DEF PTRSC PHOTOREADER SELECT CODE POINTER
0240 03776 000000 ICKSC OCT 0 INTERCONNECT RECEIVE SELECT CODE
0241 03777 000000 PTRSC OCT 0 PHOTOREADER SELECT CODE
0242
** NO ERRORS*

```

Figure D-1. Basic Binary Loader (BBL) Listing (Sheet 2 of 2)





# DISC ADDRESS CONVERSION TABLES

APPENDIX

E

The tables in this section may be used to convert hardware disc addresses to their corresponding system block numbers. Since block numbering starts with 0 and is consecutive through all blocks in the system, the first block number of a particular logical disc can be calculated by adding the size, in blocks, of all lower-numbered existing logical discs. The size in blocks for a logical disc follows:

|                   |              |
|-------------------|--------------|
| HP 7900 cartridge | 9744 blocks  |
| HP 7905 cartridge | 29592 blocks |
| HP 7920 pack      | 65520 blocks |
| HP 2883 pack      | 46690 blocks |

Running the general purpose disc diagnostic is the usual method of locating bad sections of a disc cartridge/pack. The MLOCK command is then used to instruct the system to remove these sections from its available disc space. The diagnostic identifies bad sections by a hardware disc address and word count. These must be translated into the starting and ending system block numbers required for the MLOCK command. Calculate the starting block number from the hardware disc address supplied in the diagnostic's error message. Calculate the ending block number from this value and the word count.

To convert a hardware disc address (cylinder, head, and sector) to a starting system block number, proceed as follows:

1. Determine the first block of the logical unit by adding the sizes, in blocks, of all lower-numbered existing logical discs.
2. Determine the first relative block on the cylinder from the tables in this section.
3. Determine the first relative block corresponding to the head from the tables in this section.
4. Determine the block corresponding to the sector from the tables in this section.
5. Add these four numbers together and, if not an integer, truncate the total to the nearest integer.
6. The result is the system block number corresponding to the hardware disc address.

To obtain the ending system block number proceed as follows:

1. Subtract 1 from the word count.
2. Divide this number by 256.
3. Add the quotient to the starting system block number (disregard the remainder).

These two block numbers then become the parameters in an MLOCK command to prevent the system from attempting to utilize the faulty disc areas.

**EXAMPLE**

Assume a mixed-disc configuration consisting of one 7905 cartridge (logical disc-0) and one 2883 pack (logical disc-2). While running the diagnostic on the disc pack, the operator is informed that a faulty area exists at cylinder 47, head 13, sector 7 with a word count of 662. The starting system block number is calculated as follows:

|              |    |   |         |                                      |
|--------------|----|---|---------|--------------------------------------|
| logical disc | 0  | = | 29592   | <i>logical disc-1 does not exist</i> |
| cylinder     | 40 | = | 9200    |                                      |
| cylinder     | 7  | = | 1610    | <i>from tables for 2883 disc</i>     |
| head         | 13 | = | 149 1/2 |                                      |
| sector       | 7  | = | 3 1/2   |                                      |
|              |    |   |         |                                      |
| total        |    | = | 40555   |                                      |

Thus the starting system block number is 40555. The word count was 662, so after subtracting 1 we have  $661/256 = 2$  and  $40555+2 = 40557$ , the ending system block number. Thus when the opportunity to issue MLOCK commands occurs during the loading sequence, the correct command is:

MLOCK - 40555,40557

Table E-1. HP 2883 Disc Relative Block Numbers

| CYLINDER<br>NUMBER | FIRST<br>RELATIVE BLOCK | HEAD<br>NUMBER | FIRST<br>RELATIVE BLOCK | SECTOR<br>NUMBER | FIRST<br>RELATIVE BLOCK |
|--------------------|-------------------------|----------------|-------------------------|------------------|-------------------------|
| 0                  | 0                       | 0              | 0                       | 0                | 0                       |
| 1                  | 230                     | 1              | 11 1/2                  | 1                | 0 1/2                   |
| 2                  | 460                     | 2              | 23                      | 2                | 1                       |
| 3                  | 690                     | 3              | 34 1/2                  | 3                | 1 1/2                   |
| 4                  | 920                     | 4              | 46                      | 4                | 2                       |
| 5                  | 1150                    | 5              | 57 1/2                  | 5                | 2 1/2                   |
| 6                  | 1380                    | 6              | 69                      | 6                | 3                       |
| 7                  | 1610                    | 7              | 80 1/2                  | 7                | 3 1/2                   |
| 8                  | 1840                    | 8              | 92                      | 8                | 4                       |
| 9                  | 2070                    | 9              | 103 1/2                 | 9                | 4 1/2                   |
| 10                 | 2300                    | 10             | 115                     | 10               | 5                       |
| 20                 | 4600                    | 11             | 126 1/2                 | 11               | 5 1/2                   |
| 30                 | 6900                    | 12             | 138                     | 12               | 6                       |
| 40                 | 9200                    | 13             | 149 1/2                 | 13               | 6 1/2                   |
| 50                 | 11500                   | 14             | 161                     | 14               | 7                       |
| 60                 | 13800                   | 15             | 172 1/2                 | 15               | 7 1/2                   |
| 70                 | 16100                   | 16             | 184                     | 16               | 8                       |
| 80                 | 18400                   | 17             | 195 1/2                 | 17               | 8 1/2                   |
| 90                 | 20700                   | 18             | 207                     | 18               | 9                       |
| 100                | 23000                   | 19             | 218 1/2                 | 19               | 9 1/2                   |
| 110                | 25300                   |                |                         | 20               | 10                      |
| 120                | 27600                   |                |                         | 21               | 10 1/2                  |
| 130                | 29900                   |                |                         | 22               | 11                      |
| 140                | 32200                   |                |                         |                  |                         |
| 150                | 34500                   |                |                         |                  |                         |
| 160                | 36800                   |                |                         |                  |                         |
| 170                | 39100                   |                |                         |                  |                         |
| 180                | 41400                   |                |                         |                  |                         |
| 190                | 43700                   |                |                         |                  |                         |
| 200                | 46000                   |                |                         |                  |                         |

Table E-2. HP 7900 Disc Relative Block Numbers

| CYLINDER<br>NUMBER | FIRST<br>RELATIVE BLOCK | HEAD<br>NUMBER | FIRST<br>RELATIVE BLOCK | SECTOR<br>NUMBER | FIRST<br>RELATIVE BLOCK |
|--------------------|-------------------------|----------------|-------------------------|------------------|-------------------------|
| 0                  | 0                       | 0              | 0                       | 0                | 0                       |
| 1                  | 48                      | 1              | 12                      | 1                | 0 1/2                   |
| 2                  | 96                      | 2              | 24                      | 2                | 1                       |
| 3                  | 144                     | 3              | 36                      | 3                | 1 1/2                   |
| 4                  | 192                     |                |                         | 4                | 2                       |
| 5                  | 240                     |                |                         | 5                | 2 1/2                   |
| 6                  | 288                     |                |                         | 6                | 3                       |
| 7                  | 336                     |                |                         | 7                | 3 1/2                   |
| 8                  | 384                     |                |                         | 8                | 4                       |
| 9                  | 432                     |                |                         | 9                | 4 1/2                   |
| 10                 | 480                     |                |                         | 10               | 5                       |
| 20                 | 960                     |                |                         | 11               | 5 1/2                   |
| 30                 | 1440                    |                |                         | 12               | 6                       |
| 40                 | 1920                    |                |                         | 13               | 6 1/2                   |
| 50                 | 2400                    |                |                         | 14               | 7                       |
| 60                 | 2880                    |                |                         | 15               | 7 1/2                   |
| 70                 | 3360                    |                |                         | 16               | 8                       |
| 80                 | 3840                    |                |                         | 17               | 8 1/2                   |
| 90                 | 4320                    |                |                         | 18               | 9                       |
| 100                | 4800                    |                |                         | 19               | 9 1/2                   |
| 110                | 5280                    |                |                         | 20               | 10                      |
| 120                | 5760                    |                |                         | 21               | 10 1/2                  |
| 130                | 6240                    |                |                         | 22               | 11                      |
| 140                | 6720                    |                |                         | 23               | 11 1/2                  |
| 150                | 7200                    |                |                         |                  |                         |
| 160                | 7680                    |                |                         |                  |                         |
| 170                | 8160                    |                |                         |                  |                         |
| 180                | 8640                    |                |                         |                  |                         |
| 190                | 9120                    |                |                         |                  |                         |
| 200                | 9600                    |                |                         |                  |                         |

Table E-3. HP 7905 Disc Relative Block Numbers

| CYLINDER<br>NUMBER | FIRST<br>RELATIVE BLOCK | HEAD<br>NUMBER | FIRST<br>RELATIVE BLOCK | SECTOR<br>NUMBER | FIRST<br>RELATIVE BLOCK |
|--------------------|-------------------------|----------------|-------------------------|------------------|-------------------------|
| 0                  | 0                       | 0              | 0                       | 0                | 0                       |
| 1                  | 72                      | 1              | 24                      | 1                | 0 1/2                   |
| 2                  | 144                     | 2              | 48                      | 2                | 1                       |
| 3                  | 216                     |                |                         | 3                | 1 1/2                   |
| 4                  | 288                     |                |                         | 4                | 2                       |
| 5                  | 360                     |                |                         | 5                | 2 1/2                   |
| 6                  | 432                     |                |                         | 6                | 3                       |
| 7                  | 504                     |                |                         | 7                | 3 1/2                   |
| 8                  | 576                     |                |                         | 8                | 4                       |
| 9                  | 648                     |                |                         | 9                | 4 1/2                   |
| 10                 | 720                     |                |                         | 10               | 5                       |
| 20                 | 1440                    |                |                         | 11               | 5 1/2                   |
| 30                 | 2160                    |                |                         | 12               | 6                       |
| 40                 | 2880                    |                |                         | 13               | 6 1/2                   |
| 50                 | 3600                    |                |                         | 14               | 7                       |
| 60                 | 4320                    |                |                         | 15               | 7 1/2                   |
| 70                 | 5040                    |                |                         | 16               | 8                       |
| 80                 | 5760                    |                |                         | 17               | 8 1/2                   |
| 90                 | 6480                    |                |                         | 18               | 9                       |
| 100                | 7200                    |                |                         | 19               | 9 1/2                   |
| 110                | 7920                    |                |                         | 20               | 10                      |
| 120                | 8640                    |                |                         | 30               | 15                      |
| 130                | 9360                    |                |                         | 40               | 20                      |
| 140                | 10080                   |                |                         |                  |                         |
| 150                | 10800                   |                |                         |                  |                         |
| 160                | 11520                   |                |                         |                  |                         |
| 170                | 12240                   |                |                         |                  |                         |
| 180                | 12960                   |                |                         |                  |                         |
| 190                | 13680                   |                |                         |                  |                         |
| 200                | 14400                   |                |                         |                  |                         |
| 300                | 21600                   |                |                         |                  |                         |
| 400                | 28800                   |                |                         |                  |                         |

Disc Address Conversion Tables

Table E-4. HP 7920 Disc Relative Block Numbers

| CYLINDER<br>NUMBER | FIRST<br>RELATIVE BLOCK | HEAD<br>NUMBER | FIRST<br>RELATIVE BLOCK | SECTOR<br>NUMBER | FIRST<br>RELATIVE BLOCK |
|--------------------|-------------------------|----------------|-------------------------|------------------|-------------------------|
| 0                  | 0                       | 0              | 0                       | 0                | 0                       |
| 1                  | 120                     | 1              | 24                      | 1                | 0 1/2                   |
| 2                  | 240                     | 2              | 48                      | 2                | 1                       |
| 3                  | 360                     | 3              | 72                      | 3                | 1 1/2                   |
| 4                  | 480                     | 4              | 96                      | 4                | 2                       |
| 5                  | 600                     |                |                         | 5                | 2 1/2                   |
| 6                  | 720                     |                |                         | 6                | 3                       |
| 7                  | 840                     |                |                         | 7                | 3 1/2                   |
| 8                  | 960                     |                |                         | 8                | 4                       |
| 9                  | 1080                    |                |                         | 9                | 4 1/2                   |
| 10                 | 1200                    |                |                         | 10               | 5                       |
| 20                 | 2400                    |                |                         | 20               | 10                      |
| 30                 | 3600                    |                |                         | 30               | 15                      |
| 40                 | 4800                    |                |                         | 40               | 20                      |
| 50                 | 6000                    |                |                         |                  |                         |
| 60                 | 7200                    |                |                         |                  |                         |
| 70                 | 8400                    |                |                         |                  |                         |
| 80                 | 9600                    |                |                         |                  |                         |
| 90                 | 10800                   |                |                         |                  |                         |
| 100                | 12000                   |                |                         |                  |                         |
| 200                | 24000                   |                |                         |                  |                         |
| 300                | 36000                   |                |                         |                  |                         |
| 400                | 48000                   |                |                         |                  |                         |
| 500                | 60000                   |                |                         |                  |                         |

# CONVERT (HP 2000 FILE CONVERSION PROGRAM)

APPENDIX

F

CONVERT is a utility program supplied on the master tape. It allows you to:

- restore 2000/F and 2000C (High Speed Option) files onto a slept HP 2000 Operating System.
- dump HP 2000 BASIC formatted files onto magnetic tape in 2000/F dump format.

The CONVERT program resides on the master tape in three versions. The program may be invoked by answering CONVERT to the LOAD WHICH MODULE? message and answering YES to one of the disc messages.

## CONVERT OPERATING PROCEDURE

1. Load the Master Program using procedures outlines in Section IV under the heading "Master Program Loading."
2. Respond CONVERT (can be shortened to CONV) to the LOAD WHICH MODULE? message. After the module is loaded from the magnetic tape an introductory message 2000 FILE CONVERSION PROGRAM is printed.
3. Answer affirmatively to one of the disc messages DISC-0 a 7905 or 7920?, 7900? or 2883?. The appropriate version is now loaded from tape.
4. The file conversion program prints "F" RESTORE OR DUMP COMMANDS?. Respond NO or a carriage return if you want to terminate the program. Otherwise, enter RESTORE or DUMP. The two commands are equivalent to the ones in the loader and are discussed in detail in Sections IV & VII.
5. The message ENTER NAME LIST, ONE PER LINE; TERMINATE WITH 'END' is printed. Response requirements are the same as for the loader with the following exceptions:

### RESTORE

- a. Your response must name a file, not a program.
  - b. If found on the tape, a legal 2000/F or 2000C (High Speed Option) name which is an illegal 2000 name may be entered but a legal 2000 name will be requested before the entry is loaded.
  - c. The message *id name* ILLEGAL NAME, ENTER ALTERNATE NAME is printed whenever an entry to be loaded has an illegal 2000 name. The response should be a legal 2000 name which does not already exist in the account.
6. When the restore or dump completes, the conversion program prints "F" RESTORE OR DUMP COMMANDS?. Respond accordingly if you desire to continue to restore or dump. If you are done, respond NO or just a carriage return. The conversion program prints END OF PROGRAM before terminating with a HALT (102077<sub>8</sub>).
  7. The system is now in the same state it would be in after a system sleep.

## RESTORE EXAMPLE

```
2754? NO
LOAD WHICH MODULE? CONVERT
HP 2000 FILE CONVERSION PROGRAM

DISC-0 A 7905 OR 7920? NO

7900? Y
"F" RESTORE OR DUMP COMMANDS? RESTORE
ENTER NAME LIST, ONE PER LINE; TERMINATE WITH 'END'
A000
A001
B000,B-INP0
B000,B-INU0
B000,BPRU0
C000
NO SUCH ID
END
MOUNT REEL NUMBER 1. PRESS RETURN
B000 B-INP0 ILLEGAL NAME
ENTER ALTERNATE NAME
BXINP0

B000 B-INU0 ILLEGAL NAME
ENTER ALTERNATE NAME
BXINU0

"F" RESTORE OR DUMP COMMANDS? return
END OF PROGRAM
```

Figure F-1. Conversion Dialogue — Restore Example

## DUMP EXAMPLE

```
"F" RESTORE OR DUMP COMMANDS? DUMP
ENTER NAME LIST, ONE PER LINE; TERMINATE WITH 'END'
A000
B000
A001
B001
C000
NO SUCH ID
END
MOUNT REEL NUMBER 1. PRESS RETURN
VERIFY? Y
MOUNT REEL NUMBER 2. PRESS RETURN
VERIFY? Y
DONE

"F" RESTORE OR DUMP COMMANDS? return
END OF PROGRAM
```

Figure F-2. Conversion Dialogue — Dump Example

*Note: It is possible to create a 2000/F tape with a file containing a string of greater than 72 characters in length. In this case an F program can read only the first 72 characters of the string.*



## FILE PROTECTION

In converting between HP 2000 and 2000/F, file security is assigned as indicated in the following tables. Table F-1 shows the security provisions for restoring 2000/F files onto an HP 2000 Operating System. (e.g., an unprotected 2000/F file becomes protected in a 2000 group master account and locked in a 2000 non-group master account.) Table F-2 shows the security provisions for a dump from HP 2000 BASIC formatted files onto magnetic tape in 2000/F dump format.

Table F-1. Security After RESTORE From 2000/F Files

| 2000/F      | HP 2000      |                  |
|-------------|--------------|------------------|
|             | Group Master | Non-Group Master |
| unprotected | protected    | locked           |
| protected   | locked       | —                |

Table F-2. Security After DUMP From HP 2000 BASIC Formatted Files

| HP 2000      | 2000/F       |                  |
|--------------|--------------|------------------|
|              | Group Master | Non-Group Master |
| unrestricted | unprotected  | unprotected      |
| protected    | unprotected  | unprotected      |
| locked       | protected    | unprotected      |
| private      | protected    | unprotected      |



# GLOSSARY

8 bits = 1 byte  
2 bytes = 1 word  
2 characters = 1 word  
256 words = 1 block  
1K = 1024<sub>10</sub>

## **2000 to 2000 communications**

The mode of operation that allows transmission of data from one 2000 system to another. 2000 to 2000 uses the RJE resources.

## **ASCII**

ASCII stands for the American Standard Code for Information Interchange. This standard is maintained by the American National Standards Institute (ANSI).

## **Available Disc Table (ADT)**

A table, maintained by the system, used to record the locations and amounts of unused portions of disc space. To determine the location of ADT tracks, use the STATUS command.

## **block**

The smallest quantum of disc space addressed by the 2000 System. A block consists of 256 words.

## **bit**

A single digit in a binary number, or in the recorded representation of such a number (by hole punches, magnetic states, etc.). The digit can have one of two values: 0 or 1. When a bit has a value of 1, it is said to be "set"; when it has the value 0, it is said to be "clear" or "off".

## **BMDL**

Basic Moving-Head Disc Loader is a program used to load from disc into memory other programs that were prepared with absolute addresses. On HP 2100 processors, the BMDL is memory resident and hardware protected. HP 21MX processors may contain a BMDL on an optional ROM.

## **byte**

The amount of storage required to store one character is called a byte. A byte is comprised of eight bits. Two bytes equal one word.

## **character**

The general term includes all symbols such as alphabetic letters, numerals, punctuation marks, mathematical operators, etc. Also, the coded representation of such symbols. Two characters equal one word.

## **Cold Dump Routine**

A memory-resident program used for identifying software problems while preserving system information.

## **command**

A command instructs the 2000 System to perform certain control or utility functions, such as logging on the system and listing programs. A command instructs the system to perform some action immediately, while a statement is an instruction to perform an action only when the program executes.

**DCPC**

Dual-Channel Port Controller provides a direct path, software assignable, between memory and a high-speed peripheral. DCPC is optionally available on HP 21MX processors. (See also DMA).

**Device Designator, General**

The term **general device** applies to the type of I/O device. Designators used to represent the types are: LP (line printer), CR (card reader), RP (card reader/punch/interpreter unit), PR (paper tape reader), MT (magnetic tape unit), PP (paper tape punch), JT (job transmitter), JL (job line printer), JP (job punch), JI (job inquiry device), and JM (job message device). Refer also to JFD.

**Device Designator, Specific**

The term **specific device** applies to one particular peripheral device within a system. The designator is the General Device Designator with a number appended, for instance, LP0 or CR1. Numbers are assigned at system generation. Refer also to JFD.

**diagnostic**

Relating to test programs used for detecting errors in hardware or software, or the messages resulting from such tests.

**diagnostic message**

A message from the system that provides the user with useful information.

**directory**

A table within the HP 2000 System that records all library programs and files, including the name, disc location, last date referenced, and other information. To determine the location of directory tracks, use the STATUS command.

**disc**

A mass storage device used to store the HP 2000 System and user libraries. A disc is defined here as a moving-head, rotating disc memory.

**DMA**

Direct Memory Access. DMA allows data to be transferred directly between a peripheral and the computer memory, in either direction. DMA is optionally available on HP 2100 processors. Refer also to DCPC.

**dump**

To record memory contents on an external medium, for example, magnetic tape.

**Emergency Sleep**

A sleep performed automatically by the system after a disc problem develops. Following an Emergency Sleep the system halts.

**FCP**

File Create/Purge. Used in the NEWID and CHANGEID commands to endow a group master account with FCP capability—making it possible for that group master's locked or private programs to create, read, write, or purge locked BASIC-formatted files (subject to individual accessing restrictions) in the library of any group member whose account has the Program/File Access (PFA) capability. A group master's locked or private programs may also CHAIN to specified lines in locked programs resident in his members' libraries.

**format**

A predetermined arrangement of bits or characters.

**Group Library**

A collection of data files and BASIC language programs stored by a user whose idcode ends in 00. The programs and files are generally available to all users having idcodes with the same first letter and first digit as the group master.

**HIBERNATE the system**

Issuing a HIBERNATE command through the operator console causes the system to log all current users off the system and dump a copy of itself onto disc and onto a magnetic tape. The hibernate command writes a complete copy of the system and all user programs and files to magnetic tape.

**host computer**

A computer centrally connected to a network of smaller computers. The host computer provides services such as computation, data base access, special application programs or programming languages.

**idcode**

An alphanumeric code consisting of one letter and three digits. Each idcode has associated with it an optional password, the amount of terminal time allowed, the amount of terminal time used, the amount of disc space allowed, the amount of disc space used, the account accessing capability, and I/O device accessing capability. Each user on a terminal must have an idcode. However, several users can sign on the system at the same time using the same idcode.

**IDT**

A table within the HP 2000 System that records all legal idcodes along with their current time and disc space (both allotted and used), password, accessing capabilities, etc. To determine the location of the IDT tracks, use the STATUS command.

**IOPC**

Input/Output Processor Configurator. The IOPC is an independent part of system software. It configures the I/O processor according to operator responses.

**input**

Information transferred from a peripheral device into the computer. Also can apply to the transfer process itself.

**JFD**

Job Function Designator. A special class of device designators used to access the data streams of a host system. Use of JFD's as files allows a BASIC program to simulate the physical I/O devices normally employed to send/receive data to/from a host computer.

**Logon and Logoff**

Whenever a user types a HELLO command on his terminal, he must enter the correct idcode, password, and optionally the terminal sub-type code. He is then logged onto the system and time begins accumulating on his idcode. Whenever a user types a HELLO or BYE command while logged on, or disconnects from his modem, he is logged off the system. Messages are printed on the system console to record these events.

**loop**

A sequence of instructions in which the last instruction causes a jump back to the first instruction of the sequence.

**modem**

Modulator-Demodulator. A device that modulates signals transmitted over communication circuits. A data set.

**MWA**

Multiple-Write Access. When a file has been assigned MWA status more than one user can access and write on the file at the same time. Also, MWA is the account accessing capability an operator can assign via the NEWID and CHANGEID commands. An idcode must be assigned MWA capability by the operator before an owner can assign MWA status to his files.

**Non-sharable Device**

Any peripheral that cannot be utilized by several programs executing concurrently. For example, a line printer is a non-sharable device because it prints output for one user at a time, while a disc device is sharable because it can be used by many programs executing concurrently. Once a user is granted control of a non-sharable device, no other user can perform I/O on the same device until the first user's operation has terminated (or aborted).

**octal**

Denoting a numbering system based on the radix eight. Octal digits are restricted to 0 through 7 (inclusive).

**off-line**

Pertaining to equipment or devices not under control of a central computer.

**on-line**

Pertaining to the operation of peripheral equipment under central computer control.

**Operator**

The person responsible for generating, monitoring, controlling access to, and shutting down an HP 2000 System. The person carries out these functions by entering commands on the system console.

**Operator commands**

The operator types commands on the system console to control an HP 2000 System. Commands modify system tables, obtain reports, cause system backup to be initiated, etc.

**password**

A combination of up to six characters, printing or non-printing, that is optionally associated with each idcode. If a password has been assigned, it must be included in the HELLO command when a user logs on the system.

**PFA**

Program/File Access. An idcode can be designated to have PFA via the NEWID and CHANGEID commands. As a result, the programs and files within that idcode library can be accessed to the limit of their restrictions by all users.

**port**

A port is defined to be the multiplexer connector and the internal hardware associated with a terminal.

**Recovery**

The act of restarting a dead system from disc with no lost data; i.e., it is not necessary to use backup tapes to restart a system.

**Remote Job Entry (RJE)**

The mode of operation that allows transmission of a job from a local input device to a host computer via a communication link. Also, this mode of operation allows receipt of output on an I/O device at a remote site.

**ROM**

Read Only Memory. Static semi-conductor memory within HP 21MX computers.

**routine**

A program or program segment designed to accomplish a single function.

**Salvage Dump**

A selective dump to magnetic tape, performed after Warmstart determines an automatic restart is impossible.

**Select Code**

A number assigned to input/output processor channels for purposes of identification. Each processor I/O slot is assigned a fixed address called a select code. The computer communicates with an I/O device on the basis of its select code.

**SLEEP the system**

Issuing a SLEEP command through the system console causes the system to log all current users off the system and dump a copy of itself onto disc and optionally onto a magnetic tape. The system can be restarted from the disc or from the magnetic tape copy. A SLEEP command copies only those programs and files changed since the last HIBERNATE was executed.

**software**

Computer programs. Also, the tapes or cards on which the programs are recorded.

**SWA**

Single-Write Access. Every user file has SWA status unless the owner assigns it MWA status. The Single-Write Access status allows only one user at a time to write to the file.

**system console**

An HP 2754A/B or an HP 2762A teleprinter used by the operator to communicate with the HP 2000 System. Also called the operator's console.

**System Death**

The main and/or I/O processor halts after attempting an unsuccessful Emergency Sleep.

**System Library**

A collection of BASIC language programs and files stored by the user assigned idcode A000. The collection can be accessed by all other users (with certain limitations).

**terminal**

An interactive keyboard device used for communicating with an HP 2000 System. Terminals are connected to the system by direct wiring or over telephone lines. Up to 32 terminals can be logged on the system at a time. Each has an assigned port number between 0 and 31.

## Glossary

### **timesharing**

A method of operating a computer facility so that it is shared by several users for different purposes at (apparently) the same time. Although the computer actually services each user in sequence, the high speed of the computer makes it appear that the users are all handled simultaneously.

### **User**

A person with access to a legal idcode and a terminal. More than one user can use the same idcode concurrently.

### **User Swap Area**

The area on disc where a user's program is temporarily stored while another user's program executes in memory.

### **Warmstart**

A recovery program supplied on the master tape. Program checks whether disc resident tables are in good order and consistent with each other. If they are, Warmstart performs an automatic system restart from disc. Warmstart is the preferred way to restart a dead system.

### **word**

A 16-bit unit of data capable of being stored in one computer location. Two bytes equal one word.



# FORMS

APPENDIX

H

Copies of the Load and Dump, Copy and Bestow, and Problem Report forms are provided in this appendix.











HEWLETT  PACKARD HP 2000 COMPUTER SYSTEM PROBLEM REPORT

DATE: \_\_\_\_\_ REPORT # \_\_\_\_\_  
 (Factory Use Only)

YOUR NAME: \_\_\_\_\_ TELEPHONE (\_\_\_\_) \_\_\_\_\_

INSTALLATION SITE: \_\_\_\_\_

SITE ADDRESS: \_\_\_\_\_

\_\_\_\_\_ ZIP CODE \_\_\_\_\_

HP CUSTOMER ENGINEER NAME: \_\_\_\_\_

HP SALES OFFICE: \_\_\_\_\_

MAG TAPE DENSITY: 800  1600  SOFTWARE REVISION DATE CODE \_\_\_\_\_  
 (e.g. 1638)

CPU TYPE: 2100  21MX  21MX-E

HAS SOFTWARE BEEN MODIFIED? (e.g., HP or Customer installed patches) YES  NO

IF YES, DESCRIBE PATCHES: \_\_\_\_\_

DESCRIPTION OF PROBLEM: \_\_\_\_\_

\_\_\_\_\_

\_\_\_\_\_

WHAT DEVICES WERE ACTIVE: (e.g., LP, CR, NUMBER AND TYPE OF TERMINALS) \_\_\_\_\_

\_\_\_\_\_

RJE ACTIVE? YES  NO  IF YES, SPECIFY HOST: \_\_\_\_\_

PROTOCOL: IBM HASP  ; IBM 2770/2780/3780  ; CDC UT200

PLEASE RECORD CPU REGISTER CONTENTS - (FOR PROCEDURES, REFER TO 2000 OPERATOR'S MANUAL (22687-90005), SECTION 5: "SYSTEM RECOVERY".

|                                    |     |                          |     |                          |     |                                    |     |                          |     |                          |     |
|------------------------------------|-----|--------------------------|-----|--------------------------|-----|------------------------------------|-----|--------------------------|-----|--------------------------|-----|
| SYSTEM PROCESSOR                   |     |                          |     |                          |     | COMMUNICATIONS PROCESSOR           |     |                          |     |                          |     |
| DID SP HALT?                       | YES | <input type="checkbox"/> | NO  | <input type="checkbox"/> |     | DID IOP HALT?                      | YES | <input type="checkbox"/> | NO  | <input type="checkbox"/> |     |
| (IF NO, HALT AND RECORD REGISTERS) |     |                          |     |                          |     | (IF NO, HALT AND RECORD REGISTERS) |     |                          |     |                          |     |
| INTERRUPT LIGHT ON?                | YES | <input type="checkbox"/> | NO  | <input type="checkbox"/> |     | INTERRUPT LIGHT ON?                | YES | <input type="checkbox"/> | NO  | <input type="checkbox"/> |     |
| PARITY LIGHT ON?                   | YES | <input type="checkbox"/> | NO  | <input type="checkbox"/> |     | PARITY LIGHT ON?                   | YES | <input type="checkbox"/> | NO  | <input type="checkbox"/> |     |
| REGISTERS                          |     |                          |     |                          |     | REGISTERS                          |     |                          |     |                          |     |
| P                                  | ___ | ___                      | ___ | ___                      | ___ | P                                  | ___ | ___                      | ___ | ___                      | ___ |
| T                                  | ___ | ___                      | ___ | ___                      | ___ | T                                  | ___ | ___                      | ___ | ___                      | ___ |
| M                                  | ___ | ___                      | ___ | ___                      | ___ | M                                  | ___ | ___                      | ___ | ___                      | ___ |
| B                                  | ___ | ___                      | ___ | ___                      | ___ | B                                  | ___ | ___                      | ___ | ___                      | ___ |
| A                                  | ___ | ___                      | ___ | ___                      | ___ | A                                  | ___ | ___                      | ___ | ___                      | ___ |
| E                                  | ___ | 0                        | ___ | ___                      | ___ | E                                  | ___ | 0                        | ___ | ___                      | ___ |

NOTE: ON HP 2100 COMPUTERS, THE T REGISTER IS LABELED "MEMORY DATA."

1. DID THE SYSTEM SUCCESSFULLY SLEEP? YES  NO
2. DID ANY OF THE FOLLOWING (RECOVERABLE) HALTS OCCUR DURING THE COLD DUMP?  
 102011  102022  102033  102044  102055
3. DID COLD DUMP TERMINATE IN BOTH PROCESSES AS DESCRIBED IN THE OPERATOR'S MANUAL (HALT 102061 AND 102077)? IF NOT, RECORD THE T REGISTER:  
 SP \_\_\_\_\_ IOP \_\_\_\_\_
4. WAS WARMSTART SUCCESSFUL? YES  NO

PLEASE INDICATE THE ITEMS SUBMITTED WITH THIS REPORT. IF A COLD DUMP TAPE IS SUBMITTED, A COPY OF THE CONSOLE LOG AND AN IOP MEMORY MAP ARE REQUIRED FOR ANALYSIS. ALL ITEMS SHOULD BE SUBMITTED TO YOUR HP REPRESENTATIVE.

|                               |                              |                             |
|-------------------------------|------------------------------|-----------------------------|
| COLD DUMP MAGNETIC TAPE       | YES <input type="checkbox"/> | NO <input type="checkbox"/> |
| SYSTEM CONSOLE LOG LISTING    | YES <input type="checkbox"/> | NO <input type="checkbox"/> |
| IOP MEMORY MAP LISTING        | YES <input type="checkbox"/> | NO <input type="checkbox"/> |
| BASIC PROGRAM (IF APPLICABLE) | YES <input type="checkbox"/> | NO <input type="checkbox"/> |
| OTHER: _____                  |                              |                             |
| _____                         |                              |                             |
| _____                         |                              |                             |

SPECIAL INSTRUCTIONS:

REPLIES ARE NORMALLY SENT THROUGH THE HP CUSTOMER ENGINEER. IF YOU WISH A DIRECT REPLY PLEASE SUPPLY YOUR NAME AND ADDRESS BELOW.

SEND REPLY TO: CUSTOMER  HP C.E.

COMMENTS: \_\_\_\_\_  
 \_\_\_\_\_  
 \_\_\_\_\_  
 \_\_\_\_\_  
 \_\_\_\_\_  
 \_\_\_\_\_

*NOTE: While Hewlett-Packard makes every effort to identify and correct each problem submitted by customers, first priority must be given to those problems submitted with completed and accurate documentation.*



## A

2000 System  
 Hardware, 1-2  
 Introduction, 1-1  
 Organization, 1-0  
 Overview, 1-1  
 Software, 1-13  
 2000 to 2000 Commands, 6-24  
 Device Assignment, 6-25  
 Error Report, 6-28  
 Remote Command, 6-28  
 Restart Reader, 6-27  
 Start Reader, 6-26  
 System Connect, 6-25  
 System Disconnect, 6-29  
 Terminate Reader, 6-27  
 2000 to 2000 Communication, 6-23  
 Commands, 6-24  
 Defined, G-1  
 Error Items, 6-29  
 21MX E-Series Processors, 4-3, 4-4  
 2780 to 2780 Communications, 6-31  
 Accessing Capabilities  
 Assigning, 3-25  
 Considerations, 7-3  
 Account Accessing, 7-3  
 Account Structure, 7-2  
 Active Ports, 3-31  
 Alternate Allocation Options, 4-18  
 ANNOUNCE, System Command, 3-2  
 ASCII Job Function Designator, 6-6  
 ASP Commands, 6-14  
 ASSIGN, System Command, 3-3  
 Assigning a Device, 6-25  
 Assignment, Forms, 6-21  
 Available Disc Table (ADT), defined, G-1  
 AWAKE, System Command, 3-5

## B

Backup Considerations, System  
 Tape Reloading, 7-10  
 Tape Requirements, 7-9  
 Tape Rotation Schemes, 7-9  
 Tape Storage, 7-9  
 Backup Schemes, 7-8  
 Backup Tapes  
 Errors, 7-11  
 Reloading, 4-17  
 BANNER, System Command, 3-6  
 Basic Binary Loader (BBL), 1-13  
 Loading, D-1  
 Source Listing, D-2  
 Basic Moving-Head Loader (BMDL)  
 Defined, G-1  
 Using to Restart System, 4-13

BBL (see Basic Binary Loader)  
 Bell Data Sets, 1-8  
 For Data Communications, 6-4  
 Bestow Request Form, H-3  
 BESTOW, System Command, 3-7  
 Block, defined, G-1  
 Block Address  
 Determining, E-1  
 Locking, 3-22, 4-12, 4-18  
 Unlocking, 3-24, 4-12, 4-18  
 Bit, defined, G-1  
 BMDL (see Basic Moving-Head Disc Loader)  
 Bootstrap Loader, 1-13  
 BREAK, System Command, 3-8  
 Byte, defined, G-1

## C

CDC Communication Errors, 6-17  
 CDC EXPORT/IMPORT Commands, 6-15  
 CDC 200 User Terminal, 6-5  
 CHANGEID, System Command, 3-9  
 Character, defined, G-1  
 Characteristics, Terminal, 1-7  
 Codes, Disconnect  
 2000 to 2000, 6-30  
 RJE, 6-16  
 Codes, Software Level, 4-21  
 Cold Dump  
 Procedure, 5-6  
 Problem Report Form, H-7  
 Command Error Messages, B-5  
 Command Format Conventions, 3-1  
 Commands, 2780 to 2780, 6-32  
 Commands, 2000 to 2000, 6-24  
 Device Assignment, 6-25  
 Error Report, 6-28  
 Remote Command, 6-28  
 Restart Reader, 6-27  
 Start Reader, 6-26  
 System Connect, 6-25  
 System Disconnect, 6-29  
 Terminate Reader, 6-27  
 Commands, Loader, 3-37  
 DISC, 3-37  
 DUMP, 3-38  
 FORMAT, 3-39  
 LOAD, 3-40  
 MLOCK, 3-40  
 MUNLOCK, 3-42  
 RESTORE, 3-43  
 Commands, RJE, 6-7  
 Device Assignment, 6-10  
 Error Report, 6-16  
 Load Command (CDC only), 6-18  
 Read Transparent, 6-19

## Index

- Remote Command, 6-13
- Restart Reader, 6-12
- Start Reader, 6-11
- System Connect, 6-8
- System Disconnect, 6-16
- Terminate Printer (CDC only), 6-18
- Terminate Reader, 6-13
- Transfer to Printer, 6-19
- Commands, Special, 3-44
  - DIRECTORY, 3-44
  - DUMP, 3-46
  - REPORT, 3-48
- Commands, System, 3-2
  - ANNOUNCE, 3-2
  - ASSIGN, 3-3
  - AWAKE, 3-5
  - BANNER, 3-6
  - BESTOW, 3-7
  - BREAK, 3-8
  - CHANGEID, 3-9
  - COPY, 3-11
  - DEVICE, 3-13
  - DIRECTORY, 3-15
  - DISCONNECT, 3-17
  - DUMP, 3-17
  - HIBERNATE, 3-18
  - KILLID, 3-21
  - MLOCK, 3-22
  - MUNLOCK, 3-24
  - NEWID, 3-25
  - PHONES, 3-27
  - PURGE, 3-28
  - REPORT, 3-29
  - RESET, 3-30
  - RJE, 3-31
  - ROSTER, 3-31
  - SLEEP, 3-32
  - STATUS, 3-34
- Communications, Data
  - 2000 to 2000, 6-23
  - 2780 to 2780, 6-31
  - Facility Requirements, 6-1
  - Remote Job Entry, 6-4
- Configuration, Hardware
  - I/O Processor, 1-12
  - Main Processor, 1-11
- Configuring Host Functions, A-2
- Configuring the I/O Processor Software, A-1
  - Buffer Sizes, A-2
  - Data Communications Considerations, A-2
  - Dialogue, A-4
  - Guidelines, A-1
  - I/O Device Considerations, A-2
- Connecting RJE, 6-20
- Connecting 2000 to 2000, 6-23
- Console Operation, 2-3
- Console Switch Settings, 2-3
- Console, System, 1-4
- Control-G, A-4
- Control-H, 2-4
- Control-X, 2-4
- Control Statements, Host System, 6-20

- Controllers
  - Disc, 1-3
  - Select Code Assignments, 1-12
- Conversion Dialogue
  - Dump Example, F-2
  - Restore, F-2
- Conversion File Protection, F-3
- Conversion Program, CONVERT, F-1
- Conversion Tables, Disc Addresses, E-3
- CONVERT Program, F-1
- Converting Disc Addresses, E-1
- Copy Requests Form, H-3
- COPY, System Command, 3-11
- Cross Loader, 1-13

## D

- Data Communications, 6-1
  - 2000 to 2000, 6-23
  - 2780 to 2780, 6-31
  - Compatible Operating Systems, 6-2
  - Console, 1-4
  - Error Messages, B-9
  - Facility Requirements, 6-1
  - Modems and Data Sets, 6-4
  - RJE, 6-4
- Data Set, 1-4
  - Control Interface, 1-4
  - Options, 1-8
  - Options for Data Communications, 6-4
- Data Transfer Rates, 1-5
- DCPC, defined, G-2
- Decimal Entries, 2-4
- Default Record Sizes, A-10
- Delaying Messages, 2-4
- Device Assignment Command
  - 2000 to 2000, 6-25
  - RJE, 6-10
- DEVICE, System Command, 3-13
- Device Designators
  - Defined, G-2
  - General, 3-13
  - Job Function, 6-6
  - Specific, 3-13
- Device, Disc, 1-3
- Device Listing, 3-14
- Device Models, 1-10
  - Console, 1-4
  - Data Sets (Modems), 1-8, 6-4
  - Discs, 1-3
  - Magnetic Tape Units, 1-9
  - Terminals, 1-6
- Device Status Messages
  - Defined, 2-2
  - Listed, B-4
- Devices Do Not Respond, 5-5
- Diagnostic Messages
  - Disc, 4-23, C-1
  - Magnetic Tape, 4-24
  - Startup/Restart, 4-23
  - System Halted, 5-5
- Diagnostics, Firmware, 21MXE, 4-4

- Direct Memory Access, defined, G-2
  - DIRECTORY Command
    - Special Command, 3-44
    - System Command, 3-15
  - Directory
    - Listing, 3-16
    - Overflow, 7-7
  - Disc
    - Address Information, 3-34
    - Addresses, Converting, E-1
    - Controller, 1-3
    - Device Description, 1-3
    - Formatting, 3-39, 4-11, 4-18
    - Models, 1-3
    - Relative Block Numbers, E-3
  - Disc Diagnostic Messages
    - Defined, 2-2
    - Loading or Shutdown, C-1
    - Startup/Restart, 4-23
    - System Operation, C-1
  - DISC, Loader Command, 3-37
  - Disc Space
    - Allocating, 3-15
    - Changing Allocation, 3-9
  - DISCONNECT, System Command, 3-17
  - Disconnect Codes
    - 2000 to 2000, 6-30
    - RJE, 6-16
  - DMA, defined, G-2
  - Documenting System Activity, 7-5
  - Dual-Channel Port Controller, defined, G-2
  - DUMP
    - Loader Command, 3-38, 4-21
    - Special Command, 3-46
    - System Command, 3-17
  - Dump
    - Cold, 5-6
    - Considerations, 7-6
    - I/O Processor Memory, 5-8
    - Procedure, 4-21
    - Request Form, H-5
    - Salvage, 5-2
    - Selective, 4-21, 7-6
  - Dumping Programs and Files, 4-21
- E
- Emergency Sleep, 5-1
  - Entering a Job, 6-21
  - Error Messages
    - Command, B-5
    - Data Communication, B-9
    - Defined, 2-2
    - Device Status, B-4
    - Disc, 4-23, C-1
    - I/O Processor Configurator, B-11
    - I/O Processor Halt Codes, B-3
    - Main Processor Halt Codes, B-1
    - Magnetic Tape, 4-24
    - Master Program, B-10
    - System Load/Shutdown, B-13
    - Warmstart, B-17
  - Error Report Command
    - 2000 to 2000, 6-28
    - RJE, 6-16
  - Errors, Communication
    - 2000 to 2000, 6-29
    - CDC, 6-17
    - MRJE and 2780, 6-17
  - Errors, Disc
    - Startup or Restart, 4-23
    - System Loading or Shutdown, C-1
    - System Operation, C-1
  - EXPORT/IMPORT Commands, CDC, 6-15
- F
- Failures
    - Power, 5-9
    - System, 5-1
  - FCP (see File Create/Purge)
  - Features
    - I/O Processor, 1-3
    - Main Processor, 1-3
    - Terminals, 1-5
  - Feature Level Codes, 4-22
  - File Create/Purge (FCP)
    - Assigning, 3-25
    - Considerations, 7-3
    - Defines, G-2
  - File Protection, After Conversion, F-3
  - Firmware Diagnostics, 21MXE, 4-4
  - Format Conventions, 3-1
  - FORMAT, Loader Command, 3-39
  - Forms, H-1
    - Copy and Bestow Requests, H-3
    - Load, Restore and Dump Requests, H-5
    - Problem Report, H-7
  - Forms Assignment, 6-21
  - Forms Control, 6-20, 6-21
- G
- General Device, 3-25
  - Generating a System Program, 4-11
  - Group Libraries, 7-4
  - Group Master, 7-4
- H
- H<sup>c</sup>, 2-4
  - Halt Codes
    - Defined, 2-2
    - I/O Processor, B-3
    - Main Processor, B-1
  - Halted System
    - Both Processors Halted, 5-4
    - Devices Do Not Respond, 5-5
    - Diagnostic Messages, 5-5
    - I/O Processor Halted, 5-3
    - Main Processor Halted, 5-4
    - Parity Error, 5-3
  - Hardware Configuration, 1-10
  - HASP Commands, 6-14

## Index

HELLO Program, 7-5  
HIBERNATE, System Command, 3-18  
    Backup Considerations, 7-8  
    Procedure, 3-20  
Host Functions, 6-5  
    Assignment, 6-5, 6-6  
    Configuration Considerations, A-2  
    Device Assignments, A-7  
Host Function Organization  
    2000 to 2000, 6-23  
    RJE, 6-6  
Host Systems, 6-2

**I**

IBM 2741, 1-7  
IBM Commands, 6-14  
Idcode  
    Assigning, 3-25  
    Defined, G-3  
    Organization, 7-2  
IDT, defined, G-3  
Input/Output Devices, 1-9, 1-10  
    Configuring, A-6  
Interface  
    Board, 1-10  
    Data Set Control, 1-4  
    Slot Assignments, 1-12  
I/O Processor  
    Configuration Dialogue, A-3  
    Description, 1-3  
    Device Assignments, 1-11  
    Error Messages, B-11  
    Hardware Configuration, 1-10  
    Interface Slots, 1-12  
    Software Configuration, A-1  
    Switch Settings, 4-5  
I/O Processor Halted, 5-3  
I/O Processor Loading  
    After Configuration, A-9  
    From Master Tape, 4-7  
    From Stand-Alone Tape, 4-8  
    Overview, 4-1, 4-6  
I/O Processor Memory Dump, 5-8  
I/O Processor Memory Requirements, A-1  
I/O Processor Memory Map  
    Listing From Tape, 5-7  
    Sample Listing, A-11  
I/O Slot, 1-10  
IOPC, A-1  
    Defined, G-3

**J**

JFD, defined, G-3  
Job Function Designators  
    Defined, G-3  
    Host Function Relationships, A-2  
    Listed, 6-6  
Job  
    Entry, 6-21  
    Output, 6-21

## K

Keyboard Entries, 2-3  
KILLID, System Command, 3-21

## L

Libraries  
    Group, 7-2, 7-4  
    Manipulating, 7-5  
    Private, 7-2, 7-4  
System, 7-2, 7-4  
Listing an IOP Memory Map, 5-7  
Load and Dump Request Form, H-3  
Load Command (CDC only), 6-18  
LOAD, Loader Command, 3-40  
Load, Restore and Dump  
    Considerations, 7-6  
    Options, 4-20  
    Procedure, 4-20  
    Request Form, H-5  
Loader Commands  
    DISC, 3-37  
    DUMP, 3-38  
    FORMAT, 3-39  
    LOAD, 3-40  
    MLOCK, 3-41  
    MUNLOCK, 3-42  
    RESTORE, 3-43  
Loader/Loader, 1-13  
Loading Programs and Files, 4-20, F-1  
Loading the BBL, D-1  
Loading the I/O Processor Program, 4-7  
    From Master Tape, 4-7  
    From Stand-Alone Tape, 4-8  
Loading the Master Program, 4-5  
Loading the System Program, 4-10  
Locking Disc Blocks  
    Determining Block Numbers, E-1  
    MLOCK Command, 3-24, 3-40  
    Procedure, 4-12, 4-18  
Logging Users Off System, 3-17

## M

Magnetic Tape Unit  
    Error Messages, 4-24  
    Hardware description, 1-9  
    Restart, 4-17  
Main Processor  
    Description, 1-3  
    Device Assignments, 1-11  
    Hardware Configuration, 1-11  
    Halted, 5-4  
    Switch Settings, 4-5  
Manager, System, 7-1  
Mass Storage, 1-3  
Master Program  
    Error Messages, B-10  
    Loading, 4-5  
Memory Map  
    Description, A-1

- Listing from Tape, 5-7
  - Sample Listing, A-11
  - Messages
    - Announce, 3-2
    - Banner, 3-6
    - Delaying, 2-4
    - Device Status, B-4
    - Hibernate, 3-18
    - Sleep, 3-32
  - MLOCK Command
    - Loader Command, 3-40
    - System Command, 3-22
  - Modems (data Sets), 1-4
    - For Data Communications, 6-4
  - MRJE Workstation, 6-4
  - Multi-Write Access (MWA)
    - Assigning Capability, 3-25
    - Considerations, 7-3
    - Defined, G-4
  - Multiplexers, 1-4
  - MUNLOCK Command
    - Loader Command, 3-42
    - System Command, 3-24
  - MWA (see Multi-Write Access)
- N
- NEWID, System Command, 3-25
  - Non-Printing Password Characters, 3-26
  - Non-Sharable Device
    - Assigning, 3-9, 3-25
    - Configuring, A-7
    - Defined, G-4
- O
- Octal Entries, 2-4
  - Operating Messages, defined, 2-2
  - Operating Procedures, 4-4
    - CONVERT Program, F-1
    - Dumping Programs and Files, 4-21
    - Flow Diagram, 4-2, 4-3
    - I/O Processor Program Loading, 4-7
    - Loading Programs and Files, 4-21
    - Master Program Loading, 4-5
    - Overview, 4-1
    - Restart From Magnetic Tape, 4-17
    - Restart Using BMDL, 4-13
    - Restart Using System Loader, 4-15
    - Restoring Programs and Files, 4-21
    - System Program Loading, 4-10
  - Operating Systems with Data Communications, 6-2
  - Operator's Console, 1-4
  - Operator's Job, 2-1
  - Overflow, Directory, 7-7
  - \*OUT=*filename*\*, 3-44
  - Options, Alternate Allocation, 4-18
- P
- Parity Error, 5-3
  - Password, 3-25
  - Password Characters, 3-36
  - PFA (see Program/File Access)
  - PHONES, System Command, 3-27
  - Ports, Active, 3-31
  - Power Failure Message, 2-2
  - Power Failures, 5-9
    - During Shutdown, 5-10
    - During Startup, 5-10
    - While System is Shutdown, 5-10
  - Private Libraries, 7-4
  - Problem Report Form, H-7
  - Processors
    - Configuring Hardware, 1-10
    - Halted, 5-4
    - Identifying, 1-2
    - I/O Description, 1-3
    - Main Description, 1-3
    - Switch Settings, 4-5
  - Program/File Access (PFA)
    - Assigning Capability, 3-25
    - Considerations, 7-3
    - Defined, G-4
  - Protection Codes, 4-22
  - PURGE, System Command, 3-28
  - Purging the System, 7-5
- R
- Read Transparent Command (2780 only), 6-19
  - Reading a Magnetic Tape, 5-8
  - Reloading From Backup Tapes, 4-17, 7-10
  - Record Size, Defaults, A-10
  - Remote Job Entry
    - Commands Summarized, 6-7
    - Control Statements, 6-20
    - Defined, 6-4
    - Job Output, 6-2I
    - Using, 6-20
  - Remote Job Entry (RJE) Commands, 6-7
    - Device Assignment, 6-10
    - Error Report, 6-16
    - Load Command (CDC only), 6-18
    - Read Transparent, 6-19
    - Remote Command, 6-13
    - Restart Reader, 6-12
    - Start Reader, 6-11
    - System Connect, 6-8
    - System Disconnect, 6-16
    - Terminate Printer (CDC only), 6-18
    - Terminate Reader, 6-13
    - Transfer to Printer, 6-19
  - Remote Command
    - 2000 to 2000, 6-28
    - RJE, 6-13
  - Report Listing, 3-29
  - REPORT Command
    - Special Command, 3-48
    - System Command, 3-29
  - RESET, System Command, 3-30
  - Restart Procedures, 4-12
    - From Disc Using BMDL, 4-13
    - From Disc Using System Loader, 4-15

## Index

- From Magnetic Tape, 4-17
- Overview, 4-4
- Restart Reader Command
  - 2000 to 2000, 6-27
  - RJE, 6-12
- RESTORE, Loader Command, 3-43
- Restoring Programs and Files
  - Considerations, 7-6
  - Procedure, 4-21
- RJE Communications, 6-4
- RJE, System Command, 3-31
- ROM, defined, G-5
- Roster Listing, 3-31
- ROSTER, System Command, 3-31
- RUN\*OUT=*filename*, 5-7
  
- S
  
- Salvage Dump, 5-2
- Select Code
  - Assignments, 1-10
  - Defined, G-5
- Selective Load, Restore, Dump
  - Considerations, 7-6
  - Procedure, 4-21
  - Request Form, H-5
- Sending Host System Commands, 6-13
- Shutdown Overview, 4-3
- Single-Write Access (SWA), defined, G-5
- Sleep, Emergency, 5-1
- SLEEP, System Command, 3-32
  - Backup Considerations, 7-8
  - Procedure, 3-33
- Special Commands
  - DIRECTORY, 3-44
  - DUMP, 3-46
  - REPORT, 3-48
- Specific Device
  - Assigning, 3-3
  - Defined, 3-13, G-2
  - Restarting, 3-5
- Software Configuration, A-1
- Software Level Codes, 4-21
- Software Description, 1-13
- Start Reader Command
  - 2000 to 2000, 6-26
  - RJE, 6-11
- Startup Overview, 4-1
- Statements, Control, 6-20
- Status Listing, 3-36
- STATUS, System Command, 3-34
- Supervisor Planning, 7-1
- SWA, defined, G-5
- Switch Settings
  - I/O Processor, 4-5
  - Main Processor, 4-5
  - System Console, 2-3
- System
  - Backup Considerations, 7-8
  - Console, Description, 1-4
  - Description, 1-1
  - Hardware Configuration, 1-10
  - Library, 7-4
  - Log, 1-4
  - Operating Considerations, 7-2
  - Processor (main), 1-3
  - Recovery, 5-1
  - Software Description, 1-13
  - Usage Documentation, 7-7
- System Connect Command
  - 2000 to 2000, 6-25
  - RJE, 6-8
- System Death, 5-1
- System Disconnect Command
  - 2000 to 2000, 6-29
  - RJE, 6-16
- System Halt Codes
  - Defined, 2-2
  - Listed, B-1, B-2
- System Halted, Recovery Procedures, 5-3
- System Level Codes, 4-21
- System Loader, Using to Restart, 4-15
- System Load/Shutdown Error Messages, B-13
- System Operating Overview, 4-1
  - Restart Overview, 4-4
  - Shutdown Overview, 4-3
  - Startup Overview, 4-1
- System Personnel
  - Group Master, 7-4
  - Manager, 7-1
  - Master, 7-4
  - Operator, 2-1
- System Program
  - Generating, 4-11
  - Loading, 4-11
  - Updating, 4-12
- System Purge, 7-5
- System Commands
  - ANNOUNCE, 3-2
  - ASSIGN, 3-3
  - AWAKE, 3-5
  - BANNER, 3-6
  - BESTOW, 3-7
  - BREAK, 3-8
  - CHANGEID, 3-9
  - COPY, 3-11
  - DEVICE, 3-13
  - DIRECTORY, 3-15
  - DISCONNECT, 3-17
  - DUMP, 3-17
  - HIBERNATE, 3-18
  - KILLID, 3-21
  - MLOCK, 3-22
  - MUNLOCK, 3-24
  - NEWID, 3-25
  - PHONES, 3-27
  - PURGE, 3-28
  - REPORT, 3-29
  - RESET, 3-30
  - RJE, 3-31
  - ROSTER, 3-31
  - SLEEP, 3-32
  - STATUS, 3-34

## T

- Tape Rotation Schemes, 7-9
- Terminals
  - Buffer Sizes, A-2
  - Characteristics, 1-7
  - Features, 1-5
  - Types, 1-5, 1-6
- Terminals, User, 1-4
- Terminate Printer Command (CDC only), 6-18
- Terminate Reader Command
  - 2000 to 2000, 6-27
  - RJE, 6-13
- Terminating a Report, 2-4
- Time Accumulated, Terminal
  - Listing, 3-29
  - Resetting, 3-30
- Time Limit, 3-25
- Track Allocations
  - Changing, 4-18
  - Initial Assignments, 4-12
- Transfer to Printer Command, 6-19
- Transmission Rates, 1-5

## U

- Unlocking Disc Blocks
  - Determining Block Numbers, E-1
  - MUNLOCK Command, 3-24, 3-42
- Updating the System Program, 4-13
- Usage Documentation, 7-7
- User
  - Accounts, Assigning, 3-25
  - Defined, G-6
  - Idcode Organization, 7-2
  - Listed in Report, 3-29
  - Log-On-Time Permitted, 3-27
  - Swap Areas Listed, 3-35
  - Terminals, 1-4
- Using 2000 to 2000 Communications, 6-30

## W

- Warmstart
  - Defined, G-6
  - Diagnostic Messages, B-17
  - Procedure, 5-2

## X

- X<sup>c</sup>, 2-4

