

For R.C.A.

Friden

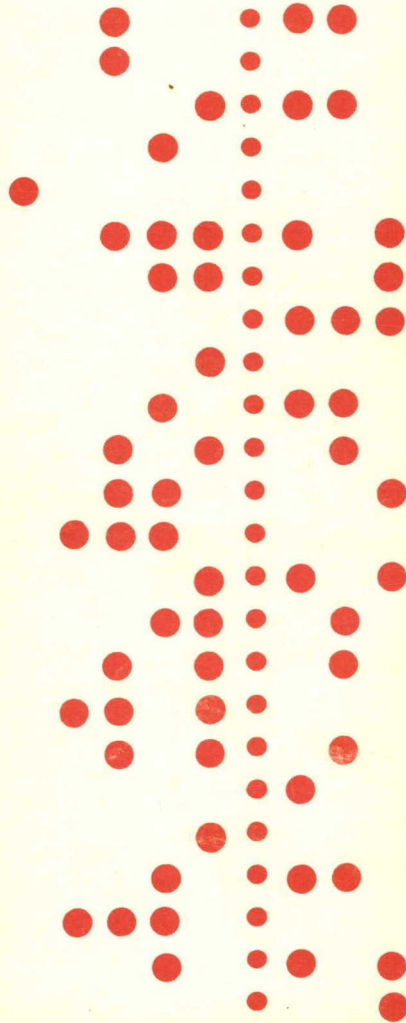

Technical Manual for

Friden Flexowriter® Programatic®

AUTOMATIC WRITING MACHINE



MODELS SPS, SPD

Price: \$2.00

Published by



Friden, Inc.
Educational Center
31 Prince Street
Rochester, New York, 14607

Technical Manual for
FLEXOWRITER[®] PROGRAMATIC[®]
AUTOMATIC WRITING MACHINE

Copyright 1962, by Friden, Inc.

FOREWORD

The Friden Flexowriter Programatic is an automatic writing machine with widely diversified uses in the dynamic fields of data processing and data distribution. It can be: integrated with electronic data processing systems requiring large computers made by other companies; as part of a small systems installation where a computer is not required; or as an individual piece of equipment for specialized tasks.

Basically concerned with document origination, the Flexowriter can simultaneously punch tape or cards as an automatic by-product of the original writing. Tape or cards, in turn, automatically create other records. Thus, the Flexowriter not only produces an original document - - the first step in the automation cycle - - but it makes possible automation of subsequent steps.

Because of its flexibility, the Flexowriter can be adapted to even the most irregular and complex business paperwork requirements. For example, it can handle input information through the keyboard, from a wide variety of auxiliary input units or through the media of punched paper tape, edge-punched cards, and tabulating cards. Only new data that has not been previously recorded is entered by using the keyboard; otherwise the Flexowriter writes all other data automatically, after a single switch is touched!

Output can take the form of a master or multi-copy printed document and one or more by-product punched tapes, edge-punched cards, or tabulating cards. Using auxiliary output units, additional documents, tapes or cards - - containing complete or selected information - - may be automatically and simultaneously produced.

By reading punched tape or cards, the Flexowriter has brought automation to the preparation of business documents for many firms, both small and nationally known. For many businesses it has eliminated the continual manual reprocessing of data that formerly kept the paperwork cost high. For example an electrical parts supply firm uses the Flexowriter to punch tab cards automatically from tape, completely eliminating the costly manual operations of key punching and verifying.

Because of this versatility, the Friden Flexowriter can meet the basic data processing needs of any size or type of business in virtually any application. Whether producing purchase orders . . . sales orders . . . invoices . . . shipping papers; or providing input-output for electronic computers; or accomplishing a host of other business jobs, the Flexowriter is truly a master of automation.

TABLE OF CONTENTS

SECTION I INTRODUCTION

General Description	1
Input-Output Versatility	1
Components	1
Operating Speeds	2

SECTION II SPECIFICATIONS

General	3
Keyboard	3
Carriage	4
Tape Supply	5
Tape Used	6
Code System	6
Type Style	6
Ribbon	7
Auxiliary Connected Equipment	7

SECTION III OPERATING FEATURES

General	9
Punch Control Switch	9
Keyboard Punch Control	9
Field Punch Control	10
Panel Switches	11
Code Reproduction	13
Correcting Errors	13
Auxiliary Control Codes	14

SECTION IV FLEXOWRITER, MODEL SPD

General Description	15
Type Style	15
Case Shift	15
Power Switch	16
ON 1 - ON 2 Keylever	16
Back Space	16

SECTION V CUSTOMIZING THE FLEXO- WRITER PROGRAMATIC

General	17
Keyboard Alterations	17
Code Reproduction	17
Tape Skip	17
Parity Check	17
Edge-Punched Card Reader and Punch	17
Tab Card Reader	18

Pin Feed Platens	19
Friden Flexofeed	19
Electric Line Finder	20
Line Skip	20
Second Stop - Selective	20
Coded Back Space	20
Ribbon Shift	20

SECTION VI AUXILIARY PUNCHES

General	21
Specifications	21
Universal Cabinet Stand	22
Operational Features	22

SECTION VII ACCESSORIES AND SUP- PLIES

General	23
Accessories	23
Supplies	25

SECTION VIII PROGRAMMING

General	27
Illustration I - Flexowriter	27
Illustration II - Flexowriter With An Auxiliary Input Unit	39
Illustration III - Flexowriter With An Auxiliary Output Unit	40
Code And Flow Chart Template	42

SECTION IX GLOSSARY OF DATA PRO- CESSING TERMS

Introduction	43
--------------	----

APPENDIX

Publications and Education	47
----------------------------	----

CHARTS AND TABLES

Platen Ratchet Chart	5
Auxiliary Input Units	7
Auxiliary Output Units	8
Control Rack Position Chart	11
Auxiliary Control Code Summary	14
Form Widths For Pin Feed Platens	19
Code Chart	46

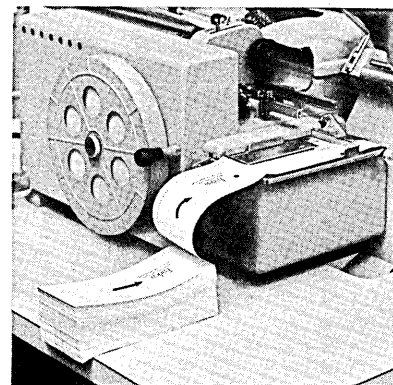
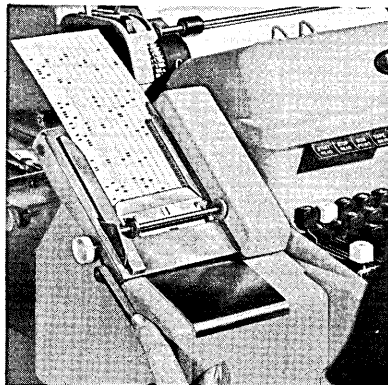
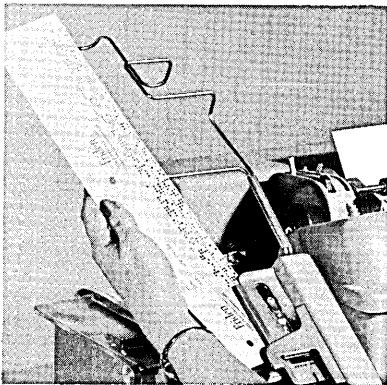
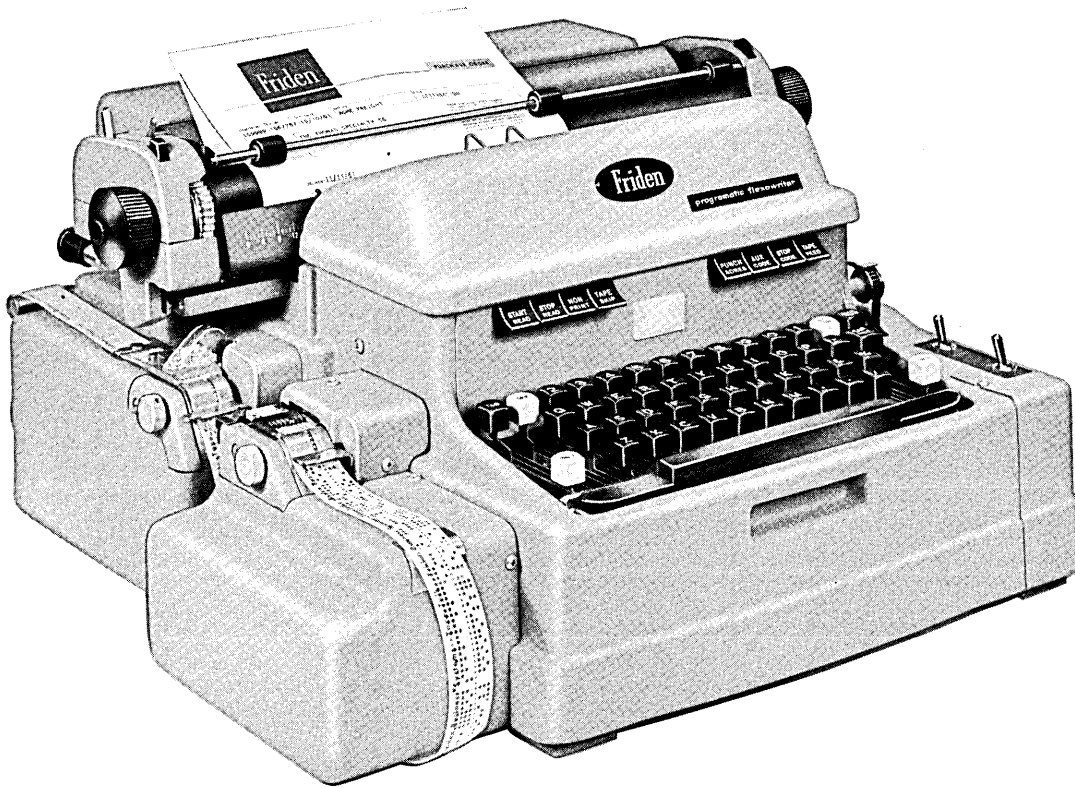

Full view of Flexowriter Programatic, standard model with 12" carriage, tape reader and punch (above). Closeup (left-to-right) of optional edge-punched card reader, tab card reader, and edge card punch.

SECTION I

INTRODUCTION

GENERAL DESCRIPTION

The Friden Flexowriter Programatic, automatic writing machine, is available in two models, Systems Programatic Single Case (SPS), and Systems Programatic Double Case (SPD). Between the two models, the major difference is in the type style used. The Model SPS uses a single case type style, giving only capital letters, numbers and special characters. The Model SPD uses a double case type style, giving both capital and small letters, numbers, and several additional special characters.

All further description of the Flexowriter will refer to the Model SPS unless otherwise indicated. Section IV of this manual describes the Model SPD in detail.

INPUT - OUTPUT VERSATILITY

As illustrated on the frontispiece (facing page), any one of three input readers are available as component parts of the Flexowriter Programatic. The tape reader is standard; edge-punched card and tab card readers are optional. Manual input is by operation of the writing machine keyboard.

Either of two punches provide tape (standard) or edge-punched card (optional) output, as well as the typed document which is produced as part of the Flexowriter Programatic operation.

In addition to this, the Flexowriter Programatic has the ability of being connected to one auxiliary input unit and one auxiliary output unit, separately or simultaneously for further operational flexibility. There are 16 different auxiliary input units, and 10 different auxiliary output units from which to choose. Combinations of these provide a wide range of application versatility.

Figure 1 illustrates the available input and output media for all the Friden Flexowriter Programatics.

COMPONENTS

Five basic components make up the Flexowriter Programatic (see figure 2): the reader, code translator, writing machine, code selector, and punch. Interaction of these components is described below.

Reader - Mechanically senses codes punched in tape (edge-punched cards or tab cards), and converts each code into a series of electrical impulses which are sent to the code translator.

Code Translator - Converts these impulses into a mechanical action of the writing machine to cause a keylever to be operated, or a function performed.

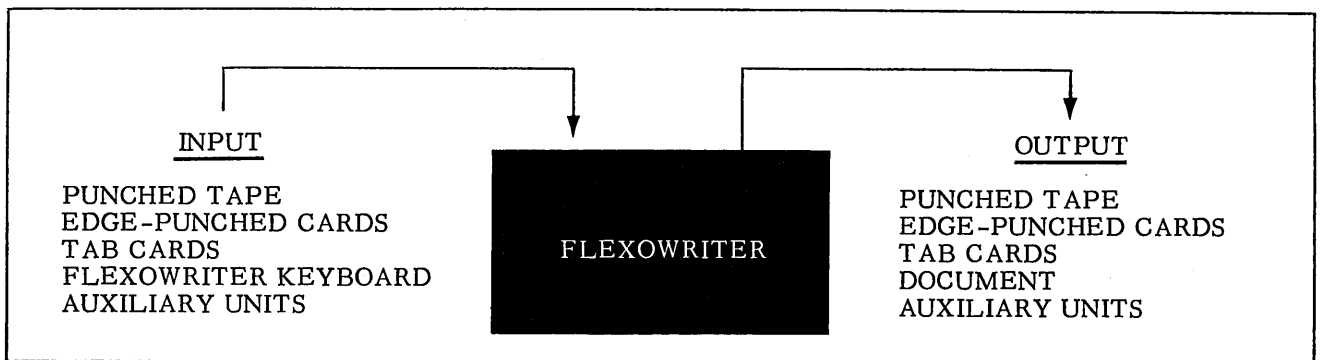

Figure 1. Flexowriter Programatic Input - Output Versatility.

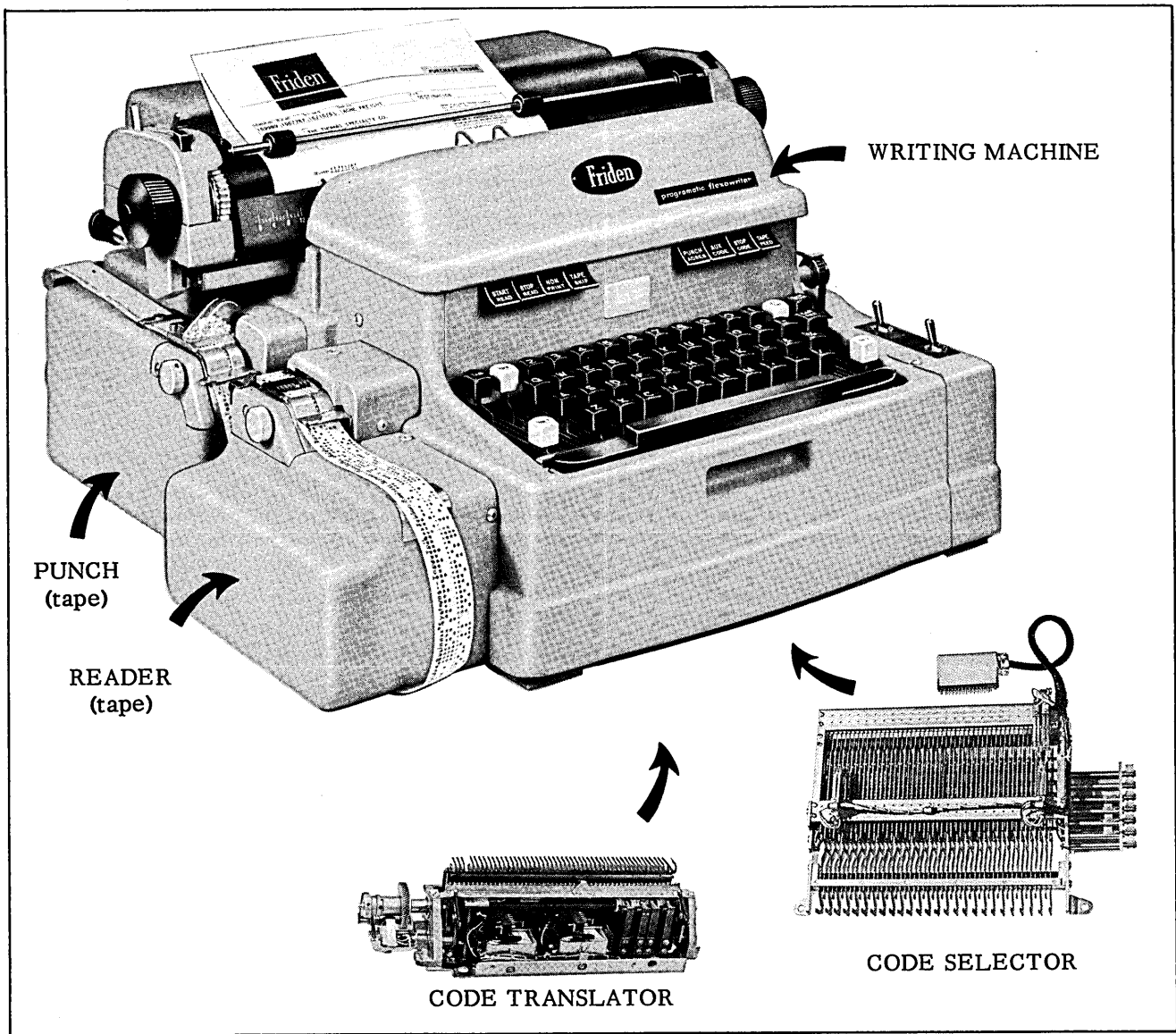

Figure 2. Flexowriter Components.

Writing Machine - Contains the power supply, the keylevers, and all necessary equipment to allow the Flexowriter Programatic to write a document.

Code Selector - When a keylever on the writing machine is operated either manually or by action of the code translator (automatically), the code selector converts this mechanical action into a series of electrical impulses, which are sent to the punch.

Punch - If the punch is on at the time these impulses are received, the code assigned to that operated keylever will be punched.

OPERATING SPEEDS

All readers (tape, edge-punched card, and tab card) operate at the rate of 572 codes read per minute. This is approximately 100 (5-letter) words per minute.

The punch will accept codes selected from manual keylever operation at a sustained rate of 1000 codes punched per minute, approximately 200 (5-letter) words. It will also handle any two successive keylever operations occurring at the rate of 1200 per minute.

SECTION II

SPECIFICATIONS

GENERAL

To provide maximum application flexibility and reliability, the Flexowriter is designed and engineered as a *heavy duty automatic* writing machine. These heavy duty characteristics enable the Flexowriter to withstand many years of sustained, high speed automatic operation. Information in this section gives the complete physical specifications of the machine.

Below is a list of general specifications:

- Weight - 85 pounds (approx.)
- Size - 17-1/2" wide, 10" high, 20" long
- Color - Friden Tan Armorsol
- Power - 110-115 volt, 60 cycle AC

KEYBOARD

Figure 3 shows the fully electric, level, speed, standard keyboard on the Flexowriter. There are four rows of keylevers, slightly stepped between each row for maximum operator speed, and ease of operation.

Only a 2-1/2 ounce touch and a total key-lever movement of 1/4 inch is required to manually operate any keylever. The following text describes all functional (non-writing) keylevers.



Operation of the carriage return (CAR RET) keylever manually, or automatically by the Carriage Return code, causes the carriage to return to the left margin. The document being written is indexed from one to three line spaces, depending upon the setting of the line space lever (See figure 4).



Operation of the TAB keylever manually or automatically by the Tab code, causes right-to-left carriage movement at high speed to a position determined by the insertion of a tab stop (See figure 4) in the tab rack. The TAB keylever is used to move the carriage across large areas of the document where spacing is not practical. Tab stops are readily accessible for insertion or removal.

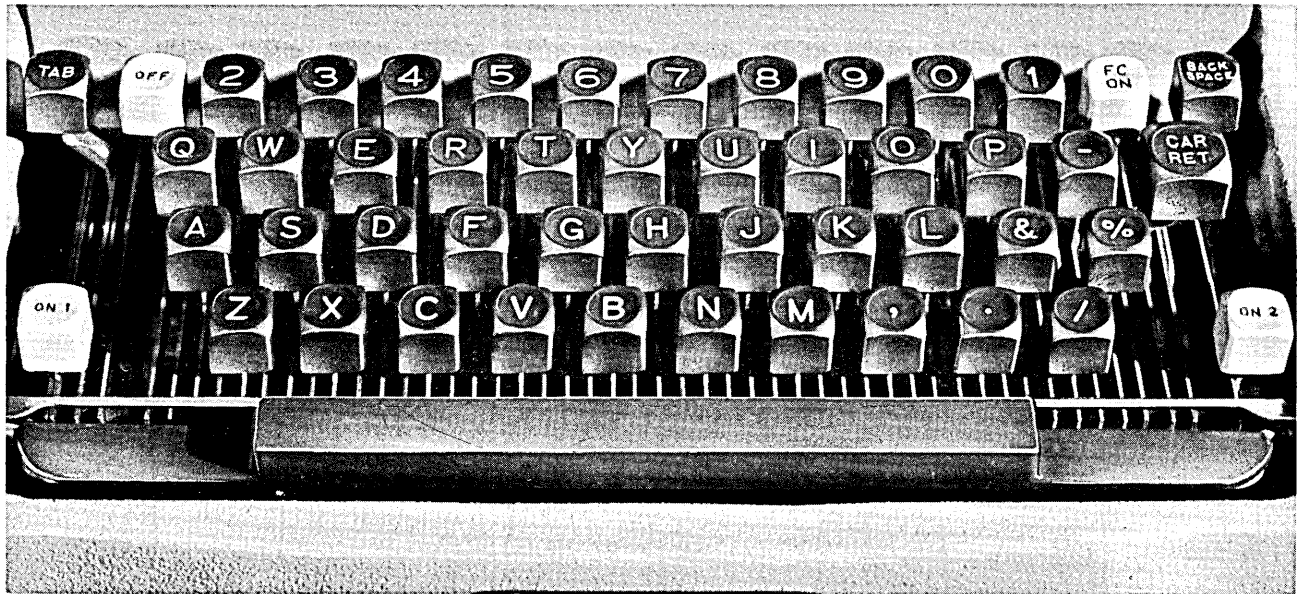

Figure 3. SPS Keyboard.

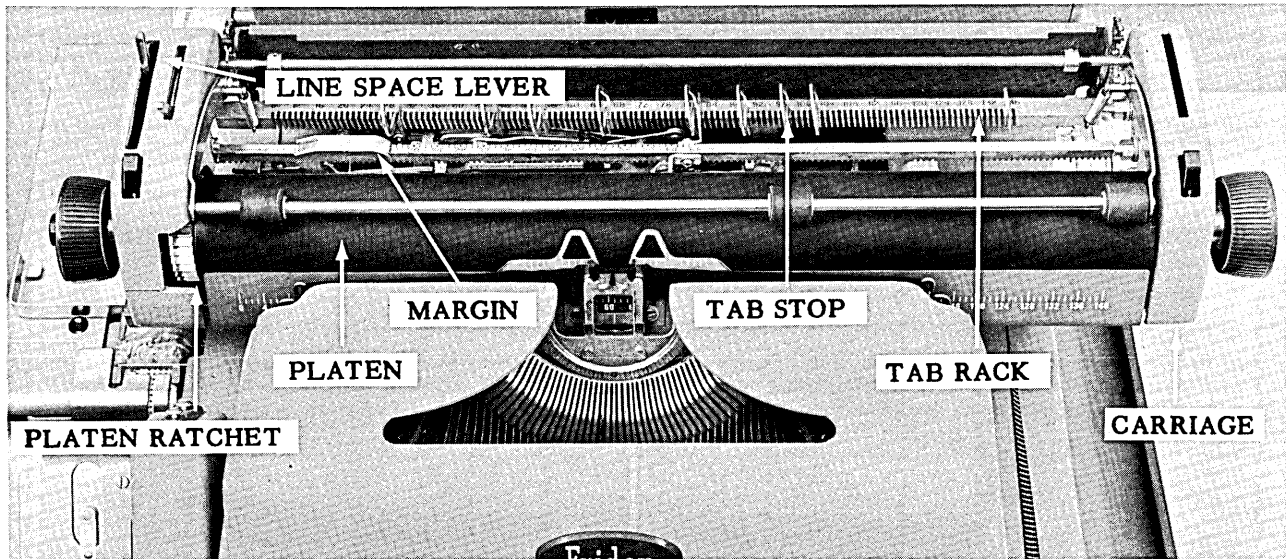
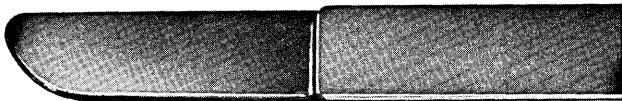

Figure 4. Carriage Parts - 16'' Carriage.



The BACK SPACE keylever causes the carriage to move one writing, or letter space in reverse (left-to-right). This keylever is not normally used in automatic operation; therefore does not punch a code, and is not operated automatically. (See page 20, Section V.)



Operation of the space bar causes the carriage to move one writing (letter) space forward (right-to-left).

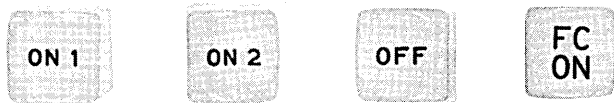

These are non-escaping, non-writing keylevers used exclusively for controlling the punch. They are seldom operated manually. The function of these keylevers is described in Section III, "Operating Features."

CARRIAGE

A 12-inch carriage is standard (See figure 4), although 16 and 20-inch carriages are available as an optional feature. The chart lists the maximum paper size and writing line for each carriage length.

CARRIAGE LENGTH	MAXIMUM PAPER SIZE	MAXIMUM WRITING LINE
12''	11''	9-1/2''
16''	15''	13-1/2''
20''	19''	17-1/2''

Platens (See figure 4) - Are supplied in various sizes and degrees of hardness for different types of work. Usually, actual documents or forms are sent with the order to facilitate factory type alignment and proper platen selection.

Platen Ratchet (See figure 4) - Is part of the platen and controls the vertical line spacing of type on the document. A 33-tooth ratchet, giving six lines to the inch (vertically), is standard on all Flexowriters. However, platens are available with a variety of ratchets giving different line spacing.

To select the correct platen ratchet for line spacing other than standard, the chart shown in figure 5 is used. First count the number of lines in 10 inches of copy then, move the decimal point one place to the left, and find the nearest number on the chart. The platen ratchet part number is located in the first column, on the same line as the number selected.

PLATEN RATCHET PART NUMBER	NO. OF TEETH	1 TOOTH	2 TEETH	3 TEETH	4 TEETH	5 TEETH
1042527	27	4.91	2.46	1.64		
1042529	29	5.28	2.64	1.76		
1042533	33	6.00	3.00	2.00		
1042536	36	6.55	3.27	2.18		
1042538	38	6.91	3.46	2.30		
1042539	39	7.09	3.55	2.37		
1042540	40	7.28	3.64	2.43		
1042544	44		4.00	2.66	2.00	
1042544		8.00	4.00	2.66		
1042548	48		4.37	2.91		1.75
1042549	49		4.46	2.97		1.78
1042550	50		4.55	3.03	2.27	
1042551	51		4.64	3.09	2.32	
1042552	52		4.73	3.15	2.37	
1042555	55		5.00	3.33	2.50	
1042557	57		5.18	3.46	2.59	
1042558	58		5.28	3.52	2.64	
1042559	59		5.37	3.58	2.68	
1042562	62		5.64	3.76	2.82	
1042566	66		6.00	4.00	3.00	

Figure 5. Platen Ratchet Chart.

Certain platen ratchets are interchangeable. Additional platens with different ratchets are often purchased to provide a variety of line spacing for different effects. Below is a list of interchangeable ratchets:

- 29, 33, 38, 44, and 49
- 36, 39, and 40
- 50, 51, 52, and 57
- 55 and 58
- 62 and 66

A line space lever (See figure 4) selects single, double and triple line spacing.

TAPE SUPPLY

Tape is threaded into the punch as shown in Figure 6. Since accuracy and reliability of the output are prime requisites of a source document automation system, an elaborate system of checks is provided to insure positive tape feeding and registration.

Tape Supply Spool - Holds one roll of tape, approximately 1000 feet in length. One thousand feet of tape will hold 120,000 codes (10 codes per inch). In Figure 6, the cover is removed from the tape supply spool to show the contents. The cover is normally on during tape operation. Tape itself is available in a variety of materials and colors, described in Section VII, "Accessories and Supplies."

Tape Guide - Serves to provide a smooth and even flow of tape to the punch. The contour of the guide prevents kinks or tears from occurring as the tape is being fed from the supply spool.

Tape Tension Arm - Acts as a safeguard against feeding failure due to restrictions in feeding. If the tape should be obstructed from proper feeding, or when a certain pre-set tape tension is exceeded, this arm will cause the Flexowriter to become locked against further operation until corrective measures have been taken.

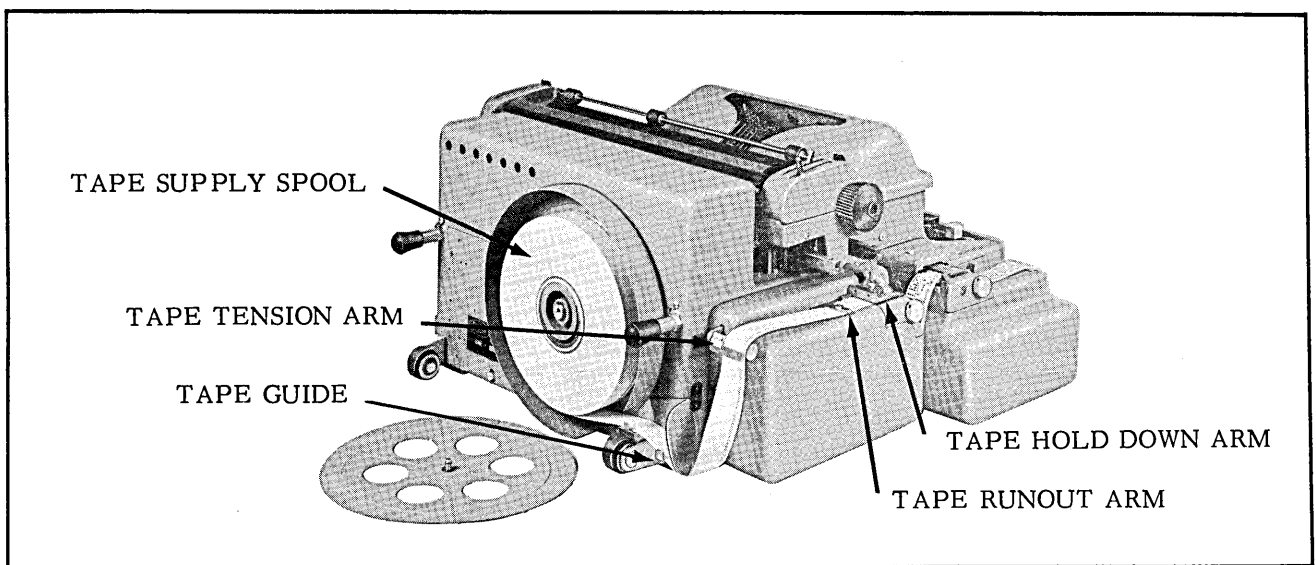

Figure 6. Flexowriter - Rear View.

Tape Runout Arm - Prevents the accidental running out of tape without the operator's knowledge. This provides a positive check against a broken tape, and locks the Flexowriter against further operation until the tape is correctly inserted.

Tape Hold-Down Arm - Provides sufficient pressure against the tape in the punch to insure positive engagement with the feeding mechanism. If this arm is not closed, the Flexowriter is locked against operation.

Keylever Interlock (not shown) - Prevents accidental manual operation of more than one keylever at a time. This provides positive assurance that codes cannot be overlapped or punched on top of each other.

Electrical Accuracy Check (not shown) - Causes the Flexowriter to become locked against further operation when the keyboard is operated in a manner which might cause inaccurate code selection and punching.

TAPE USED

A one-inch wide tape (See figure 7) is used and is punched with an eight-unit code. Tapes of various materials are supplied by Friden, and are described in Section VII. Code hole positions (channels) are numbered 87654321, from left-to-right across the width of the tape. Feed holes assure positive positioning of the tape in the reader and the punch. They are located between the third and fourth code holes, .394 inches from the right (guide) edge of the tape, and are in line with the code holes.

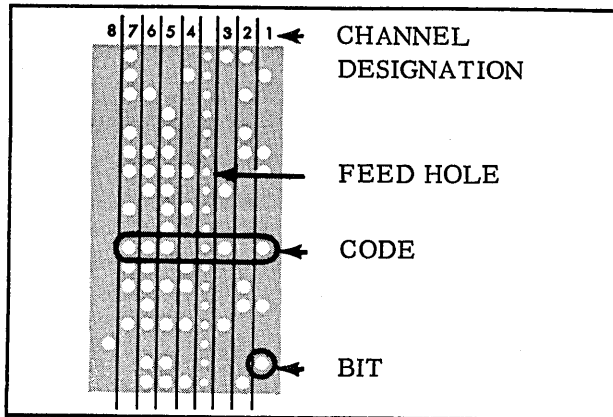

Figure 7. 8-Channel Punched Tape.

CODE SYSTEM

The Friden Systems code, a binary coded decimal system, used by the Flexowriter and its allied equipment, is often referred to as the common-language code. It is compatible with a diversity of equipment manufactured by Friden as well as a large number of other manufacturers. Eight channel tape produced by the Flexowriter may be used to operate tape-to-card converters; transmitted over private and leased wires; used for computer input and output; converted to other code structures; control machine tools; automatic address plate embossing machines; and a variety of other data processing equipment.

Since every code used by the Flexowriter contains an odd number of bits, tapes may be used with equipment employing electrical code accuracy checking facilities (parity check). As an optional feature, parity checking circuits may be added to the Flexowriter (See page 17).

A code chart listing all of the codes used by the Flexowriter is found on page 46.

TYPE STYLE

Manifold No. 10 is the standard type style on the Flexowriter, Model SPS. This type style allows 10 characters to be typed within an inch, horizontally. It is a single case type style, comprising capital letters only, on the alphabetic keys.

Maximum clarity and impression through a large number of carbon copies, as well as clear, uniform duplicating masters, are characteristics of the Manifold No. 10 type style. Additional speed and accuracy is obtained, since shifting from one case to another is eliminated.

Below is a sample of the Manifold No. 10 type style as used on the standard Flexowriter, Model SPS.

A	B	C	D	E	F	G	H	I	J	K	L	M	N	O	P
Q	R	S	T	U	V	W	X	Y	Z						
1	2	3	4	5	6	7	8	9	0						
&	%	-	/	.	,										

If desired, the Flexowriter may be equipped with alternate type styles. The manual, "Friden Type Styles", available at any Friden office, lists the alternatives.

Described in Section IV of this manual is the Flexowriter Model SPD. It is equipped with a type style containing both upper and lower case letters.

RIBBON

The Flexowriter is equipped with a Friden, black-inked nylon ribbon, 18 yards long, especially selected for strength, long wearing qualities, and rapid ink recovery.

A manually operated three-position switch (See figure 8) called the ribbon position lever, selects between upper and lower halves of the ribbon. The center position disengages the ribbon for stencil and other master preparation.

AUXILIARY CONNECTED EQUIPMENT

On the right side of the Flexowriter, there are two connectors (See figure 8). The input connector allows any one of 17 different auxiliary input units to be connected. The output connector allows connection of any one of 10 different output units.

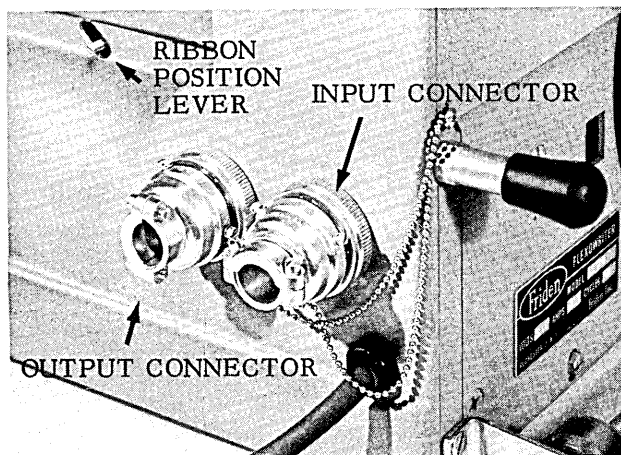

Figure 8. Input/Output Connectors and Ribbon Position Lever.

The ability to connect these additional units to the Flexowriter increases its versatility in application. Since additional units may be added at any time, the Flexowriter has the ability to expand any system to meet a customer's increasing business needs.

Auxiliary Input Units - These provide an additional reading source for the Flexowriter. All are code-controlled to provide completely automatic operation.

LIST OF AUXILIARY INPUT UNITS	
MODEL	DESCRIPTION
ATR	Auxiliary Tape Only Reader
ATR-SD	Auxiliary Tape Only Reader for Synchro-Duplex operation
ATR-D	Auxiliary Tape Only Reader with Manual Data Selector
ATR-D-SD	Auxiliary Tape Only Reader with Manual Data Selector for Synchro-Duplex operation
ATCR	Auxiliary Tape or Edge-Punched Card Reader
ATCR-D	Auxiliary Tape or Edge-Punched Card Reader with Manual Data Selector
ACR	Automatic Card Reader
ACR-D	Auxiliary Tab Card Reader with Manual Data Selector
STR	Selectadata Tape Only Reader
STR-SD	Selectadata Tape Only Reader for Synchro-Duplex operation
STR-D	Selectadata Tape Only Reader with Manual Data Selector
STR-D-SD	Selectadata Tape Only Reader with Manual Data Selector for Synchro-Duplex operation
STR-A	Selectadata Tape Only Reader with Automatic Address Selection
STR-A-SD	Selectadata Tape Only Reader with Automatic Address Selection for Synchro-Duplex operation
STR-AD	Selectadata Tape Only Reader with Automatic Address Selection and Manual Data Selector
STR-AD-SD	Selectadata Tape Only Reader with Automatic Address Selection and Manual Data Selector for Synchro-Duplex operation
ACEO-P	Auxiliary Accounting Keyboard

Auxiliary Reader units are described in the manual, "Flexowriter Model SFD." Auxiliary Tab Card Reader units are described in the manual, "Friden Tab Card Reader."

Selectadata Reader units provide the additional ability to search and select specific data from within a punched tape. These units are described in the manual, "Friden Selectadata Readers."

Reader units for synchro-duplex operation completely control Flexowriter operation and are described in the manual, "Friden Synchro-Duplex Readers."

These additional manuals, describing the auxiliary input units, are available at any Friden office.

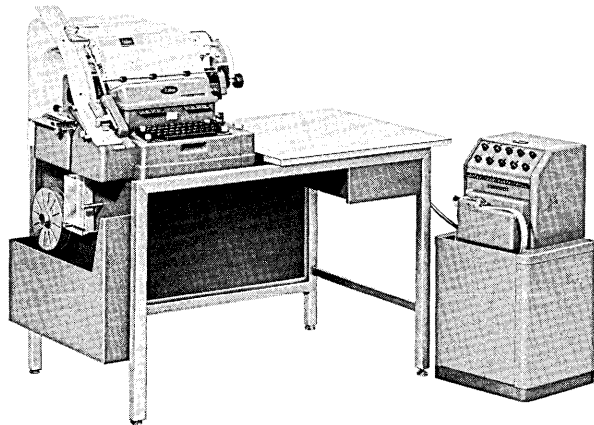

Figure 9. Flexowriter With Selectadata Reader.

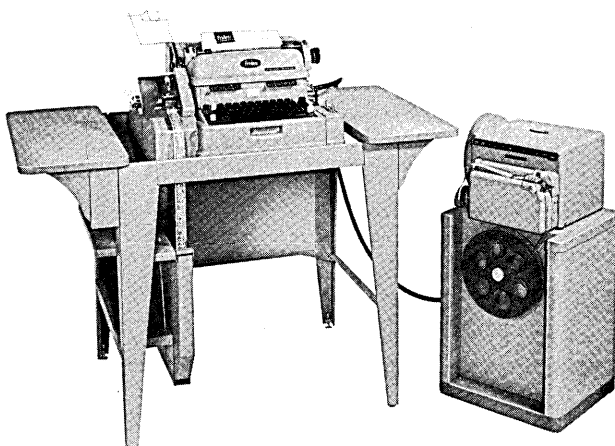

Figure 10. Flexowriter With Auxiliary Tape Punch.

Auxiliary Output Units - These units provide an additional output medium for the Flexowriter in one of these forms: a punched tape, edge-punched card, tab card, document, or adding machine tape. All output units are controlled by automatic or manual Flexowriter operation.

LIST OF AUXILIARY OUTPUT UNITS	
MODEL	DESCRIPTION
ATP	Auxiliary Tape Only Punch
ATP-S	Auxiliary Tape Only Punch with Selective Coding Switches
ATCP	Auxiliary Tape or Edge-Card Punch
ATCP-S	Auxiliary Tape or Edge-Card Punch with Selective Coding Switches
SRS	Systems Receiver Single Case Flexowriter
SRD	Systems Receiver Double Case Flexowriter
SRS-P	Systems Receiver Single Case Flexowriter with Tape Punch
SRD-P	Systems Receiver Double Case Flexowriter with Tape Punch
TCPC	Tab Card Punch Control Unit for connecting the Flexowriter to a Type 24 or 26 IBM Card Punch
ACS-P	Solenoid-Operated Friden Adding Machine

Auxiliary Punch units provide an additional selectively punched tape or edge-punched card from Flexowriter operation. These units are described in Section VI.

Systems Receivers are special receiver model Flexowriters which provide an additional writing machine output for the Flexowriter. Models SRS-P and SRD-P also provide an additional punched tape.

Model TCPC (Tab Card Punch Control) is a control unit for connecting a Flexowriter to a card punch, to produce 80-column tab cards as an additional output.

Model ACS-P (Solenoid-Operated Adding Machine) provides simple computation abilities for the Flexowriter. This unit accepts numeric information only, and can add, subtract, and give totals and sub-totals. An adding machine tape is produced with this operation.

All auxiliary output units are interchangeable on the Flexowriter with the exception of the Model ACS-P. Flexowriters must be factory or field-modified to accept connection of this unit. Units so modified may still use all Flexowriter outputs except the TCPC.

SECTION III

OPERATING FEATURES

GENERAL

In addition to all of the alpha-numeric and functional keylevers, the Flexowriter has controls for automatic operation. The function and operation of these controls is described in this section. A drawing of the keyboard (See figure 11), shows the location of these controls on the machine.

These operations can come either from manual operation of the Flexowriter keyboard, or automatically from codes read in the reader.

When this switch is in the OFF position, the punch cannot be operated.

The SELECT position allows the punch to be turned on and off by the punch control keylevers.

PUNCH CONTROL SWITCH



This is a three position toggle switch controlling the punch. When in the ALL position, all operations of the keyboard will be recorded as codes punched into the tape.

KEYBOARD PUNCH CONTROL

Three keylevers directly control punching from the keyboard, ON 1, ON 2, and OFF. These keylevers will punch their respective

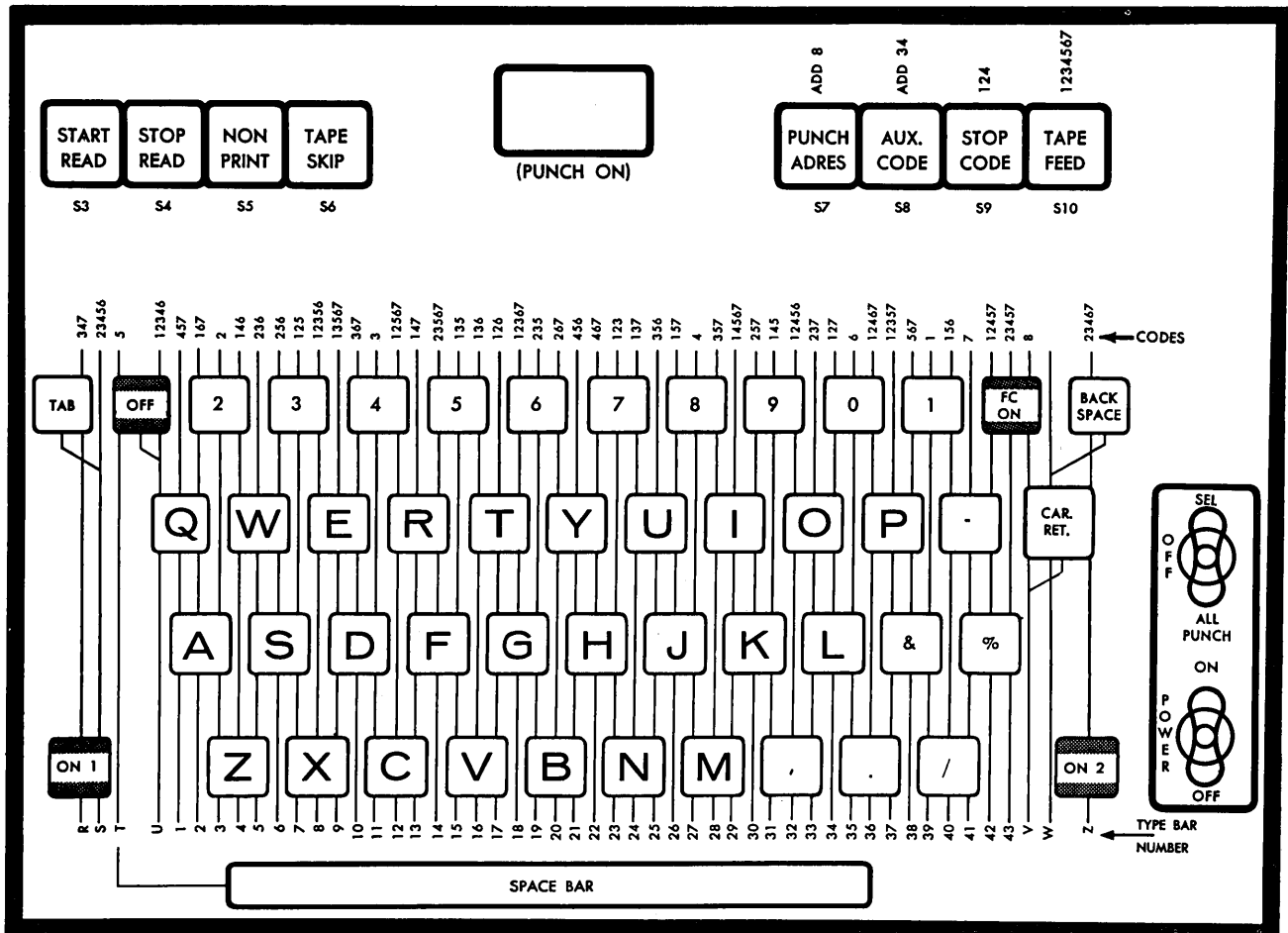

Figure 11. Flexowriter, Model SPS (Systems Programatic Single Case), Keyboard.

codes only when the punch control switch is in the ALL position. When the switch is in the SELECT position, these keylevers will perform their functions, but will not punch codes. They have no function when the punch control switch is in the OFF position.



ON 1 - Turns on the Flexowriter punch when operated manually or automatically, and the punch control switch is in the SELECT position.



ON 2 - Turns on the auxiliary output unit if one is connected.



OFF - Turns off both the Flexowriter punch and the auxiliary output unit.

Illustrations that follow show the effect of keyboard punch control when the punch control switch is in the SELECT position. Codes are read vertically, from left-to-right.

Read In Flexowriter Reader

O	O	X	X	X	X	O	Y	Y	Y	Y	O	Z	Z	Z	Z	O		
F	N					F					N					F		
F	1					F					1					F		

Punched At Flexowriter Punch

X	X	X	X	Z	Z	Z	Z											
---	---	---	---	---	---	---	---	--	--	--	--	--	--	--	--	--	--	--

The following assumes an auxiliary punch is connected to the Flexowriter.

Read In Flexowriter Reader

O	O	X	X	X	X	O	Y	Y	Y	Y	O	O	Z	Z	Z	Z	O	
F	N					F					N					F		
F	1					F					1					F		

Punched At Flexowriter Punch

X	X	X	X	Y	Y	Y	Y	Z	Z	Z	Z							
---	---	---	---	---	---	---	---	---	---	---	---	--	--	--	--	--	--	--

Punched At Auxiliary Punch

Y	Y	Y	Y															
---	---	---	---	--	--	--	--	--	--	--	--	--	--	--	--	--	--	--

FIELD PUNCH CONTROL

Both the Flexowriter punch and the auxiliary output unit can be turned on and off by the position of the carriage. This is accomplished through the use of the field control rack (See figure 12), located immediately behind the carriage.

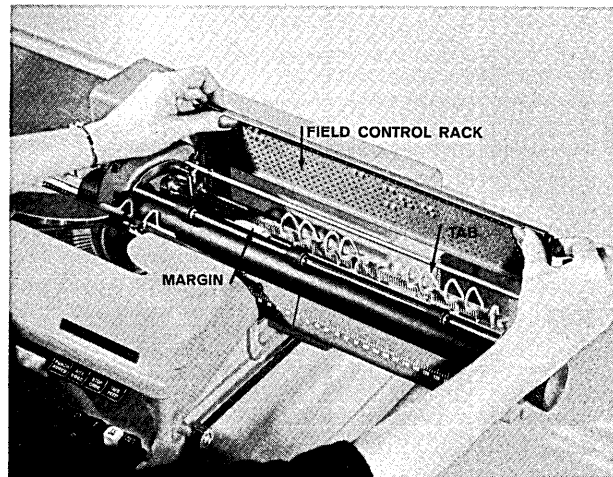

Figure 12. Inserting Field Control Rack.

The field control rack contains actuators (See figure 13) which control the Flexowriter punch and the auxiliary output unit by their position on the rack. As the carriage moves from right-to-left, these actuators come into contact with field switch rollers, which are in a fixed position. They operate to turn on and off the Flexowriter punch and the auxiliary output unit, provided the Flexowriter is in a field control condition. A small screwdriver is the only tool necessary to secure the actuators.



Operation of the FC ON keylever, either manually, or automatically by the code, places the Flexowriter into a field punch control condition.

It is not possible to have the Flexowriter under both field punch control and keyboard punch control simultaneously. If the Flexowriter has been previously under field punch control, an Off code (OFF keylever) must precede On 1 or On 2 codes. Before field punch control can again be used, an Off code

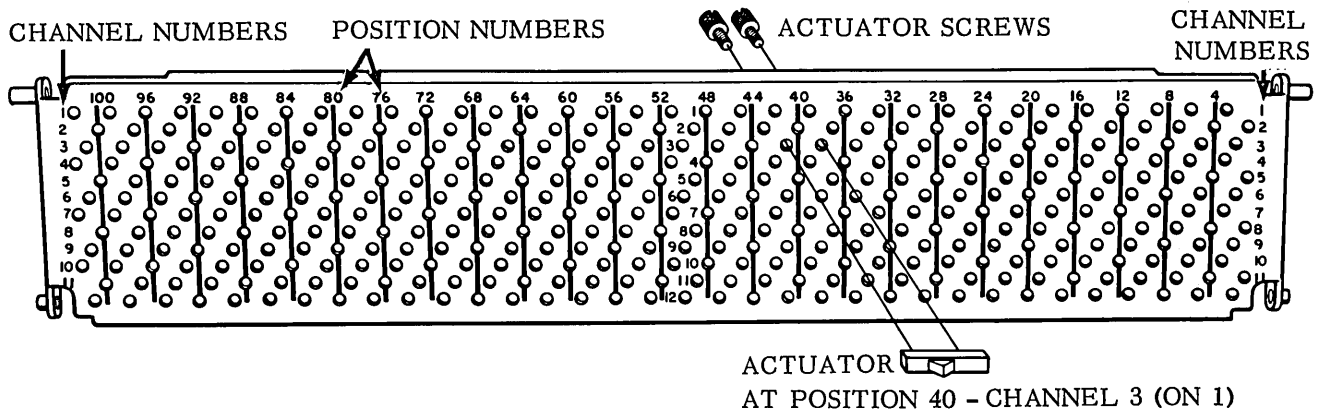

- CHANNEL 2 - Flexowriter Punch Off (1)
- CHANNEL 3 - Flexowriter Punch On (1)
- CHANNEL 5 - Auxiliary Output Unit Off (2)
- CHANNEL 6 - Auxiliary Output Unit On (2)

Figure 13. Field Control Rack, Actuators, Position Chart.

must terminate the keyboard punch control condition.

The following illustrates field punch control operation.

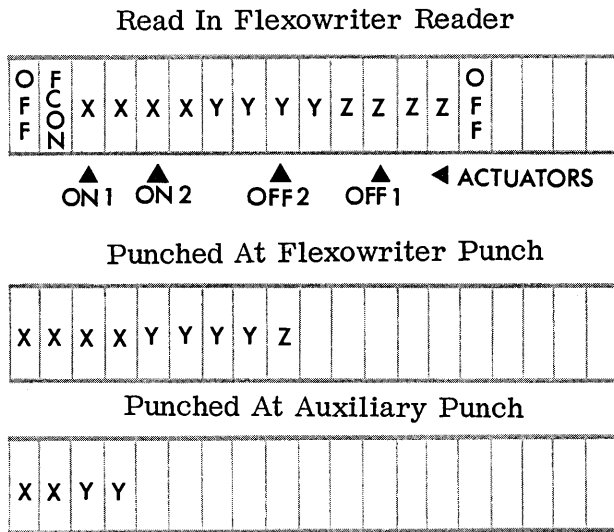

PANEL INDICATING LIGHT

The panel indicating light (See figure 14) is lit when the punch is on.

PANEL SWITCHES

There are eight panel switches (See figure 14), all of which are manually operated. They are as follows:

- START READ** - Touching and releasing this switch starts the reading action. Holding START READ depressed temporarily stops the reading action until it is released. This gives the operator the ability to pulse one code at a time through the reader, and is useful when updating tapes and cards.
- STOP READ** - Stops the reading action when touched.
- NON PRINT** - Causes the reader to be directly connected to the punch and to begin reading. All codes read in the reader will be reproduced in the punch. This includes codes normally ignored by the code translator, such as the Delete code. During this operation, there will be no printing, carriage movement, or other function of the Flexo-

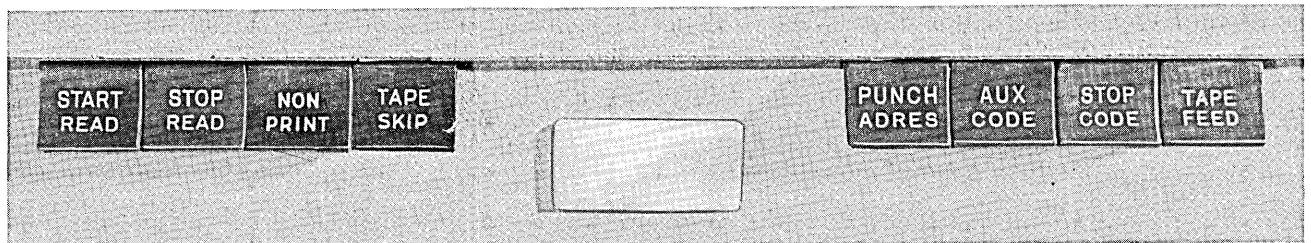

Figure 14. Panel Switches And Indicating Light.

writer. The punch must be on for code reproduction to occur.

This function is called a non print condition to differentiate it from the normal read condition, where printing and machine functions do take place. When the non print condition is caused by operation of the NON PRINT panel switch, this condition is termed manual non print.

The manual non print condition stops upon reading a Stop code, after reproducing that code. It can also be terminated by touching the STOP READ panel switch.

Manual non print is used for reproducing and updating cards and tapes.



TAPE SKIP - Causes tape (or cards) to cycle through the reader without causing printing, punching or any other function of

the Flexowriter. The skip condition is terminated upon reading the Tape Skip Restore code (page 14), or when STOP READ is touched. TAPE SKIP is used when data in the tape is to be by-passed under certain conditions, and read under other conditions.



PUNCH ADRES - Used for punching Address codes to be used with a connected Selectadata Reader.

To be operative this switch must be used in conjunction with a keylever operation. When PUNCH ADRES is held depressed, and a keylever is operated, the number 8 code hole is added to the code punched by that keylever.

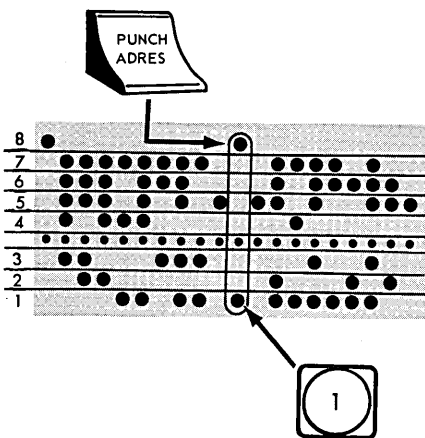

ADDRESS
1
CODE



AUX CODE - Used to punch auxiliary control codes. These are special codes used in conjunction with auxiliary input and output units, and certain Flexowriter functions.

AUX CODE operates in the same manner as PUNCH ADRES, except that it adds the number 3 and 4 code holes to the code punched by that keylever.

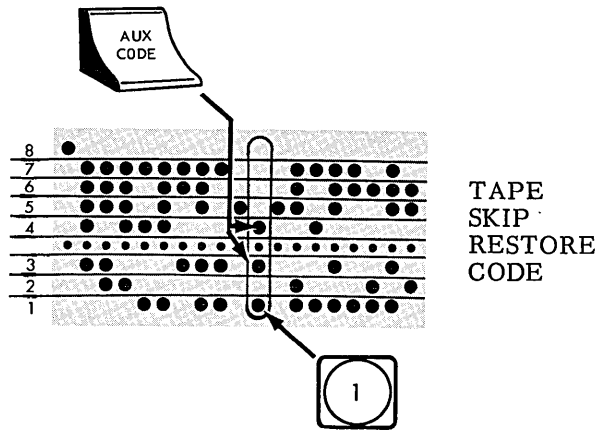

STOP CODE - Causes the Stop code (1-2-4) to be punched. When this code is read, it will stop the reading action. The Stop code is used to make manual entries within the document being typed. It also is normally used to end all punched tapes and cards.



TAPE FEED - Feeds tape through the punch as long as it is held depressed. The punch must be on for this action to occur, and this switch will not affect any connected auxiliary equipment. TAPE FEED is also used to delete incorrect codes, punching the Delete code (1-2-3-4-5-6-7).

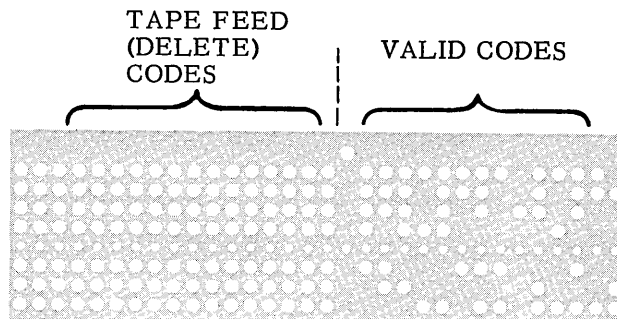

CODE REPRODUCTION

There are four methods of punching codes from the keyboard: keylevers, panel switches, keylevers plus panel switches, and manual overpunching.

Keylevers - Operating any of the alphanumeric or functional keylevers will punch codes if the punch is on. The only exceptions to this are the punch control keylevers (ON 1, ON 2, OFF, FC ON) which function, but do not punch when the punch control switch is in the SELECT position.

Panel Switches - Two panel switches punch codes when used by themselves, STOP CODE and TAPE FEED.

Keylever - Panel Switch - Two panel switches punch codes when accompanied by manual keylever operation, PUNCH ADRES and AUX CODE.

Overpunching - This method is used to punch special codes, and consists of overpunching one code with another. The tape is turned back in the punch to accomplish this, as illustrated in figure 15.

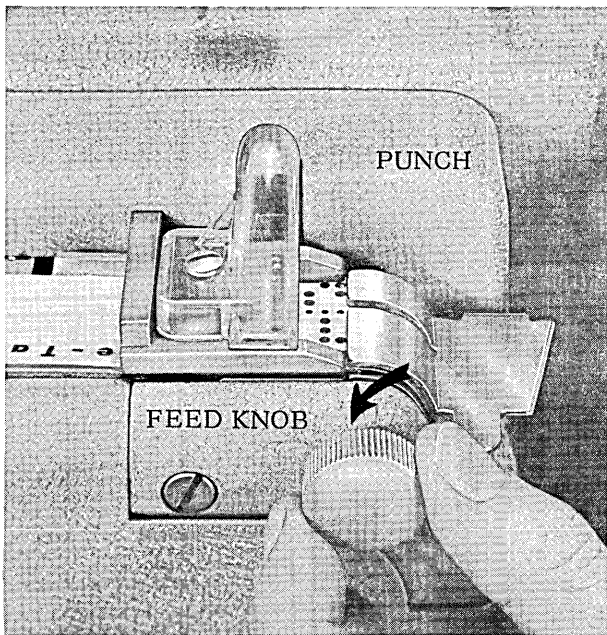

Figure 15. Closeup of Flexowriter Punch.

When codes, punched by these four methods are read in the reader with the punch on, only

those codes punched by keylevers alone will reproduce again in the punch. Such codes are termed *normally reproducing* codes. Codes punched by the other three methods are termed *normally non-reproducing* codes.

Knowing which codes are normally reproducing, and which are normally non-reproducing is an important factor in programming, the laying out of a specific Flexowriter application. Programming is further explained in Section VIII.

CORRECTING ERRORS

If the operator makes an error while punching tape it can be easily corrected. For example the word "number" is incorrectly typed as "numver".

1. Tape is turned back so that the incorrect code is over the punching station. This is done by using the feed knob (See figure 15). In this case the tape would be turned back one notch for "r", one notch for "e" and one notch for "v".

2. The TAPE FEED switch is touched to delete the three incorrect codes. This punches the Delete code (1-2-3-4-5-6-7) over each of these codes.

3. Then the correct letters "b", "e", and "r" are typed to produce visual copy which appears as "numverber". When the correct tape is read, however, the word will be typed correctly, with deleted codes simply cycling through the reader.

If a Model SPD Flexowriter (See Section IV) with a double case keyboard is used, it must be remembered that a capital letter requires three codes: Upper Case code, the letter code itself and a Lower Case code. Therefore, *three* Delete codes are required to delete a capital letter. A word in all capital letters requires one Delete code at the beginning of the word, one for each letter, and one for the Lower Case code at the end of the word.

For correcting edge-punched cards, see page 18, Section V.

AUXILIARY CONTROL CODES

There are several codes assigned to Flexowriter functions which are not found on the keyboard or among the panel switches. They must be manufactured by using the AUX CODE panel switch combined with a keylever operation. Three of these codes are used with standard Flexowriter operation, and are described below.

Tape Skip Restore (AUX 1) - Terminates the skip condition and restores the Flexowriter to a normal read condition. The skip condition is initiated by touching the TAPE SKIP panel switch.

Automatic Non Print (AUX Space) - When the Non Print code is read in the reader, the Flexowriter will go into a non print condition. If the punch is on, all codes read in the reader will be reproduced at the punch, except for the Non Print code which originated the condition. No printing, carriage movement, or other machine function will occur. The automatic non print condition is restored to a normal reading condition upon sensing a Print Restore code. Automatic non print is used to reproduce codes for a later operation.

The illustration below shows the operation of automatic non print. The code abbreviations not previously referred to, are: Non Print, Carriage Return, Address 1, Tape Skip Restore, Stop, and Print Restore.

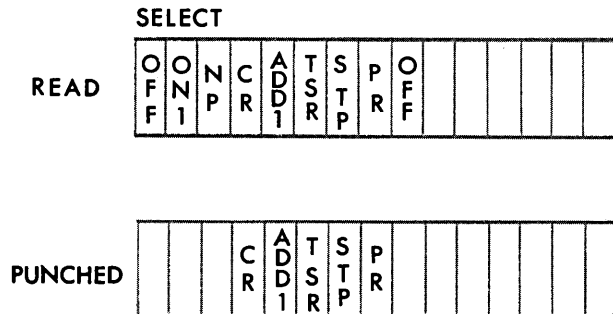

Note that several of these codes, reproduced under the non print condition, are normally

non-reproducing codes which would not be punched under a normal read condition. Also note that the Print Restore code punches before restoring the normal read condition. Neither the Carriage Return or Stop codes perform their assigned function in the automatic non print condition. They operate only to reproduce themselves.

In cases where a code is to be reproduced through more than one level of tape, an additional Non Print code is used for each level. The illustration below shows how this is done. All three tapes are punched and read with the punch control switch in the ALL position.

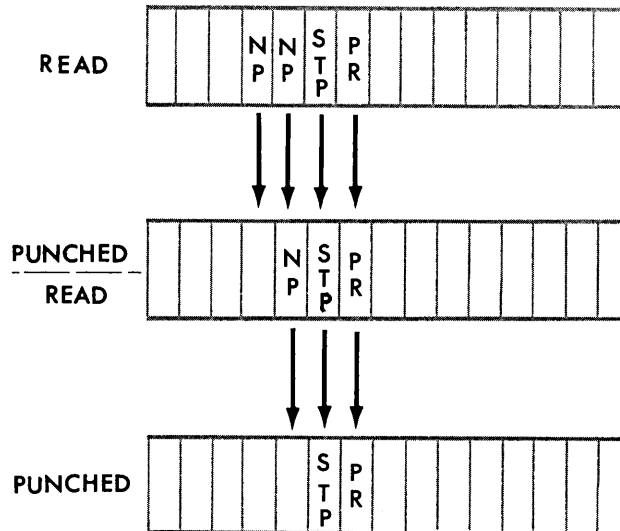

In order to gain a complete understanding of the Flexowriter, the difference between the manual non print condition and the automatic non print condition should be understood. Page 11 describes manual non print.

Print Restore (AUX Zero) - Restores the Flexowriter to a normal read condition from an automatic non print condition.

AUXILIARY CONTROL CODE SUMMARY		
FUNCTION	CODE	AUX CODE PLUS
Tape Skip Restore	1-3-4	1
Non Print (automatic)	3-4-5	Space
Print Restore	3-4-6	Zero

SECTION IV

FLEXOWRITER, MODEL SPD

GENERAL DESCRIPTION

The Flexowriter, Model SPD (See figure 16) is the double case (capital and small letters) version of the Model SPS, described on the preceding pages. Except for the differences described in this section, all specifications and operating features are identical with the Model SPS.

Model SPD (Systems Programatic Double Case) prints both capital and small alphabetic characters. It is used in systems applications where the Flexowriter is to be used for letterwriting applications on a part-time basis.

TYPE STYLE

Pica type style, with 10 characters to the horizontal inch, is standard on the Model SPD. Other type styles, however, are available. Refer to the catalog, "Friden Type

Styles", available at any Friden office for the alternatives.

Below is a sample of Pica type style. Block numerals are standard unless specified otherwise in the order.

A	B	C	D	E	F	G	H	I	J	K	L	M	N	O	P
Q	R	S	T	U	V	W	X	Y	Z						
a	b	c	d	e	f	g	h	i	j	k	l	m	n	o	p
q	r	s	t	u	v	w	x	y	z						
1	2	3	4	5	6	7	8	9	0						
@	#	\$	=	¢	?	*	()	'	"	_	;	:	.	,
&	%	-	/												

CASE SHIFT



The type basket shifts to select between upper and lower case characters (capital and small letters). Duplicate shift keylevers are provided on both sides of the keyboard (See figure 17).

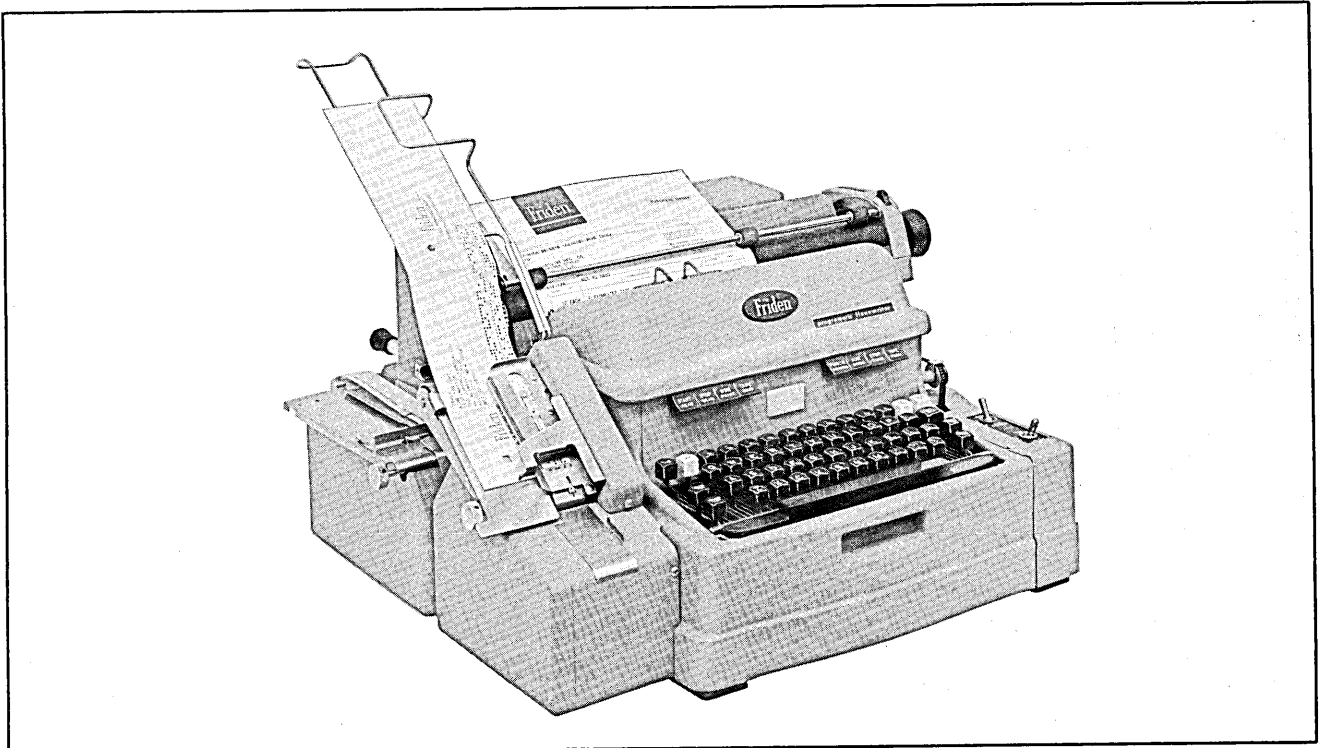

Figure 16. Flexowriter, Model SPD (Systems Programatic Double Case).

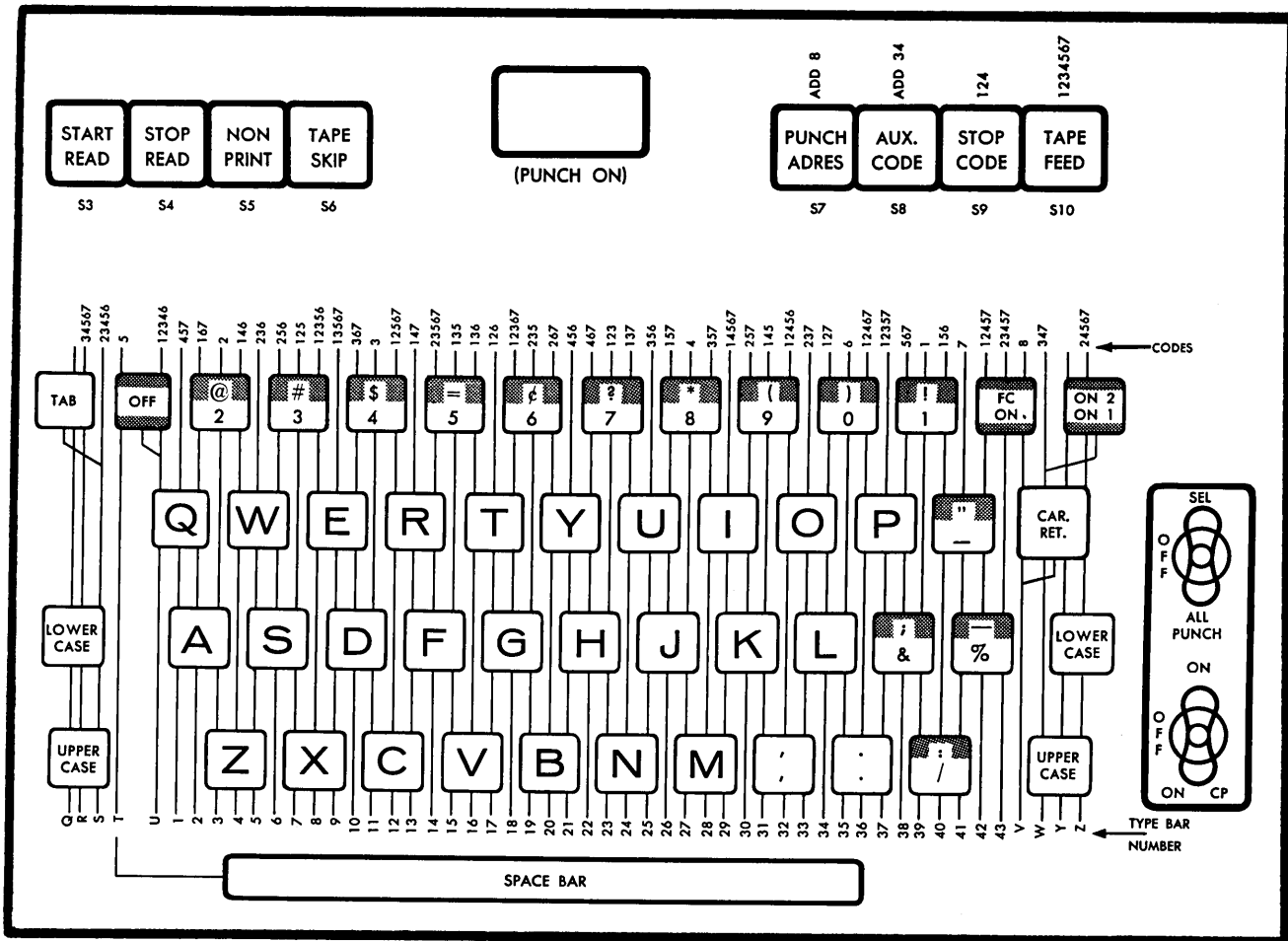
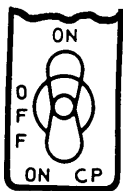

Figure 17. Flexwriter, Model SPD (Systems Programatic Double Case), Keyboard.

POWER SWITCH



The power switch on the SPD has three positions, ON, OFF, and ON CP.

In the ON CP position, those key-levers with the upper case position shaded on the illustration (See figure 17), will print but will not punch codes when in this shift condition. This applies to the special characters only, and not to the functional keylevers which are also shown in the illustration as shaded.

This feature is used when the Flexwriter is in a system involving other data processing equipment such as card punches and tape-to-card converters. This equipment often does not have the ability to recognize

case shift codes. Therefore, it cannot distinguish between an "@" and a "2", for example.

ON 1 - ON 2 KEYLEVER



When the SPD is in the lower case position, operation of this keylever turns on the Flexwriter punch, under the same circumstances as does the ON 1 keylever on the SPS (page 10). When in the upper case position, it turns on the auxiliary output unit if one is connected.

BACK SPACE

There is no keylever on the standard SPD to initiate back space. If one is desired, direct requests for details to the Friden Sales Order Department, Rochester, N.Y.

SECTION V

CUSTOMIZING THE FLEXOWRITER PROGRAMATIC

GENERAL

Provisions have been built in the Flexowriter (Models SPS and SPD) to permit the customizing of the machine to meet particular application requirements. This section describes the most common options available.

KEYBOARD ALTERATIONS

Alternate type characters are available in place of the standard characters shown in figures 11 and 17. The catalog, "Friden Type Styles," available in any Friden office, shows the alternate choices.

When the Flexowriter (SPD) is to be used primarily in applications involving the exclusive use of capital letters, the alphabet may be inverted. This puts capital letters, numbers and the most used special characters in the same case shift position. Machines with this feature are then referred to as having an inverted alphabet.

CODE REPRODUCTION

Normally, when the punch control switch is in the SELECT position, the codes for ON 1, ON 2, OFF, and FC ON do not punch, but operate only to perform their functions. An alteration can be made to cause these codes to both punch and function in this condition of the machine.

Non Print, Skip Restore, Tape Feed and other codes not found on the keyboard cannot be made to reproduce in the punch. They must be manually inserted each time.

TAPE SKIP

An alteration can be made to cause Carriage Return codes to be recognized and perform their function while the Flexowriter is in a skip condition. Normally, *only* the Skip Restore code is recognized in this situation.

PARITY CHECK

Since all 8-channel codes used with the Flexowriter have an odd number of bits (code holes), electrical circuitry can be installed to check whether each code punched meets this condition. This circuitry is called odd-count parity check, and provides the operator with a positive check against mechanical failure of the punch.

Construction of the Flexowriter is such that the possibility of error is very slight. The proved reliability of the punch makes parity check circuits unwarranted in the ordinary systems installation.

In certain instances, however, parity check is desirable. This is true in applications where the consequence of a mechanical error are extreme. In an installation involving a computer, even an isolated error can be intolerable. Where punched tapes are used locally, and soon after they are punched, the consequence of errors is not as severe as when the tapes are used at a later time, or at some remote location where it is difficult to refer to the original source for correction.

EDGE-PUNCHED CARD READER AND PUNCH

An edge-punched card reader and/or punch can be installed on the Flexowriter in place of the standard tape reader and punch (See figure 18). These units use both punched tape and edge-punched cards. Edge-punched cards are encoded along one or two edges with the same 8-channel code as is punched tape. Speed of insertion and removal, as well as simplified filing methods, make edge-punched cards particularly well adapted to systems applications.

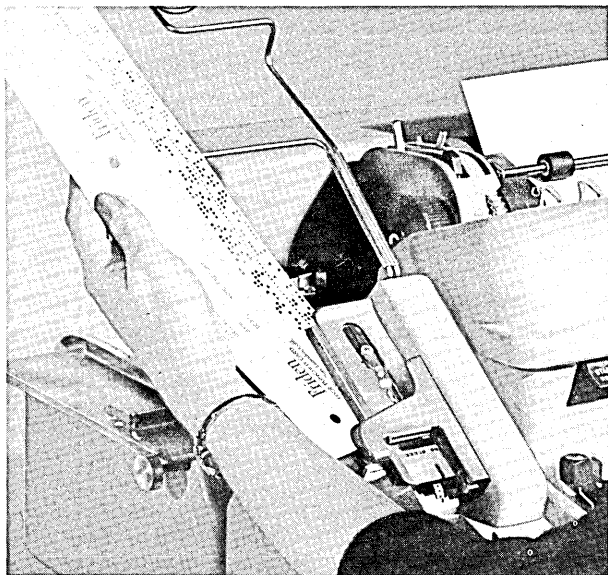

Figure 18. Edge-Punched Card Reader.

A complete description of available edge cards is found in Section VII, "Accessories and Supplies."

With edge cards in the punch (See figure 19), the TAPE FEED panel switch operates in a slightly different manner. Touching and releasing this switch will cause the next edge card to advance to the first punching position punching feed holes only.

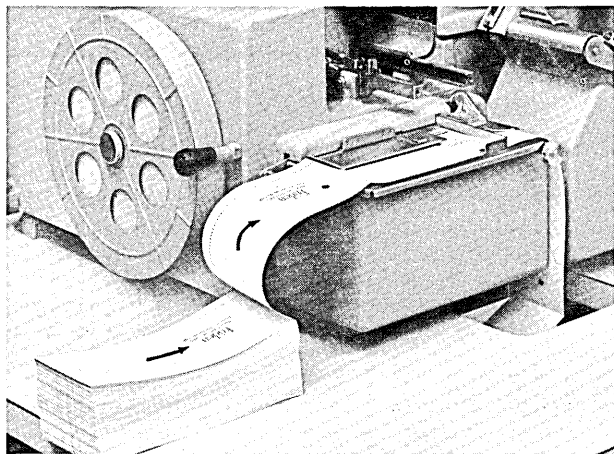

Figure 19. Edge Card Punch.

This means that when edge cards are being punched, TAPE FEED cannot be used to delete codes erroneously punched by the operator. Instead, the AUX CODE panel switch is used in conjunction with the "C" keylever for this purpose, punching the Delete (Tape Feed) code (1-2-3-4-5-6-7).

With tape in the punch (See figure 20), the TAPE FEED panel switch operates normally, punching the Tape Feed code as long as the switch is held operated.

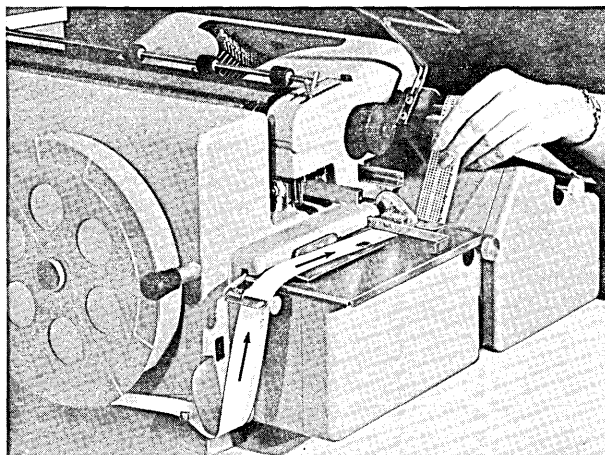

Figure 20. Tape In Edge Card Punch.

For mechanical reasons, the edge card punch cannot be installed on a Flexowriter equipped with a 20-inch carriage.

TAB CARD READER

A tab card reader (See figure 21) may be installed in place of the standard tape reader. This must be done at the factory prior to delivery. The tab card reader allows the Flexowriter to read tab cards punched with the Hollerith Code.

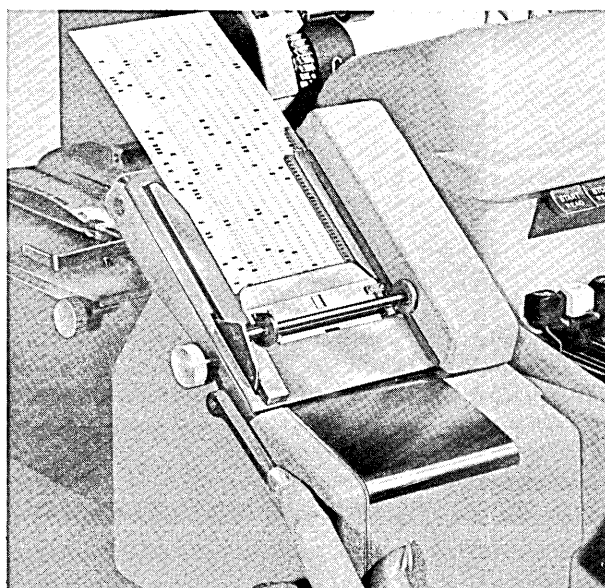

Figure 21. Tab Card Reader.

All Flexowriter functions have Hollerith Code equivalents (see code chart page 46), and all versatility of the Flexowriter is retained. The manual, "Friden Tab Card Reader", available at any Friden office, describes this unit in detail.

PIN FEED PLATENS

Pin feed platens (See figure 22) are available for factory or field installations on the Flexowriter. These platens have retractable pins at either end to accommodate continuous forms that are perforated on both sides to exactly match the pins (See figure 23). Designed by many different forms companies to fit specific applications, the forms themselves are usually made up of multiple copies interleaved with carbon paper.

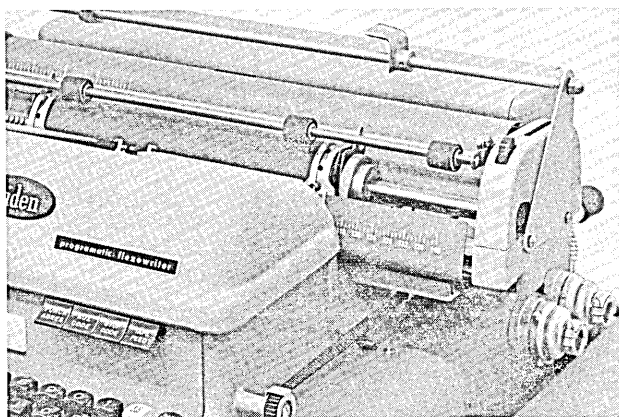

Figure 22. Pin Feed Platen On Flexowriter.

Positive registration is provided by the use of pin feed platens. That is, the writing areas match exactly on the original and all carbon copies. Also, the operator does not need to align each form separately.

When ordering pin feed platens, the overall form width to be used must be specified.

Pin-to-pin dimensions will be one-half inch less than this figure. On the chart (See figure 24) are the maximum form widths for pin feed platens and carriage lengths.

CONSTRUCTION	MAXIMUM FORM WIDTH		
	12" Carriage	16" Carriage	20" Carriage
REGULAR	10"	14"	18"
PIN TYPE VARIABLE	10-11/16"	14-11/16"	18-11/16"

Figure 24. Chart Of Form Widths For Pin Feed Platens.

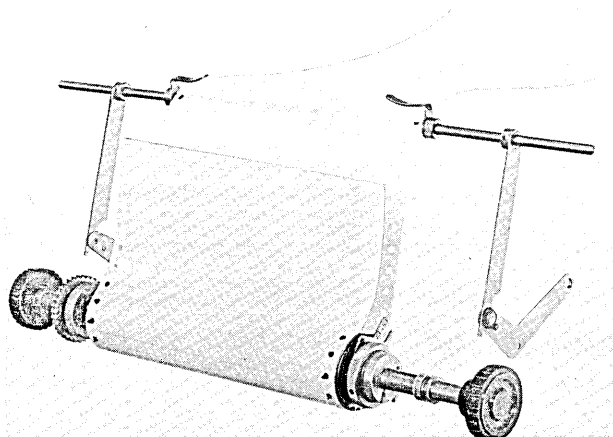

Figure 23. Pin Feed Platen.

A 33-tooth ratchet is standard on all pin feed platens, although 44, 55, and 66-tooth ratchets are available. The chart (See figure 5, page 5) gives the line spacing values for these alternate ratchets.

FRIDEN FLEXOFEED

The Friden Flexofeed (See figure 25) is so named because it allows both different size continuous and standard forms to be easily interchanged on the Flexowriter. When the Flexofeed is in position, continuous forms may be used. Otherwise it is easily detached to accommodate standard forms.

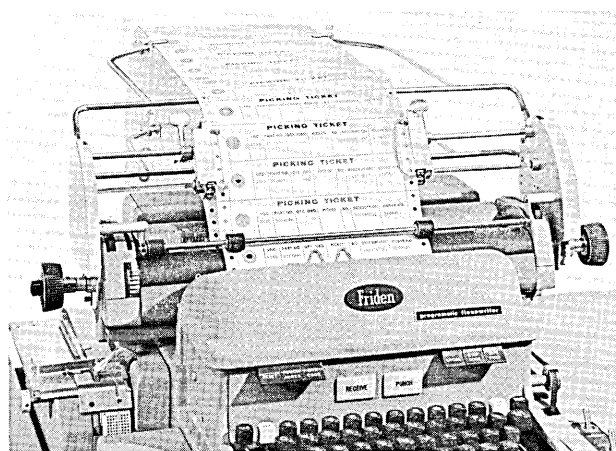

Figure 25. Flexofeed On Carriage.

No special tools are necessary to adjust the Flexofeed for forms of different widths. Thumb screws are provided for operator convenience to make these changes.

In conjunction with the Flexofeed, a forms stand (See figure 26) is also available.

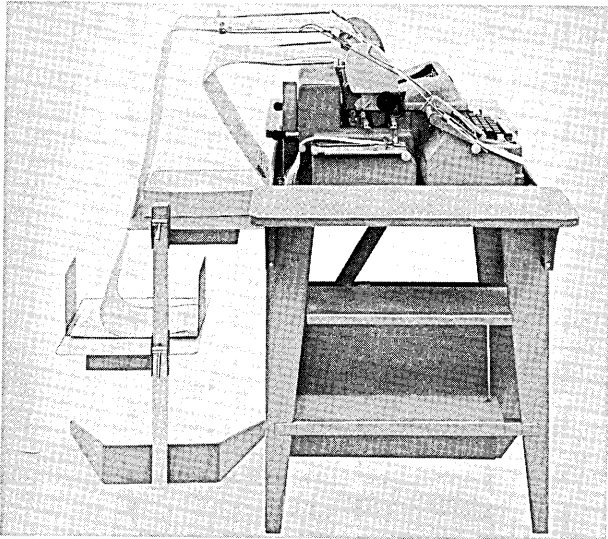

Figure 26. Forms Stand.

It holds continuous forms for convenient handling. Two shelves are easily raised or lowered to suit forms of different weights.

ELECTRIC LINE FINDER

An electric line finder (See figure 27) may be installed on the Flexowriter. It includes the pin feed platen (page 19), and is used to simplify the handling of continuous forms. An electric motor powers platen movement so that only one operation is necessary to move from one writing line to the next, wherever it is located on the form.

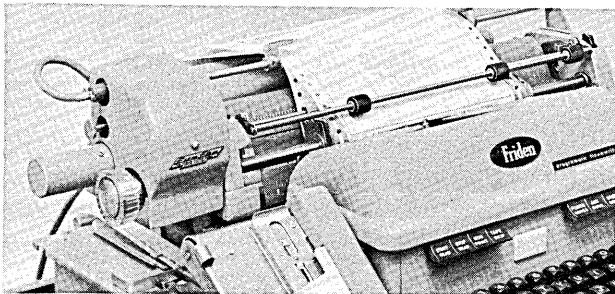

Figure 27. Electric Line Finder.

If desired, the electric line finder may be code controlled. AUX CODE plus the "L"

keylever is used for this purpose. If the code must be reproducing, type bar #38 (See figures 11 and 17) is used for this purpose, and is coded 1-2-3-4-7.

LINE SKIP

Line skip may replace tape skip if desired. This feature functions similar to tape skip, with the exception that each operation of the TAPE SKIP panel switch causes the Flexowriter reader to cycle through the tape or edge-punched card to the next Carriage Return (8th bit) code. No punching, writing, or carriage motion takes place during line skip function.

SECOND STOP - SELECTIVE

This optional feature gives the ability to selectively recognize two different Stop codes in the reader. A selective stop (or STOP 2) panel switch replaces the PUNCH ADRES panel switch. When locked in the operated position, this switch causes the Form Feed code (1-2-3-4-7) to be recognized as a Stop code.

CODED BACK SPACE

The BACK SPACE keylever (on the Model SPS) may be factory or field modified to punch a code (2-4-6) and operate automatically from the reader.

RIBBON SHIFT

This feature is used with the black and red ribbon on the Flexowriter to differentiate entries made on a document. It can be installed in one of two forms:

Mechanical Ribbon Shift - A keylever is assigned for this purpose. Manual or automatic operation of the keylever causes the ribbon to shift.

Magnetic Ribbon Shift - Operates automatically through a specified phase of Flexowriter operation, and cannot be controlled by the operator. Normally, it is used to distinguish between manual and automatic entries on a document.

SECTION VI

AUXILIARY PUNCHES

GENERAL

The Flexowriter (Model SPS and SPD) has an output connector to which may be attached any one of 10 different auxiliary output units (See page 8). Four of these are classified as Auxiliary Punch units, and provide an additional punched tape or edge-punched card as a by-product of Flexowriter operation. The four models are:

- ATP - Auxiliary Tape Only Punch
- ATP-S - Auxiliary Tape Only Punch with Selective Coding Switches
- ATCP - Auxiliary Tape and Edge Card Punch
- ATCP-S - Auxiliary Tape and Edge Card Punch with Selective Coding Switches

All auxiliary output units are automatically controlled by the On 2 and Off codes, and certain conditions of field punch control (See figure 13).

Complete specifications and operational features for the Auxiliary Tape or Edge Card Punches are described in this section.

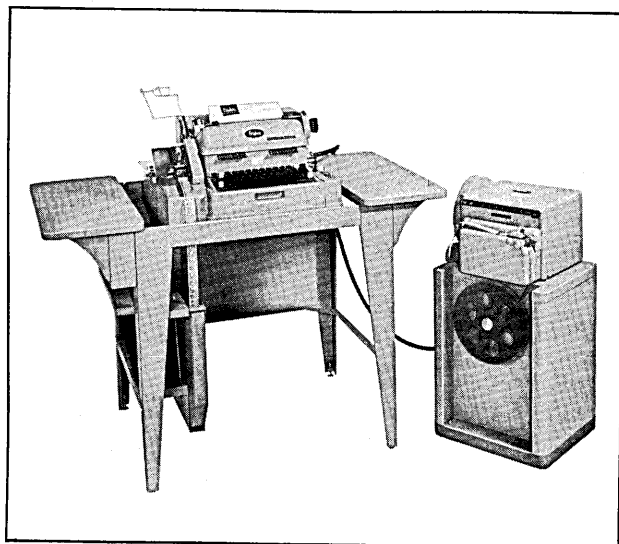

Figure 28. Flexowriter, Auxiliary Tape Punch.

SPECIFICATIONS

Power - All Auxiliary Punch units contain their own power supply, independent of the connected Flexowriter: 110-115 volt, 60 cycle AC.

Size - 27" high (with stand), 13" wide, and 14" long.

Weight - Approximately 26 pounds without the stand.

Tape Supply Spool (See figure 29) - Holds one roll of tape (approximately 1000 feet). One thousand feet of tape will hold 120,000 codes (10 codes per inch).

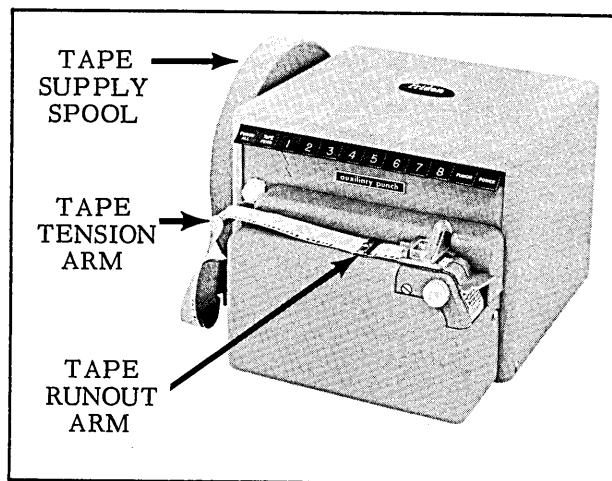

Figure 29. Auxiliary Tape Punch With Selective Coding Switches.

Tape Tension Arm - Acts as a safeguard against tape feeding failure. If an obstruction should interfere with proper tape feeding in the Auxiliary Punch, the tape tension arm will cause the connected Flexowriter to become locked against further operation.

Tape Runout Arm (Models ATP and ATP-S) Guards against the Auxiliary Punch running out of tape without the operator's knowledge. This arm is held in place by tape feeding through the Auxiliary Punch.

UNIVERSAL CABINET STAND

Auxiliary Punch units come with the universal cabinet stand (See figure 30). This stand is mounted on wheels for mobility, and contains two shelves in the rear.

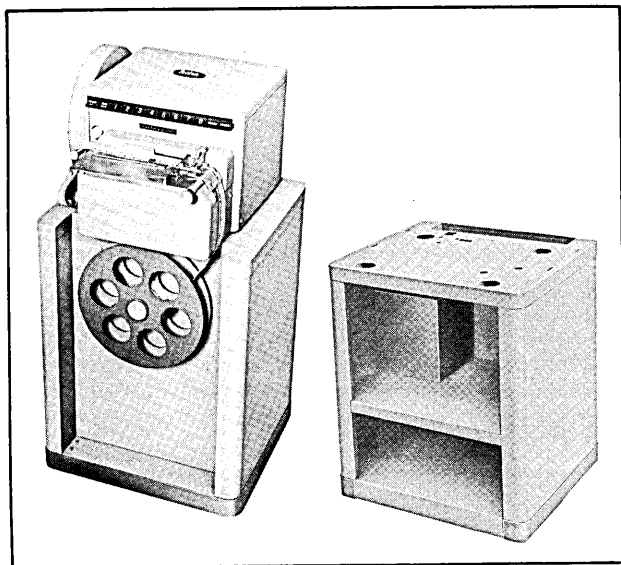

Figure 30. Auxiliary Tape And Edge Card Punch (Model ATP-S) On Stand, Front And Rear View Of Stand.

As an optional feature, a tape winder (shown in figure 30) is available.

OPERATIONAL FEATURES

The following features pertain to operation and manual control of the Auxiliary Punch.



POWER - This is a locking-type switch. When depressed it turns on the power.



PUNCH ALL - This is a locking-type switch which operates similar to the punch control switch on the Flexowriter (See figure 11).

If the punch control switch is in the ALL or OFF position, and PUNCH ALL on the Auxiliary Punch is operated (down), all operations of the Flexowriter will be recorded as codes in the tape at the Auxiliary Punch.

Similarly, if the punch control switch is in the SELECT or OFF position, and PUNCH ALL is in the not operated (up) position,

punching at the Auxiliary Punch will be controlled by the On 2 and Off codes, and certain conditions of field punch control.

If PUNCH ALL is operated and the punch control switch is in the SELECT position, all operations of the Flexowriter will punch at the Auxiliary Punch. In the Flexowriter, punching will occur after the first On 1 code, and all following codes, including any additional On 1 codes will punch. The Off code also will punch before turning off the Flexowriter punch.

The reverse is true if the punch control switch is in the ALL position, and PUNCH ALL is not operated. In the Auxiliary Punch, all codes following On 2 will punch, and the Off code will also punch before turning off the Auxiliary Punch.

Under these conditions, the Fc On code will operate in the same manner as On 1 and On 2.



INDICATING LIGHT - Glows when the Auxiliary Punch is operating, or ready for operation.



TAPE FEED - With tape in the Auxiliary Punch, touching this switch will cause tape feeding as long as the switch is held depressed. With edge cards in the Auxiliary Punch (Models ATP and ATP-S), touching and releasing this switch will cause the next edge card to be positioned for punching. This switch operates independently of TAPE FEED on the Flexowriter.



5 SELECTIVE CODING SWITCHES (Models ATP-S and ATP-S) - These eight switches correspond to the eight code channels and allow codes to be manufactured. To punch the Non Print code, for example, depress the numbers 3, 4 and 5 selective coding switches and touch PUNCH.



PUNCH - Used with the selective coding switches to cause the selected code to punch. This panel switch is effective for the Auxiliary Punch only.

SECTION VII

ACCESSORIES AND SUPPLIES

GENERAL

This section provides a description of the accessories and supplies available for all Flexowriters.

ACCESSORIES

The following accessories are made especially to be used with Flexowriters. They can be ordered from any Friden office.

Desks (See figure 31) - There are three available, to hold the Flexowriter at the correct working height from the floor, and to provide ample workroom area. They also hold accessory equipment, and collect chad (perforations) from cards and tape.

"A" is an all metal desk 40-1/2" wide, 28" high, and 24" deep. An alternate desk,

42-3/4" wide is offered for Flexowriters equipped with edge-punched card or tab card units. Shelves are 10" wide and 24" deep. Optional shelves 18" wide are also available. Color is Friden Tan Armorsol.

"1" is a desk with formica top. Provides easy access to tape handling area, plenty of leg room and a drawer for operator convenience. Measures 43" wide, 27-1/2" high, and 25" deep. Finish is beige top, padre brown siding and work area, and brushed aluminum legs.

"2" is a desk similar in construction and color to "1". The Flexowriter rests in the middle with work areas on both sides. The left work area slides out for easy access to the tape handling area. It measures 55-1/2" wide, 27-1/2" high, and 25" deep.

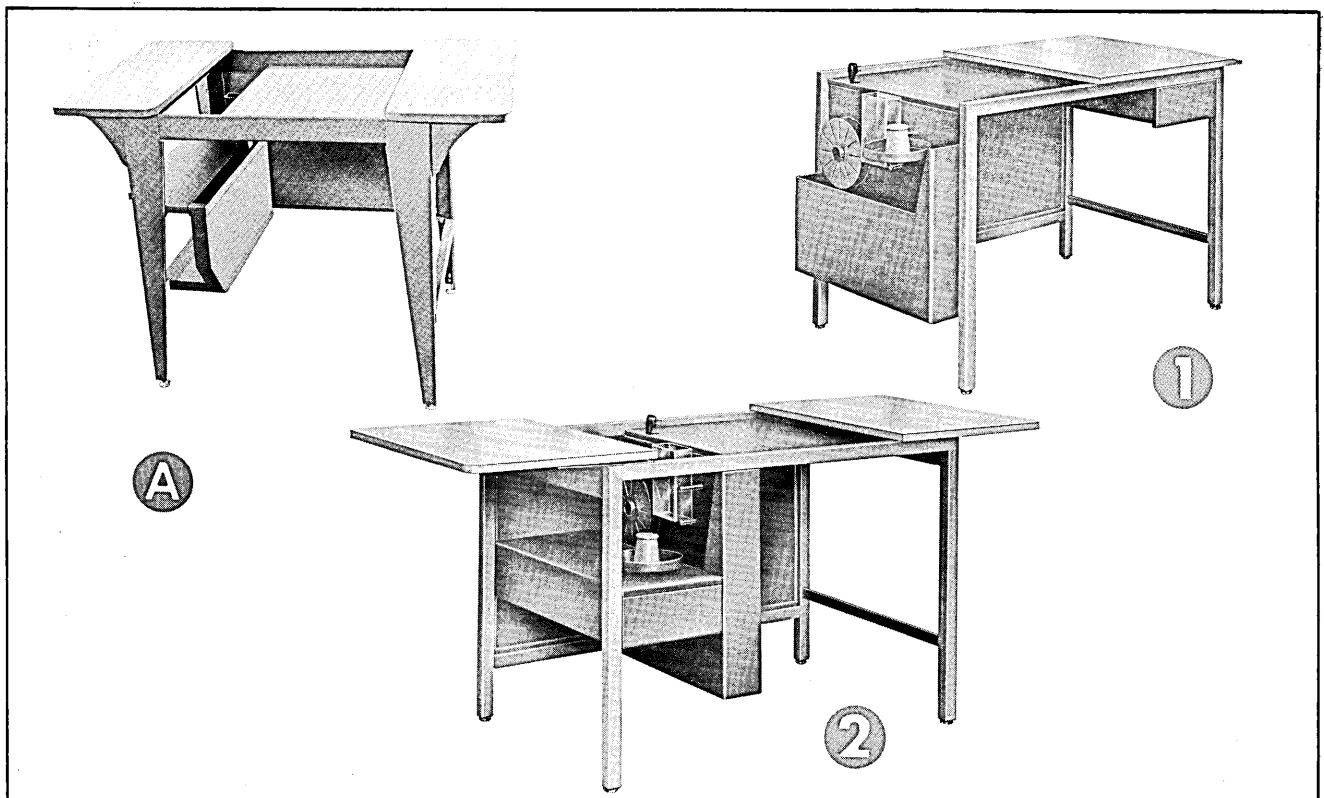

Figure 31. Friden Flexowriter Desks.

Tape Winder (See figure 32) - Used to wind tape in a continuous roll as it comes from the punch or reader. The tape winder is a sturdy, motor driven unit. A special power cord is provided to plug into an outlet on the Flexowriter. When connected, the tape winder operates only while the punch is operating. The feet of the tape winder are drilled for fastening to any Flexowriter stand or desk (See figure 31).

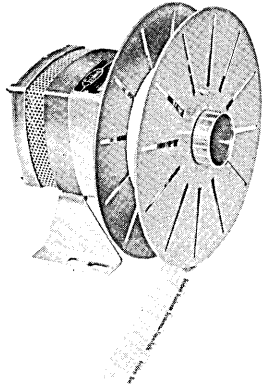

Figure 32. Tape Winder.

Tape Unwinder (See figure 33) - Holds rolls of punched tape for feeding into the reader. Tape unwinds from the inside out, as it comes from the tape winder. The tape winder may be attached to any Flexowriter stand or desk.

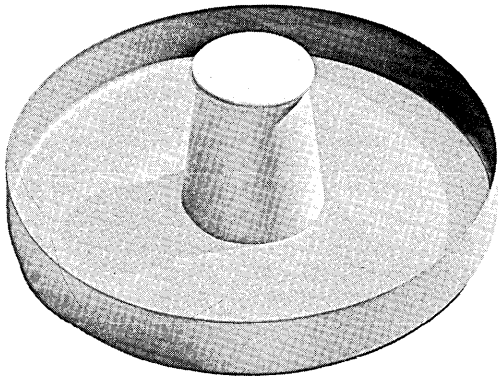

Figure 33. Tape Unwinder.

Label Holder (See figure 34) - Allows labels (See figure 43) to be fed directly into the platen of the Flexowriter. The label holder is designed so that machine operation is not hindered. Labels may be typed manually or automatically as the corresponding edge card is being punched. Since the label holder moves with the carriage, no horizontal

creepage of the labels will result. It is available for all carriage lengths, and is easily removed when it is not being used.

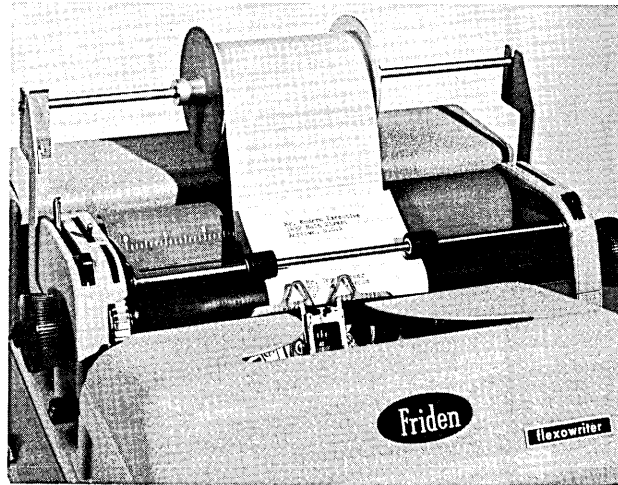

Figure 34. Label Holder On Carriage.

Edge-Punched Card Cutter (See figure 35) - Specifically designed for the precision cutting of edge-punched cards. Continuous packs of these cards may be cut into units of one, two, or three cards, easily and accurately. A single movement of the self-sharpening, double-edged wheel, removes the entire folded section, leaving a perfect edge on the card. The cutting wheel is guarded for safe operation.

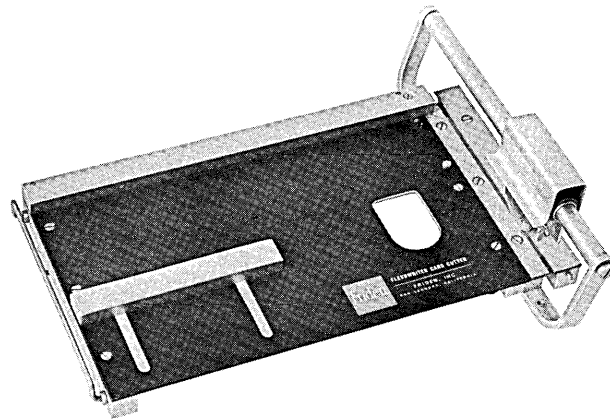

Figure 35. Edge-Punched Card Cutter.

Extended Card Guides (not shown) - Used to accommodate extra wide edge-punched cards. Extended card guides are available for the edge-punched card reader, punch, and all auxiliary units that use edge-punched cards.

SUPPLIES

Supplies are ordered from local Friden Service Departments as needed. They include the following:

Flexowriter Tape (See figure 36) - Available in three widths 11/16" (5 channels), 7/8" (6 and 7 channels), and 1" (8 channels). Paper tape is oil-impregnated for flexibility and long wear. It is not injured by folding, and is ideally suited for mailing, filing and long term storage. Paper tape comes in rolls, eight inches in diameter, holding approximately 1000 feet. Six colors are available to the customer: pink, yellow, green, grey, blue, and buff.

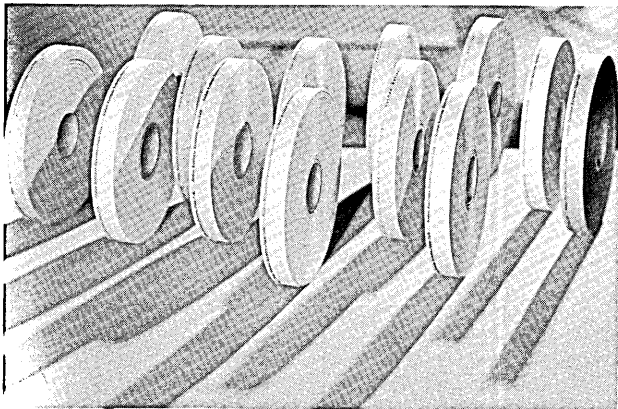

Figure 36. Flexowriter Tape.

A variety of tapes for special uses are also available (not shown). Dura Tape is a tough, vulcanized fiber tape for durability and long wear. Mylar* tape is paper, bonded to plastic, and is extremely tough and long lasting. Metalized Mylar* tape has a thin coating of aluminum and is used in machine tool control devices. Photoelectric tape is used in photoelectric code sensing devices. Prefolded paper tape is accordion-folded, ready for immediate filing after being punched, and comes in boxes rather than rolls.

Edge Cards (See figure 37) - Used in Flexowriters equipped with the edge-punched card reader and/or punch. These cards are made of a superior, wear-resistant card stock to assure maximum life. They are available with marginal feed hole punching on either one or both sides. With reasonable care, each card has a life of from 800 to 1000 passes through the reader.

*Dupont registered trademark

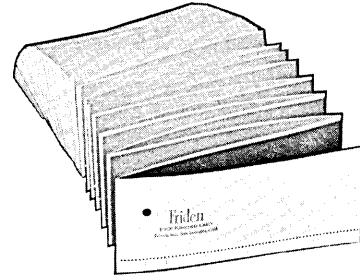

Figure 37. Edge Cards.

Friden Mylar* edge cards, with the same qualities as the tape, are also available.

Edge cards are 7" long and 3" wide, fan-folded in continuous packs of 250. Six colors are available: pink, yellow, white, grey, blue and green. In general, each card has the same code capacity as tape, 10 codes per inch. However, two code positions are lost in the card cutting operation (See figure 38). Therefore, a single edge-punched card holds 68 codes; a sequence of two cards contains 138 codes, and three cards joined together hold 208 codes.

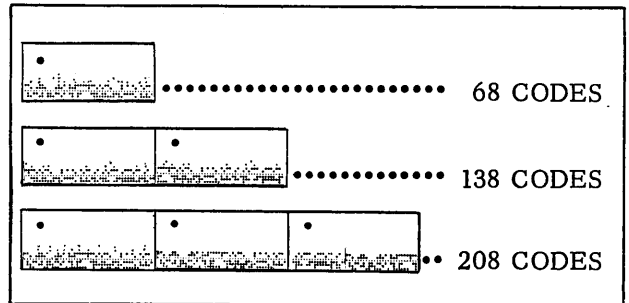

Figure 38. Code Capacity Of Edge-Punched Cards.

Ribbons (See figure 39) - Especially adapted to the high-speed operation of the Flexowriter. All fabric ribbons are tested for durability, clean reproduction, and fast ink recovery.

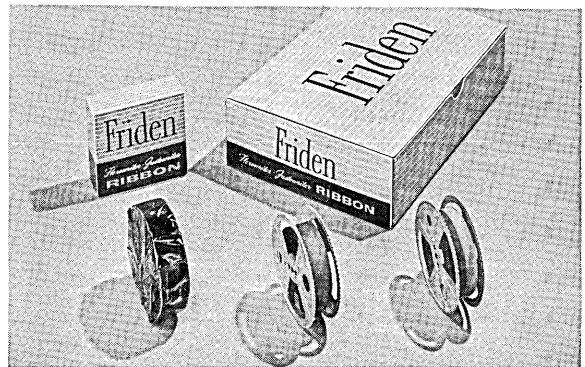

Figure 39. Friden Fabric Ribbons.

Friden fabric ribbons are 18 yards long and 9/16" wide. They are available in either nylon or silk, in all black or a combination of black and red (See figure 40). Number 50 ink density is standard for Flexowriters equipped with Manifold No. 10 or Pica type styles. Ink densities of 40 (elite type styles) and 60 (bold face styles) are available. Also available are a blue ribbon, and a special ribbon for direct image master preparation.



Figure 40. Black And Red Flexowriter Ribbon.

Tape Filing Boxes (See figure 41) - Provide easy filing and identification of tapes. They are glassine-lined for preservation of oiled tapes, and are available in two sizes: 4 inches square and 6 inches square. The 4-inch box holds 150-200 feet of punched tape. The 6-inch box holds 450-500 feet of tape.

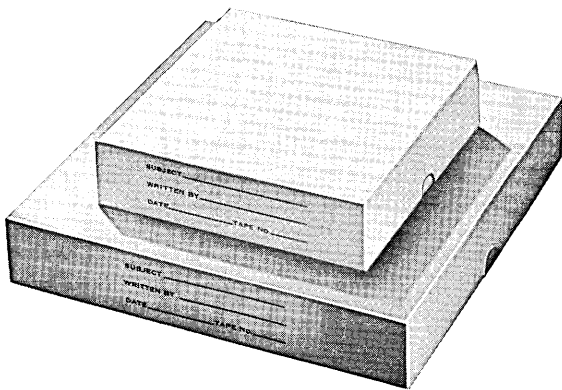

Figure 41. Tape Filing Boxes.

Tape Envelopes (See figure 42) - Used for filing and preserving shorter strips of punched tape. Each envelope is transparent and measures 2" x 9-1/2". Envelopes are extra long to permit open end to be folded, stapled, or clipped to source document.

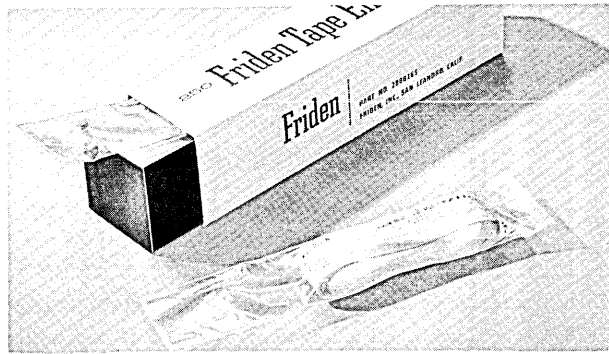

Figure 42. Tape Envelopes.

Pre-Gummed Labels (See figure 43) - Provide easy identification of edge-punched cards. One quick motion removes the label from the carrier strip. An adhesive of excellent quality assures permanent adherence of the label to the card. Labels are available in rolls of 250, in a variety of sizes ranging from 1" x 4" to 2" x 7".

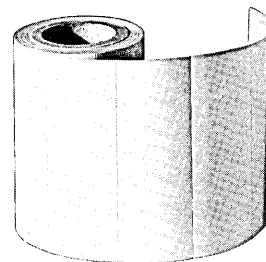

Figure 43. Pre-Gummed Labels.

Tape Cement (See figure 44) - Especially made to splice punched paper tapes when a continuous (looped) tape is required. Tape cement is easily applied, water soluble, and adheres strongly. It comes in plastic, squeeze-type containers holding two ounces. Tape cement is not to be used with Mylar* tapes, but is highly satisfactory for all paper tapes, oiled or plain.



Figure 44. Tape Cement.

*Dupont registered trademark

SECTION VIII

PROGRAMMING

GENERAL

Programming is the planning on paper of the details of an application. It consists of a step-by-step breakdown of all Flexowriter and operator functions.

Some examples of basic Flexowriter programming are described in this section. They are not to be considered comprehensive nor are they meant to suggest application limitations. Knowledge of these principles will enable the user to gain maximum benefit from the Flexowriter and auxiliary equipment employed.

Complete details of programming are described in the "Step-by-Step Programming Manual" obtainable at any Friden office. It should also be studied carefully to fully understand the flexibility of programming available for Flexowriter applications.

ILLUSTRATION I - FLEXOWRITER

In order to approach a programming problem intelligently, the programmer should first be aware of the system. Drawing a flow chart is helpful in understanding what has to be done.

For an illustration of the basic principles of programming a purchase order will be prepared on the Flexowriter equipped with edge-punched card reader and punch. Purchase order preparation often will involve constant data, repetitive to each vendor and item, such as names and addresses, product descriptions and shipping instructions. This problem can be solved easily by using edge-punched cards or tapes for data input. They will produce automatic document typing free from error.

In this case, the management of the company purchasing the goods desires a method of automatically obtaining a report upon what

they are committed to purchase. The programmer must, in his planning, arrange for a by-product select tape to be punched at the same time the purchase order is being automatically written. This select tape, when completed, will be inserted in a tape-to-card converter to produce tab cards which, in turn, are used to create the commitment report automatically.

The flow chart (See figure 45) illustrates the overall system of this purchase order writing application, showing the five steps needed to arrive at the finished products -- purchase order, select tape, tab cards and report. Edge-punched cards, containing all of the repetitive data are created to write most of the purchase order automatically. Only a few manual entries by the operator are ever needed.

As an initial part of the procedure, the programmer should collect samples of the materials with which he is working. These would include copies of the purchase order form, complete with real or dummy information, and the layout of the tab cards.

Two different types of edge-punched cards are created and used in this application -- vendor edge-punched cards and item edge-punched cards. Vendor edge-punched cards contain all of the repetitive information (constant data) about the vendor, plus codes to control horizontal and vertical line spacing. Punch control codes are also included to produce the select tape.

One item edge-punched card is created for each item purchased by the company. Each of these cards contain constant information about that item plus format and punch control codes.

The purchase order form (See figure 46) is noted with the margin and tab stop settings.

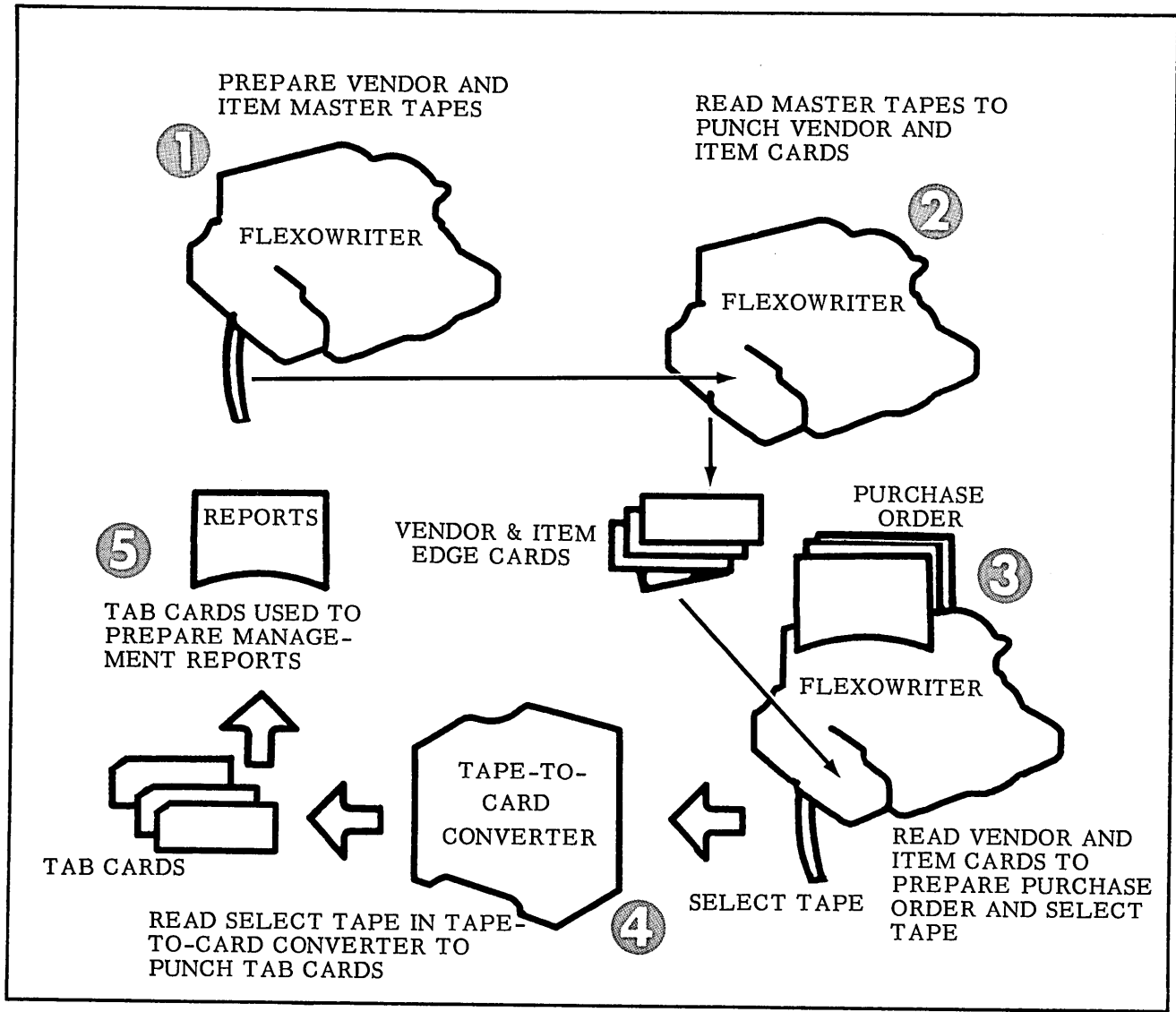

Figure 45. Flow Chart - Purchase Order System.

All data entered by the operator is circled or otherwise indicated. This information is referred to as variable data.

Laying out the program by which the Flexowriter proceeds through the application is now the job of the programmer.

As indicated on the above flow chart, three steps are necessary to prepare the purchase order and the select tape. The first two steps are only done once. From then on only the third step is ever necessary to prepare any purchase order for this particular vendor.

PREPARATION OF MASTER TAPES

1 If only one vendor were ever to be used, this step would be unnecessary. However, most companies purchase staple items from a large number of vendors. Master tapes allow edge-punched cards to be made, containing data about each vendor and each item purchased. Master tapes themselves cannot contain any of the data printed on the purchase order, since this will vary, depending upon the purchase order, and the particular vendor and items to be used. These tapes can, however, contain all functional coding, that is: all horizontal and vertical line spacing; stop codes for entering data, con-

PURCHASE ORDER

VENDOR NO. 704108	F.O. NO. 9879876	P.O. DATE 06/01/62	SHIP VIA ACME TRUCK	F.O.A. DEST.
TO: PROGRESSIVE MFG. CO. 100 FRIDEN STREET ANYTOWN, U.S.A.			PURCHASE ORDER NUMBER MUST APPEAR ON ALL PAPERS AND PACKAGES. PACKING-SLIP MUST ACCOMPANY SHIPMENTS. ALL INVOICES MUST BE RENDERED IN DUPLICATE	
DELIVERY 06/15/62		TERMS NET 30 DAYS		
QUANT.	UNIT	MATERIAL DESCRIPTION	CODE	PRICE
10	EA	FLEXOWRITER TAPE CEMENT, PART NO. 1052470	9078	.50
1	DOZ	NO. 50B FABRIC RIBBON FOR FLEXOWRITER	5097	25.50
100	ROLL	PINK PAPER TAPE 1 IN. WIDE, PART NO. 1055605	8907	1.00

Figure 46. Purchase Order Form.

stant for each vendor and item; non-printed stop codes for data which will vary from purchase order to purchase order; punch control; codes; and special codes for controlling the tape-to-card converter.

Two master tapes are created. One is called the vendor master tape, and contains the functional programming for heading of the purchase order. That is, all information above the items. The second is referred to as the item master tape, and has programming for all the items. Since all information concerning items appears in the same format (meaning that all quantities appear in one column, all unit data in another column, etc.), one master tape can contain all functional programming for all the items that will ever be purchased.

These master tapes are prepared manually with the punch control switch in the ALL position to cause punch control codes (On 1, On 2, Off, and Fc On) to punch.

When these two master tapes are prepared, it is never necessary to prepare them again. By using the NON PRINT panel switch (See page 11), duplicate master tapes can easily be made to be used in case of damage to the originals.

PREPARATION OF EDGE-PUNCHED CARDS

2 Vendor master and item master tapes are read to prepare the edge-punched cards containing data about a particular vendor and a particular item. They are used to prepare edge-punched cards for all vendors and all items. Four edge-punched cards are used to write the entire purchase order (See figure 46). The first, called the vendor card is prepared by reading the master vendor tape and manually entering all data constant for that particular vendor. Functional programming necessary for writing the heading of the purchase order is also inserted automatically by the vendor master tape. Constant data manually entered, is the vendor number, ship via, F.O.B., vendor name and address, and the terms data. In the vendor card are Stop codes, non-printed from the vendor master tape, for manual entry of the variable information when the vendor card is read to write the purchase order. This variable data is not known until the purchase order is actually written, and consists of the purchase order number, the purchase order date, and the desired delivery date.

There is one item card for each item shown on the purchase order. The item master tape creates edge-punched cards for every

item purchased from every vendor. Each item card will contain: functional codes from the item master tape; constant information for that particular item; and a Stop code, non-printed from the item master tape for manual entry of the variable data when the purchase order is written. In this case, information under the quantity ordered column is the only variable entry.

Vendor master and item master tapes can be read with the punch control switch in either the ALL or SELECT position. This is dependent upon the programming of the master tapes. If automatic typing of labels for identification of the vendor and item cards is desired, the master tape will be programmed to be read in the SELECT position of the punch control switch. When tapes are programmed to be read in the ALL position, the indexing and sometimes the positioning of the labels are left to the operator's discretion.

In this illustration, however, the ALL position is used with both the vendor master and item master tapes, and only straightforward programming is shown. After some facility in programming has been mastered, advanced methods will become clear.

PREPARATION OF THE PURCHASE ORDER AND THE SELECT TAPE

③ Vendor and item cards are read to prepare the purchase order. The operator has only to position the form in the carriage, insert the vendor card and touch the START READ panel switch. When the Flexowriter stops, the operator enters the variable data and again touches START READ. The Flexowriter stops for entry of the variable information, and at the end of each card to signal the operator to insert the next. After the purchase order heading is completed, the vendor card is removed, and item cards are inserted in sequence.

In the select tape, produced in the punch, selected information from the purchase order is punched by means of the keyboard

punch control codes (On 1, Off). These codes, contained in the vendor and item cards, were reproduced from the original master tapes. Before the purchase order was prepared the punch control toggle switch was placed in the SELECT position so this selecting function could take place.

Following are abbreviations used on program charts in programming for Flexowriter applications:

CR:	Carriage Return Code
TAB:	Tab Code
SP:	Space Code
ON 1:	Flexowriter Punch On Code
FC ON:	Field Control On Code
OFF:	Punch Off Code
NP:	Non Print Code (auto.)
PR:	Print Restore Code
TSR:	Tape Skip Restore Code
PI:	Program Identification Code
STP:	Stop Code

To understand the programming charts that follow, read the codes on the select tape under "A" (facing page) relating them with the tab card layout under "A". Next the codes under vendor card "A" should be read to become familiar with how the select tape was punched. Finally read those codes in the vendor master tape under "A" to see how the vendor card was made.

Following are paragraphs labeled to correspond with the chart headings on the facing page.

A In the select tape, the first code punched is the PI 1 code. This code causes the converter to punch a "1" in the first card column (code position) of the tab card. It also controls the tab card format for this card. The vendor number is also punched into the select tape.

In the vendor card, several codes precede the PI 1 code. These codes control the punch and form spacing on the purchase order. The OFF code insures the condition

D The ship via information is not to be punched into the select tape. In the vendor card, the OFF code turns off the punch. On the form there is a space between purchase order date and ship via. Here, the operator has the ability to make a choice of shipping methods. A STP code prior to this information marks the point of decision. If the goods are to be shipped via Acme Truck, the operator touches START READ. If they are to be shipped by any other method, the operator enters that data, and touches TAPE SKIP, to eliminate "Acme Truck" from the vendor card. Figure 47 shows this portion of the programming isolated for clarity. The TSR (Tape Skip Restore) code returns the Flexewriter to a normal read condition, if TAPE SKIP is used. It has no function in a normal read condition.

In the vendor master tape, the STP code for the operator decision is non-printed into the vendor card. Another STP code allows the operator to enter the most common shipping method into the vendor card. The TSR code is non-printed, as it is a normally non-reproducing code.

E A TAB code in the vendor card brings the carriage into the F.O.B. data area on the form. This is constant information and is written by the vendor card. Four CR codes bring the carriage into the next writing field.

In the master tape, the TAB and CR codes reproduce into the vendor card. The STP code allows the operator to enter the F.O.B. data on the purchase order.

F The vendor name is punched into the select tape. In the vendor card, the ON 1 code precedes this data, and an OFF code

follows it, as the balance of the address is written, but not punched. Street address and city-state are also constant information, and are written from the vendor card.

In the master tape, STP codes allow this data to be entered. An additional STP code allows a four-line address to be entered, in cases where this is necessary.

G Three CR codes in the vendor card bring the carriage into position to write the delivery date. A STP code allows manual entry of this data.

In the master tape, the STP code is non-printed into the vendor card.

H Since the delivery date is of a variable length, a TAB code in the vendor card brings the carriage into position to write the terms data. This TAB code is punched into the select tape. It is done to cause a function of the converter called card skip. Note that the vendor name field in the tab card is not filled. The empty columns allowed for that data in the tab card must be crossed. The TAB code here conveniently serves both the purchase order form and the tab card. The terms data is constant, and is written by the vendor card. Three CR codes bring the carriage out of the heading area of the purchase order. The STP code allows the operator to remove the vendor card, and insert the first item card into the reader.

In the master tape, punch control and spacing codes are reproduced into the vendor card. The STP code allows the terms data to be entered into the vendor card. At the end of the tape, a STP code allows the operator to TAPE FEED another edge-punched card into the punch.

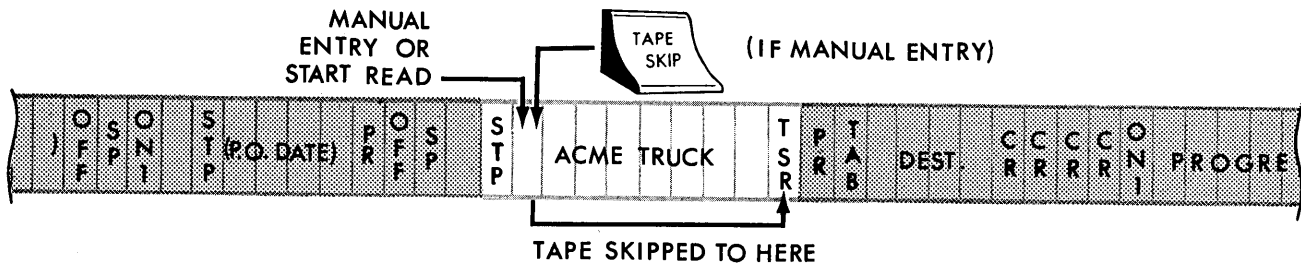

Figure 47. Tape Skip Operation.

PURCHASE ORDER

A VENDOR NO. 704108	B P.O. NO. 9879876	C P.O. DATE 06/01/62	D SHIP VIA ACME TRUCK	E F.O.B. DEST.
---------------------------	--------------------------	----------------------------	-----------------------------	----------------------

(D) ship via (E) F.O.B.

O	S	N	S	P	S		N	T	P	T	S		C	C	C	C
F	P	P	T	R	T		P	S	R	A	T		R	R	R	R
											(D)	(E)	(F)			

VENDOR MASTER TAPE

O	S		S	P			T	P	T		C	C	C	C
F	P		T	R	ACME		S	R	A	DEST.	R	R	R	R
F	P		P		TRUCK		R		B					

VENDOR CARD

PURCHASE ORDER

A VENDOR NO. 704108	B P.O. NO. 9879876	C P.O. DATE 06/01/62	D SHIP VIA ACME TRUCK	E F.O.B. DEST.
---------------------------	--------------------------	----------------------------	-----------------------------	----------------------

TO:

F

PROGRESSIVE MFG. CO.
100 FRIDEN STREET
ANYTOWN, U.S.A.

PURCHASE ORDER NUMBER MUST APPEAR ON ALL PAPERS AND PACKAGES. PACKING SLIP MUST ACCOMPANY SHIPMENTS.

ALL INVOICES MUST BE RENDERED IN DUPLICATE

G DELIVERY 06/15/62	H TERMS NET 30 DAYS			
---------------------------	---------------------------	--	--	--

F vendor name		street		city		4th line		G	H terms																
O	S	O	C	C	S	C	S	C	C	C	N	S	P	O	T	O	S	C	C	C	O	N	S	P	S
N	T	F	R	T	R	T	P	R	R	R	P	T	R	N	A	F	T	R	R	R	R	F	P	T	R
I	P	F	P		P		P							I	B	F	P					F	P	P	
								G del. date	H																
O		O	C	C		C		C	C	C	S		P	O	T	O		C	C	C	O	S	P		
N		F	R			R		R	R	R	T		R	N	A	F		R	R	R	F	T	R		
I		F									P			I	B	F					F	P			
								G	H																
									T A B																

TAB CARD

VENDOR NAME																																								
PROGRESSIVE MFG CO																																								

21 22 23 24 25 26 27 28 29 30 31 32 33 34 35 36 37 38 39 40 41

55 56 57 58 59 60

I In the select tape, the first information to come from the first item card is the PI 2 code. This code does nothing when read in card column 61, as it is in the first tab card to be punched. In the second and third tab cards, however, this code will be read in card column 1, and will cause the first 60 columns to be duplicated from the first tab card. In this manner, the heading information appears in all three tab cards punched from the select tape. The quantity ordered is also punched into the select tape.

In the item card, some punch and form control codes appear before the PI 2 code. An OFF code insures the condition of the punch at the start of reading this card. The CR code positions the carriage at the first writing line in the items. ON 1 turns on the punch. A PI 2 code is non-printed into the select tape. The STP code allows the operator to enter the quantity. Spaces are entered prior to the first significant digit.

Punch and form control codes are reproduced from the item master tape into the item card. The PI 2 code is non-printed twice to bring it into the select tape, while the STP code is non-printed only once to bring it into the item card.

J Unit and description data do not appear in the select tape. The OFF code turns off the punch prior to reading this data. Both unit and description are constant data and come from the item card. There is one space between quantity and unit. Unit data is of a variable length, so a TAB code brings the carriage into the description area.

The item master tape contains the punch and form control codes, plus STP codes for entry of unit and description.

K The item code data is punched into the select tape. In the item card this is accomplished by the ON 1 code. Description is a variable length field, and the TAB code brings the carriage into position to write the item code data.

In the master tape, form and punch control codes are again reproduced. The STP code allows the item code data to be entered into the item card.

L Price data is punched into the select tape, followed by a CR code which concludes the punching of the first tab card. There is an automatic skip between card columns 70 and 73, which is a converter function only. Following the CR code, the next tab card is positioned for punching. The next code to be read in the select tape is the PI 2 code from the second item card. This code when read, will cause the first 60 card columns to be duplicated into the second tab card.

There is one space between the item code data and the price field on the purchase order form. In the item card, this is eliminated by use of punch control. The price is written from the item card, followed by a CR code. The STP code ends the item card, and allows the operator to remove the first item card and insert the second.

Punch control and form control codes are reproduced from the master tape. The first STP code allows the operator to enter the price into the item card. The item master tape ends in the same manner as the vendor master tape. A STP code is non-printed into the item card, and another STP code allows the operator to TAPE FEED another edge-punched card into position. The price field has spaces preceding the first significant digit in the same manner as does the quantity field (see I).

Programming for the second, and all other items is found on page 36. The explanation is identical to that previously described in section I through L.

A complete programming chart for this application is located on page 37 (gatefold page), and is alphabetically referenced to the preceding pages.

MARGIN

TAB

TAB

PURCHASE ORDER

A VENDOR NO. 704108		B P.O. NO. 9879876		C P.O. DATE 06/01/62		D SHIP VIA ACME TRUCK		E F.O.B. DEST.	
---------------------------	--	--------------------------	--	----------------------------	--	-----------------------------	--	----------------------	--

TO:

F
PROGRESSIVE MFG. CO.
 100 FRIDEN STREET
 ANYTOWN, U.S.A.

PURCHASE ORDER NUMBER MUST
 APPEAR ON ALL PAPERS AND
 PACKAGES. PACKING SLIP MUST
 ACCOMPANY SHIPMENTS.

ALL INVOICES MUST BE
 RENDERED IN DUPLICATE

G DELIVERY 06/15/62		H TERMS NET 30 DAYS	
---------------------------	--	---------------------------	--

QUANT.	UNIT	MATERIAL DESCRIPTION	CODE	PRICE
I 10	EA	J FLEXOWRITER TAPE CEMENT, PART NO. 1052470	K 9078	L .50
1	DOZ	NO. 50B FABRIC RIBBON FOR FLEXOWRITER	5097	25.50
100	ROLL	PINK PAPER TAPE 1 IN. WIDE, PART NO. 1055605	8907	1.00

ITEM MASTER TAPE

O	C	N	N	P	P	N	S	P	O	S	unit	T	S	T	O	S	code	O	S	O	S	price	C	O	N	S	P	S
F	R	1	P	2	R	P	P	R	F	P		A	B	description	A	B		F	P	1	P		R	F	P	P	R	P

ITEM CARD

O	C	N	N	P	P	N	S	P	O	S	doz	T	S	T	O	S	code	O	S	O	S	price	C	O	N	S	P	S
F	R	1	P	2	R	P	P	R	F	P		A	B	no. 50B fabric ribbon for Flexowriter	A	B	5097	F	P	1	P	2550	R	F	P	P	R	

				P	P		S	P									5097					S	P	2550	C			
				2	R		4	1														3						

TAB CARD

C	D	VENDOR NO.	P.O. NO.	QTY	CODE	PRICE																										
1	7	04108	987	00001	5097	0002550																										
1	2	3	4	5	6	7	8	9	10	11	59	60	61	62	63	64	65	66	67	68	69	70	71	72	73	74	75	76	77	78	79	80

P12 causes duplication of card columns 1 thru 60

AUTO SKIP

ILLUSTRATION II - FLEXOWRITER WITH AN AUXILIARY INPUT UNIT

An example of programming the Flexowriter with a cable-connected auxiliary input unit is described on the following pages. Any one of a variety of input units may be connected to the input connector of the Flexowriter. This application will show the use of the Friden Selectadata (STR-AD) Tape Only Reader with Automatic Address Selection and Manual Data Selector. This reader offers the additional facilities of being able to search out predetermined information from a punched tape and a separation of functional coding from the data. The program tape used on the Selectadata is very similar to the master tapes prepared in Illustration I.

A Flexowriter equipped with edge-punched card reader and punch will write the purchase order shown on page 38. The select tape, punched by the Flexowriter will be used in a tape-to-card converter to produce tab cards. Figure 48 indicates the programming sequence for this application. Page 38 (gatefold) is the complete programming layout chart for this application.

STEP 1. A program tape (looped tape) is manually punched on the Flexowriter with the punch control switch in the ALL position to allow punch control codes (ON 1, ON 2,

FC ON and OFF) to reproduce. This tape will contain all horizontal and vertical line spacing codes, punch control codes, Stop codes for inserting constant and variable data, special codes for controlling the tape-to-card converter and Control (or Switch) codes. The latter causes the reading action to stop in the Selectadata Reader and to begin in the Flexowriter reader. This function is referred to as a switching action. The program tape also will contain Address codes which allow the operator to locate data or specific programming within the looped tape in the Reader.

STEP 2. Vendor and item edge-punched cards are prepared manually. These cards will contain only constant information and Switch codes, which cause the reading action to stop in the Flexowriter reader, and begin in the Selectadata Reader. Each card will also contain an Address code, which assures the operator that the program tape and the vendor (or item) card is in phase.

STEP 3. Vendor and item cards are read in the SELECT position on the Flexowriter reader in a duplex operation with the program (looped) tape on the Selectadata unit.

STEP 4. The select tape, punched in the Flexowriter punching unit is used in the tape-to-card converter to produce tab cards.

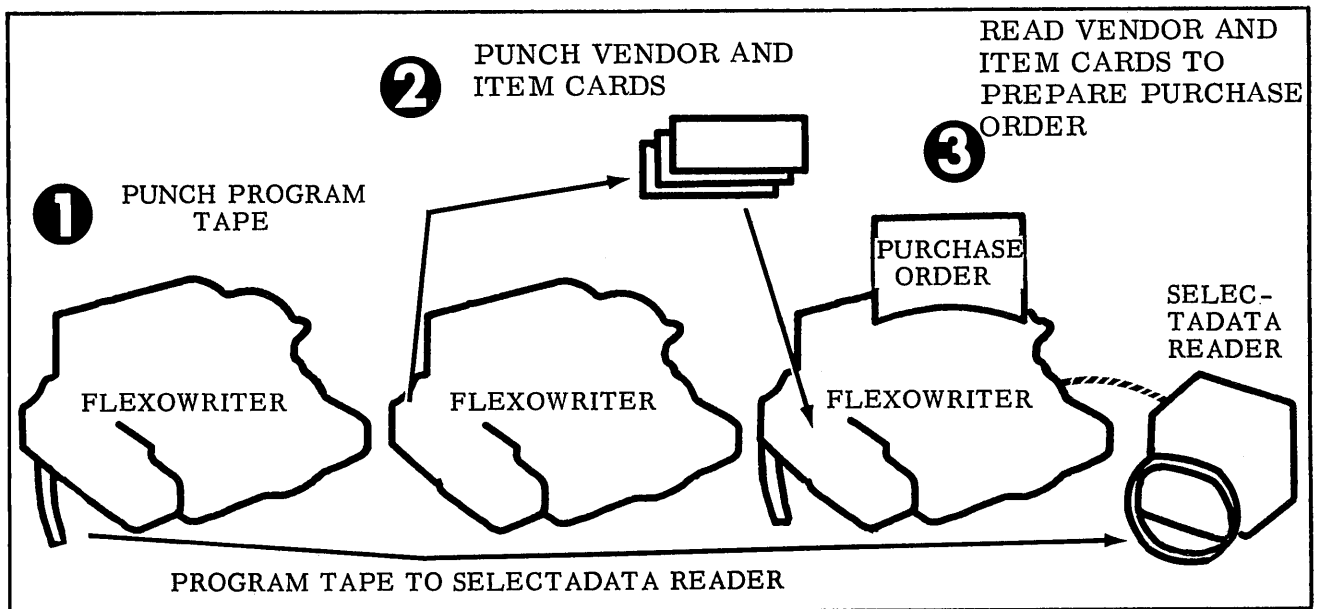

Figure 48. Flow Chart - Purchase Order System Using Auxiliary Input Unit.

ILLUSTRATION III - FLEXOWRITER WITH AN AUXILIARY OUTPUT UNIT

An example of programming the Flexowriter with a cable-connected Auxiliary Punch is described on the following pages.

A Flexowriter with an edge-punched card reader and punch will write the purchase order. Two selective by-product tapes will be punched simultaneously. The tape produced in the Flexowriter punch will be called the select tape, and will be used in a tape-to-card converter to create tab cards.

The tape punched in the Auxiliary Punch will be used at a later time in the Flexowriter reader to write a receiving slip. This tape is called the receiving slip tape, and will be used only after the goods have actually been delivered.

Figure 50 on page 42 is a flow chart showing the programming sequence of this application. Page 41 (gatefold), shows the purchase order and receiving slip forms, and the complete programming layout of this application.

STEP 1. Two program tapes, the vendor master tape, and the item master tape, are manually punched on the Flexowriter with the punch control switch in the ALL position to allow punch control codes (ON 1, ON 2, FC ON and OFF) to reproduce. These tapes will contain: all horizontal and vertical line spacing codes, punch control codes, Stop codes for inserting constant and variable information, and special codes for controlling the tape-to-card converter.

STEP 2. Vendor master and item master tapes are read in the ALL position to prepare the vendor and item edge-punched cards. These cards will contain: all horizontal and vertical line spacing codes, punch control codes, constant information, Stop codes for inserting variable information, and special codes for controlling the tape-to-card converter.

STEP 3. Vendor and item cards are read

in the SELECT position to produce the purchase order and two selective by-product tapes. The select tape, punched in the Flexowriter punch is used in the tape-to-card converter to produce tab cards. The receiving slip tape, created in the Auxiliary Punch will be read in the Flexowriter with the punch control switch in the OFF position, to write the receiving slip. This tape will contain only selected information found in the purchase order and Stop codes for inserting variable information not found on that document.

STEP 4. Once goods are delivered the receiving slip is written. It contains some information not found on the purchase order, but which must be programmed into the vendor and item cards.

The circled information on the receiving slip (shown on page 41) indicates the data not found on the purchase order. Since this information is known only at the time the receiving slip is written, Stop codes must be programmed into the receiving slip tape to allow this data to be entered. In case of a back order, or goods shipped in more than one lot, this receiving slip tape can be filed and reused until the complete purchase order is filled.

Figure 49 shows the Flexowriter with the Auxiliary Punch connected.

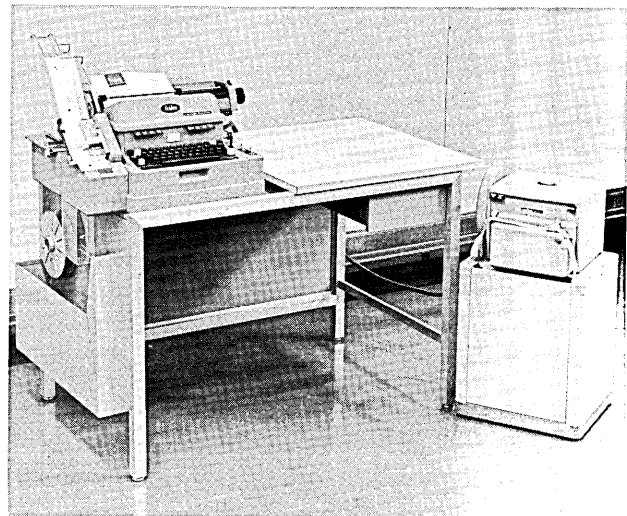

Figure 49. Flexowriter, Auxiliary Tape Punch

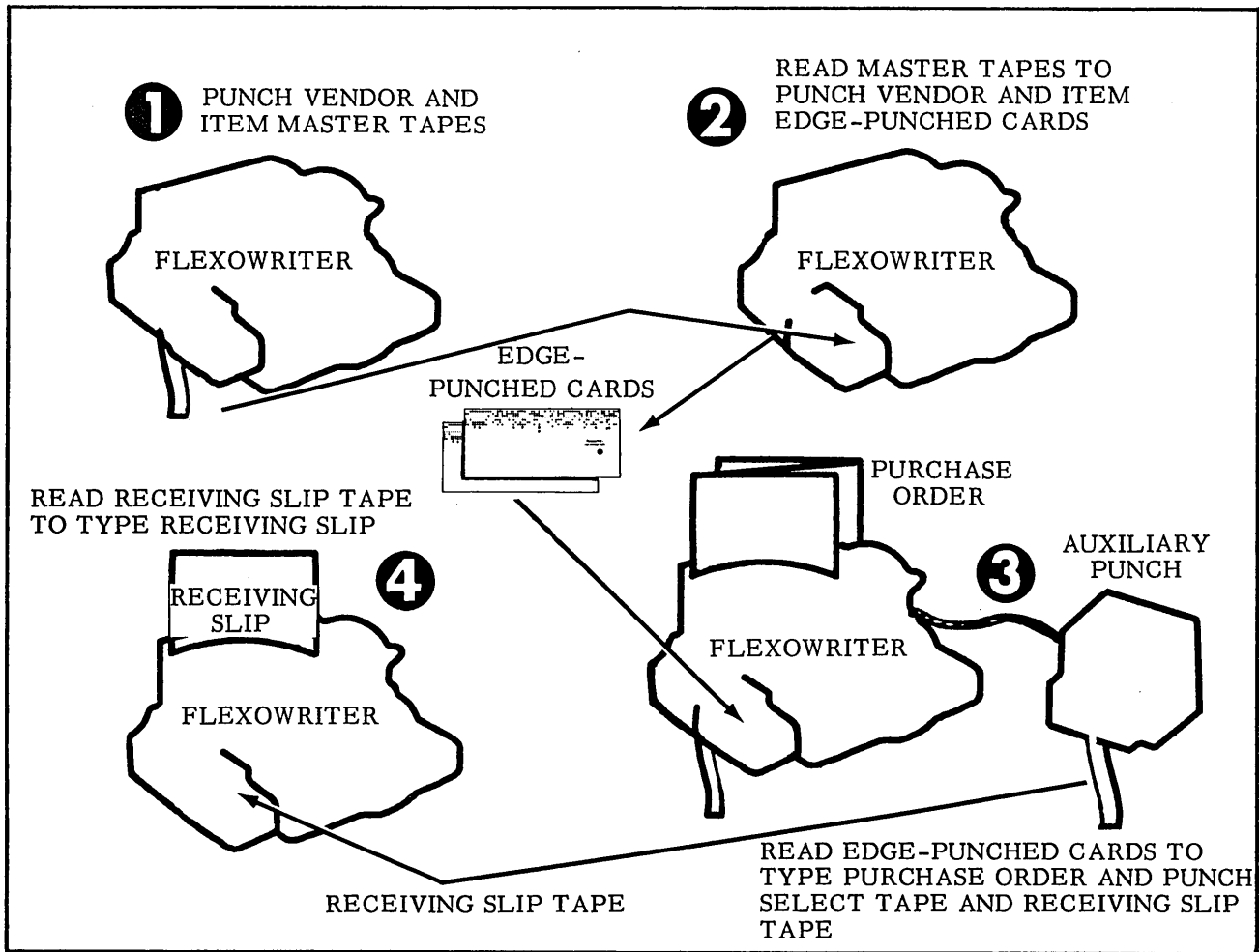

Figure 50. Flow Chart - Purchase Order, Receiving Slip System.

CODE AND FLOW CHARTING TEMPLATE

Available from local Friden offices is a 5" x 10" code and flow charting template (See figure 51). This is recommended for use in the preparation of flow charts, forms designs, and as an 8-channel code reference. Systems procedures flow charts involving Flexowriters and other Friden equipment can be realistically and artistically portrayed through the use of this template.

Scales along the edges of the template allow the user to measure vertical line spacing (six lines per inch) and type styles (10 and 12 characters to the inch).

The illustrations, figures 45, 48, and 50 were drawn with the aid of this template.

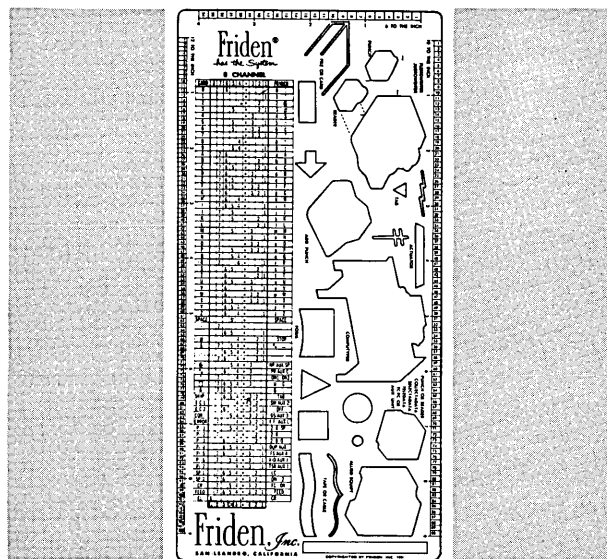

Figure 51. Code and Flow Charting Template.

SECTION IX

GLOSSARY OF DATA PROCESSING TERMS

INTRODUCTION

The following is a listing of common data processing terms as they apply to Friden and allied equipment.

ACTUATOR - A small piece of metal (cam) that is fastened to the control rack. When the Flexowriter is in a field control condition, and when the actuator touches a field switch roller, an electrical circuit is completed. This causes one phase of Flexowriter punch control or auxiliary output control-punch on or punch off.

ADDRESS CODE - A functional code that identifies specific data contained in a Selectadata tape (Used only in a high speed search operation).

ADDRESS IDENTIFICATION CODE - A functional code used to condition the Selectadata Reader for an automatic and/or a repeat search operation.

AUTOMATIC NON PRINT - An automatic method of punching codes in tape or cards without printing on the document. This condition is initiated by a sensing of the Non Print code in the reader.

AUXILIARY UNIT - Any of the input (auxiliary reader) and output (auxiliary punch) units which may be electrically connected to the Flexowriter.

BINARY - A system of coding involving two possible alternatives: the absence of a bit or the presence of a bit.

BIT - A code hole punched in a tape or edge-punched card.

BUILT-IN-CHECK - Any provision within a data processing, storage or transmission device for the purpose of verifying the accuracy of machine function.

BY-PRODUCT TAPE - Punched tape obtained automatically as the result of document preparation. It contains information to be used in a subsequent operation.

CARD COLUMN - One of the tab card positions available for a single alpha or numeric character.

CARD FIELD - A card column (or columns) in a tab card designated for a specific type of information.

CARD PUNCH - A mechanism or unit of allied equipment which punches tab cards.

CHAD - A portion of tape or card which is removed when a code is punched.

CHANNEL - A designated location of a bit.

CHARACTER - A letter, number, mark of punctuation or a symbol that is recorded by business machines.

CODE - It consists of one or more bits and is the smallest unit of data.

COMMON LANGUAGE - A code structure which is compatible with other data processing machines.

CONSTANT DATA - Data or information which is repetitive and normally contained in the coded tape, edge-punched, or tab card input to the Flexowriter.

CONSTANT LENGTH FIELD - That portion of a document or tab card in which a specific number of alpha-numeric characters must always be entered.

CONTROL CODE (Switch code) - A code that transfers reading action from one reader to the other reader whenever it is sensed.

CONVERTER - A unit or mechanism which changes the language of coded information from one form or code structure to another so as to make it acceptable to another business machine.

DATA - Information or facts.

DATA PROCESSING - The handling of information or facts through the media of common language machines.

DATA SELECT CODE - A code which causes information contained in the Manual Data Selector to be printed on a document.

DUPLEX - An operation involving two readers with controlled switching taking place, alternately, from one reader to another reader.

DUPLICATING - The automatic punching of information from a card or tape into succeeding edge-punched cards or tapes.

ERROR CODE - An instruction code for allied equipment intentionally punched to indicate a block of data to be voided.

FEED HOLES - A series of small holes in tape or edge-punched cards for accurate positioning of tape or cards in the punch and reader.

FIELD - A portion of a document or tab card designated for a particular type of alphabetic or numeric information.

FIELD CONTROL CODE - A code which activates the pre-determined program of the field control rack.

FIELD CONTROL RACK - A removable metal rack, holding the actuators, located at the rear of the Flexowriter carriage. In conjunction with the field switch rollers, it is used for turning on and off the Flexowriter and/or an auxiliary output unit.

FIELD SWITCH ROLLER - A small wheel which is operated by an actuator on the field control rack.

FLOW CHART - A series of steps illustrating all or part of a business system.

FORM FEED - The term applied to the rapid, automatic, vertical positioning of a document in a machine carriage.

FUNCTIONAL CODE - An instruction code given to the Flexowriter to initiate a definite action within the machine.

HARD COPY - A typewritten, legible recording of information.

HEADER CARD - A prepunched record of information, pertaining to the business instructions for a specific individual or firm, which is used to automatically create the upper portion of a document.

HOLLERITH CODE - The standard 12-channel code used in some tabulating card systems - named after its inventor.

INTERLOCK (Keyboard) - A system which prevents the operation of any two keylevers at the same time.

INTERPRETING - The translation of punched holes in tape or cards into printed information on cards or hard copy.

ITEM CARD - A prepunched record of information pertaining to a specific commodity which is used to automatically create the lower portion (body) of a document.

KEYBOARD - It consists of banks or rows of keylevers on the writing machine where all manual entries are made.

KEYPUNCHING - The manual keyboarding of alphabetical or numerical information into a tab card.

MANUAL DATA SELECTOR - This term refers to the 10 dials located on top of an auxiliary reader (input) unit. Through operator selection, up to 10 digits of numerical information can be caused to print on a given document.

MASTER TAPE - A control tape consisting of functional and/or data codes used in the preparation of a data tape or an edge card.

MANUAL NON PRINT - An automatic method of punching codes, sensed by the reader into tape or cards without printing on a document. It is initiated by touching the NON PRINT panel switch.

NON-REPRODUCING CODES - Functional and instruction codes that are not represented on the keyboard.

PAPER TAPE - The carrier strip for codes. It is used as a means of recording and storing data in the form of punched holes.

PARITY CHECK - An electrical check which tests whether or not the number of bits punched in a single code is odd (even if an even parity system is used).

PI CODES (Program Indication) - Instruction codes used for a tape-to-card converter.

PRINT RESTORE CODE - A code which returns the Flexowriter to a normal reading condition following an automatic non print operation.

PROGRAM TAPE - A tape containing functional or data codes used in the preparation of a document.

PUNCH - A unit for punching codes in tape or edge cards from electrical impulses.

READER - A unit for sensing codes in tape or edge-punched cards, that emits electrical impulses to the writing machine and/or punch.

REPRODUCING CODES - Functional and instructional codes that are represented on the Flexowriter keyboard.

SELECT TAPE - A by-product tape containing functional and data codes selectively captured as the result of preparing a document.

SELECTADATA READER - An auxiliary input unit capable of: searching for, selecting, and reading out information stored in punched tape.

START READ - The designated name of a panel switch that initiates action in the reader when the panel switch is touched.

STOP CODE - Code, when sensed in reader causes reading action to stop.

STOP READ - The designated name for a panel switch that stops action in the reader when touched.

SWITCH CODE (CONTROL CODE) - A code that transfers reading action from one reader to another whenever it is sensed.

SYNCHRO-DUPLEX READER - Any of the electrically connected auxiliary input units specifically designed to exercise complete control over all Flexowriter operations.

TAB STOP - A removable metal part, manually placed in a rack in the carriage. It is used to terminate horizontal movement of the carriage initiated by manual or automatic operation of the TAB keylever.

TAPE FEED - A code punched in tape or cards which is used to provide leader or trailer strips in tape and may also be used as a Delete code. It normally consists of punching in all information channels and this punching is initiated by touching the TAPE FEED panel switch.

TAPE SKIP - A function of the reader which causes tape or edge-punched cards to cycle through without causing printing or punching. This function is initiated by touching the TAPE SKIP panel switch.

TAPE SKIP RESTORE CODE - A code that returns the Flexowriter to a normal reading condition following the tape skip function.

VARIABLE DATA - Information, facts or statistics which are non-repetitive.

VARIABLE LENGTH FIELD - That portion of a document or tab card in which the total number of consecutively recorded characters differ.

VERIFYING - A method of checking or testing the accuracy of codes that have been previously punched.

APPENDIX

PUBLICATIONS AND EDUCATION

SPECIFIC PUBLICATIONS

Product publications editorializing actual customer installations of Friden products, commonly called "Case Histories", are available depicting before and after methods, flow chart procedures, and benefits derived from these installations.

These product publications and all other Friden literature may be obtained from Friden Branch offices, located in all major cities, or by writing Rochester, New York.

Customer Case Histories cover a wide scope of industries and businesses. Each write-up portrays the methods and equipment that benefited a specific customer in a given area. Many of these well thought-out customer applications may be duplicated or applied to a business operating under similar circumstances.

Technical Manuals, Information and Education Releases (I & E Bulletins) also are available. Friden Technical Manuals provide a sound knowledge of the principles that form the basis and background for Friden equipment. The entire machine or system is taken in a logical sequence and clearly described to aid anyone in achieving a complete understanding of Friden products.

Information and Education Bulletins cover a vast range of information on such subjects as data processing, graphic arts, mailroom methods, data collection and other topics.

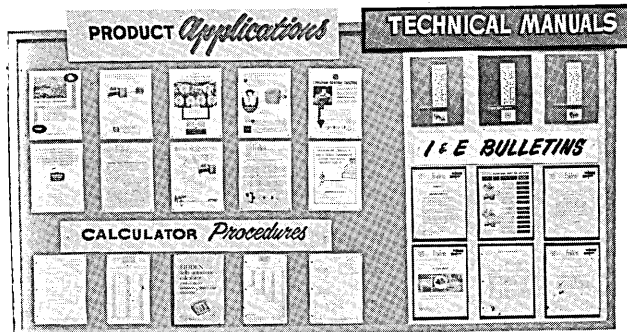

Examples of Friden Literature



Friden Educational Center

FREE COURSES AND SEMINARS

Friden, Inc., maintains an Educational Center located in Rochester, New York. This Center, equipped with over a million dollars worth of Friden and allied equipment, directs its activities toward fulfilling the guidance needs of Friden's current and potential customers.



Thousands of systems - procedures - graphic arts and management level personnel have completed one or more courses of study conducted at this Center. The curriculums, which range over the full spectrum of integrated data processing, communications, data collection, graphic arts, and allied areas are scheduled the year-round.

Courses are taught by instructors of the Friden Customer Educational staff, each an expert in his particular field.

To augment regularly scheduled courses special seminars are initiated for organizations whose requirements are restricted to specific equipment or applications.

Enrollment and registration for ALL customer programs will be arranged by the Friden representative or office nearest you. They will gladly make arrangements for you and for any member of your organization who wishes to attend any of the many courses offered. Ask them for the brochure describing and listing the dates of all courses. All courses are conducted FREE of charge.

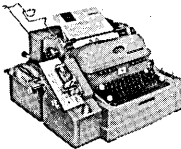
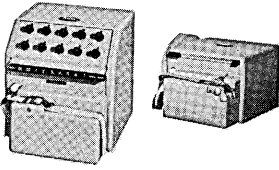
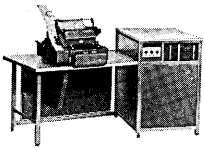
Friden Products Designed for Practical . . .

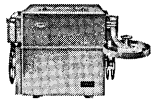
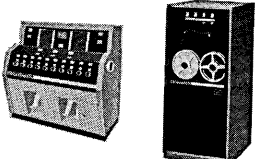
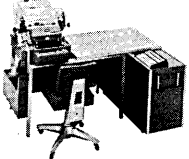
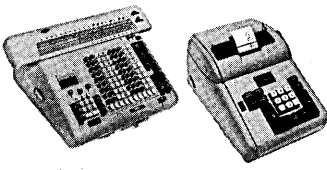
	<p>FLEXOWRITER</p>
<p>AUXILIARY EQUIPMENT</p>	
	<p>COMPUTYPER</p>
<p>ADD-PUNCH</p>	
	<p>TELEDATA</p>
<p>COLLECTADATA</p>	
	<p>COMPUTER</p>
<p>CALCULATOR ADDING MACHINE</p>	

DATA PROCESSING EQUIPMENT

The FLEXOWRITER® . . . automatic writing machine, is a tape-operated data processing unit. It automatically produces documents at 100 words per minute, and simultaneously perforates punched paper tapes for further data processing. Many models are available for specific data processing applications.

A wide variety of AUXILIARY, input/output units may be cable-connected to the Flexowriter, Computyper and other Friden equipment. These units facilitate greater application and programming flexibility.

The COMPUTYPER®, automatic writing-computing machine, is a complete billing department at a single desk. It contains all the versatility of the Friden Flexowriter, plus the ability to compute automatically.

The Friden ADD-PUNCH®, 10-key "Natural Way" adding machine with automatic tape punch, captures numeric data for automatic preparation of reports. This unit creates a printed tape as well as a punched paper tape for many data processing applications.

TELEDATA®, data transmission and receiving system, speeds communications to and from remote points over existing wire services. These units have the ability to simultaneously transmit, receive, and check tapes of 5 through 8-channels for a wide range of applications involving communications.

COLLECTADATA®, data collecting system, facilitates fast and accurate reporting from diverse points directly to a data collection center. This transmission and receiving system provides management with up-to-date information on plant operations at all times, thus allowing executive decisions to be based on events as they occur.

The Friden 6010 ELECTRONIC COMPUTER is a small-scale, business oriented, digital computer. It uses solid-state circuitry in an independent desk-sized machine. High speed computation is combined with simultaneous output of printed information, plus coded output of punched tape, edge-punched cards, tabulating cards, or any combination of these.

CALCULATORS AND ADDING MACHINES

Friden CALCULATORS and "Natural Way" 10-key ADDING MACHINES are leaders in their field. These easy to operate units come in a wide variety of models, thus providing a versatile machine for all businesses, large or small.

Application in Business and Industry

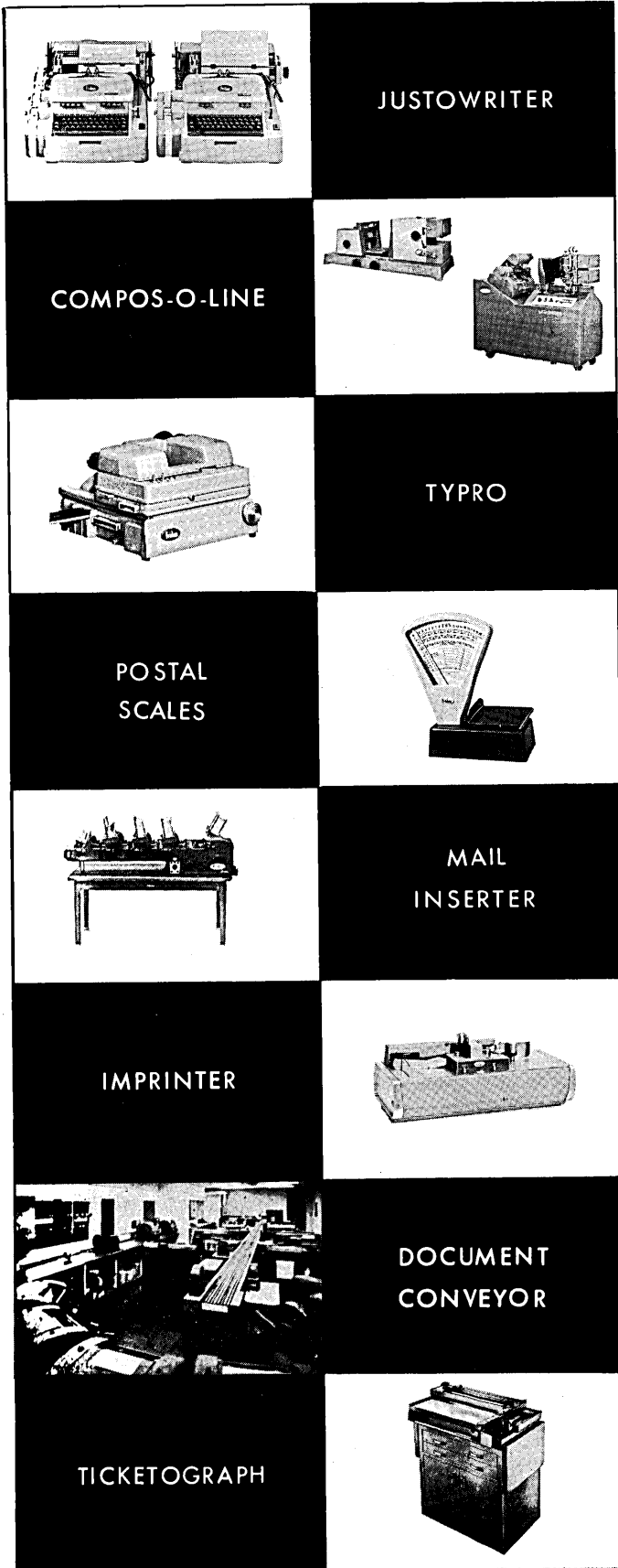

GRAPHIC ARTS EQUIPMENT

The JUSTOWRITER,[®] automatic tape operated copy-setting machine, produces justified (even margin) copy for duplicating or printing. This easy-to-operate machine is available in a variety of models that will provide an economical source of high-quality composition.

COMPOS-O-LINE,[®] Sequential Card Cameras, convert original source data from file cards into film negatives ready for the printing of price lists, directories, catalogs, labels, and other similar applications.

Friden TYPRO[®] is a cold type photo-composing machine used to produce flawless, micro-sharp display type and lettering. This easy-to-operate precision machine holds up to 15 type fonts on one reel. Type sizes range from 6 to 144 points and over 1800 selections are available.

MAILROOM EQUIPMENT

Friden provides a complete line of mailroom equipment to speed mail handling and distribution. This includes a complete line of POSTAL SCALES, sorting racks, mail bags, openers, sealers, and endorsing machines.

The Friden - Ertma MAIL INSERTER automatically gathers and stuffs into envelopes as many as eight different inserts, then seals, stacks, and counts the envelopes ready for mailing.

The IMPRINTER, automatic check endorsing and signing machine, signs, endorses, cancels, counts numbers, dates and imprints checks or other documents at high speed. These operations are performed economically; and safety is insured by the use of locked steel signature plates.

Friden DOCUMENT CONVEYOR eliminates the hand carrying of mail, papers, reports, and other documents. This system moves paperwork economically, smoothly, silently and swiftly to any specific area. The Document Conveyor is tailored to any customer requirements.

TICKETOGRAPH

Mather Division of Friden, Inc. designs and prints coupons or work tickets of all widths, lengths, colors of ink, stock and types of perforations, for all kinds of machines, automatic or manual. TICKETOGRAPH,[®] gang numbering and pricing machine, imprints piecework rates and production data utilizing these tickets.

[®] Registered Trademark of Friden, Inc.

Friden, Inc.

SAN LEANDRO · CALIFORNIA

SALES AND SERVICE THROUGHOUT THE WORLD

A SUBSIDIARY OF THE SINGER COMPANY