

# TTL MEMORY 93400 • 93400B • 93401

## 256-BIT READ/WRITE MEMORY & DECODER/DRIVER

FORMERLY 4100 • 4100B • 4101

**DESCRIPTION** – The 93400 256-Bit Read/Write Memory and the 93401 Decoder/Driver are components for use in high speed memory systems. The 93400 is a fast 256 x 1 random access read/write memory which is addressed with a partially decoded x-y coincident selection scheme. There are two device grades, with the 93400B having a slower access time than the 93400. The companion decoder and buffer driver, 93401, converts binary addresses into the partially decoded form required by the 93400, and provides sufficient drive to connect to 32 93400's. Both devices are supplied in 16-lead Dual In-Line Packages.

### 93400/93400B

- TTL COMPATIBLE
- 16-LEAD PACKAGE
- OUTPUT WIRED-OR CAPABILITY
- 70 ns TYPICAL ACCESS TIME (93400)
- 125 ns TYPICAL ACCESS TIME (93400B)
- LOW INPUT LOADING

### 93401

- TTL COMPATIBLE
- 16-LEAD PACKAGE
- 20 ns TYPICAL THROUGH DELAY
- LOW INPUT LOADING
- 4 ENABLE INPUTS FOR CHIP SELECTION
- DRIVES UP TO 32 93400's

### ABSOLUTE MAXIMUM RATINGS

$V_{CC}$  Pin Potential to Ground Pin  
 Input Voltage  
 Voltage Applied to Output when Output is HIGH  
 Current into Output when Output is LOW  
 Storage Temperature

-0.5 V to +7.0 V  
 -0.5 V to +5.25 V  
 -0.5 V to + $V_{CC}$   
 +25 mA  
 -65°C to +150°C

### LOGIC DIAGRAM

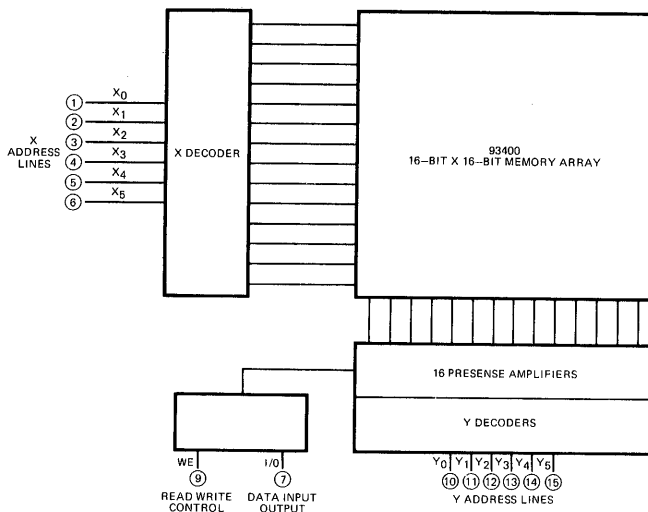

### LOGIC SYMBOLS

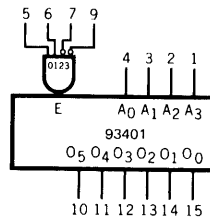
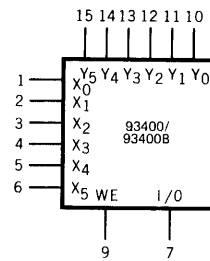

$V_{CC}$  = Pin 16  
 Gnd = Pin 8

### CONNECTION DIAGRAMS

#### (TOP VIEWS) 93400/93400B

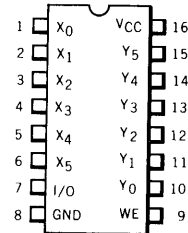

#### 93401

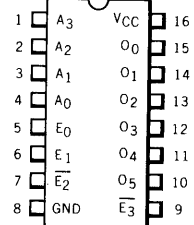

# FAIRCHILD TTL MEMORY 93400 • 93400B • 93401

## FUNCTIONAL DESCRIPTIONS

The 93400 and 93400B contain 256 bipolar storage cells arranged in a 16 by 16 format. Any one of the 256 cells may be accessed by supplying an address code on the X address inputs and the Y address inputs. Internal decoders decode the X and Y addresses into one of 16 rows and one of 16 columns in the matrix of storage cells. Data may be written into or read out from the cell lying at the intersection of the selected row and column.

The X and Y addresses supplied to the 93400 and 93400B are partially decoded in a "3 of 6" code. Of the six X address lines and the six Y address lines there are always three lines HIGH and three lines LOW. There are 20 such combinations, 16 are decoded by the internal row and column decoders. The four unused combinations of 3 of 6 will not select any row or column. If there are more than three lines HIGH in either the X or Y address, then multiple row or column selection will occur. The sixteen 3 of 6 codes used by the 93400 and 93400B are generated by the 93401 decoder/driver.

Data enters and leaves the memory on a single input/output (I/O) line (pin 7). The I/O line is an open collector output, so many 93400 I/O lines can be connected together in a wired-OR configuration. Input data must be applied to the I/O lines through an open collector gate. Each I/O line requires a pull-up resistor to  $V_{CC}$ . The magnitude of the pull-up resistor is determined by the number of 93400 I/O lines tied together. The I/O of a 93400 which is not addressed will be HIGH.

Read/Write selection is determined by the state of pin 9, the active HIGH write enable. When WE is HIGH, the data on the I/O line will be written into the selected address in the 93400. When the Write Enable line is LOW, data will be read out of the addressed location.

The 93401 is a partial decoder and driver for the 93400. It accepts a 4-bit binary code on the address inputs ( $A_0-A_3$ ) and produces a 3 of 6 code on the six output pins ( $O_0-O_5$ ). The decoder also features four separate enables, two active HIGH and two active LOW. All four enables must be active before the decoder will produce a 3 of 6 code. Since two of the enables are HIGH and two are LOW, it is possible to route two binary coded lines to four different 93401's to get two additional bits of decoding with no extra packages.

Ordinarily in memory systems, 93400 memory devices will be arranged in a matrix of rows and columns. Each column will store a particular bit and each row of 93400's will be 256 words. A 93401 driver will be used for each row and each column in the matrix. One 93401 can drive up to 32 93400 X or Y address lines. The usual driving scheme is to connect the four LSB's of address to each of the column decoders. The next four bits of address are connected to each of the row decoders. Additional address bits are decoded to the chip selects on the row decoders. Each column decoder drives the Y address lines on up to 32 93400's in a column. Each row decoder drives the address lines on up to 32 93400's in a row.

## THE THREE OF SIX CODE

The "3 of 6" code used in the 93400 and produced by the 93401 is a tradeoff between memory chip complexity and pin count. The simplest 256-bit memory chip would be a 16 by 16 matrix of storage cells, with all 16 rows and 16 column select lines brought off chip. The lowest pin count for a 256-bit memory chip would be achieved by fully decoded X and Y select lines reducing the 32 lines of the simple scheme to only 8 lines. However, full binary decoding of the X and Y lines on chip significantly increases to complexity of the memory chip. The 93400 and 93401 are designed to gain the good features of both alternatives. The 16 X and Y lines are decoded into 6 lines each, allowing the memory to fit into a 16-lead package and still keeping the memory chip fairly simple, since the 3 of 6 code does not require a complex decoder. The table on the right below shows the conversion of 4-bit binary to 3 of 6 code by the 93401, and also the internal column or row selected by the 3 of 6 to 1 of 16 decoder inside the 93400.

## TTL LOAD AND DRIVE FACTORS

93400 • 93400B

93401

INPUT	LOAD	INPUT	LOAD
X Lines Y Lines WE	0.33/0.125	$E_0, E_1$ $E_2, E_3$ $A_0, A_1, A_2, A_3$	0.33/0.25
OUTPUT	DRIVE FACTOR	OUTPUT	DRIVE FACTOR
Output I/O	<u>Open Collector</u> 3.1	$O_0, O_1,$ $O_2, O_3, O_4, O_5$	16/6

Numerator = HIGH level load  
(1 load = 0.06 mA)

Denominator = LOW level load  
(1 load = 1.6 mA)

### CODE CONVERSION EQUATIONS

$$O_0 = \overline{A_3}$$

$$O_1 = (A_1 + A_0) (\overline{A_3} + A_1) (\overline{A_2} + A_0)$$

$$O_2 = (A_1 + \overline{A_0}) (\overline{A_3} + \overline{A_0}) (A_2 + \overline{A_1})$$

$$O_3 = (\overline{A_1} + A_0) (\overline{A_3} + A_0) (A_2 + \overline{A_1})$$

$$O_4 = (\overline{A_1} + A_0) (\overline{A_3} + \overline{A_1}) (\overline{A_2} + A_0)$$

$$O_5 = \overline{A_2}$$

## TRUTH TABLE

BINARY INPUT TO 93401				3 OF 6 CODE OUTPUT OF 93401; INPUT TO 93400 (L = 0 OR X OR Y)						93400 93400B INTERNAL X OR Y ADDRESS
$A_3$	$A_2$	$A_1$	$A_0$	$L_0$	$L_1$	$L_2$	$L_3$	$L_4$	$L_5$	Row or Column
L	L	L	L	H	H	L	L	L	H	0
L	L	L	H	H	L	H	L	L	H	1
L	L	H	L	H	L	L	H	L	H	2
L	L	H	H	H	L	L	L	L	H	3
L	H	L	L	H	H	H	L	L	L	4
L	H	L	H	H	L	H	L	H	L	5
L	H	H	L	H	H	L	H	L	L	6
L	H	H	H	H	L	L	H	H	L	7
H	L	L	L	L	H	L	H	L	H	8
H	L	L	H	L	H	H	L	L	H	9
H	L	H	L	L	L	L	H	H	H	10
H	L	H	H	L	L	H	L	H	H	11
H	H	L	L	L	H	H	H	L	L	12
H	H	L	H	L	H	H	L	H	L	13
H	H	H	L	L	H	L	H	H	L	14
H	H	H	H	L	L	H	H	H	L	15

NOTE: Enables on 93401 must be LLHH. Any other state on the enable inputs causes 93401 outputs to go LOW, and addresses no internal row or column in the 93400 memory matrix.

**FAIRCHILD TTL MEMORY 93400 • 93400B • 93401**

**93400 • 93400B ELECTRICAL CHARACTERISTICS** ( $T_C = 0^\circ\text{C}$  to  $75^\circ\text{C}$  in operation;  $V_{CC} = 5.0\text{ V} \pm 5\%$ ) (Part No. 93400XC/93400BXC) \*

SYMBOL	PARAMETER	LIMITS			UNITS	CONDITIONS AND COMMENTS
		0°C MIN. MAX.	25°C MIN. TYP. MAX.	75°C MIN. MAX.		
$V_{OL}$	Output LOW Voltage	0.45	0.20 0.45	0.45	Volts	$I_{OL} = 5\text{ mA}$ $I_{OL} = 10\text{ mA}$ $V_{CC} = 4.75\text{ V}$ , See Figure 3.
				0.55		
$I_{CE}$	Output Leakage Current	100	100	100	$\mu\text{A}$	$V_{CC} = 5.25\text{ V}$ , $V_{CE} = 4.5\text{ V}$ All Inputs Grounded
$V_{IL}$	Address, Write Input LOW Voltage	0.85	0.85	0.85	Volts	Guaranteed LOW Input Threshold
$V_{IH}$	Address, Write Input HIGH Voltage	2.0	2.0	2.0	Volts	Guaranteed HIGH Input Threshold
$I_{FI}$	Data Input Forward Current	-250	-250	-250	$\mu\text{A}$	$V_{CC} = 5.25\text{ V}$ , $V_F = 0.45\text{ V}$
$I_{FX}$	X Address Input Forward Current	-250	-250	-250	$\mu\text{A}$	$V_F = 0.45\text{ V}$ , $V_{CC} = 5.25\text{ V}$ 2 other X Lines. 3 Y Lines @ 4.5 V Remaining X and Y Lines @ .45 V
$I_{FY}$	Y Address Input Forward Current	-250	-250	-250	$\mu\text{A}$	$V_F = 0.45\text{ V}$ , $V_{CC} = 5.25\text{ V}$ 2 other Y Lines. 3 X Lines @ 4.5 V Remaining X and Y Lines @ .45 V
$I_{RX}$	Address Input Leakage Current	20	20	20	$\mu\text{A}$	$V_{CC} = 5.25\text{ V}$ , $V_R = 4.5\text{ V}$ Other X and Y inputs grounded
$I_{RY}$		20	20	20		
$I_{FW}$	Write Input Forward Current	-250	-250	-250	$\mu\text{A}$	$V_{CC} = 5.25\text{ V}$ , $V_F = 0.45\text{ V}$
$I_{RW}$	Write Input Leakage Current	20	20	20	$\mu\text{A}$	$V_{CC} = 5.25\text{ V}$ , $V_R = 4.5\text{ V}$
$I_{CC}$	Power Supply Current		100 140		$\text{mA}$	$V_{CC} = 5.0\text{ V}$ , all inputs at ground

**93401 ELECTRICAL CHARACTERISTICS** ( $T_C = 0^\circ\text{C}$  to  $75^\circ\text{C}$  in operation;  $V_{CC} = 5.0\text{ V} \pm 5\%$ ) (Part No. 93401XC) \*

SYMBOL	PARAMETER	LIMITS			UNITS	CONDITIONS
		0°C MIN. MAX.	+ 25°C MIN. TYP. MAX.	+ 75°C MIN. MAX.		
$V_{OH}$	Output HIGH Voltage	2.4	2.4 3.0	2.4	Volts	$V_{CC} = 4.75\text{ V}$ , $I_{OH} = 1.0\text{ mA}$ $V_{IL}$ = value indicated below on this table
$V_{OL}$	Output LOW Voltage	0.45	0.3 0.45	0.45	Volts	$V_{CC} = 4.75\text{ V}$ , $I_{OL} = 10\text{ mA}$
$V_{IH}$	Input HIGH Voltage	2.0	2.0	2.0	Volts	Guaranteed input HIGH threshold for all inputs
$V_{IL}$	Input LOW Voltage	0.85	0.85	0.85	Volts	Guaranteed input LOW threshold for all inputs
$I_{FA}$	Add. Input Load Current	-0.4	-0.4	-0.4	$\text{mA}$	$V_{CC} = 5.25\text{ V}$ $V_{CC} = 5.25\text{ V}$ $V_F = 0.45\text{ V}$ , $V_R = 4.5\text{ V}$ on other inputs
$I_{FE}$	Enable Input Load Current	-0.4	-0.4	-0.4	$\text{mA}$	
$I_{RA} \& I_{RE}$	Input Leakage Current	20	20	20	$\mu\text{A}$	$V_{CC} = 5.25\text{ V}$ , $V_R = 4.5\text{ V}$ , Gnd. on other inputs
$I_{CC}$	Power Supply Current	140	120 140	140	$\text{mA}$	$V_{CC} = 5.25\text{ V}$ , all inputs at ground

\*X = package type; F for Flatpak, D for Ceramic Dip, P for Plastic Dip. See Packaging Information Section for packages available on this product.

**93401 SWITCHING CHARACTERISTICS** ( $V_{CC} = 5.0\text{ V}$ ,  $T_A = 25^\circ\text{C}$ ) (See Fig. 2)

SYMBOL	PARAMETER	LIMITS				UNITS
		$C_L = 90\text{ pF}$ (Equiv. to 32 X Lines)		$C_L = 500\text{ pF}$ (Equiv. to 32 Y Lines)		
		TYP.	MAX.	TYP.	MAX.	
$t_{A^{++}}, t_{A^{+-}}$ $t_{A^{-+}}, t_{A^{--}}$	Delay from address going LOW or HIGH to output going LOW or HIGH	20	25	30	40	ns
$t_{E^{++}}, t_{E^{+-}}$ $t_{E^{-+}}, t_{E^{--}}$	Delay from enable going active or inactive to output going HIGH or LOW	20	25	30	40	ns

**FAIRCHILD TTL MEMORY 93400 • 93400B • 93401**

**93400 • 93400B SWITCHING CHARACTERISTICS** ( $V_{CC} = 5.0\text{ V}$ ,  $T_A = 25^\circ\text{ C}$ )  $C_L = 47\text{ pF}$ ; Equivalent to eight OR-tied 4100 outputs

SYMBOL	PARAMETER	93400			93400B			UNITS
		LIMITS			LIMITS			
		MIN	TYP	MAX	MIN	TYP	MAX	
$t_{AX}$	Read Access Time. Time from good X address to good data at output	30	70	100	30	100	200	ns
$t_{AY}$	Read Access Time. Time from good Y address to good data at output	15	45	65		45	100	ns
$t_{RR}$	Read Recovery Time. Time for output to go HIGH after removal of address.			100			150	ns
$t_{WP}$	Write Pulse Width. Width of pulse on WE required to write data into memory.	80			100			ns
$t_{SH}$	Data Setup Time. Time HIGH or LOW data must be present before end of write pulse to write proper data into memory.			$t_{WP}+10$ 70 (Note 2)			100 70 (Note 3)	ns
$t_{SL}$								ns
$t_{RH}$	Data Release Time. This is the minimum set-up time. Removal of data after the release time will not affect the data written into the memory. See note 1.	0			0			ns
$t_{RL}$		10			10			ns
$C_O$	Output Capacitance		7.0			7.0		pF
$C_{AX}$	Input Capacitance for X address line		3.0			3.0		pF
$C_{AY}$	Input Capacitance for Y address line		15			15		pF
$t_{AS}$	Address Set Up Time. Time address must be good before end of write pulse during write operation. (See Fig. 3b)	80			80			ns
$t_{AP}$	Address Pulse Width. Time that address must remain good for write operation. (See Fig. 3b)	100			100			ns
$t_{WR}$	Write Recovery Time. Time in write-read cycle from end of write pulse to valid output data.			120			120	ns

**NOTES:**

- (1) The set up and release times define a window during which devices are responding to the data and/or address. Inputs must remain good at all times in between the set up and release time limits.
- (2) Applies for write pulse less than 150 ns.
- (3) Applies for write pulse more than 160 ns.

**Fig. 1a—93400 TYPICAL READ CYCLE**

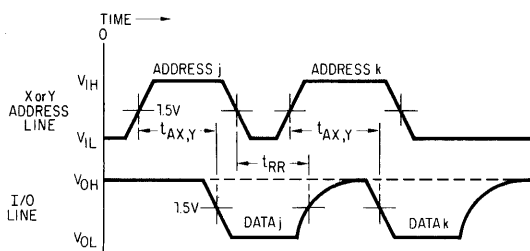

$t_{AX, Y}$  is the time from a good address to good data on the output. Note that the access time may be overlapped with the recovery time to improve speed on consecutive read operations.

**Fig. 1b—93400 WRITE CYCLE**

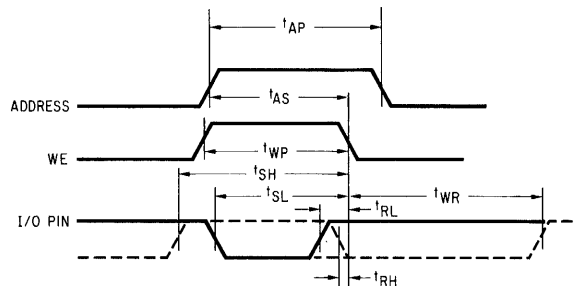

The address must be maintained for 100 ns. The simplest write cycle is achieved by applying the data, then simultaneously raising the address and write pulses for 100 ns. If the write pulse width is less than 100 ns, then the address should come up at about the same time as the write pulse and should be held on after the write pulse. The address should not be applied more than 25 ns before the write pulse, because an early address will cause a read operation to begin disrupting data on the I/O lines (see  $t_{RR}$ ). For a longer write pulse the address pulse may appear anytime as long as it starts before  $t_{AS}$  and lasts at least  $t_{AP}$ .

Fig. 2—93401 SWITCHING WAVEFORMS AND TEST LOAD CONDITIONS

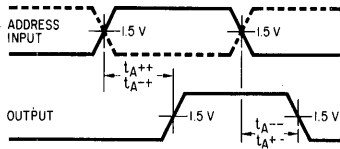
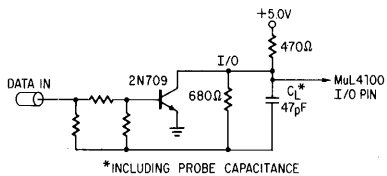

Fig. 3  
93400  
TEST LOAD CONDITIONS



LOW Level  $\leq 0.45$  V  
HIGH Level  $\geq 3.0$  V  
Rise, Fall Time =  $10 \pm 5$  ns

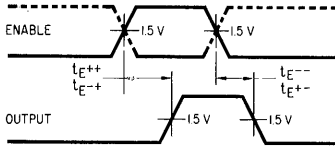

Fig. 4  
93400 STANDARD  
INPUT PULSE

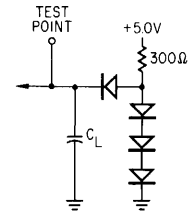
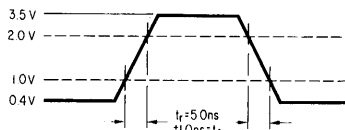
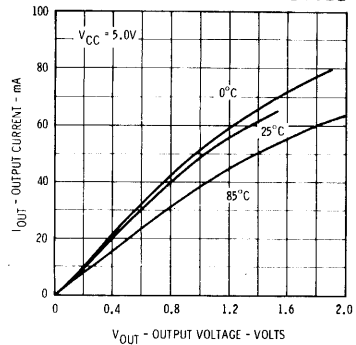

Fig. 5  
93400 • 93400B  
OUTPUT CHARACTERISTICS



The timing curves in Figures 8 through 13 are obtained using the pulse shape in Figure 6 and the loading in Figure 5. In Figures 12 and 13 the  $C_L$  value in the load is varied.

Fig. 6  
INPUT THRESHOLD VOLTAGE  
VERSUS TEMPERATURE

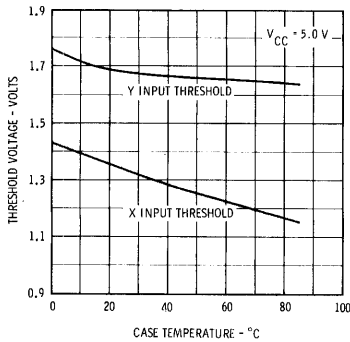

Fig. 7  
X ACCESS TIME  
VERSUS TEMPERATURE

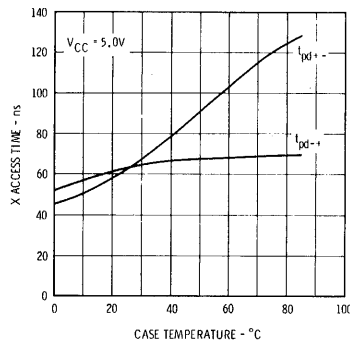

Fig. 8  
Y ACCESS TIME  
VERSUS TEMPERATURE

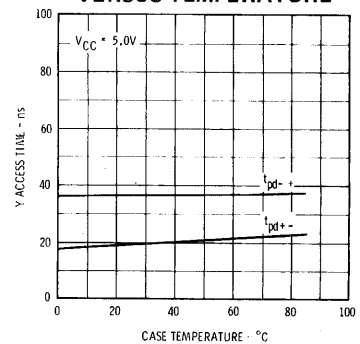

Fig. 9  
MINIMUM WRITE PULSE  
WIDTH VERSUS TEMPERATURE

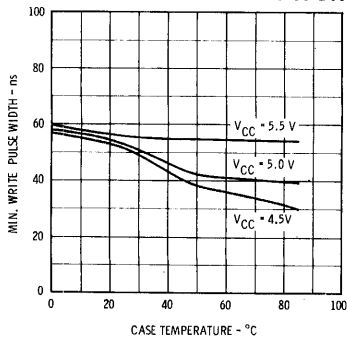

Fig. 10  
X ACCESS TIME VERSUS  
LOAD CAPACITANCE

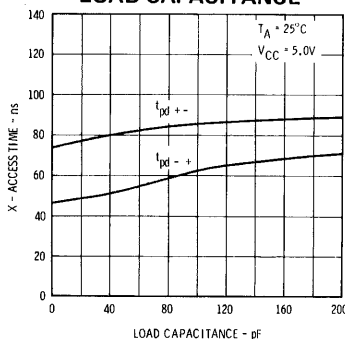
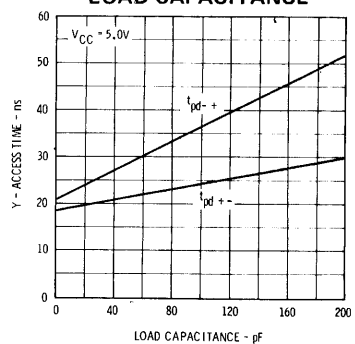

Fig. 11  
Y ACCESS TIME VERSUS  
LOAD CAPACITANCE



# TTL MEMORY 93402

## 16-BIT ASSOCIATIVE/CONTENT ADDRESSABLE MEMORY

FORMERLY 4102

**DESCRIPTION** — The 93402 is a high speed 16-Bit Associative Random Access Memory. It is a linear select 4-word by 4-bit array which performs the equality search on all bits in parallel. The 93402 is TTL compatible.

With the bit enable lines ( $\bar{E}_0 - \bar{E}_3$ ) LOW, the outputs ( $M_0 - M_3$ ) go HIGH if associated stored data matches the descriptor bits ( $\bar{D}_0 - \bar{D}_3$ ). If a bit enable line is held HIGH, a match is forced on the corresponding bit in all the words regardless of the state of the descriptor bit ( $\bar{D}_0 - \bar{D}_3$ ). An inverter is connected to the match output  $M_0$  to give its negation  $\bar{M}_0$ .

A word is addressed by having an active LOW on the appropriate address line ( $\bar{A}_0 - \bar{A}_3$ ). Any number of words may be addressed simultaneously.

Data can be written into the memory through the data inputs ( $\bar{D}_0 - \bar{D}_3$ ) under control of the address inputs and the appropriate bit enable ( $\bar{E}_0 - \bar{E}_3$ ) when the write enable ( $\bar{WE}$ ) is LOW.

Reading can occur either during an equality search or a write operation. If a single word is addressed that word will appear at the data outputs ( $\bar{O}_0 - \bar{O}_3$ ). If multiple addressing is used, the word appearing at the data output is the AND (positive logic) or the OR (negative logic) of the addressed words.

All outputs are uncommitted collectors allowing maximum flexibility in output connection. In many applications such as memory expansion, the outputs of many 93402's can be tied together. In other applications, the wired-OR is not used. In either case an external pull up resistor must be used to attain a HIGH at an output.

- 25 ns TYPICAL MATCH TIME
- MULTIPLE MATCHING AND ADDRESSING
- UNCOMMITTED COLLECTOR OUTPUTS FOR WIRED-OR CAPABILITY
- LINEAR SELECT ADDRESSING
- BIT MASKING

### LOGIC SYMBOL

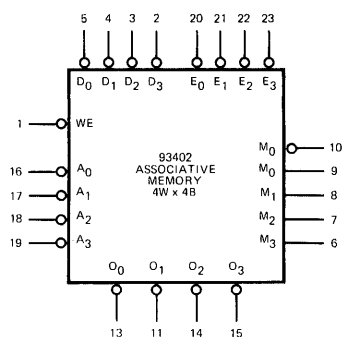

$V_{CC}$  = Pin 24  
Gnd = Pin 12

### LOGIC DIAGRAM

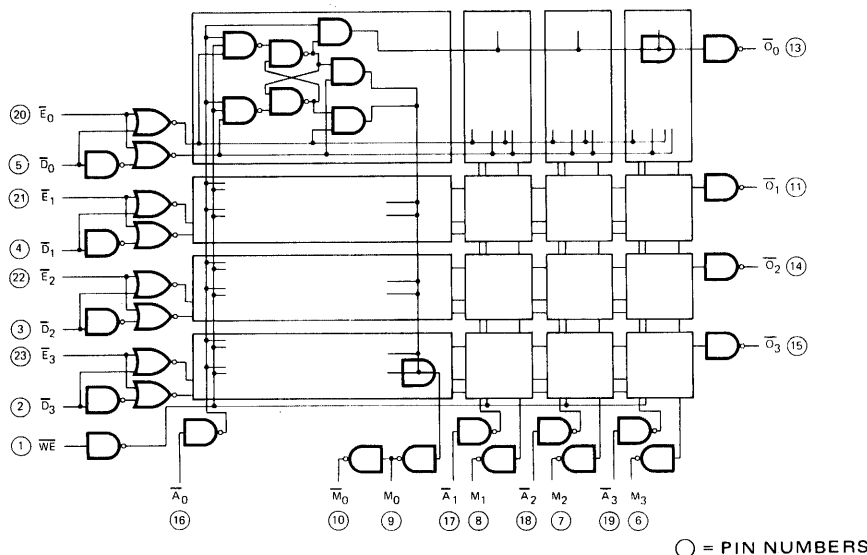

### CONNECTION DIAGRAM DIP (TOP VIEW)

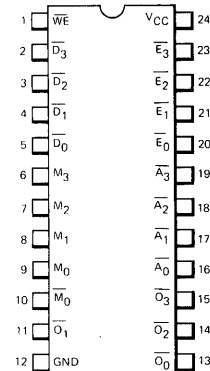

# FAIRCHILD TTL MEMORY • 93402

## LOADING RULES

	HIGH LEVEL (TTL Unit Loads)	LOW LEVEL (TTL Unit Loads)
Address	1.0	1.0
Bit Enable	1.5	1.5
Write Enable	1.5	1.5
Data Input	1.0	1.0
Data Output	Open Collector	6.2
Match Output <sup>1</sup>	Open Collector	6.2

1 Unit Load (U.L.) = 60  $\mu$ A HIGH/1.6 mA LOW.

The external pull-up resistor R is selected to lie in the range as shown.

$$\frac{5.1}{10 - \text{F.O. (1.6)}} \leq R \leq \frac{2.1}{\text{NL} + \text{F.O. (0.06)}}$$

R is in k $\Omega$

N = number of wired-OR outputs

F.O. = number of TTL loads driven

L = Sum of all I<sub>CEX</sub> of wired-OR outputs

The minimum value of R is limited by output current sinking ability. The maximum value of R is determined by the output and input leakage current (I<sub>CEX</sub> and I<sub>R</sub>) which must be supplied to hold the output at 2.4 V.

F.O.	Maximum number of Wired-OR's
1	66
2	52
3	38
4	24
5	10
5.7	0

## ABSOLUTE MAXIMUM RATINGS (above which the useful life may be impaired)

Storage Temperature	-65°C to +150°C
Temperature (Ambient) Under Bias	-55°C to +125°C
V <sub>CC</sub> Pin Potential to Ground	-0.5 V to +7.0 V
Input Pin Voltage	-0.5 V to +5.5 V
Current into Output Terminal	50 mA
Output Voltage	-0.5 V to +8.0 V

## ELECTRICAL CHARACTERISTICS (T<sub>A</sub> = 0°C to 75°C, V<sub>CC</sub> = 5.0 V $\pm$ 5%) (units are pulse tested) (Part No. 93402XC) \*

SYMBOL	PARAMETER	LIMITS			UNITS	CONDITIONS
		0°C MIN.	+25°C MIN. MAX.	+75°C MIN. MAX.		
I <sub>FA</sub>	Address Input Load Current	-1.6	-1.6	-1.6	mA	V <sub>CC</sub> = 5.25 V, V <sub>A</sub> = 0.45 V
I <sub>FB</sub>	Bit Enable Load Current	-2.4	-2.4	-2.4	mA	V <sub>CC</sub> = 5.25 V, V <sub>CS</sub> = 0.45 V
I <sub>FWE</sub>	Write Enable Load Current	-2.4	-2.4	-2.4	mA	V <sub>CC</sub> = 5.25 V, V <sub>W</sub> = 0.45 V
I <sub>FI</sub>	Data Input Load Current	-1.6	-1.6	-1.6	mA	V <sub>CC</sub> = 5.25 V, V <sub>D</sub> = 0.45 V
I <sub>RA</sub>	Address Input Leakage Current	60	60	60	$\mu$ A	V <sub>CC</sub> = 5.25 V, V <sub>A</sub> = 4.5 V
I <sub>RBE</sub>	Bit Enable Input Leakage Current	90	90	90	$\mu$ A	V <sub>CC</sub> = 5.25 V, V <sub>CS</sub> = 4.5 V
I <sub>RWE</sub>	Write Enable Leakage Current	90	90	90	$\mu$ A	V <sub>CC</sub> = 5.25 V, V <sub>W</sub> = 4.5 V
I <sub>RI</sub>	Data Input Leakage Current	60	60	60	$\mu$ A	V <sub>CC</sub> = 5.25 V, V <sub>D</sub> = 4.5 V
I <sub>CEX</sub>	Output Leakage Current (Note 4)	50	50	50	$\mu$ A	V <sub>CC</sub> = 5.25 V, V <sub>CEX</sub> = 5.25 V
I <sub>CEX M<sub>0</sub></sub>	Output Leakage Current for M <sub>0</sub>	110	110	110	$\mu$ A	V <sub>CC</sub> = 5.25 V, V <sub>CEX</sub> = 5.25 V
V <sub>OL</sub>	Output LOW Voltage (Note 5)	0.45	0.45	0.45	V	V <sub>CC</sub> = 4.75 V, I <sub>OL</sub> = 10 mA One Word Addressed
V <sub>IL</sub>	Input LOW Voltage (Note 6)	0.85	0.85	0.85	V	V <sub>CC</sub> = 5.0 V, Monitor Appropriate Output To Guarantee This Test Limit
V <sub>IH</sub>	Input HIGH Voltage (Note 6)	2.0	2.0	2.0	V	V <sub>CC</sub> = 5.0 V, Monitor Appropriate Output To Guarantee This Test Limit
I <sub>CC</sub>	Supply Current	125	125	125	mA	V <sub>CC</sub> = 5.25 V, Worst Case

\*X = package type; F for Flatpak, D for Ceramic Dip, P for Plastic Dip. See Packaging Information Section for packages available on this product.

### NOTES:

- (4) For all outputs except M<sub>0</sub>.
- (5) For all outputs.
- (6) For all inputs



# FAIRCHILD TTL MEMORY • 93402

## SWITCHING CHARACTERISTICS ( $T_A = 25^\circ\text{C}$ , $V_{CC} = 5.0\text{ V}$ )

SYMBOL	PARAMETER	LIMIT (ns)		LOAD	CONDITIONS C	NOTE
		TYP.	MAX.			
$t_{AO-}$	Address to Output Turn-On Delay	20	30	10 mA	30 pF	1
$t_{AO+}$	Address to Output Turn-Off Delay	25	35	10 mA	30 pF	1
$t_{DM+}$	Descriptor to Output Match Turn-On Delay	25	35	10 mA	30 pF	2
$t_{DM-}$	Descriptor to Output Match Turn-Off Delay	30	40	10 mA	30 pF	2
$t_{WP}$	Write Pulse Width Required to Write	33	40	10 mA	30 pF	
$t_{WO}$	Write Delay	50	80	10 mA	30 pF	
$t_s$	Maximum Set-up Time on Data Input	33	40	10 mA	30 pF	3
$t_r$	Release Time (Minimum Set-up Time) on Data Input	0	19	10 mA	30 pF	3

**NOTES:**

- (1) To test  $t_{AO+}$  and  $t_{AO-}$  a LOW must be stored in the cell under test.
- (2) To test  $t_{DM-}$  and  $t_{DM+}$ , a mismatch must occur in at least one bit of the word under test
- (3) Setup and release times are measured with respect to the rising edge of the Write enable. To guarantee writing in the correct data, the data input must be good by  $t_s$  and remain good until after  $t_r$ .

The typical capacitance of one 93402 output is 7.0 pF.

### SWITCHING WAVEFORMS

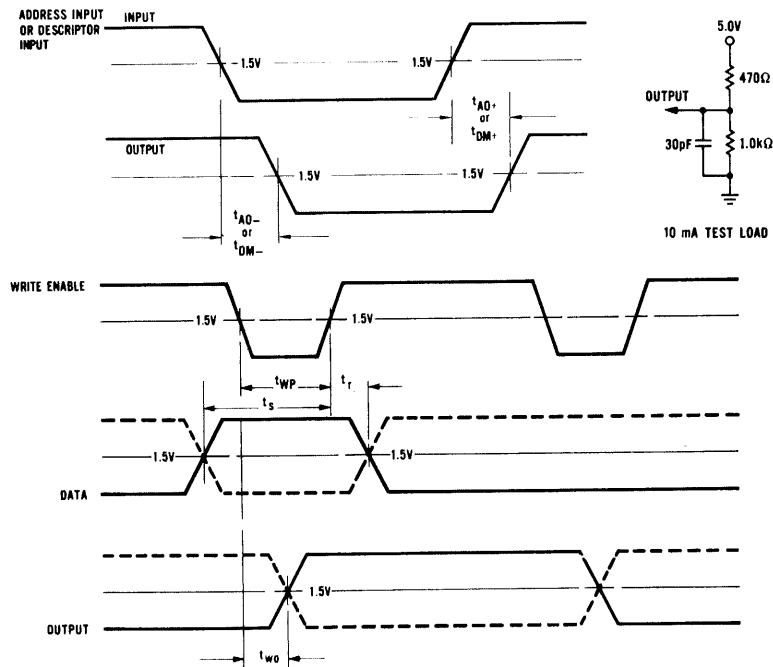

TYPICAL ELECTRICAL CHARACTERISTICS

DATA AND ADDRESS INPUT LOAD CURRENT VERSUS INPUT VOLTAGE

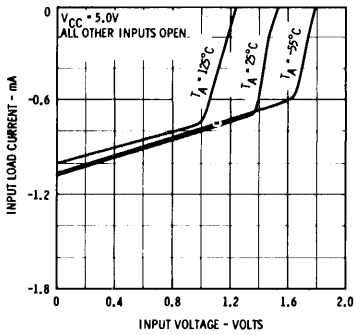

WRITE ENABLE AND BIT ENABLE INPUT LOAD CURRENT VERSUS INPUT VOLTAGE

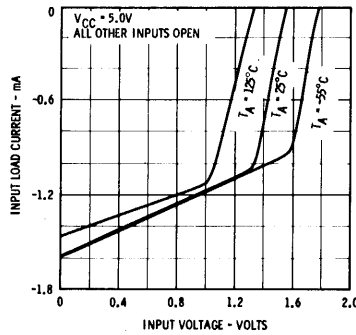

OUTPUT CURRENT VERSUS OUTPUT SATURATION VOLTAGE ALL OUTPUTS

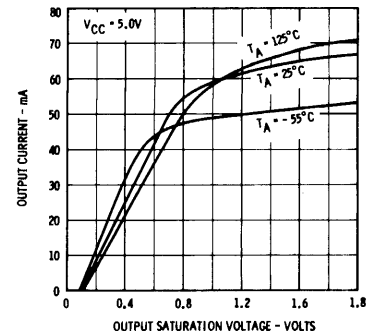

ADDRESS TO OUTPUT DELAY TIME VERSUS AMBIENT TEMPERATURE

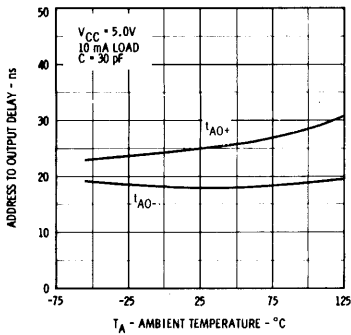

DESCRIPTOR TO OUTPUT DELAY TIME VERSUS AMBIENT TEMPERATURE

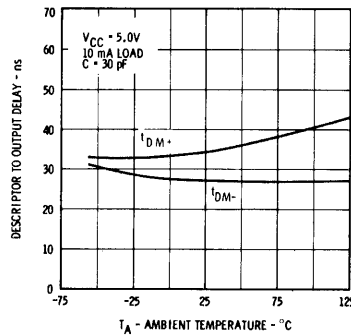

ADDRESS TO OUTPUT DELAY TIME VERSUS LOAD CAPACITANCE

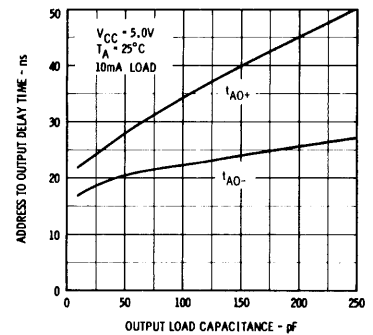

DESCRIPTOR TO OUTPUT DELAY TIME VERSUS LOAD CAPACITANCE

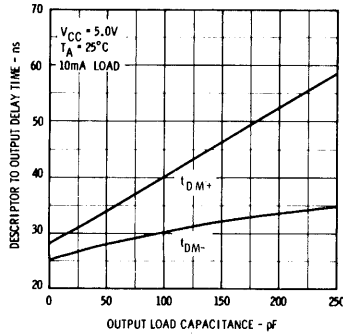

WORST CASE WRITE PULSE WIDTH VERSUS AMBIENT TEMPERATURE

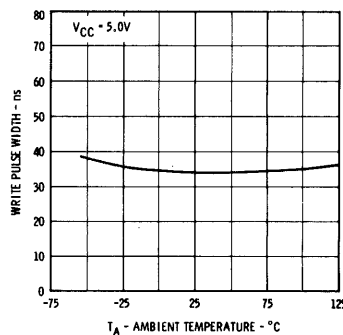

# TTL MEMORY 93403

## 64-BIT FULLY DECODED READ/WRITE MEMORY

FORMERLY 4103

**DESCRIPTION** — The 93403 is a high speed 64-Bit Read/Write Memory organized 16 words by four bits. Four address lines are buffered and decoded "on chip" for word selection. The 93403 is made with TTL circuitry and all inputs are equivalent to one TTL load.

**OPERATION** — When the 93403 receives a LOW at the Chip Select ( $\overline{CS}$ ) input, the binary address ( $A_0, A_1, A_2$  and  $A_3$ ) is decoded to select one of sixteen 4-bit words. If the Write Enable ( $\overline{WE}$ ) is at a HIGH level, the contents of the selected word are non-destructively read out and the sense amplifier outputs ( $\overline{O}_0, \overline{O}_1, \overline{O}_2$  and  $\overline{O}_3$ ) reflect the state of the stored data in the four bits of the selected word. If the Write Enable is LOW, the data present on the Data Input lines ( $D_0, D_1, D_2$  and  $D_3$ ) is written into the four bits of the selected word. Note that there is inversion through the device in a read operation.

- OUTPUT WIRED-OR CAPABILITY
- ON CHIP DECODING
- NON-DESTRUCTIVE READOUT
- CHIP SELECT FOR SYSTEM WORD EXPANSION
- TTL COMPATIBLE

**ABSOLUTE MAXIMUM RATINGS** (above which the useful life may be impaired)

Storage Temperature	-65°C to + 150°C
Temperature (Case) Under Bias	-55°C to + 125°C
V <sub>CC</sub> Pin Potential to Ground	-0.5 V to + 8.0 V
Input Pin Voltage	-1.5 V to + 5.5 V
Current Into Output Terminal	100 mA
Output Voltage (external circuit dependent)	-0.5 V to + 8.0 V

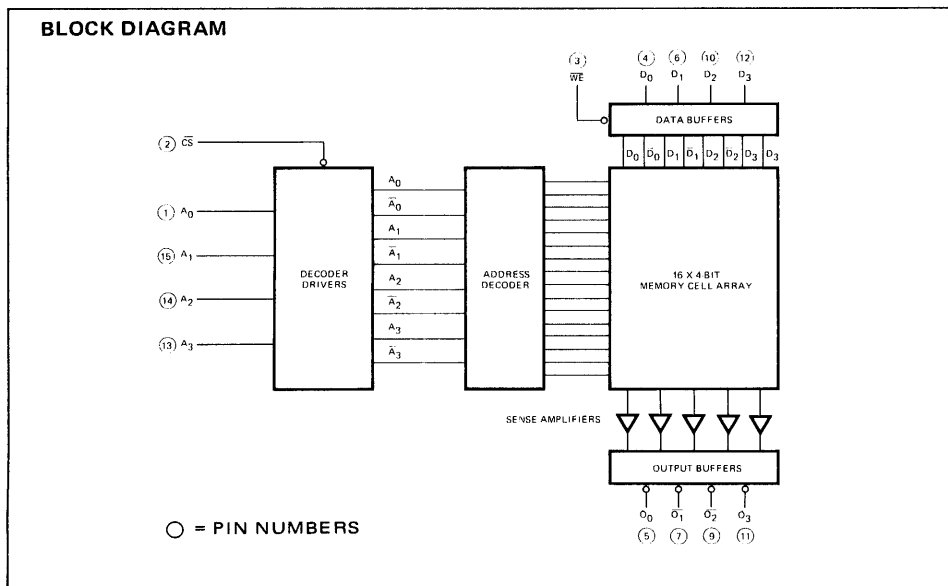
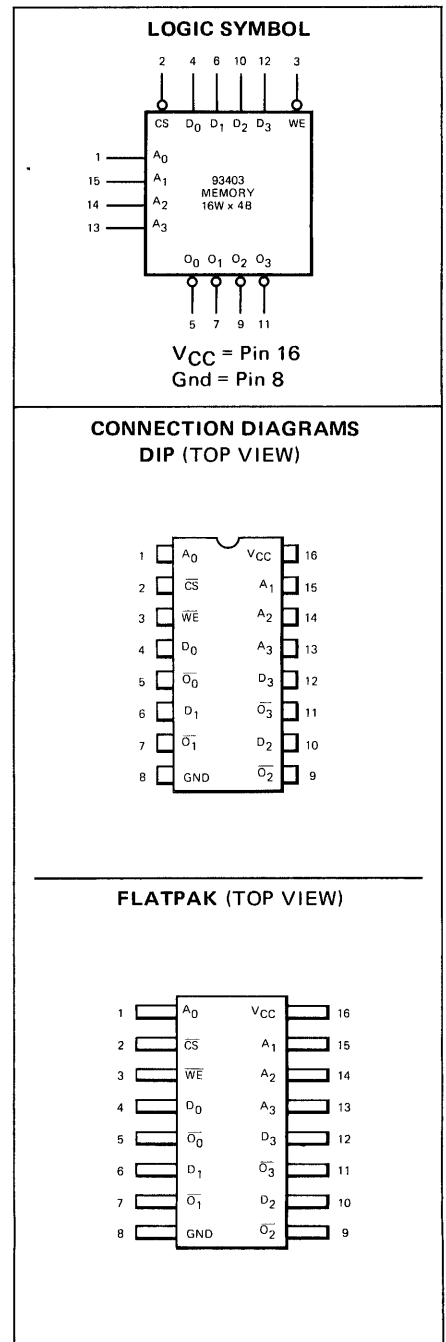

# FAIRCHILD TTL MEMORY • 93403

**ELECTRICAL CHARACTERISTICS** ( $T_{case} = 0^{\circ}C$  to  $75^{\circ}C$ ,  $V_{CC} = 5.0 V \pm 5\%$ ) (units are pulse tested) (Part No. 93403XC)

SYMBOL	TEST	LIMITS						UNITS	CONDITIONS
		0°C		+ 25°C		+ 75°C			
		MIN.	MAX.	MIN.	MAX.	MIN.	MAX.		
$I_{FA}$	Address Input Load Current	-1.6		-1.6		-1.6		mA	$V_{CC} = 5.25 V$ , $V_A = 0.45 V$
$I_{FCS}$	Chip Select Load Current	-1.6		-1.6		-1.6		mA	$V_{CC} = 5.25 V$ , $V_{CS} = 0.45 V$
$I_{FWE}$	Write Enable Load Current	-1.6		-1.6		-1.6		mA	$V_{CC} = 5.25 V$ , $V_W = 0.45 V$
$I_{FD}$	Data Input Load Current	-1.6		-1.6		-1.6		mA	$V_{CC} = 5.25 V$ , $V_D = 0.45 V$
$I_{RA}$	Address Input Leakage Current	60		60		60		$\mu A$	$V_{CC} = 5.25 V$ , $V_A = 4.5 V$
$I_{RCS}$	Chip Select Input Leakage Current	60		60		60		$\mu A$	$V_{CC} = 5.25 V$ , $V_{CS} = 4.5 V$
$I_{RWE}$	Write Enable Leakage Current	60		60		60		$\mu A$	$V_{CC} = 5.25 V$ , $V_W = 4.5 V$
$I_{RD}$	Data Input Leakage Current	60		60		60		$\mu A$	$V_{CC} = 5.25 V$ , $V_D = 4.5 V$
$I_{CEX}$	Output Leakage Current	100		100		100		$\mu A$	$V_{CC} = 5.25 V$ , $V_{CEX} = 5.25 V$ 3.0 on Chip Select
$V_{OL}$	Output LOW Voltage	0.45		0.45		0.45		V	$V_{CC} = 4.75 V$ , $I_{OL} = 16 mA$ $\overline{CS} = V_{IL}$ , $\overline{WE} = V_{IH}$
$V_{IL}$	Input LOW Voltage	0.85		0.85		0.85		V	$V_{CC} = 5.0 V$ , Monitor Appropriate Output To Guarantee This Test Limit
$V_{IH}$	Input HIGH Voltage	2.0		2.0		2.0		V	$V_{CC} = 5.0 V$ , Monitor Appropriate Output To Guarantee This Test Limit
$I_{CC}$	Supply Current	110		110		110		mA	$V_{CC} = 5.25 V$ , Write Enable = 3.0 V, other inputs Grounded
$V_{CD}$	Clamp Diode Voltage, All Inputs	-1.0		-1.0		-1.0		V	$I_{CD} = -5.0 mA$
$BV_X$	Breakdown Voltage, All Inputs	5.5		5.5		5.5		V	$I_X = 1.0 mA$

X = package type; F for Flatpak, D for Ceramic Dip, P for Plastic Dip. See Packaging Information Section for packages available on this product.

## SWITCHING CHARACTERISTICS

SYMBOL	CHARACTERISTIC	DEFINITION	LIMITS			UNITS
			25°C			
			MIN.	TYP.	MAX.	
$t_A$	Read Access Time	Time From Switching Address Or Chip Select To Data At Output	45	60		ns
$t_{SR}$	Sense Recovery Time	Time From Switching Address Or Chip Select To Output HIGH	45	60		ns
$t_{WP}$	Write Pulse	Write Pulse Width - Width of Pulse Guaranteed to Write	45	30		ns
$t_{WR}$	Write Recovery Time	Time From Write Pulse Going HIGH to Output LOW			65	ns
$t_{DH}$	Data Hold Time	Time From Write Pulse Going HIGH to Change Data Or Address			5.0	ns
$t_{DS}$	Data Set-Up Time	Time Data Must Be Present Before Write Pulse	5.0	0		ns
$t_{AS}$	Address Strobe Time	Time Address Must Be Present in Order to Write	5.0	10	45	ns

## WAVEFORMS

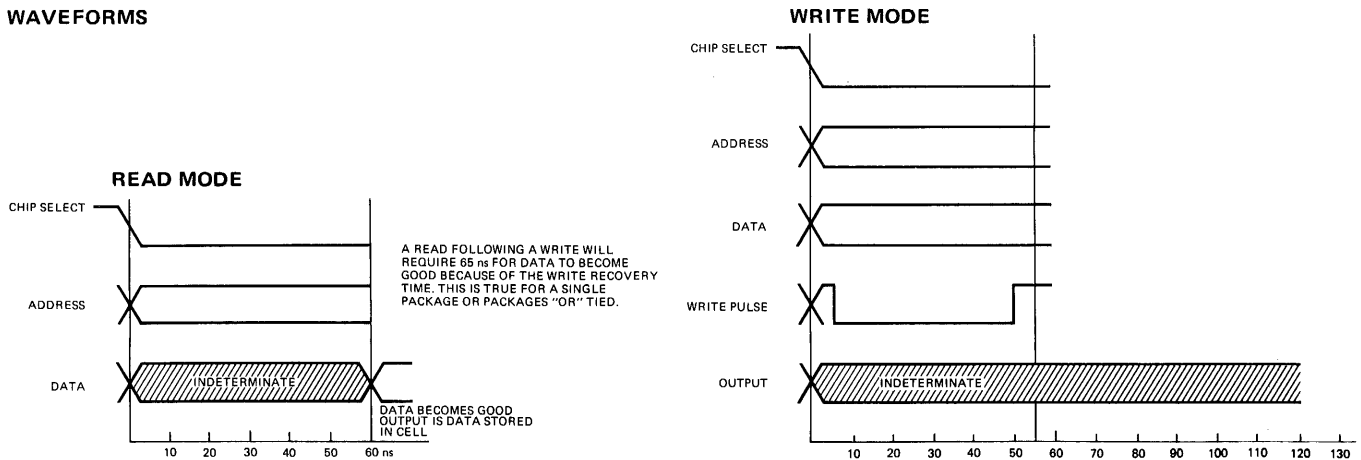

TYPICAL ELECTRICAL CHARACTERISTICS

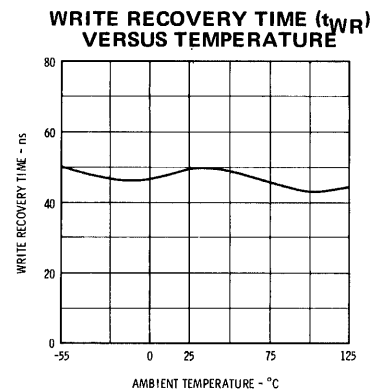
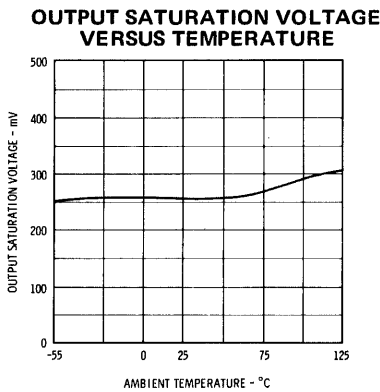
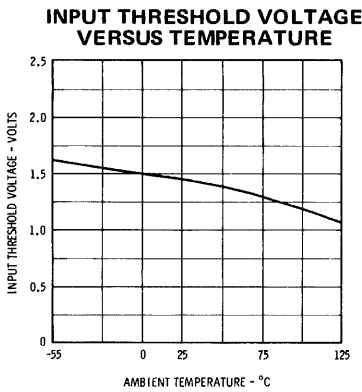
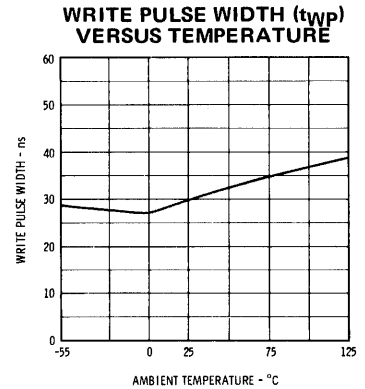
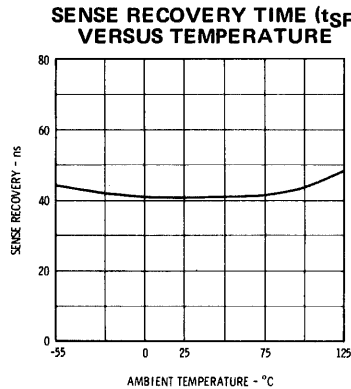
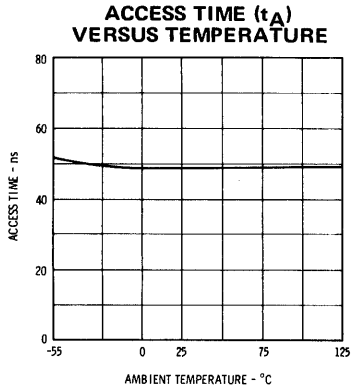

TTL LOADING RULES

	HIGH LEVEL	LOW LEVEL
Address	1 U. L.	1 U. L.
Chip Select	1 U. L.	1 U. L.
Write Enable	1 U. L.	1 U. L.
Data Input	1 U. L.	1 U. L.
Data Output	Open Collector	10 U. L.

- 1 LOW Level TTL Unit Load (U.L.) = 1.6 mA
- 1 HIGH Level TTL Unit Load (U.L.) = 60  $\mu$ A

Uncommitted collector outputs are provided on the 93403 to allow maximum flexibility in output connection. In many applications such as memory expansion, the outputs of many 93403 can be tied together. In other applications the wired-OR is not used. In either case an external pullup resistor of value  $R_L$  must be used to provide a HIGH at the output when it is off. Any value of  $R_L$  within the range specified below may be used.

$$\frac{5.05}{16 - F.O. (1.6)} \leq R_L \leq \frac{2.1}{N (0.1) + F.O. (0.06)}$$

$R_L$  is in  $k\Omega$   
 $N$  = number of wired-OR outputs  
 $F.O.$  = number of TTL loads driven  
 $V_{CC} = 5.0 V \pm 10\%$

The minimum value of  $R_L$  is limited by output current sinking ability. The maximum value of  $R_L$  is determined by the output and input leakage current ( $I_{CEX}$  and  $I_R$ ) which must be supplied to hold the output at 2.4 V.

TRUTH TABLE

WE	CS	OUTPUT	MODE
H	H	HIGH No Glitches	Not Read
L	H	Indeterminate Output	Not Write
H	L	Function of Data Stored in Cell	Read
L	L	Indeterminate Output	Write

SWITCHING TEST CIRCUIT  
15 mA LOAD

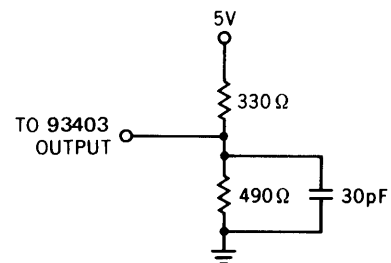

# TTL MEMORY 93406

## 1024-BIT READ ONLY MEMORY

**DESCRIPTION** – The Fairchild 93406 is a 1024-bit Bipolar Read Only Memory organized 256 words by four bits. An 8-bit binary address is used to select the desired word. The four outputs are uncommitted collectors which permit "OR" tying of the outputs for expanding the memory in the word direction. The customer can specify the active level of the 2-input chip select gate,  $\overline{CS}_1$  and  $\overline{CS}_2$  both will be active LOW unless otherwise specified by the customer. The programmable enable feature allows expansion of the memory to 1024 words without any external gates.

The contents of the memory are mask programmed to the customers specification. The customer can specify the desired ROM code on either the 93406 Coding Form(s) or by punched cards using the 93406 Data Card Format.

- DTL AND TTL COMPATIBLE
- ACCESS TIME – 50 ns MAX
- FULLY DECODED – ON CHIP ADDRESS DECODER AND BUFFER
- 2 CHIP SELECT INPUTS PROVIDING EASY MEMORY EXPANSION
- PROGRAMMABLE CHIP SELECTS
- OR-TIE CAPABILITY
- STANDARD 16-LEAD DUAL IN-LINE PACKAGE

### PIN NAMES

$A_0$  to  $A_7$   
 $\overline{CS}_1$ ,  $\overline{CS}_2$   
 $O_0$  to  $O_3$

Address Inputs  
 Chip Select Inputs  
 Data Outputs

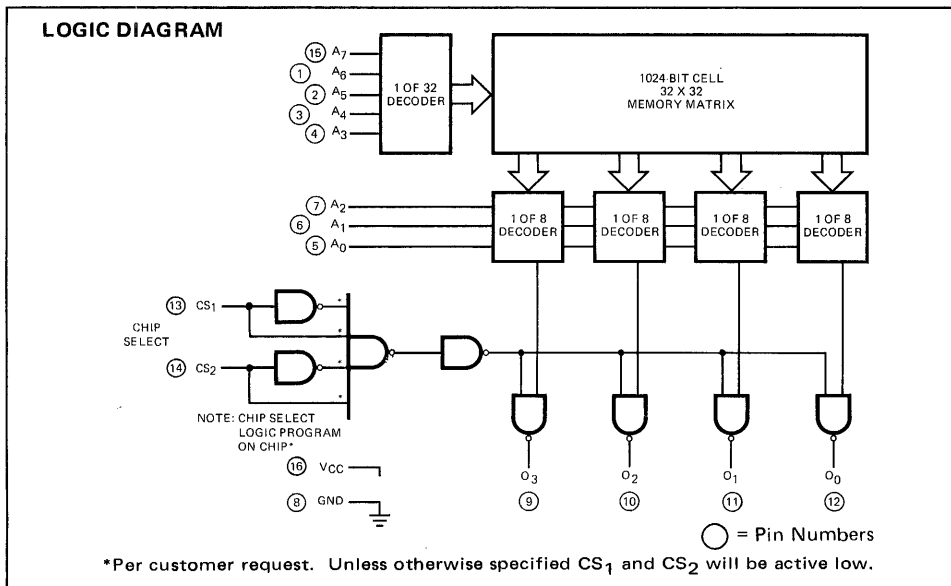

### LOGIC SYMBOL

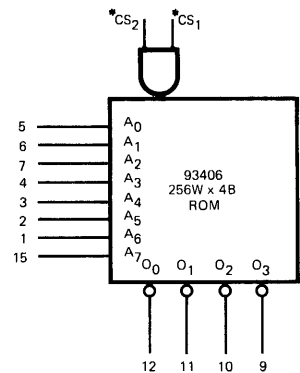

$V_{CC}$  = PIN 16  
 GND = PIN 8

\*Chip selects active level may be programmed per customer requirements. If not specified both CS will be active low.

### CONNECTION DIAGRAM DIP (TOP VIEW)

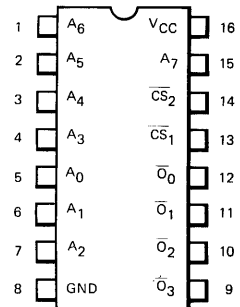

**93406 DATA CARD FORMAT**

The most efficient method of ordering the 93406 is to punch the desired truth table on a punched card in the format described below. Fairchild will generate mask and test program data directly from these inputs. This eliminates the chance of error when transcribing inputs from a hand written truth table.

Data should be provided on a deck of 34 standard 80 column cards containing the following information.

**CARD NO. 1 – Customer Identification**

Column	Content
1	Blank
2–28	Customer Name, Drawing or Specification control number.
29–32	Blank
33–39	FAIRCHILD PART NUMBER. This part number is supplied by the factory through your Fairchild sales representative.
40–64	Blank
65–72	Date
73–80	Blank

**CARD NO. 2 – Chip Select Option**

Column	Content
1–11	Punch "Chip Select"
12	Blank
13, 14	Punch Charts '00', '01', '10' or '11', depending on the chip select code option. (First bit represents CS <sub>1</sub> input, second bit represents CS <sub>2</sub> input. '0' = LOW, '1' = HIGH.)
15–32	Blank
33–39	Repeat FAIRCHILD PART NUMBER (This is used for positive identification).
40–80	Blank

**CARDS NO. 3 through 34 – Truth Table Deck**

Each card will contain instructions for the output levels for 8 input words.

Column	Content
1–7	Punch the numerals representing the first and last words on that card (i.e.: 000-007, 008-015, 016-023. . .248-255). Word order is determined by the value of the binary address – A <sub>7</sub> = MSB, A <sub>0</sub> = LSB.
8–9	Blank
10–13	Punch the desired combination of "1's" and "0's" representing the output levels for outputs O <sub>3</sub> , O <sub>2</sub> , O <sub>1</sub> and O <sub>0</sub> (in that order), for the first word on the card, '0' = LOW, '1' = HIGH.
14	Blank
15–18	Punch the desired combination of "1's" and "0's" representing the output levels for the second word on the card.
19	Blank
20–23	Punch the desired combination of "1's" and "0's" representing the output levels for the third word on the card.
24	Blank
25–28	Punch the desired combination of "1's" and "0's" representing the output levels for the fourth word on the card.
29	Blank
30–33	Punch the desired combination of "1's" and "0's" representing the output levels for the fifth word on the card.
34	Blank

## FAIRCHILD TTL MEMORY • 93406

### CARDS NO. 3 through 34 – Truth Table Deck (cont'd)

Column	Content
35–38	Punch the desired combination of "1's" and "0's" representing the output levels for the sixth word on the card.
39	Blank
40–43	Punch the desired combination of "1's" and "0's" representing the output levels for the seventh word on the card.
44	Blank
45–48	Punch the desired combination of "1's" and "0's" representing the output levels for the eighth word on the card.
49	Blank
50–51	Repeat chip select code option as in columns 13 and 14 of card number 2.
52–59	Blank
60–66	Repeat FAIRCHILD PART NUMBER (this number is used for positive identification).
67	Blank
68–80	Use optional.

### 93406 Address Scheme

The 93406 is organized 256 words by 4-bits. The words are numbered 0 through 255 and are addressed using sequential addressing of address inputs  $A_0$  through  $A_7$ , with  $A_0$  as the least significant digit.

WORD	INPUTS							
	Pin 15 $A_7$	Pin 1 $A_6$	Pin 2 $A_5$	Pin 3 $A_4$	Pin 4 $A_3$	Pin 7 $A_2$	Pin 6 $A_1$	Pin 5 $A_0$
WORD 0	0	0	0	0	0	0	0	0
WORD 1	0	0	0	0	0	0	0	1
WORD 2	0	0	0	0	0	0	1	0
WORD 3	0	0	0	0	0	0	1	1
↓	↓	↓	↓	↓	↓	↓	↓	↓
WORD 255	1	1	1	1	1	1	1	1



# FAIRCHILD TTL MEMORY • 93406

## ABSOLUTE MAXIMUM RATINGS

Storage Temperature  
 Temperature (Ambient) Under Bias  
 $V_{CC}$  Pin Potential to Ground  
 Input Pin Voltage  
 Current into Output Terminal  
 Output Voltages

-65°C to +150°C  
 0°C to +75°C  
 -0.5 V to +8.0 V  
 -1.5 V to +5.5 V  
 100 mA  
 -0.5 V to  $V_{CC}$  Value

## DC ELECTRICAL CHARACTERISTICS ( $T_A = 0^\circ\text{C}$ to $+75^\circ\text{C}$ , $V_{CC} = 5.0\text{ V} \pm 5\%$ )

SYMBOL	CHARACTERISTIC	LIMITS			UNITS	CONDITIONS
		MIN.	TYP.	MAX.		
$I_{CEX}$	Output Leakage Current			40	$\mu\text{A}$	$V_{CC} = 5.25\text{ V}$ , $V_{CEX} = 5.25\text{ V}$ Address any HIGH output
$V_{OL}$	Output LOW Voltage			0.45	Volts	$V_{CC} = 4.75\text{ V}$ , $I_{OL} = 15\text{ mA}$ Address any LOW output
$V_{IH}$	Input HIGH Voltage	2.0			Volts	Guaranteed Input HIGH Voltage for All Inputs
$V_{IL}$	Input LOW Voltage			0.85	Volts	Guaranteed Input LOW Voltage for All Inputs
$I_F$	Input LOW Current				mA	$V_{CC} = 5.25\text{ V}$ , $V_F = 0.45\text{ V}$
	$I_{FA}$ (Address Inputs) $I_{FCS}$ (Chip Select Inputs)			0.8 0.8		
$I_R$	Input HIGH, Current				$\mu\text{A}$	$V_{CC} = 5.25\text{ V}$ , $V_R = 4.5\text{ V}$
	$I_{RA}$ (Address Inputs)			40		
	$I_{RCS}$ (Chip Select Input)			40		
$I_{CC}$	Power Supply Current		114	130	mA	$V_{CC} = 5.25\text{ V}$ , Outputs open Inputs Grounded and Chip Selected
$C_O$	Output Capacitance		6.5		pF	$V_{CC} = 5.0\text{ V}$ , $V_O = 5.0\text{ V}$ , $f = 1.0\text{ MHz}$
$V_{CD}$	Input Clamp Diode Voltage		-0.8	-1.0	Volts	$V_{CC} = 4.75\text{ V}$ , $I_A = -5.0\text{ mA}$

## TTL LOADING RULES

INPUT	LOADING	
	HIGH	LOW
$A_7$ to $A_0$	1 U.L.	0.5 U.L.
$CS_1$ , $CS_2$	1 U.L.	0.5 U.L.

OUTPUTS	DRIVE FACTOR	
	HIGH	LOW
$O_0$ to $O_3$	OPEN COLLECTOR	9.3

1 U.L. = 40  $\mu\text{A}$  HIGH/1.6 mA LOW

## TYPICAL ELECTRICAL CHARACTERISTICS

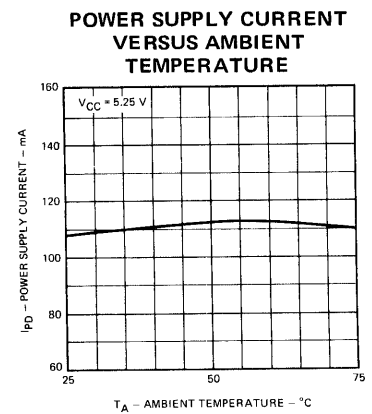
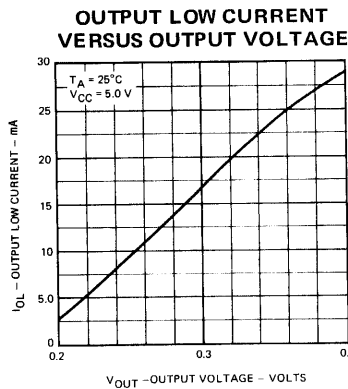
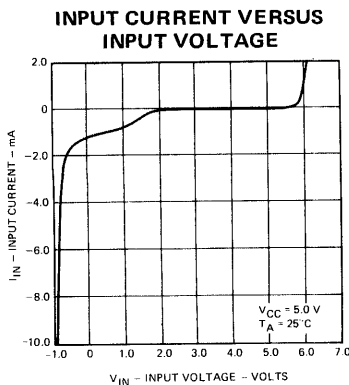

# FAIRCHILD TTL MEMORY • 93406

## SWITCHING CHARACTERISTICS ( $V_{CC} = 5.0 \text{ V}$ , $T_A = 0^\circ \text{C}$ to $+75^\circ \text{C}$ )

SYMBOL	PARAMETER	MIN.	TYP.	MAX.	UNITS	CONDITION
$t_{pd++}$	Propagation Delay Time, LOW to HIGH Output from Chip Select (or Address) LOW to HIGH		30	50	ns	$C_L = 30 \text{ pF}$ $R_{L1} = 300\Omega$ $R_{L2} = 600\Omega$ See Fig. 1
$t_{pd+-}$	Propagation Delay Time, HIGH to LOW Output from Chip Select (or Address) LOW to HIGH		30	50	ns	
$t_{pd-+}$	Propagation Delay Time, LOW to HIGH Output from Chip Select (or Address) HIGH to LOW		30	50	ns	
$t_{pd--}$	Propagation Delay Time, HIGH to LOW Output from Chip Select (or Address) HIGH to LOW		30	50	ns	

**NOTE:**

First + or - of  $t_{pd}$  indicates change in chip select, or address line. Second + or - indicates change in output.

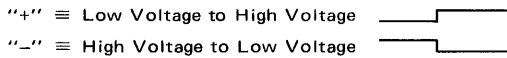

**NOTES:**

- (1) To test CS delay, apply input pulse to CS input. The word selected must contain a '0' in the bit under test.
- (2) To test  $t_{pd++}$  and  $t_{pd--}$  delay, apply input pulse to the address input under test. The word selected must contain '0' when the input pulse is LOW, and a '1' when the input pulse is HIGH in the bit under test.
- (3) To test  $t_{pd+-}$  and  $t_{pd-+}$  delay, apply input pulse to the address input under test. The word selected must contain a '1' when the input pulse is LOW, and a '0' when the input pulse is HIGH in the bit under test.

### SWITCHING TEST OUTPUT LOAD

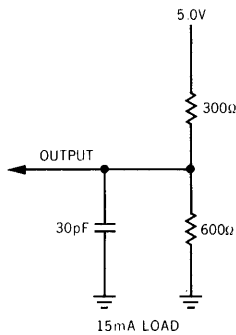
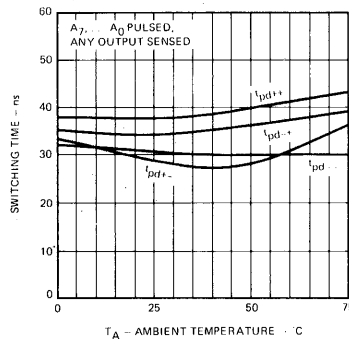
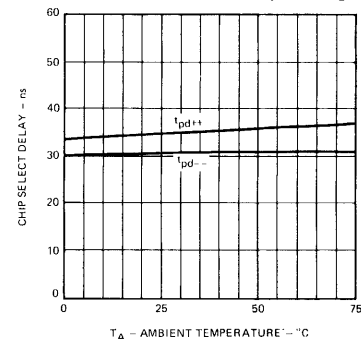

Fig. 1

### SWITCHING TIME VERSUS AMBIENT TEMPERATURE



### CHIP SELECT DELAY TIME VERSUS AMBIENT TEMPERATURE (CS<sub>1</sub> TO O<sub>0</sub>)



### SWITCHING WAVEFORMS

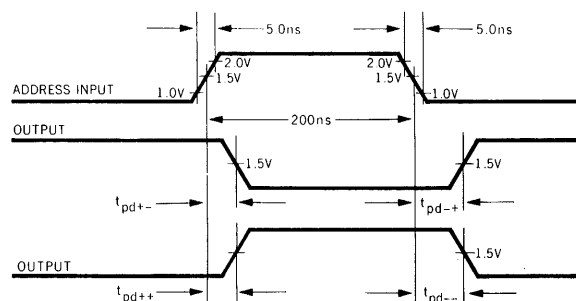
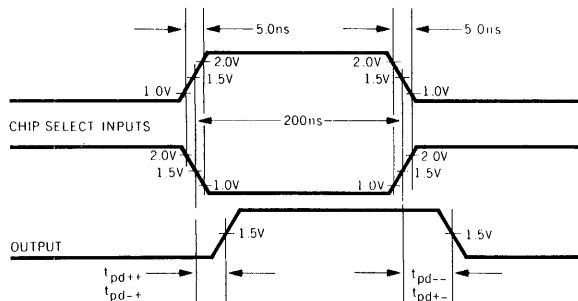

# TTL MEMORY 93406

## 1024-BIT READ ONLY MEMORY

### CUSTOMER CODING FORM

CUSTOM ROM TRUTH TABLE

CUSTOMER \_\_\_\_\_ Location \_\_\_\_\_

Cust. P/N \_\_\_\_\_ Cust. Dwg. # \_\_\_\_\_

Function \_\_\_\_\_ SL # \_\_\_\_\_

Chip Select Code – CS<sub>1</sub> (13) = \_\_, CS<sub>2</sub> (14) = \_\_.\*

\*If not specified, ship select code will be '00'. Package pin numbers are shown in parenthesis.

Input								Word #	Output				
MSB	A <sub>7</sub>	A <sub>6</sub>	A <sub>5</sub>	A <sub>4</sub>	A <sub>3</sub>	A <sub>2</sub>	A <sub>1</sub>		A <sub>0</sub>	MSB	O <sub>3</sub>	O <sub>2</sub>	O <sub>1</sub>
0	0	0	0	0	0	0	0	0	0				
0	0	0	0	0	0	0	0	1	1				
0	0	0	0	0	0	0	1	0	2				
0	0	0	0	0	0	0	1	1	3				
0	0	0	0	0	0	1	0	0	4				
0	0	0	0	0	0	1	0	1	5				
0	0	0	0	0	0	1	1	0	6				
0	0	0	0	0	0	1	1	1	7				
0	0	0	0	1	0	0	0	0	8				
0	0	0	0	1	0	0	1	1	9				
0	0	0	0	1	0	1	0	0	10				
0	0	0	0	1	0	1	1	1	11				
0	0	0	0	1	1	0	0	0	12				
0	0	0	0	1	1	0	1	1	13				
0	0	0	0	1	1	1	0	0	14				
0	0	0	0	1	1	1	1	1	15				
15	1	2	3	4	7	6	5	Pkg. Pin #	9	10	11	12	

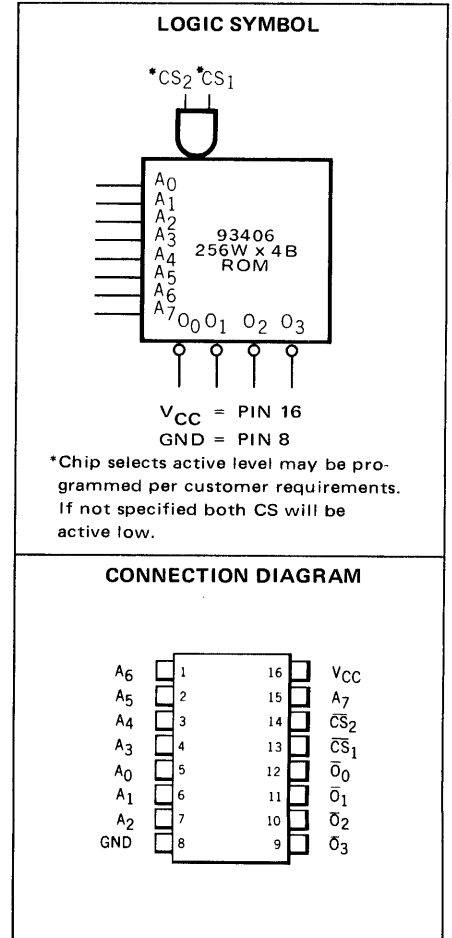

# TTL MEMORY 93406

Input								Word #	Output				Input								Word #	Output					
MSB	A <sub>7</sub>	A <sub>6</sub>	A <sub>5</sub>	A <sub>4</sub>	A <sub>3</sub>	A <sub>2</sub>	A <sub>1</sub>		A <sub>0</sub>	MSB	O <sub>3</sub>	O <sub>2</sub>	O <sub>1</sub>	O <sub>0</sub>	MSB	A <sub>7</sub>	A <sub>6</sub>	A <sub>5</sub>	A <sub>4</sub>	A <sub>3</sub>		A <sub>2</sub>	A <sub>1</sub>	A <sub>0</sub>	MSB	O <sub>3</sub>	O <sub>2</sub>
0	0	0	1	0	0	0	0	16						0	0	1	1	0	0	1	1	51					
0	0	0	1	0	0	0	1	17						0	0	1	1	0	1	0	0	52					
0	0	0	1	0	0	1	0	18						0	0	1	1	0	1	0	1	53					
0	0	0	1	0	0	1	1	19						0	0	1	1	0	1	1	0	54					
0	0	0	1	0	1	0	0	20						0	0	1	1	0	1	1	1	55					
0	0	0	1	0	1	0	1	21						0	0	1	1	1	0	0	0	56					
0	0	0	1	0	1	1	0	22						0	0	1	1	1	0	0	1	57					
0	0	0	1	0	1	1	1	23						0	0	1	1	1	0	1	0	58					
0	0	0	1	1	0	0	0	24						0	0	1	1	1	0	1	1	59					
0	0	0	1	1	0	0	1	25						0	0	1	1	1	1	0	0	60					
0	0	0	1	1	0	1	0	26						0	0	1	1	1	1	0	1	61					
0	0	0	1	1	0	1	1	27						0	0	1	1	1	1	1	0	62					
0	0	0	1	1	1	0	0	28						0	0	1	1	1	1	1	1	63					
0	0	0	1	1	1	0	1	29						0	1	0	0	0	0	0	0	64					
0	0	0	1	1	1	1	0	30						0	1	0	0	0	0	0	1	65					
0	0	0	1	1	1	1	1	31						0	1	0	0	0	0	1	0	66					
0	0	1	0	0	0	0	0	32						0	1	0	0	0	0	1	1	67					
0	0	1	0	0	0	0	1	33						0	1	0	0	0	1	0	0	68					
0	0	1	0	0	0	1	0	34						0	1	0	0	0	1	0	1	69					
0	0	1	0	0	0	1	1	35						0	1	0	0	0	1	1	0	70					
0	0	1	0	0	1	0	0	36						0	1	0	0	0	1	1	1	71					
0	0	1	0	0	1	0	1	37						0	1	0	0	1	0	0	0	72					
0	0	1	0	0	1	1	0	38						0	1	0	0	1	0	0	1	73					
0	0	1	0	0	1	1	1	39						0	1	0	0	1	0	1	0	74					
0	0	1	0	1	0	0	0	40						0	1	0	0	1	0	1	1	75					
0	0	1	0	1	0	0	1	41						0	1	0	0	1	1	0	0	76					
0	0	1	0	1	0	1	0	42						0	1	0	0	1	1	0	1	77					
0	0	1	0	1	0	1	1	43						0	1	0	0	1	1	1	0	78					
0	0	1	0	1	1	0	0	44						0	1	0	0	1	1	1	1	79					
0	0	1	0	1	1	0	1	45						0	1	0	1	0	0	0	0	80					
0	0	1	0	1	1	1	0	46						0	1	0	1	0	0	0	1	81					
0	0	1	0	1	1	1	1	47						0	1	0	1	0	0	1	0	82					
0	0	1	1	0	0	0	0	48						0	1	0	1	0	0	1	1	83					
0	0	1	1	0	0	0	1	49						0	1	0	1	0	1	0	0	84					
0	0	1	1	0	0	1	0	50						0	1	0	1	0	1	0	1	85					
15	1	2	3	4	7	6	5	Pkg. Pin #	9	10	11	12		15	1	2	3	4	7	6	5	Pkg. Pin #	9	10	11	12	

# TTL MEMORY 93406

Input								Word #	Output				Input								Word #	Output					
MSB	A <sub>7</sub>	A <sub>6</sub>	A <sub>5</sub>	A <sub>4</sub>	A <sub>3</sub>	A <sub>2</sub>	A <sub>1</sub>		A <sub>0</sub>	MSB	O <sub>3</sub>	O <sub>2</sub>	O <sub>1</sub>	O <sub>0</sub>	MSB	A <sub>7</sub>	A <sub>6</sub>	A <sub>5</sub>	A <sub>4</sub>	A <sub>3</sub>		A <sub>2</sub>	A <sub>1</sub>	A <sub>0</sub>	MSB	O <sub>3</sub>	O <sub>2</sub>
0	1	0	1	0	1	1	0	86					0	1	1	1	1	0	0	1	121						
0	1	0	1	0	1	1	1	87					0	1	1	1	1	0	1	0	122						
0	1	0	1	1	0	0	0	88					0	1	1	1	1	0	1	1	123						
0	1	0	1	1	0	0	1	89					0	1	1	1	1	1	0	0	124						
0	1	0	1	1	0	1	0	90					0	1	1	1	1	1	0	1	125						
0	1	0	1	1	0	1	1	91					0	1	1	1	1	1	1	0	126						
0	1	0	1	1	1	0	0	92					0	1	1	1	1	1	1	1	127						
0	1	0	1	1	1	0	1	93					1	0	0	0	0	0	0	0	128						
0	1	0	1	1	1	1	0	94					1	0	0	0	0	0	0	1	129						
0	1	0	1	1	1	1	1	95					1	0	0	0	0	0	1	0	130						
0	1	1	0	0	0	0	0	96					1	0	0	0	0	0	1	1	131						
0	1	1	0	0	0	0	1	97					1	0	0	0	0	1	0	0	132						
0	1	1	0	0	0	1	0	98					1	0	0	0	0	1	0	1	133						
0	1	1	0	0	0	1	1	99					1	0	0	0	0	1	1	0	134						
0	1	1	0	0	1	0	0	100					1	0	0	0	0	1	1	1	135						
0	1	1	0	0	1	0	1	101					1	0	0	0	1	0	0	0	136						
0	1	1	0	0	1	1	0	102					1	0	0	0	1	0	0	1	137						
0	1	1	0	0	1	1	1	103					1	0	0	0	1	0	1	0	138						
0	1	1	0	1	0	0	0	104					1	0	0	0	1	0	1	1	139						
0	1	1	0	1	0	0	1	105					1	0	0	0	1	1	0	0	140						
0	1	1	0	1	0	1	0	106					1	0	0	0	1	1	0	1	141						
0	1	1	0	1	0	1	1	107					1	0	0	0	1	1	1	0	142						
0	1	1	0	1	1	0	0	108					1	0	0	0	1	1	1	1	143						
0	1	1	0	1	1	0	1	109					1	0	0	1	0	0	0	0	144						
0	1	1	0	1	1	1	0	110					1	0	0	1	0	0	0	1	145						
0	1	1	0	1	1	1	1	111					1	0	0	1	0	0	1	0	146						
0	1	1	1	0	0	0	0	112					1	0	0	1	0	0	1	1	147						
0	1	1	1	0	0	0	1	113					1	0	0	1	0	1	0	0	148						
0	1	1	1	0	0	1	0	114					1	0	0	1	0	1	0	1	149						
0	1	1	1	0	0	1	1	115					1	0	0	1	0	1	1	0	150						
0	1	1	1	0	1	0	0	116					1	0	0	1	0	1	1	1	151						
0	1	1	1	0	1	0	1	117					1	0	0	1	1	0	0	0	152						
0	1	1	1	0	1	1	0	118					1	0	0	1	1	0	0	1	153						
0	1	1	1	0	1	1	1	119					1	0	0	1	1	0	1	0	154						
0	1	1	1	1	0	0	0	120					1	0	0	1	1	0	1	1	155						
15	1	2	3	4	7	6	5	Pkg. Pin #	9	10	11	12	15	1	2	3	4	7	6	5	Pkg. Pin #	9	10	11	12		

TTL MEMORY 93406

Input								Word #	Output				Word #	Output														
MSB	A <sub>7</sub>	A <sub>6</sub>	A <sub>5</sub>	A <sub>4</sub>	A <sub>3</sub>	A <sub>2</sub>	A <sub>1</sub>		A <sub>0</sub>	MSB	O <sub>3</sub>	O <sub>2</sub>		O <sub>1</sub>	O <sub>0</sub>	MSB	A <sub>7</sub>	A <sub>6</sub>	A <sub>5</sub>	A <sub>4</sub>	A <sub>3</sub>	A <sub>2</sub>	A <sub>1</sub>	A <sub>0</sub>	MSB	O <sub>3</sub>	O <sub>2</sub>	O <sub>1</sub>
1	0	0	1	1	1	0	0	156						1	0	1	1	1	1	1	1	1	191					
1	0	0	1	1	1	0	1	157						1	1	0	0	0	0	0	0	0	192					
1	0	0	1	1	1	1	0	158						1	1	0	0	0	0	0	0	1	193					
1	0	0	1	1	1	1	1	159						1	1	0	0	0	0	0	1	0	194					
1	0	1	0	0	0	0	0	160						1	1	0	0	0	0	0	1	1	195					
1	0	1	0	0	0	0	1	161						1	1	0	0	0	1	0	0	0	196					
1	0	1	0	0	0	1	0	162						1	1	0	0	0	1	0	1	0	197					
1	0	1	0	0	0	1	1	163						1	1	0	0	0	1	1	0	0	198					
1	0	1	0	0	0	0	0	164						1	1	0	0	0	1	1	1	0	199					
1	0	1	0	0	1	0	1	165						1	1	0	0	1	0	0	0	0	200					
1	0	1	0	0	1	1	0	166						1	1	0	0	1	0	0	1	0	201					
1	0	1	0	0	1	1	1	167						1	1	0	0	1	0	1	0	0	202					
1	0	1	0	1	1	0	0	168						1	1	0	0	1	0	1	1	0	203					
1	0	1	0	1	0	0	1	169						1	1	0	0	1	1	0	0	0	204					
1	0	1	0	1	0	1	0	170						1	1	0	0	1	1	0	1	0	205					
1	0	1	0	1	0	1	1	171						1	1	0	0	1	1	1	0	0	206					
1	0	1	0	1	1	0	0	172						1	1	0	0	1	1	1	1	1	207					
1	0	1	0	1	1	0	1	173						1	1	0	1	0	0	0	0	0	208					
1	0	1	0	1	1	1	0	174						1	1	0	1	0	0	0	1	0	209					
1	0	1	0	1	1	1	1	175						1	1	0	1	0	0	1	0	0	210					
1	0	1	1	0	0	0	0	176						1	1	0	1	0	0	1	1	0	211					
1	0	1	1	0	0	0	1	177						1	1	0	1	0	1	0	0	0	212					
1	0	1	1	0	0	1	0	178						1	1	0	1	0	1	0	1	0	213					
1	0	1	1	0	0	1	1	179						1	1	0	1	0	1	1	0	0	214					
1	0	1	1	0	1	0	0	180						1	1	0	1	0	1	1	1	1	215					
1	0	1	1	0	1	0	1	181						1	1	0	1	1	0	0	0	0	216					
1	0	1	1	0	1	1	0	182						1	1	0	1	1	0	0	1	0	217					
1	0	1	1	0	1	1	1	183						1	1	0	1	1	0	1	0	0	218					
1	0	1	1	1	0	0	0	184						1	1	0	1	1	0	1	1	0	219					
1	0	1	1	1	0	0	1	185						1	1	0	1	1	1	0	0	0	220					
1	0	1	1	1	0	1	0	186						1	1	0	1	1	1	0	1	0	221					
1	0	1	1	1	0	1	1	187						1	1	0	1	1	1	1	0	0	222					
1	0	1	1	1	1	0	0	188						1	1	0	1	1	1	1	1	1	223					
1	0	1	1	1	1	0	1	189						1	1	1	0	0	0	0	0	0	224					
1	0	1	1	1	1	1	0	190						1	1	1	0	0	0	0	0	1	225					
15	1	2	3	4	7	6	5	Pkg. Pin #	9	10	11	12		15	1	2	3	4	7	6	5	Pkg. Pin #	9	10	11	12		

# TTL MEMORY 93406

Input								Word #	Output				
MSB	A <sub>7</sub>	A <sub>6</sub>	A <sub>5</sub>	A <sub>4</sub>	A <sub>3</sub>	A <sub>2</sub>	A <sub>1</sub>		A <sub>0</sub>	MSB	O <sub>3</sub>	O <sub>2</sub>	O <sub>1</sub>
1	1	1	0	0	0	1	0	226					
1	1	1	0	0	0	1	1	227					
1	1	1	0	0	1	0	0	228					
1	1	1	0	0	1	0	1	229					
1	1	1	0	0	1	1	0	230					
1	1	1	0	0	1	1	1	231					
1	1	1	0	1	0	0	0	232					
1	1	1	0	1	0	0	1	233					
1	1	1	0	1	0	1	0	234					
1	1	1	0	1	0	1	1	235					
1	1	1	0	1	1	0	0	236					
1	1	1	0	1	1	0	1	237					
1	1	1	0	1	1	1	0	238					
1	1	1	0	1	1	1	1	239					
1	1	1	1	0	0	0	0	240					
1	1	1	1	0	0	0	1	241					
1	1	1	1	0	0	1	0	242					
1	1	1	1	0	0	1	1	243					
1	1	1	1	0	1	0	0	244					
1	1	1	1	0	1	0	1	245					
1	1	1	1	0	1	1	0	246					
1	1	1	1	0	1	1	1	247					
1	1	1	1	1	0	0	0	248					
1	1	1	1	1	0	0	1	249					
1	1	1	1	1	0	1	0	250					
1	1	1	1	1	0	1	1	251					
1	1	1	1	1	1	0	0	252					
1	1	1	1	1	1	0	1	253					
1	1	1	1	1	1	1	0	254					
1	1	1	1	1	1	1	1	255					

15 1 2 3 4 7 6 5 Pkg. Pin # 9 10 11 12

Customers Authorizing Signature \_\_\_\_\_

Date \_\_\_\_\_

Qualified FSC Representative \_\_\_\_\_

Date \_\_\_\_\_

# TTL MEMORY 93407 • 93433

## 16-BIT COINCIDENT SELECT READ/WRITE MEMORY

FORMERLY 5033 • 9033

**DESCRIPTION** – These devices are Planar\* epitaxial integrated 16-bit, bit-oriented, non-destructive readout memory cells, compatible with Fairchild TTL. These memory cells, organized as 16 words by one bit, are designed for high speed scratch-pad memory applications. The 93407 and 93433 are electrically identical, but with different pin configurations. Both devices are available in two fan out options, 40 mA (A) and 20 mA (B) for Industrial/Commercial temperature range.

**OPERATION** – The memory cell consists of 16 RS flip-flops arranged in an addressable four-by-four matrix. The desired bit location is selected by raising the coincident X-Y address lines to a logic "H" level (>2.1 volts) and holding the non-selected address lines at logic "L" level (<0.7 volts). As many as four locations may be addressed simultaneously without destroying stored information. The stored data and its complement at the addressed bit location may be read at the output terminals. If the addressed bit location contains a "1", the  $\overline{S}_1$  output will be LOW and the  $\overline{S}_0$  output will be HIGH. If the addressed bit location contains a "0", the  $\overline{S}_1$  output will be HIGH and the  $\overline{S}_0$  output will be LOW.

Writing is accomplished by activating one of the write amplifiers. To write a "1", the desired bit location is addressed and the input of the "write one" ( $W_1$ ) amplifier is raised to a HIGH level. To write a "0", the input of the "write zero" ( $W_0$ ) amplifier is raised to a HIGH level.

The outputs are open-collector, which may be wired OR for word expansion. (The output transistors are off when none of the bits are selected.) An external resistor should be returned to  $V_{CC}$  to pull-up the wired OR outputs.

- TTL COMPATIBLE
- OUTPUT WIRED-OR CAPABILITY
- TRUE AND COMPLEMENTARY OUTPUTS ARE PROVIDED
- NON DESTRUCTIVE READ OUT
- FAN OUT AVAILABLE IN TWO GRADES: A = 40 mA, B = 20 mA FOR INDUSTRIAL/COMMERCIAL TEMPERATURE RANGE

**ABSOLUTE MAXIMUM RATINGS** (above which the useful life may be impaired)

Storage Temperature	-65°C to +150°C
Temperature (Ambient) Under Bias	-55°C to +125°C
$V_{CC}$ Pin Potential to Ground	-0.5 V to +8.0 V
Input Pin Voltage	-1.5 V to +5.5 V
Current Into Output Terminal	100 mA
Output Voltage	-0.5 V to +8.0 V

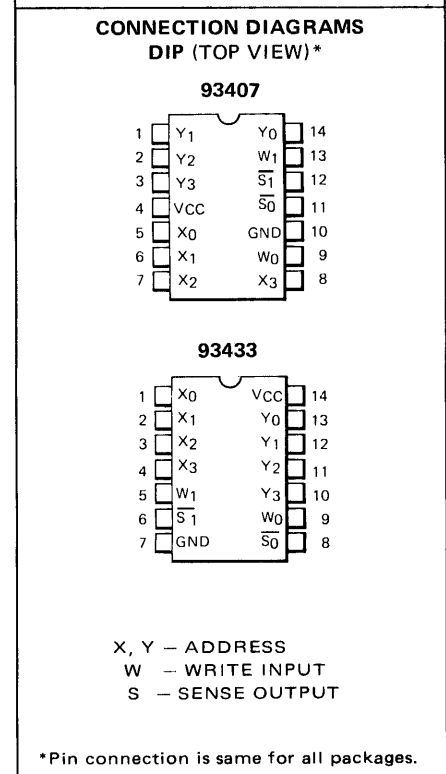
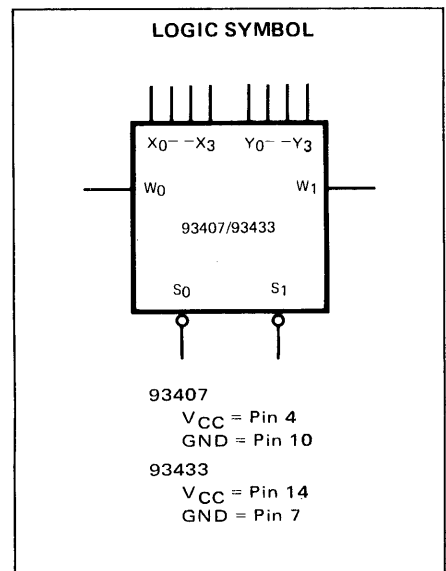
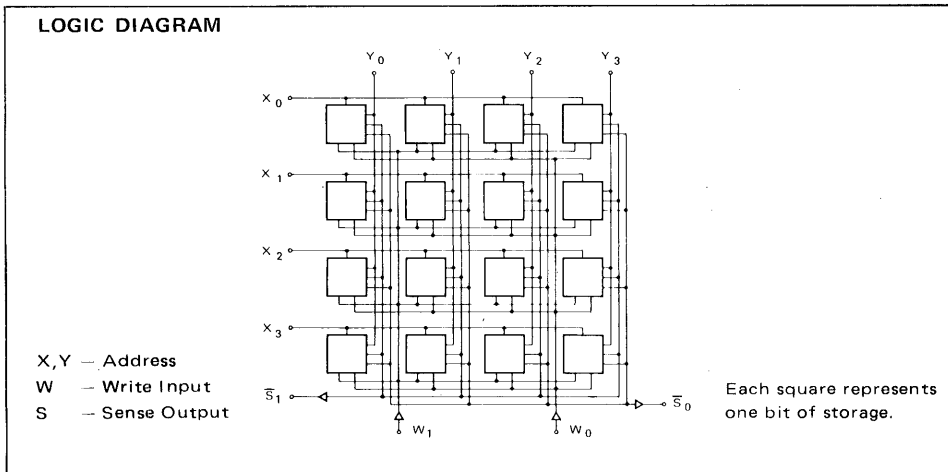



**FAIRCHILD TTL MEMORY • 93407 • 93433**

**ELECTRICAL CHARACTERISTICS** ( $T_A = -55^\circ\text{C}$  to  $+125^\circ\text{C}$ ,  $V_{CC} = 5.0\text{V} \pm 10\%$ ) (Part No. 93407/BXM, 93433/BXM)\*\*

SYMBOL	PARAMETER	LIMITS		UNITS	TEST CONDITIONS
		MIN.	MAX.		
IFX	X Address Input Load Current		11	mA	$V_{CC} = 5.5\text{V}$ , $V_X = 0\text{V}$ , $V_Y = 4.5\text{V}$ , other X inputs grounded
IFY	Y Address Input Load Current		11	mA	$V_{CC} = 5.5\text{V}$ , $V_Y = 0\text{V}$ , $V_X = 4.5\text{V}$ , other Y inputs grounded
IRX	X Address Input Leakage Current		400	$\mu\text{A}$	$V_{CC} = 5.5\text{V}$ , $V_X = 4.5\text{V}$ , other X and Y inputs grounded
IRY	Y Address Input Leakage Current		400	$\mu\text{A}$	$V_{CC} = 5.5\text{V}$ , $V_Y = 4.5\text{V}$ , other X and Y inputs grounded
IFW	Write Input Load Current		1.5	mA	$V_{CC} = 5.5\text{V}$ , $V_W = 0\text{V}$
IRW	Write Input Leakage Current		100	$\mu\text{A}$	$V_{CC} = 5.5\text{V}$ , $V_W = 4.5\text{V}$
ICC	Power Supply Current		65	mA	$V_{CC} = 5.5\text{V}$ , All Inputs Grounded
IBV	Power Supply Current at $V_{CC} = 7\text{V}$		84	mA	$V_{CC} = 7.0\text{V}$ , All Inputs Grounded
ICEX	Output Leakage Current		250	$\mu\text{A}$	$V_{CC} = 5.5\text{V}$ , $V_{CEX} = 5.5\text{V}$ , all inputs grounded
VOL	Output LOW Voltage		0.40	V	$V_{CC} = 4.5\text{V}$ , One Bit Selected $I_{OL} = 20\text{mA}$
VXY(W)	Address Input Threshold to Prevent Writing		0.75	V*	$V_{CC} = 5.0\text{V}$ , other X and Y grounded. Alternately pulse $W_0$ and $W_1$ , cell must not change state.
VXY(W)	Address Input Threshold to Insure Writing	2.1		V*	$V_{CC} = 5.0\text{V}$ , other X and Y grounded. Alternately pulse $W_0$ and $W_1$ , cell state must alternate.
VXY(R)	Address Input Threshold to Prevent Reading		0.8	V	$V_{CC} = 5.0\text{V}$ , other inputs grounded. Both outputs must be on HIGH state.
VXY(R)	Address Input Threshold to Insure Reading	2.1		V*	$V_{CC} = 5.0\text{V}$ , other X and Y grounded. Alternately pulse $W_0$ and $W_1$ , cell state must alternate.
VW(W)	Write Input Threshold to Prevent Writing		0.8	V*	$V_{CC} = 5.0\text{V}$ , one X and one Y to 4.5 V, other X and Y grounded. One write input to $V_{W(W)}$ , pulse the other write input. If $W_0$ is pulsed, $S_0$ will assume LOW state. If $W_1$ is pulsed, $S_1$ will assume LOW state.
VW(W)	Write Input Threshold to Insure Writing	2.1		V*	$V_{CC} = 5.0\text{V}$ , one X and one Y to 4.5 V, other X and Y grounded. One write input to $V_{W(W)}$ , pulse the other write input. If $W_0$ is pulsed, $S_0$ will assume LOW state. If $W_1$ is pulsed, $S_1$ will assume LOW state.

**ELECTRICAL CHARACTERISTICS** ( $T_A = 0^\circ\text{C}$  to  $75^\circ\text{C}$ ,  $V_{CC} = 5.0\text{V} \pm 5\%$ ) (Part No. 93407/AXC, 93407/BXC, 93433/AXC, 93433/BXC)\*\*

SYMBOL	PARAMETER	LIMITS		UNITS	TEST CONDITIONS
		MIN.	MAX.		
IFX	X Address Input Load Current		11	mA	$V_{CC} = 5.25\text{V}$ , $V_X = 0\text{V}$ , $V_Y = 4.5\text{V}$ , other X inputs grounded
IFY	Y Address Input Load Current		11	mA	$V_{CC} = 5.25\text{V}$ , $V_Y = 0\text{V}$ , $V_X = 4.5\text{V}$ , other X inputs grounded
IRX	X Address Input Leakage Current		400	$\mu\text{A}$	$V_{CC} = 5.25\text{V}$ , $V_X = 4.5\text{V}$ , other X and Y inputs grounded
IRY	Y Address Input Leakage Current		400	$\mu\text{A}$	$V_{CC} = 5.25\text{V}$ , $V_Y = 4.5\text{V}$ , other X and Y inputs grounded
IFW	Write Input Load Current		1.5	mA	$V_{CC} = 5.25\text{V}$ , $V_W = 0\text{V}$
IRW	Write Input Leakage Current		100	$\mu\text{A}$	$V_{CC} = 5.25\text{V}$ , $V_W = 4.5\text{V}$
ICC	Power Supply Current		65	mA	$V_{CC} = 5.25\text{V}$ , All Inputs Grounded
IBV	Power Supply Current at $V_{CC} = 7\text{V}$		95	mA	$V_{CC} = 7.0\text{V}$ , All Inputs Grounded
ICEX	Output Leakage Current		250	$\mu\text{A}$	$V_{CC} = 5.25\text{V}$ , $V_{CEX} = 5.5\text{V}$ , all inputs grounded
VOL	Output LOW Voltage		0.45	V	$V_{CC} = 4.75\text{V}$ , One bit selected $I_{OL} = 20\text{mA}$ for IND grade. $I_{OL} = 40\text{mA}$ for IND A grade.
VXY(W)	Address Input Threshold to Prevent Writing		0.8	V*	$V_{CC} = 5.0\text{V}$ , other X and Y grounded. Alternately pulse $W_0$ and $W_1$ , cell must not change state.
VXY(W)	Address Input Threshold to Insure Writing	2.0		V*	$V_{CC} = 5.0\text{V}$ , other X and Y grounded. Alternately pulse $W_0$ and $W_1$ , cell state must alternate.
VXY(R)	Address Input Threshold to Prevent Reading		1.0	V	$V_{CC} = 5.0\text{V}$ , other inputs grounded. Both outputs must be on HIGH state.
VXY(R)	Address Input Threshold to Insure Reading	2.0		V*	$V_{CC} = 5.0\text{V}$ , other X and Y grounded. Alternately pulse $W_0$ and $W_1$ , cell state must alternate.
VW(W)	Write Input Threshold to Prevent Writing		1.0	V*	$V_{CC} = 5.0\text{V}$ , one X and one Y to 4.5 V, other X and Y grounded. One write input to $V_{W(W)}$ , pulse the other write input. If $W_0$ is pulsed, $S_0$ will assume LOW state. If $W_1$ is pulsed, $S_1$ will assume LOW state.
VW(W)	Write Input Threshold to Insure Writing	2.0		V*	$V_{CC} = 5.0\text{V}$ , one X and one Y to 4.5 V, other X and Y grounded. One write input to $V_{W(W)}$ , pulse the other write input. If $W_0$ is pulsed, $S_0$ will assume LOW state. If $W_1$ is pulsed, $S_1$ will assume LOW state.

\*Amplitude of the pulse  $\geq 2.5\text{V}$ , pulse width  $\geq 100\text{ns}$ . The cell state is determined 35 ns after pulse disappears.

\*\*X = package type; F for Flatpak, D for Ceramic Dip. See Packaging Information Section for packages available on this product.

**TTL LOADING RULES**

	HIGH LEVEL	LOW LEVEL
Address Input	6.5 U.L.	6.5 U.L.
Write Input	1.5 U.L.	0.9 U.L.
Sense Output	Open Collector	IND A grade = 25 U.L. MIL or IND B grade = 12.5 U.L.

1 Unit Load (U.L.) = 60  $\mu\text{A}$  HIGH/1.6 mA LOW

TYPICAL ELECTRICAL CHARACTERISTICS

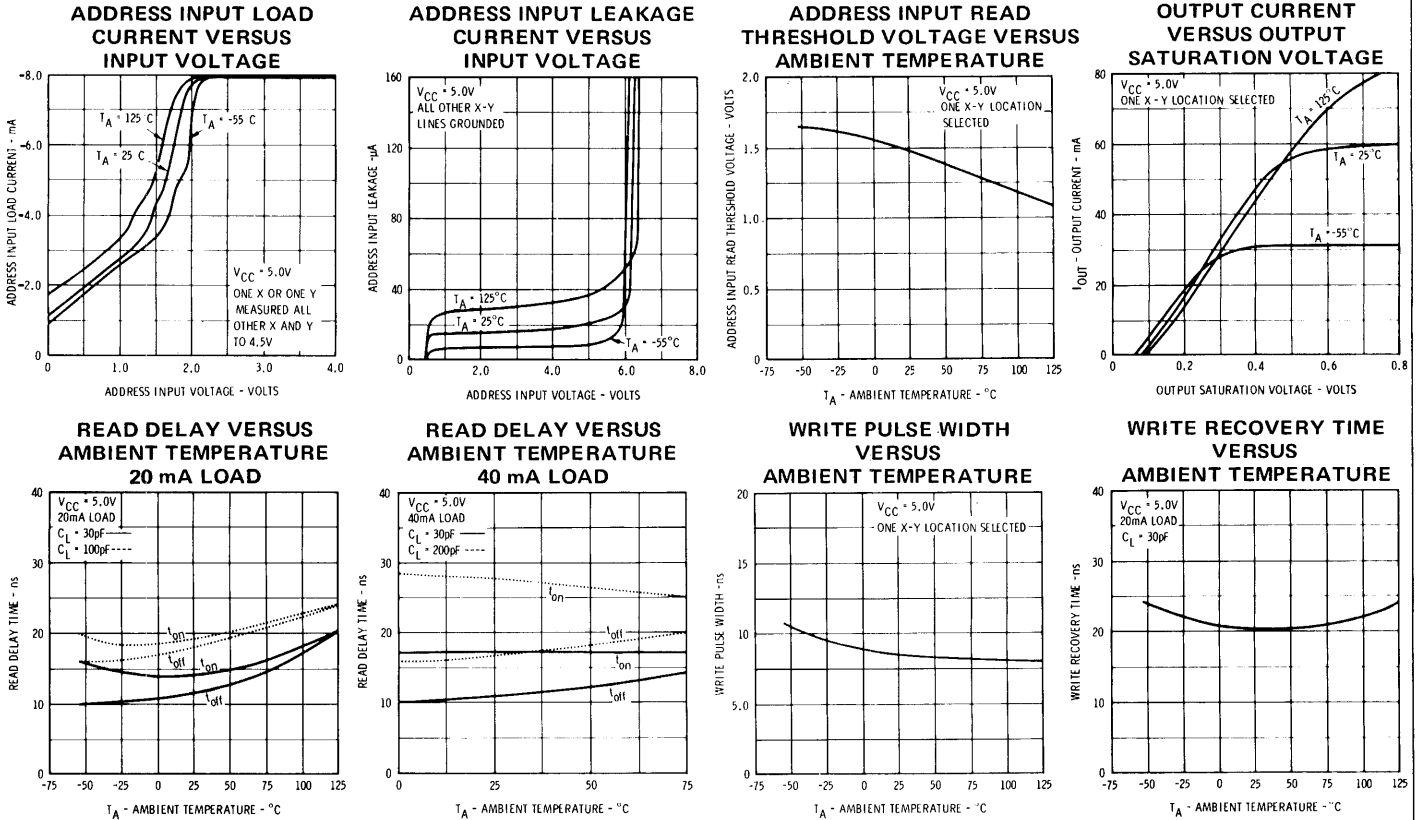

SWITCHING TIME TEST CIRCUIT AND WAVEFORMS

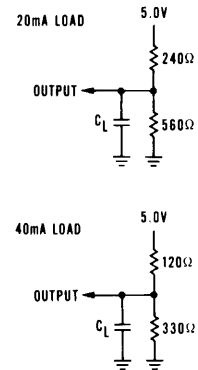
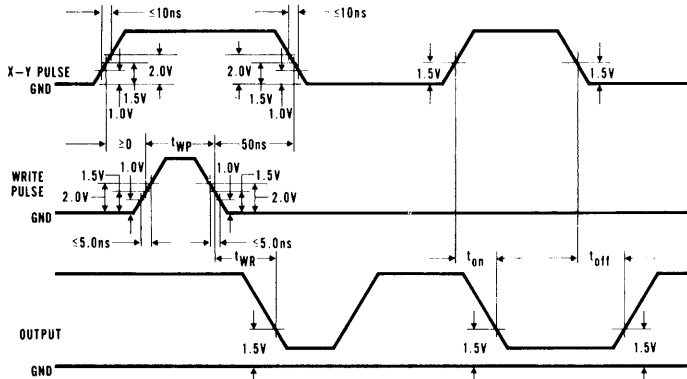

SWITCHING CHARACTERISTICS ( $T_A = 25^\circ\text{C}$ ,  $V_{CC} = 5.0\text{V}$ , One X-Y Location Selected.)

SYMBOL	PARAMETER	MIL B GRADE		IND A GRADE		IND B GRADE		UNITS	CONDITIONS	
		MIN.	MAX.	MIN.	MAX.	MIN.	MAX.		LOAD (mA)	$C_L$ (pF)
$t_{WP}$	Write Pulse Width		25	25			25	ns	40	
$t_{WR}$	Write Recovery Time		40	35		35		ns	40	30
$t_{on}$	Turn On Delay		25	20		20		ns	40	30
			35	30		30		ns	20	100
$t_{off}$	Turn Off Read Delay		25	20		20		ns	40	30
			35	30		30		ns	20	100

**APPLICATION:**

A memory utilizing these memory cells may have any desired word length. The number of words in the memory is a multiple of four words. The following example of a 64 word memory illustrates how a number of 16-bit memory cells may be used to construct a typical memory.

The 64 word memory as shown in Figure A consists of groups of four memory cells. Each of the groups of four memory cells supplies one bit for each of the 64 words stored in the memory. All bits belonging to one word are stored in the same address location. Therefore, the address of a word in the memory is the address of each bit of the addressed word in the groups of four memory cells. The equal outputs of the four memory cells are tied together so that each group of four memory cells has one HIGH and one LOW level output.

The six memory address lines from an external source are decoded at the first level with two 9301 decoders. The fourth input to each of the two decoders can be used as an enable control input to the 64 word memory. If the address enable is at a LOW logic level, one and only one of the eight outputs, 0 to 7, in the illustration assumes a LOW logic level. If the address enable is at a HIGH logic level, the outputs 0 to 7 of the two decoders assume a HIGH logic level, thus none of the 64 words stored in the memory is addressed. The outputs, 0 to 7, of the two decoders serve as X-and-Y address lines. The output signals of the decoders are connected to driving transistors which provide the necessary current to address the memory cells.

The example given above is only one of the many organizations and is presented as an illustration. Obviously many address decoding schemes may be utilized depending on memory size, driver fan out, decoder fan out, wiring, heat dissipation, etc.

Figures B through D show alternative schemes to enter data into the memory cell.

**64 WORD MEMORY**  
Fig. A

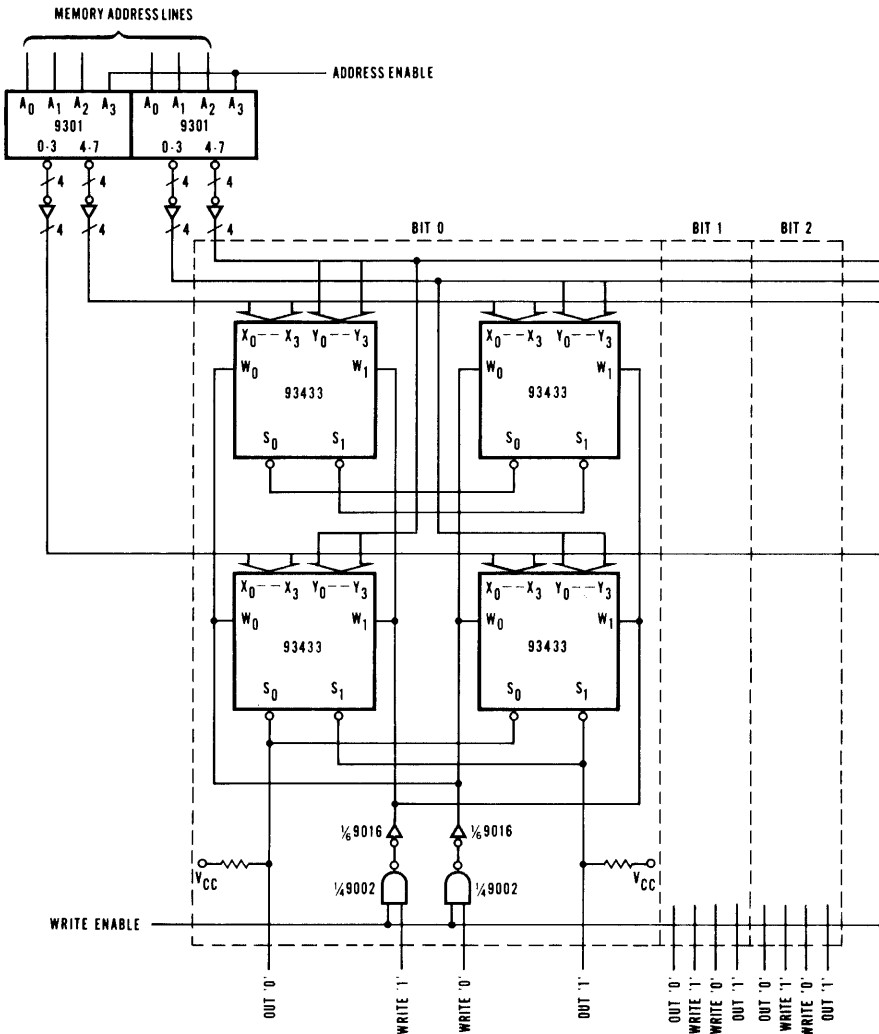

**Fig. B**  
DOUBLE RAIL ACTIVE  
LOW INPUTS AND ENABLE

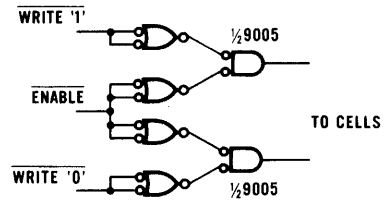

**Fig. C**  
SINGLE RAIL ACTIVE  
HIGH INPUT AND ENABLE

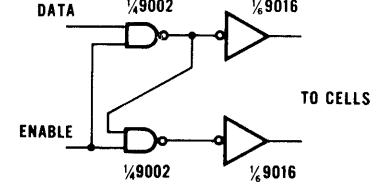

**Fig. D**  
SINGLE RAIL ACTIVE  
LOW INPUT AND ENABLE

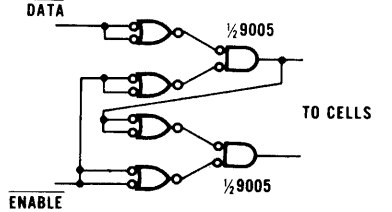

# TTL ISOPLANAR MEMORY 93410 • 93410A

## 256-BIT FULLY DECODED RANDOM ACCESS MEMORY

**DESCRIPTION** — The 93410 and 93410A are high speed 256 Bit TTL Random Access Memories with full decoding on chip. Each memory, organized as 256 words x 1 bit, is designed for scratch pad, buffer and distributed main memory applications. Both devices have three chip select lines to simplify their use in larger memory systems. Address input pin locations are specifically chosen to permit maximum packaging density and for ease of PC board layout. An uncommitted collector output is provided to permit "OR-ties" for ease of memory expansion.

The 93410A is a high speed version of the 93410, offering a 35 ns access time.

- ORGANIZATION - 256 WORDS X 1 BIT
- THREE HIGH SPEED CHIP SELECT INPUTS
- TYPICAL ACCESS TIME
 

93410A	Commercial	35 ns
93410	Commercial	45 ns
93410	Military	45 ns
- NON INVERTED DATA OUTPUT
- ON CHIP DECODING
- POWER DISSIPATION - 1.8 mW/BIT
- POWER DISSIPATION DECREASES WITH TEMPERATURE

### PIN NAMES

$\overline{CS}_1$ $\overline{CS}_2$ $CS_3$	Chip Select Input
A <sub>0</sub> thru A <sub>7</sub>	Address Inputs
D <sub>IN</sub>	Data Input
D <sub>OUT</sub>	Data Output
$\overline{WE}$	Write Enable

### LOADING

(Notes a & b)

0.5 U.L.
0.5 U.L.
0.5 U.L.
10 U.L.
0.5 U.L.

### NOTES:

- 1 Unit Load (U.L.) = 40μA HIGH/1.6 mA LOW
- 10 U.L. is the output LOW drive factor. An external pull up resistor is needed to provide HIGH level drive capability. This output will sink a maximum of 16 mA at V<sub>out</sub> = 0.45 V.

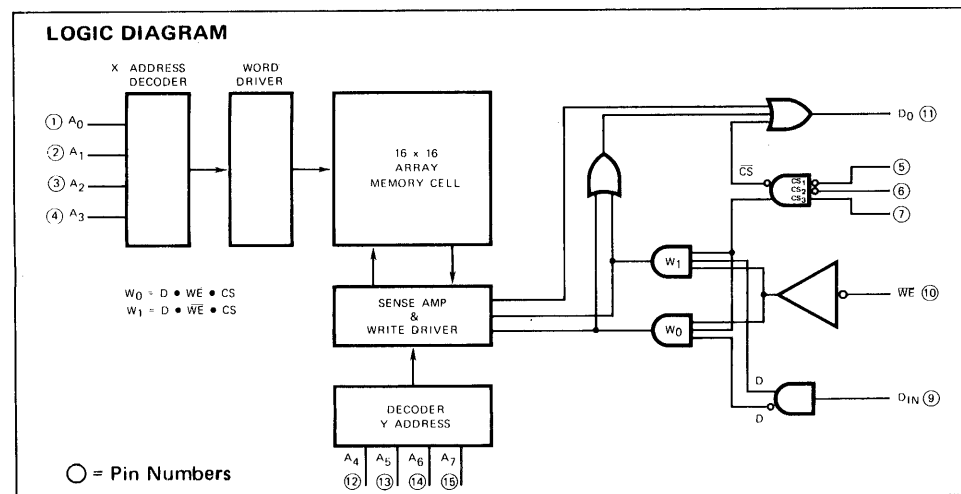
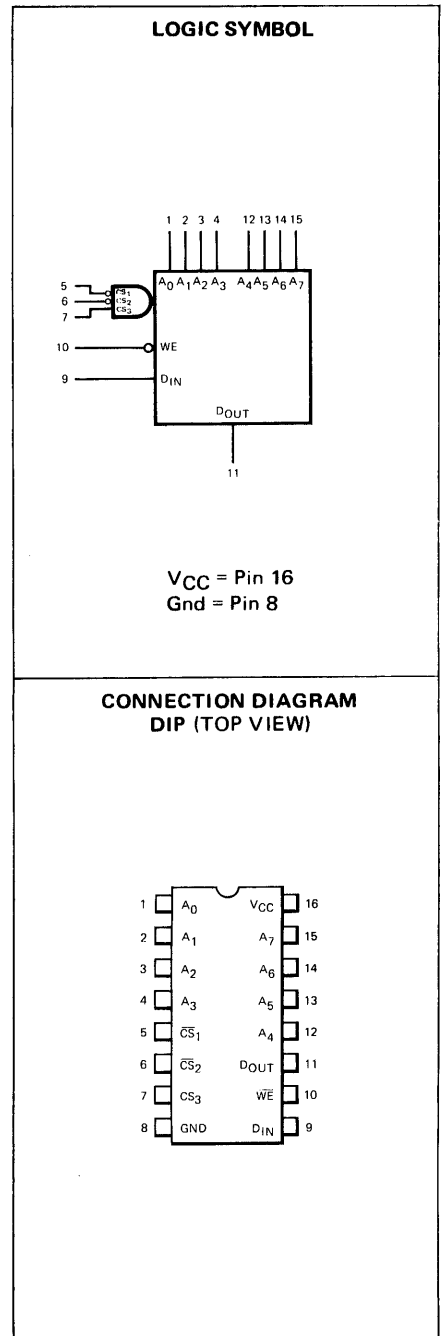

# FAIRCHILD ISOPLANAR TTL MEMORY • 93410 • 93410A

## FUNCTIONAL DESCRIPTION

The 93410 and 93410A are fully decoded 256-bit Random Access Memories organized 256 words by 1 bit. Bit selection is achieved by means of an 8-bit address, A<sub>0</sub> thru A<sub>7</sub>.

Three chip select inputs are provided, two are active LOW ( $\overline{CS}_1$  and  $\overline{CS}_2$ ) and the third active HIGH ( $CS_3$ ) for maximum logic flexibility. This permits memory array expansion up to 2048 words without the need for additional external decoders. For larger memories the fast chip select access time permits the decoding of chip select, CS, from the address without increasing address access time.

The read and write operations are controlled by the state of the active LOW Write Enable  $\overline{WE}$  (pin 10). With  $\overline{WE}$  held LOW and the chip selected, the data at D<sub>IN</sub> is written into the addressed location. To read,  $\overline{WE}$  is held HIGH and the chip selected. Data in the specified location is presented at D<sub>OUT</sub> and is non-inverted.

Uncommitted collector outputs are provided to allow maximum flexibility in output connection. In many applications such as memory expansion, the outputs of many 93410s or 93410As can be tied together. In other applications the wired-OR is not used. In either case an external pull up resistor of value R<sub>L</sub> must be used to provide a HIGH at the output when it is off. Any value of R<sub>L</sub> within the range specified below may be used.

$$\frac{V_{CC} \text{ (MAX)}}{16 - \text{F.O. (1.6)}} \leq R_L \leq \frac{V_{CC} \text{ (MIN)} - V_{OH}}{N (I_{CEX}) + \text{F.O. (0.04)}}$$

R<sub>L</sub> is in kΩ

N = number of wired-OR outputs tied together

F.O. = number of TTL Unit Loads (U.L.) driven

I<sub>CEX</sub> = Memory Output Leakage Current in mA

V<sub>OH</sub> = Required Output HIGH level at Output Node

The minimum value of R<sub>L</sub> is limited by output current sinking ability. The maximum value of R<sub>L</sub> is determined by the output and input leakage current which must be supplied to hold the output at V<sub>OH</sub>.

**TABLE I – TRUTH TABLE**

INPUTS			OUTPUT			MODE
CS			$\overline{WE}$	DI	DO	
PIN 5	PIN 6	PIN 7				
H	X	X	X	X	H	Not Selected
X	H	X	X	X	H	Not Selected
X	X	L	X	X	H	Not Selected
L	L	H	L	L	H	Write "0"
L	L	H	L	H	H	Write "1"
L	L	H	H	X	DO	Read data from addressed location

H = HIGH Voltage

L = LOW Voltage

X = Don't Care (HIGH or LOW)

**ABSOLUTE MAXIMUM RATINGS** (above which the useful life may be impaired)

Storage Temperature	-65°C to +150°C
Temperature (Ambient) Under Bias	-55°C to +125°C
V <sub>CC</sub> Pin Potential to Ground Pin	-0.5 V to +7.0 V
*Input Voltage (dc)	-0.5 V to +5.5 V
*Input Current (dc)	-12 mA to +5.0 mA
**Voltage Applied to Outputs (output HIGH)	0.5 V to +5.50 V
Output Current (dc) (Output LOW)	+20 mA

\*Either Input Voltage limit or Input Current limit is sufficient to protect the inputs.

\*\*Output Current Limit Required.

**GUARANTEED OPERATING RANGES**

PART NUMBER	SUPPLY VOLTAGE (V <sub>CC</sub> )			AMBIENT TEMPERATURE <sup>4</sup>
	MIN.	TYP.	MAX.	
93410XC, 93410AXC	4.75 V	5.0 V	5.25 V	0°C to 75°C
93410XM	4.75 V	5.0 V	5.25 V	-55°C to +125°C

X = package type; F for Flatpak, D for Ceramic Dip, P for Plastic Dip. See Packaging Information Section for packages available on this product.

FAIRCHILD ISOPLANAR TTL MEMORY • 93410 • 93410A

ELECTRICAL CHARACTERISTICS OVER OPERATING TEMPERATURE RANGE<sup>1</sup> (unless otherwise noted)

SYMBOL	PARAMETER	LIMITS <sup>2</sup>			UNITS	CONDITIONS		
		MIN.	TYP. <sup>3</sup>	MAX.				
V <sub>OL</sub>	Output LOW Voltage		0.3	0.45	V	V <sub>CC</sub> = MIN I <sub>OL</sub> = 16 mA		
V <sub>IH</sub>	Input HIGH Voltage	2.0	1.6		V	Guaranteed input logical HIGH voltage for all inputs		
V <sub>IL</sub>	Input LOW Voltage		1.5	0.85	V	Guaranteed input logical LOW voltage for all inputs		
I <sub>IL</sub>	Input LOW Current		-530	-800	μA	V <sub>CC</sub> = MAX., V <sub>IN</sub> = 0 V		
I <sub>IH</sub>	Input HIGH Current		1.0	20	μA	V <sub>CC</sub> = MAX., V <sub>IN</sub> = 4.5 V		
I <sub>CEX</sub>	Output Leakage Current		1.0	50	μA	V <sub>CC</sub> = MAX., V <sub>OUT</sub> = 4.5 V		
V <sub>CD</sub>	Input Clamp Diode Voltage		-1.0	-1.5	V	V <sub>CC</sub> = MAX., I <sub>IN</sub> = -10 mA		
I <sub>CC</sub>	Power Supply Current	93410XC		90	135	mA	T <sub>A</sub> ≥ 25°C	V <sub>CC</sub> = MAX. All inputs grounded See Power Supply vs Temp. Curve
				100	140		T <sub>A</sub> < 25°C	
		93410XM		90	135		T <sub>A</sub> ≥ 25°C	
				100	145		T <sub>A</sub> < 25°C	

SWITCHING CHARACTERISTICS OVER OPERATING TEMPERATURE RANGE

SYMBOL	PARAMETER	93410AXC			93410XC			93410XM			UNITS	CONDITIONS
		MIN.	TYP.	MAX.	MIN.	TYP.	MAX.	MIN.	TYP.	MAX.		
READ MODE	DELAY TIMES											
t <sub>ACS</sub>	Chip Select Access Time		20	24		25	30		25	40	ns	See Test Circuit 5
t <sub>RCS</sub>	Chip Select Recovery Time		20	25		25	32		25	40	ns	
t <sub>AA</sub>	Address Access Time		35	45		45	60		45	70	ns	
WRITE MODE	DELAY TIMES											
t <sub>WS</sub>	Write Disable Time	10	20	35	10	20	40	10	20	50	ns	
t <sub>WR</sub>	Write Recovery Time		25	35		25	40		25	50	ns	
	INPUT TIMING REQUIREMENTS											
t <sub>w</sub>	Minimum Write Pulse Width	30	20		30	25		40	25		ns	See Test Circuit
t <sub>WSD</sub>	Data Set-up Time Prior to Write	5	0		5	0		5	0		ns	
t <sub>WHD</sub>	Data Hold Time After Write	5	0		5	0		5	0		ns	
t <sub>WSA</sub>	Address Set-up Time	5	0		5	0		5	0		ns	
t <sub>WSCS</sub>	Chip Select Set-up Time	5	0		5	0		5	0		ns	
t <sub>WHCS</sub>	Chip Select Hold Time	5	0		5	0		5	0		ns	
C <sub>IN</sub>	Input Pin Capacitance			4.0			4.0			4.0	pF	Measured with a pulse technique
C <sub>OUT</sub>	Output Pin Capacitance			8.0			8.0			8.0	pF	

NOTES:

- Conditions for testing, not shown in the table, are chosen to guarantee operation under "worst case" conditions.
- The specified LIMITS represent the "worst case" value for the parameter. Since these "worst case" values normally occur at the temperature and supply voltage extremes, additional noise immunity and guard banding can be achieved by decreasing the allowable system operating ranges.
- Typical limits are at V<sub>CC</sub> = 5.0 V, 25°C, and max. loading.
- Guaranteed with transverse airflow exceeding 400 linear F.P.M. and 2 minute warm up.  
Typical thermal resistance values of the package are:  
θ<sub>JA</sub> (Junction to Ambient) = 50°C/W (at 400 F.P.M. Airflow)  
θ<sub>JA</sub> (Junction to Ambient) = 90°C/W (Still Air)  
θ<sub>JL</sub> (Junction to Case) = 25°C/W  
The -55°C Operating Temperature relates to a -30°C worst case cold Junction Temperature.
- The maximum address access time is guaranteed to be the worst case bit in the memory using a pseudo random testing pattern.

93410 AC TEST LOAD AND WAVEFORM

LOADING CONDITION

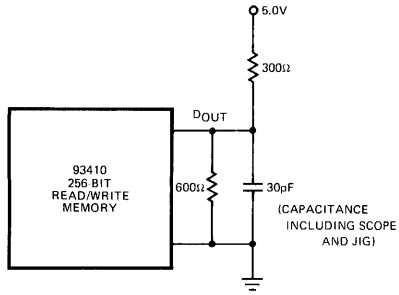

INPUT PULSES

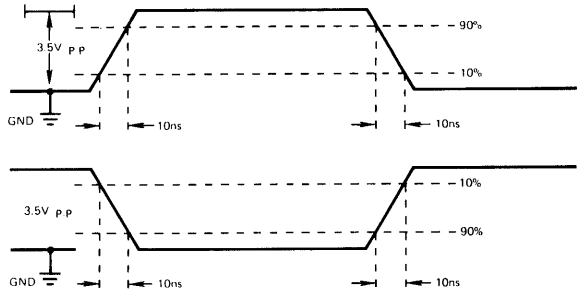

(ALL TIME MEASUREMENTS REFERENCED TO 1.5 V)

SWITCHING WAVEFORMS

READ MODE

PROPAGATION DELAY FROM CHIP SELECT

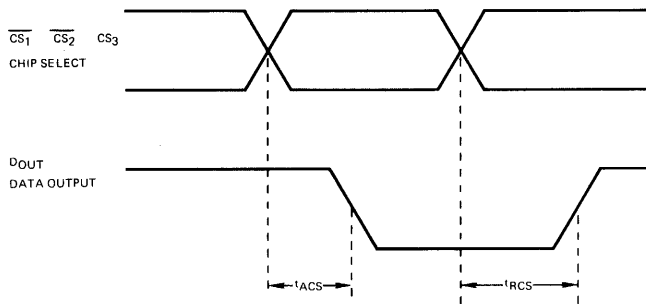

PROPAGATION DELAY FROM ADDRESS

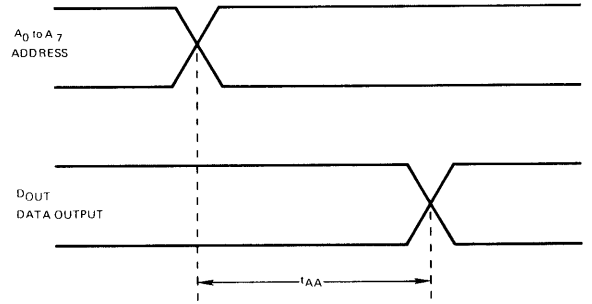

WRITE MODE

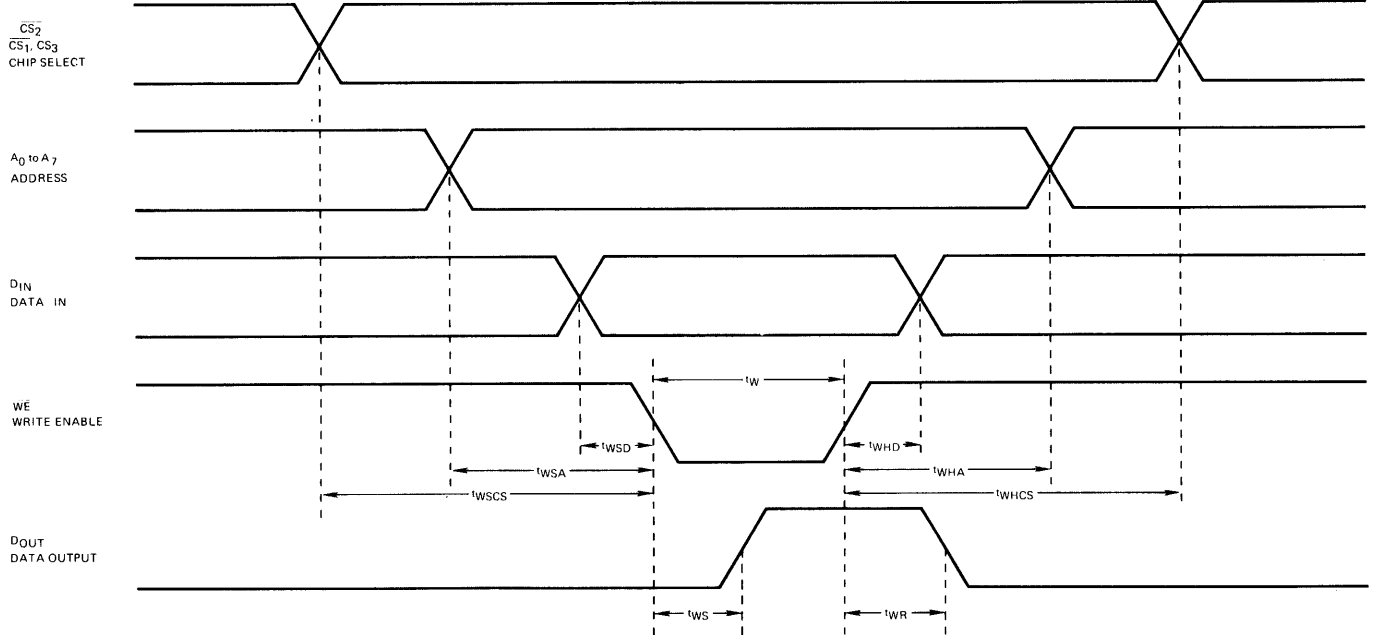

TYPICAL ELECTRICAL CHARACTERISTICS

OUTPUT CURRENT VERSUS OUTPUT VOLTAGE (OUTPUT HIGH)

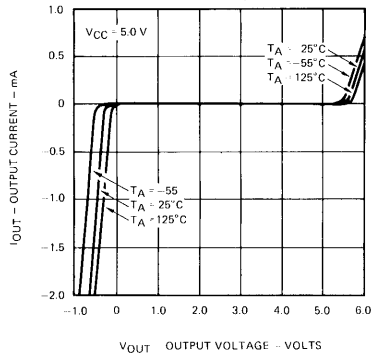

OUTPUT CURRENT VERSUS OUTPUT VOLTAGE (OUTPUT LOW)

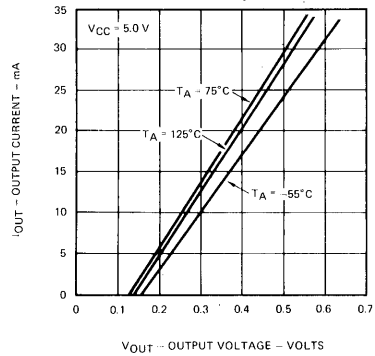

POWER SUPPLY CURRENT VERSUS TEMPERATURE

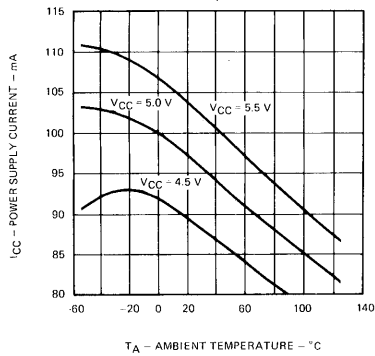

NORMALIZED ADDRESS ACCESS TIME VERSUS LOAD CAPACITANCE

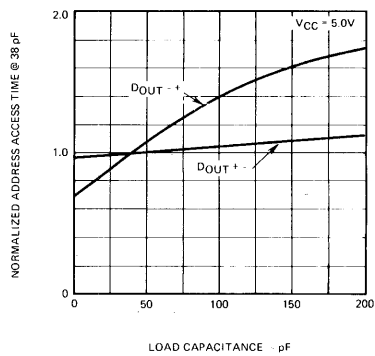

INPUT CURRENT VERSUS INPUT VOLTAGE VERSUS TEMPERATURE

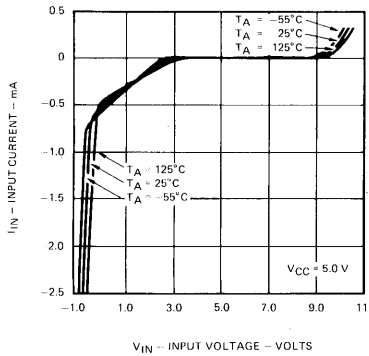

INPUT CURRENT VERSUS INPUT VOLTAGE VERSUS SUPPLY VOLTAGE

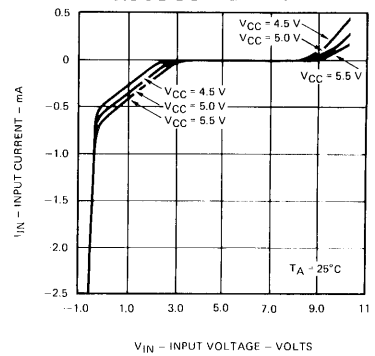



# TTL ISOPLANAR MEMORY 93415

## 1024-BIT FULLY DECODED RANDOM ACCESS MEMORY

**DESCRIPTION** — The 93415 is a 1024-Bit Read/Write Random Access Memory organized 1024 words x 1-bit. It has a typical access time of 60 ns and is designed for buffer and control storage and high performance main memory applications.

The 93415 includes full decoding on the chip, has separate data input and data output lines and an active LOW chip select line.

The device is fully compatible with standard DTL and TTL logic families and has an uncommitted collector output for ease of memory expansion.

- NON-INVERTING DATA OUTPUTS
- ORGANIZED 1024 WORDS X 1-BIT
- READ ACCESS TIME 60 ns TYP.
- CHIP SELECT ACCESS TIME 30 ns TYP.
- POWER DISSIPATION 0.5 mW/BIT TYP.
- INPUT LOADING 0.25 TTL UNIT LOADS
- UNCOMMITTED COLLECTOR OUTPUT
- POWER DISSIPATION DECREASES WITH INCREASING TEMPERATURE
- TTL COMPATIBLE

### PIN NAMES

$\overline{CS}$	Chip Select
A <sub>0</sub> to A <sub>9</sub>	Address Inputs
$\overline{WE}$	Write Enable
D <sub>IN</sub>	Data Input
D <sub>OUT</sub>	Data Output

### LOADING

0.25 U.L.
0.25 U.L.
0.25 U.L.
0.25 U.L.
10 U.L.

1 Unit Load (U.L.) = 40  $\mu$ A HIGH/1.6 mA LOW

### LOGIC SYMBOL

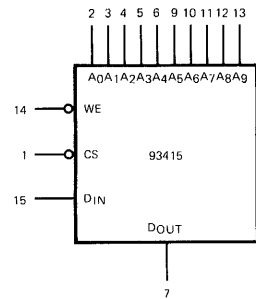

V<sub>CC</sub> = PIN 16  
GND = PIN 8

### CONNECTION DIAGRAM DIP (TOP VIEW)

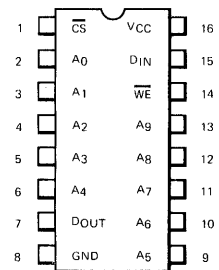

### LOGIC DIAGRAM

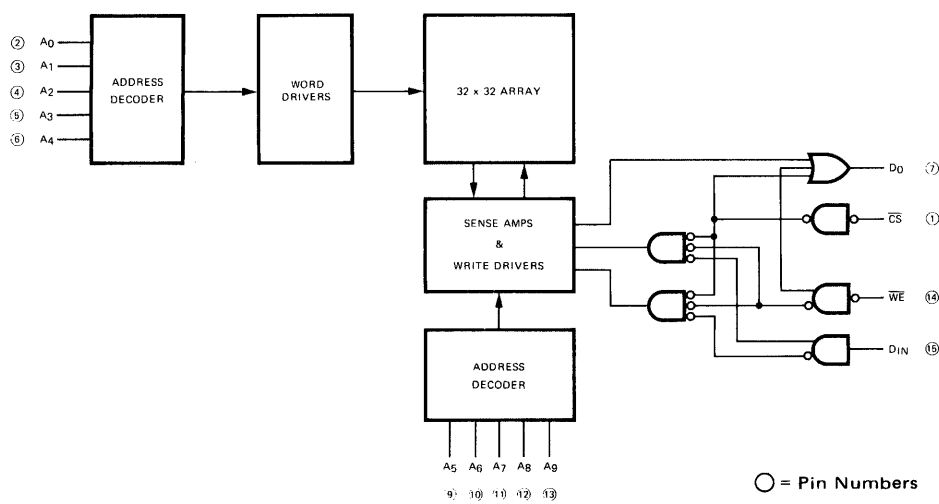

# FAIRCHILD ISOPLANAR TTL MEMORY • 93415

**FUNCTIONAL DESCRIPTION** — The 93415 is a fully decoded 1024-bit Random Access Memory organized 1024 words by 1-bit. Bit selection is achieved by means of a 10-bit address  $A_0$  to  $A_9$ .

One chip select input is provided for memory array expansion with the need for one additional external decoder. For larger memories the fast chip select access time permits the decoding of chip select,  $\overline{CS}$ , from the address without affecting system performance.

The read and write operations are controlled by the state of the active LOW Write Enable  $\overline{WE}$  (pin 14). With  $\overline{WE}$  held LOW and the chip selected, the data at  $D_{IN}$  is written into the addressed location. To read,  $\overline{WE}$  is held HIGH and the chip selected. Data in the specified location is presented at  $D_{OUT}$  and is non-inverted.

Uncommitted collector outputs are provided on the 93415 to allow maximum flexibility in output connection. In many applications such as memory expansion, the outputs of many 93415 can be tied together. In other applications the wired-OR is not used. In either case an external pull up resistor of value  $R_L$  must be used to provide a HIGH at the output when it is off. Any value of  $R_L$  within the range specified below may be used.

$$\frac{V_{CC}(\text{min})}{I_{OL} - \text{F.O.}(1.6)} \leq R_L \leq \frac{V_{CC}(\text{min}) - V_{OH}}{N(I_{CEX}) + \text{F.O.}(0.04)}$$

$R_L$  is in  $k\Omega$

$N$  = number of wired-OR outputs tied together

F.O. = number of TTL Unit Loads (U.L.) driven

$I_{CEX}$  = Memory Output Leakage Current

$V_{OH}$  = Required Output HIGH Level at Output Node

$I_{OL}$  = Output LOW Current

The minimum value of  $R_L$  is limited by output current sinking ability. The maximum value of  $R_L$  is determined by the output and input leakage current which must be supplied to hold the output at  $V_{OH}$ .

**TABLE I — TRUTH TABLE**

INPUTS			OUTPUT	MODE
$\overline{CS}$	$\overline{WE}$	$D_I$	Open Collector	
H	X	X	H	NOT SELECTED WRITE "0" WRITE "1" READ
L	L	L	H	
L	L	H	H	
L	H	X	$D_0$	

H = HIGH Voltage

L = LOW Voltage

X = Don't Care (HIGH or LOW)

## TYPICAL INPUT AND OUTPUT CHARACTERISTICS

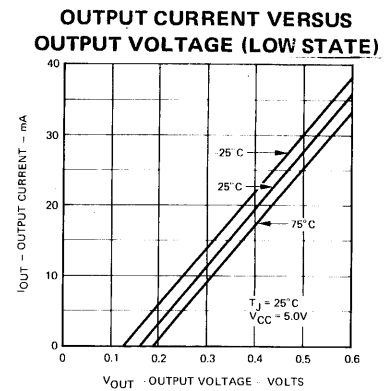
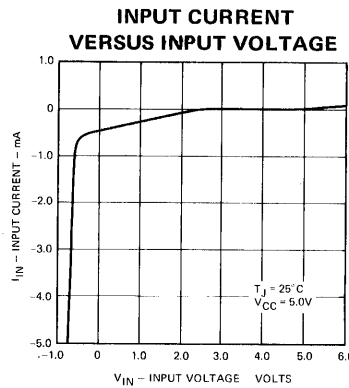

### ABSOLUTE MAXIMUM RATINGS (above which the useful life may be impaired)

Storage Temperature

Temperature (Ambient) Under Bias

$V_{CC}$  Pin Potential to Ground Pin

\*Input Voltage (dc)

\*Input Current (dc)

Voltage Applied to Outputs (Output HIGH)

Output Current (dc) (Output LOW)

-65°C to +150°C

0°C to +75°C

-0.5V to +7.0V

-0.5V to +5.5V

-12 mA to +5.0 mA

0.5 V to +4.50V

+20 mA

\*Either input voltage or input current limit is sufficient to protect the input.

### GUARANTEED OPERATING RANGES

PART NUMBER	SUPPLY VOLTAGE ( $V_{CC}$ )			AMBIENT TEMPERATURE (Note 4)
	.MIN.	TYP.	MAX.	
93415XC	4.75 V	5.0 V	5.25 V	0°C to 75°C

X = package type; F for Flatpak, D for Ceramic Dip, P for Plastic Dip. See Packaging Information Section for packages available on this product.

# FAIRCHILD ISOPLANAR TTL MEMORY • 93415

## TO BE ANNOUNCED

### ELECTRICAL CHARACTERISTICS OVER OPERATING TEMPERATURE RANGE (unless otherwise noted)

SYMBOL	CHARACTERISTIC	LIMITS			UNITS	CONDITIONS
		MIN.	TYP. (Note 3)	MAX.		
V <sub>OL</sub>	Output LOW Voltage		0.3	0.45	Volts	V <sub>CC</sub> = MIN., I <sub>OL</sub> = 16 mA
V <sub>IH</sub>	Input HIGH Voltage	2.1	1.6		Volts	Guaranteed Input HIGH Voltage for all Inputs
V <sub>IL</sub>	Input LOW Voltage		1.5	0.8	Volts	Guaranteed Input LOW Voltage for all Inputs
I <sub>IL</sub>	Input LOW Current		-250	-400	μA	V <sub>CC</sub> = MAX., V <sub>IN</sub> = 0.4 V
I <sub>IH</sub>	Input HIGH Current		1.0	20	μA	V <sub>CC</sub> = MAX., V <sub>IN</sub> = 4.5 V
				1.0	mA	V <sub>CC</sub> = MAX., V <sub>IN</sub> = 5.25 V
I <sub>CEX</sub>	Output Leakage Current		1.0	50	μA	V <sub>CC</sub> = MAX., V <sub>OUT</sub> = 4.5 V
V <sub>CD</sub>	Input Diode Clamp Voltage		-1.0	-1.5	Volts	V <sub>CC</sub> = MAX., I <sub>IN</sub> = -10 mA
I <sub>CC</sub>	Power Supply Current		90	130	mA	T <sub>A</sub> ≥ 25°C
			110	150	mA	T <sub>A</sub> < 25°C

#### NOTES:

- Conditions for testing, not shown in the Table, are chosen to guarantee operation under "worst case" conditions.
  - The specified LIMITS represents the "worst case" value for the parameters. Since these "worst case" values normally occur at the temperature and supply voltage extremes, additional noise immunity and guard banding can be achieved by decreasing the allowable system operating ranges.
  - Typical limits are at V<sub>CC</sub> = 5.0 V, 25°C, and max. loading.
  - The Operating Ambient Temperature Ranges are guaranteed with transverse air flow exceeding 400 linear feet per minute and a two minute warm-up. Typical thermal resistance values of the package are:
    - θ<sub>JA</sub> (Junction to Ambient) = 50°C/Watt (at 400 fpm air flow)
    - θ<sub>JA</sub> (Junction to Ambient) = 90°C/Watt (still air)
    - θ<sub>JC</sub> (Junction to Case) = 25°C/Watt
- The 100°C Operating Temperature relates to a "worst case" junction temperature of 125°C.
- The maximum address access time is guaranteed to be the "worst case" bit in the memory using a pseudo random testing pattern.

### SWITCHING CHARACTERISTICS – OVER OPERATING TEMPERATURE AND VOLTAGE RANGES

SYMBOL	CHARACTERISTIC	MIN.	TYP.	MAX.	UNITS	CONDITIONS
<b>READ MODE</b>						
<b>DELAY TIMES</b>						
t <sub>ACS</sub>	Chip Select Access Time		30	55	ns	See Test Circuit and Waveforms on page 9-30 (Note 5)
t <sub>RCS</sub>	Chip Select Recovery Time		30	55		
t <sub>AA</sub>	Address Access Time		60	90		
<b>WRITE MODE</b>						
<b>DELAY TIMES</b>						
t <sub>WS</sub>	Write Disable Time		35	45	ns	See Test Circuit and Waveforms on page 9-30
t <sub>WR</sub>	Write Recovery Time		45	65		
<b>INPUT TIMING REQUIREMENTS</b>						
t <sub>w</sub>	Minimum Write Pulse Width		30	55	ns	
t <sub>WSD</sub>	Data Set-Up Time Prior to Write		0	5		
t <sub>WHD</sub>	Data Hold Time After Write		0	5		
t <sub>WSA</sub>	Address Set-Up Time		20	35		
t <sub>WHA</sub>	Address Hold Time		0	5		
t <sub>WSCS</sub>	Chip Select Set-Up Time		0	5		
t <sub>WHCS</sub>	Chip Select Hold Time		0	5		
C <sub>IN</sub>	Input Pin Capacitance		4	5		
C <sub>OUT</sub>	Output Pin Capacitance		7	8		

# TTL MEMORY 93434

## 256-BIT READ-ONLY MEMORY

FORMERLY 9034

**DESCRIPTION** — The Fairchild 93434 is a 256-Bit bipolar TTL Read-Only Memory. The memory is organized as 32 words of eight bits each. The words are selected through five address lines. The eight outputs of the words are uncommitted collectors which may be wired-OR with the outputs of other ROMs. An Enable input is provided for additional decoding flexibility. A HIGH on the Enable input forces all outputs to be HIGH.

The contents of the memory are permanently programmed to customer order. A customer order form is available on request.

- TTL COMPATIBLE
- OUTPUT WIRED-OR CAPABILITY
- SINGLE TTL LOAD INPUTS
- INPUT CLAMP DIODES

### ABSOLUTE MAXIMUM RATINGS

Storage Temperature	-65°C to +150°C
Temperature (Ambient) Under Bias	-55°C to +125°C
V <sub>CC</sub> Pin Potential to Ground	-0.5V to +8.0V
Input Pin Voltage	-1.5V to 5.5V
Current Into Output Terminal	100 mA
Output Voltages	-0.5 V to V <sub>CC</sub> Value

### LOGIC SYMBOL

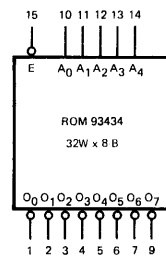

V<sub>CC</sub> = PIN 16  
GND = PIN 8

### CONNECTION DIAGRAMS DIP (TOP VIEW)

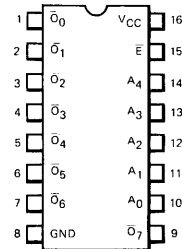

### FLATPAK (TOP VIEW)

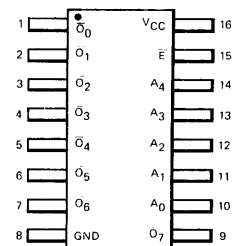

### LOGIC DIAGRAM

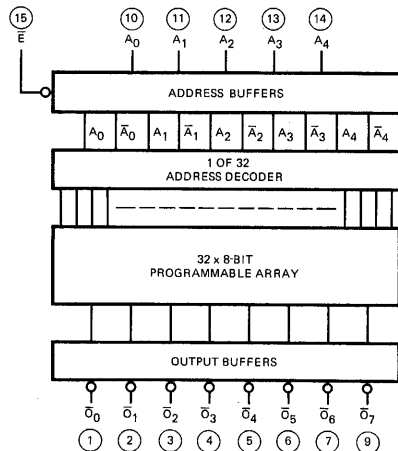

## FAIRCHILD TTL MEMORY • 93434

### ELECTRICAL CHARACTERISTICS ( $T_A = -55^\circ\text{C}$ to $+125^\circ\text{C}$ , $V_{CC} = 5.0\text{ V} \pm 10\%$ ) (units are pulse tested) (Part No. 93434XM)\*

SYMBOL	PARAMETER	LIMITS						UNITS	TEST CONDITIONS
		$-55^\circ\text{C}$		$+25^\circ\text{C}$		$+125^\circ\text{C}$			
		MIN.	MAX.	MIN.	MAX.	MIN.	MAX.		
$I_{FA}$	Address Input Load Current		-1.6		-1.6		-1.6	mA	$V_{CC} = 5.5\text{ V}$ $V_A = 0.4\text{ V}$
$I_{FE}$	Enable Input Load Current		-1.6		-1.6		-1.6	mA	$V_{CC} = 5.5\text{ V}$ $V_E = 0.4\text{ V}$
$I_{RA}$	Address Input Leakage Current		100		100		100	$\mu\text{A}$	$V_{CC} = 5.5\text{ V}$ $V_A = 4.5\text{ V}$
$I_{RE}$	Enable Input Leakage Current		100		100		100	$\mu\text{A}$	$V_{CC} = 5.5\text{ V}$ $V_E = 4.5\text{ V}$
$I_{CEX}$	Output Leakage Current		200		200		200	$\mu\text{A}$	$V_{CC} = 5.5\text{ V}$ $V_{CEX} = 5.5\text{ V}$ Enable input to 2.0V
$V_{OL}$	Output LOW Voltage		0.4		0.4		0.4	V	$V_{CC} = 4.5\text{ V}$ $I_{OUT} = 10\text{ mA}$ The word containing a "0" bit is selected when performing this test.
$V_{IL}$	Input LOW Voltage		0.8		0.9		0.8	V	$V_{CC} = 5.5\text{ V}$ Enable input grounded. Monitor appropriate output to guarantee this test.
$V_{IH}$	Input HIGH Voltage	2.0		1.7		1.4		V	$V_{CC} = 4.5\text{ V}$ Enable input grounded. Monitor appropriate output to guarantee this test.
$I_{CC}$	Power Supply Current		80		80		80	mA	$V_{CC} = 5.5\text{ V}$ All inputs grounded

### ELECTRICAL CHARACTERISTICS ( $T_A = 0^\circ\text{C}$ to $+75^\circ\text{C}$ , $V_{CC} = 5.0\text{ V} \pm 5\%$ ) (units are pulse tested) (Part No. 93434XC)\*

SYMBOL	PARAMETER	LIMITS						UNITS	TEST CONDITIONS
		$0^\circ\text{C}$		$+25^\circ\text{C}$		$+75^\circ\text{C}$			
		MIN.	MAX.	MIN.	MAX.	MIN.	MAX.		
$I_{FA}$	Address Input Load Current		-1.6		-1.6		-1.6	mA	$V_{CC} = 5.25\text{ V}$ $V_A = 0.45\text{ V}$
$I_{FE}$	Enable Input Load Current		-1.6		-1.6		-1.6	mA	$V_{CC} = 5.25\text{ V}$ $V_E = 0.45\text{ V}$
$I_{RA}$	Address Input Leakage Current		100		100		100	$\mu\text{A}$	$V_{CC} = 5.25\text{ V}$ $V_A = 4.5\text{ V}$
$I_{RE}$	Enable Input Leakage Current		100		100		100	$\mu\text{A}$	$V_{CC} = 5.25\text{ V}$ $V_E = 4.5\text{ V}$
$I_{CEX}$	Output Leakage Current		200		200		200	$\mu\text{A}$	$V_{CC} = 5.25\text{ V}$ $V_{CEX} = 5.25\text{ V}$ Enable input to 2.0 V
$V_{OL}$	Output LOW Voltage		0.45		0.45		0.45	V	$V_{CC} = 4.75\text{ V}$ $I_{OUT} = 10\text{ mA}$ The word containing a "0" bit is selected when performing this test.
$V_{IL}$	Input LOW Voltage		0.85		0.85		0.85	V	$V_{CC} = 5.25\text{ V}$ Enable input grounded. Monitor appropriate output to guarantee this test.
$V_{IH}$	Input HIGH Voltage	1.9		1.8		1.6		V	$V_{CC} = 4.75\text{ V}$ Enable input grounded. Monitor appropriate output to guarantee this test.
$I_{CC}$	Power Supply Current		80		80		80	mA	$V_{CC} = 5.25\text{ V}$ All inputs grounded

\*X=package type; F for Flatpak, D for Ceramic Dip, P for Plastic Dip. See Packaging Information Section for packages available on this product.

### SWITCHING TIME CHARACTERISTICS ( $T_A = 25^\circ\text{C}$ )

SYMBOL	PARAMETER	LIMITS			UNITS	TEST CONDITIONS
		MIN.	TYP.	MAX.		
$t_{++}$	Enable and Address Delay	*	50		ns	10 mA load. See Note 1.
$t_{--}$	Enable and Address Delay	*	50		ns	10 mA load. See Note 1.
$t_{+-}$	Address Delay	*	50		ns	10 mA load. See Note 2.
$t_{-+}$	Address Delay	*	50		ns	10 mA load. See Note 2.

\*See Typical Electrical Characteristics curves.

### NOTES:

- To test Enable delay, apply input pulse to Enable input. The word selected must contain a "0" in the bit under test.  
  
To test Address delay, the enable input must be low. Apply the input pulse to the Address input under test. The words selected must contain a "1" when input pulse is low and a "0" when input pulse is high in the bit under test.
- To test Address delay, the Enable input must be low. Apply the input pulse to the Address input under test. The words selected must contain a "0" when input pulse is low and a "1" when input pulse is high in the bit under test.

SWITCHING TIME TEST CONDITIONS AND WAVEFORMS

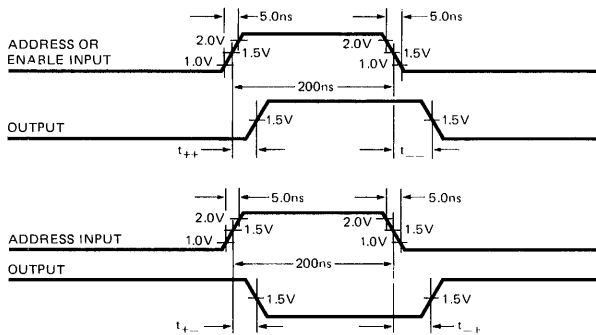

SWITCHING TEST OUTPUT LOAD

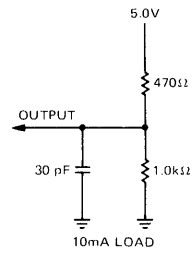

LOADING RULES

TTL INPUT LOAD AND DRIVE FACTORS

INPUTS	LOADING	OUTPUTS	DRIVE FACTOR
LOW Level	1.7 U.L.	All outputs	Open Collector 6.25 U.L.
HIGH Level	1.0 U.L.		

1 LOW Level TTL Unit Load (U.L.) = 1.6 mA  
 1 HIGH Level TTL Unit Load (U.L.) = 60 μA

TYPICAL ELECTRICAL CHARACTERISTICS

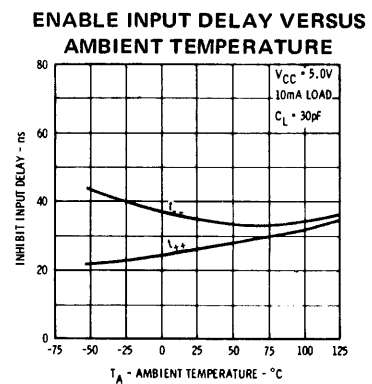
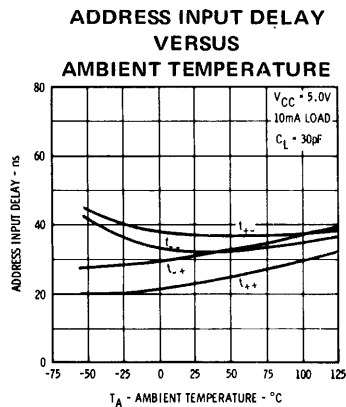
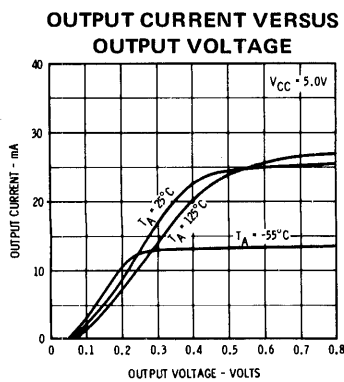
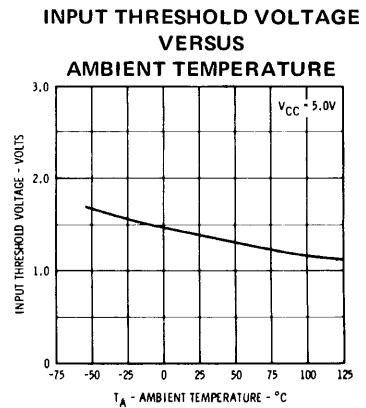
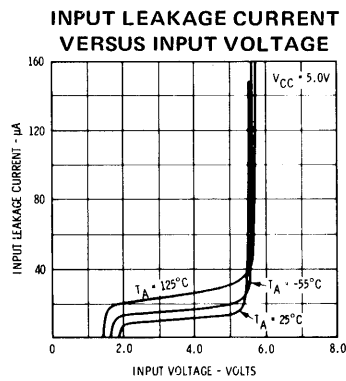
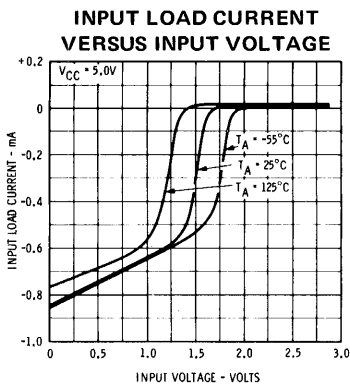

# TTL MEMORY 93435

## 64-BIT LINEAR SELECT READ/WRITE MEMORY

FORMERLY 9035

**DESCRIPTION** – The 93435 is a high speed 64-Bit Read/Write Memory Cell designed for use in high speed scratch pad memories. It is a linear select 16 word by 4-bit array.

The 93435 is available in the hermetically sealed 36-lead ceramic Dual In-Line package and will operate over the temperature range from  $-55^{\circ}\text{C}$  to  $+125^{\circ}\text{C}$ .

**OPERATION** – In addition to 16 address inputs, 4 data outputs, and 4 data inputs, the 93435 has a chip select and a write enable. When the chip select is HIGH, a word may be addressed by a HIGH on one of the address inputs. Data is written into the addressed word location only when the write enable is held LOW. While the address is present, the outputs continuously show the contents of the word selected. Readout is non-destructive.

Up to four words may be addressed and read simultaneously with the OR function of each bit appearing at the outputs. Data can be written into two locations simultaneously.

Uncommitted collector outputs are provided on the 93435 to allow maximum flexibility in output connection. In many applications such as memory expansion, the outputs of many 93435's can be tied together. In other applications the wired-OR is not used. In either case an external pullup resistor of value R must be used to provide a HIGH at the output when it is off. Any value of R within the range specified below may be used.

$$\frac{5.1}{10 - \text{F.O. (1.6)}} \leq R \leq \frac{2.1}{N(0.1) + \text{F.O. (0.06)}}$$

R is in  $k\Omega$   
N = number of wired-OR outputs  
F.O. = number of TTL loads driven

The minimum value of R is limited by output current sinking ability. The maximum value of R is determined by the output and input leakage current ( $I_{\text{CEX}}$  and  $I_{\text{R}}$ ) which must be supplied to hold the output at 2.4 V.

- 35 ns MAXIMUM ACCESS TIME – 20 ns TYPICAL
- CHIP SELECT AND WRITE ENABLES
- UNCOMMITTED COLLECTOR OUTPUTS FOR WIRED-OR CAPABILITY
- LINEAR SELECT
- ON CHIP ADDRESS LINE BUFFERING
- TTL COMPATIBLE

#### ABSOLUTE MAXIMUM RATINGS

Storage Temperature  
Temperature (Ambient) Under Bias  
 $V_{\text{CC}}$  Pin Potential to Ground  
Input Pin Voltage  
Current into Output Terminal  
Output Voltage

$-65^{\circ}\text{C}$  to  $+150^{\circ}\text{C}$   
 $-55^{\circ}\text{C}$  to  $+125^{\circ}\text{C}$   
 $-0.5\text{ V}$  to  $+7.0\text{ V}$   
 $-0.5\text{ V}$  to  $+5.5\text{ V}$   
50 mA  
 $-0.5\text{ V}$  to  $+8.0\text{ V}$

#### LOGIC SYMBOL

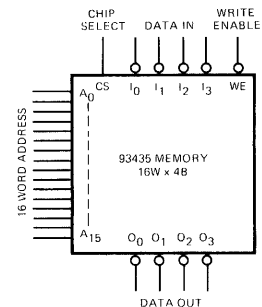

#### CONNECTION DIAGRAM DIP (TOP VIEW)

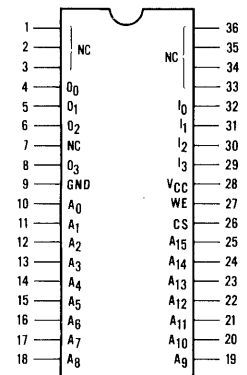

NC = No Internal Connection

# FAIRCHILD TTL MEMORY • 93435

## LOADING RULES

	HIGH LEVEL (TTL Unit Loads)	LOW LEVEL (TTL Unit Loads)
Address	1.67	1
Chip Select	26.7	1 (see note 1)
Write Enable	1.67	1
Data Input	3.34	2
Data Output	Open Collector	6.2

1 LOW Level TTL Unit Load = 1.6 mA  
1 HIGH Level TTL Unit Load = 60  $\mu$ A

### ELECTRICAL CHARACTERISTICS ( $T_A = -55^\circ\text{C}$ to $125^\circ\text{C}$ , $V_{CC} = 5.0\text{ V} \pm 10\%$ ) (units are pulse tested) (Part No. 93435XM)\*

SYMBOL	PARAMETER	LIMITS			UNITS	CONDITIONS
		-55°C MIN. MAX.	+25°C MIN. MAX.	+125°C MIN. MAX.		
I <sub>FA</sub>	Address Input Load Current	-1.6	-1.6	-1.6	mA	$V_{CC} = 5.5\text{ V}$ , $V_A = 0.4\text{ V}$
I <sub>FCS</sub>	Chip Select Load Current	-1.6	-1.6	-1.6	mA	$V_{CC} = 5.5\text{ V}$ , $V_{CS} = 0.4\text{ V}$ See Note 1
I <sub>FWE</sub>	Write Enable Load Current	-1.6	-1.6	-1.6	mA	$V_{CC} = 5.5\text{ V}$ , $V_W = 0.4\text{ V}$
I <sub>FD</sub>	Data Input Load Current	-3.2	-3.2	-3.2	mA	$V_{CC} = 5.5\text{ V}$ , $V_D = 0.4\text{ V}$
I <sub>RA</sub>	Address Input Leakage Current	100	100	100	$\mu$ A	$V_{CC} = 5.5\text{ V}$ , $V_A = 4.5\text{ V}$
I <sub>RCS</sub>	Chip Select Input Leakage Current	1.6	1.6	1.6	mA	$V_{CC} = 5.5\text{ V}$ , $V_{CS} = 4.5\text{ V}$
I <sub>RWE</sub>	Write Enable Leakage Current	100	100	100	$\mu$ A	$V_{CC} = 5.5\text{ V}$ , $V_W = 4.5\text{ V}$
I <sub>RD</sub>	Data Input Leakage Current	200	200	200	$\mu$ A	$V_{CC} = 5.5\text{ V}$ , $V_D = 4.5\text{ V}$
I <sub>CEX</sub>	Output Leakage Current	100	100	100	$\mu$ A	$V_{CC} = 5.5\text{ V}$ , $V_{CEX} = 5.5\text{ V}$ Write Enable Input Grounded
V <sub>OL</sub>	Output LOW Voltage	0.4	0.4	0.4	Volts	$V_{CC} = 4.5\text{ V}$ , $I_{OL} = 10\text{ mA}$ One Word Addressed
V <sub>IL</sub>	Input LOW Voltage	0.8	0.9	0.8	Volts	$V_{CC} = 5.0\text{ V}$ , Monitor Appropriate Output To Guarantee This Test Limit
V <sub>IH</sub>	Input HIGH Voltage	2.1	2.0	2.0	Volts	$V_{CC} = 5.0\text{ V}$ , Monitor Appropriate Output To Guarantee This Test Limit
I <sub>PD</sub>	Supply Current	118	118	118	mA	$V_{CC} = 5.5\text{ V}$ , One Word Addressed

### ELECTRICAL CHARACTERISTICS ( $T_A = 0^\circ\text{C}$ to $75^\circ\text{C}$ , $V_{CC} = 5.0\text{ V} \pm 5\%$ ) (units are pulse tested) (Part No. 93435XC)\*

SYMBOL	PARAMETER	LIMITS			UNITS	CONDITIONS
		0°C MIN. MAX.	+25°C MIN. MAX.	+75°C MIN. MAX.		
I <sub>FA</sub>	Address Input Load Current	-1.6	-1.6	-1.6	mA	$V_{CC} = 5.25\text{ V}$ , $V_A = 0.45\text{ V}$
I <sub>FCS</sub>	Chip Select Load Current	-1.6	-1.6	-1.6	mA	$V_{CC} = 5.25\text{ V}$ , $V_{CS} = 0.45\text{ V}$ See Note 1
I <sub>FWE</sub>	Write Enable Load Current	-1.6	-1.6	-1.6	mA	$V_{CC} = 5.25\text{ V}$ , $V_W = 0.45\text{ V}$
I <sub>FD</sub>	Data Input Load Current	-3.2	-3.2	-3.2	mA	$V_{CC} = 5.25\text{ V}$ , $V_D = 0.45\text{ V}$
I <sub>RA</sub>	Address Input Leakage Current	100	100	100	$\mu$ A	$V_{CC} = 5.25\text{ V}$ , $V_A = 4.5\text{ V}$
I <sub>RCS</sub>	Chip Select Input Leakage Current	1.6	1.6	1.6	mA	$V_{CC} = 5.25\text{ V}$ , $V_{CS} = 4.5\text{ V}$
I <sub>RWE</sub>	Write Enable Leakage Current	100	100	100	$\mu$ A	$V_{CC} = 5.25\text{ V}$ , $V_W = 4.5\text{ V}$
I <sub>RD</sub>	Data Input Leakage Current	200	200	200	$\mu$ A	$V_{CC} = 5.25\text{ V}$ , $V_D = 4.5\text{ V}$
I <sub>CEX</sub>	Output Leakage Current	100	100	100	$\mu$ A	$V_{CC} = 5.25\text{ V}$ , $V_{CEX} = 5.25\text{ V}$ Write Enable Input Grounded
V <sub>OL</sub>	Output LOW Voltage	0.45	0.45	0.45	Volts	$V_{CC} = 4.75\text{ V}$ , $I_{OL} = 10\text{ mA}$ One Word Addressed
V <sub>IL</sub>	Input LOW Voltage	0.85	0.85	0.85	Volts	$V_{CC} = 5.0\text{ V}$ , Monitor Appropriate Output To Guarantee This Test Limit
V <sub>IH</sub>	Input HIGH Voltage	2.0	2.0	2.0	Volts	$V_{CC} = 5.0\text{ V}$ , Monitor Appropriate Output To Guarantee This Test Limit
I <sub>PD</sub>	Supply Current	124	124	124	mA	$V_{CC} = 5.25\text{ V}$ , One Word Addressed

\* X = package type; F for Flatpak, D for Ceramic Dip, P for Plastic Dip. See Packaging Information Section for packages available on this product.  
NOTE:

(1) I<sub>FCS</sub> increases by 1.6 mA for each address input held at a logic 1.



TYPICAL ELECTRICAL CHARACTERISTICS

ADDRESS INPUT LOAD CURRENT VERSUS INPUT VOLTAGE

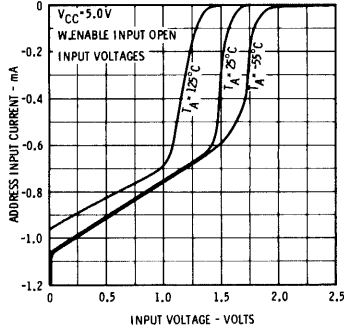

ADDRESS INPUT LEAKAGE CURRENT VERSUS INPUT VOLTAGE

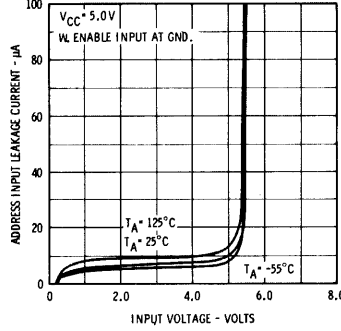

OUTPUT CURRENT VERSUS OUTPUT SATURATION VOLTAGE

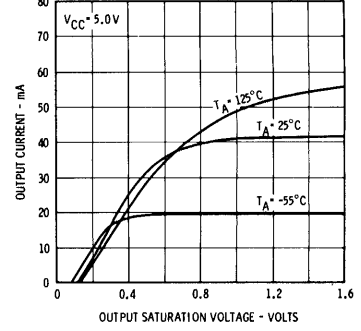

ADDRESS TO OUTPUT DELAY TIME VERSUS OUTPUT LOAD CAPACITANCE

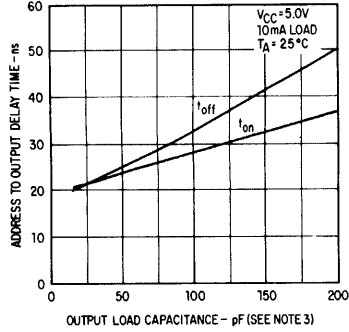

ADDRESS TO OUTPUT DELAY TIME VERSUS TEMPERATURE

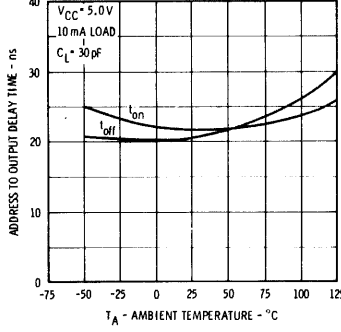

WRITE PULSE WIDTH VERSUS TEMPERATURE

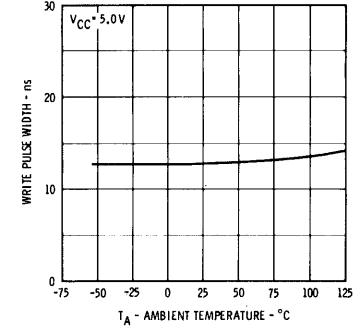

SWITCHING CHARACTERISTICS (TA = 25°C, VCC = 5.0V)

SYMBOL	PARAMETER	LIMIT (ns)			CONDITION		
		MIN.	TYP.	MAX.	LOAD	C	NOTE
t <sub>on</sub>	Address to Output Turn-On Delay	10	22	35	10 mA	30 pF	1
t <sub>off</sub>	Address to Output Turn-Off Delay	10	20	35	10 mA	30 pF	1
t <sub>wp</sub>	Write Pulse Width Required to Write	25	15		10 mA	30 pF	2
t <sub>wd</sub>	Write Delay	10	30	50	10 mA	30 pF	2

NOTES:

- (1) To test t<sub>on</sub> and t<sub>off</sub>, a LOW must be stored in the cell under test.
- (2) One word is selected during the test.
- (3) The typical capacitance of one 93435 output is 7.0 pF.

