

EK-KC780-TM-007

# KC780 Family Remote Diagnosis Options

Technical Manual

KC780, KC782 and KC785

**digital**

EK-KC780-TM-007

JULY, 1984

KC780 FAMILY  
REMOTE DIAGNOSIS OPTIONS  
TECHNICAL MANUAL

KC780, KC782, and KC785

First Edition October 1980  
Second Edition January 1982  
Third Edition October 1982  
Fourth Edition November 1982  
Fifth Edition August 1983  
Sixth Edition March 1984  
Seventh Edition June 1984

Copyright © 1982,1983, and 1984  
by Digital Equipment Corporation

All Rights Reserved

The reproduction of this material, in part or whole, is strictly prohibited. For copy information, contact the Educational Services Department, Digital Equipment Corporation, Maynard, Massachusetts 01754.

The information in this document is subject to change without notice. Digital Equipment Corporation assumes no responsibility for any errors that may appear in this manual.

Printed in U.S.A.

The following are trademarks of Digital Equipment Corporation, Maynard, Massachusetts.

DEC	DECnet	OMNIBUS
DECUS	DECsystem-10	OS/8
DIGITAL	DECSYSTEM-20	PDT
Digital Logo	DECwriter	RSTS
PDP	DIBOL	RSX
UNIBUS	EduSystem	VMS
VAX	IAS	VT
	MASSBUS	

## CONTENTS

### CHAPTER 1 INTRODUCTION

1.1	Scope .....	1-1
1.2	VAX-11/780 Series Systems Remote Diagnosis .....	1-2
1.3	DDC/RDC Host Computer System .....	1-4
1.4	DDC/RDC Operation Overview .....	1-5
1.5	M8017 (-00, -AA, -YB) Module Specifications .....	1-6
1.6	Modem Specifications .....	1-7
1.7	Related Documentation .....	1-8

### CHAPTER 2 FUNCTIONAL DESCRIPTION

2.1	Introduction .....	2-1
2.2	The VAX-11/780 Series System Control Panel .....	2-4
2.2.1	The Keyswitch .....	2-4
2.2.2	The REMOTE Indicator Light .....	2-5
2.3	Serial Line Interface .....	2-5
2.3.1	M8017 Options .....	2-6
2.4	KC780 Family Remote Diagnosis Operation Sequence .	2-7
2.5	Console Terminal .....	2-8

### CHAPTER 3 OPERATION

3.1	Introduction .....	3-1
3.2	A Typical Remote Diagnosis Session .....	3-1
3.3	Intermittent Failure .....	3-6
3.4	Extended Monitoring .....	3-8

## CHAPTER 4 INSTALLATION

4.1	Introduction .....	4-1
4.2	Site Preparation Requirements .....	4-2
4.2.1	System Configuration Package .....	4-2
4.2.2	Modem Location .....	4-2
4.2.3	RJ11C Standard Voice Jack (United States) .....	4-4
4.2.4	Option Kits For Installation in Canada .....	4-5
4.2.5	Option Kits For Installation in Europe .....	4-6
4.2.6	Site Management Guide .....	4-6
4.3	The KC780 Family Remote Diagnosis Kits .....	4-6
4.3.1	Opening the Kit .....	4-7
4.4	Step-By-Step Installation Procedure .....	4-13
4.5	Modem Test .....	4-36
4.6	M8017 Off-Line Test .....	4-37
4.7	DDC/RDC System Test .....	4-38
4.8	Customer Instruction .....	4-38
4.8.1	Normal Operation Not Affected .....	4-39
4.8.2	The User Guide .....	4-39
4.8.3	The Site Management Guide .....	4-40
4.8.4	DDC/RDC Demonstration Session .....	4-40
4.8.5	Installation Acknowledgement Form .....	4-41
4.9	Removing a KC780 Family Option .....	4-44

## CHAPTER 5 TROUBLESHOOTING

5.1	Field Maintenance Philosophy .....	5-1
5.2	M8017 Test .....	5-1
5.3	Modem Signal Control in the LSI-11 .....	5-2
5.4	Modem Failure .....	5-3
5.5	Failure Indications .....	5-3
5.5.1	No System Identification Message .....	5-3
5.5.2	DDC/RDC Not Able to Connect .....	5-4

## APPENDIX A GENERAL MODEM INFORMATION

A.1	Interface to Common Carrier Network.....	A-1
A.2	Modems - Canada .....	A-4
A.3	Modems - Europe .....	A-4
A.4	Modems - United States .....	A-6
A.4.1	Racal Vadic Modem .....	A-6
A.4.2	GDC Modem .....	A-7
A.4.3	DIGITAL DF02/DF03 Modem .....	A-7
A.5	Modem Troubleshooting .....	A-10
A.6	Modem Repair .....	A-15
A.7	FCC Regulations (USA) .....	A-16
A.8	Modem Operation Characteristics .....	A-19
A.8.1	Definitions .....	A-20
A.8.2	Call Requirements .....	A-20
A.8.2.1	Automatic Call Answering .....	A-20
A.8.2.2	Establishing a Logical Connection .....	A-23
A.8.2.3	Call Termination (Abort Sequence) .....	A-23

## APPENDIX B WIRE WRAP WORKMANSHIP STANDARD

B.1	Purpose
B.2	Definitions
B.3	Connections
B.4	Procedure

## APPENDIX C USER GUIDES

## APPENDIX D COMMUNICATIONS SWITCH

## FIGURES

2-1	LSI-11 With KC780 Family Remote Diagnosis Option	2-2
3-1	The VAX-11/780 Series System Control Panel .....	3-4
4-1	KC780/KC782 Kitting Scheme .....	4-3
4-2	KC780 Family Option Kit Contents .....	4-9
4-3	LSI-11 Hardware Configuration .....	4-14
4-4	Original LSI-11 Module Configurations .....	4-15
4-5	LSI-11 Configurations With KC780 and KC782 .....	4-16
4-6	LSI-11 Configurations in 11/785 Systems .....	4-17
4-7	M8017-00, M8017-YB Jumper Configuration .....	4-23
4-8	M8017-AA Jumper Configuration .....	4-24
4-9	M7944 Jumpers for KC780-DA or KC782-DA .....	4-25
4-10	M7264 to M7264-YA Rework .....	4-31
4-11	KC780 and KC782 Installation Acknowledgement Form	4-42
4-12	KC785-BA Installation Acknowledgement Form .....	4-43
A-1	M8017 (-00, -AA, -YB) Interface .....	A-2
A-2	Cabling Diagram .....	A-3
A-3	Racal-Vadic Switch and Jumper Configuration .....	A-8
A-4	GDC Jumper and Switch Configuration .....	A-9
A-5	DF02 Interface Board Jumpers for KC780-BA .....	A-11
A-6	DF02 Modem Board Jumpers for KC780-BA .....	A-12
A-7	DF03 Interface Board Option Jumpers .....	A-13
A-8	DF03 Modem Board Option Jumpers .....	A-14
A-9	Automatic Call Answering Sequence .....	A-25
A-10	Call Abort or Termination Sequence .....	A-25
A-11	Call Initialization .....	A-26
A-12	Call Abort or Termination Sequence .....	A-27
B-1	Solderless Wrapped Connection on Wire Wrap Pin ...	B-1
B-2	Full Turn .....	B-2
B-3	Half Turn .....	B-2
B-4	Two Levels of Wire Wrap .....	B-3
B-5	Defective Wire Wraps .....	B-4
B-6	Loading the Wire Wrapping Kit .....	B-6
C-1	KC780 Family User Guide .....	C-2
C-2	VAX-11/780 Remote Diagnosis Preparation .....	C-4
D-1	Communications Switch Document .....	D-2

## TABLES

4-1	Modem Specifications For RJ11C .....	4-5
4-2	KC780/VAX-11/780 Compatibility .....	4-12
4-3	M8017 (-00, -AA, and -YB) Jumper Configuration ..	4-20
5-1	Troubleshooting KC780 Family Options .....	5-5
A-1	Modem Option States .....	A-5
A-2	Signal Definitions .....	A-21



1.1 SCOPE

This manual provides information for Digital Field Service personnel who install, test, and maintain VAX-11/780 Series systems remote diagnosis equipment. The material presented supports the option maintenance philosophy which is module swapping. It provides information needed to service the option at that level.

Chapter 1 INTRODUCTION - provides an overview of Digital Remote Diagnosis and describes the relationships between the customer, the Digital Remote Diagnosis Center (two acronyms are used, DDC and RDC), and the local Digital Field Service office.

Chapter 2 FUNCTIONAL DESCRIPTION - describes the remote port and the modem and their interfaces to the LSI-11, the DDC/RDC, and to each other. Note that modem operation is covered in greater detail in Appendix A.

Chapter 3 OPERATION - describes typical operation and operator involvement when remote diagnosis is used to resolve a system problem. This chapter is primarily for use in customer instruction following option installation.

Chapter 4 INSTALLATION - provides information required for site preparation and step-by-step instructions for installation and testing of the option. It also includes the procedure for removing the option.

Chapter 5 TROUBLESHOOTING - describes troubleshooting of the KC780 Family options and documents some known failure indications and their causes.

Appendix A GENERAL MODEM INFORMATION - is a compilation of modem information which applies to remote diagnosis. It also includes excerpts of government regulations that users of remote diagnosis equipment in the United States should be familiar with.

Appendix B WIRE WRAP INSTRUCTIONS - is a Digital Workmanship Standard titled "Wire Wrap Instructions". It is reproduced in this manual to remind or instruct the reader concerning the correct installation of wire wrap jumpers on the M8017 module.

Appendix C USER GUIDE DOCUMENTATION - is a reproduction of two "user guide" documents that are left on-site for customer use. Those documents are included in this manual so that, if they are not available otherwise, photocopies may be made for that purpose.

APPENDIX D COMMUNICATIONS SWITCH - is a reproduction of the document that is shipped with the four-port communications switch.

## 1.2 VAX-11/780 SERIES SYSTEMS REMOTE DIAGNOSIS

Digital's implementation of a system for providing a range of customer services over the switched lines telephone network is referred to as "REMOTE DIAGNOSIS". Some features of this system are unique in the industry:

- o A telephone connection to the customer's computer is used in the initial response to a request for repair service. The Remote Diagnosis Port, a reserved connection into the customer's system, is dedicated to that purpose.

- o The Digital Remote Diagnosis Center (DDC/RDC) host computer can be used to initiate tests and control them automatically. The application software uses both historical information about the customer's system and dynamic test results to optimize the test procedure.
  
- o The DDC/RDC staff includes response specialists and experienced engineers who are especially trained to monitor customer system operation and to diagnose problems from their remote location. The DDC/RDC and the local Digital Field Service office work together in response to a customer service request.

The KC780 Family options add remote diagnosis capability to VAX-11/780 Series systems. The option is logically inserted between the console terminal and the processor. When the option is installed, the console terminal I/O port is switch-controlled so that it can function as a remote diagnosis port. The remote port also provides DMA (Direct Memory Access) capability for use by the DDC/RDC host computer.

ASCII character commands, entered at the console terminal, control the processor in normal operation. The DDC/RDC remote operator uses the same commands when remote access is in effect. A keyswitch on the processor control panel controls remote access to the system. When the keyswitch is set to either REMOTE or REMOTE DISABLE, all system control operations normally performed at the local console terminal can be performed from the DDC/RDC remote terminal.

The DDC/RDC remote operator can:

- o Enter console commands.
- o Enter and examine data in memory.
- o Examine the contents of registers.
- o Control, and communicate with, user and diagnostic programs.

### 1.3 DDC/RDC HOST COMPUTER SYSTEM

The DDC/RDC host computer system is a major feature of Digital's remote diagnosis service. The system stores statistical and other historical information about each customer system it services. This data includes information required for testing, such as how peripherals are configured, I/O addresses, memory size, hardware and operating system revision status, and the names and phone numbers of customer site personnel. When a DDC/RDC response specialist enters a service request into the system, it uses that data base and its auto-dial equipment to make a connection to the customer's system and perform various tests. The host system application software includes programs (scripting) which automatically control the running of diagnostics on the customer's system.

During a service session, the host system reports on the results of diagnostic tests completed and the status of those in progress. It also provides the DDC/RDC remote operator with such details as who the customer representative on site is and which local Digital Field Service office has service responsibility. As each service session is completed, the data base for that customer system is updated. As a result, the DDC/RDC has a "case history" which can be referenced for fault analysis or as an indication of performance quality.

#### 1.4 DDC/RDC OPERATION OVERVIEW

Customers whose systems are equipped for remote diagnosis enter requests for service with the DDC/RDC. The DDC/RDC response specialist decides either to start a host-computer-controlled test session or to refer the call directly to the responsible local Digital Field Service office. If the problem is to be handled by the DDC/RDC, the response specialist creates a repair record on the host system, listing details about the problem. The response specialist then begins the appropriate test procedure and informs the local Digital Field Service office that the customer call was received and that testing is in progress.

A DDC/RDC engineer reviews test results and performs additional host-computer-controlled tests or takes direct control of the system through a remote console. When testing is complete, the DDC/RDC informs the local Digital Field Service office of its analysis of the problem. The local Digital Field Service office assumes responsibility for on-site repairs or service. Following repair, the DDC/RDC may be asked to run a test to verify that the problem has been resolved.

The final step in processing a customer service request through the DDC/RDC is closing the report. Information about the testing procedures used and the specifics of the repair are added to the historical records for that system. This enables the DDC/RDC to measure how well the procedures worked and provides a log of service requests for each customer system. Each time a service request is processed, the records of previous repair sessions is available to the response specialist to help in selecting the most effective DDC/RDC action.

1.5 M8017 (-00, -AA, -YB) MODULE SPECIFICATIONS

The following specifications are given as information only and are subject to change.

Physical Characteristics

Dimensions:

	<u>M8017 Circuit Board</u>	<u>Board With Handle</u>
Length:	21.6 cm (8.5 in)	22.8 cm (8.9 in)
Height:	12.7 cm (5.0 in)	13.2 cm (5.2 in)
Width:	1.3 cm (0.5 in)	1.3 cm (0.5 in)

Cable Connection: One 40-pin header connector

Module Type:

M8017-00	. . . . .	USED IN KC780-BA, -EA KC782-AA
M8017-AA	. . . . .	USED IN KC780-BA, -DA, -EA KC782-AA, -DA KC785-BA, -DA
M8017-YB	. . . . .	USED IN KC780-DA KC782-DA
M7944	MSV11-B . . . .	USED IN KC780-DA KC782-DA
M8044-EA	MSV11-DE . . . .	USED IN KC780-DA KC782-DA

## Electrical Characteristics

### Power Specification:

Approximately 1.0 A @ +5 V +5%, 5.0 W

Approximately 150 mA @ +12 V +5%, 1.8 W

LSI-11 Bus Loading: One bus load.

## Environmental Characteristics

### Temperature

Operating 5° C to 50° C (41° F to 122° F)

Not Operating -40° C to 66° C (-40° F to 151° F)

### Humidity (Operating and Not Operating)

10% to 95%, maximum wet bulb 32° C

(90° F) and minimum dew point 2° C (35° F)

### Altitude

Operating 2.4 km (8,000 ft)

Not Operating 9.1 km (30,000 ft)

## 1.6 MODEM SPECIFICATIONS

When a KC780 Family kit includes a modem made by a vendor, a manual for that modem is shipped with it. That manual is a source of specification details for any modem identified by Digital part number 30-15949. Specifications for vendor modems are also available in Digital Purchase Specification, A-PS-3015949-0-0. Appendix A of this manual provides all information from that purchase specification needed for field installation and repair of these modems.

The model DF02 or DF03 modem, made by DIGITAL, is also sent with a manual, DF02 User Guide, EK-0DF02-UG, or DF03 User Guide, EK-0DF03-UG which provides specifications for that modem.

## 1.7 RELATED DOCUMENTATION

Information related to remote diagnosis can be found in the following documents:

- o KC780-B FIELD MAINTENANCE PRINT SET  
MP-00704
- o KC780-D FIELD MAINTENANCE PRINT SET  
MP-01082
- o KC780-E FIELD MAINTENANCE PRINT SET  
MP-00744
- o KC782-A FIELD MAINTENANCE PRINT SET  
MP-01610
- o KC782-D FIELD MAINTENANCE PRINT SET  
MP-01611
- o KC785-B FIELD MAINTENANCE PRINT SET  
MP-01888
- o KC785-D FIELD MAINTENANCE PRINT SET  
MP-01889
- o KC780 CONSOLE INTERFACE TECHNICAL DESCRIPTION  
EK-KC780-TD

Describes the VAX-11/780 Console Subsystem which includes the M8017 remote port.



- o DLV11-E AND DLV11-F ASYNCHRONOUS LINE INTERFACE USER'S MANUAL  
EK-DLV11-OP

Describes operation of the KC780 remote port.
- o VAX-11/780 DIAGNOSTIC SYSTEM USER'S GUIDE  
EK-DS780-UG

Describes the organization and use of the VAX-11/780 Diagnostic System, including ROM resident testing of the LSI-11 and microdiagnostics, Direct I/O diagnostics, and Queue I/O diagnostics for system testing.
- o VAX-11/780 SYSTEM MAINTENANCE GUIDE  
EK-11/780-PG

Describes VAX-11/780 operating and maintenance procedures, troubleshooting, and diagnostics in a single-source summary format.
- o KC785 TECHNICAL DESCRIPTION  
EK-KC785-TD

Describes the KC785.
- o TERMINALS AND COMMUNICATIONS HANDBOOK  
EB15486

Presents concepts of data communications.
- o Each KC780 Family kit that includes a vendor-manufactured modem also includes a vendor-published manual that describes installation and operation of that modem.

## 2.1 INTRODUCTION

The KC780 Family remote diagnosis option is a serial line interface installed as a remote port in the LSI-11 console subsystem of VAX-11/780 Series systems. That port is connected to an external modem to provide remote access through the public telephone network. The telephone line to that port at the customer site is dedicated to remote diagnosis and is not intended for support of either voice communications or other customer use of the remote port.

Figure 2-1 shows the VAX-11/780 Series systems LSI11 with the KC780 Family options added.

Two VAX-11-780 processors can be interconnected to function as one VAX-11/782 system. When remote diagnosis is implemented, identical hardware is added internally to each processor. Both processors can be served by one modem when an LQPX2 processor select switch (supplied in each KC782 kit) is used. The KC780 and KC782 kitting scheme is explained in Paragraph 4.3.

Remote access to the VAX processor is enabled or disabled according to the setting of the keyswitch on the front panel.

**VAX-11/780 and VAX-11/782 only:**

Software provided by the Remote Console diskette, RX4 in the United States and Canada, RX41 in Europe, is also required to enable remote access.

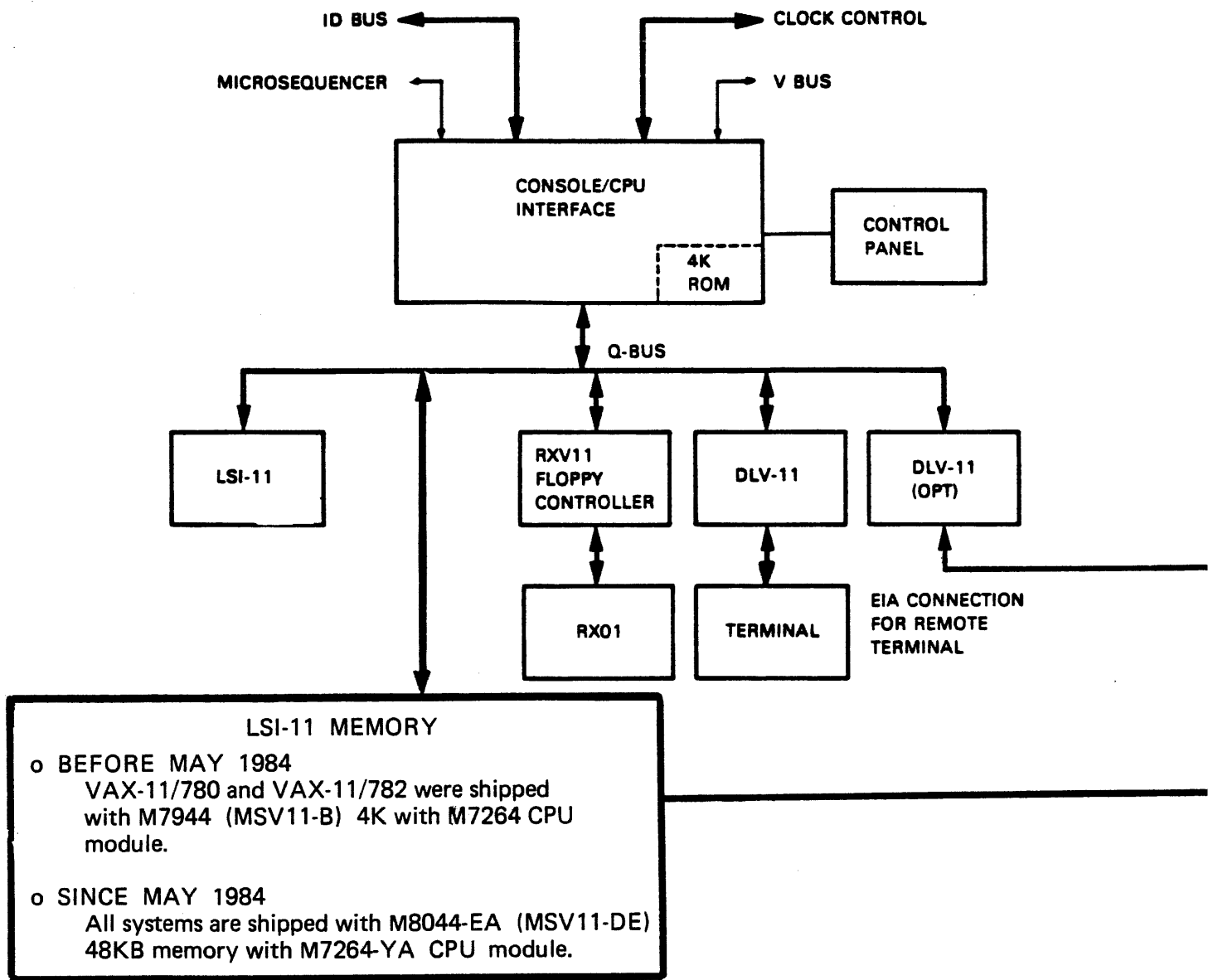

\* MODEMS ARE INCLUDED IN KC780-BA and KC785-BA KITS ONLY

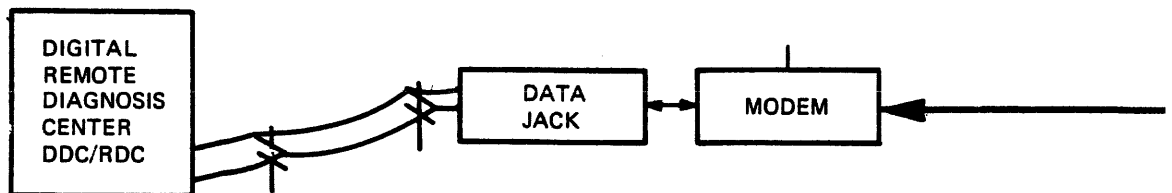
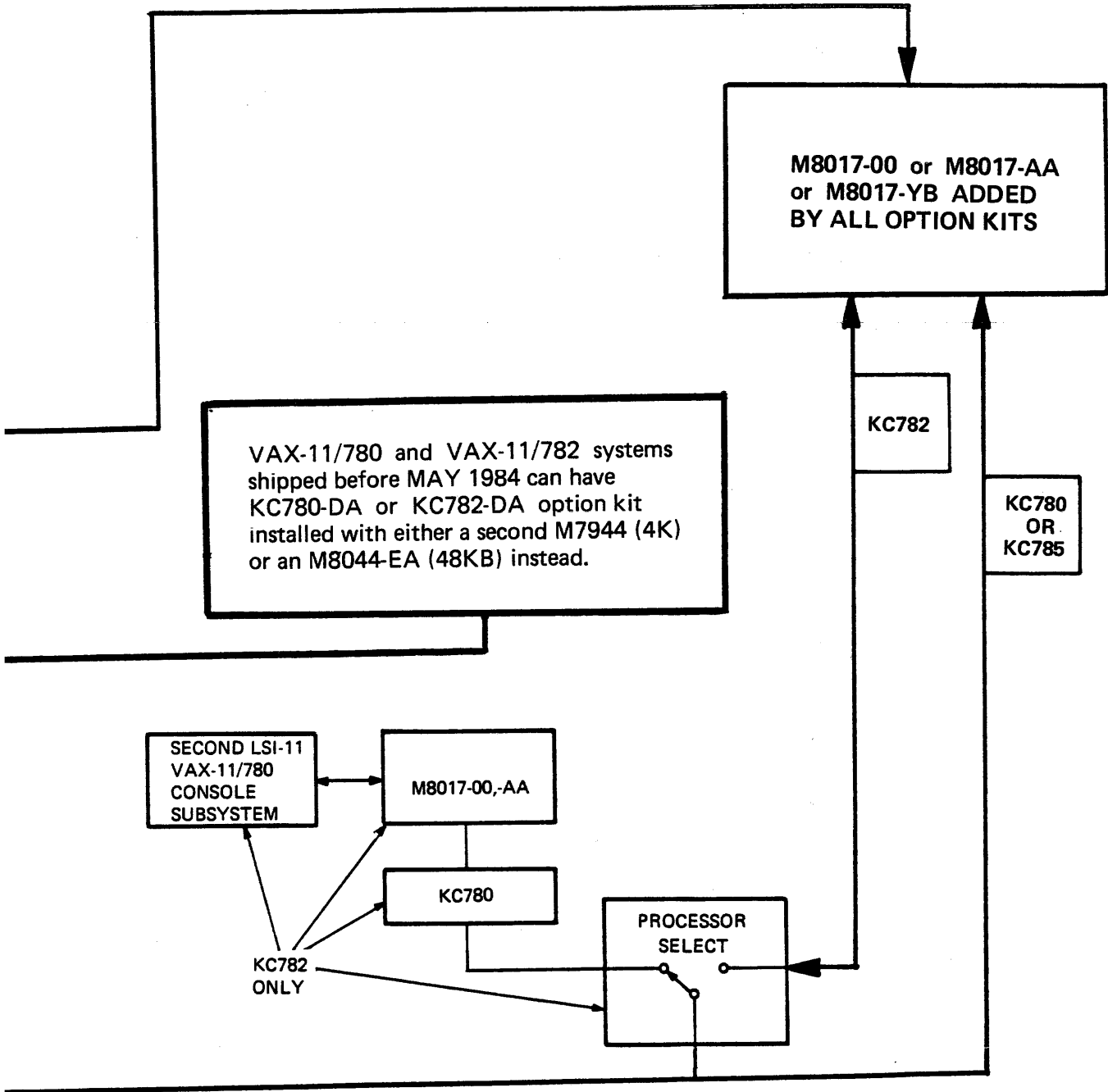

Figure 2-1 LSI-11 With KC780 Family Remote Diagnosis Option



VAX-11/782 only:

The LQPX2 processor select switch setting determines which processor is accessible. See also Appendix 6.

## 2.2 THE VAX-11/780 SERIES SYSTEM CONTROL PANEL

The LSI-11 monitors the state of switches on the VAX control panel. It reads the Miscellaneous Control Status (MCS) register continually, first at power-up, and then each time it performs a null loop. The control panel is shown in Figure 3-1.

### 2.2.1 The Keyswitch

The five-position keyswitch, located on the VAX control panel, controls MCS register bits 0 and 1. The state of these bits starts or controls specific LSI-11 operations as follows:

- o LOCAL  
When the keyswitch is in LOCAL, the LSI-11 enables the local terminal as the console terminal or as the VMS operator's terminal. Both Console I/O or Program I/O modes are available. The remote port is disabled.
- o LOCAL DISABLE  
When the keyswitch is in LOCAL DISABLE, the LSI-11 enables the local terminal as the VMS operator's terminal. Console I/O mode is disabled. This is often referred to as "panel locked" mode. The remote port is disabled.
- o REMOTE  
When the keyswitch is in REMOTE, the LSI-11 enables the remote port which, in turn, enables DDC/RDC access to the system. Both Console I/O and Program I/O modes are available to the DDC/RDC remote operator. The local console terminal is disabled as an initial condition but it can be enabled by the DDC/RDC remote operator.

o **REMOTE DISABLE**

When the keyswitch is in REMOTE DISABLE, the LSI-11 enables the remote port as the VMS operator's terminal. DDC/RDC access to the system is limited to Program I/O mode. Console I/O mode is disabled. Local Copy is enabled. The local terminal keyboard is disabled as an initial condition but it can be enabled by the DDC/RDC remote operator.

**2.2.2 The Remote Indicator Light**

When the keyswitch is set to either REMOTE or REMOTE DISABLE, the red REMOTE indicator light comes on. This indicates to the on-site operator that the remote port is enabled and the DDC/RDC has access to the system.

**2.3 Serial Line Interface**

The LSI-11 has two terminal ports. The basic configuration includes an M7940 module for connection of the system console terminal. In the installation of the KC780 Family option, an M8017 (-00, -AA, or -YB) module is added as the second, remote port.

**VAX-11/780 and VAX-11/782 only:**

The console diskette which is shipped with the system controls only the local console terminal port. When the KC780 or KC782 option is added, modified software must be present to control both the local and remote ports. This software is provided by the Remote Console Diskette, RX4 in the United States and Canada or RX41 in Europe, which is included in the option kit.

**VAX-11/785 only:**

The console diskette, RX1A, which is shipped with the VAX-11/785 system, controls the local console port. When the KC785 option is added, the same console diskette controls the remote port and supports the United States, Canada and Europe.

The DLV11-E and DLV11-F Asynchronous Line Interface User's Manual, EK-DLV11-OP, provides a complete technical description of the M8017 module. All information needed for KC780 Family option installation, such as M8017 jumper configuration, are provided in this manual.

### 2.3.1 M8017 Options

Table 4-3 identifies the M8017 option jumpers by function and shows their required inserted or removed states. It also identifies those jumpers which must be inserted or removed during field installation. Figures 4-5 and 4-6 indicate jumper locations on the boards and show their inserted or removed states for KC780, KC782 and KC785 operation.

Appendix B, Wire Wrap Instructions, is included in this manual as a reminder or to instruct concerning proper insertion of the M8017 jumpers.

## 2.4 KC780 FAMILY REMOTE DIAGNOSIS OPERATION SEQUENCE

A typical remote diagnosis session exercises the following functions:

### NOTE

Refer to Appendix A (Table A-2) for more information about the data communications signals and event sequences described here.

1. When the keyswitch is set to REMOTE, the KC780 Family option asserts DTR (Data Terminal Ready) at the LSI-11 remote port which enables call answering. Note that in a VAX-11/782 system, the LQPX2 processor select switch determines which processor is accessible.
2. The DDC/RDC host computer calls the number of the dedicated telephone line.
3. The modem detects RI (Ring Indicator) then asserts DSR (Data Set Ready) to indicate to the KC780 that the modem has answered the call.
4. The KC780 asserts RTS (Request To Send) to the modem. The modem responds by putting its answer mode carrier signal on the line.
5. The on-site modem receives the carrier signal from the modem at the DDC/RDC and responds by asserting CD (Carrier Detect). It then indicates to the option that its carrier signal is on the line by asserting CTS (Clear To Send).
6. A transfer of protocol messages occurs between the DDC/RDC host computer and the local VAX. A logical connection is in effect when a valid protocol message has been received from the DDC/RDC.



7. The DDC/RDC begins diagnostic testing of the customer's system. The DDC/RDC may terminate the call, allow testing to proceed, then call back to evaluate test results.
8. If the carrier from the modem at the DDC/RDC is lost (e.g. they "hang up"), CD (Carrier Detect) is lost at the on-site modem. This causes the option to begin its termination sequence. It clears DTR (Data Terminal Ready), thus disabling access through the remote port.
9. When the termination sequence is completed, and if the keyswitch is in REMOTE or REMOTE DISABLE, the KC780 asserts DTR (Data Terminal Ready) at the LSI-11 remote port which enables call answering.
10. When the operator sets the keyswitch to LOCAL, remote access to the system and call answering are disabled.

## 2.5 CONSOLE TERMINAL

Console Terminal operation is not affected by the presence of remote diagnosis hardware. There is no conflict or interaction between the KC780 Family option hardware and the setting of such terminal features as baud rate, parity and data bits, etc.

### 3.1 INTRODUCTION

The addition of a KC780 Family remote diagnosis option does not affect normal VAX system operation. There are no changes to normal operating procedures performed by the user. Having remote diagnosis available does mean, however, that the user must be prepared to work with the DDC/RDC in the event of a system failure. A user who is familiar with remote diagnosis procedures can help the DDC/RDC when they work together to restore the system to correct operation. This chapter provides basic information about those procedures which can be used for instruction of customer site personnel following option installation. The KC780 Family User Guide, Figure C-1, should be used during that instruction.

### 3.2 A TYPICAL REMOTE DIAGNOSIS SESSION

A typical remote diagnosis session involves the following instructions and procedures. These are the steps which are summarized in the KC780 Family User Guide. If the reported failure can be isolated to a specific device, the session may be limited to the steps required to test that device.

1. The system is running with the keyswitch in LOCAL or LOCAL DISABLE when a hardware failure occurs.

2. The on-site operator calls the DDC/RDC and enters a request for service. Reference to user guide information may be helpful at this time:

a. The KC780 Remote Diagnosis Option Family User Guide

EK-KC780-UG (Figure C-1)

This is an instructional document which will be found near the telephone, attached to the processor cabinet or terminal or in some other highly visible location. It may be filed in the Site Management Guide as described below. It tells the user how to prepare the system for remote diagnosis, how to call the DDC/RDC, and summarizes the remote diagnosis procedures.

b. VAX 11/780 Remote Diagnosis Preparation

EK-11780-DC (Figure C-2)

This document is also a user guide, published especially for the Site Management Guide. The Site Management Guide is a loose-leaf binder with information about system configuration, FCO status, maintenance history, etc. Within the binder there is a tab with the title "XI. Remote Diagnostic Console (RDC)" under which this document should be filed.

c. Miscellaneous Cards and Labels

To provide customers with information about calling the DDC/RDC, local DIGITAL offices may attach cards or labels to processor cabinets, supply cabinets, or in other obvious places for that purpose. The information is usually limited to a basic instruction to call the DDC/RDC and provides the telephone number.

3. The on-site operator with no previous remote diagnosis experience asks the DDC/RDC for instructions.

4. Any media with confidential or valuable data is removed from the system or otherwise protected.
5. The disk volume, which includes the diagnostics, is mounted on the load device and put on-line, write protected.

NOTE

The diagnostic library must be resident on a disk in a directory named [SYSMAINT]. This area may be on the customer's system pack together with VMS or it can be assembled on a separate diagnostic pack or cartridge. If the customer's system pack is not to be used because of confidential or vital data, then a separate Field Service VMS pack should be prepared. For remote diagnosis, it will be mounted and write protected in place of the customer's pack.

6. Each disk drive to be tested is loaded with a formatted scratch pack (must be initialized with the label "SCRATCH") and put on-line, write enabled.
7. Each tape drive to be tested is loaded with a scratch tape and put on-line, write enabled.

8. VAX-11/780 and VAX-11/782 only:

The Remote Console diskette RX4 (RX41 in Europe) is loaded and booted in RX01 drive 0.

- a. The Remote Console diskette is MAINDEC ZZ-ESZBB in the United States and Canada and ZZ-ESZFB in Europe.
- b. Customers are requested to use only the Remote Console diskette for all operations to avoid having to reboot and, as a result, losing the machine state data.

c. Booting can only be done by turning power off at the LSI-11, then, with the diskette loaded, turning power on.

9. The AUTO RESTART switch on the VAX control panel is set to the OFF position. The control panel is shown in Figure 3-1.

10. VAX-11/782 only:

If the system is a VAX-11/782, the LQPX2 processor select switch is set to select the processor which is to be tested, A or B.

11. The keyswitch is set to the REMOTE position (the REMOTE indicator light will come on). Setting the keyswitch to REMOTE transfers control of the system to the remote port and remote access is enabled.

12. The modem is turned on with switches set for normal operation.

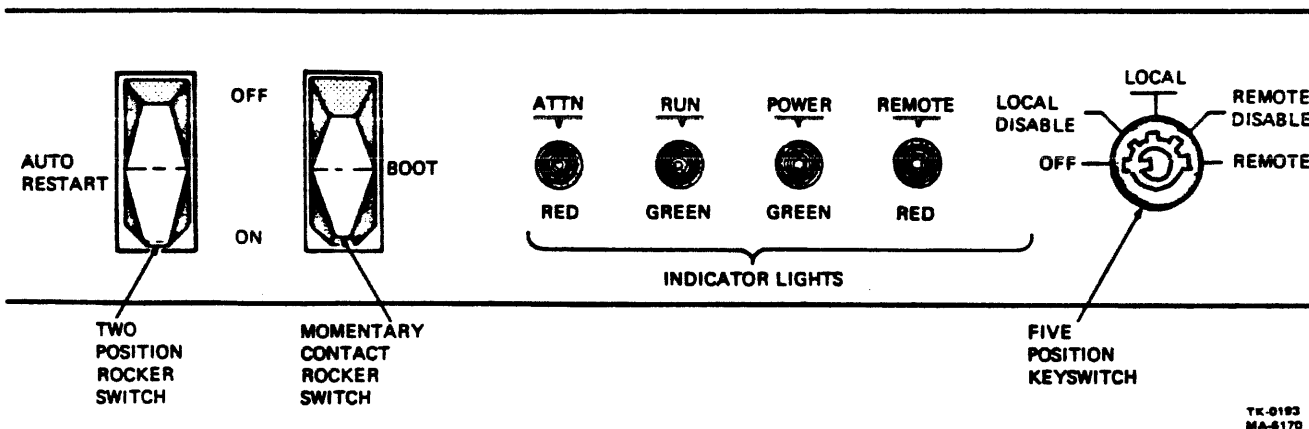

TK-0193  
MA-0170

Figure 3-1 The VAX-11/780 Series System Control Panel

13. The DDC/RDC reviews the previous steps to determine that the system has been correctly prepared for their access and testing.
14. The DDC/RDC calls the local Digital Field Service Branch Office to report that their customer has entered a service request and on-site service may be necessary.
15. The DDC/RDC takes control of the system. The option allows the remote operator to boot the system, use Console I/O or Program I/O modes, and enter the TALK state to communicate with the on-site operator at the console terminal.

**VAX-11/780 and VAX-11/782 only:**

The DDC/RDC may ask that microdiagnostic diskettes be loaded as testing progresses.

For example: Micro #1 (RX5) (RX42 in Europe)

Micro #2 (RX6) (RX43 in Europe)

Because some VAX-11/780 or VAX-11/782 hardware failures may leave the system "hung", they may ask that the Remote Console diskette, RX4, (RX41 in Europe) be loaded and booted. Booting can only be done by turning the LSI-11 DC-ON switch to OFF, then to ON.

**VAX-11/785 only:**

The DDC/RDC may ask that microdiagnostic diskettes be loaded as testing progresses. For example, RX2A, RX3A, RX5, RX7, or RX8A.

16. The DDC/RDC host computer tests the system by running the VAX diagnostic system, including Microdiagnostics, the Direct I/O Diagnostics, and the Queue I/O Diagnostics as necessary. Terminal communications are echoed at the console terminal, permitting the local operator to see the type of testing being done and to monitor its progress.

17. Activity in the RxD and TxD (Data In and Data Out) indicators on the modem (if the modem is so equipped) indicates DDC/RDC and system interaction as testing is in progress.

In certain test conditions the DDC/RDC may start a test, then "hang-up" as the test continues without their attention. Another call is made later to evaluate test results and continue the session. During the period of testing without attention there is no modem activity. DDC/RDC access to the system should not be interrupted (which would occur if the keyswitch were turned away from REMOTE or REMOTE ENABLE) unless there are instructions from the DDC/RDC to do so.

18. The DDC/RDC reports test results and/or failure analysis to the local Digital Field Service office. Control of the system is returned to the on-site operator.
19. Following repair by local Field Service personnel, the DDC/RDC may be asked to verify correct system operation.
20. When correct system operation has been verified, system control is returned to the on-site operator.

### 3.3 INTERMITTENT FAILURE

Although the procedure described in Paragraph 3.2 usually leads to the solution of intermittent hardware failures, they may not be detected by diagnostics. System software may exercise a failing hardware component or may itself produce ambiguous error indications. It is often difficult to re-create those indications which, in turn, makes analysis more complex.

When diagnostic testing has been completed, it may be determined that the reported system failure is intermittent and/or involves the operating system. The DDC/RDC can provide software expertise, both from its own staff and from other DIGITAL facilities. Depending on the system software, and the software personnel who are available to the DDC/RDC, they work together to analyze and solve the problem. Any procedure to isolate a system problem that involves the customer's operating system is attempted only with the customer's authorization.

If such a procedure is agreed upon, the DDC/RDC usually requests that the user perform the following steps:

1. Set the VAX keyswitch to LOCAL.
2. Remove scratch media and mount operating system software media.
3. Boot the system.
4. If the system is a VAX-11/782, set the LPQX2 processor select switch to select the processor which is to be tested, A or B.
5. Turn the keyswitch to REMOTE DISABLE. The REMOTE indicator light will come on. Remote access to the system is enabled.
6. Give the DDC/RDC a system account number and password.
7. The DDC/RDC logs into the system. Terminal communications are echoed at the local console terminal, however, the keyboard is disabled to prevent the on-site operator from interrupting the procedure.



8. When testing has been completed by the DDC/RDC, they log off the system. The on-site operator takes control of the system by turning the keyswitch to LOCAL.
9. The DDC/RDC calls the local Digital Field Service Office to report test results.
10. Local Field Service personnel determine the repair procedure that best meets the customer's needs and schedule the service.

#### 3.4 EXTENDED MONITORING

If test results indicate an intermittent failure condition, the DDC/RDC can schedule extended testing and monitoring of system operation. This procedure can include off-hours diagnostic runs and other procedures designed to isolate such failures.

#### 4.1 INTRODUCTION

This chapter provides information needed by Digital Field Service personnel for the following activities related to installation:

- o Preparing the site.
- o Ordering the dedicated telephone line (by the customer).
- o Installing the option hardware (a step-by-step procedure).
- o Connecting and testing the modem.
- o Monitoring the initial DDC/RDC test of the system.
- o Instructing customer site personnel.

The KC780 Family Remote Diagnosis option is installed only within the terms and conditions of a maintenance contract. It remains the property of Digital Equipment Corporation and is not for sale. If the contract is terminated, the option will be removed. Paragraph 4.9 is a step-by-step procedure for removing the option.

The modem information provided in this chapter is limited to specific details needed for site preparation and installation. Appendix A includes general modem information that will be especially useful for connecting to modems that are provided by local telecommunications authorities.

## 4.2 SITE PREPARATION REQUIREMENTS

Because a KC780 Family kit is an add-on option to a VAX-11/780 Series system, only those prerequisites for installation of the option itself are defined in this manual. These preparation steps are important to successful installation and should be started as soon as possible after it is known that the option is to be installed.

### 4.2.1 System Configuration Package

Before installation, significant technical details about the customer system must be sent to the DDC/RDC. These include such items as ECO and FCO status, option configuration, power supplies and controllers, cables, baud rates, and the presence of non-DIGITAL equipment connected to the system. These details are readily available in the System Configuration Charts, EK-SMGDE-SC, which are part of the Site Management Guide. They can be photocopied and sent to the DDC/RDC.

When the DDC/RDC receives the system configuration package, engineering personnel check it for technical details and missing information; all details needed by the host computer must be present. When the package is approved, the host computer data base is updated, making remote diagnosis possible for that system.

### 4.2.2 Modem Location

It is recommended that locations for the modem, telephone company equipment, and the connecting cables be determined before option installation (see Appendix D). Telephone company personnel will usually be able to install their equipment where the customer

wants it. A carefully planned installation can facilitate cable dressing and ensure modem visibility in operation and accessibility for maintenance. The customer may decide to install a shelf, add a table, or otherwise make space available for that hardware.

Some modem installation limitations are these:

a. Visibility

When a DDC/RDC test session is in progress, activity in the modem indicator lights is an indication of successful host computer connection through the option remote port. Although such monitoring of a diagnostic session is not necessary, it is recommended that the modem be installed so that its indicator lights are visible for that purpose.

b. Access

The modem must be accessible for maintenance purposes. Many units have switches on the back which are used for loopback testing. Also, maintenance procedures may require that the digital I/O cable be disconnected and a test adapter attached.

c. AC Power

An ac receptacle, external to the VAX system, must be provided for the modem. The modem may not be plugged into the system power controller.

d. Analog Interface Cable

The modem has an analog interface cable for connection to the telephone network. In the United States, this cable plugs into an RJ11C standard voice jack which has a miniature four-pin connector.

e. Digital Interface Cable

The option kit includes a BC05D-25 or BC22F-25 (25 feet long) cable for connecting the modem to the remote port at the VAX connector panel.

**For KC782 only:**

The KC782 option kit includes two BC22F-10 (10 feet long) cables. A VAX-11/782 system may be connected to the LQPX2 processor select switch and modem in various configurations using these cables in combination with the BC05D-25 or BC22F-25 mentioned above.

In England, a BC99N cable (which includes protective diodes) must be installed to isolate the modem from the option components. The BC05D-25, BC22F-25 or BC22F-10 may be connected between the BC99N and the option hardware as an extension.

#### 4.2.3 RJ11C Standard Voice Jack (United States)

The 30-15949, DF02, or DF03 stand-alone modem, included in the option kit, must be connected to the telephone network through an RJ11C data jack installed by the telephone company. All arrangements and costs for the installation and maintenance of the RJ11C and the dedicated line are the responsibility of the customer. The customer must provide the telephone company with the following information about the data communications equipment (modem) to be connected to the RJ11C:

- o Manufacturer's name.
- o Model number.
- o Registration number.
- o Ringer equivalence.

When the District Console Allocation Coordinator (United States) has determined which modem will be sent for the specific system, those details are communicated to the local Digital Field Service office. They can then give that information to the customer for use in ordering the RJ11C installation. Table 4-1 provides those details for the modems which are included in KC780 Family option kits as of the publication date of this manual.

Table 4-1 Modem Specifications For RJ11C

Modem Manufacturer	Model Number	FCC Registration Number	Ringer Equivalence
GDC	103A3	AG697J-62418-DM-E	0.6, Type B
VADIC	VA355P	AJ496M-70263-DM-N	1.0, Type B
DIGITAL	DF02	A0994Q-67693-DM-R	0.3, Type A
DIGITAL	DF03	A0994Q-69391-DM-R	0.3, TYPE A

#### 4.2.4 Option Kits For Installation in Canada

The KC780 Family option kits which are intended for installation in Canada do not include a modem. The option must be connected through a modem, Bell 103J or equivalent, installed by the telephone company. All arrangements and costs for the installation and maintenance of telephone company equipment are the responsibility of the customer.

#### 4.2.5 Option Kits For Installation in the U.K. and Europe

Those KC780 Family kits which are intended for installation in Europe do not include modems. The VAX LSI-11 remote port operates in accordance with CCITT V.24, V.21, and V.28 recommendation. It has B.P.O. approval in the U.K. and F.T.Z approval in Germany.

Appendix A provides interface specifications which will be especially useful for option and modem installation and maintenance in the U.K. and Europe. The BC99N modem cable has protective diodes which must be used in the U.K.; it is not provided in the option kit, but is added in the U.K. before the kit is shipped to the customer site.

#### 4.2.6 Site Management Guide

The Site Management Guide must be updated when remote diagnosis is added to the system. The binder includes a divider titled "XI. Remote Diagnostic Console (RDC)". A single sheet, "VAX-11/780 Remote Diagnosis Preparation", EK-11780-DC, should be filed behind that divider. Figure C-2 is a copy of the document.

### 4.3 THE KC780 FAMILY REMOTE DIAGNOSIS KITS

Three KC780 option kit variations are available:

- KC780-BA for installation in the United States.
- KC780-DA for installation in the U.K. and Europe.
- KC780-EA for installation in Canada.

Two KC782 option kit variations are available:

- KC782-AA for installation in the United States and Canada.
- KC782 DA for installation in the U.K. and Europe.

Two KC785 option kit variations are available:

- KC785-BA for installation in the United States and Canada.
- KC785-DA for installation in the U.K. and Europe.

For KC780 and KC782 only:

Figure 4-1 shows the KC780/KC782 option kitting scheme and includes a diagram of system interconnection. That figure is provided to show the special relationship between the KC780 and KC782 kits.

Figure 4-2 identifies each kit component by description, part number, and the quantity included in each kit.

#### NOTE

The KC780 Family option remains the property of Digital Equipment Corporation; it is not for sale. A DIGITAL asset tag is attached to the BC03L-05 cable during installation. The asset number on that tag is used for capital equipment inventory purposes.

#### 4.3.1 Opening the Kit

Carefully open the shipping container and remove the option components. Check each component for possible damage. If any damage is present, it should be reported to the branch office supervisor; if there are indications of shipping damage, that should be reported to the responsible carrier also.

For KC780 and KC782 only:

Determine that the kit is complete by verifying it against Figure 4-2. Determine that the diagnostic diskette set is compatible with the VAX-11/780 hardware/system revision level according to Table 4-2. The system identification message printed during console program booting indicates the VMS version and reports any FLPA-WCS mismatch.



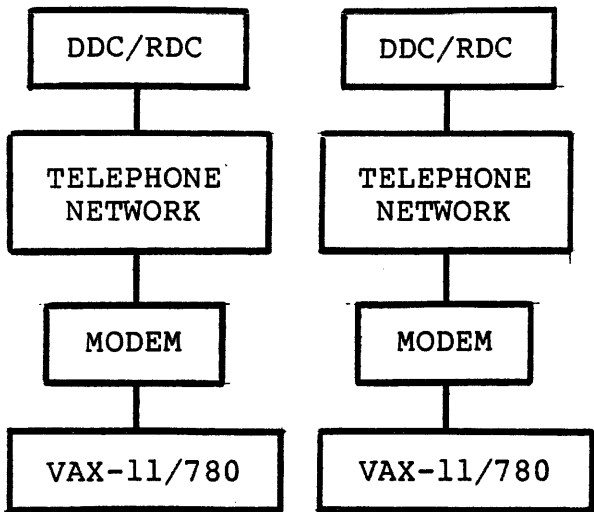

Remote Diagnosis For Two Independent VAX-11/780 Systems

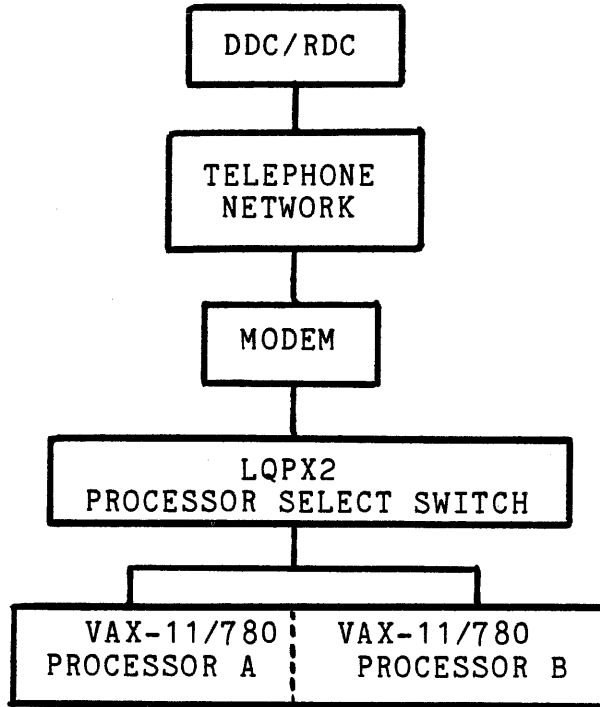

Remote Diagnosis For Two VAX-11-780'S Connected as a VAX-11/782 System

FOR:	USE KIT:	CONTAINS:
An independent VAX-11/780 system.	KC780-BA KC780-DA KC780-EA	All hardware required for one VAX-11/780 system.
Processor A of a VAX-11/782 system.	KC780-BA KC780-DA KC780-EA	All hardware required for VAX-11/780 Processor A in a VAX-11/782 system.
Processor B of a VAX-11/782 system.	KC782-AA	All hardware required for VAX-11/780 Processor B when Processor A has a KC780-BA or KC780-EA.
Processor B of of a VAX-11/782 system.	KC782-DA	All hardware required for VAX-11/780 Processor B when Processor A has a KC780-DA.

Figure 4-1 KC780 / KC782 Kitting Scheme

	DESCRIPTION	QUANTITY PER KIT							
		-BA	KC780			KC782		KC785	
			-DA	-EA	-AA	-DA	-BA	-DA	
	M8017-00 or M8017-AA module	1	0	1	1	0	0	0	
	M8017-AA or M8017-YB module	0	1	0	0	1	0	0	
	M8017-AA module	0	0	0	0	0	1	1	
	M7944 module (MSV11-B) 4K memory  OR  M8044-EA module (MSV11-DE) 48KB Memory  *See Note on Page 4-13.	0	1*	0	0	1*	0	0	
	DF02, DF03, or 30-15949 Stand-alone modem	1	0	0	0	0	1	0	
	LQPX2 Processor Select Switch	0	0	0	1	1	0	0	

Figure 4-2 KC780 Family Option Kit Contents



	DESCRIPTION	QUANTITY PER KIT								
		KC780			KC782		KC785			
		-BA	-DA	-EA	-AA	-DA	-BA	-DA		
	BC05D-25 or BC22F-25 EIA Extension Cable (25' long)	1	1	1	0	0	0	0		
	BC22F-25 only EIA Extension CABLE (25' long)	0	0	0	0	0	1	1		
	BC22F-10 EIA Extension Cable (10' long)	0	0	0	2	2	0	0		
	BC03L-05 Filtered Cable (5' long)	1	1	1	1	1	1	1		
	74-21885 Adapter Plate	1	1	1	1	1	1	1		
	ZE016CY Diagnostic Set	1	0	1	1	0	0	0		
	ZE022CY Diagnostic Set	0	1	0	0	1	0	0		

Figure 4-2 KC780 Family Option Kit Contents (continued)

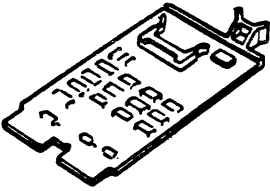
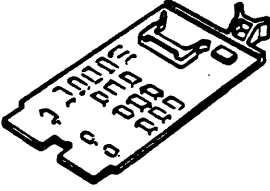
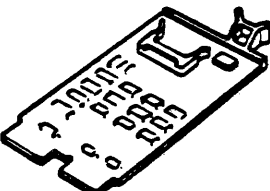
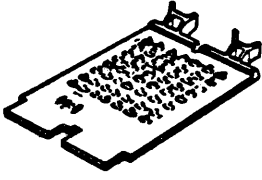
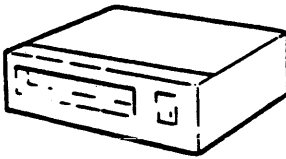
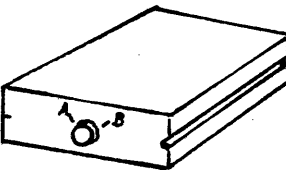

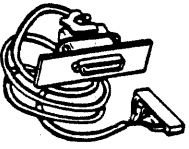
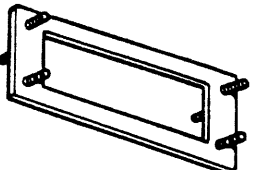
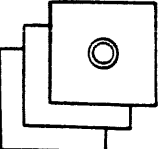
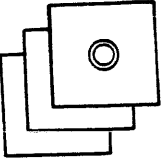

	DESCRIPTION	QUANTITY PER KIT						
		KC780			KC782		KC785	
		-BA	-DA	-EA	-AA	-DA	-BA	-DA
	Mounting Hardware Package	1	1	1	1	1	1	1
	H315 Modem Test Adapter	1	1	1	1	1	1	1
	DIGITAL Asset Tag	1	1	1	1	1	1	1
	EN-01392-07-N978 Installation Acknowledgement	1	0	1	1	0	0	0
	EN-01780-07-N978 Installation Acknowledgement	0	0	0	0	0	1	0
	EK-KC780-TM Technical Manual	1	1	1	1	1	1	1
	EK-KC780-UG User Guide	1	1	1	1	1	1	1

Figure 4-2 KC780 Family Option Kit Contents (continued)

Table 4-2 KC780/VAX-11/780 Compatibility (Does not apply to KC785)

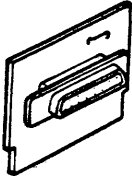
RD Console Diskette Revision	V5.00-C V5.00-R *	V5.00-C V5.00-R *	V5.00-C V5.00-R *	V5.00-C V5.00-R *	V5.00-C V5.00-R *	V7.00-C V7.00-R *	V7.00-C V7.00-R *	V7.00-C V7.00-R *
VMS Release	1.5, 1.6	2.0	2.0	2.0, 2.1	2.0, 2.1	2.0, 2.1, 2.2, 2.3	2.3, 2.4, 2.5	2.3, 2.4, 2.5
11/780 Hardware Revision	01	03	03A	04	05	06, 06A	06, 06A	07
ZZ-EVNDX Diagnostic Revision	P or R	R, S, T, or U	R, S, T, or U	V,W,X,Y,Z, or 1.0	V,W,X,Y,Z or 1.0	3.0	3.0	4.0
M8224 CS REVISION	C	D	D	D	D	D	D	F
M8235 CS Revision and FPLA Sockets	H 3	H1,K 3	H1, K 3	J1, L 3	J1, L 3	J1, L 3	J1, L 3	H3, M 3
FPLA'S REQUIRED	23-021C6 23-022C6	23-021C6 23-039C6	23-021C6 23-039C6	23-021C6 23-039C6 23-058C6	23-021C6 23-039C6 23-058C6	23-021C6 23-039C6 23-058C6	23-021C6 23-039C6 23-058C6	23-066C6 23-067C6 23-068C6
WCS Version and Filename	0A-13 WCS118.PAT	0C-11 WCS120.PAT	0C-11 WCS120.PAT	0D-12 WCS122.PAT	0D-12 WCS122.PAT	0D-12 WCS122.PAT	0D-13 WCS123.PAT	0E-10 WCS124.PAT
SYSID Jumpers Required ?	No**	Yes	Yes	Yes	Yes	Yes	Yes	Yes

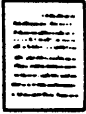
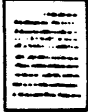
\* The -C suffix indicates CCITT operation; -R indicates U.S.A. operation.

\*\* The System Identity Register jumpers are not needed for booting VMS release 1.5 or 1.6, however, they are needed for release 1.6 to enable the error logger.

## NOTE

For KC780-DA and KC782-DA in the U.K. and Europe

The kit you receive may not have an M7944 or M8044-EA module.

BEFORE MAY 1984 - 11/780 systems had an M7944 4K memory module in LSI-11 Slot 3, Row A/B. The KC780-DA and KC782-DA kits added a second M7944 in Slot 3, Row C/D. (See Figures 4-4 and 4-5)

SINCE MAY 1984 - All 11/780 family systems are being shipped with an M8044-EA 48KB memory module in LSI-11 Slot 3, Row A/B instead of the M7944.

KC780-DA and KC782-DA options can be installed on systems which have an M7944 in LSI-11 Slot 3, Row A/B, either by replacing it with an M8044-EA or by adding the second M7944 (the module is to be obtained locally if it is not provided in the kit). Systems which have an M8044-EA in Slot 3, Row A/B do not require any additional memory when these options are added.

### 4.4 STEP-BY-STEP INSTALLATION PROCEDURE

This procedure provides instructions for the installation of KC780 Family option kits as follows:

- o In the United States KC780-BA      KC782-AA      KC785-BA
- o In Canada                      KC780-EA      KC782-AA      KC785-BA
- o In the U.K. & Europe KC780-DA      KC782-DA      KC785-DA

On the following pages, there is a formatted header block at the right of each instruction step number . Each box in the header block is reserved for a particular option kit variation. When the kit number is printed in its box, the instruction step must be performed. When the kit number box is blank, the step does not apply. Figure 4-3 may be used for an overview of KC780 Family option installation. The installation procedure references that figure as a source of specific installation detail.

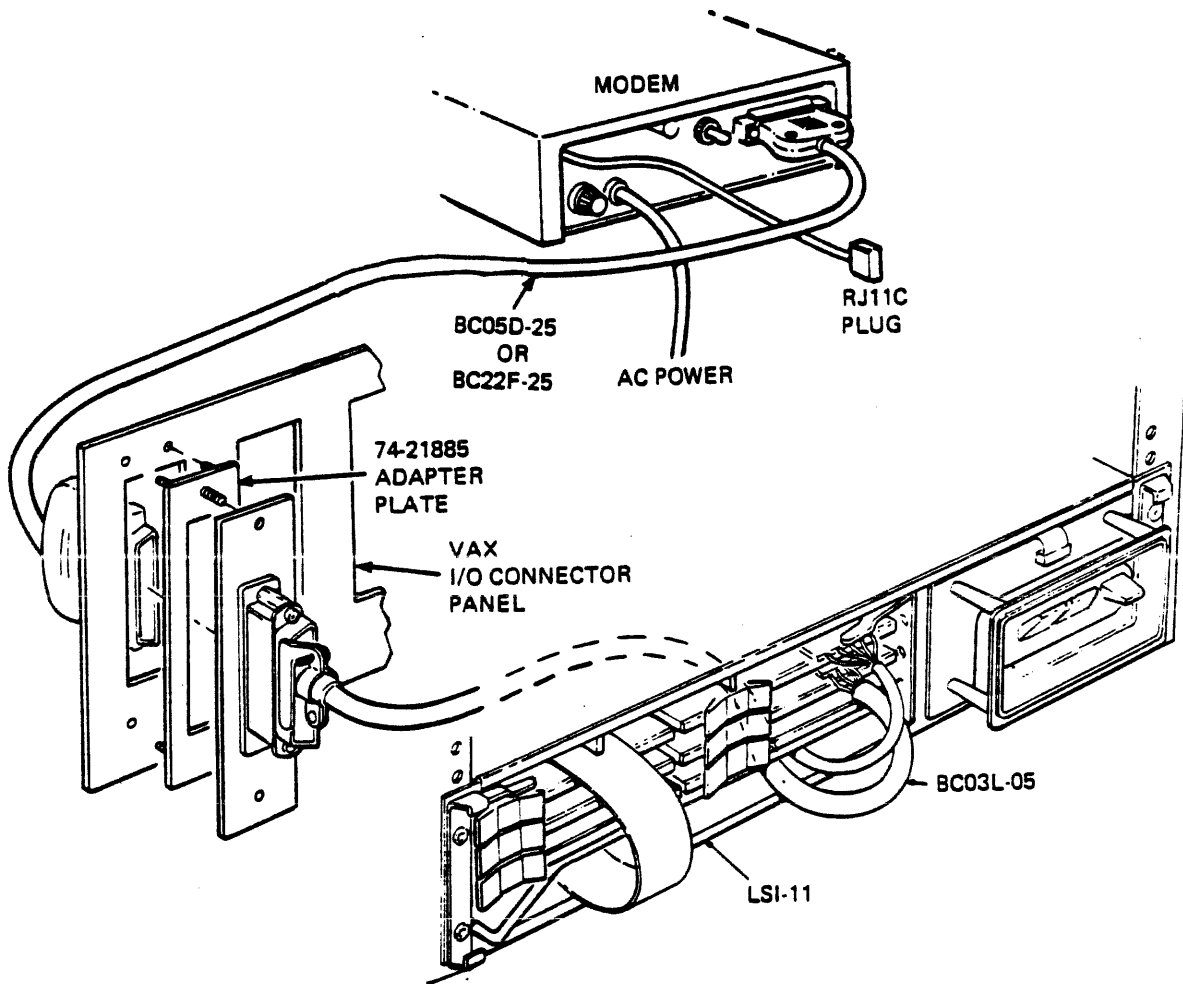
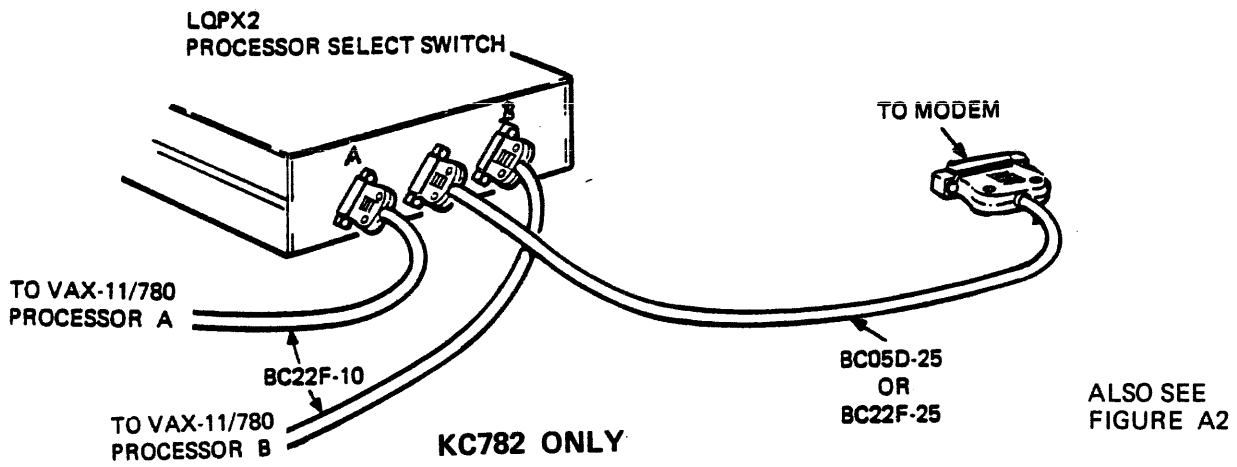

Figure 4-3 LSI-11 Hardware Configuration

ORIGINAL LSI-11 MODULE CONFIGURATIONS

ALL 11/780 and 11/782 SYSTEMS SHIPPED BEFORE MAY 1984

1	M7264 CPU MODULE				1
2	M7946		M7940		2
3	M7944		M9400-YE		3
4					4
	A	B	C	D	

ALL 11/780, 11/782, and 11/785 SYSTEMS SHIPPED AFTER MAY 1984

1	M7264-YC CPU MODULE				1
2	M7946		M7940		2
3	M8044-EA		M9400-YE		3
4					4
	A	B	C	D	

Figure 4-4 Original LSI-11 Module Configurations



LSI CONFIGURATIONS AFTER OPTION INSTALLATION

11/780 AND 11/782 SYSTEMS IN THE UNITED STATES AND CANADA

1	M7264 CPU MODULE (M7264-YC with M8044-EA)		1
2	M7946	M7940	2
3	M7944 or M8044-EA	M8017-00, -AA	3
4		M9400-YE	4
	A	B	C
			D

11/780 AND 11/782 SYSTEMS IN THE UNITED KINGDOM AND EUROPE

(OPTION INSTALLED WITH M7944 4K MEMORY MODULE)

1	M7264 CPU MODULE		1
2	M7946	M7940	2
3	M7944	M7944	3
4	M9400-YE	M8017-AA, -YB	4
	A	B	C
			D

11/780 AND 11/782 SYSTEMS IN THE UNITED KINGDOM AND EUROPE

(OPTION INSTALLED WITH M8044-EA 48KB MEMORY MODULE)

1	M7264-YC CPU MODULE		1
2	M7946	M7940	2
3	M8044-EA	M8017-AA or -YB	3
4		M9400-YE	4
	A	B	C
			D

Figure 4-5 LSI-11 Configurations With KC780 and KC782 Options

ORIGINAL LSI-11 MODULE CONFIGURATION

ALL 11/785 SYSTEMS

1	M7264-YC CPU MODULE				1
2	M7946		M7940		2
3	M8044-EA		M9400-YE		3
4					4
	A	B	C	D	

LSI CONFIGURATION AFTER OPTION INSTALLATION

ALL 11/785 SYSTEMS

1	M7264-YC CPU MODULE				1
2	M7946		M7940		2
3	M8044-EA		M8017-AA		3
4			M9400-YE		4
	A	B	C	D	

Figure 4-6 LSI-11 Configurations In 11/785 Systems

STEP 1

KC780	KC780	KC780	KC782	KC782	KC785	KC785
-BA	-DA	-EA	-AA	-DA	-BA	-DA

Perform the following preparatory steps before installation is begun:

- o Complete site preparation as described in Paragraph 4.2.
- o Examine kit contents as described in Paragraphs 4.3 and 4.3.1.
- o Verify correct system operation.

STEP 2

KC780	KC780	KC780	KC782	KC782	KC785	KC785
-BA	-DA	-EA	-AA	-DA	-BA	-DA

Call the DDC/RDC and confirm that the System Configuration Package (described in Paragraph 4.2.1) has been received and processed. They want to know when an option installation is in progress and if you will be requesting a system test (Paragraph 4.7) and/or a demonstration for customer personnel (Paragraph 4.8).

STEP 3

KC780	KC780	KC780	KC782	KC782	KC785	KC785
-BA	-DA	-EA	-AA	-DA	-BA	-DA

Prepare the M8017 (-00, -AA, -YB) module for installation using Table 4-3 and Figures 4-7 and 4-8. In addition to verifying the status of each jumper on the board, you must change the status of some of the jumpers. Those are indicated in Table 4-3 in the column titled "JUMPER REMOVED OR INSERTED AT FIELD INSTALLATION".

STEP 4

KC780	KC782
-DA	-DA

Do this step if you will be installing an M7944 4K memory module. (Do not do this step if you will be installing an M8044-EA module)

Prepare the M7944 (MSV11-B) for installation as shown in Figure 4-9.

Table 4-3 M8017-00, M8017-AA, and M8017-YB Jumper Configurations

KC780-C4 (007) 5/29/84

JUMPER STATE FROM FACTORY		JUMPER REMOVED OR INSERTED AT FIELD INSTALLATION	M8017-00	M8017-AA	M8017-YB	DESCRIPTION
IN	OUT					
A3	A4		X	X	X	These jumpers are for corresponding bits 3-12 of the address word. Device address 17756X is set. Bits 0, 1, and 2 are hardwired on the module to address the four device registers as follows: X=0 RCSR    X=4 XSCR X=2 RBUF    X=6 XBUF
	A5		X	X	X	
	A6		X	X	X	
A7			X	X	X	
A8			X	X	X	
A9			X	X	X	
	A10		X	X	X	
A11			X	X	X	
A12			X	X	X	
	V3	Insert V3	X	X	X	
	V4		X	X	X	
	V5		X	X	X	
V6			X	X	X	
V7			X	X	X	
	V8		X	X	X	

4-20

FOR 300 BAUD ONLY						
R0		Remove R0	X	X	X	This configuration sets the receiver and transmitter for 300 baud (enables common speed operation).
	R1	Insert R1	X	X	X	
R2		Remove R2	X	X	X	
R3			X	X	X	
T0		Remove T0	X	X	X	This configuration sets the transmitter to 300 baud. It is redundant to the "R" jumpers.
	T1	Insert T1	X	X	X	
	T2		X	X	X	
	T3	Insert T3	X	X	X	

FOR 1200 BAUD ONLY						
R0		Remove R0	X	X	X	This configuration sets the receiver and transmitter for 1200 baud (enables common speed operation).
	R1		X	X	X	
R2		Remove R2	X	X	X	
R3			X	X	X	

Table 4-3 M8017-00, M8017-AA, and M8017-YB Jumper Configurations (Continued)

JUMPER STATE FROM FACTORY IN OUT		JUMPER REMOVED OR INSERTED AT FIELD INSTALLATION	M8017-00	M8017-AA	M8017-YB	DESCRIPTION
FOR 1200 BAUD ONLY						This configuration sets the DF03 transmitter to 1200 baud. It is redundant to the "R" jumpers.
T0		Remove T0	X	X	X	
T1			X	X	X	
T2			X	X	X	
T3		Insert T3	X	X	X	
BG	P -E	Remove BG	X X X	X X X	X X X	Disable Break Generation Operation without parity Parity type - Does not apply when "P" is removed.
	1 2		X X	X X	X X	Operation with 8 data bits per character.
	PB		X	X	X	Programmable baud rate function disabled.
C C1			X X	X X	X X	Common speed operation enabled.
	S S1		X X	X X	X X	Split speed operation disabled.
	H		X	X	X	Halt on framing error disabled.
-B	B		X X	X X	X X	Boot on framing error disabled.
-FD			X	X	X	Data Terminal Ready is not forced continuously true.

KC780-C4 (007) 5/29/84

4-21

Table 4-3 M8017-00, M8017-AA, and M8017-YB Jumper Configurations (Continued)

JUMPER STATE FROM FACTORY		JUMPER REMOVED OR INSERTED AT FIELD INSTALLATION	M8017-00	M8017-AA	M8017-YB	DESCRIPTION
IN	OUT					
-FR			X	X	X	Request To Send is not forced continuously true.
RS			X	X	X	Request To Send is enabled
	FB		X	X	X	Force Busy is disabled.
	M, M1		X	X	X	Factory test jumpers. "M" does not exist on M8017-AA.
	M2, M3			X		Maintenance jumpers disabled
INIT	DCOK			X X		UART Clear signal enabled
SD1 to SD	SD1 to DS	No change required		X*		* FOR KC780-BA and KC780-EA DATA SET READY IS DISABLED SD1 to SD may be a jumper on Side 1 or an intact etch between those pins on Side 2.
SD1 to SD	SD1 to DS	Remove SD1 to SD. Insert SD1 to DS		X*		* For KC780-DA, KC785-BA, and KC785-DA. DATA SET READY IS ENABLED Change jumpers. Cut the etch on side 2 between SD1 and SD if it has not been cut.

Kc780-e4(007) 7/12/84

4-22

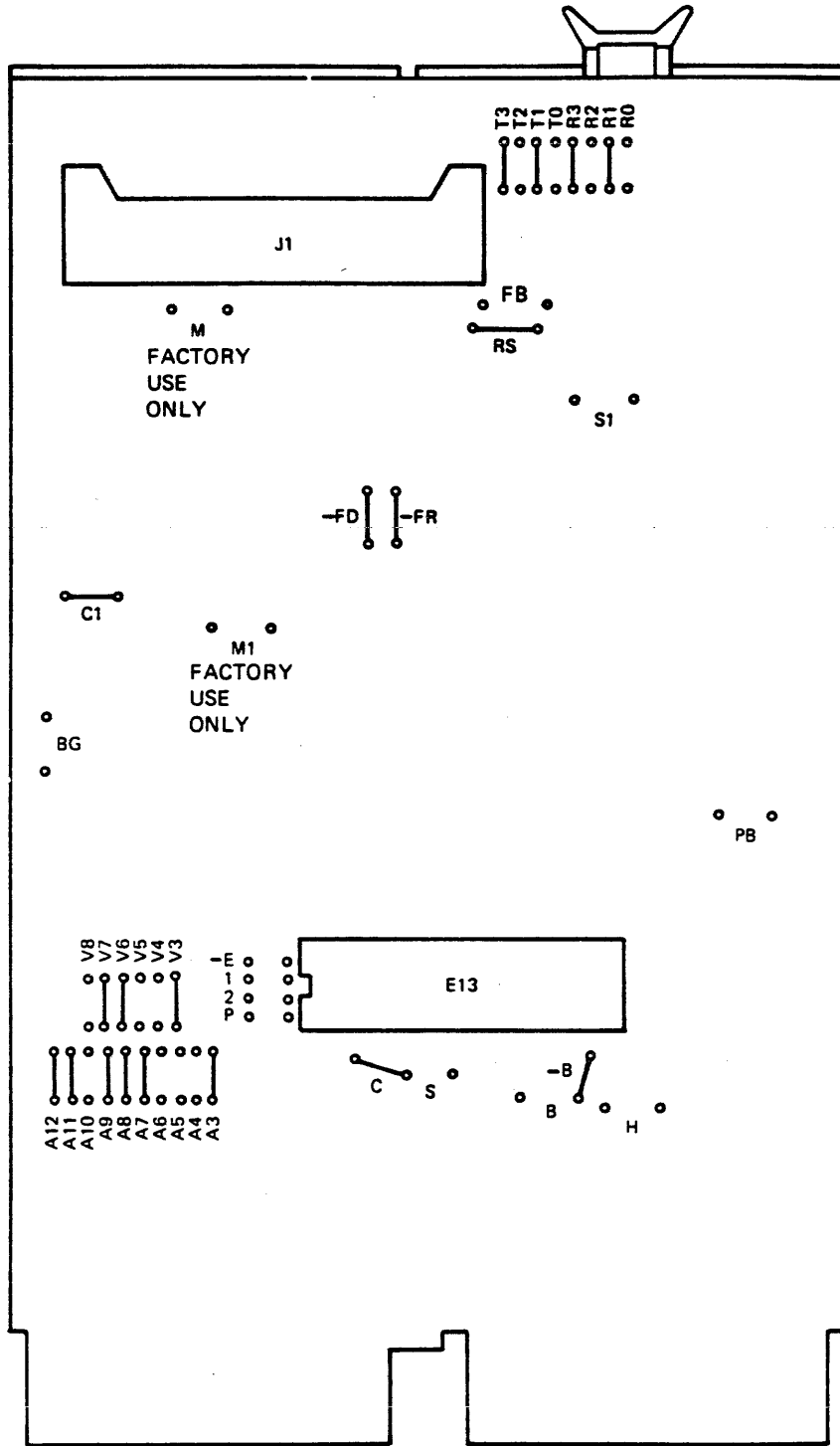

Figure 4-7 M8017-00, M8017-YB Jumper Configuration



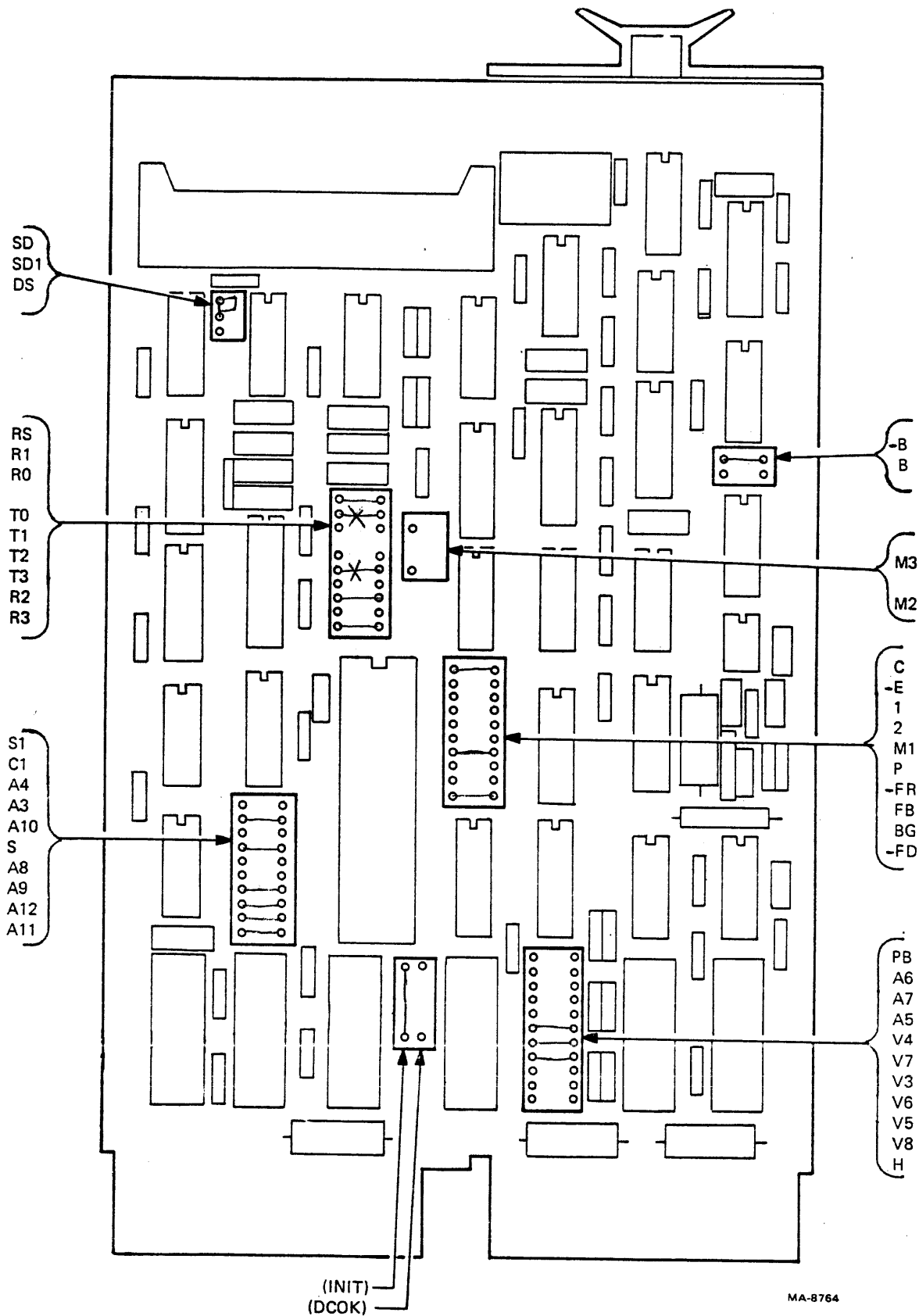
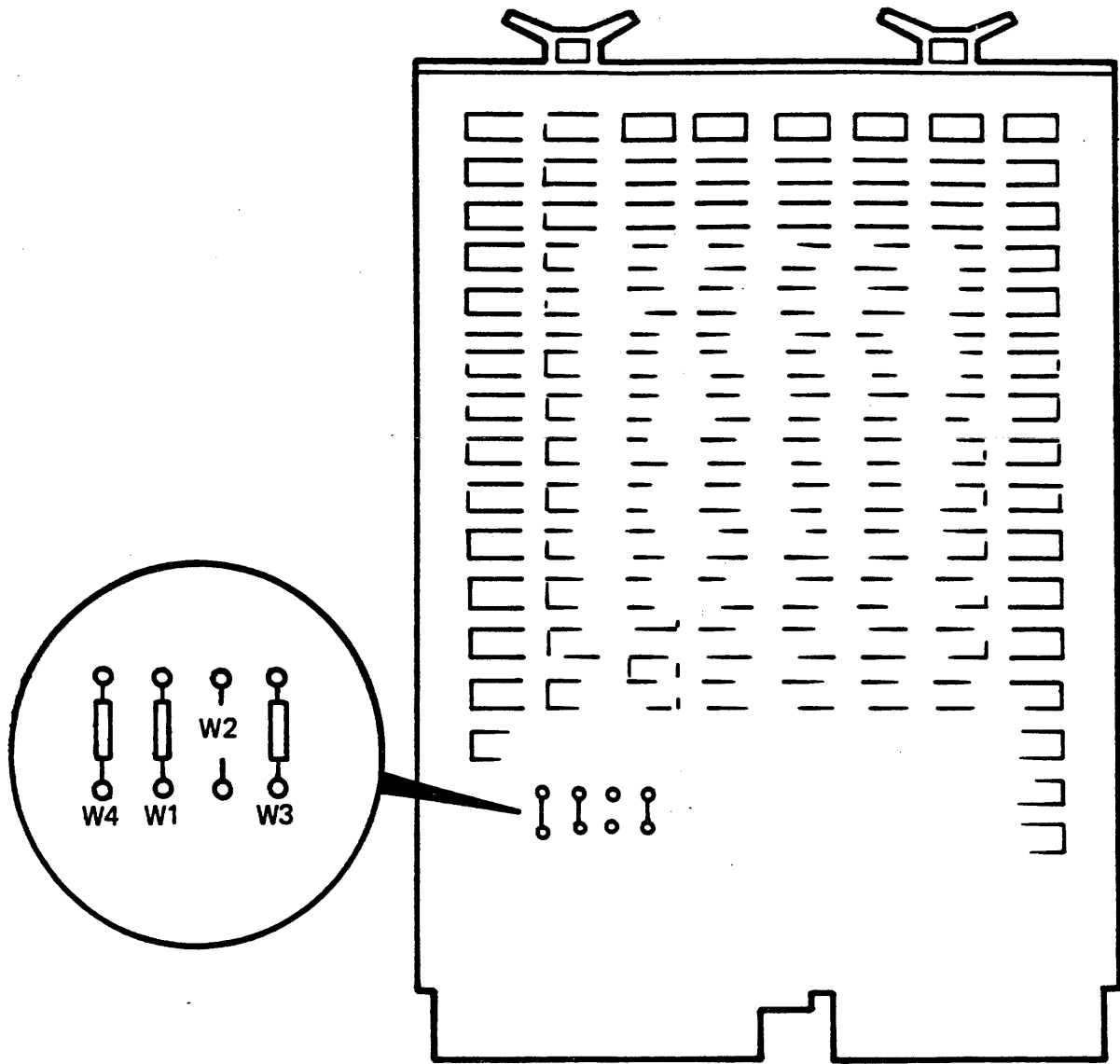

Figure 4-8 M8017-AA Jumper Configuration



JUMPER	IN/OUT	FUNCTION
W1	IN	MEMORY BANK SELECT 2 (40000-57776)
W2	OUT	
W3	IN	DISABLE BRPLY DURING REFRESH
W4	IN	

MA-6613

Figure 4-9 M7944 Jumpers for KC780-DA or KC782-DA

STEP 5

KC780	KC780	KC780	KC782	KC782	KC785	KC785
-BA	-DA	-EA	-AA	-DA	-BA	-DA

Refer to Figure 4-3. Check the universal I/O connector panel at the lower right rear of the VAX to determine if the 25-pin EIA connector on the BC03L-05 will mount directly to it. If not, attach the 74-21885 Adapter Plate to the cable, using two 6-32 kep nuts that are included in the mounting hardware package. On later systems, the cable should be mounted instead to the CPU I/O panel directly behind the LSI-11.

STEP 6

KC780	KC780	KC780	KC782	KC782	KC785	KC785
-BA	-DA	-EA	-AA	-DA	-BA	-DA

With two tie wraps, attach the DIGITAL Asset Tag to the BC03L-05 cable about four inches from the Berg connector.

STEP 7

KC780					KC785	
-BA					-BA	

Perform this step only if the modem in the kit is a model VA355P made by Racal-Vadic. Determine that switches 6 and 7 on SW B are in the closed (ON) position (Figure A-3). On most Racal-Vadic modems, these two switches will be in the open (OFF) position incorrectly.

The Racal-Vadic modem has a decal attached to the bottom surface of the unit. It provides information about setting jumpers and switches for modem operation options. The same information is in the vendor-published manual which is shipped with the unit. Since the cover must be removed to check the status of the two switches defined above, it is recommended that the status of other switch settings and jumpers be verified at the same time. Except for the two switches, all others should have been set correctly at the factory.

Appendix A of this manual includes additional general modem information.

#### STEP 8



Perform this step only if the modem in the kit is a model 103A3 made by General Data Comm Industries, Inc. Remove the modem cover and verify the status of option switches and jumpers. They should have been set correctly at the factory. Figure A-4 and the vendor-published manual both include the information needed to check the states of those options.

Appendix A of this manual includes additional general modem information.

CAUTION

FCC regulations prohibit the changing of certain data set configurations by customer personnel. Installation of solder straps or the cutting of printed circuit clads by any but an authorized GDC agent voids GDC's warranty on the equipment, and is strictly prohibited.

STEP 9



Perform this step only if the modem in the kit is a model DF02 or DF03 made by DIGITAL. The proper option states are preset at the factory; no on-site preparation is required. If the model to be installed is a DF03, press the HS switch on the control panel to the IN position to set 1200 baud operation. Figures A-5 and A-6 (for DF02) and Figures A-7 and A-8 (for DF03) and Table A-1 show the functions and the required states of the option selection jumpers. Both the DF02 or DF03 User Guide (shipped with the modem) and Appendix A of this manual provide additional information.

STEP 10

KC780	KC780	KC780	KC782	KC782	KC785	KC785
-BA	-DA	-EA	-AA	-DA	-BA	-DA

At this step, you will turn off system power and make the hardware accessible for the installation:

- a. Open the front doors to provide access to the LSI-11 at the lower left. Remove the left panel.
- b. Turn off power to the LSI-11.
- c. Turn the VAX keyswitch to OFF.
- d. Turn the ac circuit breakers at the lower left rear of the cabinet to OFF.
- e. Release the quarter-turn captive retaining screws that attach the blower plenum to the rear of the cabinet. Lift up on both sides of the panel to remove it. This exposes the rear of the LSI-11.
- f. Remove the bezel from the LSI-11 mounting box.

STEP 11

KC780	KC780	KC780	KC782	KC782	KC785	KC785
-BA	-DA	-EA	-AA	-DA	-BA	-DA

Disconnect the Berg connector/cable from the M7940 module in Slot 2, Row C/D of the LSI-11; leave the module in place. Marking this console terminal cable may avoid confusing it with the remote cable which will be installed in Step 16.

The following steps which include module insertion or position changes refer to the LSI-11.

STEP 12



Move the M9400-YE module from Slot 3, Row C/D to Slot 4, Row C/D.

STEP 13



Install the M8017-00 or -AA in Slot 3, Row C/D.

STEP 14



IF YOU WILL BE INSTALLING AN M7944 (4K) MEMORY MODULE -

- Move the M9400-YE module from Slot 3, Row C/D to Slot 4, Row A/B.
- Install the M7944 module in Slot 3, Row C/D.
- Install the M8017-AA or -YB in Slot 4, C/D.

IF YOU WILL BE INSTALLING AN M8044-EA (48KB) MEMORY MODULE -

- a. Move the M9400-YE module from Slot 3, Row C/D to Slot 4, Row C/D.
- b. Remove the M7944 module from Slot 3, Row A/B.
- c. Install the M8044-EA in Slot 3, Row A/B.
- d. Install the M8017-AA or -YB in Slot 3, Row C/D.
- e. If the M7264 LSI-11 CPU module (Slot 1, Row A/B/C/D) is not a -YC, rework it as follows:

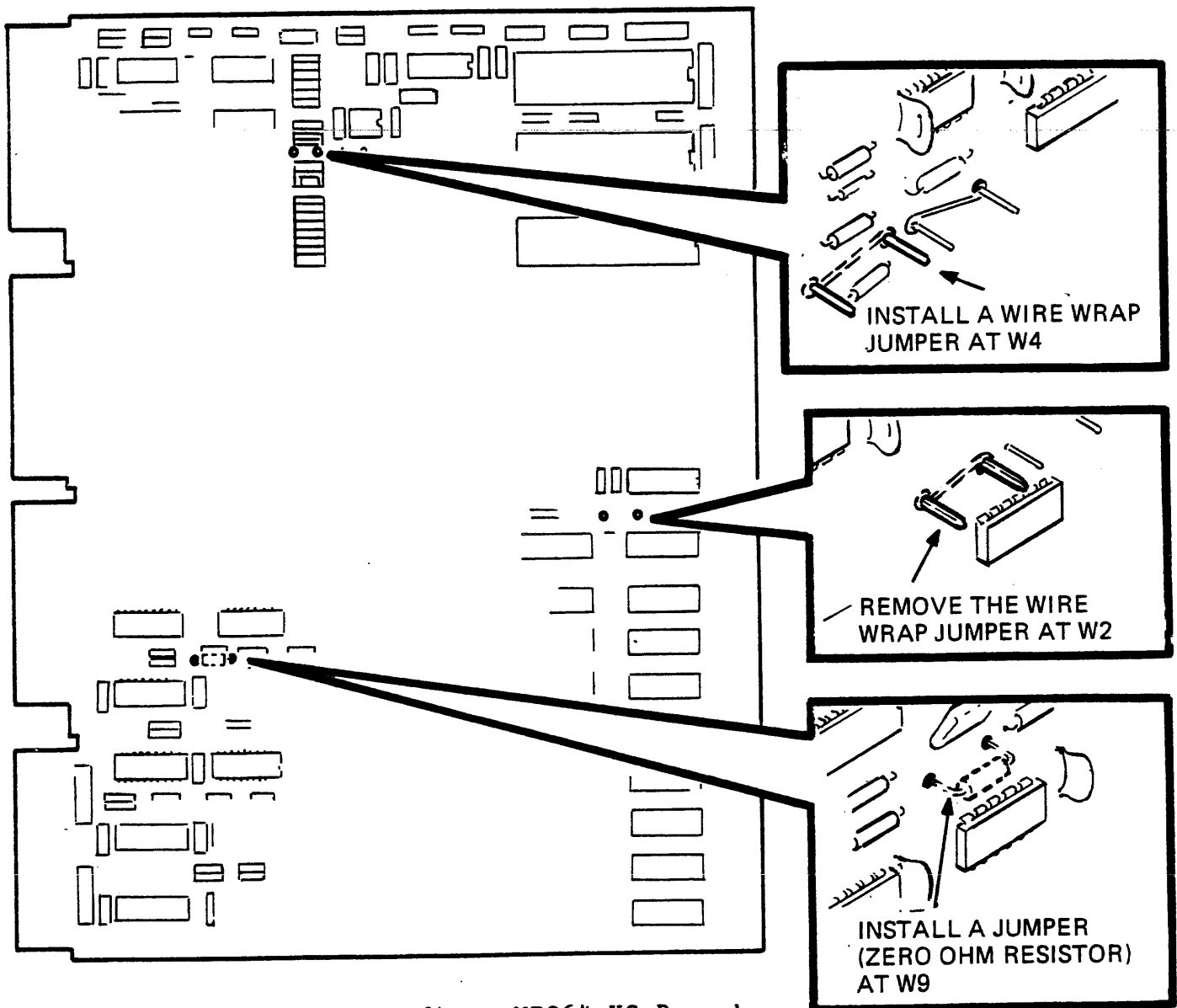

Figure 4-10 M7264 to M7264-YC Rework

MA-0600-84



STEP 15

KC780	KC780	KC780	KC782	KC782	KC785	KC785
-BA	-DA	-EA	-AA	-DA	-BA	-DA

Dress the BC03L-05 cable through the opening under the LSI-11 module (near the power supply), out through the back, and to the I/O connector panel. Plug the Berg connector into the M8017 module, making certain that the "THIS SIDE UP" label is away from the side 1 surface of the board.

STEP 16

KC780	KC780	KC780	KC782	KC782	KC785	KC785
-BA	-DA	-EA	-AA	-DA	-BA	-DA

Connect the Berg connector (which was disconnected in Step 11) to the M7940 module in Slot 2, row C/D.

STEP 17

KC780	KC780	KC780	KC782	KC782	KC785	KC785
-BA	-DA	-EA	-AA	-DA	-BA	-DA

Attach the BC03L-05 25 pin EIA connector (with the adapter plate if needed) to the I/O connector panel at the lower right rear of the VAX-11/780. Four 6-32 kep nuts are included in the mounting hardware kit for this purpose. On later systems, the cable should be mounted instead to the CPU I/O panel directly behind the LSI-11.

STEP 18

KC780	KC780	KC780	KC782	KC782	KC785	KC785
-BA	-DA	-EA	-AA	-DA	-BA	-DA

At this step all KC780 option hardware which mounts within the processor cabinet has been installed.

- a. Install the blower plenum and fasten it.
- b. Install the LSI-11 bezel.
- c. Install the left panel.

STEP 19

KC780	KC780	KC780	KC782	KC782	KC785	KC785
-BA	-DA	-EA	-AA	-DA	-BA	-DA

Put the modem in the location prepared for it (Appendix D may apply). Note that there must be a separate ac power source for the modem. Connecting the modem to the 869 Power Distribution Box is a violation of U.L. and other regulations and of system power integrity. Connect the analog output cable from the modem into the telephone data jack (e.g., RJ11C in the United States).

STEP 20

KC780	KC780	KC780	KC782	KC782	KC785	KC785
-BA	-DA	-EA	-AA	-DA	-BA	-DA

- o IF THE SYSTEM IS AN INDEPENDENT VAX-11/780:

Connect the BC05D-25 or BC22F-25 cable to the BC03L-05 connector that you mounted to the I/O connector panel in Step 17. Run the BC05D-25 or BC22F-25 cable to the modem and connect it there. (For installation in the U.K. see note which follows.)

- o IF THE SYSTEM IS A VAX-11/782:

Position the LQPX2 processor select switch on top of the VAX-11/782. Connect a BC22F-10 cable from each VAX-11/780 I/O panel to the switch. Connect the BC05D-25 or BC22F-25 cable from the switch to the modem. (For installation in England, see note which follows.)

NOTE

For installation in the U.K., a BC99N cable (which has protective diodes) must be installed to isolate any user device from the telephone network. A BC99N cable is added to each KC780 Family option kit in the U.K. before it is shipped to the customer site.

For a VAX-11/780 or 11/785 system, connect the BC99N cable between the processor I/O panel and the modem. The BC05D-25 or BC22F-25 cable can be used as an extension between the BC99N and the processor I/O panel.

For a VAX-11/782 system, connect the BC99N between the modem and the LPQX2 processor select switch. The BC05D-25 or BC22F-25 cable can be used as an extension between the BC99N and the LPQX2 switch.

STEP 21

KC780	KC780	KC780	KC782	KC782	KC785	KC785
-BA	-DA	-EA	-AA	-DA	-BA	-DA

At this step, all option hardware installation is complete. You can now restore system power and perform preliminary system testing:

- a. Turn the ac circuit breakers at the lower left rear of the cabinet to ON.
- b. Power up the LSI-11. For KC780-DA in Europe, and for all KC785's, the line time clock (LTC) switch must be on.
- c. For VAX-11/780 and 11/782: Mount the Remote Console diskette RX4 (RX41 in Europe) in the RX01.

For VAX-11/785: Mount the System Console diskette RX1A in the RX01.

- d. Power up the VAX system by turning the keyswitch to the LOCAL position.
- e. Check the system identification message and verify that the Console Version is as follows:

For VAX-11/780 and 11/782: V7.00-C (CCITT) or V7.00-R (U.S.A.) or later. Reference Table 4-3 for compatibility details.

For VAX-11/785: V06-00-C or later.

- f. Examine memory location 0 to verify correct operation at the local console terminal.

- g. Boot VMS and log into the Field Service account (the BOOT switch may not work at this time because DEFBOO.COM is not set-up yet).
- h. Check the following in the [SYSMAINT] directory:
  - 1. CONFIG.COM is assembled correctly for this system.
  - 2. DIAGBOOT.EXE is contiguous; if not, do the following:
    - a. \$COPY/CONTIG DIAGBOOT.EXE DIAGBOOT.EXE
    - b. \$PURGE [SYSMAINT]
  - 3. See that all the necessary diagnostics are present for the indicated release.

#### NOTE

If the customer's system pack is not to be used for remote diagnosis because it has confidential or vital data, then a separate Field Service VMS pack should be prepared. For remote diagnosis it will be mounted (and write protected) in place of the customer's pack.

#### 4.5 MODEM TEST

Perform a preliminary test of the modem and dedicated telephone line as follows:

- a. Turn the VAX system keyswitch to REMOTE.  
For VAX-11/782: The LQPX2 processor select switch enables remote access to either processor A or B.

- b. If the modem is a DF03, make sure that the HS switch on the control panel is in the IN position (1200 baud).
- c. Determine that the modem has ac power. Set the modem switches for normal (not test) operation.
- d. From another telephone, dial the number of the dedicated telephone line. A ringing signal should be heard, followed by a carrier signal which indicates that the modem answered the call.
- e. Hang-up.

If this test cannot be completed successfully, refer to Paragraph A.5, Modem Troubleshooting.

#### 4.6 M8017 OFF-LINE TEST

MAINDEC-11-DVDVA is used to test operation of the M8017-00, -AA, or -YB module. The diagnostic is included on diskette ZJ-215-RY.

1. Power down the system.

#### NOTE

Always arrange for proper system shut-down with the customer before beginning any troubleshooting procedure.

2. Disconnect the modem cable from the I/O connector at the lower left rear of the VAX.

For VAX-11/782: The cable to be disconnected from the I/O connector goes to the LQPX2 processor select switch.

3. Plug the H315 modem test adapter into the I/O connector in place of the cable.
4. Power up the system; turn the keyswitch to LOCAL.
5. Load and run MAINDEC-11-DVDVA.
6. When the program has run successfully, the testing is complete.
7. Disconnect the H315 modem test adapter. Reconnect the cable which you disconnected in Step 2.

#### 4.7 DDC/RDC SYSTEM TEST

The DDC/RDC should be asked to check system operation following option installation. Call the DDC/RDC and perform the procedure in Paragraph 3.2 or in the KC780 and KC782 User Guide, Figure C-1, "When Maintenance Diagnostics are to be run by the DDC/RDC". You may want to ask site personnel to participate in the procedure.

#### 4.8 CUSTOMER INSTRUCTION

Following installation of the KC780 option, site personnel must be instructed in the use of the added remote diagnosis capability. The instruction includes:

1. Describe the added remote diagnosis hardware and functions. Inform them that normal system operation is unaffected and that their normal operating procedures are not changed. (Paragraph 4.8.1)

2. Review the contents of the User Guide (Figure C-1) and see that they post or file it where it will be easy to find. (Paragraph 4.8.2)
3. Add the "VAX 11/780 Remote Diagnosis Preparation" document (Figure C-2) to the Site Management Guide binder behind the RDC tab. (Paragraph 4.8.3)
4. Assist them in calling the DDC/RDC and helping with a remote diagnosis demonstration session. (Paragraph 4.8.4)

#### 4.8.1 Normal Operation Not Affected

The addition of remote diagnosis hardware does not affect system operation. Site personnel will not be required to change their normal day-to-day operating procedures. Keyswitch positions OFF, LOCAL, and LOCAL DISABLE will continue to be used exactly as before.

Instruction in the use of the now-functional keyswitch positions REMOTE and REMOTE DISABLE is required. The functions of these keyswitch positions are described in Paragraph 2.2.1. The only visible hardware addition is the modem. Site personnel will have little or no need to touch it, but they may want to monitor activity in its indicator lights during remote system testing.

#### 4.8.2 The User Guide

The Remote Diagnosis User Guide, Figure C-1, is a summary of site personnel involvement in remote diagnosis procedures. Review the document with them, type in the DDC/RDC telephone number, then put it where it will be easy to find when they need it (they may want extra photocopies of it).



The guide will help users with different levels of remote diagnosis experience:

- a. The user with little remote diagnosis experience or knowledge can call the DDC/RDC and be led step-by-step through the procedure.
- b. The user can expect that the DDC/RDC will ask the basic questions listed on Page 1, Steps 1 and 2, and be prepared to respond.
- c. The user may read the information on Page 2 and be prepared for an easier interaction with DDC/RDC personnel and the remote diagnosis procedure.

#### 4.8.3 The Site Management Guide

A document titled "VAX-11/780 Remote Diagnosis Preparation" is reproduced in this manual as Figure C-2. It is another source of information about working with the DDC/RDC and the user should be shown where it is filed in the Site Management Guide.

#### 4.8.4 DDC/RDC Demonstration Session

The most effective instruction, an on-line demonstration, should be considered an important step in each KC780 Family option installation. If site personnel were included in the initial DDC/RDC system test (Paragraph 4.7), that may have provided enough user instruction. If not, request that they help in a demonstration which you can schedule with the DDC/RDC.

Before a demonstration is started, see that site personnel understand operation of front panel controls, how to find and identify the diagnostic diskettes, and where to find information

about calling the DDC/RDC. They should be allowed to place the call to the DDC/RDC, load the diskettes, monitor the terminal, and perform other steps which are part of the remote diagnosis procedure. You may want to explain the activity in the modem indicator lights, but the modem does not need user attention except possibly to turn power on or off.

Site personnel who have received this instruction will be more confident about the remote diagnosis process. However, the DDC/RDC expects calls from users with little experience and will provide whatever help is needed. This is shown in the User Guide, Page 1 of Figure C-1, in which each of the five steps of the procedure begins "The DDC/RDC will . . . ."

#### 4.8.5 Installation Acknowledgement Form

As the final step in the KC780 Family option installation, you must have an authorized customer representative sign a receipt for the hardware. The customer also acknowledges that the hardware is the property of Digital Equipment Corporation. An Installation Acknowledgement Form, EN-01392-07-N978, is included in each KC780-BA and KC782-AA option kit for that purpose in the United States.

KIT	FORM NUMBER	FIGURE NUMBER
KC780-BA	EN01392-07-N978	4-11
KC782-AA	EN01392-07-N978	4-11
KC785-BA	EN01780-07-0000(7PJ)	4-12

Country-specific forms are used in countries other than the United States. The form is to be sent to the DDC/RDC after it has been filled-out and signed.

**digital**  
DIGITAL EQUIPMENT CORPORATION

VAX 11/780 REMOTE DIAGNOSIS INSTALLATION ACKNOWLEDGEMENT

I, the undersigned, acknowledge receipt of Remote Diagnosis Kit (KC780),  
Asset No. .... for use on VAX 11/780,  
Serial No. ....

I recognize that this Remote Diagnosis Kit always remains the property of Digital Equipment Corporation, and agree not to remove or tamper with any part of it, nor to disclose or make any part of it available to a third party.

I further acknowledge that I will allow Digital full and free access for the purpose of removal of the Diagnosis Kit and restoration of the system to its original condition if for any reason the Field Service Agreement should be terminated.

Computer System to be located at: \_\_\_\_\_

Company \_\_\_\_\_

Address \_\_\_\_\_

City \_\_\_\_\_ State \_\_\_\_\_ Zip Code \_\_\_\_\_

By Authorized Representative \_\_\_\_\_ Date \_\_\_\_\_

Title \_\_\_\_\_

EN-01392-07-N978(725)

White—Customer    Canary—Branch    Pink—D.D.C.

Figure 4-11 KC780 and KC782 Installation Acknowledgement Form



DIGITAL EQUIPMENT CORPORATION

11/785 REMOTE DIAGNOSIS INSTALLATION ACKNOWLEDGEMENT

I, the undersigned, acknowledge receipt of Remote Diagnosis Kit (KC 785),

Asset No. .... For use on 11/785

Serial No. ....

I recognize that this Remote Diagnosis Kit always remains the property of Digital Equipment Corporation, and agree not to remove or tamper with any part of it, nor to disclose or make any part of it available to a third party.

I further acknowledge that I will allow Digital full and free access for the purpose of removal of the Diagnosis Kit and restoration of the system to its original condition if for any reason the Field Service Agreement should be terminated.

Computer System to be located at: \_\_\_\_\_

Company \_\_\_\_\_

Address \_\_\_\_\_

City \_\_\_\_\_ State \_\_\_\_\_ Zip Code \_\_\_\_\_

By Authorized Representative \_\_\_\_\_ Date \_\_\_\_\_

Title \_\_\_\_\_

White -Customer Canary -Branch Pink -D.D.C.

EN-01780-07-00007P-A

Figure 4-12 KC785-BA Installation Acknowledgement Form

## 4.9 REMOVING A KC780 FAMILY OPTION

The following procedure must be performed when a KC780 Family option is removed from a VAX system.

### STEP 1

KC780	KC780	KC780	KC782	KC782	KC785	KC785
-BA	-DA	-EA	-AA	-DA	-BA	-DA

At this step you will turn off power to the system and make the hardware accessible for option removal:

- a. Open the front doors to provide access to the LSI-11 at the lower left. Remove the left panel.
- b. Power down the LSI-11.
- c. Turn the VAX keyswitch to OFF.
- d. Set the ac circuit breakers at the lower left rear of the cabinet to OFF.
- e. Release the quarter-turn captive retaining screws that attach the blower plenum to the rear of the cabinet. Lift up on both sides of the panel and remove it.
- f. Remove the bezel assembly from the LSI-11 mounting box.

STEP 2

KC780	KC780	KC780	KC782	KC782	KC785	KC785
-BA	-DA	-EA	-AA	-DA	-BA	-DA

Disconnect the Berg connector/cable from the M7940 module in Slot 2, Row C/D of the LSI-11; leave the module in place.

Note: Module position changes in the following steps are made within the LSI-11. Refer to Figures 4-2, 4-3, 4-4, 4-5, and 4-6 which show the various configurations of modules in the LSI-11 and identify all KC780 family option components.

STEP 3

KC780	KC780	KC780	KC782	KC782	KC785	KC785
-BA	-DA	-EA	-AA	-DA	-BA	-DA

Disconnect the Berg connector (BC03L-05 cable) and remove the M8017 (-00, -AA, or -YB) module from Slot 3, Row C/D or Slot 4, Row C/D.

STEP 4

KC780	KC782
-DA	-DA

If there is an M7944 in Slot 3, Row C/D, remove it.

STEP 5



If the option was installed with an M8044-EA module (48KB memory) added in Slot 3, Row A/B, remove the M8044-EA and replace it with an M7944 module (4K). (An M7944 may not be available when you are doing this; see note on page 4-13.)

STEP 6



If you replaced an M8044-EA with an M7944 in Step 5, rework the M7264-YC CPU module (Slot 1, Row A/B/C/D) as follows:

- Remove the jumper (0 ohm resistor) at W9.
- Remove the wire wrap jumper at W4.
- Install a wire wrap jumper at W2.

Figure 4-10 shows the locations of these jumpers.

STEP 7



Move the M9400-YE Slot 4, Row A/B or Slot 4, Row C/D to Slot 3, Row C/D.

STEP 8

KC780	KC780	KC780	KC782	KC782	KC785	KC785
-BA	-DA	-EA	-AA	-DA	-BA	-DA

Reconnect the Berg connector to the M7940 module in slot 2, row C/D (it was disconnected in Step 2).

STEP 9

KC780	KC780	KC780	KC782	KC782	KC785	KC785
-BA	-DA	-EA	-AA	-DA	-BA	-DA

Disconnect the modem cable from the I/O connector panel at the lower left rear of the CPU cabinet.

For VAX-11/782: The cable to be disconnected goes to the LQPX2 processor select switch.

STEP 10

KC780	KC780	KC780	KC782	KC782	KC785	KC785
-BA	-DA	-EA	-AA	-DA	-BA	-DA

Remove the BC03L-05 (with the 74-21885 adapter plate attached if it is present) from the I/O connector panel. Pull the Berg connector end of the BC03L-05 cable out of the LSI-11 and remove the cable assembly.



STEP 11



If the modem was provided by DIGITAL, disconnect it from ac power.

- a. Disconnect the BC05D-25 cable from the modem.

STEP 12

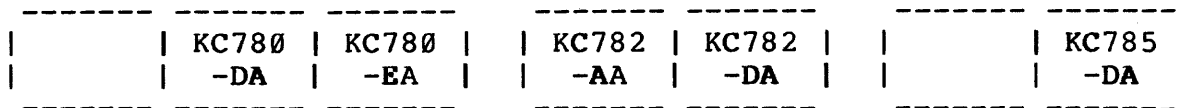

Disconnect the BC05D-25 (and/or the BC99N in the U.K.) from the modem.

STEP 13

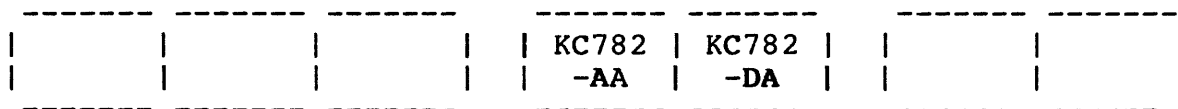

Remove the LQPX2 processor select switch and the three cables attached to it.

STEP 14

KC780	KC780	KC780	KC782	KC782	KC785	KC785
-BA	-DA	-EA	-AA	-DA	-BA	-DA

At this step the KC780 option hardware has been removed.

- a. Install the blower plenum and fasten it
- b. Install the LSI-11 bezel
- c. Install the left panel

STEP 15

KC780	KC780	KC780	KC782	KC782	KC785	KC785
-BA	-DA	-EA	-AA	-DA	-BA	-DA

Power up the system and perform routine testing to verify that the system is operating correctly.

STEP 16

KC780	KC780	KC780	KC782	KC782	KC785	KC785
-BA	-DA	-EA	-AA	-DA	-BA	-DA

Verify that you have all option components according to Figure 4-2. Verify specifically that the DIGITAL Asset Tag has been removed (it is usually attached to the BC03L-05 cable during installation). The kit components should be carefully packed and returned to the local Field Service office or the District Allocation Coordinator.

## 5.1 FIELD MAINTENANCE PHILOSOPHY

The KC780 Family option hardware includes either one module, or two, connecting cables, and, in the United States, a modem. Since field maintenance assumes module and modem swapping, servicing the option is not complex. Also, since the option is a remote port connection within a system, it is unlikely that an option component failure will affect system operation. Most failures will be discovered when the DDC/RDC attempts a connection. As a result, you will usually have their help when performing corrective maintenance on the option.

## 5.2 M8017 TEST

After running LSI-11 basic CPU and memory diagnostics, KC780 or KC782 troubleshooting should begin with the running of the M8017 Off-Line Diagnostic, MAINDEC-11-DVDVA as detailed in Paragraph 4.6. Failure of that test indicates a defective M8017 module:

- a. M8017 (-00 or -AA) LSI-11 Slot 3, Row C/D in KC780-BA, KC780-EA or KC782-AA in the United States and Canada.
- b. M8017 (-AA or -YB) in KC780-DA or KC782-DA in the United Kingdom and Europe -  
If the option was installed with an M7944 (4K memory), the M8017 will be in Slot 4, Row C/D.

If the option was installed with an M8044-EA (48KB memory), the M8017 will be in Slot 3, Row C/D

c. M8017-AA LSI-11 Slot 3, Row C/D in KC785.

You can troubleshoot the M8017 as follows:

#### NOTE

Always arrange for proper system shut-down with the customer before beginning any troubleshooting procedure.

CONTROL P

>>>HALT

>>>SET DEF OCTAL, WORD

>>>E/CONS 175610 ..... This is the M8017 CSR. Refer to the bit designation list which follows.

>>>SET DEF HEX.LONG .. Don't forget to do this when finished.

Bit 15	Dataset Interrupt	Bit 7	Receiver Done
Bit 14	Ring Indicator	Bit 6	Receiver Interrupt Enable
Bit 13	Clear To Send	Bit 5	Dataset Interrupt Enable
Bit 12	Carrier Detect	Bit 4	Not Used
Bit 11	Receiver Active	Bit 3	Not Used
Bit 10	Dataset Ready *	Bit 2	Request To Send
Bit 9	Not Used	Bit 1	Data Terminal Ready
Bit 8	Not Used	Bit 0	Not Used

\*Used only with M8017-AA and M8017-YB in KC780-DA, KC782-DA, and KC785-DA in the United Kingdom and Europe and KC785-BA in the United States.

### 5.3 MODEM SIGNAL CONTROL IN THE LSI-11

All LSI-11's (in 11/780's and 11/782's) shipped before April 1984 included a 4K RAM memory, M7944 module in Slot 3, Row A/B. Modem

signals were controlled by microcode on that module. The KC780-DA and KC782-DA options added a second M7944 4K memory module in Slot 3, Row C/D, which extended modem signal control capability as required for the European environment. Either of these modules may be suspected when modem interface failure indications are present.

The M7944 module has been replaced by an M8044-EA (48KB memory) in Slot 3, Row A/B in all LSI-11's (in 11/780's, 11/782's, and 11/785's) shipped since April 1984.

#### 5.4 MODEM FAILURE

Information about modem operation, testing, options, repair, and swapping can be found in Appendix A. Paragraph A.5, Modem Troubleshooting, may be useful when modem failure indications are present.

#### 5.5 FAILURE INDICATIONS

Table 5-1 is a compilation of reported failure indications which have been noted by the DDC/RDC.

##### 5.5.1 No System Identification Message

If there is no console message at power-up or booting

- a. Check to see that the keyswitch is in LOCAL.
- b. Check to see that LSI-11 modules are in the correct slots (Figures 4-4, 4-5, and 4-6).
- c. Check to see that modules are seated and that cable connectors are secure in their sockets.

## 5.5.2 DDC/RDC Not Able to Connect

- a. For KC780 or KC782: Check to see that the RX4 (RX41 in Europe) Remote Console diskette is booted in the LSI-11.

For KC785: No remote console diskette is required; load and boot Console Diskette RX1A.

- b. Check to see that the VAX keyswitch is in REMOTE.
- c. Check to see that the modem has power and that its cables are connected.
- d. Check to see that the M8017 (-00, -AA, -YB) module jumpers are configured correctly (Paragraph 2.3.1) and that the module is in the correct slot (Figures 4-4, 4-5, and 4-6).
- e. Perform the Modem Test, Paragraph 4.5.

Table 5-1 Troubleshooting KC780 Family Options

Indication	Probable Cause	Comments
DDC/RDC not able to connect.	Wrong telephone number.	Verify modem operation. Dial the number of the dedicated line. You should hear a ring signal, then a carrier signal.
DDC/RDC not able to connect.	Keyswitch not in REMOTE.	
DDC/RDC not able to connect.	Modem not set up properly.	Reference Paragraph A.4 and the vendor published operation manual.
DDC/RDC not able to connect.	Telephone line noise, etc.	Advise telephone company.
DDC/RDC not able to enter protocol.	Remote Console diskette not booted correctly.	RD diskette must be booted by turning LSI-11 power OFF, then ON.
DDC/RDC not able to enter protocol.	M8017 not set up correctly (or defective).	Refer to Paragraph 2.3.1. The M8017 Off-line test is documented in Paragraph 4.6.
DDC/RDC not able to enter protocol.	Modem not set up correctly (or defective).	Vadic modem must have Jumper B IN and switches B6 and B7 ON; reference Paragraph A.4.1.
Remote Access not supported.	Incorrect diskette in Drive 0 or not booted properly.	For KC780 and KC782 only: Diskette RX4 (RX41 in Europe) must be mounted on Drive 0 and booted by a power-down, power-up sequence; typing "BOOT" will not boot it.
Remote Access not supported.	Failure on M8236 CIB module.	Most signals related to remote logic are on CIB board.

GENERAL MODEM INFORMATION

A.1 INTERFACE TO COMMON CARRIER NETWORK

All KC780 Family installations are dependent on telephone lines for their remote diagnosis functionality. There are many modem and telephone hardware configurations, all controlled by government regulations which are not the same from country to country.

These remote diagnosis options are essentially identical. Because additional modem control signals are required in Europe, there is additional logic in the KC780-DA and KC782-DA options. Paragraph A.8 describes the operational characteristics required of modems that are used with DIGITAL remote diagnosis devices.

Figure A-1 shows the option-to-modem interface and identifies connector pin numbers and signal assignments.

Figure A-2 shows the M8017-to-modem configuration used for the KC780 Family options.

The M8017 remote port is connected to the modem through a BC03L-05 filtered cable (internal to the processor cabinet) in series with a BC05D-25 EIA extension cable.

When the option kit is installed in the U.K., use of the BC05D-25 EIA extension cable is optional. It may be used to extend the distance between the modem and the CPU an additional 25 feet.



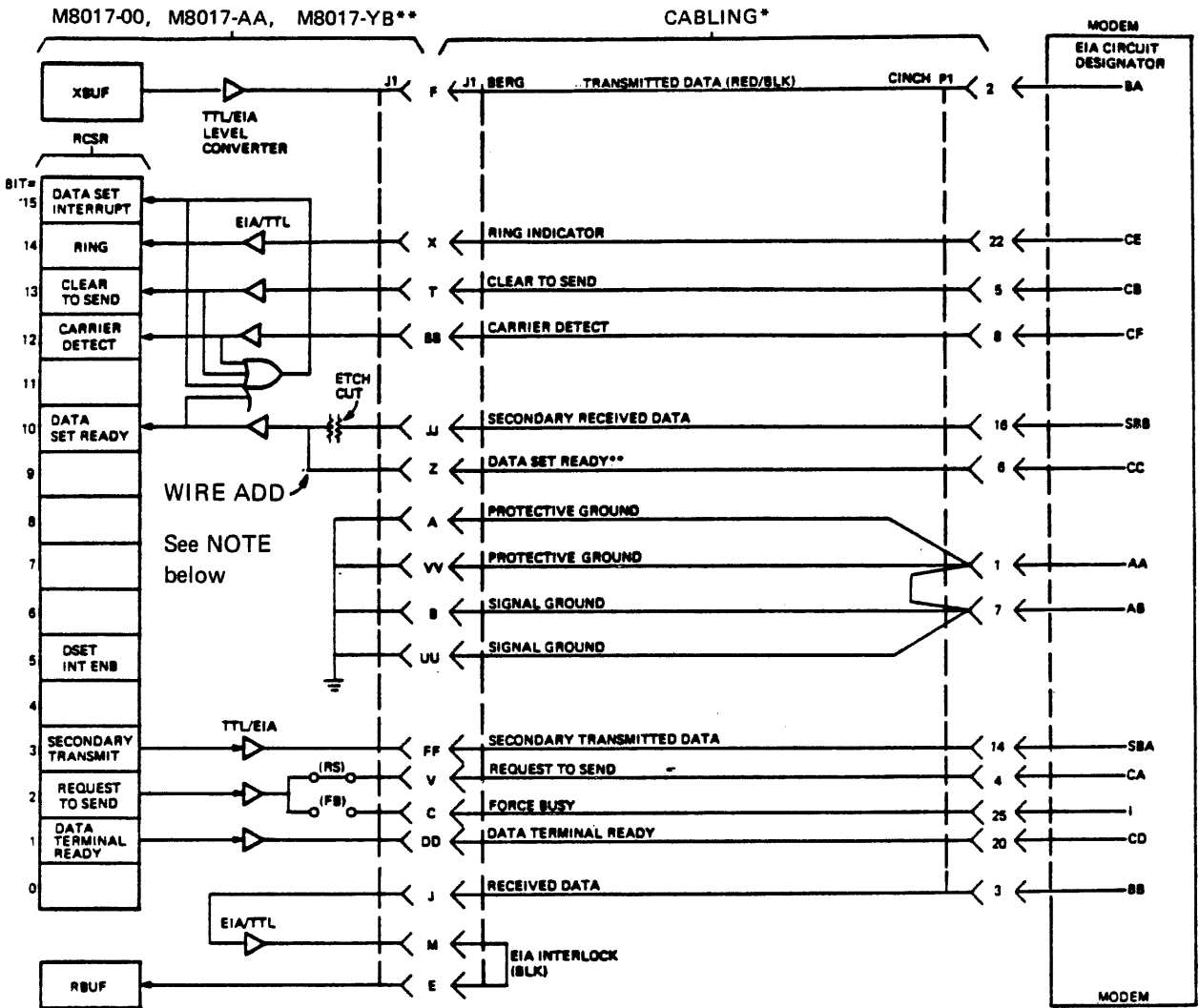

\* CABLING CONSISTS OF A BC03L08 FILTERED CABLE IN SERIES WITH A BC08N CABLE (WHICH INCORPORATES PROTECTIVE DIODES AND IS USED ONLY IN THE UNITED KINGDOM) AND/OR A BC09D-25 EXTENSION CABLE.  
 \*\*AN M8017 BECOMES AN M8017-YB WHEN DATA SET READY IS ADDED AS SHOWN.

NOTE -  
 WIRE ADD ON M8017-YB.  
 WIRE WRAP JUMPER ON M8017-AA

Figure A-1 M8017 (-00, -AA, -YB) Interface

VAX-11/780 and VAX-11/785

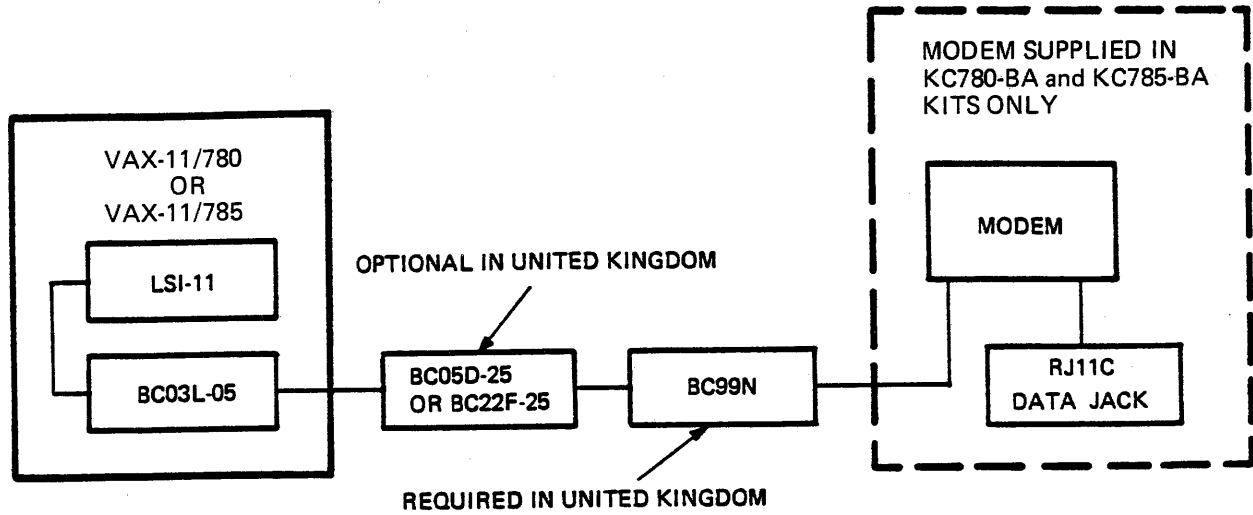

VAX-11/782

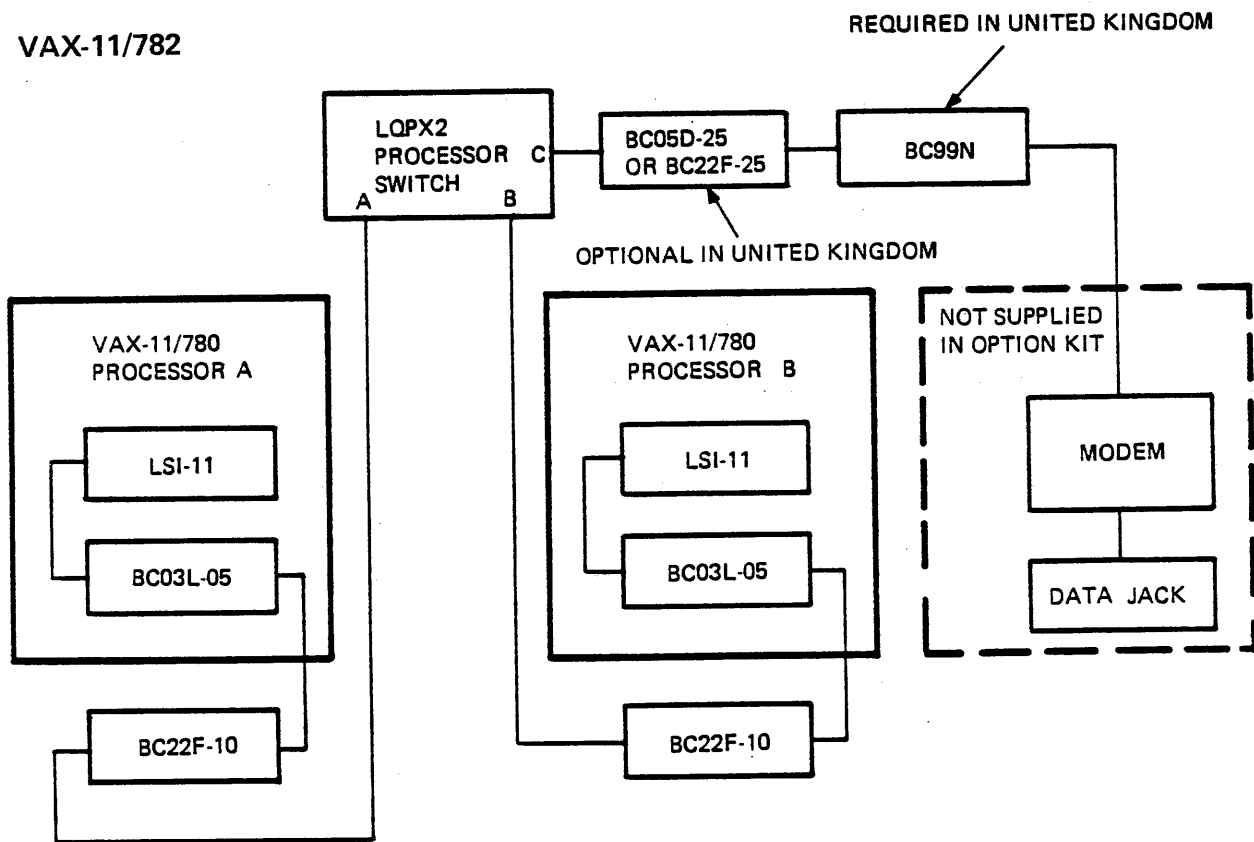

MA-0452-83

Figure A-2 Cabling Diagram

GPO regulations require that a cable with protective diodes be used to isolate the modem from the option connected to it. The BC99N cable, which is used for this purpose in the U.K., is added to the kit in the U.K. before it is shipped to the customer site.

## A.2 MODEMS - CANADA

The kits for installation in Canada are identical to those for the United States except that they do not include modems. In Canada, the customer must have the telephone company install a voice grade telephone line and a Bell 103AR modem (or equivalent). All arrangements and costs for the installation and maintenance of the line and modem are the responsibility of the customer.

Table A-1 shows modem option states required for option operation.

## A.3 MODEMS - EUROPE

European countries control the connection of data communications equipment to their public telephone networks in different ways. Connection approval must be requested through their telecommunications authorities such as the BPO in the U.K. and the FTZ in Germany. The KC780 Family options operate in accordance with CCITT .V24 and .V21 recommendations for interface sequences and CCITT .V28 recommendations for the electrical characteristics of binary interfaces and has received both BPO and FTZ approval.

Table A-1 Modem Option States

DESCRIPTION	PREDETERMINED STATE		
	ON STATE	OFF STATE	CONDITION
Originate/Answer	X		
Automatic/Answer	X		
Data Set Ready (CC) in Analog Loop	X		
Loss of Carrier Disconnect (LCD)		X	
Abort Timer (ABT): Shall allow Data Set Disconnects when handshaking does not take place. Delay Time: 17.0 Sec. minimum 30.0 Sec. maximum	X		
Receive Space Disconnect (RSD)		X	
Send Space Disconnect (Immediate)		X	
Transmit Reversals in Manual Analog Loop		X	
Answer Mode Indication (CE)		X	
Early Data Set Ready (CC) Indication: Shall cause Data Set Ready (CC) to be asserted when the "Modem" is connected to the switched network rather than when the called station's carrier is detected.	X		
Make Busy (CN Circuit)		X	
Fail safe State of CN		X	
Common Ringer		X	
RTS Control			DTE Mode
DTR Control			DTE Mode
Analog Loop			DTE Mode
Disconnect (Unattended)			DTE Mode
CB-CF (Com/Sep)			Shall be Separate
Grounding AA/AB COM/SEP			Shall be Common
Remote Telephone Operation (REM OPR)			Remote

When the kit does not include a modem, the modem must be provided by the telecommunications authority of the country in which installation is made. This manual, and this appendix specifically, describes the option-to-modem interface in sufficient detail to permit the installation of any compatible modem.

Table A-1 shows the modem option states required for KC780 Family option operation.

#### A.4 MODEMS - UNITED STATES

The KC780-BA and KC785-BA option kits, for installation in the United States, include a DIGITAL DF03 stand-alone modem (or DF02, or a vendor product, 30-15949). Stand-alone here means that it is not designed to be installed in a rack or other chassis.

These modems are factory-configured for remote diagnosis operation as defined by Digital Purchase Specification A-PS-3015949-0-0. Table A-1 shows the modem option states required for operation with the KC780 family options. Paragraph A.8 provides a signal level description of remote diagnosis modem operation, including call answering, establishing a logical connection, and call termination. In addition, each modem is shipped with a manual which has specific operating detail. Paragraphs A.4.1, A.4.2, and A.4.3 provide information which is specific to each of the four types of modems.

##### A.4.1 RACAL VADIC MODEM

The KC780-BA option kit may include a Racal Vadic modem, model VA355P, FCC registration number AJ496M-70263-DM-N. Field installation of this stand-alone unit includes a check to see that option jumpers and switches are correctly configured, plugging its cables into ac power and to the RJ11C data jack, and connecting the BC05D-25 digital I/O cable to it.

Figure A-3 indicates the IN/OUT, ON/OFF states of the jumpers and switches and shows their locations on the board. Most switches and jumpers will be correct as they were set at the factory, however, it is probable that switches B6 and B7 will be incorrectly set to the OFF position.

#### A.4.2 GDC MODEM

The KC780-BA kit may include a GDC modem, model 103A3, FCC registration number AG697J-62418-DM-E. Field installation of this stand-alone unit includes a check to see that option jumpers and switches are correctly configured, plugging its cables into ac power and to the RJ11C data jack, and connecting the BC05D-25 digital I/O cable to it.

Figure A-4 indicates the IN/OUT, ON/OFF states of the jumpers and switches and shows their locations on the board. All of the jumpers and switches will probably be correct as they were set at the factory.

#### A.4.3 DIGITAL DF02/DF03 MODEMS

The KC780-BA kit may include either a DF02 or DF03 modem (made by DIGITAL); The KC785-BA kit includes a DF03 modem. These modems have FCC registration numbers as follows: A0994Q-67693-DM-R for DF02 and A0994Q-69391-DM-R for DF03. Field installation of these stand-alone units involve only plugging its cables into ac power and to the RJ11C data jack, and connecting the BC05D-25 digital I/O cable into it. For the DF03 modem, the HS switch on the control panel should be set to the IN position (1200 b/s). The required option state jumpers are set at the factory; no on-site preparation of the modems are required.

RAYCAL-VADIC MODEM

OPTION JUMPER	JUMPER CONFIGURATION	
	IN	OUT
A		•
B	•	
C	•	
D		•
E		•
F	•	
G	•	
H	•	

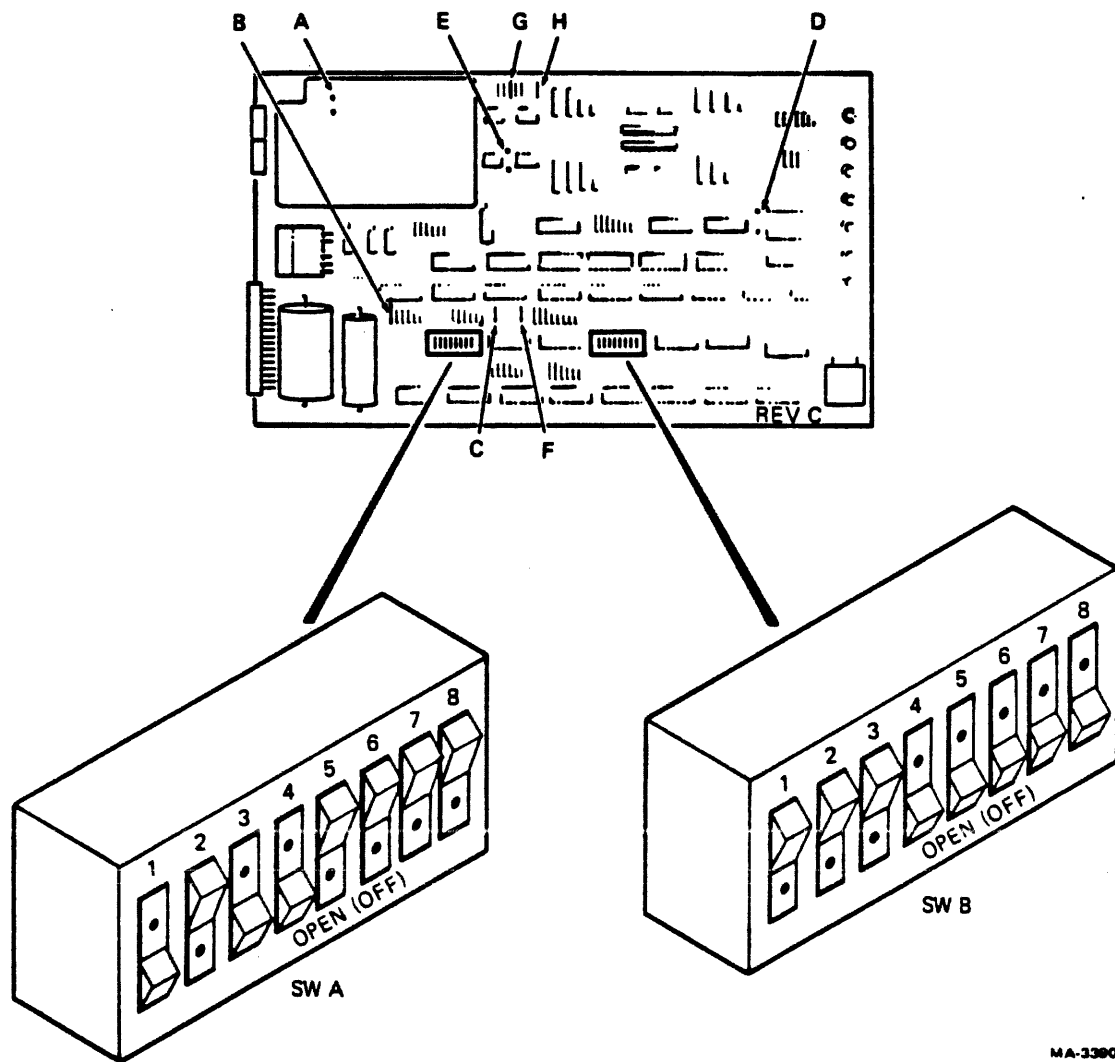

MA-3300A

Figure A-3 Racal-Vadic Switch and Jumper Configuration

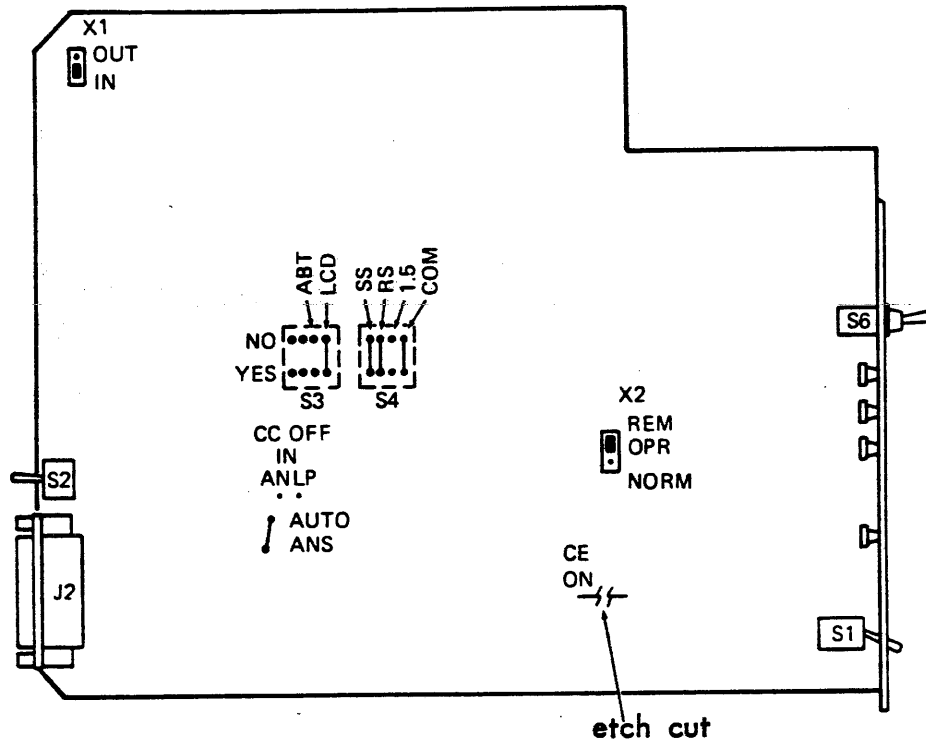

Figure A-4 GDC Jumper and Switch Configuration



Figures A-5 and A-6 indicate the locations of jumpers on the two DF02 boards. The DF02 Modem User Guide, EK-0DF02-UG, which is shipped with the modem, provides additional information about DF02 jumper configuration.

Figures A-7 and A-8 show locations of jumpers/switches on the two DF03 boards. The DF03 Modem User Guide EK-0DF03-UG, provides additional information about DF03 jumper configuration.

## A.5 MODEM TROUBLESHOOTING

Instruction manuals which are included with modems have troubleshooting and testing information. These provide specific instructions for setting-up test modes and explain test procedures. The information provided here is generally applicable to any modem which is compatible with the KC780 family remote diagnosis options.

The M8017 (-00, -AA, or -YB) may be tested off-line using MAINDEC-11-DVDVA which is resident on diskette ZJ-215-RY.

The basic modem test is:

- o Call the number of the dedicated telephone line.
- o Hear the ringing signal.
- o Hear the carrier signal (indicating that the modem has answered the call).
- o Hang-up.

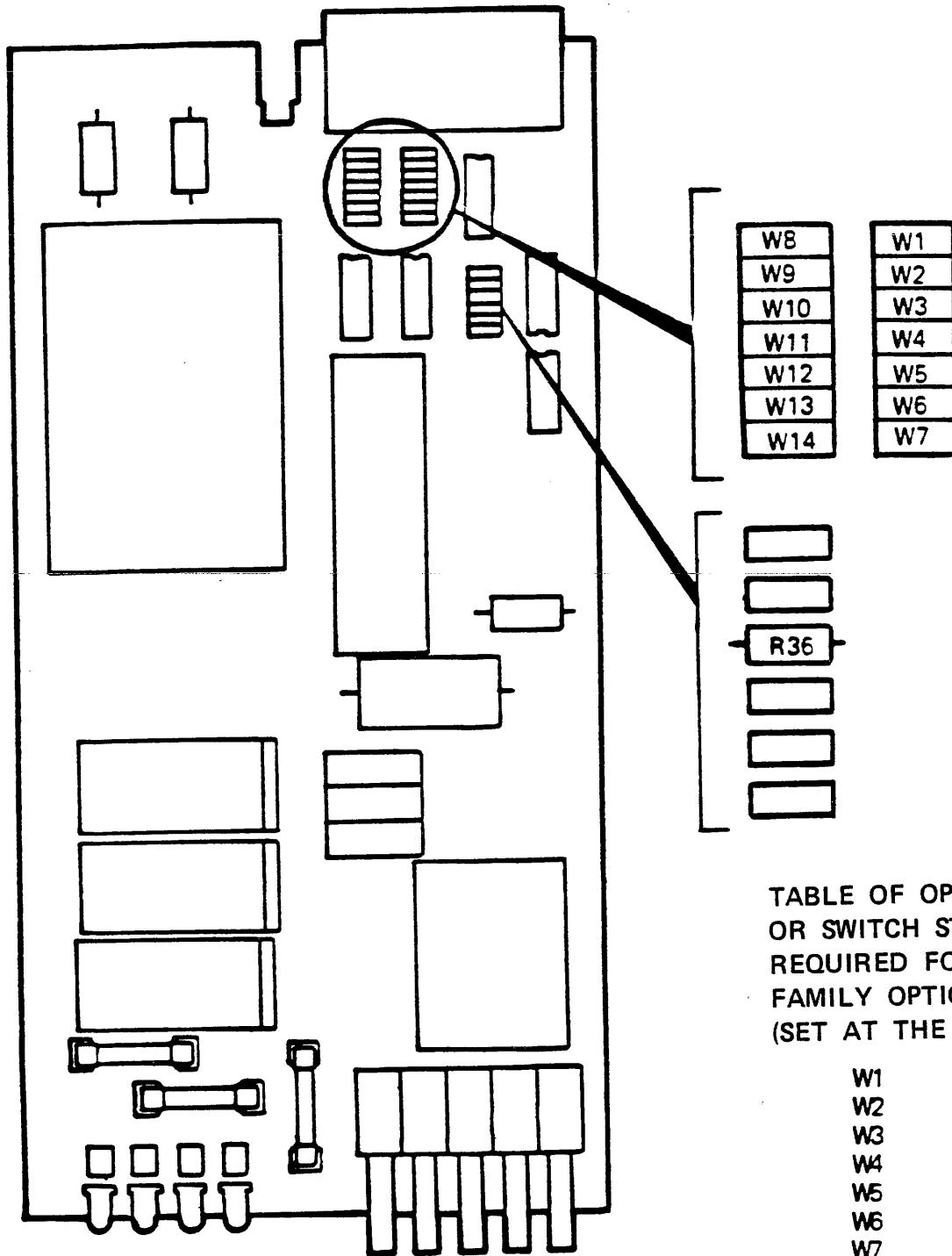

TABLE OF OPTION JUMPER  
OR SWITCH STATES  
REQUIRED FOR KC780  
FAMILY OPTIONS  
(SET AT THE FACTORY)

W1	OUT
W2	IN
W3	IN
W4	OUT
W5	IN
W6	OUT
W7	OUT
W8	IN
W9	OUT
W10	OUT
W11	IN
W12	OUT
W13	OUT
W14	OUT
R36	OUT

Figure A-5 DF02 Interface Board Jumpers for KC780-BA

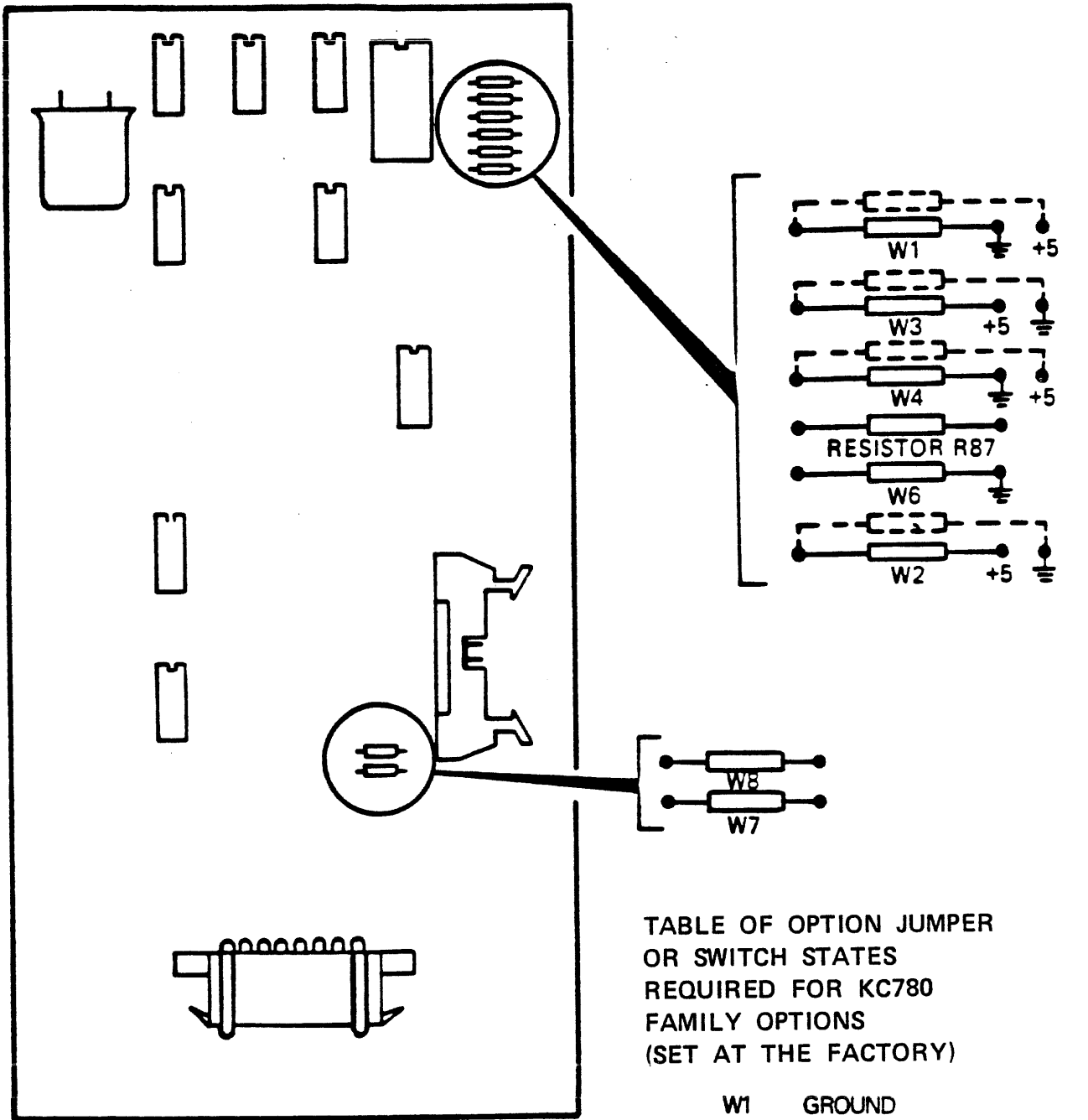
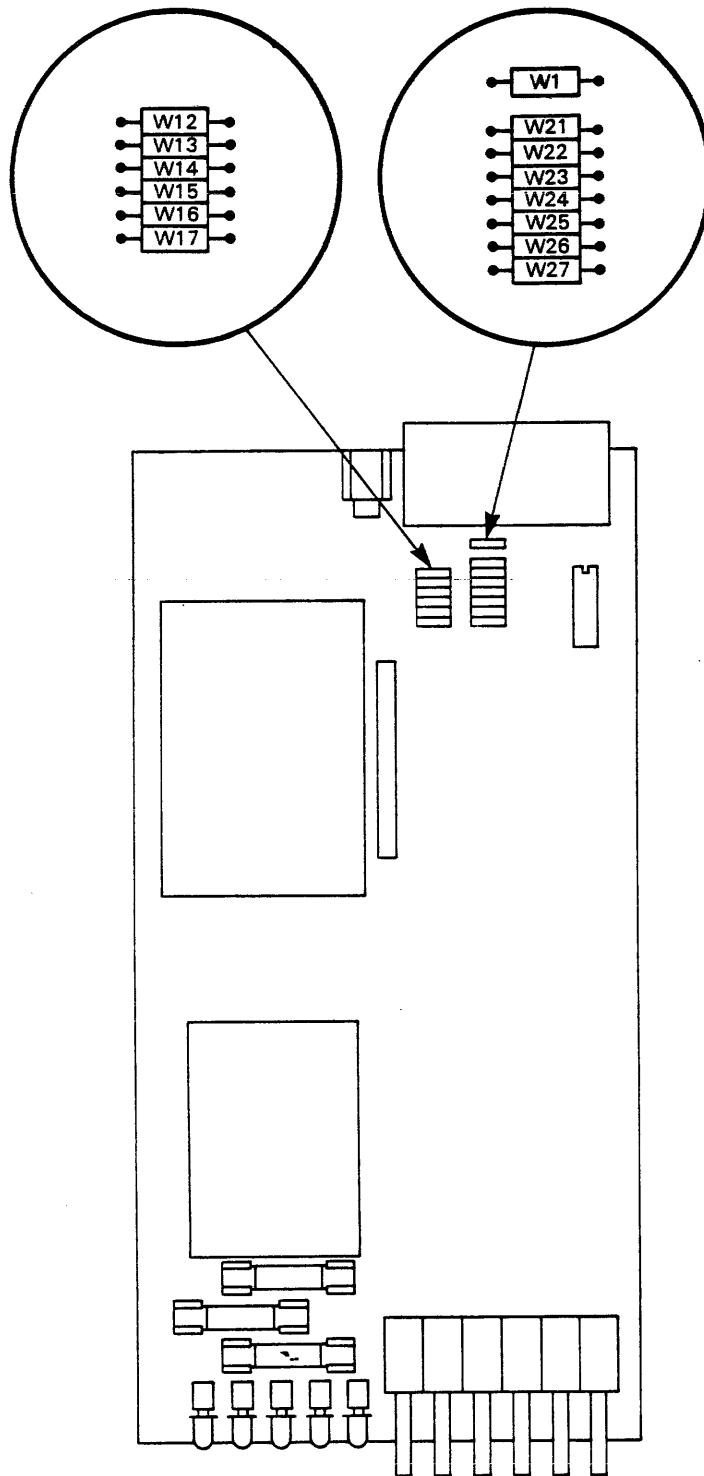

TABLE OF OPTION JUMPER  
OR SWITCH STATES  
REQUIRED FOR KC780  
FAMILY OPTIONS  
(SET AT THE FACTORY)

W1	GROUND
W2	+5V
W3	+5V
W4	GROUND
W6	IN
W7	IN
W8	IN

MA-5346 A

Figure A-6 DF02 Modem Board Jumpers for KC780-BA



**TABLE OF OPTION JUMPER  
OR SWITCH STATES  
REQUIRED FOR KC780  
FAMILY OPTIONS  
(SET AT THE FACTORY)**

W1	IN
W12/S1-2	OUT/OFF
W13/S1-3	OUT/OFF
W14/S1-4	IN/ON
W15/S1-5	OUT/OFF
W16/S1-6	OUT/OFF
W17/S1-7	IN/ON
W21/S2-1	IN/ON
W22/S2-2	OUT/OFF
W23/S2-3	OUT/OFF
W24/S2-4	OUT/OFF
W25/S2-5	IN/ON
W26/S2-6	OFF/OUT
W27/S2-7	OFF/OUT

MK-1599

MA-0448-83

**Figure A-7 DF03 Interface Board Option Jumpers**

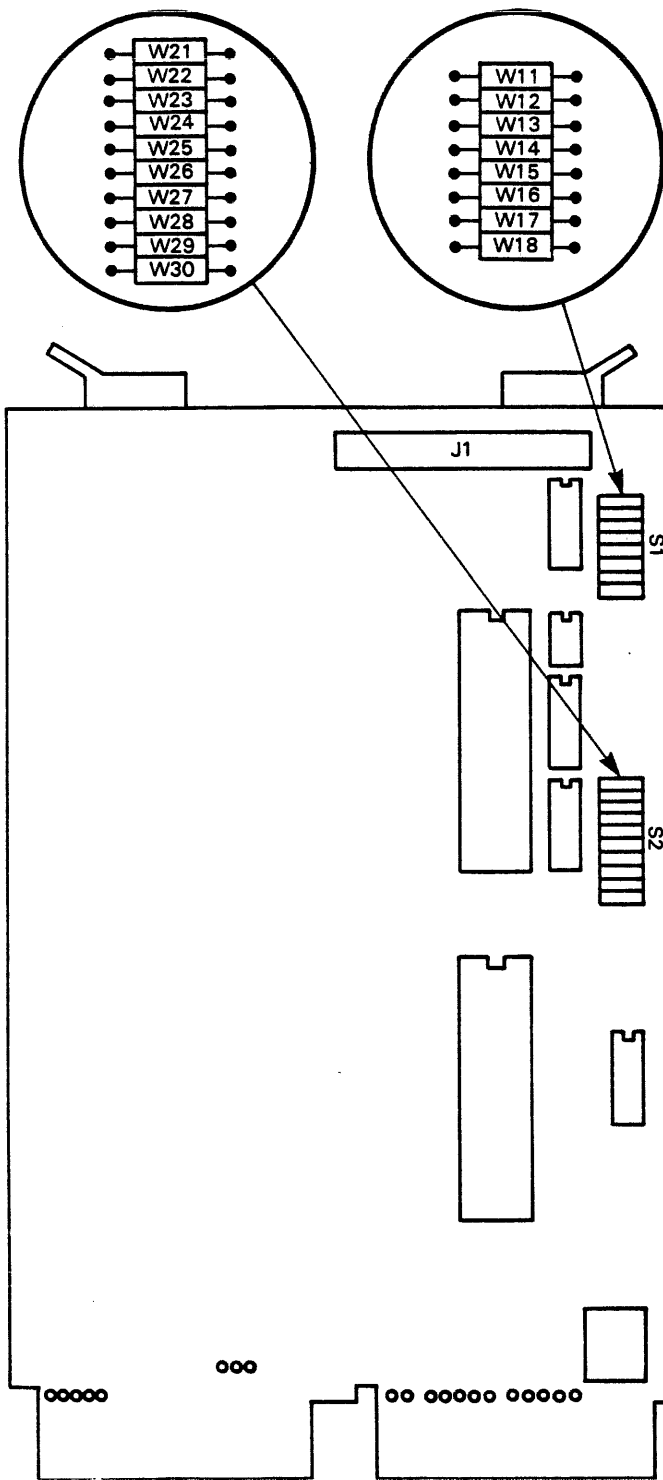

**TABLE OF OPTION JUMPER  
OR SWITCH STATES  
REQUIRED FOR KC780  
FAMILY OPTIONS  
(SET AT THE FACTORY)**

W11/S1-1	OUT/OFF
W12/S1-2	OUT/OFF
W13/S1-3	IN/ON
W14/S1-4	OUT/OFF
W15/S1-5	OUT/OFF
W16/S1-6	OUT/OFF
W17/S1-7	IN/ON
W18/S1-8	OUT/OFF
W21/S2-1	IN/ON
W22/S2-2	IN/ON
W23/S2-3	OUT/OFF
W24/S2-4	OUT/OFF
W25/S2-5	IN/ON
W26/S2-6	IN/ON
W27/S2-7	OUT/OFF
W28/S2-8	IN/ON
W29/S2-9	OUT/OFF
W30/S2-10	OUT/OFF

MA-0449-83

Figure A-8 DF03 Modem Board Option Jumpers

This basic procedure may produce failure indications:

- a. If a busy signal is heard, incorrect jumper or switch configuration of the M8017 or the modem are probable causes. Step 3 of the Installation Procedure, Paragraph 4.4, provides detailed M8017 set-up information; this appendix provides modem set-up information. If the modem was not provided by DIGITAL, determine that the correct type modem was installed.
- b. If the ringing signal continues and the modem does not answer with a carrier tone, that could indicate a modem with no power. It could also indicate any failure of the VAX system to assert DTR to the modem or from having the keyswitch in a LOCAL instead of a REMOTE or REMOTE DISABLE position.

#### A.6 MODEM REPAIR

Modem repair is also subject to government regulation. A modem for connection to a telephone line may be repaired only by the manufacturer or an authorized agent. As a result, unit swapping is routine when a modem which was provided by DIGITAL fails. Both DIGITAL and customer personnel should know that the telephone company must be notified if an installed modem is replaced by a unit which has a different F.C.C. registration number (United States). The Digital Field Service Representative will tell customer personnel about any such change and provide them with the information which they must have for the telephone company (Table 4-1).

## A.7 FCC REGULATIONS (U.S.A.)

Vendor modems which are provided by DIGITAL come with a manual that includes excerpts of government (F.C.C.) regulations which apply to users of that equipment. Excerpts that apply to the users of KC780 family options are provided in the following paragraphs. The customer is responsible for compliance with these regulations. Site personnel should know that they may have to perform specified actions in the event of modem or telephone line problems.

### FCC RULES SECTION 68.104 - MEANS OF CONNECTION

#### "(a) General

Except for telephone company-provided ringers and except as provided in subsection (c), all connections to the telephone network shall be made through the standard plugs and standard telephone company-provided jacks, or equivalent, described in Subpart F., in such a manner as to allow for easy and immediate disconnection of the terminal equipment. Standard jacks shall be so arranged that, if the plug connected thereto is withdrawn, no interference to the operation of equipment at the customer's premises which remains connected to the telephone network, shall occur by reason of such withdrawal.

#### (b) Data Equipment

Where a customer desires to connect data equipment which has been registered in accordance with Section 68.308 (a) (4) (i) or (ii), he shall notify the telephone company of each telephone line to which he intends to connect such equipment. The telephone company, after determining the attenuation of

such telephone line between the interface and the telephone company central office, will make such connections as are necessary in each standard data jack which it will install, so as to allow the maximum signal power delivered by such data equipment to the telephone company central office to reach but not exceed the maximum allowable signal power permitted at the telephone company central office."

#### **STANDARD DATA JACKS**

The Standard Data Jacks with which the FCC-registered model(s) of the data set covered in the attached technical manual will connect are listed and briefly described in the manual.

#### **FCC RULES SECTION 68.106 - NOTIFICATION TO TELEPHONE COMPANY**

"Customers connecting terminal equipment to the telephone network shall, before such connection is made, give notice to the telephone company of the particular line(s) to which such connection is to be made and shall provide to the telephone company the F.C.C. Registration Number and the Ringer Equivalence Number of the registered terminal equipment or registered protective circuitry."

#### **FCC REGISTRATION NUMBER AND RINGER EQUIVALENCE NUMBER**

The FCC Registration Number and Ringer Equivalence Number are contained on the label on the registered equipment.



FCC RULES SECTION 68.108 - INCIDENCE OF HARM

"Should terminal equipment cause harm to the telephone network, the telephone company shall, where practicable, notify the customer that temporary discontinuance of service may be required; however, where prior notice is not practicable, the telephone company may temporarily discontinue service forthwith, if such action is reasonable in the circumstances. In case of such temporary discontinuance, the telephone company shall (1) promptly notify the customer of such temporary discontinuance, (2) afford the customer the opportunity to correct the situation which gave rise to the temporary discontinuance, and (3) inform the customer of his right to bring a complaint to the Commission pursuant to the procedures set out in Subpart E of this Part."

FCC RULES SECTION 68.110

COMPATABILITY OF THE TELEPHONE NETWORK AND TERMINAL EQUIPMENT

"(b) Changes in Telephone Company Facilities, Equipment, Operations or Procedures

The telephone company may make changes in its communications facilities, equipment, operations or procedures, where such action is reasonably required in the operation of its business and is not inconsistent with the rules and regulations in this Part. If such changes can be reasonably expected to render any customer's terminal equipment incompatible with telephone company communications facilities, or require modification or alteration of such terminal equipment, or otherwise materially affect its use or performance, the customer shall be given adequate notice in writing, to allow the customer an opportunity to maintain uninterrupted service."

FCC RULES, SECTION 68.218 (b) - INSTRUCTION TO USER

- "(2) . . . registered terminal equipment or protective circuitry may not be used with party lines or coin lines.
- (3) . . . when trouble is experienced the customer shall disconnect the registered equipment from the telephone line to determine if the registered equipment is malfunctioning and . . . if the registered equipment is determined to be malfunctioning, the use of such equipment shall be discontinued until the problem has been corrected.
- (4) . . . the user must give notice to the telephone company in accordance with the requirements of Section 68.106."

A.8 MODEM OPERATION CHARACTERISTICS

The following paragraphs define the required functional characteristics of modems used with DIGITAL remote diagnosis devices. Those devices operate with the following characteristics:

- o 300 baud serial data communication
- o 1200 baud serial data communication
- o Asynchronous (start/stop) character framing (one start bit, eight data bits, no parity bits, one stop bit)
- o Full duplex
- o Automatic answer
- o Automatic disconnect

## A.8.1 DEFINITIONS

Table A-2 defines the signals recognized by the remote diagnosis device and modem. The table provides the signal name, the EIA RS-232C circuit name, the CCITT V.24 circuit number, the position on the 25-pin D-type connector, and the signal definition.

## A.8.2 CALL REQUIREMENTS

The following paragraphs describe call answering and termination event sequences.

**A.8.2.1 AUTOMATIC CALL ANSWERING** - Automatic call answering is enabled as follows (Figures A-9 and A-11):

Set the front-panel keyswitch to either the REMOTE or REMOTE/DISABLE position. Console device signals DTR and RTS are cleared and data line TxD is inhibited (held at binary 1). Modem signals RI, DSR, CTS, and CD are cleared and data line RxD is inhibited (held at binary 1). DTR is asserted by the console device and call answering is enabled.

With DTR asserted, the modem attempts to answer the phone when it detects at least one RI signal. When the phone is answered, the modem asserts DSR. Once the console detects DSR, DTR may not be deasserted for five seconds, unless the console has also detected CD. The assertion of DSR must be detected by the console device within 20 seconds, or the call is terminated. Once DSR is detected, the console asserts RTS.

The modem responds to the assertion of RTS by placing its carrier signal or answer tone on the line. When a carrier signal is

Table A-2 Signal Definitions

Name	RS-232C	V.24	25-pin	Definition
GND	AA	101	1	Protective ground. This signal provides a path between the remote diagnosis device and the modem for the discharge of spurious potentials, such as static electricity.
GND	AB	102	7	Signal ground. This signal provides a reference level for the data and control signals that follow in this table.
TxD	BA	103	2	Transmit data (console to modem). This signal contains the serial bit stream to be sent from the console to the calling station.
RxD	BB	104	3	Receive Data (modem to console). This signal contains the serial bit stream received by the modem from the calling station.
RTS	CA	105	4	Request to Send (console to modem). This signal is asserted by the console causing the carrier signal to be placed on the line. Called the station's answer mode carrier.
CTS	CB	106	5	Clear to send (modem to console). This signal is asserted by the modem to indicate that it has successfully placed its carrier signal on the line.
DSR	CC	107	6	Data set ready (modem to console). This signal indicates to the console that the telephone has been answered (the telephone is "off hook").
DTR	CD	108/2	20	Data terminal ready (console to modem). This signal is asserted by the console, enabling telephone answering when a ring occurs.
RI	CE	125	22	Ring indicator (modem to console). This signal is monitored by the console to determine when a ring occurs (when a DDC host is attempting to call the system).
CD	CF	109	8	Carrier detect (modem to console). This signal is asserted by the modem to indicate that the calling station's carrier signal has been detected.

received from the calling station, the modem responds by asserting CD and then asserting CTS (700 +300 ms later). Note, however, that whenever CD is OFF, RxD is held at binary 1. The CD and CTS signals must be detected by the console device within 20 seconds of the assertion of RTS, or the call is terminated.

Once the console receives CD and CTS, a dialogue between the console and calling station is initiated. This dialogue, or logical connection, (described more fully in Paragraph A-5) consists of a series of data transfers via RxD and TxD, and must be successfully completed before further communications can proceed.

TxD and RxD are subject to the following restrictions and conditions:

With signals RTS, CTS, DSR, and DTR asserted, data may be transmitted on TxD until any of these four signals is deasserted. While these signals are asserted, TxD is held at binary 1 when there is no data transmission. If any of signals RTS, CTS, DSR, or DTR are deasserted, data flow is inhibited and TxD is returned to binary 1.

A logical connection must be completed within 20 seconds of the detection of DSR by the console device, or the call is terminated. During a logical connection, loss of any one of signals DSR, CTS or CD, or the receipt of a space condition (binary 0) on RxD for more than one second will also cause call termination.

Once a logical connection is completed, call answering is considered complete, a valid connection is in effect, and remote diagnosis communications can proceed.

Note, that during call answering, but before logical connection, loss of any one of signals DSR, CD, or CTS for more than 500 ms

results in call termination. Signal glitches less than 500 ms are ignored until a logical connection is established.

#### A.8.2.2 ESTABLISHING A LOGICAL CONNECTION

Once the modem asserts CD and CTS, the console device recognizes data received on RxD only if these data are in the form of a protocol message. The protocol is a modified subset of the DIGITAL Data Communication Protocol (DDCMP) for ASCII serial communications. Successful receipt of a protocol message packet from the calling station (the DDC/RDC) within 20 seconds after the modem asserts DSR constitutes the establishment of a logical connection.

#### A.8.2.3 CALL TERMINATION (ABORT SEQUENCE)

A call is terminated during a call answering routine if key signals are not detected within the established time frame, or are lost. Call termination can also be accomplished by the DDC host (by removing its carrier signal, which results in the loss of CD) or by a local operator (setting the keyswitch to LOCAL) via the console device. Refer to Figures A-10 and A-12.

Once termination is initiated, the console device inhibits the data flow on TxD and deasserts DTR and RTS. A "Connection Lost" message is printed on the system console terminal. The modem then monitors the states of signals RI, DSR, CTS, CD, and RxD. These must be cleared to successfully complete the call termination.

DTR remains deasserted for two seconds following termination, before being reasserted to again enable call answering. In addition, during this two second delay period, RTS must remain cleared and data cannot be placed on TxD. Note that DSR and CTS must be cleared by the modem before DTR and RTS can be reasserted.

If call termination was initiated by placing the VAX system keyswitch in the LOCAL position, DTR and RTS are forced deasserted. Call answering is not enabled until the switch is returned to the REMOTE/DISABLE or REMOTE position, where DTR can be asserted.

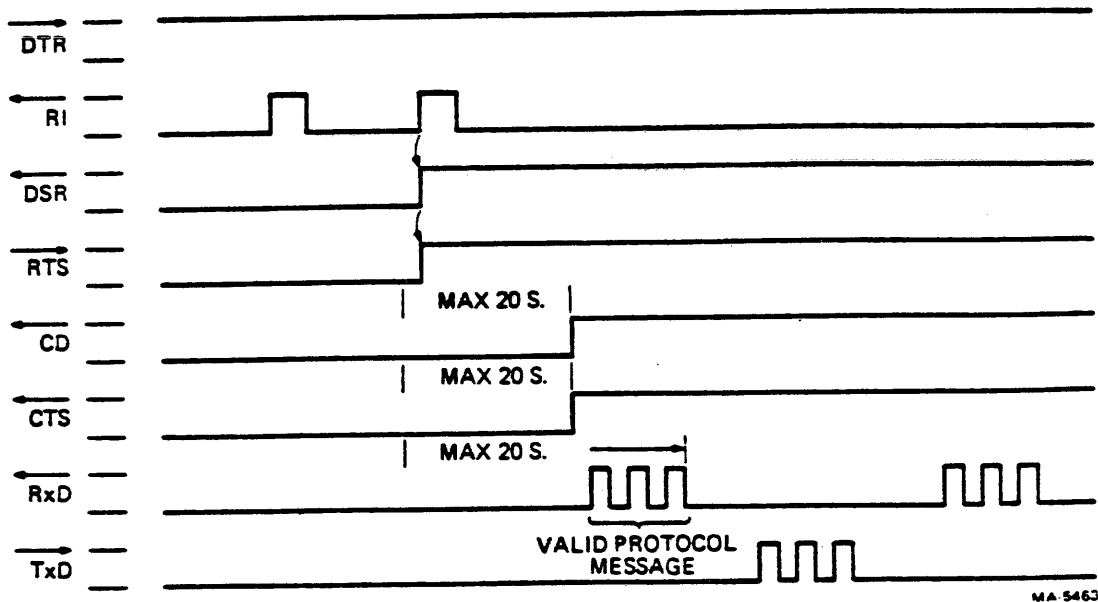

Figure A-9 Automatic Call Answering Sequence \*

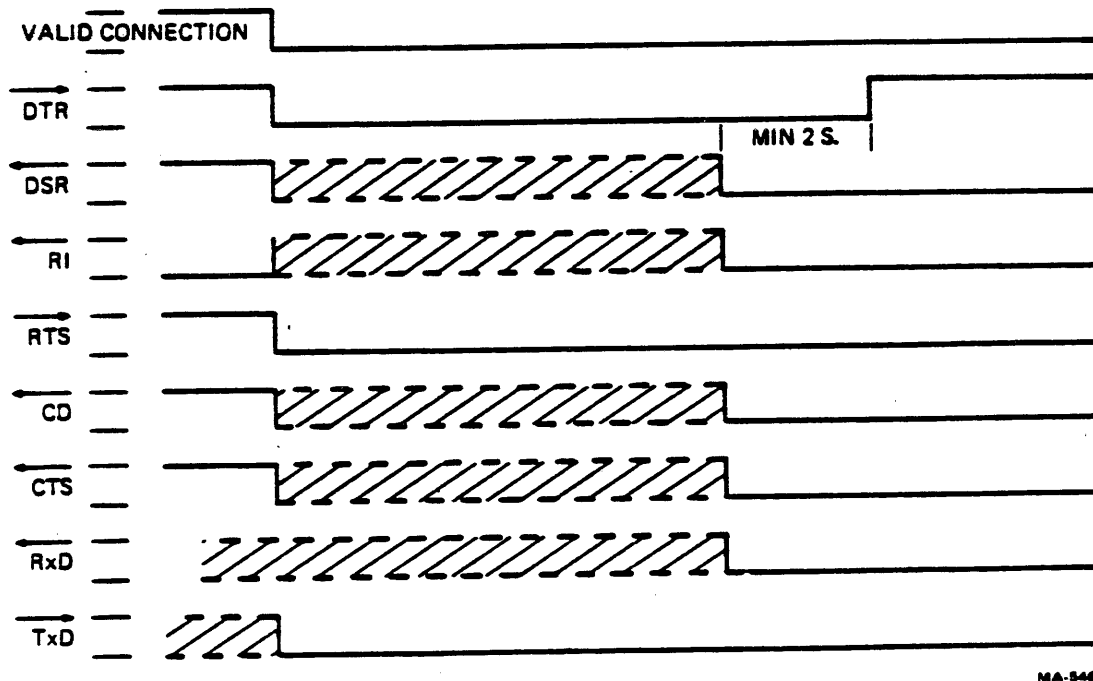
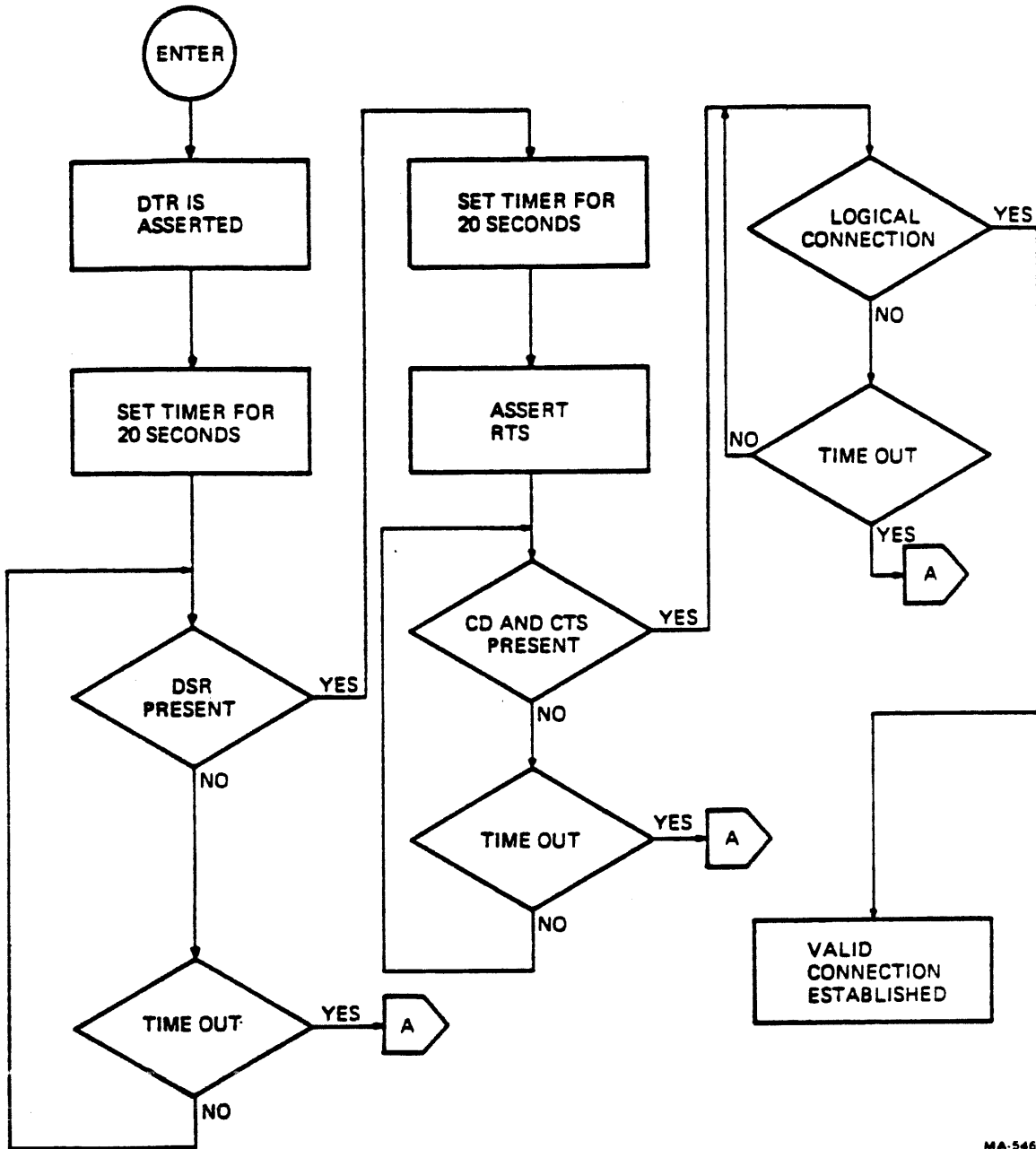

Figure A-10 Call Abort or Termination Sequence \*

(\* Both Figure A-9 and A-10 assume KC780 family option on the left, modem on the right; the VAX system keyswitch is assumed to be in a REMOTE position.)





MA-5461

Figure A-11 Call Initialization \*

(\* It is assumed, on entry, that the VAX system keyswitch is in a REMOTE position and that RI, DSR, CD, CTS, and RxD are clear.)

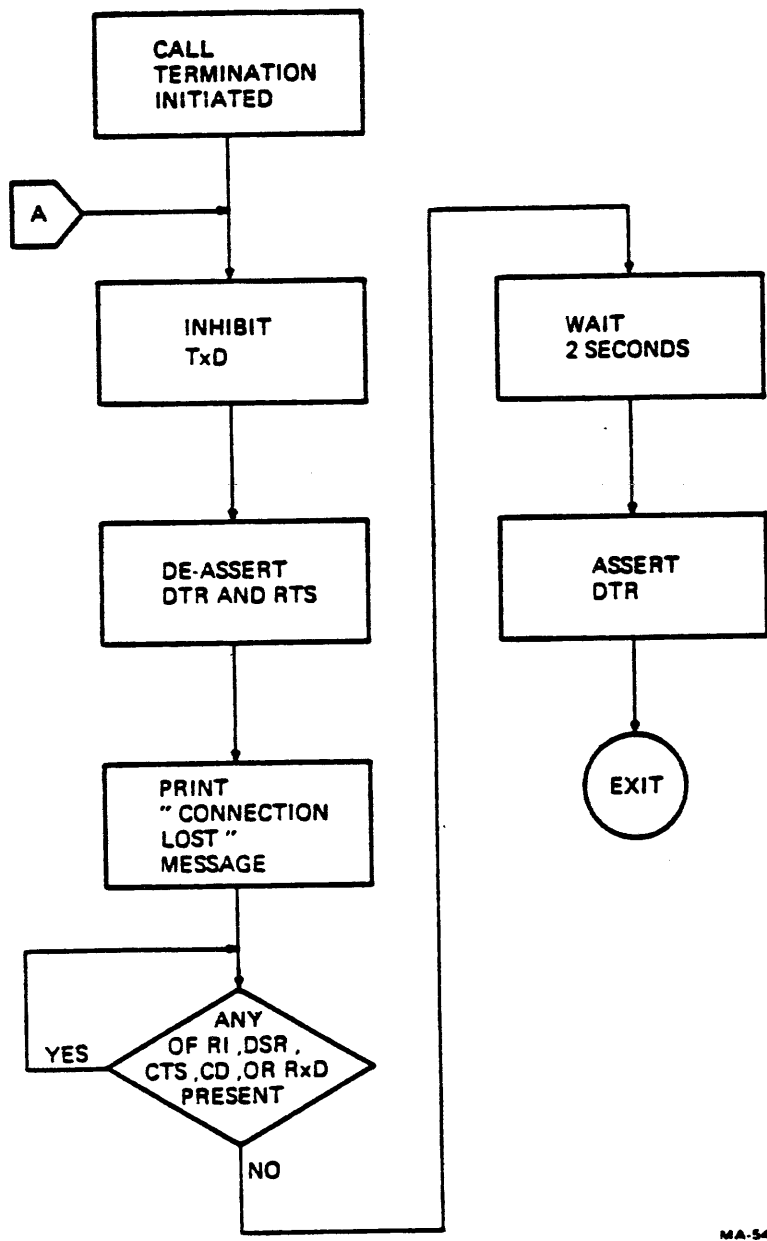

MA-5462

Figure A-12 Call Abort or Termination Sequence \*

(\* It is assumed that the VAX system keyswitch is in a REMOTE position.)

## APPENDIX B WIRE WRAP INSTRUCTIONS

### B.1 PURPOSE

This appendix is intended to assist the user who installs or removes wire wrap jumpers. It describes and illustrates the preferred procedures and standards for producing high-grade solderless wrapped jumper wire connections.

### B.2 DEFINITIONS

The following terms are used in discussing wire wrapping:

**Solderless wrapped connection**— This connection consists of a helix of continuous, solid uninsulated wire tightly wrapped around a wire wrap pin to produce a mechanically and electrically stable connection. In addition to the length of uninsulated wire wrapped around the wire wrap pin, a half turn of insulated wire is wrapped around the pin to ensure better vibration characteristics (Figure B-1).

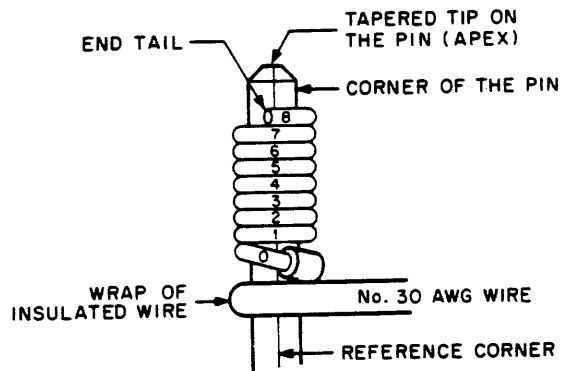

11-4974

Figure B-1 Solderless Wrapped Connection on Wire Wrap Pin

**A turn of wire** – A turn of wire consists of one complete, single, helical ring of wire wrapped 360 degrees around a wire wrap pin, intersecting four corners of the pin. Thus, a connection having “n” turns in contact with the wire wrap pin will intersect the reference corner “n + 1” times (Figure B-2).

**A half turn of wire** – A half turn of wire contacts three of the four corners of a wire wrap pin (Figure B-3).

**End tail** – An end tail is the end of the last turn of wire on the wire wrap pin.

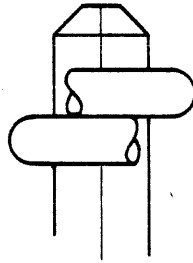

WIRE CONTACTS ALL FOUR CORNERS,  
AND CONTACTS THE REFERENCE  
CORNER TWICE.

11-4975

Figure B-2 Full Turn

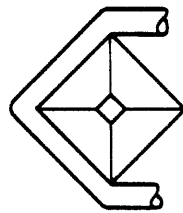

WIRE CONTACTS  
THREE CORNERS  
OF PIN

11-4976

Figure B-3 Half Turn

### B.3 CONNECTIONS

Turns are counted along the edge of a reference corner (Figure B-1). There should be seven to nine turns of insulated wire on the wire wrap pin. Each turn should be adjacent to the next turn; one turn should not be wrapped over another turn. The end tail may extend tangentially away from the wire wrap pin, but should not extend more than one wire diameter.

If a second level of wire wrap is placed on a wire wrap pin, the bare wire of the second level wrap should not overlap the first level wrap. The first turn of the insulated wire of the second level wrap may, however, overlap the last turn of the first level wrap (Figure B-4).

The wire used for the jumpers should be good quality wrapping wire. DIGITAL uses the following specifications for the jumpers installed at the factory:

Conductor

Gauge

30 AWG solid

Material

Silver-coated copper

Diameter

0.0257 + 0.0008 cm or -0.0003 cm (0.0101 + 0.0003 in or - 0.0001 in)

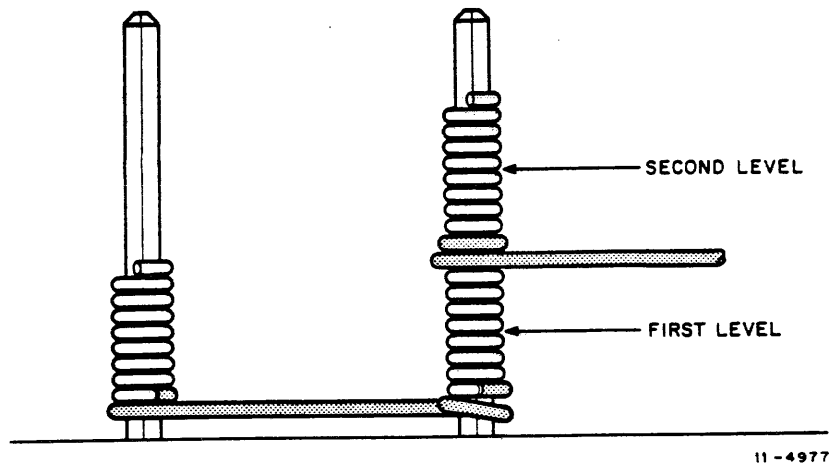

Figure B-4 Two Levels of Wire Wrap

Insulation

Material

Vinylidene fluoride

Outside Diameter

$0.048 \pm 0.003$  cm ( $0.018 \pm 0.001$  in)

U.L. Style No.

1423

DC Resistance/304.8 m (1000 ft)

113.6 ohms

**NOTE**

**This wire should not be used for solder applications.**

Figures B-1 and B-4 show recommended solderless wrapped connections. Figure B-5 illustrates connections that should be avoided.

**B.4 PROCEDURE**

To install a wire wrap jumper, proceed as follows:

1. Cut a piece of 30 AWG wire 5.7 cm (2-1/4 in) longer than the distance between the two wire wrap pins.
2. Strip 2.7 cm (1-1/16 in) off each end of the wire.

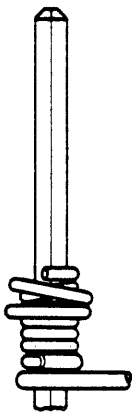

OVER WRAP  
(PILE WRAP)

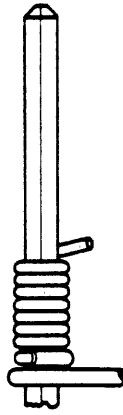

END TAIL TOO LONG

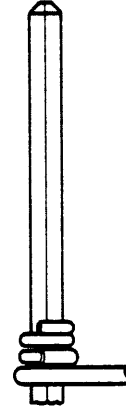

INSUFFICIENT TURNS

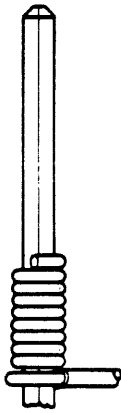

INSUFFICIENT INSULATION

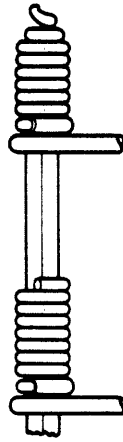

IMPROPER SPACING AND  
OVER TAPER END

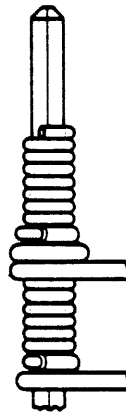

OVERLAP

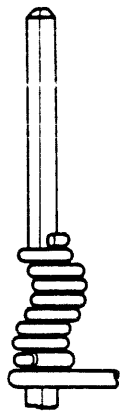

BENT WRAP-POST

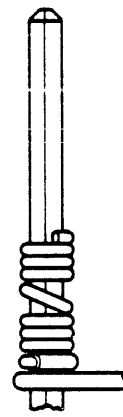

OPEN WRAP

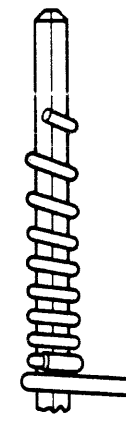

SPIRAL WRAP

11-5037

Figure B-5 Defective Wire Wraps

3. Insert the wire into the wire wrap bit far enough for the insulation to enter the feed slot (Figure B-6).
4. Loop the wire through the anchoring notch.
5. Place the tool on the wire wrap pin and actuate the rotating spindle (bit). This should produce eight turns of bare wire and one-half to two turns of insulated wire on the wire wrap pin.
6. Load the free end of the wire into the wire wrap bit and wrap the other wire wrap pin.

Use an unwrapping tool to remove a wire wrap jumper. A jumper may be snipped out to break the electrical connection, but when it is desired to reuse the wire wrap pin the remaining wire should be removed carefully. Pulling the wire off may bend the pin and dent the pin corners. Therefore, it is recommended that an unwrapping tool be used to remove jumper wire wraps.

Place the tool over the wire wrap pin and insert the end tail of the wrap into the unwrapping tool bit. Carefully unwrap the wire and discard it. Jumper wires should not be reused.

If it is desired to place a second level wrap on a wire wrap pin, care should be taken not to overlap the first wrap. If there is insufficient space left on the wire wrap pin for a second level wrap, remove the first level jumper and install a new one lower on the pin. A wire wrap joint that is installed too high on the pin should not be forced to a lower level; it should be unwrapped and replaced with a new one at the lower level.

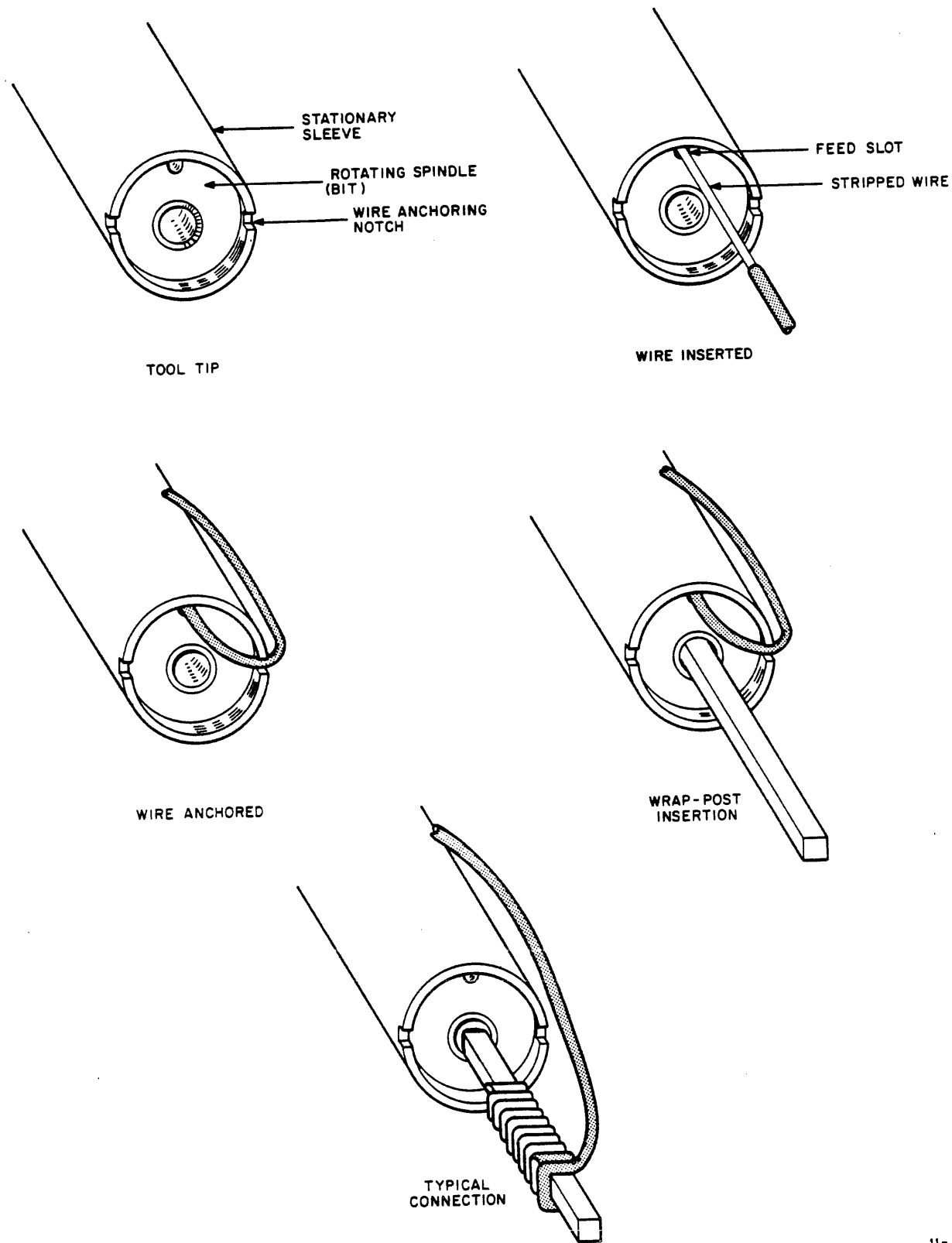

11-5038

Figure B-6 Loading the Wire Wrapping Kit



APPENDIX C  
USER GUIDES

A customer user of DIGITAL remote diagnosis needs only a few instructions to work with the DDC/RDC successfully. The DDC/RDC is always ready to give the customer any instruction needed.

As a result, the KC780 User Guide is a two-page document; it is reproduced in this manual as Figure C-1. The option kit includes it as part number EK-KC780-UG and it is stocked by Publishing and Circulation Services in Northboro. After showing it to the customer, you may post the guide, give it to the customer for use as a stand-alone document, or you may file it in the Site Management Guide behind the tab titled "XI. Remote Diagnostic Console (RDC)".

Figure C-2 is a reproduction of form EK-11780-DC which is also filed in the Site Management Guide binder behind the same tab.

## TO REQUEST REPAIR SERVICE, CALL:

DDC/RDC TELEPHONE NUMBER

## THE DIGITAL REMOTE DIAGNOSIS CENTER

provides remote diagnosis service 24 hours a day, 7 days a week, for all RD contract systems.

You should report all types of hardware failure:

Processor or Peripheral  
Identified or Suspected  
Hard or Intermittent

### WHEN YOU CALL:

- 1** The DDC/RDC will ask you to identify:  
Yourself  
Your company  
The site address  
A phone number where you can be reached  
The system type and serial number  
(System Type \_\_\_\_\_ Serial Number \_\_\_\_\_)
- 2** The DDC/RDC will ask you about the problem:  
What symptoms were (or are) present?  
What error messages were printed on the terminal?
- 3** The DDC/RDC will tell you:  
How to prepare the system for remote diagnosis.  
For additional details, see next page.
- 4** The DDC/RDC will:  
Begin the appropriate test procedure almost immediately.  
Notify the local DIGITAL Field Service office that your system is under test.
- 5** The DDC/RDC will inform the local DIGITAL Field Service Representative of test results.  
DIGITAL will complete the repair on site.  
The DDC/RDC will verify that the system has been repaired if requested to do so by the local DIGITAL Field Service Representative.

### WAIT FOR THE DDC/RDC TO TELL YOU HOW TO PREPARE THE SYSTEM FOR TESTING.

Important failure data may be lost if their instructions are not followed. Although the DDC/RDC will guide you through the various testing procedures, the following descriptions of typical sequences may be helpful.

Copyright 1982, 1984 Digital Equipment Corporation. All Rights Reserved.

#### **WHEN MAINTENANCE DIAGNOSTICS ARE TO BE RUN BY THE DDC/RDC:**

The DDC/RDC may ask you to:

- See that the modem has power and is set for "normal" operation.
- Dismount or protect media containing sensitive data.
- Identify location of [SYSMAINT] diagnostic library.
- Mount scratch media on units to be tested.
- Set AUTO RESTART switch to OFF.
- Set keyswitch to LOCAL.

For VAX-11/780 or VAX-11/782

- Load and boot Remote Console diskette in RX01 drive 0: USA - RX4
- Europe - RX41

For VAX-11/785

- Load and boot System Console diskette RX1A in RX01 Drive 0

For VAX-11/782

- Set the LQPX2 processor select switch for the processor to be tested.
- Turn keyswitch to REMOTE.

The DDC/RDC will connect via its host computer and begin testing.

Modem indicator lights may be active as testing proceeds.

The system terminal may echo DDC/RDC and CPU dialog.

The DDC/RDC may "talk" to you at the system terminal.

You may be asked to load a diskette

- For VAX-11/780 or VAX-11/782: USA - RX5 or RX6
- Europe - RX42 or RX43

- For VAX-11/785: RX2A, RX3A, RX5, RX7, or RX8A.

After testing, the local DIGITAL Field Service Representative will complete the repair.

The local DIGITAL Field Service Representative may request the DDC/RDC to verify normal operation.

#### **WHEN DDC/RDC ACCESS TO THE OPERATING SYSTEM IS PERMITTED**

The DDC/RDC may ask you to:

- Mount operating system media and boot the system

- For VAX-11/782, set the processor select switch for remote access.

- Turn the keyswitch to the REMOTE DISABLE position; the DDC/RDC may ask that the REMOTE position be selected to permit them to do crash dumps and other operating system related data testing. The keyswitch position should not be changed until requested by the DDC/RDC.

Provide DDC/RDC with an account number and password.

The DDC/RDC will log-in and begin testing.

The system terminal will echo all DDC/RDC and CPU dialogue.

The system terminal keyboard will be disabled.

The DDC/RDC may "talk" to you at the system terminal in REMOTE.

After testing, the local DIGITAL Field Service Representative will complete the repair.

The local DIGITAL Field Service Representative may request the DDC/RDC to verify normal operation.

#### **PREVENTIVE MAINTENANCE**

Preventive maintenance diagnostic sessions which will include DDC/RDC testing (also extended monitoring for intermittent failure) will be scheduled by the local DIGITAL Field Service Representative subject to customer approval.

#### **DIGITAL-SUPPLIED MODEMS**

The remote diagnosis hardware may include a DIGITAL supplied MODEM. The direct connection of these devices to a dedicated telephone line is regulated by governmental authority.

**THE CUSTOMER IS ULTIMATELY RESPONSIBLE FOR COMPLIANCE**

**WITH APPLICABLE REGULATIONS**

DIGITAL-supplied modems which fail are usually exchanged, not field repaired. Only the manufacturer or authorized agents may repair such equipment. The customer is responsible to ensure that the telephone company is notified when an exchange involves units which are electrically different and/or have differing registration numbers.

**FOR ADDITIONAL INFORMATION, SEE:**

The RDC section of the Site Management Guide

Figure C-1 KC780 Family User Guide (Sheet 2 of 2)

### VAX 11/780 REMOTE DIAGNOSIS PREPARATION

This section is intended to provide the information necessary for the user to utilize Remote Diagnosis, the Service Response Group (SRG), and the Digital Diagnosis Center (DDC) to identify a system malfunction.

If a system malfunction is detected, proceed as follows:

- 1) Contact the SRG via the "hot line" telephone.
- 2) Provide the following information to the SRG:
  - a. Caller's name and phone number
  - b. System type and serial number
  - c. Company (customer name)
  - d. Equipment location (address)
  - e. Description and frequency of your problem
  - f. Phone number and extension where you can be reached
  - g. Operating system software type and version
- 3) At this point if remote diagnosis is applicable, the SRG will log your call with the DDC and inform your local branch field service office that remote diagnosis testing is being performed on your system.
- 4) If you are asked to set up your system for remote diagnosis, follow the appropriate procedure as described below.
- 5) When the DDC has diagnosed the problem, the local branch field service office will be contacted with the DDC engineer's recommendation for correcting the problem.

#### PREPARING A VAX 11/780 FOR REMOTE DIAGNOSIS

First, some highlights: The DDC assumes that the remote diagnosis console floppy is mounted in the floppy drive and booted in the LSI-11 front end. The floppy number is 'RX4/ 11/780 REMOTE CONSOLE FLOPPY'. If this floppy is NOT booted in the LSI, the DDC cannot connect to your machine via the remote port of the LSI front end. If this is the case, the floppy must be booted in the LSI front end before the DDC connects.

The DDC also assumes that the system disk pack (or an assigned diagnostic disk pack) is ready, on-line, and write protected if VMS is not running. This pack has a diagnostic area (SYSMAINT) that will be used by the DDC to load and run diagnostics. If VMS is running, the DDC may want to run on-line diagnostics or error logger depending on the severity of the malfunction. The system disk pack or assigned diagnostic pack need not be write protected in this case.

- I. STAND ALONE REMOTE DIAGNOSIS ON 11/780 (VMS NOT RUNNING)
  - a. Determine whether the remote console floppy is booted in the LSI. This can be accomplished by turning the access key switch (on front console) to REMOTE. If it is not the remote console floppy that is booted the system will report "Remote access not supported"
    - (1) If the console floppy is NOT booted - place 'RX4/ REMOTE CONSOLE FLOPPY' in the floppy drive and turn the LSI power switch OFF then back ON - this will automatically boot the LSI with the Remote Port protocol and type some information and end with a ' ' prompt. Proceed with the next step.

XI-11780-1

Figure C-2 Site Management Guide Insert (Sheet 1 of 2)

- (2) If the floppy has been previously booted in the LSI - proceed with the next step.
  - b. Write protect the system disk pack (keeping on-line and ready) if this pack has the diagnostic (SYSMAINT) area on it, or mount the assigned disk pack with the (SYSMAINT) area on it in a drive and write protect it.
  - c. Place the AUTO RESTART switch (on the front console) to the OFF position.
  - d. Rotate the access key to REMOTE (on the front console) - the REMOTE indicator will light.
  - e. The VAX 11/780 is now ready for remote diagnosis.
2. ON-LINE REMOTE DIAGNOSIS OF 11/780 (VMS RUNNING)
- a. Determine whether the remote console floppy is booted in the LSI.
    - (1) If NOT, the DDC cannot connect to your 11/780 via the remote diagnosis port in the front end. Call the DDC at this point for further instructions.
    - (2) If the floppy has been previously booted in the LSI proceed to the next step.
  - b. Rotate the access key switch (on front console) to the REMOTE DISABLE POSITION - the REMOTE indicator will light.
  - c. Leave all system disks in their normal state.
  - d. The VAX 11/780 is now ready for remote diagnosis.

**NOTE**  
IN EITHER CASE (VMS RUNNING OR NOT)  
IF THE DDC CANNOT ACCESS THE DISK TO  
LOAD DIAGNOSTICS, YOU WILL BE CON-  
TACTED OVER THE CONSOLE TERMINAL  
AND MAY BE ASKED TO INSERT SOME  
FLOPPIES IN THE LSI TO EXHANCE DIAG-  
NOSIS

If you have any questions about preparing for a remote diagnosis session or encounter any problems in implementing the procedure - please call the DDC for assistance.

XI-11780-2

Figure C-2 Site Management Guide Insert (Sheet 2 of 2)

APPENDIX D

COMMUNICATIONS SWITCH DOCUMENT

This appendix is a reproduction of the document which is shipped with the 30-21661-01 Four-Port Communications Switch. The document part number is EJ-25436. The switch is an optional accessory which makes it possible to provide RSD services for multiple processors using a single modem.

**COMMUNICATIONS SWITCH  
FOR USE WITH  
REMOTE SERVICES DELIVERY OPTIONS**

Communications switching can be used to satisfy a wide range of customer requirements for Remote Services Delivery (RSD). It is no longer necessary that each system have its own modem and dedicated telephone line. A multiple system site can be served by one phone line and one modem or various configurations of switches, modems, and phone lines.

- Can be used on systems that have RSD options with stand-alone modems.
- No change to system hardware: A cable connects each RSD option port to the switch; another cable connects the switch common to the modem.
- Can be used on systems located within a radius of 150 feet from the modem.
- Configuration can be designed to serve site requirements and can be changed or upgraded easily.

**SITE PREPARATION**

1. Determine where the switch unit is to be installed; an operator will control RSD access to each system from that location.
2. Determine where the modem and the telephone data jack will be installed.
3. Determine that required cabling lengths are in accordance with the Cable Configuration Chart on page 2.

**INSTALLATION PROCEDURE**

1. Prepare each processor with its RSD option installed and its RSD port connector accessible.
2. Connect the switch-to-modem cable from the switch unit connector labeled COMMON to the modem.
3. Connect the system-to-switch cable from the RSD port on each system to a switch unit connector labeled A, B, C, or D.
4. Note that usually no connection is made to the switch unit connector labeled MONITOR.

**OPERATION**

1. When a system is to be accessed for RSD, set the communications switch to the position for that system before the telephone connection is made.
2. Do not change the switch setting while RSD activity is in progress; the carrier signal will be lost and the system RSD option will terminate RSD access.

Copyright 1983

DIGITAL EQUIPMENT CORPORATION

All rights reserved  
EJ-25436

Figure D-1 Communications Switch Document (Sheet 1 of 2)

MENU ITEMS	SYSTEM TYPE	PART NUMBER
ONE KIT REQUIRED PER PROCESSOR  Kits contain processor-to-RSD EIA port hardware only.	11/730 11/750 11/44 11/780 11/782 (two kits)	KC730-BA KC750-DA KBD01-BA KC780-EA (USA) or KC780-DA (EUROPE) KC780-EA (USA) or KC780-DA (EUROPE) KC782-AA (USA) or KC782-DA (EUROPE)
MODEM	-	DF03-AA (300/1200 Baud)
EIA PORT SWITCH	-	30-21661-01 (Four-Port)

CABLE CONFIGURATION

IF SWITCH-TO-MODEM CABLE IS:	SYSTEM-TO-SWITCH CABLE CAN BE:			
	10'	25'	75'	150'
(BC22F-10) 10'	X	X	X	X
(BC22F-25) 25'	X	X	X	
(BC22F-75) 75'	X	X		
(BC18E-A5) 150'	X			

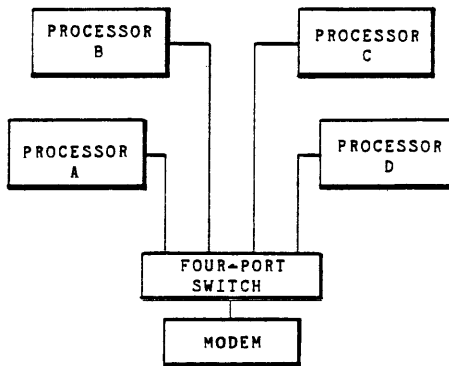

EJ-25436

Figure D-1 Communications Switch Document (Sheet 2 of 2)



## TECHNICAL DOCUMENTATION CHANGE NOTICE

This Change Notice provides information that updates revision 007 of the KC780 Technical Manual, EK-KC780-TM. When the manual is revised to 008, it will include these changes.

This document was released to Manufacturing in preliminary form so it could be shipped with KC780 kits as soon as possible.

**digital equipment corporation • maynard, massachusetts**

o Page 4-5, Table 4-1

Table 4-1 is changed to include the new DF112-AA modem that is now being shipped in KC780 kits. The new version of the table follows.

MODEM MANUFACTURER	MODEL NUMBER	FCC REGISTRATION NUMBER	RINGER EQUIVALENCE NUMBER
GDC	103A3	AG697J-62418-DM-E	0.6, Type B
VADIC	VA355P	AJ496M-70263-DM-N	1.0, Type B
DIGITAL	DF02	A0994Q-67693-DM-R	0.3, Type A
DIGITAL	DF03-AA	A0994Q-69391-DM-R	0.3, Type A
DIGITAL	DF112-AA	A0994Q-13634-DM-E	0.3, Type B

---

o Page 4-9, Figure 4-2

Figure 4-2 will be changed to show that the new DF112 modem is now being shipped in the KC780 kits.

---

o Page 4-28, Installation Step 9

Information about the new DF112 modem will be included. For the DF112: The proper option states are preset at the factory; no on-site preparation is required except mechanical assembly. The manual this shipped with the modem tells you how to do the assembly.

o Page 4-39, Paragraph 4.8.1

Information about the new DF112 modem will be included. Since the KC780 does not use the new features of the DF112 yet, set the front panel switches as follows:

All switches except HS (High Speed) out.

HS switch out for 300 baud operation.

HS switch in for 1200 baud operation.

---

o Page A-5, Table A-1

Table A-1, and the paragraphs that refer to it, will be changed to show that it is only applicable to the GDC and Vadic modems.