

RSX-11M Operating System Internals

Data Structures and Lists

RSX-11M Operating System Internals

Data Structures and Lists

Course Number
EY-CC 573-LE-001
(J2542-A)

Prepared by Educational Services
of
Digital Equipment Corporation

Copyright © 1982, Digital Equipment Corporation.
All Rights Reserved.

The reproduction of this material, in part or whole, is strictly prohibited. For copy information, contact the Educational Services Department, Digital Equipment Corporation, Bedford, Massachusetts 01730.

Printed in U.S.A.

The information in this document is subject to change without notice and should not be construed as a commitment by Digital Equipment Corporation. Digital Equipment Corporation assumes no responsibility for any errors that may appear in this document.

The software described in this document is furnished under a license and may not be used or copied except in accordance with the terms of such license.

Digital Equipment Corporation assumes no responsibility for the use or reliability of its software on equipment that is not supplied by Digital.

The following are trademarks of Digital Equipment Corporation, Maynard, Massachusetts:

DIGITAL	DECsystem-10	MASSBUS
DEC	DECSYSTEM-20	OMNIBUS
PDP	DIBOL	OS/8
DECUS	EDUSYSTEM	RSTS
UNIBUS	VAX	RSX
	VMS	IAS

CONTENTS

DATA STRUCTURES

1	Asynchronous System Trap Control Block.	1
2	Attachment Descriptor Block	1
3	Attachment Descriptor Status Bits	1
4	Clock Queue Control Block	2
5	Device Control Block (DCB).	4
6	Device Function Masks: FILES-11 ACP Functions.	5
7	Device Function Masks: Standard Non-ACP Functions.	6
8	Device Function Masks: Special Executive I/O Function.	6
9	Error Message Block (EMB): Fixed Part.	6
10	Error Message Block (EMB): Undefined Interrupts.	7
11	Error Message Block (EMB): Device Errors and Device Timeouts.	7
12	Error Message Block (EMB): Driver Load and Unload.	7
13	Error Message Block (EMB): Memory and Cache Parity Errors.	8
14	Error Codes (E.CODE in EMB)	9
15	File Control Block (FCB).	10
16	System File Characteristics (F.SCHA in FCB)	11
17	User File Characteristics (F.UCHA in FCB)	11
18	FCB Status (F.STAT+1 in FCB).	11
19	FILES-11 Window Block	12
20	FILES-11 Window Block Control Bits (W.CTL+1 in window block)	12
21	Group Global Event Flags Block.	13
22	Interrupt Control Block (ICB): Error Logging Device.	13
23	Interrupt Control Block (ICB): Non-error Logging Device.	14
24	Interrupt Transfer Block.	15
25	I/O Packet.	16
26	Logical Assignment Control Block (LCB).	16
27	Locked Block List Node.	17
28	Mapping Assignment Block.	17
29	Mounted Volume List Entry (MVL)	17
30	Status Values for Mounted Volume (M.STAT in MVL).	18
31	Offspring Control Block (OCB)	18
32	Partition Control Block (PCB)	19
33	Partition Busy Bits (P.BUSY in PCB)	20
34	Partition Protection Bits (P.PRO in PCB).	21

35	Partition Status Word (P.STAT in PCB)	22
36	Checkpoint PCB	23
37	Send/Receive Data Block	23
38	Send/Receive-by-Reference Block	24
39	Status Control Block (SCB)	25
40	Device Priority Byte (S.PRI in SCB)	26
41	Task Addressing Window Block	26
42	Task Control Block (TCB): Fixed Part	27
43	Task Control Block (TCB): Conditional Parts	28
44	Task Status Word (T.STAT in TCB)	29
45	Second Task Status Word (T.ST2 in TCB)	30
46	Third Task Status Word (T.ST3 in TCB)	31
47	Task Header: Fixed Part	32
48	Task Header: Variable Part	33
49	Task Header: Termination of Variable Part	34
50	Unmounted Volume List Node (UVL)	34
51	Unit Control Block (UCB): Fixed Part	35
52	UCB Prefix for Error Logging Devices	35
53	UCB Prefix for Terminals	35
54	End of UCB for FILES-11 Devices	36
55	End of UCB for Terminals	36
56	Unit Control Processing Flags (U.CTL in UCB)	37
57	Unit Status Flags (U.STS in UCB)	38
58	Unit Status Extension (U.ST2 in UCB)	39
59	Device Characteristics Word 1 (U.CW1 in UCB)	39
60	Device Characteristics Word 2 (U.CW2 in UCB)	40
61	Terminal Driver Status Word 1 (U.TSTA in UCB)	41
62	Terminal Driver Status Word 2 (U.TSTA+2 in UCB)	42
63	Terminal Driver Status Word 3 (U.TSTA+4 in UCB)	43
64	Volume Control Block (VCB)	44
65	Volume Status Byte (V.STS in VCB)	45
66	Volume Type Descriptors (V.TYPE in VCB)	45
67	Volume Characteristics (V.VCHA in VCB)	46

LISTS

68	AST Queue	46
69	Checkpoint File Data Structure.	47
70	Dynamic Storage Region (DSR).	48
71	Error Message List.	49
72	File Open and Close Structures.	50
73	I/O Packets (Preallocated).	50
74	Loader Queue.	51
75	MCR Command Line List	52
76	Mounted FILES-11 Volume	53
77	Partition List.	54
78	Partition Wait Queue.	55
79	Send/Receive Data Queue	56
80	Send/Receive-by-Reference Queue	56
81	System Task Directory (STD) and Active Task List (ATL).	57
82	TCB, Task Header, and PCB Interrelationship: System Controlled Partition.	58
83	TCB, Task Header, and PCB Interrelationship: User Controlled Partition.	59

TABLE

1	Macros Which Define Data Structure Offsets.	60
---	---	----

DATA STRUCTURES AND LISTS

SUBROUTINE KISAR5 BIAS (A.CBL = 0)	-4	A.KSR5
DEQUEUE SUBROUTINE ADDRESS (A.CBL = 0)	-2	A.DQSR
AST QUEUE THREAD WORD	0	
LENGTH OF CONTROL BLOCK IN BYTES	2	A.CBL
NUMBER OF BYTES TO ALLOCATE ON TASK STACK	4	A.BYT
AST TRAP ADDRESS	6	A.AST
NUMBER OF AST PARAMETERS	10	A.NPR
FIRST AST PARAMETER	12	A.PRM

TK-3256

Figure 1 Asynchronous System Trap Control Block

	PCB ATTACHMENT QUEUE THREAD WORD	0	A.PCBL
A.IOC 1	I/O COUNT THROUGH THIS DESCRIPTOR	2	A.PRI
	PRIORITY OF ATTACHED TASK	4	A.TCB
	TCB ADDRESS OF ATTACHED TASK	6	A.TCBL
	TCB ATTACHMENT QUEUE THREAD WORD	10	A.STAT
A.MPCT 7	MAPPING COUNT OF TASK THROUGH THIS DESCRIPTOR	12	A.PCB
	STATUS BYTE		
	PCB ADDRESS OF ATTACHED TASK		

TK-3184

Figure 2 Attachment Descriptor Block

BIT	MASK	
3	10	AS.DEL – TASK HAS DELETE ACCESS (1=YES)
2	4	AS.EXT – TASK HAS EXTEND ACCESS (1=YES)
1	2	AS.WRT – TASK HAS WRITE ACCESS (1=YES)
0	1	AS.RED – TASK HAS READ ACCESS (1=YES)

TK-3185

Figure 3 Attachment Descriptor Status Bits

DATA STRUCTURES AND LISTS

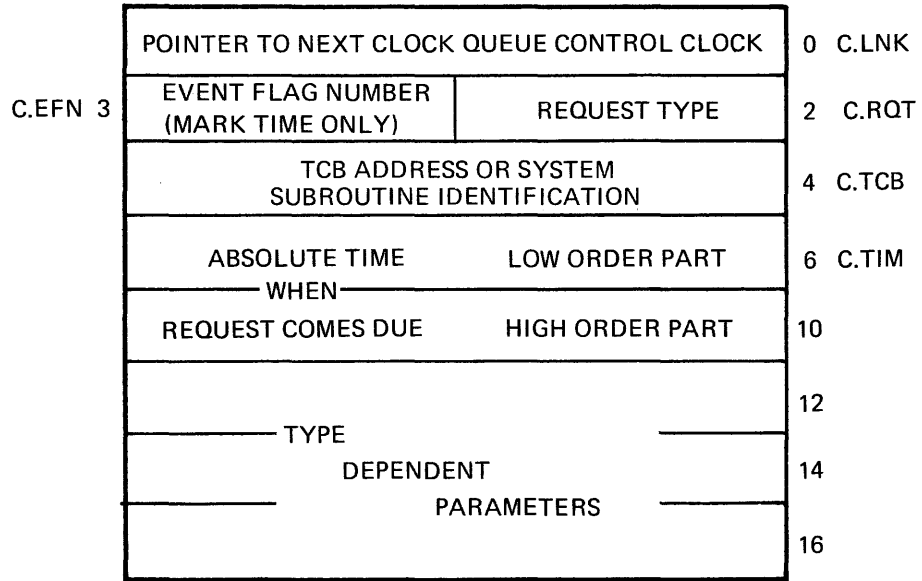

TK-1820

Figure 4 Clock Queue Control Block
(Sheet 1 of 2)

DATA STRUCTURES AND LISTS

TYPE 0 (C.MRKT) – MARK TIME REQUEST

AST ADDRESS	12	C.AST
SOURCE FOR BIS INSTRUCTION - MASK WORD	14	C.SRC
ADDRESS OF 'BIS' DESTINATION	16	C.DST

TYPE 2 (C.SCHD) – TASK REQUEST WITH PERIODIC RESCHEDULING

RESCHEDULE _____	LOW ORDER WORD	12	C.RSI
INTERVAL _____	HIGH ORDER WORD	14	
SCHEDULING UIC		16	C.UIC

TYPE 4 (C.SSHT) - SINGLE SHOT TASK REQUEST

(UNUSED)	12	
(UNUSED)	14	
SCHEDULING UIC	16	C.UIC

SINGLE SHOT INTERNAL SUBROUTINE

TYPE 6 (S.SYST) (IDENT)¹ TYPE 8 (C.SYTK) (TASK)¹

SUBROUTINE ADDRESS	12	C.SUB
RELOCATION BIAS (KISAR5) FOR LOADABLE DRIVERS	14	C.AR5
(UNUSED)		

TYPE 10 (C.CSTP)²

(UNUSED)	12	
(UNUSED)	14	
(UNUSED)	16	

1. TYPE 6 = A 16 BIT VALUE AS AN IDENTIFIER
 TYPE 8 = TCB ADDRESS AS AN IDENTIFIER

2. SYSTEMS WITH SYSTEM CONTROLLED PARTITIONS AND
 THE SHUFFLER ONLY.

TK-1821

Figure 4 Clock Queue Control Block
 (Sheet 2 of 2)

DATA STRUCTURES AND LISTS

LINK TO NEXT DCB		0	D.LNK
POINTER TO FIRST UCB OF THIS DEVICE TYPE		2	D.UCB
GENERIC DEVICE NAME (IN ASCII)		4	D.NAM
HIGHEST UNIT NUMBER	LOWEST UNIT NUMBER	6	D.UNIT
LENGTH OF EACH UCB OF THIS DEVICE TYPE		10	D.UCBL
POINTER TO DRIVER DISPATCH TABLE		12	D.DSP
LEGAL FUNCTION MASK	CODES 0 – 15	14	D.MSK
CONTROL FUNCTION MASK	CODES 0 – 15	16	} (NOT NAMED)
NO-OP FUNCTION MASK	CODES 0 – 15	20	
ACP FUNCTION MASK	CODES 0 – 15	22	
LEGAL FUNCTION MASK	CODES 16 – 31	24	
CONTROL FUNCTION MASK	CODES 16 – 31	26	
NO-OP FUNCTION MASK	CODES 16 – 31	30	
ACP FUNCTION MASK	CODES 16 – 31	32	
PCB ADDRESS OF LOADABLE DRIVER		34	

D.DSP \ D.PCB	=0	≠0
	=0	LOADABLE DRIVER NOT LOADED
≠0	RESIDENT DRIVER	LOADABLE DRIVER LOADED

1. SYSTEMS WITH LOADABLE DRIVER SUPPORT ONLY

TK-1822

Figure 5 Device Control Block (DCB)

DATA STRUCTURES AND LISTS

BIT GROUP		MASK	OFFSET	
10	1	400		NOT USED
11	1	1000	IO.FNA	FIND NAME IN DIRECTORY
12	1	2000		UNLOCK BLOCK
13	1	4000	IO.RNA	REMOVE NAME FROM DIRECTORY
14	1	10000	IO.ENA	ENTER NAME IN DIRECTORY
15	1	20000	IO.ACR	ACCESS FILE FOR READ
16	1	40000	IO.ACW	ACCESS FILE FOR WRITE
17	1	100000	IO.ACE	ACCESS FILE FOR EXTEND
20	2	1	IO.DAC	DEACCESS FILE
21	2	2	IO.RVB	READ VIRTUAL BLOCK
22	2	4	IO.WVB	WRITE VIRTUAL BLOCK
23	2	10	IO.EXT	EXTEND FILE
24	2	20	IO.CRE	CREATE FILE
25	2	40	IO.DEL	MARK FILE FOR DELETE
26	2	100	IO.RAT	READ ATTRIBUTES
27	2	200	IO.WAT	WRITE ATTRIBUTES

TK-1803

Figure 6 Device Functions Masks: FILES-11 ACP Functions

DATA STRUCTURES AND LISTS

BIT GROUP MASK			OFFSET	
0	1	1	IO.KIL	CANCEL I/O
1	1	2	IO.WLB	WRITE LOGICAL BLOCK
2	1	4	IO.RLB	READ LOGICAL BLOCK
3	1	10	IO.ATT	ATTACH DEVICE
4	1	20	IO.DET	DETACH DEVICE
5	1	40		DEVICE CONTROL FUNCTIONS
6	1	100		

TK-1804

Figure 7 Device Function Masks: Standard Non-ACP Functions

BIT GROUP MASK			OFFSET	
7	1	200	IO.CLN	CLOSE OUT LUN

TK-1805

Figure 8 Device Functions Masks: Special Executive I/O Function

		SIZE OF EMB IN BYTES		0	E.SIZE
E.SCDE 3	ERROR SUBCODE	ERROR CODE		2	E.CODE
	MINUTE	TIME	SECOND	4	E.TIME
	DAY	OF	HOUR	6	
	YEAR	ERROR	MONTH	10	
ERROR SEQUENCE NUMBER				12	E.SEQ
SAVED I/O ACTIVE BITMAP				14	E.ABM

TK-1806

Figure 9 Error Message Block (EMB): Fixed Part

DATA STRUCTURES AND LISTS

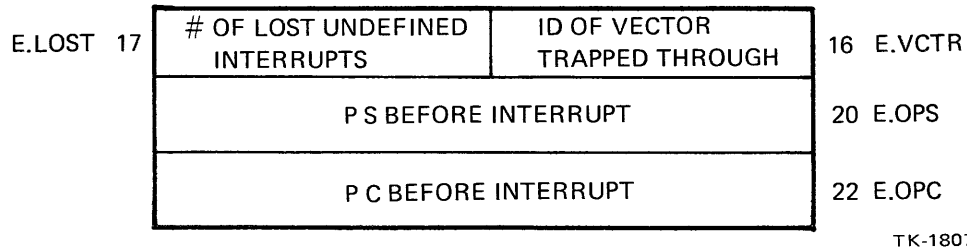

Figure 10 Error Message Block (EMB): Undefined Interrupts

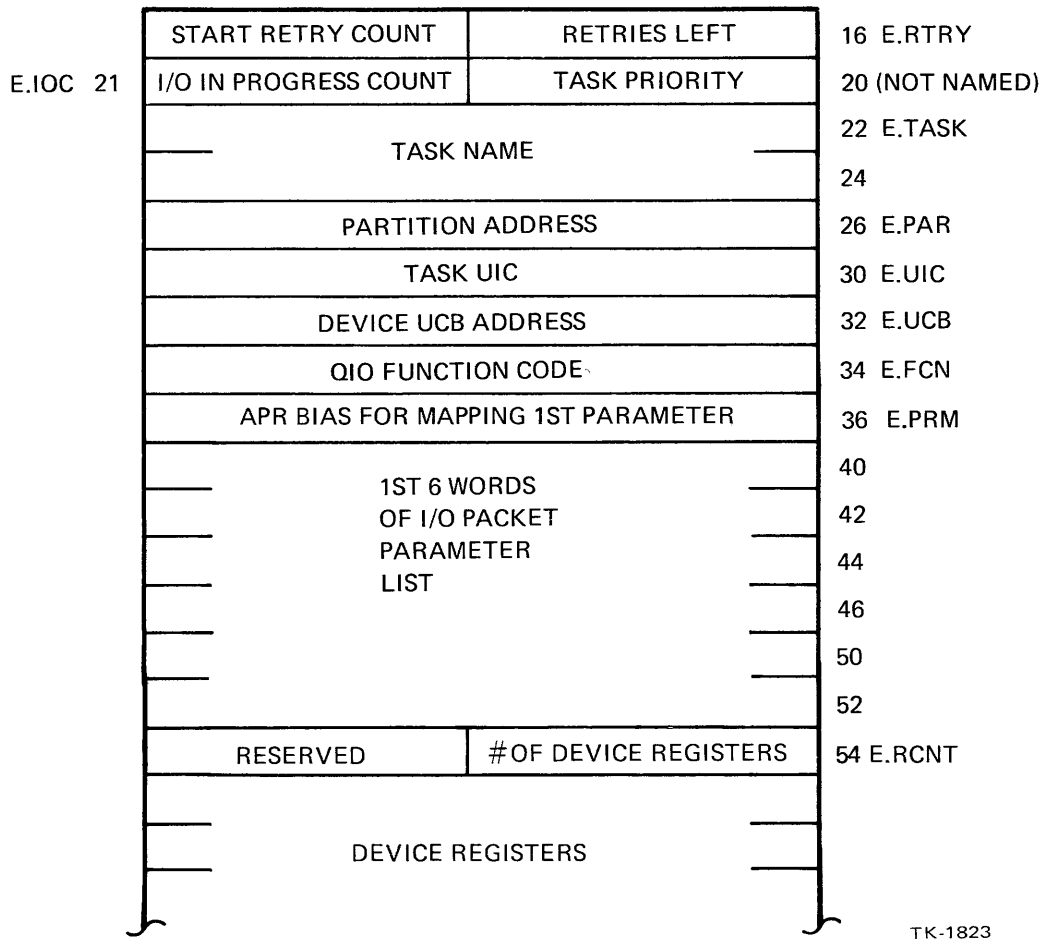

Figure 11 Error Message Block (EMB): Device Errors and Device Timeouts

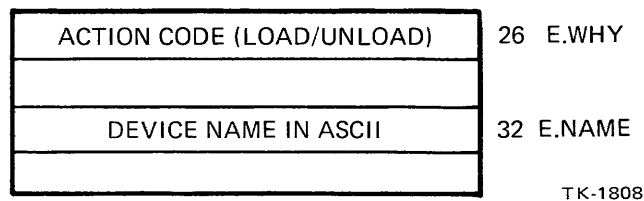
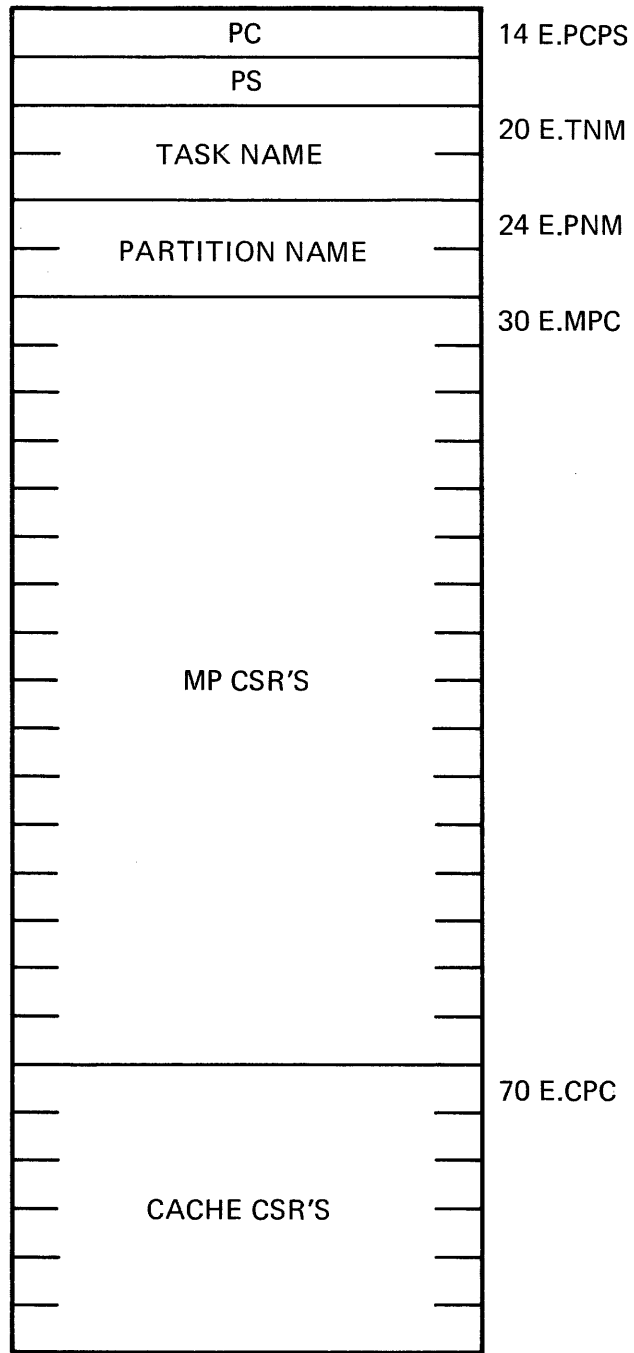

Figure 12 Error Message Block (EMB): Driver Load and Unload

DATA STRUCTURES AND LISTS



TK-7936

Figure 13 Error Message Block (EMB): Memory and Cache Parity Errors

DATA STRUCTURES AND LISTS

1	EC.DVC	DEVICE ERROR BIT SET
2	EC.MPE	MEMORY PARITY ERROR
4	EC.LOA	DRIVER LOAD
10	EC.UNL	DRIVER UNLOAD
40	EC.INI	ERROR LOGGING INITIALIZATION
41	EC.STO	ERROR LOGGING STOPPED
42	EC.PWR	POWER FAILURE
47	EC.SSM	SYSTEM SERVICE MESSAGE
50	EC.MCF	MODIFIED CONFIGURATION INFO
51	EC.ICF	INITIAL CONFIGURATION INFO
52	EC.TIM	CHANGE SYSTEM TIME EMB
100	EC.MOU	MOUNT DEVICE EMB
101	EC.DMO	DISMOUNT DEVICE EMB
140	EC.DTO	DEVICE INTERRUPT TIMEOUT
141	EC.NSI	UNDEFINED INTERRUPTS

TK-3812

Figure 14 Error Codes (E.CODE in EMB)

DATA STRUCTURES AND LISTS

	POINTER TO NEXT FCB		0 F.LINK
	FILE NUMBER (ID)		2 F.FNUM
	FILE SEQUENCE NUMBER		4 F.FSEQ
F.FSQN 7	FILE SEGMENT		6 UNUSED
	FILE OWNER UIC		10 F.FOWN
	FILE PROTECTION CODE		12 F.FPRO
F.SCHA 15	SYSTEM CONTROL CHAR.	USER CONTROLLED CHAR	14 F.UCHA
	FILE HEADER		16 F.HDLB
	LOGICAL BLOCK NUMBER		20
	LOGICAL BLOCK # OF VBN 1 IF FILE IS CONTIGUOUS, 0 OTHERWISE		22 F.LBN
	SIZE OF FILE IN BLOCKS		26 F.SIZE
			30
F.NLCK 33	NUMBER OF LOCKS	NUMBER OF ACCESSES	32 F.NACS
	STATUS BITS	NUMBER OF WRITE ACCESSORS	34 F.STAT/F.NWAC
	DIRECTORY END OF FILE		36 F.DREF
	FIRST WORD OF DIRECTORY NUMBER		40 F.DRNM
	POINTER TO EXTENSION FCB		42 F.FEXT
	FIRST VIRTUAL BLOCK NUMBER IN THIS SEGMENT		44 F.FVBN
			46
	POINTER TO LOCKED BLOCK LIST		50 F.LKL
	POINTER TO WINDOW BLOCK LIST		52 F.WIN

Tk-1838

Figure 15 File Control Block (FCB)

DATA STRUCTURES AND LISTS

BIT MASK OFFSET

7	200	SC.MDL – FILE MARKED FOR DELETE
6	100	SC.BAD – BAD DATA BLOCK IN FILE

TK-1839

Figure 16 System File Characteristics (F.SCHA in FCB)

BIT MASK OFFSET

7	200	UC.CON – LOGICALLY CONTIGUOUS FILE
6	100	UC.DLK – FILE IS LOCKED

TK-1840

Figure 17 User File Characteristics (F.UCHA in FCB)

BIT MASK OFFSET

15	100000	FC.WAC – SET IF FILE ACCESSED FOR WRITE
14	40000	FC.DIR – SET IF FCB IS IN DIRECTORY LRU
13	20000	FC.CEF – SET IF DIRECTORY EOF NEEDS UPDATING
12	10000	FC.FCO – SET IF TRYING TO FORCE DIRECTORY CONTIGUOUS

TK-1809

Figure 18 FCB Status (F.STAT+1 in FCB)

DATA STRUCTURES AND LISTS

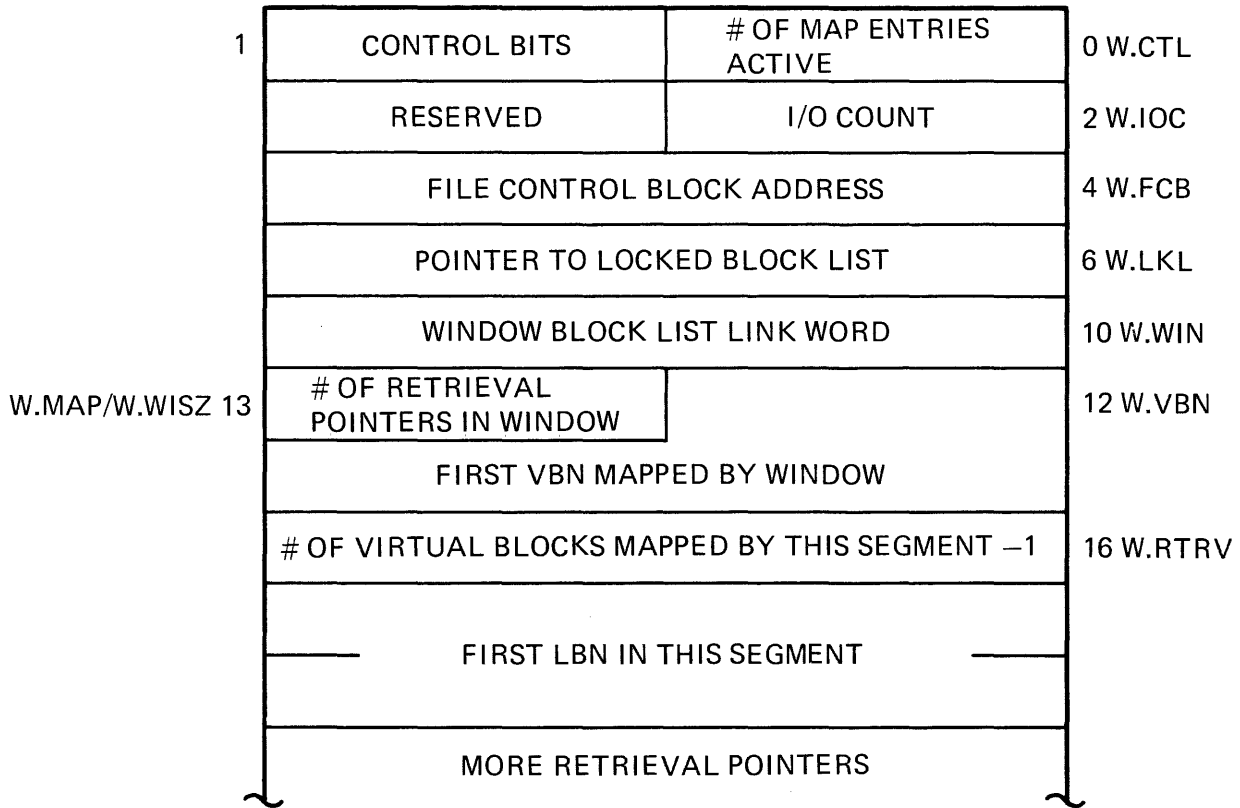

Figure 19 FILES-11 Window Block

BIT	MASK		
15	100000	WI.WCK -	DATA CHECK ALL WRITES TO FILE
14	40000	WI.EXL -	SET IF MANUAL UNLOCK DESIRED
13	20000	WL.PND -	WINDOW TURN PENDING BIT
12	10000	WI.DLK -	SET IF DEACCESS LOCK ENABLED
11	4000	WI.LCK -	SET IF LOCKED AGAINST SHARED ACCESS
10	2000	WI.EXT -	EXTEND ALLOWED IF SET
9	1000	WI.WRV -	WRITE VIRTUAL BLOCK ALLOWED IF SET
8	400	WI.RDV -	READ VIRTUAL BLOCK ALLOWED IF SET

TK-1851

Figure 20 FILES-11 Window Block Control Bits (W.CTL+1 in Window Block)

DATA STRUCTURES AND LISTS

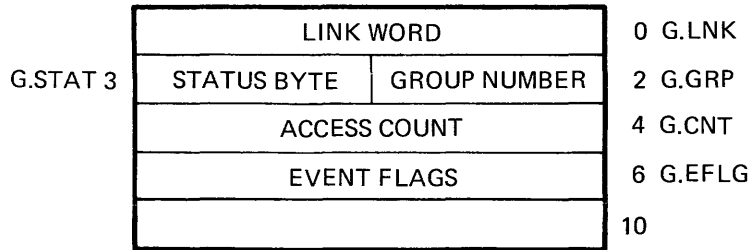

NOTE: STATUS BYTE DEFINITIONS = GS.DEL = 1;
GROUP MARKED FOR DELETE

TK-3255

Figure 21 Group Global Event Flags Block

00 4537	JSR R5,@#\$ INTSE ¹
ADDR OF \$INTSE	
SCB ADDRESS	WORD \$ XXN ¹
177753 (TYPICAL)	WORD ↑ C <P RN > ¹
000400TNNN	BR ISECOM ¹
004537	JSR RS,@#\$ INTSE
ADDR OF \$INTSE	
SCB ADDR.	.WORD \$ XXN
177753 (TYPICAL)	.WORD ↑C <PRN >
0 13746	ISECOM: MOV@#K ISAR5,-(SP)
172 352	
012737	DRIVER RELOCATION BIAS MOV#RELBAS,@ #KISARS
172 352	
004737	JSR PC,@ #- NTSRV
ADDR OF INTERRUPT SERVICE ROUTINE	
012637	MOV (SP) +,@# KISARS
172352	
000207	RETURN

1. THIS SEQUENCE IS REPEATED FOR EACH CONTROLLER AFTER THE FIRST.

TK-1810

Figure 22 Interrupt Control Block (ICB): Error Logging Device

DATA STRUCTURES AND LISTS

113767	
177776	MFPS TEMP ¹
50	
004537	JSR R5,@#\$ INTSV
	ADDR OF \$INTSV
177753(TYPICAL)	.WORD ↑C <PRN >
016704	MOV TEMP, R4 ¹
000036	
043704	BIC ↑C<17>,R4 ¹
177760	
006304	ASL R4 ¹
013746	MOV@#K ISAR5,-(SP)
172352	
012737	
DRIVER RELOCATION BIAS	MOV # RELBAS,@# KISAR5
172352	
004737	JSR PC,@# INTSRV
	ADDRESS OF INTERRUPT SERVICE ROUTINE
012637	MOV (SP)+,@#KISAR5
172352	
000207	RETURN
000000	TEMP: .BLKW 1 ¹

1. MULTI-CONTROLLER DRIVERS

TK-1828

Figure 23 Interrupt Control Block (ICB):
Non-Error Logging Device

DATA STRUCTURES AND LISTS

LINK TO NEXT ITB		0 X.LNK
004737	JSR R5,@#\$INTSC	2 X.JSR
ADDRESS OF \$INTSC		4
UNUSED	LOW BYTE OF PSW FOR ISR	6 X.PSW
INTERRUPT SERVICE ROUTINE ADDRESS (APR 5 MAPPING)		10 X.ISR
LINK TO NEXT FORK BLOCK		12 X.FORK
SAVED PC		
FORKBLOCK	SAVED R5	
SAVED R4		
RELOCATION BIAS FOR APR5		X.REL ¹
ADDRESS OF DISABLE INTERRUPT ROUTINE		X.DSI
TCB ADDRESS OF OWNING TASK		X.TCB
A.DQSR FOR AST BLOCK		
		X.AST ²
AST BLOCK		
VECTOR ADDRESS		X.VEC
SAVED VECTOR PC		X.VPC

- 1. MAPPED SYSTEMS ONLY
- 2. ONLY IF AST SUPPORT

TK-1829

Figure 24 Interrupt Transfer Block

DATA STRUCTURES AND LISTS

I.EFN 3	POINTER TO NEXT I/O PACKET		0 I.LNK	
	EVENT FLAG NUMBER	REQUEST PRIORITY	2 I.PRI	
	TCB ADDRESS OF REQUESTOR		4 I.TCB	
	POINTER TO 2ND LUN WORD		6 I.LN2	
	POINTER TO REDIRECT UCB		10 I.UCB	
	I/O FUNCTION CODE		12 I.FCN	
	I/O STATUS	VIRTUAL ADDRESS		14 I.IOSB
		BLOCK ADDRESS	RELOCATION BIAS	16
			DISPLACEMENT IN BLOCK	20
	AST SERVICE ROUTINE ADDRESS		22 I.AST	
	APR BIAS FOR MAPPING 1ST PARAMETER		24 I.PRM	
			26	
			30	
			32	
	I/O PARAMETER LIST (SIX WORDS)		34	
		36		
		40		
USER MODE DIAGNOSTIC PARAMETER WORD		42		

TK-1830

Figure 25 I/O Packet

L.TYPE 5	POINTER TO NEXT LCB		0 L.LNK
	NAME OF LOGICAL DEVICE (ASCII)		2 L.NAM
	TYPE OF ENTRY ¹	LOGICAL UNIT NUMBER	4 L.UNIT
	UCB ADDRESS OF REQUESTING TERMINAL		6 L.UCB
	ASSIGNMENT UCB ADDRESS		10 L.ASG

¹ -1 = LOGIN
 0 = SYSTEM WIDE
 1 = LOCAL

TK-1831

Figure 26 Logical Assignment Control Block (LCB)

DATA STRUCTURES AND LISTS

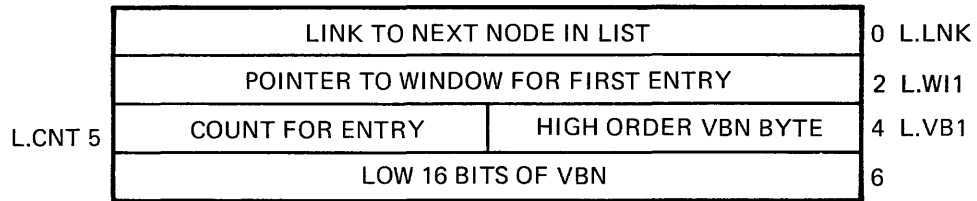

TK-1833

Figure 27 Locked Block List Node

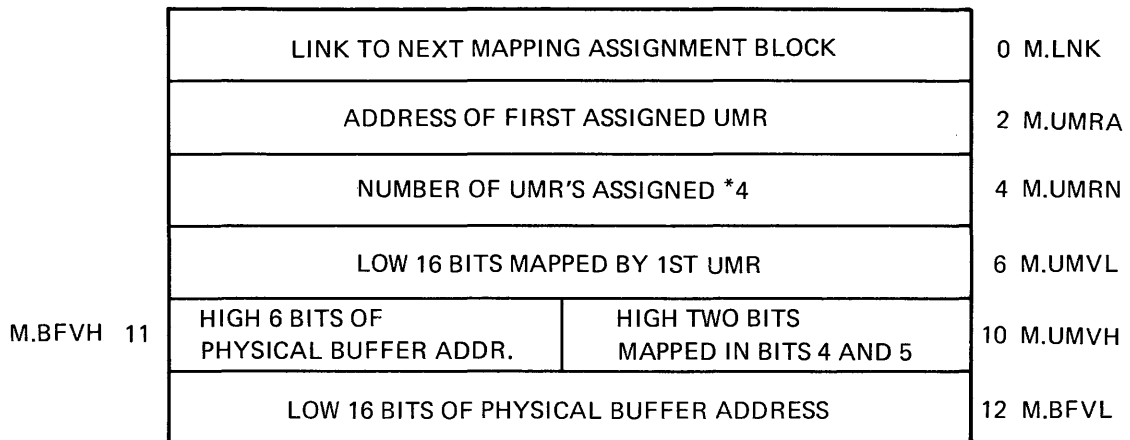

TK-3823

Figure 28 Mapping Assignment Block

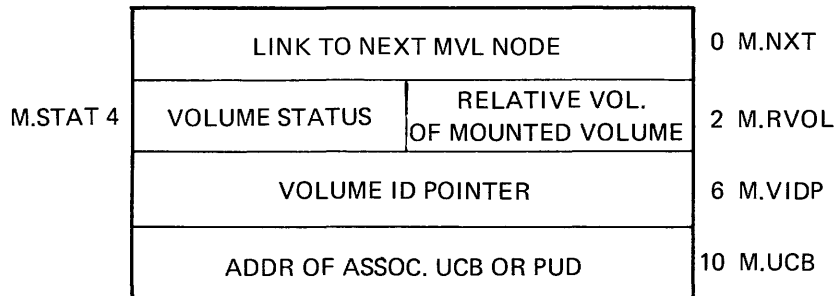

TK-3251

Figure 29 Mounted Volume List Entry (MVL)

DATA STRUCTURES AND LISTS

BIT	MASK		
7	200	MS.VER	VOL ID NOT VERIFIED
3	10	MS.RID	VOL ID TO BE READ NOT CHECKED
2	4	MS.NMO	MOUNT MESSAGE NOT GIVEN YET
1	2	MS.TMO	ONE TIMEOUT ALREADY EXPIRED
0	1	MS.EXP	EXPIRATION DATE MESSAGE GIVEN

TK-3246

Figure 30 Status Values for Mounted Volume (M.STAT in MVL)

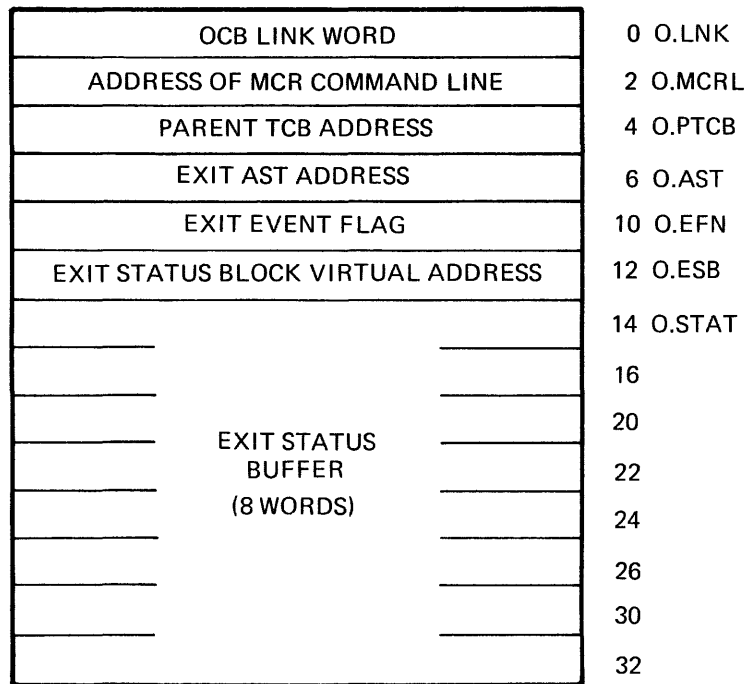

TK-3254

Figure 31 Offspring Control Block (OCB)

DATA STRUCTURES AND LISTS

P.IOC 3	LINK TO NEXT PARTITION PCB		0 P.LNK
	I/O COUNT =0	PRIORITY OF PARTITION	2 P.PRI
	PARTITION NAME		4
	(IN RADIX-50)		6 P.NAM
	POINTER TO NEXT SUB-PARTITION		10 P.SUB
	POINTER TO MAIN		12 P.MAIN
	PHYSICAL START ADDRESS OF PARTITION		14 P.REL ¹ ,P.HDR ²
	SIZE OF PARTITION		16 P.BLKS ¹ ,P.SIZE ¹
	PARTITION WAIT QUEUE LIST HEAD		20 P.WAIT
	PARTITION SWAP SIZE (SYSTEM ONLY)		22 P.SWSZ ³
	PARTITION BUSY FLAGS		24 P.BUSY
	TCB ADDR. OF OWNER/CURRENT UIC OF OWNER TASK		26 P.TCB/P.OWN
	PARTITION STATUS FLAGS		30 P.STAT
	POINTER TO TASK HEADER		32 P.HDR ²
	PROTECTION WORD FOR TASK/COM PARTITION ⁶		34 P.PRO
	ATTACHMENT DESCRIPTOR		36 P.ATT
LIST HEAD		40	

1. 32 WORD BLOCKS FOR MAPPED SYSTEMS
 BYTES FOR UNMAPPED SYSTEMS
2. P.HDR = P.REL IN UNMAPPED SYSTEMS
3. FOR SUB-PARTITIONS OF SYSTEM CONTROLLED PARTITIONS

TK-1836

Figure 32 Partition Control Block (PCB)

DATA STRUCTURES AND LISTS

HIGH BYTE - BUSY BITS

BIT MASK

15	100000	MAIN PARTITION IS BUSY
14	40000	FIRST PARTITION IS BUSY
13	20000	SECOND PARTITION IS BUSY
12	10000	THIRD PARTITION IS BUSY
11	4000	FOURTH PARTITION IS BUSY
10	2000	FIFTH PARTITION IS BUSY
9	1000	SIXTH PARTITION IS BUSY
8	400	SEVENTH PARTITION IS BUSY

LOW BYTE - ID BIT MASK

BIT MASK

7	200	THIS PCB IS FOR MAIN PARTITION
6	100	THIS PCB IS FOR FIRST SUBPARTITION
5	40	THIS PCB IS FOR SECOND SUBPARTITION
4	20	THIS PCB IS FOR THIRD SUBPARTITION
3	10	THIS PCB IS FOR FOURTH SUBPARTITION
2	4	THIS PCB IS FOR FIFTH SUBPARTITION
1	2	THIS PCB IS FOR SIXTH SUBPARTITION
0	1	THIS PCB IS FOR SEVENTH SUBPARTITION

TK-1837

Figure 33 Partition Busy Bits (P.BUSY in PCB)

DATA STRUCTURES AND LISTS

WORLD CLASS ACCESSORS (UIC = [*,*])

BIT	MASK	
15	100000	DELETE ACCESS DENIED
14	40000	EXTEND ACCESS DENIED
13	20000	WRITE ACCESS DENIED
12	10000	READ ACCESS DENIED

GROUP CLASS ACCESSORS (UIC = [G,*])

BIT	MASK	
11	4000	DELETE ACCESS DENIED
10	2000	EXTEND ACCESS DENIED
9	1000	WRITE ACCESS DENIED
8	400	READ ACCESS DENIED

OWNER CLASS ACCESSORS (UIC = [G,M])

BIT	MASK	
7	200	DELETE ACCESS DENIED
6	100	EXTEND ACCESS DENIED
5	40	WRITE ACCESS DENIED
4	20	READ ACCESS DENIED

SYSTEM CLASS ACCESSORS (UIC = [≤10,*])

BIT	MASK	
3	10	DELETE ACCESS DENIED
2	4	EXTEND ACCESS DENIED
1	2	WRITE ACCESS DENIED
0	1	READ ACCESS DENIED

TK-1827

Figure 34 Partition Protection Bits (P.PRO in PCB)

DATA STRUCTURES AND LISTS

BIT MASK		
15	100000	PS.OUT - PARTITION IS OUT OF MEMORY (1 = YES)
14	40000	PS.CKP - PARTITION CHECKPOINT IN PROGRESS (1 = YES)
13	20000	PS.CKR - PARTITION CHECKPOINT IS REQUESTED (1 = YES)
12	10000	PS.CHK - PARTITION IS NOT CHECKPOINTABLE (1 = YES)
11	4000	PS.FXD - PARTITION IS FIXED (1 = YES)
10	2000	PS.PER - PARITY ERROR IN PARTITION (1 = YES)
9	1000	PS.LIO - MARKED BY SHUFFLER FOR LONG I/O (1 = YES)
8	400	PS.NSF - PARTITION NOT SHUFFLABLE (1 = YES)
7	200	PS.COM - LIBRARY OR COMMON BLOCK (1 = YES)
6	100	PS.PIC - POSITION INDEPENDENT LIBRARY OR COMMON (1 = YES)
5	40	PS.SYS - SYSTEM CONTROLLED PARTITION (1 = YES)
4	20	PS.DRV - DRIVER IS LOADED IN PARTITION (1 = YES)
3	10	PS.DEL - PARTITION SHOULD BE DELETED WHEN NOT ATTACHED (1 = YES)
0-2	7	PS.APR - STARTING APR NUMBER MASK

TK-1853

Figure 35 Partition Status Word (P.STAT in PCB)

DATA STRUCTURES AND LISTS

P.IOC 1	POINTER TO NEXT CHECKPOINT PCB	0	P.LNK
	UCB ADDRESS OF CHECKPOINT FILE DEVICE	2	P.UCB
	HI PART OF STARTING LBN	4	P.LBN
	LO PART OF STARTING LBN	6	
	POINTER TO NEXT CHECKPOINT SUBPARTITION CB	10	P.SUB
	POINTER TO CHECKPOINT MAIN PARTITION CB	12	P.MAIN
	RELATIVE BLOCK NO.WITHIN CHECKPOINT FILE	14	P.REL
	SIZE OF CHECKPOINTED TASK (IN DISK BLOCKS)	16	P.SIZE

TK-1819

Figure 36 Checkpoint PCB

PONTER TO NEXT BLOCK IN QUEUE	0
SENDER TASK NAME	2
IN RADIX 50	4
	6
	10
	12
	14
	16
	20
SENT DATA (13 WORDS)	22
	24
	26
	30
	32
	34
	36
UCB OF REQUESTING TERMINAL OF SENDER	40
CURRENT UIC OF SENDER	42

TK-1825

Figure 37 Send/Receive Data Block

DATA STRUCTURES AND LISTS

POINTER TO NEXT BLOCK IN QUEUE	0
SENDER TO TCB ADDRESS	2
EVENT FLAG MASK	4
EVENT FLAG MASK ADDRESS	6
REGION ID OF RECEIVER	10
OFFSET IN PARTITION (UNCHECKED FROM SENDER)	12
LENGTH TO MAP (UNCHECKED FROM SENDER)	14
ACCESS RIGHTS OF ATTACHMENT	16
	20
	22
	24
SEND/RECEIVE BUFFER CONTENTS (UNCHECKED)	26
OR 0 IF NOT SPECIFIED	30
	32
	34
	36
	40
	42

TK-1826

Figure 38 Send/Receive-by-Reference Block

DATA STRUCTURES AND LISTS

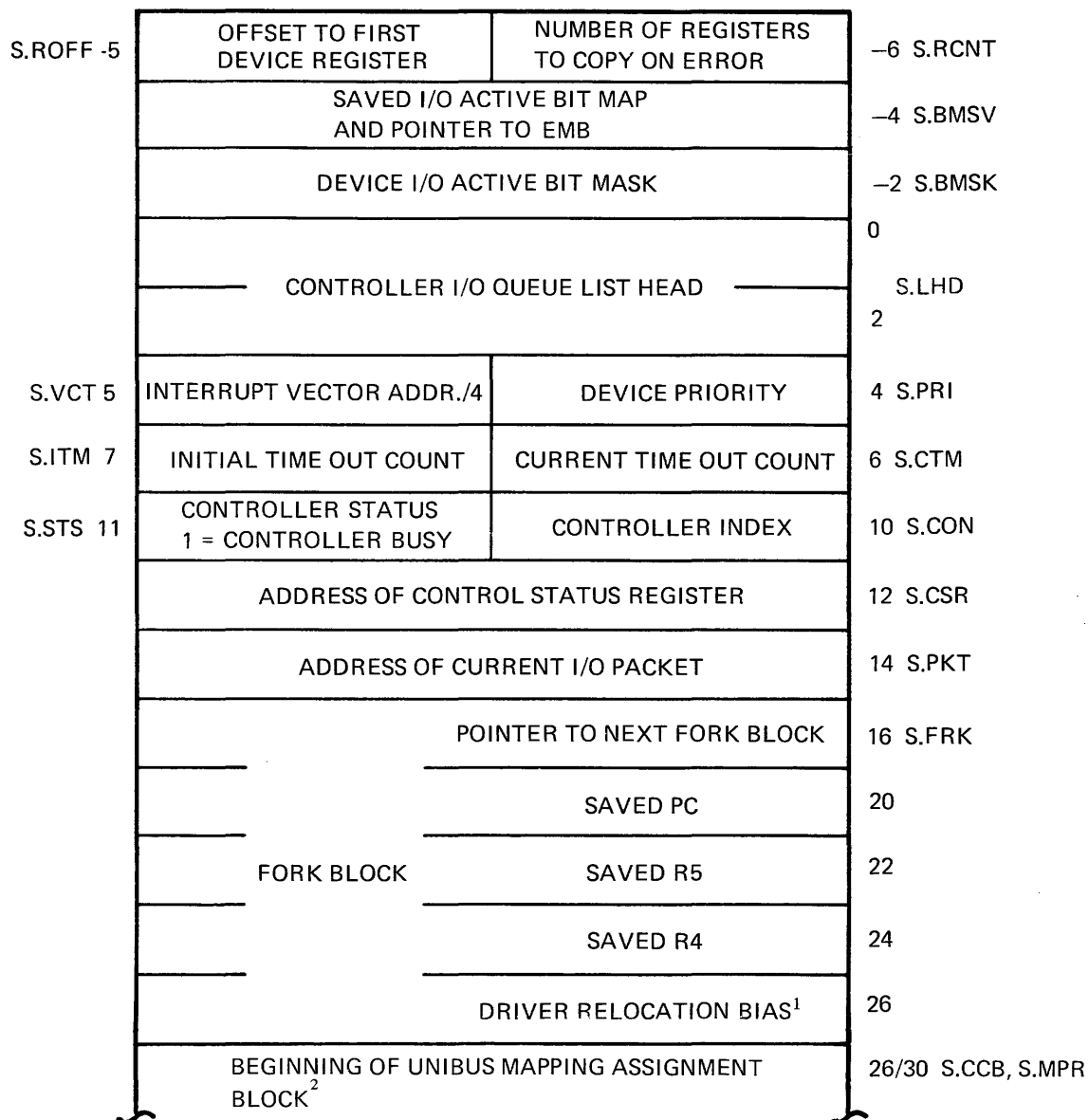

1. FOR MAPPED SYSTEMS WITH LOADABLE DRIVER SUPPORT ONLY
2. SEE MAPPING ASSIGNMENT BLOCK

TK-1843

Figure 39 Status Control Block (SCB)

DATA STRUCTURES AND LISTS

BIT MASK

4-7	360		DEVICE PRIORITY
3	10	SPARE	RESERVED
2	4	SP.LOG	ERROR LOGGING AVAILABLE (1 = YES)
1	2	SP.ENB	ERROR LOGGING ENABLED (0 = YES)
0	1	SP.EIP	ERROR IN PROGRESS (1 = YES)

TK-1865

Figure 40 Device Priority Byte (S.PRI in SCB)

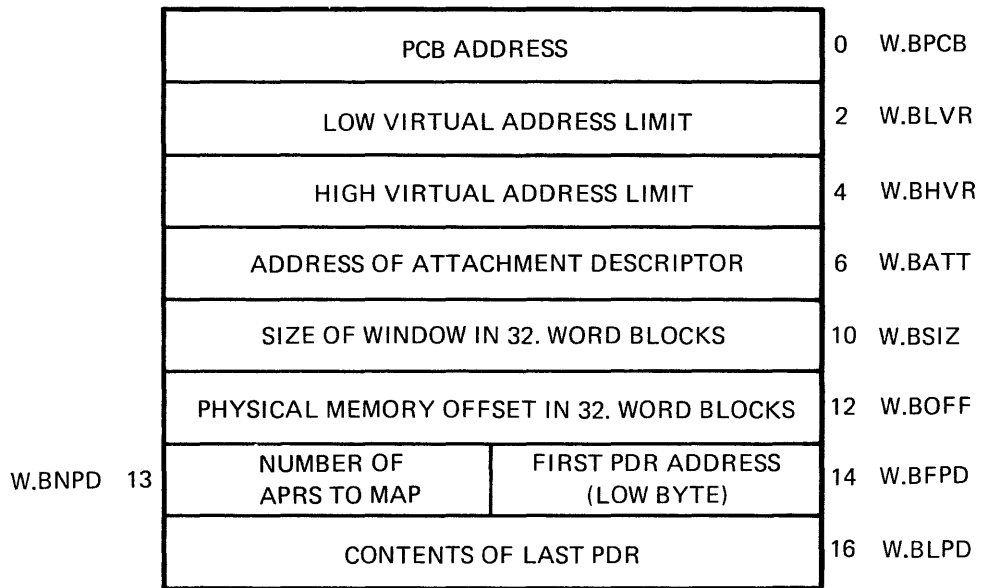

TK-1587

Figure 41 Task Addressing Window Block

DATA STRUCTURES AND LISTS

		UTILITY LINK WORD	0 T.LNK
T.IOC	3	I/O PENDING COUNT TASK PRIORITY	2 T.PRI
		POINTER TO CHECKPOINT PCB	4 T.PCBV
		TASK NAME (IN RADIX-50)	6 T.NAM 10
		RECEIVE QUEUE LISTHEAD	12 T.RCVL 14
		AST QUEUE LISTHEAD	16 T.ASTL 20
		TASK LOCAL EVENT FLAGS 1-32	22 T.EFLG 24
		UCB ADDRESS FOR PSEUDO DEVICE 'TI'	26 T.UCB
		TASK LIST THREAD WORD	30 T.TCBL
		1ST STATUS WORD (BLOCKING BITS)	32 T.STAT
		2ND STATUS WORD (STATE BITS)	34 T.ST2
		3RD STATUS WORD (ATTRIBUTE BITS)	36 T.ST3
T.LBN	41	DEFAULT PRIORITY	40 T.DPRI
		LBN OF TASK IMAGE FILE	
		UCB ADDRESS OF LOAD DEVICE	44 T.LDV
		PCB ADDRESS OF TASK PARTITION	46 T.PCB
		MAXIMUM SIZE OF TASK IMAGE	50 T.MXSZ ¹
		ADDRESS OF NEXT TCB IN ATL	52 T.ACTL
		SPECIFIED AST LIST HEAD	54 T.SAST
T.TIO	57	BUFFERED I/O COUNT RESERVED	
		TASK SIZE	60 T.TKSZ ²

1. USED IN MAPPED SYSTEMS ONLY
2. IN UNMAPPED SYSTEMS, SIZE IN BYTES
IN MAPPED SYSTEMS, SIZE IN 32-WORD BLOCKS

TK-1867

Figure 42 Task Control Block (TCB): Fixed Part

DATA STRUCTURES AND LISTS

IF PLAS DIRECTIVES:

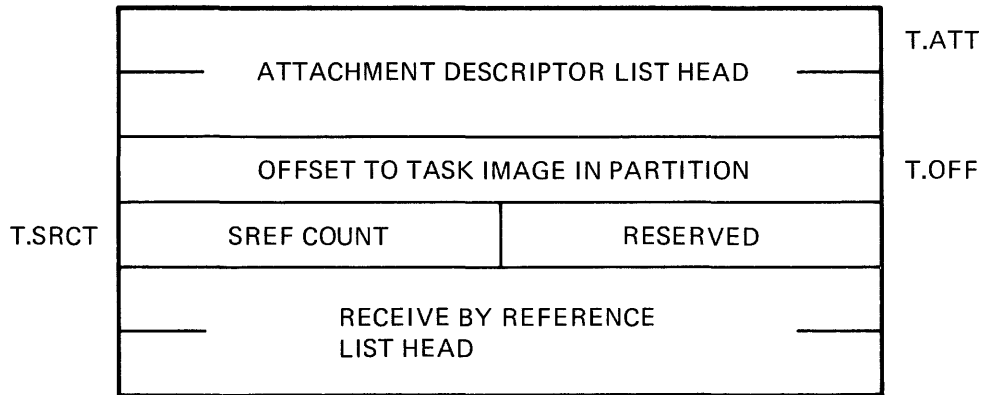

IF PARENT/OFFSPRING SUPPORT:

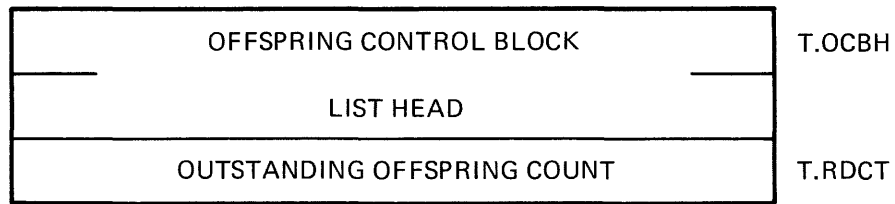

IF STOP-BIT SYNCHRONIZATION AND DRIVER-BUFFERED TERMINAL I/O:

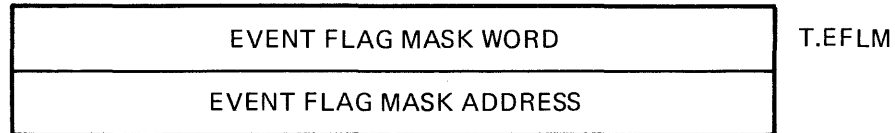

IF EXTERNAL HEADER SUPPORT:

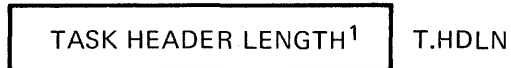

1. LENGTH GIVEN IN 32-WORD BLOCKS

IF GROUP GLOBAL EVENT FLAGS, AND EITHER SEND/RECEIVE DIRECTIVES OR ALTERNATE CLI'S:



TK-7939

Figure 43 Task Control Block (TCB): Conditional Parts

DATA STRUCTURES AND LISTS

BIT MASK

15	100000	TS.EXE - TASK NOT IN EXECUTION (1 = YES)
14	40000	TS.RDN - I/O RUNDOWN IN PROGRESS (1 = YES)
13	20000	TS.MSG - ABORT MESSAGE BEING OUTPUT (1 = YES)
12	10000	TS.NRP - TASK MAPPED TO NON RESIDENT PARTITION (1 = YES)
11	4000	TS.RUN - TASK IS RUNNING ON ANOTHER PROCESSOR (1=YES)
10	2000	TS.HLD - TASK HALF-LOADED BY TASK LOADER (1 = YES)
9	1000	TS.STP - TASK EXTERNALLY BLOCKED VIA CLI COMMAND (1 = YES)
8	400	TS.OUT - TASK IS OUT OF MEMORY (1 = YES)
7	200	TS.CKP - TASK IS BEING CHECKPOINTED (1 = YES)
6	100	TS.CKR - TASK CHECKPOINTING REQUESTED (1 = YES)
5	40	(RESERVED)
4	20	(RESERVED)
3	10	(RESERVED)
2	4	(RESERVED)
1	2	(RESERVED)
0	1	(RESERVED)

TK-1842

Figure 44 Task Status Word (T.STAT in TCB)

DATA STRUCTURES AND LISTS

BIT MASK

15	100000	T2.AST - AST IN PROGRESS (1 = YES)
14	40000	T2.DST - AST RECOGNITION DISABLED (1 = YES)
13	20000	T2.CHK - TASK NOT CHECKPOINTABLE (1 = YES)
12	10000	T2.CKD - TASK CHECKPOINTING DISABLED (1 = YES)
11	4000	T2.SEF - TASK STOPPED FOR EVENT FLAGS (1 = YES)
10	2000	T2.FXD - TASK IS FIXED IN MEMORY (1 = YES)
9	1000	T2.REX - ABORT AST EFFECTED OR IN PROGRESS (1 = YES)
8	400	T2.CAF - DYN. CHECKPOINT SPACE ALLOC. FAILURE
7	200	T2.HLT - TASK IS BEING HALTED (1 = YES)
6	100	T2.ABO - TASK MARKED FOR ABORT (1 = YES)
5	40	T2.STP - SAVED T2.STP ON AST IN PROGRESS
4	20	T2.STP - TASK STOPPED (1 = YES)
3	10	T2.SPN - SAVED T2.SPN ON AST IN PROGRESS
2	4	T2.SPN - TASK SUSPENDED (1 = YES)
1	2	T2.WFR - SAVED T2.WFR ON AST IN PROGRESS
0	1	T2.WFR - TASK IN WAIT FOR STATE (1 = YES)

TK-1863

Figure 45 Second Task Status Word (T.ST2 in TCB)

DATA STRUCTURES AND LISTS

BIT MASK

15	100000	T3.ACP - ANCILLARY CONTROL PROCESSOR (1 = YES)
14	40000	T3.PMD - INHIBIT POST MORTEN DUMP (/PM) (1 = INHIBIT DUMP) (0 = DUMP)
13	20000	T3.REM - REMOVE TASK ON EXIT (1 = YES)
12	10000	T3.PRIV - TASK IS PRIVILEGED (/PR) (1 = YES)
11	4000	T3.MCR - TASK REQUESTED AS EXTERNAL MCR FUNCTION (1 = YES)
10	2000	T3.SLV - TASK IS A SLAVE TASK (/SL) (1 = YES)
9	1000	T3.CLI - TASK IS A COMMAND LINE INTERPRETER (1 = YES)
8	400	T3.RST - TASK IS RESTRICTED (1 = YES)
7	200	T3.NSD - TASK DOES NOT ALLOW SEND DATA (/SE)
6	100	T3.CAL - CHECKPOINT SPACE ALLOCATED IN TASK IMAGE (/AC)
5	40	T3.ROV - TASK HAS RESIDENT OVERLAYS
4	20	T3.NET - TASK USES REVISED NETWORK PROTOCOL
3	10	T3.GFL - TASK HAS ITS GROUP GLOBAL EF'S LOCKED
2	4	(RESERVED)
1	2	(RESERVED)
0	1	(RESERVED)

TK-1864

Figure 46 Third Task Status Word (T.ST3 in TCB)

DATA STRUCTURES AND LISTS

CURRENT STACK POINTER	0 H.CSP
HEADER LENGTH IN BYTES	2 H.HDLN
EVENT FLAG MASK	4 H.EFLM
EVENT FLAG MASK ADDRESS	6
CURRENT UIC	10 H.CUIC
DEFAULT UIC	12 H.DUIC
INITIAL PS	14 H.IPS
INITIAL PC	16 H.IPC
INITIAL STACK POINTER	20 H.ISP
ODT SST VECTOR ADDRESS	22 H.ODVA
ODT SST VECTOR LENGTH IN BYTES	24 H.ODVL
TASK SST VECTOR ADDRESS	26 H.TKVA
TASK SST VECTOR LENGTH IN BYTES	30 H.TKVL
POWERFAIL AST CONTROL BLOCK ADDRESS	32 H.PFVA
FLOATING-POINT AST CONTROL BLOCK ADDRESS	34 H.FPVA
RECEIVE AST CONTROL BLOCK ADDRESS	36 H.RCVA

TK-1861

Figure 47 Task Header: Fixed Part

DATA STRUCTURES AND LISTS

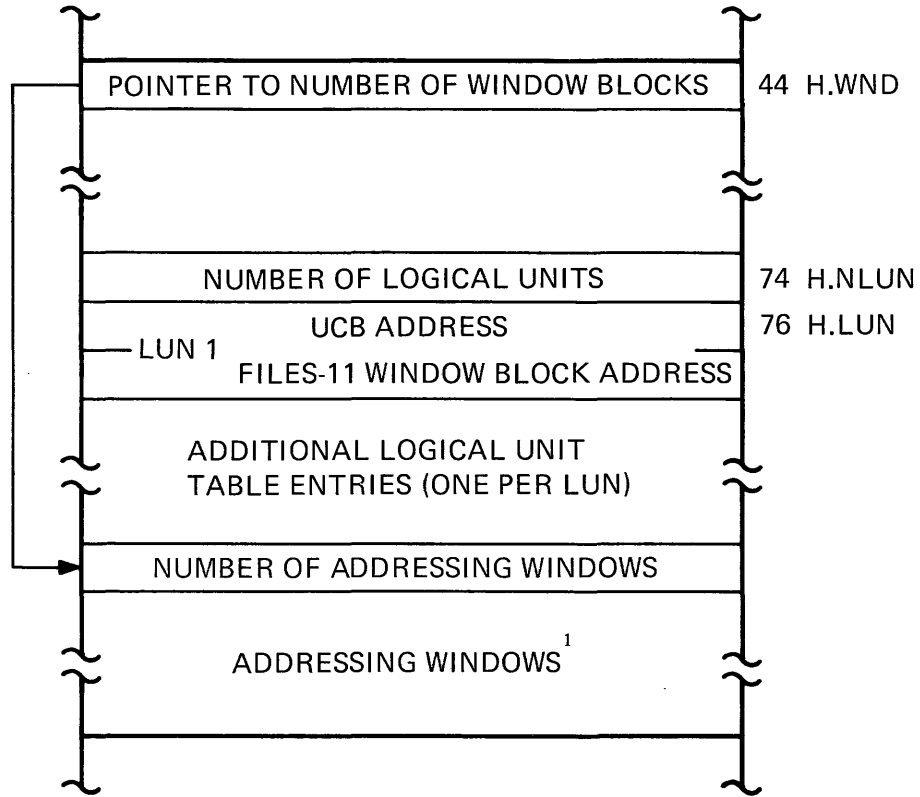

¹ SEE TASK ADDRESSING WINDOW FIGURE

TK-7940

Figure 48 Task Header: Variable Part

DATA STRUCTURES AND LISTS

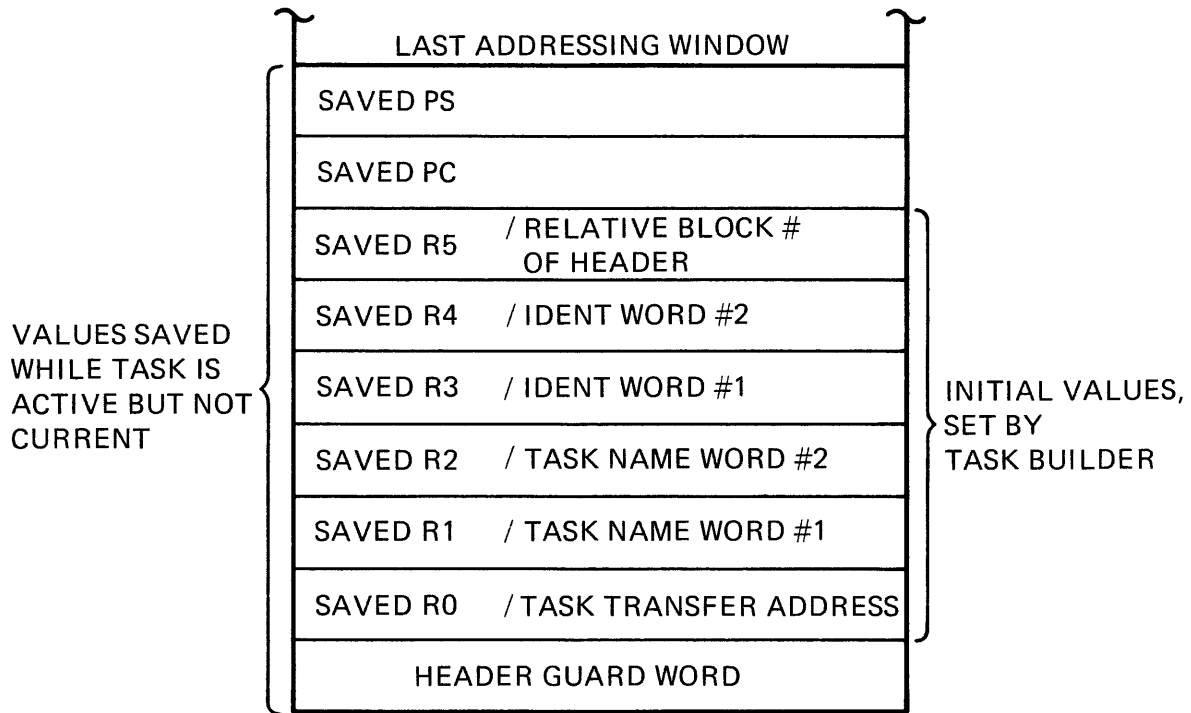

TK-7941

Figure 49 Task Header: Termination of Variable Part

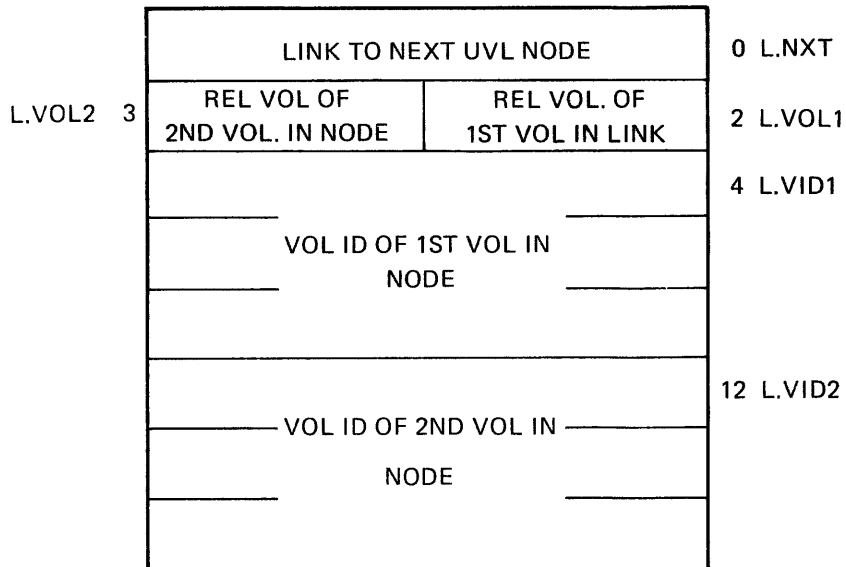

TK-3250

Figure 50 Unmounted Volume List Node (UVL)

DATA STRUCTURES AND LISTS

		UCB ADDRESS OF OWNING TERMINAL	-2	U.OWN ¹
		BACK POINTER TO DCB	0	U.DCB
		POINTER TO REDIRECT UNIT UCB	2	U.RED
U.STS	5	UNIT STATUS	4	U.CTL
		CONTROL FLAGS		
U.ST2	7	UNIT STATUS EXTENTION	6	U.UNIT
		PHYSICAL UNIT NUMBER		
		1ST DEVICE CHARACTERISTICS WORD	10	U.CW1
		2ND DEVICE CHARACTERISTICS WORD	12	U.CW2
		3RD DEVICE CHARACTERISTICS WORD	14	U.CW3
		4TH DEVICE CHARACTERISTICS WORD	16	U.CW4
		POINTER TO SCB	20	U.SCB
		TCB ADDRESS OF ATTACHED TASK	22	U.ATT
		CURRENT BUFFER ADDRESS	24	U.BUF
		RELOCATION BIAS DISPLACEMENT	26	
		CURRENT BYTE COUNT	30	U.CNT

1. MULTI-USER PROTECTION SYSTEMS

TK-1859

Figure 51 Unit Control Block (UCB): Fixed Part

		I/O COUNT SINCE MOUNT	-10/-12	U.IOC
U.ERHL	-5/-7	HARD ERROR LIMIT	-4/-6	U.ERSL
		SOFT ERROR LIMIT		
U.ERHC	-3/-5	HARD ERROR COUNT	-2/-4	U.ERSC
		SOFT ERROR COUNT		

TK-7930

Figure 52 UCB Prefix for Error Logging Devices

TCB OF CLI/MULTIUSER PROTECTION FLAG	-6	U.CLI/U.MUP
LOGIN UIC	-4	U.LUIC ¹

1. USED IN MULTIUSER SYSTEMS ONLY

TK-7931

Figure 53 UCB Prefix for Terminals

DATA STRUCTURES AND LISTS

ADDRESS OF TCB OF ACP ¹	32	U.ACP
ADDRESS OF VCB ¹	34	U.VCB

1. USED FOR MOUNTED VOLUMES ONLY

TK-7932

Figure 54 End of UCB for FILES-11 Devices

		POINTER TO UCB EXTENSION (UCBX)	24	U.TUX ¹
		STATUS TRIPLE-WORD	26	U.TSTA
		TYPE-AHEAD BUFFER OR POINTER ²	34	U.TTAB
U.TFRQ	37	FORK REQUEST BYTE	36	U.LPP
		LINES PER PAGE		
		FORK LIST LINK WORD	40	U.TFLK
U.TCVP	43	CURRENT VERTICAL POSITION	42	U.TCHP
		CURRENT HORIZONTAL POSITION		
		TERMINAL UIC	44	U.UIC
U.TMTI	47	MODEM TIMER	46	U.TTYP
		TERMINAL TYPE		
		CONTROLLER TYPE	50	U.CTYP

1 - NOTE THAT U.TUX = U.BUF

2 - IF U.TTAB = 0 THEN U.TTAB+1 IS A SINGLE CHARACTER TYPE-AHEAD BUFFER, CURRENTLY EMPTY

IF U.TTAB IS ODD THEN U.TTAB+1 IS A SINGLE CHARACTER TYPE-AHEAD BUFFER AND HOLDS A CHARACTER

IF U.TTAB IS NON-0 AND EVEN THEN U.TTAB IS A POINTER TO A MULTICHARACTER TYPE-AHEAD BUFFER

TK-7933

Figure 55 End of UCB for Terminals

DATA STRUCTURES AND LISTS

BIT	MASK	
7	200	UC. ALG – BYTE ALIGNMENT ALLOWED (1 = NO)
6	100	UC. NPR – DEVICE IS AN NPR DEVICE (1=YES)
5	40	UC. QUE – CALL DRIVER BEFORE QUEUING (1=YES)
4	20	UC. PWF – CALL DRIVER AT POWERFAIL ALWAYS (1=YES)
3	10	UC. ATT – CALL DRIVER ON ATTACH/DETACH (1=YES)
2	4	UC. KIL – CALL DRIVER AT I/O KILL ALWAYS (1=YES)
0-1	3	UC.LGH – TRANSFER LENGTH MASK BITS
1	2	} USE FOR UC.LGH
0	1	

TK-1855

Figure 56 Unit Control Processing Flags (U.CTL in UCB)

DATA STRUCTURES AND LISTS

BIT MASK		
7	200	US.BSY – UNIT IS BUSY (1 = YES)
6	100	US.MNT – UNIT IS MOUNTED 1 = YES
5	40	US.FOR – UNIT IS MOUNTED AS FOREIGN (1=YES)
4	20	US.MDM – UNIT IS MARKED FOR DISMOUNT (1 = YES)
2	10	US.PWF - POWERFAIL OCCUR (1=YES)

UNIT STATUS BIT (DEVICE-INDEPENDENT)

BIT MASK		
3	10	US.WCK – WRITE CHECK ENABLED (1 = YES)
2	4	RESERVED
1	2	US.SPU – UNIT IS SPINNING UP (1 = YES)
0	1	US.VV – VOLUME VALID IS SET (1 = YES)

FILES – 11 – DEPENDENT

TK-1856

BIT MASK		
3	10	US.DSB – UNIT IS DISABLED (1 = YES)
2	4	US.CRW – UNIT IS WAITING FOR CARRIER (1 = YES)
1	2	US.ECH – UNIT HAS ECHO IN PROGRESS (1 = YES)
0	1	US.OUT – UNIT IS EXPECTING OUTPUT INTERRUPT (1 = YES)

TERMINAL-DEPENDENT

TK-1857

BIT MASK		
2	4	US.CRW – UNIT IS WAITING FOR CARRIER (1 = YES)
1	2	US.DSB – UNIT IS DISABLED (1 = YES)
0	1	US.OIU – OUTPUT INTERRUPT IS EXPECT ON UNIT (1 = YES)

FULL DUPLEX TERMINAL DRIVER

TK-1858

Figure 57 Unit Status Flags (U.STS in UCB)

DATA STRUCTURES AND LISTS

BIT MASK		
4	20	US.PDF – PRIVILEGED DIAGNOSTIC FUNCTIONS ONLY (1 = YES)
3	10	US.UMD – UNIT IS ATTACHED FOR DIAGNOSTICS (1 = YES)
2	4	US.PUB – UNIT IS A PUBLIC DEVICE (1 = YES)
1	2	US.RED – UNIT IS REDIRECTABLE (0 = YES)
0	1	US.OFL – UNIT IS OFF-LINE (1 = YES)

TK-1852

Figure 58 Unit Status Extension (U.ST2 in UCB)

BIT MASK		
15	100000	DV.MNT – DEVICE IS MOUNTABLE (1 = YES)
14	40000	DV.F11 – DEVICE MOUNTABLE AS FILES – 11. (1 = YES)
13	20000	DV.COM – DEVICE MOUNTABLE AS COMM. CHANEL (1 = YES)
12	10000	DV.PSE – PSEUDO DEVICE (1 = YES)
11	4000	DV.OSP – OUTPUT SPOOLED DEVICE (1 = YES)
10	2000	DV.ISP – INPUT SPOOLED DEVICE (1 = YES)
9	1000	DV.SWL – DEVICE IS SOFTWARE WRITE LOCKED
8	400	DV.MBC – DEVICE IS ON A MASSBUS CONTROLLER DV.EXT – DEVICE ON EXTENDED ADDRESSING CONTROLLER
7	200	DV.UMD – USED MODE DIAGNOSTICS SUPPORTED (1 = YES)
6	100	DV.MSD – MASS STORAGE DEVICE (1 = YES)
5	40	DV.SQD – SEQUENTIAL DEVICE (1 = YES)
4	20	DV.SDI – SINGLE DIRECTORY DEVICE (1 = YES)
3	10	DV.DIR – FILE STRUCTURED DEVICE (1 = YES)
2	4	DV.TTY – TERMINAL DEVICE (1 = YES)
1	2	DV.CCL – CARRIAGE CONTROL DEVICE (1 = YES)
0	1	DV.REC – RECORD ORIENTED DEVICE (1 = YES)

TK-1849

Figure 59 Device Characteristics Word 1 (U.CW1 in UCB)

DATA STRUCTURES AND LISTS

BIT MASK		
15	100000	U2.DH1 - UNIT IS A MULTIPLEXER (1 = YES)
14	40000	U2.DJ1 - UNIT IS A DJ11 (1 = YES)
13	20000	U2.RMT - UNIT IS REMOTE (1 = YES)
12	10000	U2.HFF - UNIT HANDLES HARDWARE FORM FEEDS (1 = YES)
11	4000	U2.NEC - DON'T ECHO SOLICITED INPUT (1 = YES)
10	2000	U2.CRT - UNIT IS A CRT (1 = YES)
9	1000	U2.ESC - UNIT GENERATES ESCAPE SEQUENCE (1 = YES)
8	400	U2.LOG - USER LOGGED ON TERMINAL (0 = YES)
7	200	U2.SLV - UNIT IS A SLAVE TERMINAL (1 = YES)
6	100	U2.DZ1 - UNIT IS A DZ11 (1 = YES)
5	40	U2.HLD - TERMINAL IS IN HOLD SCREEN MODE (1 = YES)
4	20	U2.AT - MCR COMMAND AT BEING PROCESSED (1 = YES)
3	10	U2.PRV - MCR COMMAND AT BEING PROCESSED (1 = YES)
2	4	U2.L3S - UNIT IS A LA30S TERMINAL (1 = YES)
1	2	U2.VT5 - UNIT IS A VTO=ZERO TERMINAL (1 = YES)
0	1	U2.LWC - CONVERT LOWERCASE TO UPPER (1 = YES)

TK-1850

Figure 60 Device Characteristics Word 2 (U.CW2 in UCB)

DATA STRUCTURES AND LISTS

BIT	MASK	
15	100000	S1.IBF - BUFFERED INPUT IN PROGRESS
14	40000	S1.OBF - BUFFERED OUTPUT IN PROGRESS
13	20000	S1.USI - UNSOLICITED INPUT IN PROGRESS
12	10000	S1.CTS - OUTPUT STOPPED BY CTRL-S
11	4000	S1.DSI - INPUT PROCESSING DISABLED
10	2000	S1.DEC - DEFER ECHO OF CHAR. IN U.TECB
9	1000	S1.DPR - DEFER PROCESSING OF CHAR. IN U.TECB
8	400	S1.BEL BELL PENDING
7	200	S1.IBY INPUT BUSY
6	100	S1.OBY OUTPUT BUSY
5	40	S1.CTO OUTPUT STOPPED BY CTRL-O
4	20	S1.RNE ECHO SUPPRESSED
3	10	S1.RAL READ ALL IN PROGRESS
2	4	S1.ESC ESCAPE SEQUENCE IN PROGRESS
1	2	S1.RUB ROUBOUT SEQUENCE IN PROGRESS (NON-SCOPE)
0	1	S1.RST READ WITH SPECIAL TERMINATORS IN PROGRESS

TK-3259

Figure 61 Terminal Driver Status Word 1 (U.TSTA in UCB)

DATA STRUCTURES AND LISTS

BIT	MASK	
15	100000	S2.FDX - LINE IS IN FULL DUPLEX MODE
14	40000	S2.FLF - FORCE LINE FEED BEFORE NEXT ECHO
13	20000	S2.HFF - HARDWARE FORM-FEED PRESENT
12	10000	S2.HHT - HARDWARE HORIZONTAL TAB PRESENT
11	4000	S2.VFL - VERTICAL FILL REQUIREMENT
8 - 10	3400	S2.HFL - HORIZONTAL FILL REQUIREMENT
10	2000	} USE FOR S2.HFL
9	1000	
8	400	
7	200	S2.IRQ - INPUT REQUEST IN QUEUE (MUST=S1.IBY)
6	100	S2.ORQ - OUTPUT REQUEST IN QUEUE (MUST=S1.OBY)
5	40	S2.SRQ - SPECIAL REQUEST QUEUE (IO.ATT, IO.DET, SF.SMC)
4	20	S2.BRQ - BREAK THROUGH - WRITE REQUEST IN QUEUE
3	10	S2.CR - TRAILING CR REQUIRED ON OUTPUT
1 - 2	6	S2.WRA - CONTEXT FOR WRAP AROUND
2	4	USED FOR S2.WRA
1	2	S2.WRB - LOW BIT IN S2.WRA BIT PATTERN
0	1	S2.ACR - WRAP AROUND (AUTOMATIC CRLF) REQUIRED

TK-3260

Figure 62 Terminal Driver Status Word 2 (U.TSTA+2 in UCB)

DATA STRUCTURES AND LISTS

BIT	MASK	
15	100000	S3.PCU - POSITION CURSOR (MUST = TF.PCU*400)
14	40000	S3.DAO - LAST CHAR. IN TYPE-AHEAD BUFFER HAS DATA OVERRUN ERROR ¹
13	20000	S3.BCC - LAST CHAR. IN TYPE-AHEAD BUFFER HAS FRAMING ERROR
12	10000	S3.VER - LAST CHAR. IN TYPE-AHEAD BUFFER HAS PARITY ERROR
11	4000	S3.WAL - WRITE-PASS-ALL (MUST = TF.WAL*400)
10	2000	S3.ABP - AUTO-BAUD SPEED DETECTION IN PROGRESS
9	1000	S3.ABD - AUTO-BAUD SPEED DETECTION ENABLED
8	400	S3.RCU - RESTORE CURSOR (MUST = TF.RCU*400)
7	200	S3.8BC - PASS 8 BITS ON INPUT
6	100	S3.TAB - TYPE-AHEAD BUFFER ALLOCATION REQUESTED
5	40	S3.WES - TASK WANTS ESCAPE SEQUENCES
4	20	S3.RPO - READ WITH PROMPT OUTPUT IN PROGRESS
3	10	S3.RAL - TERMINAL IS IN READ-PASS-ALL MODE (S3.RAL MUST = S1.RAL)
2	4	NOT USED
1	2	NOT USED
0	1	NOT USED

1. NOTE - THESE 3 BITS MUST CORRESPOND TO THE RESPECTIVE ERROR FLAGS IN THE HARDWARE RECEIVE BUFFER.

TK-3258

Figure 63 Terminal Driver Status Word 3 (U.TSTA+4 in UCB)

