

May, 1963

# computers and automation

The Need for Faster Computers

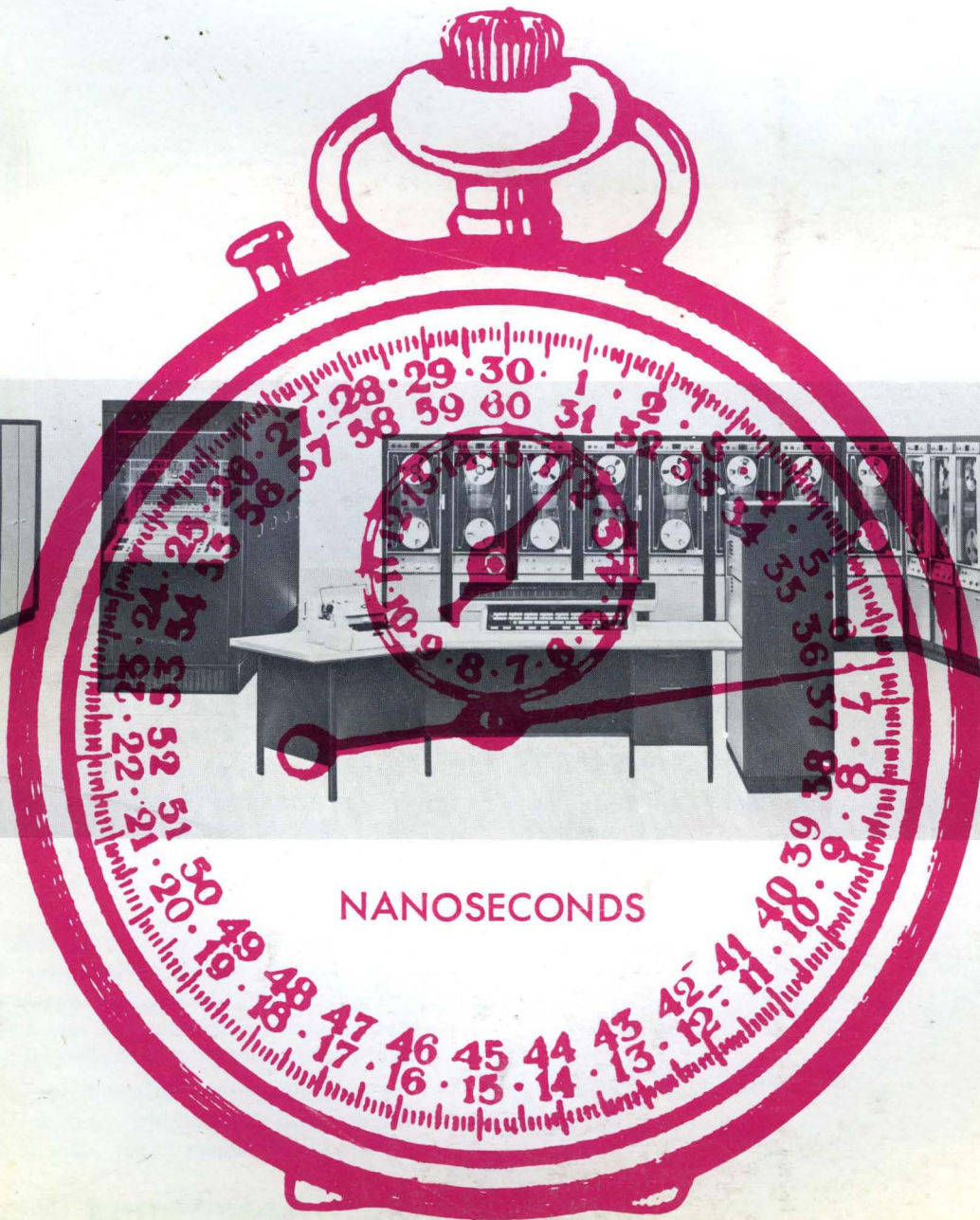

NANOSECONDS

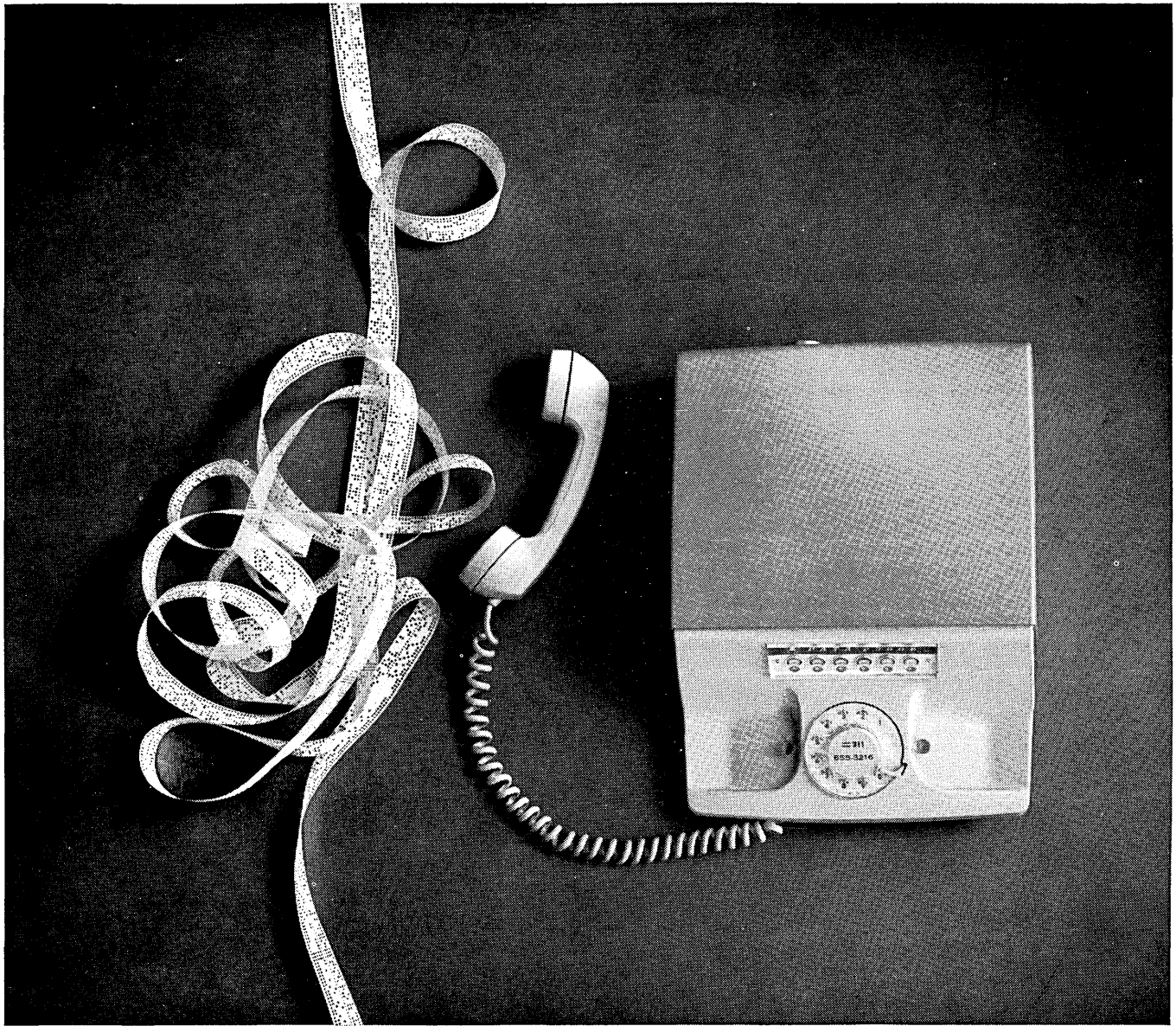

## How do you teach perforated tape to telephone?

No instruction necessary. Just connect Bell System DATA-PHONE service with the machines that process the tape. The rest is automatic.

The DATA-PHONE data sets convert the information punched on the tapes (and read by the business machines) into a special tone language that can be "talked" over regular telephone lines—up to 16 times faster than you talk yourself.

All kinds of taped or card-punched business data can be transmitted this way. At regular telephone rates. It means you can exchange data between your headquarters and outlying branches in a fraction of the time it now takes.

Like to know more? Talk with one of our Communications Consultants. Just call your Bell Telephone Business Office and ask for him.



# Bell Telephone System

# COMPUTER RESEARCH SCIENTISTS

**SALARIES \$10,000 TO \$20,000 +**

Our client is a leading nonprofit organization, located in the Washington, D. C. area, whose end product is reports.

They are comparatively new in the computer sciences field, although very well established as an organization and in other activities. This comparative newness, in conjunction with their determination for excellence, requires new programs and new approaches on their part, and provides exceptional opportunities for advancement and development for those joining them.

Since they are new in this field, they need outstanding professionals to head up and give direction to their work in the areas noted below.

Actually, two types of computer scientists are needed.

Common denominators will be the interest, determination, and ability to push back, if not to hurdle, the frontiers of the "state of the art" in computer science.

**A. ONE GROUP OF PROFESSIONALS WILL WORK INDEPENDENTLY ON PROGRAMS THAT THEY THEMSELVES TAKE THE LEAD IN DEVELOPING AND FORMULATING.**

**B. The other group will be just as imaginative and creative, but will work in sponsored areas, with goals laid out a bit more.**

Areas of interest include, but are not limited to:

1. • Machine problem or procedure oriented languages
  - Pattern recognition
  - Programmed learning
  - Artificial intelligence
  - On-line programming
  - To work on research in computer science
2. Compiler development for problem or procedure oriented languages. Experience on 7090 machine languages and in machine war gaming useful. To work on compiler for war game oriented languages.
3. Model making and programming of machine war games, machine simulation of military operations, or other military computer applications. Experience in construction and/or maintaining operating systems and compilers desirable, for work on a war game oriented language and compiler study.
4. Developing scientific computer applications. Emphasis in machine language coding for IBM 709 or 7090. Will assist in design, development and maintenance of an operating system for IBM 1401-7040. Will also provide consultation and/or instruction in computing techniques and processes.

Desired backgrounds should include graduate degrees in Mathematics, Engineering, or the Physical Sciences. Candidates, particularly for level A., should also be capable of successfully making verbal and written presentations, and of communicating effectively with non-computer scientists as well.

**We will be in Detroit for the Spring Joint Computer Conference May 20-23, at the Pick-Fort Shelby Hotel. Confidential interviews can be arranged in advance with our client's technical management.**

Interested parties who are not planning to attend are also invited to submit their resumes at the earliest possible date. Interview arrangements will be made for Washington, D. C., and possibly several other major cities.

*WE HAVE OTHER POSITIONS OF A BASICALLY SIMILAR NATURE, AS WELL AS OPENINGS COVERING EVERY PHASE OF THE ELECTRONIC DATA PROCESSING FIELD, WITH OTHER CLIENTS COAST TO COAST.*

Resumes should be as complete as possible. Indicate the type of work sought and include current salary, salary requirements, and geographic areas you will not consider.

All inquiries treated confidentially. All charges and relocation expenses are paid for by our client company.

**Contact: Herbert Halbrecht**

**Herbert Halbrecht Associates, Inc.**

332 SOUTH MICHIGAN AVENUE  
CHICAGO 4, ILLINOIS  
Harrison 7-2876

11691 NATIONAL BLVD.  
LOS ANGELES 64, CALIF.  
Phone: 478-8657

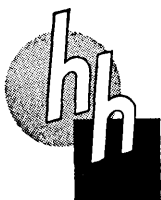

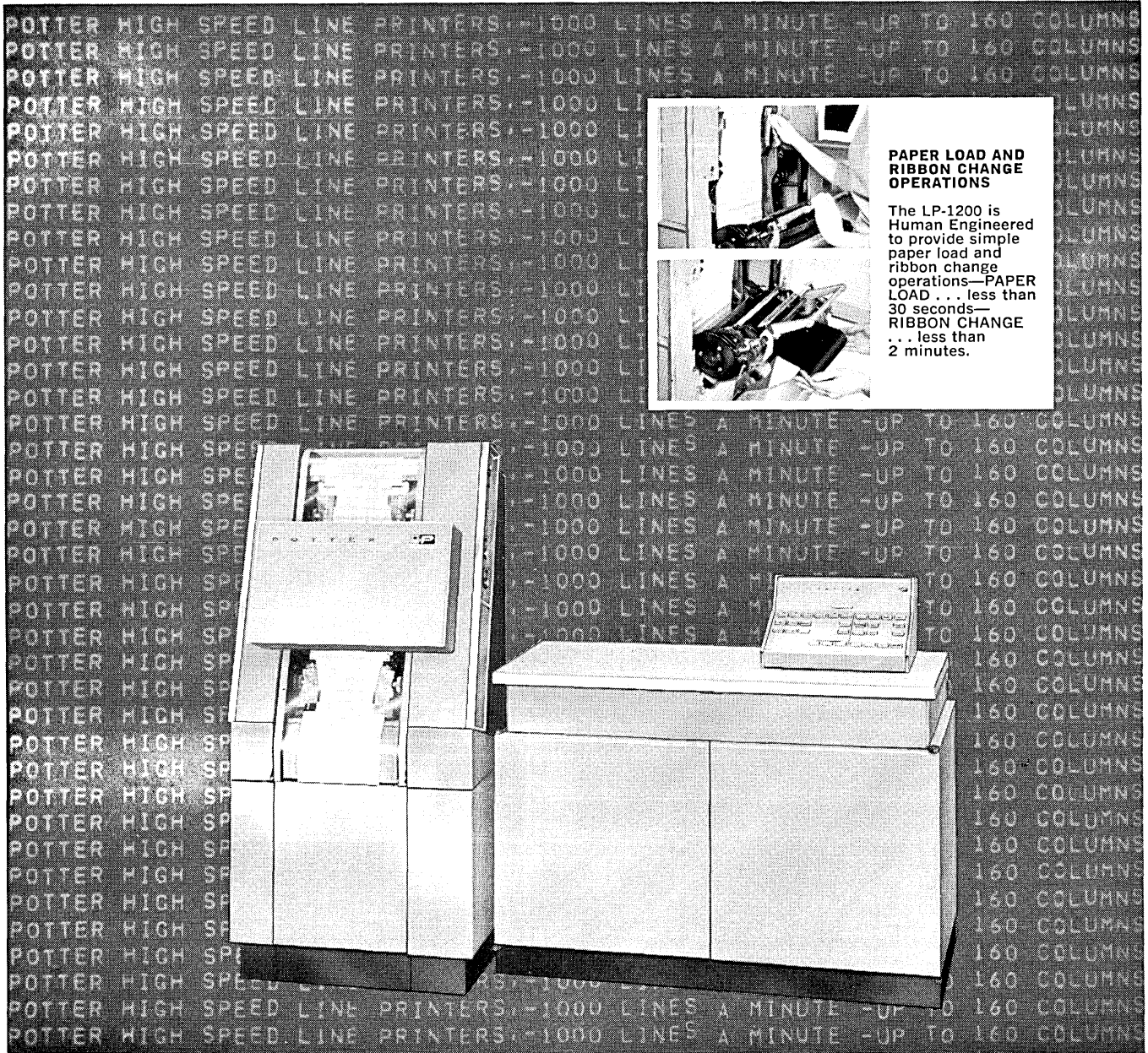

## This Printer System Can Save \$50,000 Per Year In Computer Time!

The LP-1200 High Speed Printer System provides unusual savings of computer time through the use of magnetostrictive delay lines. This innovation permits compatibility with the fastest systems — conserves computer loading time by 20:1 or more!

Is your computer system fast enough to take advantage of LP-1200's performance? If so, our representative can show you how computer time savings of up to \$50,000 a year can be realized. Write today, for full information.

### THE LP-1200 FEATURES:

- **LOW COST BUFFER STORAGE**... Computer proven Magnetostrictive Delay Lines provide compatibility with the fastest computer systems.
- **NEW DELAY LINE AMPLIFIER**... Peak Detection circuit improves reliability at higher frequencies.
- **QUALITY HIGH SPEED PRINT-OUT**... Vacuum Paper control, coupled with high speed paper feed produces clean, sharp impressions.
- **HUMAN ENGINEERING** provides... quick, front paper loading, ease of ribbon change, access to drum and hammers, convenient operating controls.
- **ADDITIONAL FEATURES**... non-wearing Elastomeric torsion bearings assure long hammer life; low inertia drive belts minimize clutch and brake wear.
- **12 WEEK DELIVERY**



**POTTER INSTRUMENT COMPANY, INC.**  
 PRINTER DIVISION • East Bethpage Road • Plainview, New York

T.M.

The need for faster computers is becoming increasingly apparent. Extensive data communications facilities and real-time operation are reaching the processing speed limits of existing fast computers. Also, most of the expense and effort devoted to more efficient programming might be easily by-passed by doubling the processing speed for the same cost. James Ward presents the case for faster computers on page 14. The computer on the cover is the Philco 2000-212 with an add time of 750 nanoseconds.

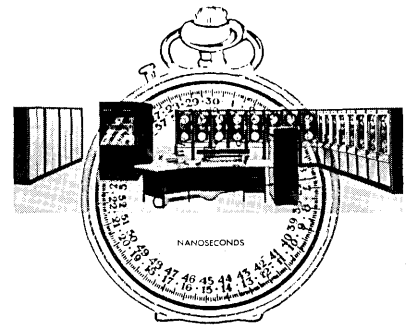

# computers and automation

MAY, 1963 Vol. XII, No. 5

*editor and publisher*  
EDMUND C. BERKELEY

*assistant editors*  
MOSES M. BERLIN  
NEIL D. MACDONALD  
L. LADD LOVETT

*contributing editors*  
ANDREW D. BOOTH  
NED CHAPIN  
JOHN W. CARR, III  
ALSTON S. HOUSEHOLDER  
PETER KUGEL

*advisory committee*  
T. E. CHEATHAM, JR.  
GEORGE E. FORSYTHE  
RICHARD W. HAMMING  
ALSTON S. HOUSEHOLDER  
HERBERT F. MITCHELL, JR.

*associate publisher*  
PATRICK J. MCGOVERN

*production manager*  
ANN B. BAKER

*art director*  
J. LOVELL

*circulation manager*  
VIRGINIA A. NELSON, 815 Washington St.  
Newtonville 60, Mass., DEcatur 2-5453

*advertising representatives*  
Chicago 11, COLE, MASON AND DEMING  
737 N. Michigan Ave., SU 7-6558

Los Angeles 5, WENTWORTH F. GREEN  
439 So. Western Ave., DUNkirk 7-8135

San Francisco 5, A. S. BABCOCK  
605 Market St., YUKon 2-3954

Elsewhere, THE PUBLISHER  
815 Washington St., DEcatur 2-5453  
Newtonville 60, Mass.

*computers and data processors:  
the design, applications,  
and implications of  
information processing systems.*

## In This Issue

14 THE NEED FOR FASTER COMPUTERS  
by James A. Ward

18 A METHODOLOGY FOR COMPUTER SELECTION STUDIES  
by Quincy N. Williams, Robert S. Perrott, Joseph Weitzman, Joseph A. Murray, and John A. Shober

24 MACHINE TRANSLATION AND LANGUAGE DATA PROCESSING  
by Leon E. Dostert

30 A SUMMARY OF RECENT ADVANCES IN THE COMPUTER FIELD  
by Ad Hoc Group, AIEE Computing Devices Committee

## In Every Issue

*across the editor's desk*  
42 COMPUTING AND DATA PROCESSING NEWSLETTER

*editorial*  
7 The Computer and Wrongoing

*readers' and editor's forum*  
9 "Required Cobol — 1961" — Some Comments  
9 ISPIC, Etc. — Some Comments  
10 Computer Art Contest  
10 The Computer As a Door Prize  
30 Calendar of Coming Events  
41 Place of Individual in Automation, Subject for Essay Contest  
41 Two New Computer Films Available  
57 A Case for Optical Readers  
64 Computer Braggadocio

*reference information*  
58 Monthly Computer Census  
60 Books and Other Publications, by Moses M. Berlin  
64 New Patents, by Raymond R. Skolnick

*index of notices*  
66 Advertising Index  
64 Manuscripts Notice  
68 Who's Who in the Computer Field

COMPUTERS AND AUTOMATION IS PUBLISHED MONTHLY AT 815 WASHINGTON ST., NEWTONVILLE 60, MASS., BY BERKELEY ENTERPRISES, INC. PRINTED IN U.S.A. SUBSCRIPTION RATES: UNITED STATES, \$15.00 FOR 1 YEAR, \$29.00 FOR 2 YEARS, INCLUDING THE JUNE DIRECTORY ISSUE; CANADA, ADD 50c A YEAR FOR POSTAGE; FOREIGN, ADD \$1.50 A YEAR FOR POSTAGE. ADDRESS ALL EDITORIAL AND SUBSCRIPTION MAIL TO BERKELEY ENTERPRISES, INC., 815 WASHINGTON ST., NEWTONVILLE 60, MASS. SECOND CLASS POSTAGE PAID AT BOSTON, MASS.

POSTMASTER: PLEASE SEND ALL FORMS 3579 TO BERKELEY ENTERPRISES, INC., 815 WASHINGTON ST., NEWTONVILLE 60, MASS. COPYRIGHT, 1963, BY BERKELEY ENTERPRISES, INC. CHANGE OF ADDRESS: IF YOUR ADDRESS CHANGES, PLEASE SEND US BOTH YOUR NEW ADDRESS AND YOUR OLD ADDRESS (AS IT APPEARS ON THE MAGAZINE ADDRESS IMPRINT), AND ALLOW THREE WEEKS FOR THE CHANGE TO BE MADE.

COMPUTERS AND AUTOMATION, FOR MAY, 1963

\$87,000

*DDP-24 IS NOT designed to be all things to all people. DDP-24 IS a fast digital computer, versatile, a sophisticated "component" built to move in company with a precision team in complex real-time on-line configurations. Equally comfortable performing off-line engineering and scientific computations. Reliable? Very.\**

*DDP-24 pays for itself on a diet of challenge. DDP-24 hardware, comprehensive software, user services and options belong in the hands of qualified professionals who know their applications and how to evaluate a computer against these selected applications. Under these conditions DDP-24's are a lot of computer for the money.*

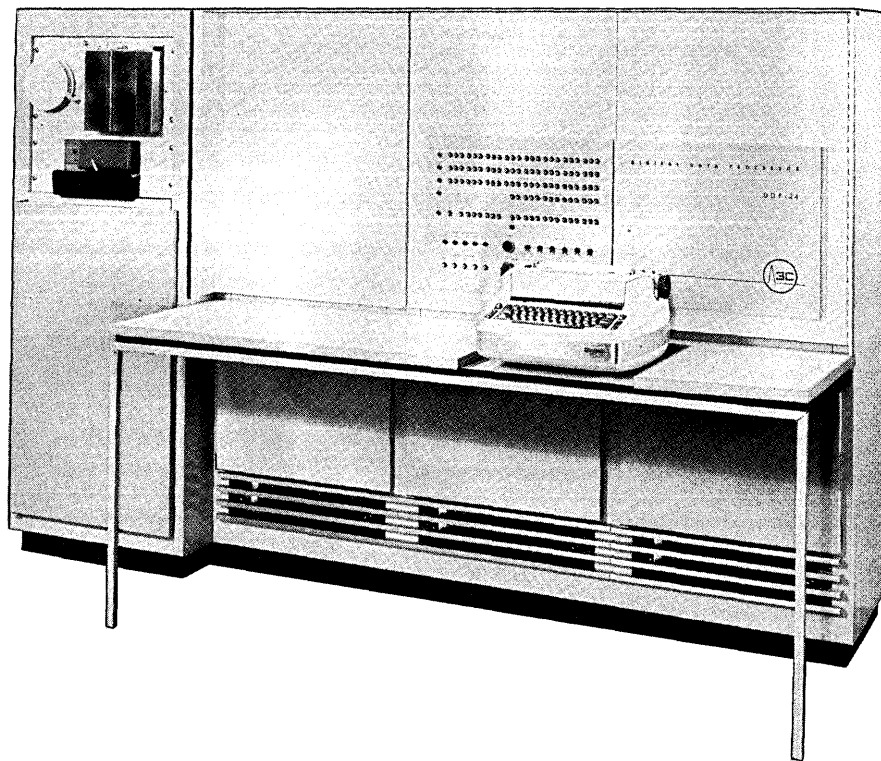

## DDP expanded to 24 bits Faster arithmetic unit Comprehensive software

DDP-24 is a parallel 24-bit word, core memory, sign-magnitude, binary, general purpose computer, with indexing and indirect addressing. Instruction repertoire includes multiply and divide, load and store, shifting, logical, jump, index, and input/output. Standard memory capacity is 4096 words (optionally expandable).

Simplicity, maintainability, user convenience are factors of design. Regulated power supplies and power failure protection preserve integrity of computation. Ready and interrupt modes give DDP-24 master or slave relationship with external equipment. Optional independent memory banks and fully buffered channels give true input, output, and compute overlap.

### SPEED

Computation rate is 100,000 additions per second. Multiplication takes 31 microseconds, division 33 microseconds. Times include instruction and operand access. Other arithmetic speeds:

Add floating point	125 $\mu$ /secs. max.
Multiply floating point	99 $\mu$ /secs.
Add double precision fixed	55 $\mu$ /secs.
Add double precision floating	181 $\mu$ /secs.
Multiply double precision fixed	263 $\mu$ /secs.
Multiply double precision floating	371 $\mu$ /secs.

Core memory cycle time is five microseconds with three microsecond access. Input and output can occur asynchron-

ously and be interleaved with processing at transfer rates up to 166,000 24-bit words per second.

### INPUT-OUTPUT

Strong input-output capabilities enhance communication with surrounding equipment; offer unique freedom of system implementation. Standard DDP-24 incorporates an eight-bit I/O character buffer register and channels, a 24-bit parallel input channel, a 24-bit parallel output channel, sixteen lines for external sense inputs, eight output control pulse lines, and four interrupt lines capable of asynchronous operation with the associated four basic input-output channels. Standard I/O equipment: typewriter, paper tape reader, punch.

### SOFTWARE

Programming software provided with the DDP-24 is comprehensive; satisfying professional programmers writing complex routines, mathematical analysts, and the occasional user. Fortran II, DAP, and DIP are modular, patterned after SHARE, easily adapted to specific hardware configurations. Diagnostics for rapid isolation of programming and system faults are included. Also provided: mathematical subroutines, number conversion, memory dump, library routines, master executive program, load program, and computer exercise routines.

Fortran II compiler permits investigation and development of math models prior

to writing real-time programs. Boolean augmentation and macro calls are provided.

**DAP** — DDP-24 Assembler Program — with one-to-one and one-to-many assembly, facilitates tight real-time programs in convenient language.

**DIP** — DDP-24 Interpretive Program — permits users with minimum programming experience to generate scientific computation routines after only half a day's study.

### OPTIONS

To offer still greater system adaptability and functional capabilities, extensive standard options and peripheral equipment are available for the DDP-24:

- core memory expansion to 16,384 words, with special expansion 32,768 words. (directly addressable)
- additional index register
- word forming buffers
- character I/O buffer registers
- interrupt lines
- eight level hardware interrupt priority system
- additional sense lines
- output control pulses
- parallel I/O channels.

I/O control units for maximized interlace and truly simultaneous operation:

- direct memory access control unit with unlimited channels
- fully buffered I/O control unit with unlimited channels.

Peripheral equipment optionally available: Magnetic tape control and transport units, A/D, D/A converters, card adapter, high speed line printer and adapter, digital plotter and adapter. Digital Resolver, satellite computer, increases DDP speed up to 10 times for algebraic and trigonometric functions. Other peripheral requirements can be fulfilled. Write for the full story.



**COMPUTER CONTROL COMPANY, INC.**

OLD CONNECTICUT PATH, FRAMINGHAM, MASS. • 2251 BARRY AVENUE, LOS ANGELES 64, CALIF.

\*Design is typical 3C. Modular construction is with S-PAC digital logic modules. Based upon a million PAC-hours of life test without failure the DDP-24 calculated MTBF is over 4000 hours.

## **The Computer and Wrongdoing**

---

On Friday, January 25, 1963, in Attleboro, Mass., the body of Mrs. Edith Martin was found in her home, stabbed to death. About midday, when she was last seen, her neighbors observed a blue 1958 Chevrolet parked in the driveway of her home, and this was reported to the police. Through the processing of 1144 punch card records of blue Chevrolets registered in Massachusetts, it was learned that 117 belonged to persons living in the area of Attleboro and Pawtucket. Police officers began a check of each of the 117 owners. The third name which they came to was the name of Thomas E. Knott, of Attleboro, a 17-year-old Pawtucket high school student and star athlete, who had a record of probation for one offense as well as psychiatric tests. Pawtucket police, learning that he was attending a movie, arrested him a few hours later with no resistance. He confessed, spending most of Sunday telling police how he had slashed Mrs. Martin to death, and also knifed to death another woman in December, 1961.

The Federal government, in making use of electronic data processing for comparing, has requested all United States savings banks to report their payments of interest to the holders of bankbooks. A certified public accountant, a partner in his firm, told me a few days ago that it was remarkable how many of his clients, whose income tax reports he checks, "have suddenly had rich uncles die," and this year are reporting much larger interest payments from their savings.

It is wonderful that murderers can be more readily found from the use of data processing. It is good that concealment of income for evasion of tax is being greatly reduced, from electronic data processing. But these applications of computers and data processors are the beginning of a long road—and does it lead to George Orwell's *1984*, with Big Brother knowing everything and watching everything?

I have a number now, and I have to put my number down on many formal occasions like paying my income tax or applying for a passport. Ever since I entered the Navy in 1942, my finger prints have been on file, so that the government can keep better track of me. One of the possibilities explained by a management analyst in the pages of

COMPUTERS AND AUTOMATION some time ago was that every person in the country will have an electronic bank account and that all buying and selling transactions will be done by electronic transfers at a central station. To a greater and greater extent, electronic data processing will permeate the nerve channels of a complicated society.

But tyranny is not a necessary outcome of these developments, and of course computers are not a necessary ingredient of tyranny. For example, take "One Day in the Life of Ivan Denisovich," by Alexander Solzhenitsyn (E. P. Dutton, New York, 1963, 160 pages), the deservedly best-selling story by a Soviet mathematics teacher of life and vivid characters in one of the forced labor camps in the Soviet Union in the early 1950's. Even with no contribution from computers, it is clear that there was no way at all to escape from or to deal with the tyranny. Among other problems, where could you escape to, with your one-day lunch ration of 6 ounces of bread, in a frozen waste at 10 below zero in daytime and 30 below at night?

But tyranny can be tighter and more inclusive for more people, and more efficient and more inescapable, with the contribution of computers and data processors.

We who know about the enormous powers of computers and data processors need to think about the wise and humane use of electronic data processing. Then it can really help in the problems that lie ahead of the adjustments between the individual and society, as we try to apply Victor Hugo's maxim, "The liberty of one person leaves off where the liberty of another person begins,"—or the wise remark of a Soviet leader quoted in the introduction to Solzhenitsyn's book:

*"It is our duty to gain a thorough and comprehensive understanding of the nature of the matters related to the abuse of power. Time will pass, and we shall die, we are all mortal, but so long as we work we can and must clear up many points, and tell the truth to the Party and the people. . . . This we must do so that such things will never happen again."*

*Edmund C. Berkeley*  
EDITOR

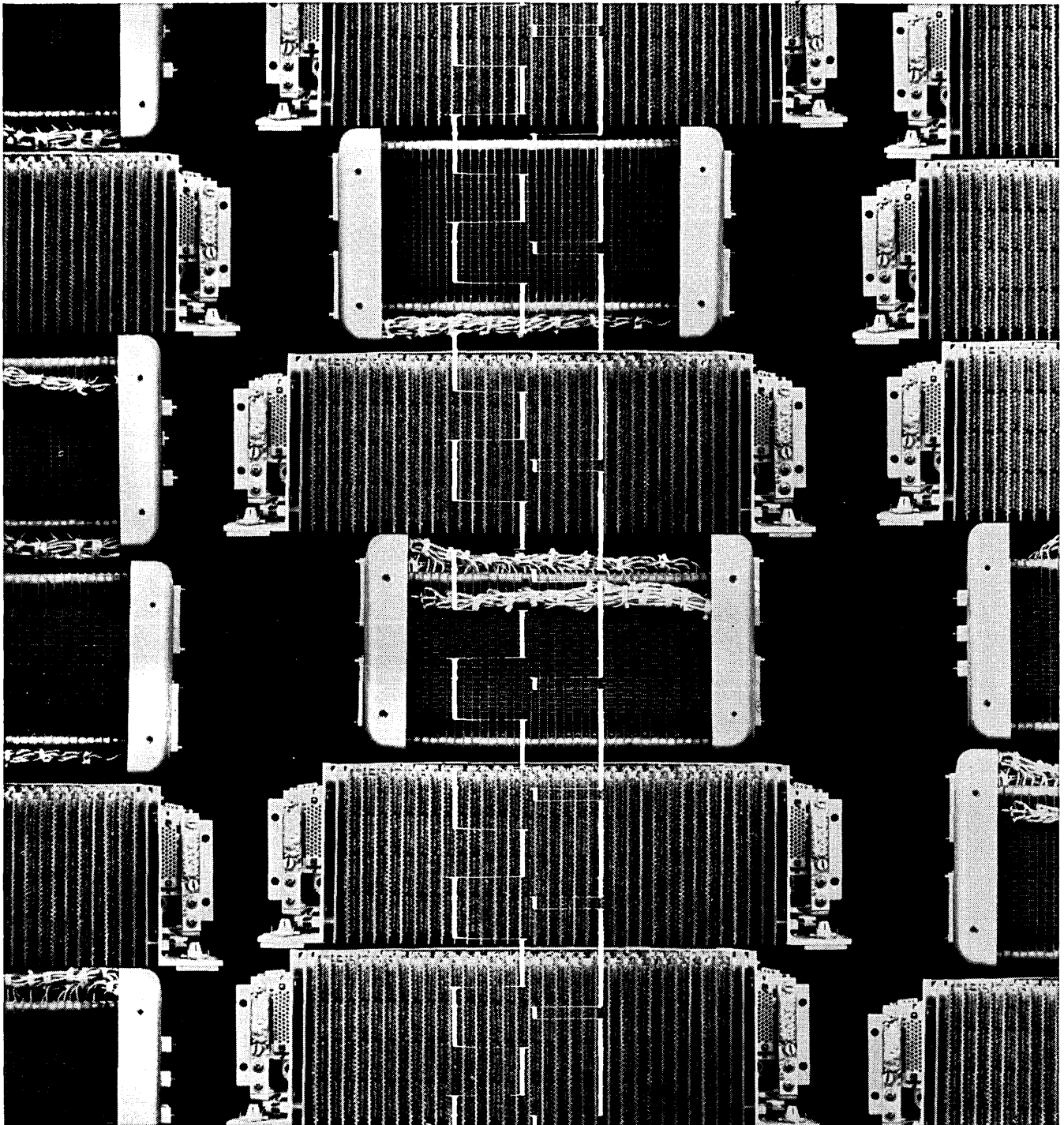

**Who can give you stacks of stacks?**

**AMPEX**

Just say the word. Ampex can give you every kind of 30 and 50 mil component. Stacks, for example. We've got both word select and coincident current types. They can provide complete memory cycle times ranging from 1 to 2.5 microseconds. They offer high signal-to-noise, high voltage output with low drive. And what's more, they're compact! 30 and 50 mil cores? We've got those—plenty

of them. High speed cores, low drive cores, and cores in-between. 30 and 50 mil arrays, too. All performance perfect. All now available! Ampex Computer Products Co., Culver City, Calif. A division of the only company providing recorders, tape and memory devices for every application: Ampex Corp., 934 Charter St, Redwood City, Calif. Worldwide sales, service.

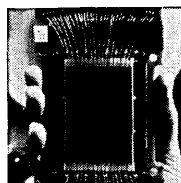



### "REQUIRED COBOL—1961"— SOME COMMENTS

Barrie Simmons  
Executive Vice President  
Basic Systems, Inc.  
New York, N. Y.

To the Editor:

Thank you for the space you kindly gave to a review of our self-instructional program, *Required COBOL—1961*, in your March issue. We were pleased with this coverage, but do take issue with some items.

Your editor objects to the cost of our evaluation kit, and perhaps still more to the license fee which gives client companies continuous and unlimited internal use of *Required COBOL—1961*. But he ignores, I think, the economic features characteristic both of this course and of other well-designed units of Programmed Instruction. For programming, as a form of automated technology, has features which are very different from the conventional textbook or manual.

(1) This course delivers predictable on-job behavior which has a determinable value to the employer organization. It does *not* deliver a mass of paper which is priced by a formula built on printing costs. It should *not* be seen as books, but as a machine to change behavior in specified ways. It should be judged by whether or not it succeeds as claimed.

The program is sold to managers who can calculate the value to them of specific returns on a specific investment in upgrading their manpower. Basic Systems offers evidence that the program *works*, and contends that its success can be replicated at any time under specified conditions:

"Trainees averaged 93.9% on a comprehensive final examination which required a usable computer program. . . . At Shell Oil, trainees were 'obviously more proficient, especially in regard to details' than those trained by conventional methods." The average time of completion of the program is 45 hours, about half the time taken for conventional instruction in COBOL.

Add this performance to the fact that the course requires no classrooms, trainee transportation or formally organized teaching, and you can begin to measure its real value.

The evaluation use is offered so that client management can assess the program's applicability, what Dr. Gloria Silvern in your same issue describes as "the transfer of these learned elements to the real-life programming situation." It also permits the company to learn the administrative details of Programmed Instruction, and to check the accuracy of performance claims. For \$600 the client gets this experience, its distillation into a documented management report from Basic Systems—and *ten well-trained men*. The

lowest-priced competitive training in COBOL costs well more than \$60 per head, and is demonstrably less efficient.

(2) The licensing fee of \$9,000 looks like a whopping price tag for books. For all the reasons above, it is no such thing. An analogy should be made to the economics of other forms of automation: high initial cost, as for equipment and installation, and then low variable cost of use. In this case, the licensee immediately receives materials which will train 150 men but more importantly, obtains access to a well-designed, tested training system which works as predictably as precision hardware, at a heavily discounted price per head for later trainees.

Let me end by reiterating that this program represents an *educational technology*, the first we have ever been offered. Programmed Instruction accepts responsibility for the student: if he fails, it is the program's fault, not his. It emphasizes a 90-90 criterion (90% of students achieving 90% or better on stringent finals) which challenges the programmer, not the intelligence of the class. For the first time, a teaching technique is available which can accept this responsibility, this challenge. It should be added that instructional programs, like other automated systems, are, as your magazine knows well, not cheap to build.

P.S. I have one factual correction to the article by James Rogers and Donald Bullock called "The Application of Programmed Instruction in the Computer Field" which appeared in your April issue.

We have recently re-examined the grades of the COBOL course students who took the final examination at Shell Oil and Burroughs, and find that the final grade was 93.9 per cent, and not 94.5 per cent.

### ISPIC, ETC.—SOME COMMENTS

I. From Arnold Roe  
Teaching Systems Laboratory  
Department of Engineering  
University of California  
Los Angeles 24, California

In the March, 1963 issue of *COMPUTERS AND AUTOMATION*, there appeared an article on "Programmed Instruction for Computer Programming" by Gloria M. Silvern which contained some possibly misleading statements (on page 17) concerning ISPIC.

ISPIC is supposed to stand for: *Ad Hoc* Inter-Society Programmed Instruction Council. As the representative of the American Society of Engineering Education (ASEE) on this council, I know that as yet no formal recognition has been extended by ASEE to the *ad hoc* council. Nor

have I been informed of any formal recognition of ISPIC by the Association for Computing Machinery (ACM), the Electronics Industries Association (EIA), or from the American Society of Training Directors (ASTD). Furthermore, at the one and only meeting of ISPIC last November, no recommendations concerning the description or quality control of programmed instruction were formulated. The recommendations listed on pages 17 and 18 are not those of ISPIC nor do they appear to be those of the AERA-APA-DAVI Joint Committee on Programmed Instruction and Teaching Machines, headed by Dr. Arthur A. Lumsdaine.

Furthermore, I am somewhat dismayed by Mrs. Silvern's attempt to rigidly specify what does and what does not constitute "bona fide programmed instruction." Programming, as a technique for instruction, is in its infancy, and doctrinaire views (which would confine programs to those formats used by the earliest practitioners) are likely to stifle fruitful exploration or use of modified programming procedures.

Lastly, I feel that Mrs. Silvern's concluding remark in her review of the Colman and Smallwood text *Computer Language*, namely, "... the identification in the preface with B. F. Skinner suggests that the authors might profit by making a more strenuous attempt to understand the Skinnerian point of view," is both unkind and unjust. In the preface Colman and Smallwood clearly state that *Computer Language* is a departure from the traditional Skinnerian format, and their further statements of why they make this departure seems to indicate that they are not only aware of the early Skinnerian point of view, but also of some of the possible weakness in this view.

**II. From Dr. Gloria M. Silvern**  
**Research Specialist**  
**Computer Center**  
**Space and Information Systems Division**  
**North American Aviation, Inc.**  
**Downey, Calif.**

Mr. Arnold Roe's communication is appreciated since it makes possible a further clarification of a number of points.

In connection with his comment about misleading statements on page 17, the text originally submitted to COMPUTERS AND AUTOMATION read as follows: "More recently, ISPIC (the Inter-Society Programmed Instruction Council, consisting of the Association for Computing Machinery; American Society of Engineering Education, Electronic Industries Association and the American Society of Training Directors) was formed. In this way, ACM now has immediate access and may contribute to recommendations which, when translated into terms most meaningful to its members, will gradually develop into an *instrument of quality control for programmed instruction.*"

The recommendations listed on pages 17 and 18 of the article are *not* those of ISPIC, and it is regrettable that the omission through editing produced this impression. The recommendations were formulated by the ASTD representative to ISPIC and are extracted from Reference 5. It is the intention of the ACM representative to present these recommendations to the ACM Special Interest Committee on Digital Computer Programmer Training at the next SICODCPT meeting.

While ISPIC was formed on an ad hoc basis, it was understood that each society would formalize recognition at its next opportunity. The ACM representative was officially authorized to attend meetings of a council of societies on programmed instruction. The other members of the council were also expected to officially represent their respective associations.

Regarding Mr. Roe's concern with rigid specifications for bona fide programmed instruction, a reviewer has an obligation to his readers to call the plays of the game as he sees them. Some observers may not agree with the referee's

decision based upon his understanding of the rules. It is not too early to establish assessment criteria as recommended by the APA-AERA-DAVI Joint Committee (Ref. 4).

Finally, the remarks about the Colman and Smallwood text identification with the Skinnerian method arose from the following quotation taken from their Preface: "The teaching technique used is called *autoinstructional*. It is based on B. F. Skinner's reinforcement theory of learning—the theory of programmed learning and teaching machines. Traditional applications of this theory require students to respond overtly to *every* new unit of information by writing down a word, numbers, or phrase, the correctness of which is *immediately* verified in the text." It is suggested that Mr. Roe argue with Dr. Skinner regarding how far one can stray from Skinnerian reinforcement theory before a "departure" becomes no connection at all. Both overt responses and feedback are absent, and the character and design of the stimulus bear no resemblance to Skinnerian design. The Colman and Smallwood Preface further states: "Experiments, particularly by Arnold Roe at UCLA, indicate, however, that under some circumstances, if the overt response and verification are omitted, the result is a program of instruction that is equally as effective and significantly more efficient. This mode of autoinstruction is usually called the *no-response* mode." The "no-response mode" used in the text is approximately 179° away from Skinnerian theory, not merely a "departure."

### III. From the Editor

We regret the garbling through typographical error (incorrect insertion of "to"), and injudicious editing of the author's intended expression. Please insert the words "ACM now has immediate access and may contribute" between line 9 and line 10, in paragraph 2, column 1, page 17, of COMPUTERS AND AUTOMATION, March, 1963; and in line 10 and line 11, please delete the words "may be produced."

## COMPUTER ART CONTEST

**I. From Peter John Lawrence**  
**Northern Electric Co.**  
**Ottawa, Ont., Canada**

To the Editor:

If possible, would you oblige me with further information on the Art Contest for Computer Art for the cover of the August, 1963 issue?

### II. From the Editor

The cover photograph on our January, 1963, issue is an example of an artistic design generated by a computer. We feel sure that many more, varied and interesting printer, oscilloscope, or plotting board displays can be generated via a computer. We will award feature presentation in our cover story for August, 1963, to the most interesting example of this type of aesthetic expression.

We hope you will be in a position to submit an entry in this competition.

## THE COMPUTER AS A DOOR PRIZE

A milestone in the expansion of the computer field was reached recently when an analog computer was offered as a door prize to attract visitors to a computing service.

The occasion was the open house held in March at Electronic Associates' Los Angeles Computation Center. A \$4,000 TR-10 analog computer was given to a university designated by the holder of the lucky number. The winner, Warren Hall of the Northrup Corporation, was picked from

(Please turn to Page 41)

# PLANNED OBSOLESCENCE

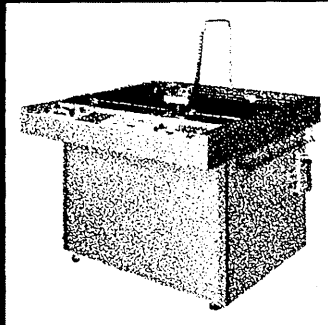

PROTECT

ELECTROPLOTTER II

# new

NO OBSOLESCENCE.

- 4 pen option (4 color—4 line width—under input control).
- 48 character alpha numeric printer.
- Variable speed line drawing—input control.
- On-line capabilities.
- Increased plotting speeds.
- Control panel for operator-proof set up and run.
- Low price.
- Exclusive 180 day Double Warranty.
- Modular construction.

SPEED

ACCURACY



The new ELECTROPLOTTER II furnishes a precise balance of speed and accuracy, permitting the broadest scope of application at the lowest cost in computer and programing time.

## RELIABILITY?

Benson-Lehner's exclusive New Double Warranty Policy gives you six months of factory service at no charge. It's backed by the nation's largest field service organization specializing in graphic input and output devices!

See it in Detroit at the SJCC, May 20-23, Cobo Hall.

**benson-lehner** corporation / 14761 califa street / van nuys, california



Over 70 sales and service engineers to serve you both here and in Europe.

MAIN OFFICE: USA • 14761 Califa St., Van Nuys, Calif. • Phone: 781-7100  
Benson-France • 1 Rue George-Mandel, Paris, France • Phone: TRE 2982  
Benson-Lehner Ltd. • W. Quay Rd., Southampton, Eng. • Phone: S.H. 2-7831



**"Why we chose the NCR 315 Computer."** — THALHIMER BROTHERS, INC. Richmond, Va.

"Our interest in computers dates back to the early 1950's when we participated in an extensive computer research and testing project. Backed with this experience, we began a study to design our system, and this led to our choice of the NCR 315 Computer as the one best suited to our specific needs.

"Our 315 was delivered in May 1962 and we made the first customer billings for our Danville store one month later.

Each month we added one or more stores to our computer system, and are now completely processing all the customer accounts for our 12 stores in Richmond and Danville, Virginia; Greensboro, Winston-Salem and Durham, North Carolina.

"Essentially, our choice of the NCR 315 stemmed from the fact that we have had a long association with NCR—they know the problems of retailing. With the 315, we were able to install just those

pieces of equipment needed today, yet the system can be expanded as our future needs demand. And additionally, the 315 gives us a strong foundation upon which to grow and expand in the trading areas which we serve."

*William B. Thalhimer, Jr.*

William B. Thalhimer, Jr., President  
Thalhimer Brothers, Inc.

NCR PROVIDES TOTAL SYSTEMS — FROM ORIGINAL ENTRY TO FINAL REPORT — THROUGH ACCOUNTING MACHINES, CASH REGISTERS OR ADDING MACHINES, AND DATA PROCESSING  
The National Cash Register Co. • 1,133 offices in 120 countries • 79 years of helping business save money



# CI-308

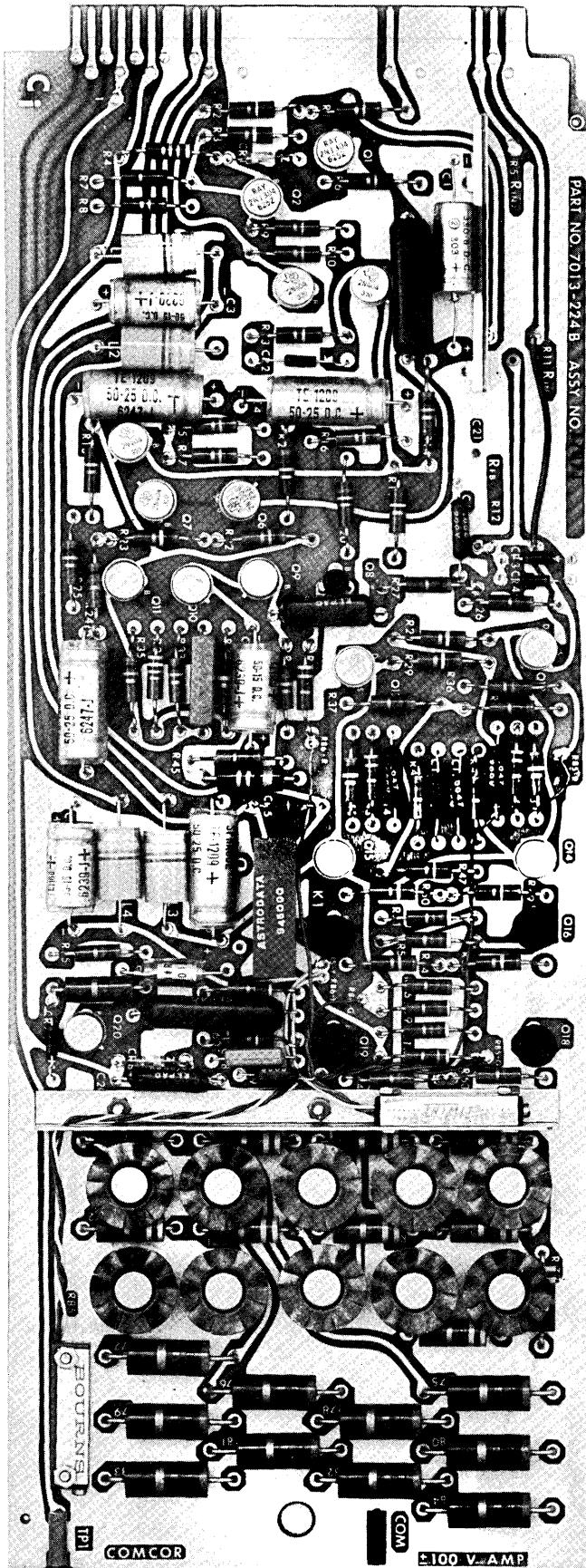

## 100 Volt Operational solid state amplifier for computer and control applications

The CI-308 is designed specifically for high speed analog computer and control applications. Outstanding advantages include high reliability, 50% reduction in size, and 80% reduction in heat dissipation. Output current capability is 50 ma at  $\pm 100$  volts DC. Open loop gain is greater than  $10^8$ . The unit employs solid state chopper stabilization and exhibits low noise and drift characteristics. Comcor offers the CI-308 with digitally controlled solid state electronic integrator mode switches to provide high speed repetitive and iterative capability. Custom models can be produced for special applications. COMPLETE INFORMATION ON THE CI-308 AND THE COMCOR LINE OF SOLID STATE ANALOG COMPUTER SYSTEMS IS AVAILABLE ON REQUEST.

---

## Comcor Inc.

---

A SUBSIDIARY OF ASTRODATA, INC.  
430 SOUTH NAVAJO STREET • DENVER 23, COLORADO  
PHONE 777-3066, AREA CODE 303 • TWX 303-292-2936

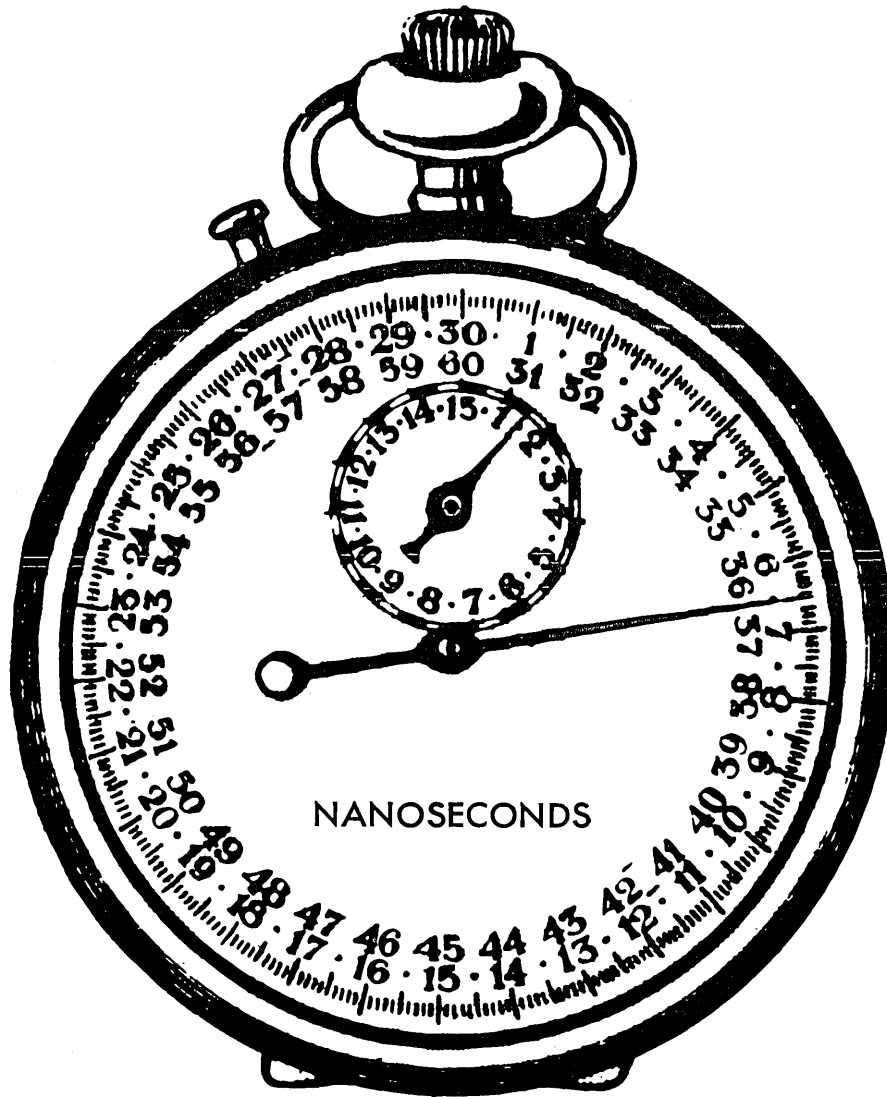

## THE NEED FOR FASTER COMPUTERS

*James A. Ward  
Office of Electronics*

*Office of the Director of Defense Research & Engineering  
Washington, D. C.*

We can all agree, I believe, that we need faster computation. We can all name problems that computers should perform faster. There are several ways the speed can be increased:

1. More efficient compilers
2. Better use of existing machine logic
3. Better numerical analysis
4. Parallel computation
5. Faster computers.

The Department of Defense is sponsoring research on all five fronts but not at the same rate. This article will discuss these points and show why Number 5 seems the most important. To illustrate the need for faster computers I will give examples within and outside the Department of Defense.

### More Efficient Compilers

Everyone will agree that more efficient compilers are needed, but it is hard to get agreement on what is meant by "more efficient." It is one thing for experienced programmers and quite another for beginners. At Laboratory A they do a great many one-shot problems that are comparatively short. At Laboratory B there are few one-shot problems and many are quite long. The compiler desired at the former is expected to convert to machine language as quickly as possible. At the latter installation, it is expected to furnish a very efficient object program with a minimum storage. To get this the compiler time is longer.

Who is to say how much debugging aid is needed in a compiler? The requirements are different for different applications.

The point is: Though all our compilers can be improved, there is no single ideal all-purpose "best" compiler. The goal of "More Efficient Compiler" calls for movement on a very wide front. Progress is apt to be very slow for a long time to come.

Furthermore, much programming is done in machine or assembly language and better compilers will not help. Many installations also rely heavily on programs furnished by the manufacturer or by a programming contractor. These are largely done in assembly language.

### Better Use of Existing Machine Logic

Many of the logical features built into a computer are not used by programmers.

A part of a problem a friend had was to determine the number of "one" bits in each of a large number of computer words. He did this by extracting each bit, one at a time, determining if it were a "one," and tallying the results. He spent a lot of time on the sub-routine and got it quite fast. But

since he had a 40-bit word he had to go through the loop 40 times.

His problem would have been solved much faster by using the logical product command. If  $X$  is the binary representation of the number to be tested, then the *logical* product of  $X$  with  $(X-1)$  has one fewer "one" bit. It would have reduced his computation time by a factor of five.

We can all give examples of a programmer who used loops rather than index registers because he did not understand them. There are also cases of compilers that have not taken advantage of some of the machine logical capability.

### Better Numerical Analysis

Being a mathematician I feel that numerical analysis is the area of greatest need.

Research is needed to find the best method for solving large systems of non-linear equations, systems of integral equations, for constructing digital filters, for differentiating and integrating numerical data, etc., ad infinitum. There is no all-purpose "best" technique. The "best" integration technique for real-time guidance during missile launch is different from the "best" technique for post flight analysis.

One of the greatest needs is to determine the accuracy of results. After 10,000 integration steps of a system of differential equations (about 2 weeks of a satellite orbit), how much significance is left?

Another need in numerical analysis is to get the word to the programmer. Much that is published is unknown to him. When I was running a scientific computation laboratory, I had trouble getting the programmers to read the literature.

Hastings's book "Approximations for Digital Computers," has been both praised and berated, but it did get techniques into the hands of programmers. Can we do the corresponding thing for solution of equations, filtering, etc.? Can we do them in such a way as to safeguard their misuse?

### Parallel Computation

Many feel that the best way to speed up computation is to split it among several computers. Much can be done by this, but it is very difficult. Part of the difficulty is that it is incompatible to our system of thought. From the time of Gauss to the present, the numerical analyst has worked to arrange his computation in sequential order. It is difficult to change a 200-year tradition, but some progress has been made.

The first multi-computer was the LARC. The original concept was for

a data processor to handle input, output and formatting of data, for two arithmetic units to work independently, and for several banks of memory. Neither of the two LARC purchasers knew how to use two arithmetic units, so they bought only one. However, both did get the data processor. So the LARC corresponds to a 7090/1401 combination, but is not a true multi-computer.

Two computers are used back-to-back in each SAGE Sector installation. However, one is on-line and the other is stand-by. The Mercury computation at Goddard is similar. Two identical computers receive all the inputs and make all the computations. However only one of them is on line to output the results to the Mercury system. Each displays the output. An operator monitors both displays. Should the output of the on-line computer go bad, he can switch to the stand-by computer.

One interesting application in the Department of Defense does use multi-computer systems. Installations have two or three computers depending on the workload. The program determines which computer services each input device and which computer drives each output device. The computation is divided on a functional basis. Data and results from one computer are used in the computation of another. Each computer has its own executive program. No one computer is master and the other slave.

Minneapolis-Honeywell has made a step in the direction to achieve parallel computation with hardware. The H 800 (and the forthcoming H 1800) have only one arithmetic unit, but there is hardware capability to interleave up to 8 different programs. This is particularly useful for programs that are limited by input-output.

Another effort in this direction is the SOLOMON computer which is under study at Westinghouse. Here, under supervision of a house-keeping unit, 1,000 small and comparatively slow arithmetic units operate in parallel on corresponding pieces of data. The result is an over-all speed-up. For certain classes of problems SOLOMON is expected to be much faster than any existing computer. However, the range of problems it can efficiently handle is limited.

### There Are More Rewards for Higher Speed

If we can get computers that are fast enough, the parallel computation on our present machines will be unnecessary except for back-up. We can afford sloppy numerical analysis if the computer is fast enough to allow for poor procedures. If the computer is fast enough for double and triple pre-

cision, we do not need to worry about significance. We can operate in compiler language with no consideration for scaling. Faster computers can solve the problems that the other efforts try to solve and solve them by brute force—if we can manage to get sufficient speed.

Suppose the people at a certain installation have a difficult problem that takes  $n$  minutes on computer A. Suppose they have to do this many, many times. They can speed it up by having a consulting firm do a good numerical analysis and programming job and may get it down to  $n/4$  minutes after considerable time and expense. A change to computer B which is 4 times faster would accomplish the same result—and furthermore would speed up *all* the other computation at the installation. The result may be cheaper in the long run.

The making of faster hardware is a physical and patentable operation. The manufacturer that develops such a device will strike it rich. He is willing to spend a large sum on research and offer large rewards to his research people who do develop faster "widgets." On the other hand, the rewards for better software are far, far less.

Professor William E. Milne of Oregon State and Dr. S. Gill in England have probably done more to speed up the numerical solution of differential equations than any advance in hardware since the ENIAC in 1946. However, their *financial* rewards have been microscopic compared to those who have made the corresponding achievements in faster hardware.

Whether this is proper is not argued here, but it is a fact of life. We give greater rewards for increasing speed of hardware than for increasing speed with better software. Therefore, we will have more advances in the speed of hardware. I understand that the Russians put more emphasis on the software aspects.

### We Do Need Faster Hardware

However, there are many problems we are now faced with that cannot be properly solved until we do get faster hardware. And I do not mean we need double the present speed—we need 100 times the present speeds for some of the problems facing us today. Let me mention a few of general scientific interest.

### Ballistic Missile and Satellite Launch

At present the launch of such a vehicle is tracked by a number of doppler type devices and a number of radars. The data from only a few of them are fed into the computer. Under program control the computer selects only

one source of data to operate on for guidance. Why? Because the computer isn't fast enough.

Azimuth, elevation, range, and range rate are obtained from a radar 5, 10, or more times per second. These need to be checked for reasonableness and corrected for misalignment and refraction. The data is changed to local x, y, and z coordinates, then to earth-centered inertial coordinates. A curve is fitted through this and the preceding k points to obtain velocity, acceleration, and a better estimate of position. Comparisons must be made between these results and the desired results. Proper signals must be sent to the missile for guidance corrections. All of this must be outputted in the proper formats for human and machine monitoring.

The trajectories obtained from the different devices are amazingly different. What is needed is a weighted average of all the inputs from all the devices. For launches that are coming up this is essential. It looks like 100 times present speed would solve our needs, but we'll take anything we can get.

### Phased Array Radar

A phased array radar is a matrix of small radars each of which sends and receives under command of a central control. If digital computer circuitry were fast enough, each separate radar could measure its sending and receiving delays as a discrete number of picoseconds. Hence the whole radar would become a digital device. An ultra-high-speed computer would be required to reduce the resulting vast amount of data to usable form as is now achieved by analog methods. However, I am not a radar man but it seems that such a radar may have far greater capability than those at present. We are also far from the digital computer capability to implement it.

### Reactor Problems

The AEC has many problems that require more speed than is presently available. A neutron diffusion problem in three dimensions requires a minimum of  $50^3$  grid points. To solve a set of partial differential equations over such a network is a very formidable problem.

### Orthogonal Latin Squares

There is an interesting classical mathematical problem of latin square. A latin square is an n-by-n matrix in which the first row has n distinct elements and each succeeding row is a permutation of the first row in such a way that each column has n distinct elements.

For example:

$$X = \begin{matrix} 1 & 2 & 3 & 4 \\ 4 & 1 & 2 & 3 \\ 3 & 4 & 1 & 2 \\ 2 & 3 & 4 & 1 \end{matrix}$$

is a latin square of order 4.

Two latin squares of the same dimension are said to be orthogonal if, when one is superimposed onto the other, the ordered pairs of elements in the cells are all distinct. For example, each pair of the three 4-by-4 latin squares

$$A = \begin{matrix} 1 & 2 & 3 & 4 \\ 2 & 1 & 4 & 3 \\ 3 & 4 & 1 & 2 \\ 4 & 3 & 2 & 1 \end{matrix} \quad B = \begin{matrix} 1 & 2 & 3 & 4 \\ 3 & 4 & 1 & 2 \\ 4 & 3 & 2 & 1 \\ 2 & 1 & 4 & 3 \end{matrix} \quad C = \begin{matrix} 1 & 2 & 3 & 4 \\ 4 & 3 & 2 & 1 \\ 2 & 1 & 4 & 3 \\ 3 & 4 & 1 & 2 \end{matrix}$$

is orthogonal. The latin square X above has no orthogonal mate.

Which latin squares have orthogonal mates and which ones do not? The main problem is how does one construct a set of n-1 n-by-n latin squares so that each will be orthogonal to each of the others? The set A, B, C above is such a set, but X cannot be a member of such a set.

The problem has many applications to geometry and statistics.

The problem was introduced by Euler 180 years ago. Some 60 years ago it was proved that no 6-by-6 latin square can have an orthogonal mate. The problem is pretty well settled for n odd or n as a power of 2. However, the 10-by-10 problem is far from settled.

The problem was attacked by computers in 1952. At that time, it was estimated that the SWAC at UCLA had a reasonable chance of solving the problem in  $10^{10}$  years!

Since then considerable progress has been made in developing faster computers with larger memories (the SWAC had only 256 words) and speed-up devices such as index registers and multiple accumulator registers.

Also considerable advance has been made on the mathematical theory. In 1959, Dr. E. T. Parker produced the first pair of orthogonal 10-by-10 latin squares. Since then, by using the present theoretical and computer state of the art, he has produced several dozen 10-by-10 pairs of latin squares, but has found no set of 3.

What is needed is a set of 9 or the proof that none exists. With present computers it seems that the problem can be solved in about a year. This is entirely too long. A computer 100 times as fast as our present ones would reduce this to 3 days which is long, but within practical attainment.

### Monte Carlo Problems

Monte Carlo problems really eat up computer time. A problem at Edge-wood Arsenal requires 30 hours on the

STRETCH for every set of parameters! The accuracy of many results in Monte Carlo problems varies as the square root of the number of operations. That is, if a computation correct to two decimal places requires K minutes on a given computer, the computation correct to three decimal places would require  $100K$  minutes!

### The Weather Research Problem

The General Circulation Research Laboratory of the Weather Bureau is trying to build a model of the earth's atmosphere. At each point they keep track of the solar energy absorbed and re-emitted, the surface features, snow cover, cloud formation, precipitation, etc. To do this they have a network of 10,000 grid points at each of 10 levels to cover the entire globe.

There are four variables to be evaluated at each of these points, which makes almost half a million data points to describe the atmosphere at any instant. The change in the atmosphere is denoted by a set of five very complicated non-linear differential equations. These are solved on the STRETCH by a central difference process.

To test this model of the atmosphere the Laboratory solves 100-day problems. But unfortunately 100 days of weather requires 400 days of computer time! And this is with only one set of parameters. What they need is to be able to make the computer representation many times with different sets of parameters to get a really good fit.

They say they need a speed of 50 times that of STRETCH and really ought to have 100 times that speed. With such a computer they could learn about the atmosphere much faster, get better fits, and make much, much better weather predictions. They can hardly predict now!

### Conclusion

I have pointed out the usefulness of faster computers to make up for those who are not using their present computers to the maximum efficiency. They are needed in jobs where the state of the art in software is lagging such as numerical analysis and higher order compiler languages. I have also tried to show that there is a large variety of very important classes of problems for which there is no foreseeable solution except for faster hardware.

Of course, we cannot continue increasing the speed of computers by orders of magnitude, for we are limited by the speed of light. But, I am glad that we have men with the imagination and initiative to create the demand for faster computers. It is a very challenging goal for the computer industry and the rewards for achievement will be very great.



# WHAT MAKES THESE TAPE READERS THE BEST IN THE WORLD?

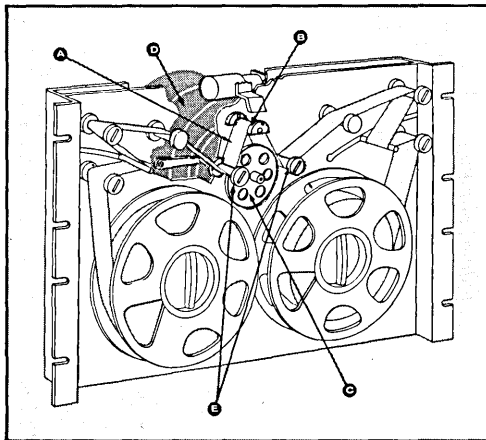
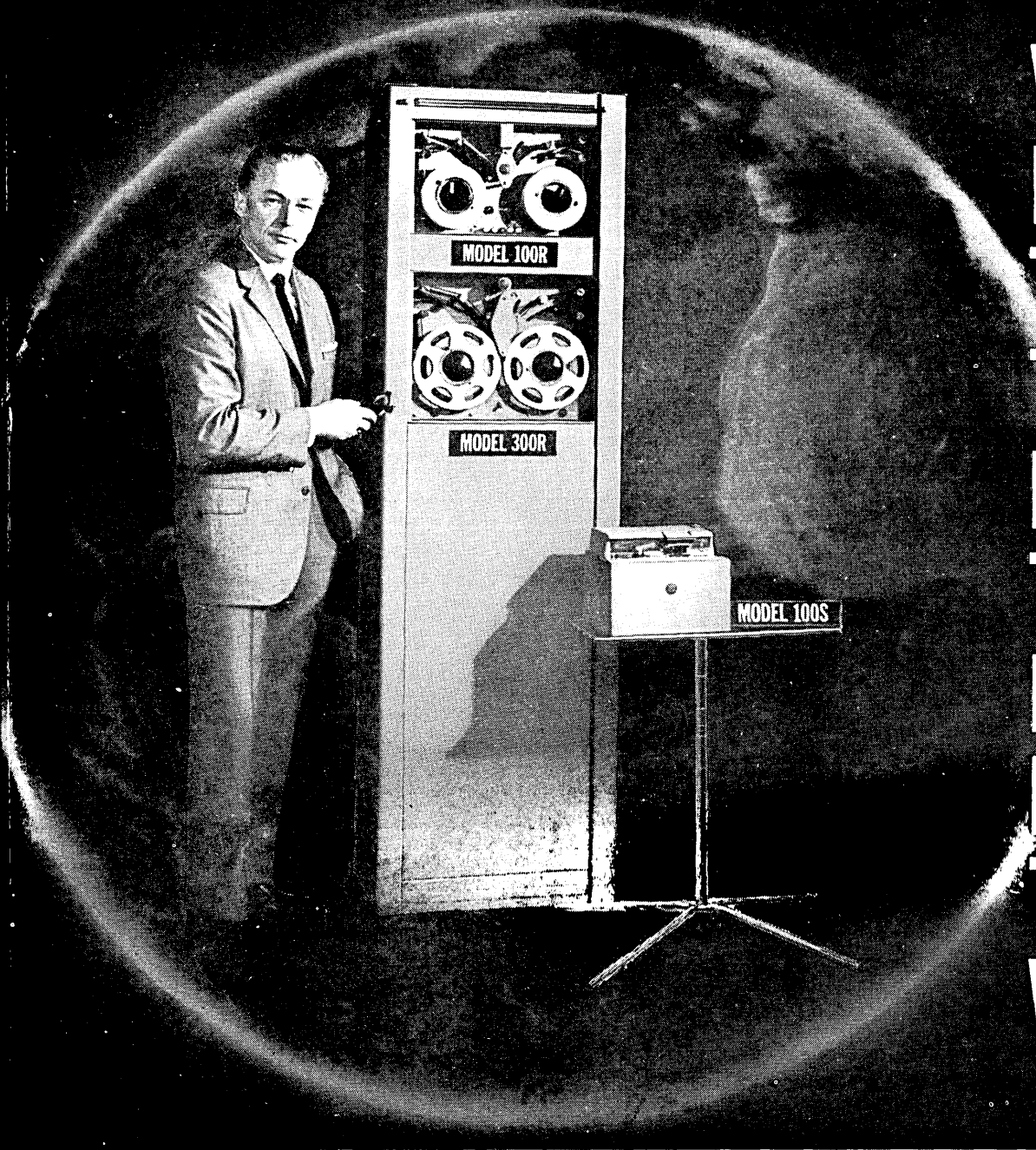

Mechanical simplicity . . . which yields a degree of reliability unattainable by any other paper tape reader! Simplicity made possible through the utilization of the revolutionary PMI printed motor direct drive servo. Movement of the tape through the read head is achieved by merely starting and stopping a printed motor. The brakes, clutches and pinch rollers that cause big trouble and down time in conventional tape transports are completely eliminated.

Line by line cycle: movement of tape (A) over read head (B) is controlled by drive capstan (C)—attached directly to shaft of PMI printed motor\* (D); spring-loaded rollers (E) hold tape gently against capstan, keeping tape movement in exact accord with capstan rotation; advance command pulse accelerates motor, capstan, and tape; as read head detects next sprocket hole, a reverse pulse to motor halts capstan and tape with next character perfectly aligned in read head. \*U.S. Patents of Printed Motors, Inc. Pending.

PHONE, WIRE OR WRITE FOR COMPLETE INFORMATION

*Photocircuits*  
CORPORATION  
TAPE READER DIVISION  
Glen Cove, N.Y.

## A METHODOLOGY FOR COMPUTER SELECTION STUDIES

Recently, data processing people at this company surveyed current and potential users of our first generation computer in order to determine future corporate data processing equipment and service requirements. We concluded that SK&F would grow out of its present computer in 1963 and therefore established a team to select the equipment to be procured on the expiration of our present rental agreement. This team was headed by one of our Systems supervisors and reported to the manager of our data processing operation. The team was staffed with three systems analysts, two programmers, and our chief computer operator.

After appropriate preparation the computer selection team invited eight computer manufacturers to an orientation session at which we described corporate and data processing organizations, the goals of our electronic data processing operation, our current computer applications and systems that might be converted to EDP in the next several years. We also gave them written detailed descriptions, flow charts, input/output specifications, and volume data on four applications which comprised a sample of our current and anticipated computer workload.

These four benchmark problems were: marketing information retrieval and mailing list preparation; billing and sales analysis; scientific information retrieval; and a statistical problem involving matrix inversion. They were given comparative weights of 35%, 30%, 30%, and 5% respectively to show the relative importance of each type of application to SK&F's over-all data processing.

We asked the manufacturers to fill out and return questionnaires on equipment specifications and software, and to code in assembly language a short problem involving discounting an invoice. We requested them to prepare a written proposal that included at least the following: equipment configuration and cost; narrative description, flow charts, time estimates for each of the benchmark problems including record and file layouts, estimates of the number of program instructions, and discussions of any special techniques; space requirements and site preparation; conversion costs and plans; maintenance program and availability of equipment back-up; personnel requirements; training facilities and programming support; contract terms and dates; expandability of equipment and special devices available; present and anticipated software package; description of and data on vendor's organization, size, and operating procedures. To guide the manufacturers, we said that the proposed configuration should process the four benchmarks in one-half of one shift and that monthly rent should be ten to twenty per cent lower than our current payments.

Prior to this meeting with the vendors, we developed a methodology which we used to compare and evaluate the vendors and their equipment. We had made the usual investigation of how people study and select computers and were unimpressed by what we found. The system we evolved was built on the belief that documented quantitative methods provide the soundest objective foundation on which to lay the subjective facade that colors and influences every decision. Then we went one step further and decided that we should quantify the unmeasurable by relative grading or evaluation and thus apply the discipline of comparative qualitative quantification to our whole evaluation process. We realized that top management is not interested in microseconds, transfer rates, or flow charts and that we should avoid the jargon of EDP. Management can understand relative or comparative performances. If we could reduce the apples and oranges, the obvious and the mystical, the objective and the subjective to a common denominator, we felt that we could make ourselves understood; thus our reliance on the discipline of numbers. More importantly, we could be sure that our recommendation had been influenced by those subjective factors that machine technologists usually ignore and management always recognizes.

We do have one disclaimer: our methodology was tailored to our company at a certain point in time. If we used it for any other firm or for SK&F at another time, the methods and results would not necessarily be the same. The degree of importance or the weights of the various factors would change; in fact, some factors would disappear and others would be included.

### Methodology

We felt that the key factors to be considered were equipment specifications, through-put cost and timing, software package, the various elements of support that the user receives from the vendor, and the cost of the installation. We felt that these five factors were equally important to us. Each factor could then be given a weight of 20 percentage points, with the total for all five equaling one hundred.

I will now describe the components that comprised each of the five factors and the methods we used to award points to a manufacturer based on his relative performance in each of the components and thereby in each of the five factors to reach a total percentage.

### Equipment Specifications

There are many comparative measurements of computer component characteristics. We wanted to reduce the number of measurements we had to make to manageable pro-

Quincy N. Williams, Robert S. Perrott, Joseph Weitzman, Joseph A. Murray,  
and John A. Shober

Smith Kline & French Laboratories  
Philadelphia 1, Pa.

portions. Thus we eliminated those specifications or characteristics where the machines were roughly equivalent (e.g., print positions on the high speed printer), that could be evaluated by yes/no answers (e.g., valid character tape check available?), that required narrative descriptors, that pertained to a single manufacturer only, or that we as a user were not interested in (e.g., paper tape I/O).

We listed the pertinent remaining possibilities and assigned to each a value that designated its relative importance to each and all of the others. For example a criteria that was twice as important as another received twice as many value points. Applying factorial analysis we converted the value points to percentage points and grouped the criteria as shown in Table 1.

Table 1

CRITERIA	PERCENTAGE POINTS
Simultaneity	30
Magnetic Tape System	24
a) reel capacity of alpha-numeric characters	6
b) rate of transfer	6
c) start-stop time	6
d) number of 40 character records on a reel	6
Central Processor	18
a) access time	9
b) fetch execute time	9
Input/Output Functions	23
a) card read rate per minute	8
b) card punch rate per minute	3
c) print speed in lines per minute	12
Miscellaneous	5
a) fixed point arithmetic ability	2
b) floating point arithmetic ability	2
c) number of index registers	1
TOTAL	100

We then constructed a matrix with these criteria across the horizontal axis and computers down the vertical axis. The results of the equipment questionnaire were then posted to the matrix and the optimum performance was noted. This optimum entitled that computer system to receive the percentage points allowed for that criteria; the optimum became the standard of comparison for the awarding of points to the other manufacturers. If the optimum performance was the highest or largest measurement (e.g., card read speed) this formula was used to award points to the other manufacturers:

$$(\text{points awarded}) = (\text{percentage points}) \times (\text{measurement of the component}) / (\text{optimum measurement})$$

If the optimum was the lowest measurement (e.g., access time), the inverse of the formula was used. We posted the

points awarded to a second matrix, identical to the first except the body of the matrix contained relative points rather than actual component measurements.

A couple of the criteria above need further explanation. In simultaneity, we awarded the full value of 30 to a computer if it could read, write, and compute simultaneously. One that could read-compute or write-compute received 20 and one that could read-write received 10. If a configuration had I/O operations on a satellite computer we gave that manufacturer an additional five points.

In the fixed-point and floating-point arithmetic ability, we asked the manufacturers to time adding, subtracting, multiplying and dividing five digit fields composed of fives.

After filling in the columns of the matrix, we could add across the rows to obtain the total for each computer system. Since the equipment specifications factor accounted for one-fifth of our study, we had to convert the percentage points awarded to a base of twenty from one hundred. After dividing all totals by 5 we posted the results in a column headed equipment specifications points awarded (see Appendix A).

### Through-put or Benchmarks

As stated earlier, we gave the manufacturers four benchmark problems which were representative of SK&F data processing. We asked each manufacturer to submit flow charts, processing time estimates, estimated number of instructions, description of methods of handling files and file and record layouts, and descriptions of the techniques used in the computer runs to process these problems. We required that the problems be processed in one-half of a prime shift on the proposed configurations.

Having allocated 20 percentage points of our entire study to the benchmark factor, we distributed these points to the individual problems in accordance with their relative importance to our data processing workload.

Problem	Relative Importance	Percentage Points
Marketing Information Retrieval and Mailing List Preparation ..	35%	7
Billing and Sales Analysis .....	30%	6
Scientific Information Retrieval ..	30%	6
Statistics .....	5%	1
	100%	20 points



For each problem, the computer system with the fastest running time received the maximum points allowed for that problem, the other systems received relative partial credit based on the relationship between their times and the fastest as follows:

$$(\text{relative point value}) = (\text{points assigned}) \times (\text{lowest, or fastest, running time}) / (\text{running time of the system being evaluated})$$

For example, if the fastest system processed billing and sales analysis in 10 hours it received 6 points. If another system required 15 hours, it would receive 4 points.

These points were posted to additional columns on our matrix and summed to derive a column for the total points awarded for our benchmark factor.

Quite obviously the most important element of this phase of our study was to be sure that all of the manufacturers being evaluated fully understood and solved the problem and used the same timing criteria. For example, in their proposals some manufacturers did not estimate set-up times and others did, some included a fudge factor, etc. We decided to add set-up times where it had not been considered and to eliminate the fudge factor where it had been included.

Analyzing the benchmark problems presented to us was the most time-consuming part of our study. Only two of the manufacturers completely understood, solved, and documented the problems. We had to rework most of the problems for the other six to take care of aspects that had been misunderstood, ignored, or inadvertently omitted. In nearly every case reworking the problem with the manufacturer resulted in a more optimum system and thus aided the manufacturer in obtaining more points than he otherwise would have.

### Software Factor

In order to evaluate the software offered by each manufacturer we collected the specifications and write-ups of the various programs. We compiled a list of those programming aids which we felt were most important to SK&F and designed the questionnaire to obtain data we did not already possess.

We found eight categories of principal software packages on which we based our comparisons and evaluations. Since there is no natural common denominator or measurable unit as there was in equipment specifications or benchmark timing, our software evaluation was less objective, less specific, and more relative.

The eight principal categories were:

1. Sorts
2. Program Assembly Routines
3. Report Generator Programs
4. Executive and Control Routines
5. Debugging Routines
6. ALGOL/FORTRAN Compilers
7. COBOL Compilers
8. Miscellaneous Utility Routines

Our programmers, by studying the literature and questionnaires and, when possible, consulting users, determined what they considered to be the most desirable features of all the programs for each of the eight types or categories of programs. A mythical program that contained all of the most desirable features was then considered the norm. We thus had eight fictitious epitomes to which we could compare the eight program packages of each of the manufacturers. We then graded the manufacturer in each of the eight categories depending on how its program compared to the norm. The possible grades:

4.0—excellent performance—its program contained nearly all of the best features.

*June 17, 1815 . . . Rain delays the Battle of Waterloo . . . 24 hours later Napoleon engages Wellington, gambling on victory before the arrival of Allied Reinforcements. He almost carries the day and then Blucher's Army appears. The French are routed. The Empire collapses. But supposing Napoleon had known more about weather, delay and their effects on battle-field conditions . . . would he have won?*



**BATTLE OF WATERLOO**

For several years TECH/OPS programming scientists and analysts have been creating *Synthetic History* to answer a myriad of questions about military operations through the use of manually-played and computer-played war games. OMEGA (Operations Model Evaluation Group, Air Force), established by TECH/OPS for Headquarters Air Force in 1957, has as a task the simulation of large-scale air war battles. The simulation is the most ambitious game undertaken by TECH/OPS, and probably by anyone else.

The models simulate full scale nuclear war; however, they are built in sufficient detail to consider use of their parts for study of problems of lesser scope. The simulations are constructed modularly so that they can be responsively changed to keep pace with evolving weapon systems and doctrines. *Synthetic Histories* produced with these simulations have a direct influence on senior Air Force planners and decision makers.

TECH/OPS work on OMEGA is typical of the Company's work in the System Sciences . . . CORG, COMSAT, 473L, TRAG . . . to name a few other programs. If you would like to work in an environment where your individual contributions count, we would like to hear from you. Positions are available at TECH/OPS in the Washington, D. C. area for experienced Operations Analysts and Computer Programmers.

Write Mr. J. Pierce Jenkins.

**TECHNICAL  
OPERATIONS  
Research**



3600 M Street, N. W., Washington 7, D. C.

An Equal Opportunity Employer

- 3.0—good performance—its program contained most of the important best features.
- 2.0—fair performance—its program contained some of the important best features.
- 1.0—poor performance—its program contained few of the important best features.
- 0.0—no program of this type was offered by the manufacturer.

The eight grades for each manufacturer were then added and the manufacturer with the highest grade was awarded the maximum 20 percentage points allocated to the software factor. The other manufacturers were awarded percentage points based on the ratio of their grades to the highest grade. For example, the highest grade was 25 and that manufacturer received 20 points. A manufacturer whose grade was 12.5 received 10 points and a manufacturer with a grade of 20 received 16.

### Support Factor

We intended that this fourth factor of our study be concerned with four types of support:

1. Support of our programming efforts.
2. Engineering and maintenance of our installation.
3. Back-up or provision for an alternate site for us to use when our machine is down.
4. Assurance of continued existence and progress in the data processing industry by the manufacturer.

Although we had to make subjective and intuitive value judgments in each of these areas, we felt it was better than excluding an obviously important factor from our study.

As with the previous three factors, the support factor was assigned a percentage point value of 20 and we divided these points equally among the four elements listed above so that each was worth 5. Some of the criteria we examined in each of the topics is discussed below.

Our method of awarding points was the same for each of the four elements. The manufacturer that rated the best received the full value of five points; each other manufacturer was awarded points based on how close we thought it came to the leader in providing the service being examined.

It is interesting to note that three manufacturers have their computer headquarters in the Philadelphia area, and the local branch office of a fourth manufacturer is its largest. However, we are not sure whether this made our job any easier.

Here is a list of a few of the criteria we investigated in each of these support topics. The list is not complete and is illustrative only. Each computer user will have different interests, needs, and criteria.

In comparing and evaluating programming support we considered the size of the research programming staff, the size of the local office programming staff, the library of users programs available, the quality of the programming work in the proposals submitted to us, our impression of the proficiency and capabilities of the programmers that we met during our study, the training facilities for customer's programming staff, discussion with other users, etc.

Criteria for investigating engineering and maintenance were the quality and quantity of on-site engineers, the back-up to on-site personnel by local and manufacturing plant engineers, the training programs of these engineers, discussions with users, up-time statistics of other customers, timing and methods of making field changes to a configuration, provisions for custom-engineered special devices, etc.

To compare back-up, we simply obtained a list of systems compatible with that proposed to us that were located in the Philadelphia area. We had data on systems installed,

on order, and some potential orders. We included service facilities that we could rent from the manufacturer.

The last element of support might also be entitled corporate image of the manufacturer. Essentially we wanted to be associated with a manufacturer who was or would be an industry leader, who would be able to meet our data processing needs in 1965 and 1970, and who would be able to do the most for SK&F over the years. One can question whether this is important in an equipment selection study. However, we hear of a future shake-out in the industry and we know the huge investment in research and equipment financing that successful companies must make. We certainly wanted to avoid picking a loser that would not be around to service us five or ten years hence. Therefore, we studied many of the things one does for a security investment: per cent of industry sales, per cent of the company's sales and investment in data processing, data processing research budget, profits and forecasts, financial and organization structure, etc.

### Cost Factor

Our fifth and final factor, also worth 20%, was computer cost. One of the goals of our study was to reduce computer rental by 10-20%. We defined cost as the rental for 176 hours of computer production. We did not have to consider amortizing conversion costs since these costs were the same regardless of which of the eight systems we chose. We also did not have to worry about computer personnel or space costs since these did not vary among the eight proposed configurations or our present situation.

The manufacturer who proposed the lowest price computer received the full 20 points for this portion of the study. The others received partial relative points through the formula:

$$(\text{points awarded}) = 20 \times (\text{lowest price}) / (\text{price of the equipment being evaluated})$$

### Conclusion

Obviously, no one is going to make an investment decision of this nature based solely on points awarded to a matrix. What we hoped to achieve by this exercise was to establish the two or three best alternatives by a disciplined, objective, uniform analysis and then proceed with detailed contrast studies of each survivor against the other survivor(s). As it turned out, two systems stood out above the rest which we studied in detail—going through the methodology already described but with the two rather than the eight and by doing additional studies. Some of these were:

- An application cost analysis where we determined the through-put cost. This is not a simple calculation of computer running time multiplied by an hourly charge. Here we have to consider different rates for various components such as off-line or satellite or slave input/output, the master central processor, etc., and the problems associated with allocating costs on a multi-channel system.
- Projected configurations, dates, and costs for an expanding data processing workload.
- Analysis of the devices, appliances, software routines available but not proposed by the manufacturer at this time.
- Detailed studies of the programming languages available.

The important thing to remember when thinking about this methodology is that the standards selected, the criteria measured, and the weighting of the inter-related factors will vary with time and the goals of the user. No one system or distribution of weights will fulfill the needs of all users at all times.

Chart 1 summarizes and illustrates the factors and weights that we have discussed.

*Your instrumentation  
tape supplier should be  
a complete source.*  
**Soundcraft is!**

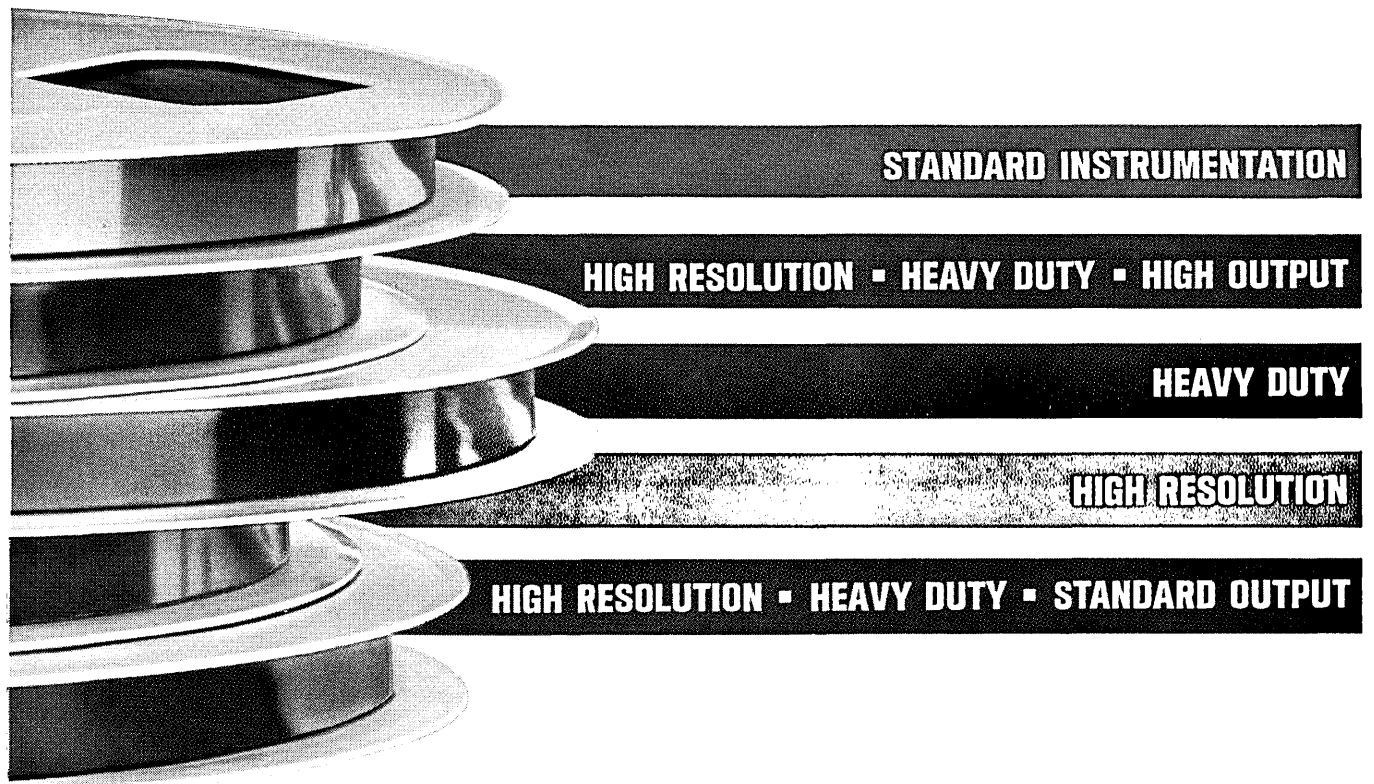

With Soundcraft Instrumentation Tapes, you can meet every data recording need. Sixteen combinations of coatings and base materials are available to fulfill the recording time, resolution, wear-life and output characteristics required by your data recording equipment.

Common to each instrumentation tape is Soundcraft's technical competency. This is demonstrated by the unique oxides and binder systems which are engineered to provide su-

perior physical and magnetic qualities for all recording applications. The Soundcraft plant is one of the newest and best-equipped in the industry—where advanced manufacturing processes and control methods produce superior instrumentation tapes. Reliable data recording is assured.

In military and space facilities... among industry leaders... Soundcraft Instrumentation Tapes are meeting the most exacting performance standards. They can meet yours, too.

Soundcraft Instrumentation Tapes are available from stock for immediate delivery. Write for literature.

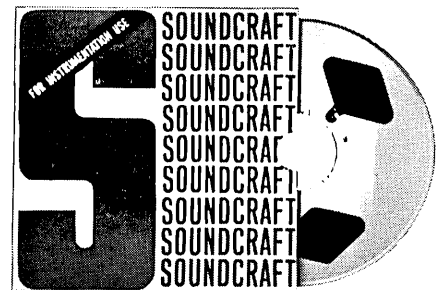

REEVES **SOUNDCRAFT** CORP.

Main Office: Great Pasture Rd., Danbury, Conn. • New York: 10 E. 52nd St. • Chicago: 28 E. Jackson Blvd. • Los Angeles: 342 N. LaBrea • Canadian Reps.: Toronto • Vancouver

# Possibilità applicative dell'automazione nell'amministrazione aziendale

Časová tíseň a její vliv na činnost operátora v podmínkách centrálního

## Die Handwerker-Versicherung verabschiedet

ВЛИЯНИЕ НЕРАВНОМЕРНОСТИ НАМАГНИЧИВАНИЯ  
НА СТАТИЧЕСКИЕ ХАРАКТЕРИСТИКИ СЕРДЕЧНИКА. II

— 4 4 0 . 2 1 - 4

### § 6. Das Studium einiger partikulären Fälle. Der Fall, der von G. S. Makaeva betrachtet wurde

This chapter discusses machine or automatic translation of natural languages. It reviews the status of the art at present; explains its basic operations, methods and procedures; indicates its objectives and uses, and situates machine translation or MT in the general field of automatic language data processing. Finally, it suggests its possible role in language communication as a whole.

Machine translation is a relatively new area of automatic language data processing. It came about in part as a result of the conjuncture of three trends: (1) the development of structuralist procedures in linguistics; (2) the increasing sophistication of programming techniques, and (3) the growing capabilities and versatility of computation devices. It also became a subject of interest in the scientific and managerial communities as a result of the increasing volume and diversity of scientific and technical writings in the several languages of scientifically creative cultures, and the lengthening lag between the publication of information in a given language and its accessibility in one or several other languages.

A decade ago machine translation was of interest to a relatively small group of people coming from such apparently unrelated fields as philosophy, physics, mathematics, sociology, logic, computational engineering, chemistry, and of course linguistics and languages. This diversity of background among the early comers was to bring about a widely diversified and divergent set of notions as to what automatic translation is or should be, what it ought to try to do, how and why it should do it.

Notwithstanding these divergences, MT research today is pursued in a number of centers and laboratories in some twenty countries, including besides the United States, where oriented research may be said to have originated, Great Britain, the U.S.S.R., Japan, Italy, France, Belgium, Germany, and others. The first public demonstration of feasibility was carried out jointly by Georgetown University and IBM in January, 1954, on the basis of an experiment for the transfer of a small corpus of Russian to English on an IBM 701. The methods and results of this experiment, necessarily limited in scope, were made public.

Today there are, to my knowledge, three regular MT professional journals, one in this country, one in France and a third in the U.S.S.R.<sup>1</sup> At least two general national symposia have been held, one in the U.S., the other in the Soviet Union and the first International Conference on MT, was held at the National Physical Laboratory, Teddington, England, in September 1961. A first international seminar was held under the auspices of NATO in Venice last summer. A large number of reports and studies have been published by individuals and groups in several countries. Experimental and trial runs of increasing scope have been reported and some of their text output published for examination and review. Finally, courses in MT (or courses related to basic research in the field) have been introduced in the curricula of a number of universities in several countries and programs of studies leading to the doctorate in the field are under development in several places.



# MACHINE TRANSLATION AND LANGUAGE DATA PROCESSING

Leon E. Dostert

Georgetown University  
Washington, D. C.

This brief inventory of the results of efforts over a decade, limited to the salient aspects of the work done, suffices to show the growing importance of machine translation. After ten significant years it is worthwhile therefore to attempt to situate MT research in the general field of which it is a part—that of automatic language data processing, to see what experience appears to teach us, and where we may expect to go in the immediate future.

Natural languages, unlike conventional sign systems such as those of chemistry or mathematics, are culturally based. Natural languages are structured and can be and are being increasingly formally described. The systems of notation used to represent the nature and functions of language signs may be such as to make them appear to be mathematical formulas. But linguistics is obviously not a part of mathematics, though the algorithmic representation of some generalized usages or “rules” may give that impression. Also, in our language manuals, when we speak of “rules,” we are in fact describing the habits confirmed by “proper” usage among the largest groups of users of a given language.<sup>2</sup>

MT is now directing its efforts to the translation of written languages. What this involves will be described in some detail below. As for the oral form, while some preliminary steps have been taken, we are still far from oriented research.

There are several ways in which we can think of machine translation. We can of course dream of a day when “perfect” translation from and into several languages will be obtained with speed or at a relatively low cost in almost any realm of language. This is a rather remote objective, though a valid one, provided the quest for high quality, wide diversity and great speed does not preclude the attainment of more modest, practical, useful results attainable in reasonable time and at acceptable cost. Of course, any early systems should be so conceived and constructed as to remain open-ended and likely to yield results applicable to the refinement and broadening of the initial procedures.

We should accept the fact that “perfect” translation is neither *humanly nor mechanically* achievable. We should likewise recognize that although a so-called word-for-word translation can be carried out on a computer with relative ease, it is of no practical value. What then should we aim for? The experience of the last decade seems to argue for focussed and coordinated programs extending over two or three years for one-directional translation involving two languages, and in restricted areas such as the physical or natural sciences, general technology, economics, law, engineering, etc. These limited programs should strive for maximum results in terms not only of usability, but of revealing un-

<sup>1</sup> A new publication, “Information Processing Journal,” contains in its first monthly issue seven abstracts of four articles and three books under the heading “Natural Languages, Linguistics and Mechanical Translation” (p. 39).

<sup>2</sup> See David G. Hays, *Research Procedures in Machine Translation*, Memorandum RM-2916-MR, December 1961, The Rand Corporation, introductory pages.

anticipated problems, confirming the validity of initial procedures, and bringing nearer the general solution of only partially resolved problems.

In terms of practical use, what is a reasonable norm of acceptability for machine output attainable in the near future? Can we accept the following standard?

The output text should convey the same information as the input text; if it describes a chemical experiment, a chemist should be able to read the translation and reproduce the experiment with no more difficulty than if he had read the original report. Moreover, he should be able to read the translation as easily as if it had been written by a person fluent in the output language—Russian documents should be translated into versions that might have been written by Americans, for example.<sup>3</sup>

Isn't this in fact requiring of the machine more than is generally performed by human translators? There is nothing wrong with this objective in terms of long-range efforts and those who are familiar with the vagaries of human translators look forward to some day when the machine may do better.

A more immediately achievable standard of practical performance is given by Ida Rhodes of the National Bureau of Standards.

If, for example, a translated article enables a scientist to reproduce an experiment described in a source paper and to obtain the same results—such a translation may be regarded as a practical one. Perhaps the translation is not couched in elegant terms; here and there several alternative meanings are given for a target word; a word or two may appear as a mere transliteration of original source words. Nevertheless, this translation has served its main purpose: a scholar in one land can follow the work of his colleague in another.<sup>4</sup>

This does not require of machine output the same ease of readability elegance of style or completeness of language transfer, but it does insist on reliability of information transfer.

Have we reached a point, or are we about to reach it, where the language of a scientifically creative culture can be processed on a computer so as to produce an intelligible, reliable, and therefore acceptable, output so that "a scholar in one land can follow the work of his colleague in another"?

The following pages present a machine translated section of a Russian book in the field of cybernetics aimed at the general reader.<sup>5</sup> From the 120-page text we have reproduced only that section which deals with machine translation. The book was translated into English on an IBM 7090 computer on the basis of the current Georgetown MT program, and this is a second cyclical run, i.e., it includes lexical and structural improvements based on the review of a first output.

The reason we are reproducing a section from this book is that it is by and large nontechnical. Another reason is that this chapter deals with the subject of MT.

It will be seen that the text is presented in two columns. The column on the left contains every detail of the output as it actually was produced by the computer. The column on the right presents the same text with a minimum of editing to facilitate reading. A study of both columns will, we believe, show that the translation adheres to the standard of reliability of information-transfer mentioned above. The lexical and structural inadequacies which are readily noticeable in the left-hand column, and which have in part been eliminated in the human-revised version on the right-hand column, are at present the subject of careful study. As a

<sup>3</sup> David G. Hays, *ibid.*

<sup>4</sup> Ida Rhodes, "A New Approach to the Mechanical Syntactic Analysis of Russian," *Mechanical Translation*, November 1961.

<sup>5</sup> The original Russian text of this passage is reproduced as appendix I to this paper. It is taken from Z. Rovensky, A. Uemov and E. Uemova "Mashina i Mysl'" (Machine and Thought), State Publishing House, Moscow 1960.

## Actual Machine Translation

### A machine translation

By by one from the first practical applications of logical capabilities of machines was their utilization for the translation of texts from one tongue on other. Linguistic differences represent the serious hindrance on a way for the development of cultural, social-political and scientific connections between nations. Automation of the process of a translation, the application of machines, with a help which possible to effect a translation without a knowledge of the corresponding foreign tongue, would be by an important step forward in the decision of this problem.

A machine, as already repeatedly stressed, does not penetrate into a sense being carried out by it the operations. *mashinaperevodchik*, in particular, cannot be attracted to a to a content being converted by it a text; it operates only pure by formal relations. The effecting of an automatic translation from an one tongue on other supposes a composition such the programs, in which the agreement between by both tongues represented in the form of a system strict formal relations, which were installed on the basis of structural analysis of this and other tongue. (page 88) Assumptions for such an analysis, principal possibilities the establishments of an abstract system formal of agreements in tongues, as was showed above, have.

On the example of a translation of the phrase from a greek tongue on latin we saw, by which way possible in the principle to convert from an one tongue on other, not knowing any one from them. But there we had fact only with by an one proposition and with the dictionary, which consists in all from some 10 elements. For the translation of texts of more solid dimensions, naturally, necessary the dictionary of agreements, significantly more voluminous and complex. The composition of such dictionaries for whole tongues would be a problem practically unrealizable, if there were no such possibilities of a formalization of a tongue, concerning which spoke above.

On the basis of detachment from material, the lexical values of the words, there are installed the formal-grammatical agreements between by tongues. This makes it possible to constitute the separate dictionary of the grammatical indexes — the kind, the numbers, the case, a time, parts of a speech etc., instead of this to introduce in the program of a machine all of the words with by the corresponding attachments, by the suffixes and by completions.

## Machine Translation

### With Some Editing

#### Machine Translation

One of the first practical applications of logical capabilities of machines was their utilization for the translation of texts from one tongue on other. Linguistic differences (5)

present a serious hindrance on the way for the development of cultural, social - political and scientific relations between nations. Automation of the process of translation, the application of machines, with the help of which it is possible to effect a translation without knowledge of the corresponding foreign tongue, would be an important step forward in the resolution of this problem. (10) (15)

A machine, as already repeatedly stressed, does not penetrate into the sense carried out by it of the operations. Machine translator, in particular, cannot handle the content converted by [it] of a text; it operates purely by formal relations. The effecting of an automatic translation from one tongue on other supposes the composition of such program, in which the agreement between both tongues represented in the form of a system of strict formal relations, which were established on the basis of structural analysis of this and the other tongue. (page 88) Assumptions for such an analysis, the principal possibilities of the establishment of an abstract system of formal agreements in tongues, as was showed above exist. (20) (25) (30) (35)

On the example of a translation of the phrase from Greek tongue on Latin we saw, in which way it is possible in principle to convert from one tongue on other, not knowing either one of them. But there we dealt only with one sentence and with the dictionary, which consists in all of some 10 elements. For the translation of texts of larger dimensions, naturally, is necessary a dictionary of agreements, significantly more voluminous and complex. The composition of such dictionaries for whole tongues would be a problem practically unrealizable, if there were no such possibilities of (40) (45) (50)

formalization of a tongue, concerning which we spoke above.

On the basis of detachment from basic lexical values of the words, there are established the formal-grammatical agreements between tongues. This makes it possible to constitute the separate dictionary of the grammatical indexes—the gender, the number, the case, tense, parts of speech etc., rather than to introduce in the program of the machine all of the words with corresponding attachments, the suffixes and endings. (55) (60)

result of this review, the program will again be modified to incorporate generalized solutions to permit a higher level of output quality. This is the principle of cyclical-improvement procedure which will be described in more detail later on. Thus, by comparing the quality level of the output of a given text at a certain phase of production with the same text printed out on the basis of a partially improved, and repeatedly improved program, it is possible to demonstrate two things to which again we will refer in greater detail later: (1) that the system is constituted so as to remain open-ended, and (2) that relatively short time focused on improvement research permits the up-grading of the output product in a significant manner.

A review of the right-hand column of the revised text, in which under-scoring indicates the corrections, reveals that the largest number of errors (about one fourth of the total in the passage given) involves insertion of the definite or indefinite article in English. In spite of different approaches during the last four years, we have not yet been able to develop a reliable formal program for article insertion in Russian-English MT, nor do we know of any program on the article which has been tested. (Most of the material published on MT is in the form of theoretical studies rather than reports on actual computer experiments on specific or general procedures.) The second largest source of errors in the passage given involves the use of prepositions in general and in particular of the selection of "of" and "from" in English, as well as the use of the preposition "by" as an oversimplified procedure in the transfer of the Russian instrumental case. The third most frequent error occurs in lexical equivalents and a few lexical gaps. These inadequacies, and other deficiencies, will be eliminated to a considerable degree in a next cyclical run.

A separate random<sup>6</sup> text in the field of cybernetics was run recently against the program. Being more technical and therefore less complicated lexically and stylistically, the quality of the output is reported to be equal or superior to that of the book itself, of which the sample reproduced above is quite representative.

The processing of the signs of natural language by electronic computers for translation of a given source language into a chosen target language presents problems basically different from those presented by the automatic processing of conventional language signs, such as those of mathematics or chemistry. When in the field of numbers, for instance, we deal with different systems of representation such as the decimal or duodecimal, the binary or even the Morse system (essentially binary) we have obviously a fixed and generalized transfer of relationships between the different systems of signs. This is not true, or at least we have not yet established such correlation between any two natural language systems.

The signs (in natural language can be characterized as "unspecific" or "unstable" in the sense that a given letter or groups of letters between spaces (a word) will carry different information in terms of the language in which it operates, and also in terms of its possible equivalents in another language. Contextual factors, either phrase groups, sentences, or larger discourse units, or again in the sense of different fields or disciplines, are the basis for the reduction or elimination of ambiguity. Further, communication through natural languages involves in effect the obtaining of information from signs, oral or written, which are "known" to the hearer or reader. In a monolingual situation, different levels or fields of discourse are accessible only to a person knowing the fields and

<sup>6</sup> By "random text" we mean a passage or article in a given discipline which is run without previous lexical or structural study or abstraction for incorporation in the program. A copy of this "random text" is available on request.

level of discourse. In natural languages (and for that matter in conventional sign systems) the two basic means for the discernment of information are the forms of the signs and their distribution.

In the translating of one language into another, we are confronted with two distinct sign structures. Our problem is one of transfer. This transfer means that the information in a source text will be represented in another language form or text. What is involved in this transfer when we speak of machine translation? Some years back I attempted an explanation to the effect that MT involved the transfer of meaning by computers from the signs of the source language to those of the target. It is more accurate to describe the operation as involving the systematic substitution by computing devices of the signs of the target language for those of the source language, with the obvious aim of maximum information transfer.

Since we are dealing, for the present at least, with two structures, and since we are seeking to effect the systematic substitution of signs, it follows that we must establish as complete a correlation or correspondence between the structures involved as is required for effective information transfer. Thus we may say that MT research is, or should be, oriented to a specialized area of linguistic investigation, which is called transfer linguistics. While this may seem obvious to some, considerable research effort has been aimed primarily at intrinsic or monostructural investigation rather than at bistructural transfer programs. The thesis has been upheld by many that a "complete" analysis of a given structure should precede any approach to the problem of transfer, and that exhaustive monostructural automation is a prerequisite to systematic bi- or multi-lingual transfer. More pragmatic and empirical procedures are being gradually developed by other groups with reasonably promising results and prospects in terms of relatively modest and immediately practical aims.

### Actual Machine Translation

From an other standpoint, the separation of the prefixes, the suffixes and completions permits isolating in a word this its part, which is kept upon all its modifications and contains the lexical value of the given word.

All this significantly reduces the volume of the memory apparatus, necessary for an automatic dictionary. . . .

The selection of the words for a dictionary produces on the basis of statistical calculation of their use - in a tongue in general language, if constitutes a general dictionary, and in given to the branch of a science or a technology upon the preparation of special dictionaries.

Itself is understood, the words of a converted text cannot introduce into a machine in the form of combinations known to us the letters of a written tongue. For them necessary the special system of designations, a special code, "clear" to a machine. The symbols of this code must correspond to the elements of a tongue, not changing the sense of the latter. As far as for the logical operations, and also for a translation, are used the usual electronic - numerical machines, which realize different actions

### Machine Translation With Some Editing

From another standpoint, the separation of the prefixes, the suffixes and endings permits isolating in a word the part which is kept in all its modifications and contains the lexical value of the given word. (70)

All this significantly reduces the volume of the memory apparatus, necessary for an automatic dictionary. . . .

The selection of the words for a dictionary is produced on the basis of statistical calculation of their use in general language, if a general dictionary is made, and in a given branch of a science or technology for the preparation of special dictionaries. (80)

It is understood, the words of a translated text cannot be introduced into a machine in the form of combinations known to us as the letters of the written tongue. For them is necessary the special system of designations, a special code, "clear" to a machine. The symbols of this code must correspond to the elements of a tongue, not changing the sense of the latter. For the logical operations, and also for a translation, are used the usual electronic-numerical machines, (95)

over 1 and also 0, combinations of these two symbols express upon the composition of the program for the machine - translator also and a word of a tongue. Each basis, the each prefix, suffix, completion and also any other introduced into a "memory" a machine element is compared with the definite combination of units and zeroes. These combinations are transferred on the punched tape in the form of alternations of holes and gaps, which as a result of a series of closings and also openings are converted in the corresponding combination of conducting and also nonconducting states of electronic lamps. Upon the help of a whole series of a relay symbols on a punched tape are compared with the dictionary, which are found in "a memory" a machine. Comparison occurs in the form of a subtraction of dictionary combinations from combinations on a punched tape.

If compare words do not coincide, as a result this operation receives which anyone a number, but not 0. In this case occurs switchin on the following word of a dictionary, and so up to these being time, meanwhile upon a subtraction does not receive 0. 0 signifies, that a machine finding in a dictionary a combination, equal with given. Now necessary to know, which corresponds to it in by friend a tongue. Side-by-side with each word of a converted tongue is indicated the number of the cell, containing the corresponding combination of this tongue, on which convert. A when subtraction gives as a result 0, switching occurs already not on the following word of a dictionary, but on this cell of the second tongue, a number which is side-by-side with by the given word. (page 90) A combination of states of the apparatus "of a memory", concluded in this cell, gives upon an exit definite the alternation of holes and gaps on a blade, which is converted then on the usual tongue of letters. The when memory apparatus contains not the wholly words, but their bases and the grammatical indexes, then the machine seeks at first in the dictionary of the bases the maximum combination, which agrees with the first part of the given words, but then in the dictionary of the suffixes and also completions finds other its part. We permit, on the punched tape of a machine, converting from an english tongue on russian, perforated a word "letterless". In the dictionary of the bases turn out to be words "summer, Lett", "letter". A machine stops only on the latter, as far as it coincides with by a maximum part of the given in word and gives its translation: a letter, a learning, literacy. Then searches for a value which left to a part of a word - less, indicating a negation, as a result of which on an exit is obtained a russian word "an ignorance", "illiteracy".

.....

which realize different actions over 1 and 0, combinations of these two symbols are expressed upon the composition of the program for the machine-translator, and also the words of the tongue. Each (100) base, each prefix, suffix, ending and also any other element introduced into the "memory" of the machine is compared with the definite combination of units and zeroes. These combinations are transferred on the punched tape in the form of alternations of holes and gaps, which as a result of a series of closings and openings are converted in the corresponding combination of conducting and nonconducting states of electronic lamps. With the help of a whole series of a relay symbols on a punched tape are compared with the dictionary, which are found in the "memory" of the machine. Comparison occurs in the form of a subtraction of dictionary combinations from combinations on a punched tape.

If compared words do not coincide, as a result of this operation a number is obtained, but not 0. In this case occurs switching to the following word of dictionary, and so on until a subtraction does not receive 0. 0 signifies that a machine finds in dictionary a combination equal with given. Now it is necessary to know, what corresponds to it in another tongue. Side-by-side with each word of a converted tongue is indicated the number of the cell containing the corresponding combination of the tongue, into which to translate. [When] a subtraction gives as a result 0, switching occurs no longer to the following word of dictionary, but on this cell of the second tongue the number of which is side-by-side with the given word. (page 90) A combination of states of the apparatus of the "memory" included in this cell, gives as an exit a definite alternation of holes and gaps on a tape, which is converted then in the usual language of letters. When [the] memory apparatus contains not the complete words, but their bases and the grammatical indexes, then the machine seeks at first in the dictionary of the bases the maximum combination, which agrees with the first part of the given words, and then in the dictionary of the suffixes and endings it finds its other part. For instance, on the punched tape of a machine converting from English tongue to Russian is perforated the word "letterless." In the dictionary of the bases turn out to be words "let", "Lett" and "letter." A machine stops only on the latter, as far as it coincides with a maximum part of the given word and gives its translation: letter, learning, literacy. Then searches for a value of the part of word left - less, indicating a negation, as a result of which in the output is obtained Russian word "ignorance", "illiteracy".

.....

# CALENDAR OF COMING EVENTS

- May 13-15, 1963: National Aerospace Electronics Conference (NAECON), Biltmore Hotel, Dayton, Ohio; contact IEEE Dayton Office, 1414 E. 3rd St., Dayton, Ohio.
- May 16, 1963: Western Systems Conference, Statler-Hilton Hotel, Los Angeles, Calif.
- May 17-18, 1963: Symposium on Artificial Control of Biology Systems, Univ. of Buffalo, School of Medicine, Buffalo, N. Y.; contact D. P. Sante, 4530 Greenbriar Rd., Williamsville 21, N. Y.
- May 20-22, 1963: 12th National Telemetry Conference, Hilton Hotel, Albuquerque, N. M.; contact A. E. Bentz, Sandia Corp., 7113, Box 5800, Albuquerque, N. M.
- May 20-22, 1963: National Symposium on Microwave Theory and Techniques, Miramar Hotel, Santa Monica, Calif.; contact Irving Kaufman, Space Tech. Labs., Inc., 1 Space Park, Redondo Beach, Calif.
- May 21-23, 1963: Spring Joint Computer Conference, Cobo Hall, Detroit, Mich.; contact Dr. E. Calvin Johnson, Bendix Aviation Corp., Detroit, Mich.
- May 23-24, 1963: Association of Data Processing Service Organizations Symposium, Royal York Hotel, Toronto, Canada.
- June 6-7, 1963: Symposium on Banking Automation, Palmer Motor Inn, U. S. Highway No. 1, Princeton, N. J.; contact Mrs. P. V. Burghart, National Computer Analysts, Inc., Route 206 Center, Princeton, N. J.
- June 11-13, 1963: National Symp. on Space Electronics and Telemetry, Los Angeles, Calif.; contact John R. Kauke, Kauke & Co., 1632 Euclid St., Santa Monica, Calif.
- June 17-18, 1963: Computer and Information Sciences (COINS) Symposium, Northwestern Univ. Technological Institute, Evanston, Ill.; contact Prof. Julium T. Tou, Co-Chairman, Computer Sciences Lab., Northwestern Univ., Evanston, Ill.
- June 19-21, 1963: 4th Annual Joint Automatic Control Conference, Univ. of Minnesota, Minneapolis, Minn.; contact R. K. Adams, Union Carbide Nuclear Co., P. O. Box X, Oak Ridge, Tenn.
- June 23-28, 1963: ASTM 66th Annual Meeting, Chalfonte-Haddon Hall, Atlantic City, N. J.
- June 25-28, 1963: Data Processing Management Association's 12th International Data Processing Conference and Business Exposition, Cobo Hall, Detroit, Mich.; contact DPMA Headquarters, 524 Busse Highway, Park Ridge, Ill.
- June 26-27, 1963: 10th Annual Symposium on Computers and Data Processing, Elkhorn Lodge, Estes Park, Colo.; contact W. H. Eichelberger, Denver Research Institute, Univ. of Denver, Denver 10, Colo.
- July 15-17, 1963: 3rd Annual Rochester Conference on Data Acquisition and Processing in Medicine and Biology, Whipple Auditorium, Univ. of Rochester Medical Center, Rochester, N. Y.; contact Kurt Enslein, 42 East Ave., Rochester 4, N. Y.
- July 22-26, 1963: 5th International Conference on Medical Electronics, Liege, Belgium; contact Dr. L. E. Flory, RCA Labs., Princeton, N. J.
- Aug. 4-9, 1963: International Conference and Exhibit on Aerospace Support, Sheraton-Park Hotel, Washington, D. C.; contact F. K. Nichols, Air Defense Div. Directorate of Operations, DSC/O Hdq., USAF, Washington 25, D. C.
- Aug. 8-9, 1963: 6th Annual Summer Conference, Pacific Science Center, Seattle, Wash.; contact Harold Ostling, Sec'y., Northwest Computing Association, P. O. Box 836, Seahurst, Wash.
- Aug. 20-23, 1963: Western Elec. Show and Conference (WESCON), Cow Palace, San Francisco, Calif.; contact WESCON, 1435 La Cienega Blvd., Los Angeles, Calif.
- Aug. 27-Sept. 4, 1963: 2nd International Congress on Automatic Control Swiss Industries Fair, Basle, Switzerland; contact R. M. Emberson, Professional Groups Secretary, IEEE, Box A, Lenox Hill Station, New York 21, N. Y.
- Aug. 28-30, 1963: Association for Computing Machinery, Annual Meeting, Denver, Colo.
- Sept. 9-11, 1963: 7th National Convention on Military Electronics (MIL-E-CON 7), Shoreham Hotel, Washington, D. C.; contact L. D. Whitelock, Exhibits Chairman, 5614 Greentree Road, Bethesda 14, Md.
- Sept. 9-12, 1963: 18th Annual ISA Instrument-Automation Conference & Exhibit, McCormick Place, Chicago, Ill.
- Sept. 9-12, 1963: International Symposium on Analog and Digital Techniques Applied to Aeronautics, Liege, Belgium; contact M. Jean Florine, 50, Avenue F. D. Roosevelt, Brussels 5, Belgium.
- Sept. 16-20, 1963: 2nd Institute on Electronic Information Display Systems, The American University, SGPA, The Center for Technology and Administration, 1901 F St., N.W., Washington 6, D. C.; contact Dr. Lowell H. Hattery, The American University, Washington 6, D. C.
- Sept. 23-27, 1963: International Telemetry Conference, London Hilton Hotel, London, England; contact F. G. McGavock Associates, 3820 E. Colorado Blvd., Pasadena, Calif.
- Oct., 1963: 10th Annual Meeting, PGNS 2nd International Symposium on Aerospace Nuclear Prop. and Power
- Oct. 1-3, 1963: 8th Annual National Space Electronics Symposium, Hotel Fontainebleau, Miami Beach, Fla.; contact Hugh E. Webber, Martin Co., Orlando, Fla.
- Oct. 7-9, 1963: 9th National Communications Symposium, Hotel Utica, Utica, N. Y.
- Oct. 8-11, 1963: Int'l on Electromagnetic Relays, Tohoku University, Sendai, Japan; contact C. F. Cameron, School of Eng., Oklahoma State University, Stillwater, Okla.
- Oct. 14-15, 1963: Materials Handling Conference, Chamberlain Hotel, Newport News, Va.; contact R. C. Tench, C & O Rlwy Co., Rm. 803, C & O Bldg., Huntington 1, W. Va.
- Oct. 14-16, 1963: Systems and Procedures Association, 16th International Systems Meeting, Hotel Schroeder, Milwaukee, Wis.; contact Systems & Procedures Association, 7890 Brookside Dr., Cleveland 38, Ohio.
- Oct. 21-23, 1963: East Coast Conference on Aerospace & Navigational Electronics (ECCANE), Baltimore, Md.



# A SUMMARY OF RECENT ADVANCES IN THE COMPUTER FIELD

*The impressions of several engineers in the computing devices field are summarized to present an overall perspective of the size, growth, and scope of technical activity in this area. Examples of current commercial usage and design practice, as well as noteworthy "firsts," range from components and integrated circuits through complex multicomputer systems*

Significant developments in the computing devices field may be identified in at least three phases: (1) first demonstration of feasibility, usually in a laboratory; (2) first application; and (3) first delivery for public use. Significant trends are identified as strong evidence of rapid growth in acceptance of an idea or product, even though the idea may have been initially disclosed and used in prior years.

During 1962, the development and installation of new computing devices continued at a high rate. Sales increased approximately 20 per cent, exceeding one billion dollars in 1962, with another 50 per cent estimated for computer programming. Analog computer sales, about 5 per cent of the total, increased at least as rapidly as digital sales. The total annual operating expenditures for installed computers is not known, but Federal expenditures alone were approximately \$500 million. Although few manufacturers of computers claim that the business is profitable, many of the anticipated dropouts failed to occur.

Government and military interests in computing devices have become and still are a dominant factor in the amount of computer research and development in the United States. Being the largest single customer for both commercial and scientific data-

processing equipment, the government and its agencies have indirectly supported company-sponsored research and development projects. In addition, they have given much direct support to new developments, often by ordering special computing devices with advanced characteristics long before commercial applications could support the work. There has been a continuing trend, however, toward the award of contracts on the basis of the lowest qualified fixed-price bidder rather than cost plus fixed fee.

IBM's Stretch computer, installed in 1961 at Los Alamos, New Mexico, is still the largest. Subsequent trends in large systems appear to be toward modular and parallel organizations with a capability for working either large single problems or a multiplicity of smaller problems simultaneously. Satellite computers connected on line to other computers, even at diverse locations, to form large systems are also now an accepted concept. Other features that appeared in large systems include multilevel instruction "look ahead," memory stacks, overlapped-core memory banks, asynchronous operations, and stored master control programs. There is a definite trend toward real-time on-line processing on computers of all sizes.

Smaller scientific and business computers also appeared with features that previously were justifiable only on very large systems. Faster and larger memories became common, as did buffering, which enables internal operations to be executed simultaneously with a flow of input/output data. Magnetic tape, drum, and disk data-storage media have improved in bit density, access time, rate of data flow, and maximum capacity. Ferrite core and magnetic thin-film memories appeared with access and cycle times measured in tenths of microseconds, several of which were delivered as part of complete computers. New sonic delay-line and photographic memories appeared.

The announcement of new types of integrated

---

Essentially full text of conference paper CP63-331, presented at the IEEE Winter General Meeting, New York, N.Y., Jan. 27-Feb. 1, 1963, at a session sponsored by the AIEE Computing Devices Committee.

The Ad Hoc Group consists of the following members:

J. F. Kalbach (Editor)	Burroughs Corp., Pasadena, Calif.
H. H. Green	General Electric Co., Phoenix, Ariz.
D. H. Hogan	National Security Agency, Fort Meade, Md.
R. M. Kalb	Remington Rand Univac, St. Paul, Minn.
J. C. McPherson	IBM Corp., New York, N.Y.
P. G. Northrop	National Cash Register Co., Dayton, Ohio
R. J. Preiss	IBM Corp., Poughkeepsie, N.Y.
T. J. Williams	Monsanto Chemical Co., St. Louis, Mo.

Subcommittee chairmen of the Computing Devices Committee were asked to identify and summarize significant developments and trends in 1962. The editor gratefully acknowledges their assistance as well as that of others too numerous to mention.



circuits or microcircuits, delivery of working samples, and completion of several small experimental computers using them substantiated earlier forecasts of growing interest and future trends. Conventional components and solid-state circuits have also been improved and costs have been reduced.

Programming languages and compilers, which are an important part of computer systems, are still described by several individuals as "chaotic." They are in need of further development and rigorous definition which standards activities can bring. Algol, Cobol, and Fortran were the first to receive such attention from ASA committees.

Hybrid digital/analog circuits found additional application in analog-computer, control-computer, and data-logging closed-loop systems. The number and variety of new control-computer applications increased at a satisfactory rate.

**NEW COMPUTERS**

The following commercial general-purpose computers constitute a good cross section of those delivered in 1962 or announced for future delivery. They range from the CDC 6600 (largest) down to the DEC PDP-4 (smallest), but not necessarily in the order listed.

Large Systems	Small Systems
CDC: 6600, 3600	IBM: 1440
IBM: 7040, 7044, 7072, 7094	Burroughs: B260, B270, B280
Burroughs: B5000, D825	NCR: 315
Univac: 1107, 111	Philco: 1000
Honeywell: 1800	SDS: 910, 920
Philco: 2000-212	Univac: 1004
ASI: 420	ASI: 210
RCA: 601	DEC: PDP-4

Some of the features of interest are noted in other sections of this article. Many of the larger machines are designed as extensions of smaller systems and provide for expanded capabilities when the smaller system is outgrown. For example, the CDC 6600 is expected to use much of the CDC 3600 hardware

and "software." Similarly, the IBM 7010 is for those who outgrow the IBM 1410 and wish to use their 1410 programs and input/output devices without changes.

English Electric's KDF-6 computer has a ferrite-core memory that holds as many as 24,576 alphanumeric characters of six bits each. Data are stored in individually addressable groups of three characters, each called "triads." Magnetic tapes have variable-length duplicate recording, and will give correct readout even if a bit from one channel is missing. Input to the computer is through 1,000-character-per-second paper tape; output is from a high-speed line printer.

Ferranti-Packard's FP 6000 computer is a 1-mc parallel-logic Canadian-designed machine. First delivery was scheduled to the Federal Reserve Bank in New York City. A digital computer has been designed and built at the University of Buenos Aires, Argentina, reportedly the first developed in South America. It will be used at the Engineering School for training in maintenance, operation, and programming.

In process-control computers, General Electric's new 412-M central processor is of digital, binary, fixed-point solid-state circuit construction with a magnetic-core storage of 4,000 words, each of 20 bits. Prewired expansion options allow for additional core and drum memory storage.

Westinghouse and Univac teamed up to produce a new line of digital industrial process-control computers, the Prodac 500 series. Univac makes the control computer and some peripheral equipment; Westinghouse markets the system with additional equipment of its own, and supplies application, installation, and maintenance services.

In the field of analog computers, Electronic Associates announced the availability of a new hybrid digital/analog computer, "Hydac."

For its military market, Librascope presented a

small general-purpose computer, its L2010, made to MIL-E-1600C specifications. In the space-borne computer field, the new computing devices that constitute significant advances are too numerous to recite in detail. The features of major interest are largely new components and techniques, and are discussed under that heading.

### COMPONENTS AND TECHNIQUES

The majority of computing devices manufactured in 1962 contained semiconductor diodes and transistors as active electronic elements. Most of these components were individual elements, typically soldered to an etched circuit board, which plugged into a connector. An increasingly popular arrangement is the "cordwood" approach, in which individual components are stacked together, leads bent and welded in space, and the entire assembly potted to form a functional module. The module is then soldered in place on an etched circuit card or plugged into a connector. Although the unit described is nonrepairable, similar unpotted repairable configurations are being used by some manufacturers in their products.

Reliable resistors and capacitors made by metallic film processes are now available in close tolerances (1-per-cent resistors, 5- to 10-per-cent capacitors) at nominal cost. The trend toward higher performance and better quality control of semiconductor diodes and transistors continued, while prices continued to drop. Some of the better semiconductors now compete in price and make obsolete thousands of earlier lower-performance types. Epitaxial layer growth processes are now widely used and are responsible for much of the improved performance and quality. Passivation of exposed silicon surfaces is also a common technique believed by many to provide adequate protection against contamination of the device. These devices are being marketed in inexpensive small plastic capsules. The addition of hermetic sealing provides superior protection.

Epitaxial layer growth has also been applied to the manufacture of germanium devices. Greater charge mobility and lower forward potential drops in germanium have sustained a demand for high-performance germanium devices in spite of increasing use of silicon. Difficulties of passivating or otherwise protecting germanium against contaminants, plus lower maximum temperature limits compared with silicon, are recognized problems, but not serious ones.

The upper frequency limits of computer logic circuits have been increased through improved semiconductor characteristics and physically smaller components. Available driving power from semiconductor devices has increased; and the stored charge in driven devices and line capacitance have decreased. Where the practical upper frequency limit for current steering diode logic was felt to be a 1-mc pulse rate a year or two ago, this limit now appears

to be 15 to 20 mc, with equivalent margins of performance.

A growing industry-wide interest in integrated circuits was clearly observed in 1962. Objectives and techniques seemed to vary independently of some of the names applied to the techniques. Microcircuits, molecular electronics, made-in-place components, and micrologic devices are some of the terms that have been applied. In some, the object was small in size, even at increased cost. In others, small size was secondary to high reliability and low cost. The trade-offs between costs of various components, logic functions, and complete devices on one hand and the cost of interconnecting them into practical systems on the other have received much attention, but no single significant approach seems to be forthcoming at this time.

Two divergent philosophies have evolved on what should be contained in circuit packages. The first is that packages should contain only like elements, such as all resistors or all diodes. This simplifies manufacturing processes, reduces costs of parts, and reduces the number of types that must be stocked for manufacture and maintenance of computing devices. However, it does create a difficult, if not impossible, interconnection problem for the system designer.

The second philosophy, which really does not exclude concurrent use of the first, is that packages should contain all the elements required to perform single or combined functions, such as an inverter, diode NOR, flip-flop, half or full adder, or other logical building blocks for computing devices. Because of the diverse range of possible applications, there has been much discussion but little agreement on which is best. In 1962 there were indications of increasing interest in the generation of computer programs to analyze this problem.

Techniques for producing integrated circuits have evolved into several classes. The most popular and least expensive is perhaps the formation of both active and passive circuits and their connections on a single silicon chip by diffusion and photoetching techniques. Texas Instruments and Fairchild Semiconductors, among others, have demonstrated devices and subsystems made of them. They have also delivered working samples of devices. They expect to supply production quantities in 1963, and to be competitive with or lower in price than conventional packaged circuits with individual soldered or welded parts by 1964 or 1965. Variations of the diffusion techniques allow the use of distributed rather than discrete circuit elements. Similar connected circuit elements have also been formed using epitaxial layer growth rather than only diffusion techniques. In these processes, the capacitance and resistive (voltage-absorbing) characteristics are derived from back-biased junctions or from controlled conductivity of the silicon. These characteristics are not as linear

That's our P-200 platform on your lower right. In December of 1958, the first P-200 was delivered to Grumman for their E-1B aircraft as the heart of our LN-1A inertial system. The one above is our P-300, about one-half as heavy and not much larger than a football. Despite these reductions, the system provides greater reliability, maintainability, and accuracy. This miniaturized inertial reference platform was developed under an applied research contract with the Flight Control Laboratory of the Aeronautical Systems Division, Air Force Systems Command.

Our advanced systems continue the development of pure inertial navigators and tie astro-trackers and doppler radars to inertial systems for improved long-term accuracy. The

**WILL YOU BE ON THE TEAM  
THAT DEVELOPS THE INERTIAL  
SYSTEMS OF THE FUTURE?**

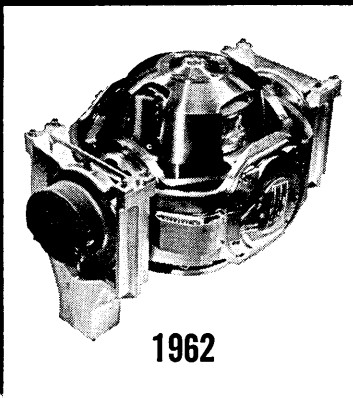

**1962**

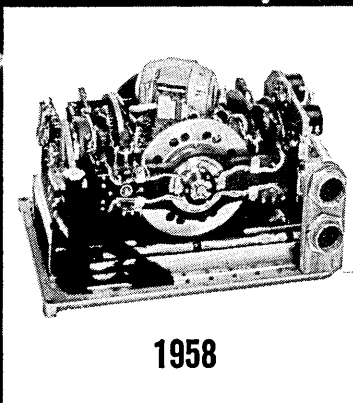

**1958**

projects are long-term, too.

Will you contribute to the inertial-based systems of the future? You will if you're the kind of engineer who gets restless resting on his laurels, who sets new goals after each success. If you know your way around in inertial guidance and/or airborne digital computers and associated electronic equipment, we invite you to investigate Litton Systems. Simply send your name and address for an application form or your résumé for immediate action. Write to Mr. J. B. Lacy, Guidance and Control Systems Division, 5500 Canoga Avenue, Woodland Hills, California. An equal opportunity employer.

**LITTON SYSTEMS, INC.**  
Guidance and Control Systems Division

and stable as those generally provided by conventional separate components.

Higher-quality capacitors, resistors, and connections have been formed by vacuum deposition of various metals and silicon monoxide films, interspersed with suitable masking and photoetching processes. Such elements have generally been deposited on glass, ceramic, or alumina substrates. Active semiconductor elements of planar diffused or epitaxial silicon have been attached in a separate bonding operation. Variations have included electrochemical operations such as the anodizing of tantalum to form the dielectric insulation of capacitors and conductor crossovers. Electroplating and anodic machining have also been reported as useful processes in this work.

Available fabricating tools and techniques for integrated circuits now include vacuum deposition by evaporation and sputtering, and scribing, machining, and welding with electron beams. Methods reported for joining circuits now include ultrasonic bonding, laser welding, conducting adhesives and paints, and thermocompression bonding, in addition to the more conventional soldering and resistance welding processes. Those materials and process most adaptable to automated processing are likely candidates for the manufacture of computing devices in the future.

Further work in micrologic organized systems was reported. In this approach, macro instructions stored in a core memory are operated on by micro programs in a high-speed read-only memory. Timofeev, of the Soviet Union, described such a system and gave specific examples of advantages in speed, simplicity, reliability, flexibility to change, and maintainability.

IBM, RCA, and Sperry Rand, among others, have continued work on kilomegacycle (gigahertz) computers and have achieved logic and memory circuits operating in nanoseconds or tens of nanoseconds. A tunnel-diode full serial binary adder has been constructed by IBM and operated at a 125-mc rate. Experimental tunnel-diode memories and logic have also been shown capable of operating in high levels of ionizing radiation.

Several all-magnetic or predominantly magnetic computers have been built, the latest of which is Burroughs' D-210 magnetic computer. Low power consumption and high reliability under adverse conditions including radiation are expected.

Cryogenic computer elements and additional thin-film cryotron assemblies have been successfully constructed and described. However, the hoped-for kilomegacycle speeds for large switching-tree networks have not been achieved, and there is some evidence that past approaches will not provide switching times much shorter than 1 microsecond.

Cryogenic research has been facilitated by new sources of helium that are not controlled by the government. In most areas, anyone can now obtain liquid helium for approximately \$12 per liter, a

price low enough that the need for small but expensive cryostats or closed-cycle refrigerators to conserve helium appears to be quite limited. Additional basic information has been obtained on the properties of various materials and alloys at cryogenic temperatures and many, such as niobium-tin, are now available to experimenters.

Design automation has been refined as a tool in the manufacture of computers. It now converts logic equations into documented design data in the form of component insertion charts, wire routing tables, and punched cards for direct input to Gardner-Denver automated machines, which wire-wrap the computer connections. Routines for standard performance and diagnostic tests have also been generated through design automation.

K. E. Iverson's new programming language, mentioned under the heading "Machine Languages," also promises to be a useful tool that should indirectly improve design automation. This is a language for rigorous description of computer organization; it will improve communication between designers of computing devices, and it could lead to greater depths of understanding and simplification of future computers.

#### **MACHINE LANGUAGES**

The estimated \$500 million spent in computer programming in the United States in 1962 indicates the importance of effective programming languages and programming aids called "software." The trend toward universal programming languages is now fairly well defined. Algol, Cobol and Fortran are candidates.

In the past, some who claimed to conform to one or more of these universal languages actually did not, but there was no single authority on rigorous definitions of the language nor were there any organized efforts to police its use. In 1962, the ASA took steps to do so in the United States and to coordinate efforts with the ISO (International Standards Organization).

Internationally, agreement was reached by IFIPS (International Federation of Information Processing Societies) to publish Algol 60 (with the 1962 Rome Supplement) as an official IFIPS publication. Agreement was also reached for IFIPS to sponsor a proposal to ISO that this be made an International Standard programming language. The Algol Committee WG 2.1 was asked to prepare an official subset to become part of the standard. This subset would provide a limited version of Algol that is easier for the manufacturers to implement and programmers to use, where the sophistication of the generalized version is not needed. Thus, Algol would have some of the simplicity of some form of Fortran.

Algol software (compilers and translators) was developed by many groups for various computers—for example, the University of Southern Illinois for the IBM 1620, Duke University for the IBM 7070,

Peter Naur for the Gier computer, and Van der Pohl for the Stantec Zebra. Share Algol for the IBM 7090 was tested. Burroughs has produced a considerable amount of software for the B5000, which was designed to use Algol.

Cobol was made available for the IBM 1401, and had already been developed for the 1410, 7070-7074, 705, and 7080 computers. Most manufacturers provided similar software for their products.

For large systems working on large problems or a multiplicity of small ones, software has been prepared to allow programs written in different languages to be processed together. For the IBM 7090 or 7094 computers, IBM prepared such a software system known as the Ijob processor.

The "Iverson language," subject of a new book entitled *A Programming Language* by Kenneth E. Iverson (published by John Wiley & Sons, Inc.), is not a programming language for direct input to a computer and should not be confused with one. It is, however, a very useful language for rigorously and concisely describing the functional organization of computer hardware at several levels of detail. This language and notational scheme offers a vast improvement over block and flow diagrams to describe computing systems in broad detail or subsystem hardware in fine detail.

#### MEMORIES AND PERIPHERAL EQUIPMENT

Advances were made throughout the entire spectrum

of memories. In 1962 production quantities of thin magnetic film memories were delivered for the first time, some as part of data-processing systems. The Univac 1107 and the Burroughs D825 contain such memories. Thin-film memory components ranging from evaporated films on glass to complete memory plans became available from at least three sources: Burroughs, Remington Rand Univac, and Texas Instruments. All three vendors supply word-organized destructive readout (DRO) types. Remington Rand Univac has also offered nondestructive readout and associative-memory types.

Most commercial thin-film memories are now capable of 100- to 200-nanosecond read times, and 300- to 500-nanosecond cycle times (1 nanosecond =  $10^{-9}$  seconds). Early in 1962, International IBM scientists in Zurich demonstrated a 60-nanosecond access time and less than a 100-nanosecond cycle time in an experimental thin-film memory of 256 words, each of 72 bits. Later in the year, Remington Rand Univac demonstrated a cycle time of just over 50 nanoseconds in an experimental thin-film memory.

RCA announced a ferrite-core memory array capable of submicrosecond cycle times of about 300 to 500 nanoseconds. This was accomplished by differential partial flux switching between two ferrite cores having very small inside diameters. Two cores are required per bit. Core planes offered for sale had

## MATHEMATICIANS PROGRAMMERS

We are engaged in the development of an interesting variety of programs for research and real-time operations.

Expansion of our technical staff offers substantial growth opportunities for professional advancement in the areas of mathematical analysis and programming, systems design, and data handling.

Senior positions currently available for mathematicians and physicists in program development and mathematical analysis.

Please send resume in complete confidence to:

**Mr. W. E. Daly.**



MONTEREY LABORATORY

An Equal Opportunity Employer



We are located just two hours from San Francisco on the Monterey Peninsula . . . one of the most desirable living and working areas in the West. Monterey enjoys a temperate, smog-free climate year round and offers an unmatched professional, cultural and recreational environment.

## LFE ELECTRONICS

A DIVISION OF LABORATORY FOR ELECTRONICS, INC.  
305 WEBSTER STREET MONTEREY, CALIFORNIA

# WacoPlate\*

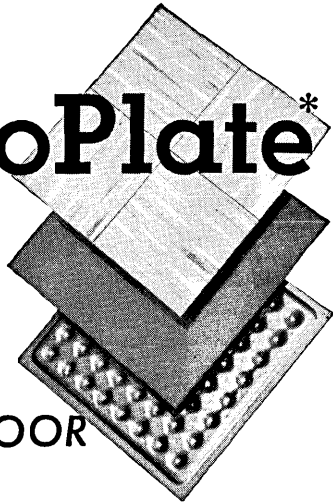

ALL STEEL

CUSTOM FLOOR

AT PRODUCTION LINE COSTS

*\*Patent Applied for*

Washington Aluminum's uniquely designed welded assembly of formed steel sheets results in the finest flooring system created. Initial low cost installations, easy maintenance and interchangeability, combined with the strength of steel, make WacoPlate your ideal flooring choice in your next installation.

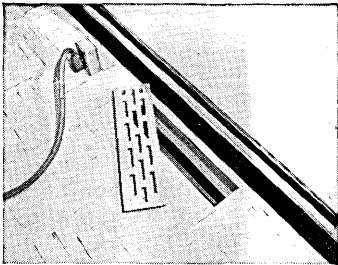

**CUT-OUTS ANYWHERE!**  
WacoPlate's basic panel provides such inherent rigidity, cutouts can be made as desired... now or later! They never affect the load bearing capacity.

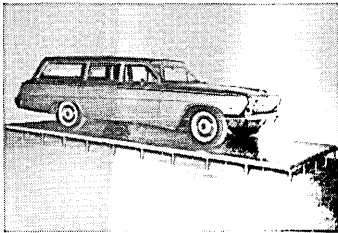

**PERFECT LEVELING**  
WacoPlate's system is guaranteed firm, stable and vibration free; engineered to handle the most sensitive office or electronic equipment.

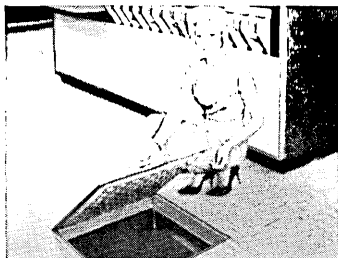

**WACOPLATE FITS ANY DECOR**  
Any contemporary floor covering matched to the precision of steel creates a magnificent floor that is seamless, crackless and flat.

Sweets <sup>13n</sup> Wa Write or call for further information.

**PANEL PRODUCTS DIVISION**

Washington Aluminum Co., Inc.  
Baltimore 29, Md.  
Phone 301 CI2-1000

960 bits per module, arranged as 32 words of 30 bits each. Multiple modules can be connected for more word capacity or greater word lengths.

The trend in coincident current ferrite-core memories has been toward smaller cores and faster cycle times. New improved cores, nominally 0.030 inch in diameter, are now available from RCA, Ampex, EMI, Ferroxcube, and possibly others. These cores are capable of being switched in less than 0.5 microsecond and provide memory cycle times of 2 microseconds or less with drive currents of 400 milliamperes or more. The ferrite memory assembly for Control Data's CDC3600 computer is a significant advance in size and speed. The storage module is 32,768 words of 48 bits each, expandible in 32,768-word modules to a maximum of 262,144 words (over 12 million bits). Memory cycle time is 1.5 microseconds, but with overlapping core banks the effective cycle time will be 0.7 microsecond. As many as six modules operate simultaneously at peak rates, completely asynchronously. IBM built a 1,024 72-bit core memory which achieved a 0.6-microsecond cycle time, and is now building an experimental 16,384 72-bit word memory with the same techniques.

This has been a year for introspection of the future of cryogenic memories. The hoped-for kilomegacycle speeds for very large memory systems have not been achieved in spite of extensive research and development effort. The *L/R* time constants associated with the large tree-switching networks, which address the memory elements, are presumed to be the 1-mc barrier.

Low-cost glass acoustic delay lines with low temperature coefficient and large storage capacity were offered by Corning Glass Company. Samples capable of bit rates of 10 to 25 mc with storage of several thousand bits have been delivered for evaluation. General Electric produced a 2,000-bit wire-sonic delay line memory for use in high vibrational environments.

Bendix has demonstrated an optical drum memory for storage of permanent and unalterable data. Binary data is recorded on a rotating glass drum by photographic means, developed, and read back by photosensing heads. The unit has 256 tracks, 4,096 bits per track, and readout rates of 1 mc.

The trend toward large-capacity disk files for random access memories continued. IBM's 1301 disk file was displayed late in 1961 with first deliveries in 1962. Data Products' dp/f-5020 Discfile was new in 1962. It offers capacities up to 155,500,000 bits per file unit in modules which have as many as 16 disks per module, and one head positioner per disk. Data access time is 225 milliseconds.

IBM's new 1440 small business computer contains a small disk file memory in which interchangeable packs of 14-inch disks are placed in a unit that resembles a phonograph record changer. Access time

to data on any disk in an active pack is reported to be less than 1/2 second.

In spite of the trend to disks, magnetic tape is still the predominant low-cost-per-bit storage medium. IBM's 705 tape format has become the accepted basis of interchangeability of tapes, even between those made on equipment manufactured by other companies. In the meantime, IBM has introduced another format, called "Hypertape," with wider tape, higher bit density, and automatic cartridge loading. Up to 340,000 numeric characters are read per second. To balance the trend toward higher sophistication and cost, other efforts were reported by RCA toward very-low-cost low-performance cartridge-loading tape.

Magnavox's Magnecard and National Cash Register's Cram are finding additional applications. These provide storage and retrieval of data on cards with magnetic recording surfaces.

In optical character recognition, IBM introduced its 1428 alphameric optical reader. This reads typed or printed numeric and alphabetic characters on documents for direct input into an IBM 1401 for processing. Speed is 480 characters per second from as many as 400 documents per minute. Readable type fonts include the IBM 1403 printer and a particular size of IBM electric typewriter.

Remington Rand Univac acquired National Data Processing and will probably use NDP products, which include numeric OCR and MICR readers. Remington Rand Univac is using Farrington's alphanumeric page readers in some new system applications.

Magnetic Ink Character Recognition (MICR) with the E-13-B font, now well established in banking in the United States, was adopted during 1962 as a standard in Canada, Australia, and Great Britain. Analex Corporation has demonstrated a high-speed printer for E-13-B characters.

Other peripheral equipment that shows definite growth includes data-transmission units. Over 3,000 Dataphones were installed in 1962, principally for reproducing punched cards at a remote point. A few on-line installations were reported.

#### JOINT ACTIVITIES AND STANDARDS

The scope of interests in the AIEE Computing Devices Committee is already interlaced with many other technical groups. Merger of the AIEE and IRE is already causing groups with like interests to become aware of each other's activities. This should do much to promote joint efforts, realign objectives, and induce mergers.

Some standards activities have already been re-oriented in view of the newly formed AFIPS and IFIPS. Programming-language standards activities have been mentioned. Proposals for standard data codes for exchange media, and fonts for magnetic ink and optical character recognition in the United

## WILEY BOOKS

### Macon: **NUMERICAL ANALYSIS**

This book is an introduction to numerical analysis (as opposed to numerical methods) emphasizing applicability to high speed computing. 1963. Approx. 176 pages. Prob. \$5.50.

### Sherman: **PROGRAMMING AND CODING DIGITAL COMPUTERS**

Here is a book which treats in detail digital computer programming. It emphasizes the analysis of problems before they are put to the computer for solution, deals with the details of coding and discusses special languages for computers. 1963. 444 pages. \$11.00.

### Tomkins-Messick (Eds.): **COMPUTER SIMULATION OF PERSONALITY: Frontier of Psychological Theory**

Proceedings of a conference which will serve as an introduction to computer simulation in the study of personality as well as a valuable survey of recent accomplishments in the field. 1963. 325 pages. \$5.00.

### McCracken: **A GUIDE TO ALGOL PROGRAMMING**

This is an easy-to-understand introduction to the programming language of ALGOL, and it also presents the idea of an algorithm — how one goes about transforming a problem statement into a problem solving procedure acceptable to the computer. 1962. 106 pages. \$3.95.

### Hoffmann (Ed.): **DIGITAL INFORMATION PROCESSORS, SELECTED ARTICLES ON PROBLEMS OF INFORMATION PROCESSING**

Deals with digital information processors in connection with the information machine and presents recent contributions to the field. An Interscience Book. 1962. 740 pages. \$27.00.

### Smith-Johnson: **FORTRAN AUTOTESTER**

For the non-specialist, this is a quick, handy, and complete text which will enable him to program his own problems for the modern electronic digital computer. 1962. 176 pages. Paperbound. \$2.95.

### Vajda: **READINGS IN MATHEMATICAL PROGRAMMING, 2nd Edn.**

This is an expanded edition of the author's *Readings in Linear Programming* covering the more recent developments of the subject. 1962. 130 pages. \$4.25.

### MacKay-Fisher: **ANALOGUE COMPUTING AT ULTRA-HIGH SPEED: An Experimental and Theoretical Study**

This is the first book in English devoted wholly to repetitive analyzers. It presents new possibilities and shows the versatility and latent potential in analogue technique. 1962. 410 pages. \$11.50.

### Hartley: **AN INTRODUCTION TO ELECTRONIC ANALOGUE COMPUTERS**

A Methuen Monograph on Physical Subjects. 1962. 155 pages. \$4.50.

### Ware: **DIGITAL COMPUTER TECHNOLOGY AND DESIGN, Vols. I and II**

Vol. I: Mathematical Topics, Principles of Operation, and Programming. 1963. Approx. 328 pages. \$7.95. Vol. II: Circuits and Machine Design. 1963. Approx. 328 pages. Prob. \$7.95.

*send now for on-approval copies*

**John Wiley & Sons, Inc.**

605 THIRD AVENUE

NEW YORK 16, N. Y.



**SAVE TIME...  
SAVE SPACE...  
with new DRAKE**

**Bi-Pin Cartridge ★ Lamps ★  
Lampholders ★ Assemblies**

A whole new line—designed especially to *slice direct cost and assembly time alike*—gives you unusually wide choice of 5 neon, 5 incandescent lamp varieties—4 useful filter styles in 5 colors.

All fit in any Bi-Pin Lampholders, as well as in two special aluminum body DRAKE styles, which feature small size, sturdy construction, insulated contacts, various optional built-in resistors for neon. Replacement? The easiest!

**EXCLUSIVE: Indexed Readout Filters**  
—1 to 3 letters or figures—always position upright—saves expensive assembly time because body is keyed to hole. And—The *only* neon types you can get with flush or short cylindrical filters!

★ SEND FOR ILLUSTRATED 4-PAGE FOLDER WITH FULL DATA ON ALL VARIETIES



**DRAKE**

**MINIATURE  
LIGHTING  
SPECIALISTS**

4624 N. OLCOTT AVENUE • CHICAGO 31, ILLINOIS

States were spurred by international interest and activity in generating and adopting international standards.

After two years of negotiation an American Standard for logic diagramming symbols has finally been approved. This standard promises to reduce the hundreds of sets of symbols presently used down to two—a uniform and a nonuniform set.

Other activities of a standards nature affecting those engaged in the computing-device business include the National Fire Protection Association's work on a standard for the protection of electronic computer systems. The outgrowth of this work may impose new requirements on the design and manufacture of such equipment.

**SYSTEMS, COMPLEXES, AND APPLICATIONS**

Only a few highlights can be enumerated in the space of this article. The increasing availability of broadband microwave transmission, particularly with the long distances now afforded by Telstar, have brought high-speed world-wide data systems into the realm of technical feasibility.

Using lower-speed communications circuits, but not excluding the possibility of using Telstar circuits, a world-wide electronic reservations and communications network called Panamac is being installed by IBM for Pan American World Airways in New

York City. Linking 114 cities in six continents, the system not only books space in seconds, but handles countless other accounting and computing chores. Based upon two IBM 7080s, the new system replaces an IBM 705, which six years ago was the first installation in the air transportation industry.

In October, the output of a Burroughs D825 computer appeared on an S203 electrostatic printer in Detroit via Telstar. Similar demonstrations and tests for transmission characteristics were conducted by Honeywell, Remington Rand Univac, and National Cash Register. Costs per bit were not mentioned, but it would be interesting to know how they compare with reels of magnetic tape, for example, sent one reel at a time by personal courier in a jet airplane.

At the other end of the spectrum, much interest and potential business is developing for small data systems and control computers. Friden, Datex, RCA, IBM, and others have designed and applied data-collecting units for such purposes as personnel time-keeping (time cards), job time or operation cards, quality-control measurements, stockroom transactions and inventory, retail point-of-sale transactions, and so on. The trend is toward on-line processing of gathered data, and shortening the time for necessary action to be initiated.

Process-control computers in operation over several years have demonstrated feasibility and reliability. Among new installations in 1962, Leeds & Northrup delivered an LN 3000 computer system to the Niagara Power Project. The computer's function will be to utilize but not exceed the water allotted by International Treaty for diversion from the Falls. It will determine the number of generators and/or pumps required and loads for each, and will log over 500 hydraulic and electrical variables.

Applying process-control principles to automobile traffic, the city of Toronto has embarked upon a project to ease traffic jams through computer control of lights at 500 intersections.

To do justice to the subject, a separate article should be written on the many new, interesting applications of computers. However, it seems appropriate to mention at least one more here. *The Los Angeles Times* has just installed an RCA 301 computer to perform a newspaper editing function. Starting with text supplied directly from reporters, it separates text into lines, inserts, justifies, breaks long words in appropriate places for hyphenating, and merges editorial corrections. The output is then in the form of paper tape for direct input into typesetting machines.

The Computing Devices Committee is now eagerly anticipating the very real possibility of having a computer on a future Ad Hoc Committee for preparing the annual technical paper on computer progress.



## READERS' AND EDITOR'S FORUM

(Continued from Page 10).

several hundred guests by EAI's new digital-analog hybrid computer, HYDAC. As a result of winning, he could select the university to which the computer was to be given. His choice was his alma mater, University of California at Berkeley, from which he graduated with a BSEE in 1958.

Each guest as he arrived received an identification badge with a number on it. All the numbers were programmed into the HYDAC and displayed, in rapid succession, on the readout panel of a digital voltmeter. At a certain moment, one of the guests was asked to stop HYDAC. The last number that the computer contained as it stopped was declared the winning number.

### PLACE OF INDIVIDUAL IN AUTOMATION SUBJECT FOR ESSAY CONTEST

"Preserving the Individual in an Age of Automation" is the subject of a \$5,000 essay contest sponsored by the Connecticut Mutual Life Insurance Company, Hartford.

Purpose of the contest, said Charles J. Zimmerman, company president, is to evoke serious thought on how to make the most of benefits derived from automation, and how to solve problems arising from its increasing use in American business.

"We are looking for ideas rather than writing skill," Mr. Zimmerman states. "There are many strong opinions on automation, but few conclusions. How, for instance, can we best meet the challenge of automation without destroying individual dignity and individual opportunity in business and society?"

Mr. Zimmerman said his company based the contest on the assumption that automation, for good or bad, is not here to stay, but to grow.

First prize is \$2,500; second prize, \$1,000. Three additional prizes of \$500 each will also be awarded. A copy of contest rules may be obtained by writing to Human Relations Program, Connecticut Mutual Life Insurance Company, 140 Garden Street, Hartford 15, Conn. Deadline for entries is June 30, 1963. Winners will be announced on or before Oct. 15, 1963.

### TWO NEW COMPUTER FILMS AVAILABLE

Computer people teaching courses in the design and applications of Analog computers, or tackling the less difficult job of interesting young people in the computer field, will be pleased to learn that two new motion pictures are available to ease communication.

One is called "An Introduction to Analog Computers." It is a lecture film by L. C. Just of the Applied Mathematics Division of the Argonne National Laboratory. The film covers the fundamentals of a typical analog computer, analog computer components, programming, and the solution of typical problems. It is a 16 mm color film with sound. The film is designed for classroom presentation, and consists of three sections, each approximately 40 minutes long.

The film is available for loan without charge for public use upon request to: Film Center, Technical Publications Department, Argonne National Laboratory, 9700 South Cass Avenue, Argonne, Illinois.

The other is a 16 minute, 16 mm color film from the University of Southern California called "Careers in Business Data Processing."

## PRINT AS YOU PUNCH



### NEW NAVCOR ALPHANUMERIC TAPEWRITER

prints on the margin of the tape as it punches the holes . . . permits legible confirmation of source document at a glance. Low cost, completely self-contained unit combines advanced features to speed and simplify tape preparation for all applications.

★ **Simplified Electronic Keyboard**—magnetic key detent ensures light, positive keyboard action. ★ **Full Alphanumeric Keyboard**—standard typewriter plus adding machine format. ★ **Electronic Coding & Timing**—minimizes maintenance costs, extends service life. ★ **Optional Characters and Codes**—available at low cost. ★ **Adaptable to Portable Operation—Automatic Tape Duplication**. See the NAVCOR Tapewriter in action at the Detroit Spring Joint Computer Conference. ★ **Visit NAVCOR at Booth 125.**

**NAVCOR** NAVIGATION COMPUTER CORPORATION  
932 Rittenhouse Road • Valley Forge Industrial Park  
NORRISTOWN, PENNSYLVANIA • GLENDALVE 2-6531

This film discusses the basic elements of the computer. It emphasizes the importance to young people of understanding data-processing systems and related equipment.

The film is primarily designed to help colleges and universities attract students to enter the computer field. Although produced in a junior college setting, it should also be useful to high schools, civic and service organizations, and industrial groups.

For further information about this film write to: Film Distribution Department of Cinema, USC, University Park, Los Angeles 7, Calif.

**We will be happy to send**

**a complimentary copy of**

**COMPUTERS & AUTOMATION**

**in your name**

**to a friend who might find the  
information in it stimulating  
and useful to him.**

**Just send his name and address to:**

**V. C. Nelson, Computers & Automation,**

**815 Washington Street, Newtonville 60, Mass.**

**He'll appreciate your thoughtfulness!**

# "ACROSS THE EDITOR'S DESK"

## Computing and Data Processing Newsletter

### TABLE OF CONTENTS

New Applications . . . . .	42	Education News . . . . .	49
New Contracts . . . . .	43	New Products. . . . .	50
New Installations . . . . .	45	People of Note . . . . .	55
Organization News . . . . .	47	Business News . . . . .	56
Computing Centers . . . . .	48	Monthly Computer Census . . . . .	58

### NEW APPLICATIONS

#### COMPUTER CALCULATES RESULTS OF NATIONAL SKI CHAMPIONSHIPS

The results and up-to-the-minute standings of the racers participating in the National Alpine Ski Championships and Olympic Tryouts in Mt. Alyeska, Alaska, were calculated by a computer in a ski lodge in the snowy Chugach Mountains. The three-day sports program was the final test in the selection of the U.S. Olympic Team for the Winter Games at Innsbruck, Austria, next January.

Electronic data processing, in the form of an IBM 1620 computer, was used for the first time in the history of the U.S. championships. The computer provided participants, officials, press, and spectators with the standings of all competitors in the races, minute by minute.

The computer scored each skier according to the point system established by the International Ski Federation (ISF) and printed the cumulative overall standings at the end of each event.

The start and finish times of each racer, taken from a tape prepared at the finish gate by an electronic timer, were read over a telephone line to the computer center at the Lodge. The data was punched into previously prepared start and finish cards and fed to the computer which calculated elapsed time. As each racer finished his run, the name, race number and standing were printed out and a current list of the top five racers was prepared.

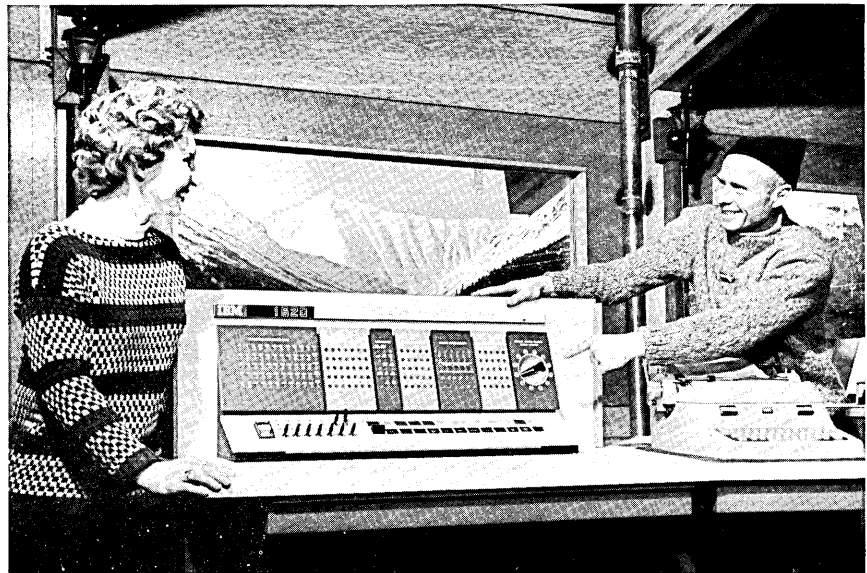

-- Don Flynn, chief of courses for the downhill and giant slalom races of the National Alpine Ski Championships and Olympic Tryouts, examines the IBM 1620 computer. Looking on is local skier Georgia Pitzer.

#### FINGERPRINT SEARCHING WITH EDP

Police Commissioner Michael J. Murphy of New York City has disclosed the development by the Police Department of an important advance in fingerprint processing and search, by the use of electronic data processing methods. Through this means, the search of fingerprints on file will be reduced from hours to minutes. At least

one hundred sets of fingerprints can now be searched simultaneously, whereas in the past only one man could look up one set at a time.

At the present time, the Police Department has the fingerprints of about four million persons on file. Last year the fingerprints of 286,000 persons were received and looked up by

the Bureau of Criminal Identification. In the past four years, the number of fingerprint charts received has risen 60 per cent.

Until now fingerprints found at the scene of a crime could only be matched against the fingerprints of a selected number of persons known for habitually committing a certain crime. Under the electronic data processing system, however, fingerprints may be matched in about three hours against those of 100,000 selected repeaters previously coded and stored in the computer's memory -- or if necessary, may be matched in a longer time against those of the entire four million persons in the file.

The new method of fingerprint search will be put into operation using an IBM 1401 computer system in the Statistical and Records Bureau of the Police Department.

## **WALL STREET JOURNAL TO TRANSMIT NEWS ELECTRONICALLY**

The Wall Street Journal will transmit news copy over telephone lines simultaneously to seven printing plants at a rate of nearly a column a minute. In theory at least, the entire contents of any day's newspaper could be transmitted in about 90 minutes. The system being used is a Dial-o-verter system made by Digitronics Corp., Albertson, N.Y.

The transmitting system is fifteen times as fast as the teleprinter equipment previously used, and operates at a speed of 1000 words per minute. The network uses eight Dial-o-verter D507 terminals, for simultaneous transmission to plants at Chicopee Falls (Mass.), New York, Cleveland, Chicago, Dallas, San Francisco, and the soon-to-be-completed White Oak (Md.) facility.

## **COMPUTER ANALYSIS OF BRAIN WAVE RESPONSES**

A program has been developed by Drs. Burton Rosner and William Goff of Yale University School of Medicine and West Haven Veterans Administration Hospital, which permits computer analysis of brain wave responses. This application was demonstrated on a PDP-4 computer made by Digital Equipment Corporation, Maynard, Mass.

Researchers can observe averaged brain-wave signal responses, displayed on the screen of the computer's cathode ray tube. A stimulus, such as a small electric shock, a visible light flash, or an audible click, is applied repeatedly to the subject. The resulting brain wave responses are fed into the computer, which adds each succeeding response to the total of all previous responses.

If an individual brain-wave response recorded from the scalp is so weak it cannot ordinarily be separated from extraneous signals, the computer can be controlled to add up several succeeding brain-wave responses to make a strong signal whose characteristics can be readily observed.

In addition, a "light pen" can pick-out parts of the signal when more detailed information is desired. By pointing the light pen at a part of the signal, the characteristics of that part can be displayed in detail on the CRT screen, or printed out.

## **SIMULATION AND CONTROL OF A CHEMICAL PROCESS WITH ANALOG COMPUTER TECHNIQUES**

A recent demonstration by Electronic Associates, Inc., Long Branch, N.J., showed the simulation and control of a continuous-flow stirred-tank reactor, under certain stated conditions, by the use of analog computer techniques. The prediction and control of the operation of the reactor was shown using a TR-48 analog computer to simulate the process, and a PC-12 multi-purpose analog computer to control the process.

In the process two dissimilar materials react with each other to form a third material. The TR-48 simulates the operation of the chemical reactor, the cooling-water jacket, the analyzer sampling system and two controllers. The function of the PC-12 is to measure one of the two inputs to the reactor (one input is a controlled flow, the other is uncontrolled). The PC-12 will also measure the size of the disturbance within the reactor, predict what deviations from the required norm will occur in the composition of the output, and determine the corrective action to be taken to bring the output back to normal.

## **BIOLOGICAL SCIENCES & THE COMPUTER**

The Massachusetts General Hospital (MGH), Boston, Mass., established a Research Center for Mathematics in Medicine in 1961. During the early months of the Center's operation, it became clear that a small high-speed digital computer would be an asset. A PDP-4 computer, of Digital Equipment Corporation, Maynard, Mass., has been acquired for purely research purposes. The configuration used at MGH consists of an operator console, paper-tape reader, paper-tape punch, cathode-ray display tube with a light pen, keyboard, printer unit, and four channels for analog data input.

A major application of the computer will be the analysis of electro-physiological responses. The computer can process the response so quickly that the experimenter can actually see the results of his experiment as he is performing it.

Other applications will be calculating dosage distributions in radiation therapy, remote on-line processing of data during radio-isotope brain scans, and calculation of bone crystal structures.

---

## **NEW CONTRACTS**

---

### **CONTRACT TO DEVELOP THIN-FILM SPACECRAFT MEMORY AWARDED UNIVAC**

NASA-Goddard Space Flight Center, Greenbelt, Md., has awarded a cost-plus-incentive-fee contract to the UNIVAC Division, Sperry Rand Corp., Philadelphia, Pa., for the development of a reliable low-power thin-film memory for space craft.

The objective of the one-year contract is the development of a 100,000 bit memory with a total power requirement of 133 milliwatts. A new magnetic thin-film plated-wire memory element, developed at UNIVAC, will be used for this application. NASA's immediate plans call for use of the memory in the Orbiting Astronomical Observatory.

## Newsletter

### LEEDS & NORTHRUP RECEIVE CONTRACT FROM AMERICAN ELECTRIC POWER

Leeds & Northrup Company, Philadelphia, Pa., has received a contract from American Electric Power System for an analog-computer control system and digital telemetering equipment. The equipment will be part of an automatic load-frequency control-and-economic-dispatch system to be incorporated into the electric utility industry's large-scale computer and operating center, to be installed in Canton, Ohio. The Canton operating center, including necessary microwave extensions to the AEP's seven state electric power network, is scheduled for completion in late 1964.

### COMPUTER SYSTEMS FOR SATURN MISSILE PROJECT

Douglas Aircraft Co., Santa Monica, Calif., has purchased five 924-A Computer Systems from Control Data Corp., Minneapolis 20, Minn. These will be used in the Saturn Vehicle project at Cape Canaveral, Fla., and Sacramento and Huntington, Calif. The contract is in excess of \$1,600,000

The first system was delivered last month. The CD 924-A computer systems will be used in the checkout of the S-IVB. It will control the hot-firing tests to be conducted at Sacramento. The system includes a computer interface buffer to handle information received from and sent to the vehicle by the computer.

The object of the Saturn Vehicle Project is to provide a large space carrier for both manned and unmanned space flights, to achieve a landing on the moon by 1970. Douglas Aircraft Company is prime contractor to the National Aeronautics and Space Administration (NASA) for the development of the Saturn S-IV and S-IVB upper stages of the giant Saturn vehicle.

### NASA CONTRACT TO DATATROL FOR REAL TIME SYSTEM ON SDS 920

Datatrol Corporation, Silver Spring, Md., has been awarded a \$34,500 contract by the National Aeronautics and Space Administration to design and implement a real time system for the SDS 920 computer. The system will be able to make a "quick look" analysis in real time on telemetry

signals received from the Orbiting Geophysical Observatory series of satellites.

### LEACH WINS APOLLO CONTRACT FOR LUNAR-TYPE TAPE RECORDER

The Leach Corporation, Compton, Calif., has won a contract (approximately \$2 million) to develop lunar-flight tape recorders for Collins Radio Company, Cedar Rapids, Iowa. The recorders will enable U.S. Project Apollo astronauts to record important research data. They will be used aboard the three-man Apollo command module which is to orbit the moon.

The recorders will have half the weight and twice the capacity of recorders now available, and will operate on about one-third the power. Less than 20 watts of power will be drawn from the power system. They will be able to collect and store data for five hours, and the data can then be transmitted to the earth over telemetry links when they are available. The astronauts will be able to change tape reels easily in flight.

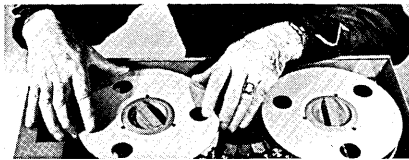

-- Lunar-type tape recorder under laboratory test at the Leach Controls Division, Azusa, Calif.

### DATA DISPLAY SYSTEM CONTRACT AWARDED BY PHILCO

Kollsman Instrument Corp., Elmhurst, N.Y., has been awarded a contract by the Philco Communications and Electronics Division, Fort Washington, Pa., for the production of five electronic visual display systems. The Kollsman systems will be a major part of an Automatic Data Processing and Display System being built for use by the Alaskan Air Command of the North American Air Defense network.

Each system will contain plotting and background projectors, an electronics support console, and a digital and analog control console. Additionally, one of the systems will include a manual graphics inserter and a character generator for feeding alpha-

numeric symbols and other data into the fully automatic system.

### SPERRY ORDERS TWO NUCLEAR SUB TRAINING SYSTEMS

Packard Bell Electronics, Computer Division, Los Angeles, Calif., has received a contract from the Sperry Division of Sperry Rand Corporation, in excess of \$500,000, for the third and fourth Computer-Interface Systems, to help train nuclear submarine crews. Packard Bell has already delivered two similar systems.

Each Computer-Interface System simulates several Ships Inertial Navigation Systems (SINS), a stabilization data computer, a Loran C radio navigation system and various manual inputs. The systems operate in conjunction with a NAVDAC Navigational Computer to create a realistic simulation of the actual conditions under which crews navigate and maintain nuclear submarines and aim and fire Polaris missiles.

The Packard Bell system is designed around a PB250 digital computer. Other equipment includes analog-to-digital and digital-to-analog converters, multiplexers, buffers and a number of special purpose data units.

### AIR FORCE CONTRACT TO LFE

The U.S. Air Force has awarded a contract for research in thin ferro magnetic films to LFE Electronics, division of Laboratory For Electronics, Inc., Boston, Mass. The contract, for the Air Force Cambridge Research Laboratories, (AFCLRL), Bedford, Mass., calls for the continuation of theoretical and experimental investigation and development of compact, inexpensive new computer devices able to store and process large amounts of digital information. LFE Electronics is conducting a related program for the Office of Naval Research (ONR).

### CONTRACT AWARDED HRB-SINGER, INC.

The Office of Emergency Planning, Executive Office of the President, has awarded a contract to HRB-Singer, Inc., State College, Pa., which will lead to the development of an electronic data processing system designed to improve the federal government's

radio frequency assignment methods. The program calls for the company to develop EDP techniques and systems which will facilitate the selection of frequencies and improve existing data processing, record-keeping, and output procedures. The new project will be carried on in the Methodology Section of the Operations Department at HRB-Singer.

### DISPLAY SYSTEM CONTRACT AWARDED TO HAZELTINE

Hazeltine Corporation, Little Neck, N.Y., has received a contract from the United States Navy to design and produce prototype models of the display portion, including consoles, for the Small Ship Combat Data System (SSCDS).

SSCDS will be primarily concerned with anti-submarine warfare (ASW) requirements and will also have an aircraft control capability. The display portion of the system will accept both radar and computer-processed sonar information. It is being developed particularly for destroyer classes of ships.

### CONTRACT TO RADIATION INC.

Radiation Incorporated, Melbourne, Fla., has received a \$382,000 contract from McDonnell Aircraft Corp., St. Louis, Mo., for the design, development and testing of a digital data processing system for Project Gemini. The system will be divided into a digital section and an analog section. The digital equipment will be capable of converting Pulse Code Modulation data to digital form on magnetic tape for input into a digital computer. The analog equipment will convert the same Pulse Code Modulation data into analog form to be used in graph charts and other visual displays.

### NEW INSTALLATIONS

#### COMPUTER TO EXPEDITE MAILING OF TEN MILLION MAGAZINES MONTHLY

Merkle Press Inc., Washington, D.C., one of the largest commercial printing firms in the United States, is installing an RCA 301 computer system, which

will improve its mailing of more than 10 million copies of publications monthly. More than 60 national and international publications are printed and mailed by Merkle Press including Time Magazine and Sports Illustrated (Southeast distributions), labor and trade periodicals.

The RCA 301 system will permit close-out of address changes within hours of actual mailing, instead of weeks. This will mean thousands of dollars of saving to clients in the unnecessary printing of undeliverable magazines and returned copies from the Post Office. The system also will permit instant geographic analyses and expedited selective mailings. To further expedite customer service, an A. B. Dick Videograph high-speed label printer is being added.

The RCA 301 will also provide a computerized accounting system. Later, the computer will be linked to RCA Electronic Data Gathering Equipment (EDGE) units, placed at various points in the firm's production area. The EDGE system, linked directly to the computer, can report on the status of a job order, the specific location of a job in production process, adherence to quality control standards, completion of assignments, machine workloads and manpower requirements, inspection reports, and payroll data.

#### HONEYWELL 400 MAGNETIC TAPE SYSTEM INSTALLED IN BEECH AIRCRAFT CORP.

Beech Aircraft Corp., Wichita, Kansas, has installed a Honeywell 400 magnetic tape system. The company's goal is to establish within the next two years an integrated, computer-oriented manufacturing control system encompassing all major phases of production of its 10 business airplane models.

#### NAVY SELECTS UNIVAC III FOR SHIPYARD MANAGEMENT SYSTEM

The Navy's Bureau of Ships is developing a Management Information System for its naval shipyards. A UNIVAC III model is being used for a pilot development and installation. The Bureau of Ships is working jointly with seven naval shipyards to perfect a standard computerized management system and will install it first in the Boston Naval Shipyard. After being proved out at

Boston, the new system is expected to be applied in 1964 to naval shipyards at Portsmouth, N.H.; Philadelphia, Pa.; Portsmouth, Va.; Long Beach, San Francisco, Mare Island, and Vallejo, all in California.

#### BOWERY SAVINGS BANK HAS NEW UNIVAC 490 REAL-TIME COMPUTER

Recently the Bowery Savings Bank, New York, N.Y., began using a new Univac 490 Real-Time computer. The 490 will be used to process all "back office" accounting and record-keeping on depositors' accounts and mortgage holdings. In 1964, the computer will pass into full "on line" operation, after delivery of custom-designed Sperry Rand "Unisaver" teller units.

#### FARMERS MUTUAL REINSURANCE CO. ORDERS UNIVAC SOLID-STATE II

A UNIVAC Solid-State II 90 Computer is scheduled for installation in September at the Farmers Mutual Reinsurance Company, Grinnell, Iowa. The computer will be used for processing accounts receivable, payroll, income and disbursement analyses, statistical reports, and reinsurance cessions. The system will include a central processor (with drum storage capacity of 2600 words and magnetic core storage of 1280 words); a Synchronizer; five Uniservo Magnetic Tape Units; a High-Speed Card Reader; and a High-Speed Printer.

#### UNIV. OF WISCONSIN INSTALLS CONTROL DATA 160-A

A Control Data 160-A computer has been delivered to the Department of Psychology of the University of Wisconsin, Madison, Wisc. The computer will be used: for on-line experiments in delayed sensory perception with human subjects; as a controlled delay system to study effects on learning and behavior with visual and auditory inputs such as handwriting and speech; and in other psychological experiments. This may be the first time that a digital computer will be used for real-time sensory-feedback analyses in behavioral and environmental research.

The University of Wisconsin presently has one of the largest computer installations of any University, with a large-scale Control Data 1604 as the central computer.

## Newsletter

### SANDIA SPEEDS UP NUCLEAR WEAPON DESIGN DATA HANDLING

The installation of six OSCARS (semi-automatic oscillogram record readers) at Sandia Corporation laboratories, Albuquerque, N.M. and Livermore, Calif., have cut in half the time required to provide design and manufacturing groups with highly accurate data.

The OSCARS, manufactured by Benson-Lehner Corp., Van Nuys, Calif., read data from oscillograms made during performance tests of new materials to enable immediate correction of design deficiencies.



The employees in the picture above demonstrate how the system reads data from oscillograms, reports it on a light bank, types it on an electric typewriter, and punches it into IBM cards which are analyzed on a 7090 computer. Sandia Corporation is engaged in research and development on ordnance phases of nuclear weapon design.

### NEW JERSEY BELL TELEPHONE CO. INSTALLS RCA COMPUTERS

The New Jersey Bell Telephone Company has established a computer "central" equipped with the new RCA 601 electronic data processing system. Four RCA 301 computers complete the center in Teaneck, N.J. The system is being used to keep track of 14 million toll calls placed each month in the northern half of New Jersey. On the average, 35,000 bills are processed daily. The computers turn out the finished bill to be mailed to the individual customer and maintain a master file for each account. The New Jersey Bell system involves 15 separate billing dates every month.

The system includes 17 magnetic tape stations for storing pertinent data on each of more than one million telephones. Bill-

ing data, in less detail, now is stored on punched cards requiring warehouse-size quarters for storage and handling.

### BOISE, IDAHO, TO INSTALL TRAFFIC CONTROL SYSTEM

The city of Boise, Idaho, has purchased a PR (Pro Rata) Traffic Control System from the Automatic Signal Division, Laboratory For Electronics, Inc., Norwalk, Conn. This electronic traffic control system is able to automatically detect, analyze and regulate all vehicles moving through a grid of 25 downtown intersections. Overhead radar detectors will continuously transmit traffic volume and density information to the PR Traffic Control System Master Computer located in City Hall. The computer, after analyzing the information, will send commands to local intersection controllers indicating which streets should be given the largest amount of green light to permit the greatest number of vehicles to pass in the shortest time.

The system includes two Emergency Fire Apparatus Pre-emptors (operable from Fire Headquarters) to clear a right-of-way through the PR System area for the passage of fire fighting apparatus.

### DELIVERY OF FIRST UNIVAC 1107 TO A FOREIGN CUSTOMER

Delivery of the first UNIVAC 1107 Thin-Film Memory computer to a foreign customer has been announced by UNIVAC Division of Sperry Rand Corp., New York, N.Y. The 1107 system, valued at more than \$2½ million, was purchased by an agency of the West German government for a classified application.

The first St. Paul-produced UNIVAC 1107 computing system was placed in operation by Computer Sciences Corporation, Los Angeles, Calif. (Computers and Automation, January, 1963). Another 1107 will be delivered to the Ministry of Culture at Baden-Wurttemberg, Stuttgart, Germany, this summer (Computers and Automation, March, 1963).

### TRUCKING FIRM TO INSTALL IBM 1440

A trucking firm will receive a new IBM 1440 data processing

system. Great Lakes Express, Saginaw, Mich., has purchased the 1440 system, and will receive delivery sometime later this year.

Weekly terminal operating summaries, and monthly terminal profit and loss statements for all of GLX's 18 terminals, are two of the jobs which will be undertaken with the new system.

### FOURTH EDP SYSTEM FOR THE FIRST FEDERAL SAVINGS, DETROIT

The First Federal Savings, Detroit, Mich., has ordered a new electronic data processing system -- its fourth in seven years. A General Electric 225 computer system, which uses magnetic tapes as the information storage medium, is scheduled for installation in the fall of 1964. The new system will do away with the need for 6 million punch cards annually on which data is now stored.

The GE-225 computer system can store the same amount of information now carried on 200,000 punch cards on a 10½ inch reel of magnetic tape. Under normal conditions this reel can be processed in 10 minutes. The cards it will replace require up to six hours for processing.

The First Federal's decision to go to a magnetic tape computer system could have an influence on the course of automation in the savings and loan industry. The Detroit association, seventh largest in the nation, was a pioneer in the use of electronic data processing equipment and its decisions in the area of electronic bookkeeping are highly regarded.

### UNIVAC 1004 CARD PROCESSOR, OPTICAL SCANNING PUNCH, INSTALLED IN THE CHRONICLE PUBLISHING CO.

A UNIVAC 1004 Card Processor with an Optical Scanning Punch has been installed in the business office of The Chronicle Publishing Company, San Francisco, Calif. The new system will be used for accounting and customer service functions by The San Francisco Chronicle and television station KRON-TV.

**OLIVETTI ELEA 6001 INSTALLED AT INTERNATIONAL COMPUTATION CENTRE**

An Olivetti ELEA 6001 electronic computer has been installed at the International Computation Centre, Rome, Italy. The computer has a memory range of 10,000 decimal positions (expandable to 100,000), and is equipped with two magnetic tape units, a paper tape unit, and teleprinter input and output. It will be used for scientific research, education, and computing services.

**MOTION PICTURE INDUSTRY'S LARGEST COMPUTER INSTALLED AT MCA**

The largest computer in the motion picture industry, and the industry's only integrated data processing system, has been installed at the Universal City headquarters of MCA, Inc., Hollywood, Calif. The computer, a Honeywell 400, will be used by MCA's Revue Productions and Universal Pictures Company for a variety of data processing tasks -- many of them unique in the motion picture industry -- including complex payroll operations, inventory control, picture cost accounting, PERT management functions, and film distribution.

**NORWEGIAN COMPUTING CENTER ORDERS UNIVAC 1107**

The Norwegian Computer Center, Oslo, Norway, has ordered a UNIVAC 1107 Thin-Film Memory Computer, which is scheduled for delivery this summer.

The Center will use the computer for solving scientific problems and for general data processing. It will also be used in operations research and for developing new programming systems.

The University of Oslo, located near the Center, will be one of the principal users of the UNIVAC 1107. The equipment also will be made available to research establishments and industry throughout Scandinavia.

**UNITED NUCLEAR CORP. INSTALLS CONTROL DATA 1604-A SYSTEM**

United Nuclear Corporation, White Plains, N.Y., has installed a large scale Control Data 1604-A Computer System. The system is capable of handling 100,000 operations per second and includes

the 1604-A Computer, two 1607 magnetic tape units, and a 1000 line-per-minute printer.

United Nuclear Corporation is a major producer of nuclear fuel and nuclear reactors. The computer system will be used for advanced scientific research projects.

**SERVICE CENTER INSTALLS B280**

Data Corporation of America, New York, N.Y., a data processing service center, has installed a B280 magnetic tape computer system made by Burroughs Corp., Detroit, Mich. It will replace four tabulating systems. DCA expects to halve operating costs, maximizing output while minimizing the number of components that stand idle in the normal course of data processing.

The Burroughs system includes a central processor with 9600 characters of memory, four magnetic tape units, a paper-tape reader, 800 card-per-minute reader, 300 card-per-minute punch and 700-line-per-minute printer.

**MAIL ORDER HOUSE INSTALLS IBM 1401 EDP SYSTEM**

Office Electronics, Inc., Great Neck, N.Y., one of the largest mail order fulfillment houses in the country, has installed an IBM 1401 EDP system.

The new equipment has been programmed to handle daily sales reports and analysis, preparation of invoices and statements, inventory controls, accounts receivable reports, and the reproduction of labels for list utilization.

Office Electronics, Inc. concentrates chiefly in the book publishing industry, handling all aspects of accounting, shipping and list maintenance for its clients selling by direct mail.

**CRUCIBLE STEEL TO INSTALL CONTROL DATA MESSAGE SYSTEM**

A high-speed communications system will be installed later this year at the headquarters of Crucible Steel Company of America, Pittsburgh, Pa. The firm has ordered a Type 8050 Message and Data Switching System, which is being built by Control Corporation, a subsidiary of Control Data Corporation. The system is expected

to speed up order and inquiry service to coast-to-coast customers of the steel company. The system will be controlled by two Control Data 160-A computers.

**ORGANIZATION NEWS****BURROUGHS TO MANUFACTURE OWN MAGNETIC FERRITE CORES**

Burroughs Corporation will manufacture its own magnetic ferrite cores for its commercial and defense computer systems. The cores will be produced at the company's Electronic Instruments Division in Philadelphia, Pa.

EID will begin with the manufacture of small aperture cores. It expects to reach full production levels to meet internal needs of Burroughs' computer facilities in suburban Philadelphia, Detroit, and Pasadena by mid-August. The cores will be used in memory units of Burroughs B200 and B5000 series commercial computers and the military-oriented D025 modular data-processing system.

**TELEREGISTER BUYS CONTROL OF COMPUTER DYNAMICS CORP.**

Teleregister Corp., Stamford, Conn., has acquired an 80% interest in Computer Dynamics Corp., Silver Spring, Md. The purchase price was not disclosed.

Computer Dynamics is a privately held company specializing in computer systems analysis, programming, and operating services. It employs about 100 persons, most of them computer technologists, and has billings of over \$1 million a year. One-third of the work force is at Cape Canaveral engaged in the programming and operation of launch operations at the center of the National Aeronautics and Space Administration. The remaining two-thirds are at Silver Springs, where the company operates data processing services under contracts with Government agencies.

Teleregister Corp. develops and operates electronic systems to provide market quotation services to the investment banking industry, reservations services to airlines and hotels, and accounting services to banks.

## Newsletter

### CONTROL DATA BOARD APPROVES ACQUISITION OF BENDIX COMPUTER DIVISION

The Boards of both Control Data Corporation and The Bendix Corporation have given their approval to the acquisition by CDC of the Computer Division of the Bendix Corp. (Computers and Automation, April, 1963).

Robert D. Schmidt has been named by Control Data to be manager of the former Bendix Computer facility in Los Angeles. It is planned that the former Bendix Computer sales organization will be merged with the Control Data sales organization at the regional and district sales office level. The former Bendix Computer customer service organization will be merged with the Control Data customer service, also at the regional and district level, to provide service for all Bendix and Control Data computer installations, nation-wide. The Bendix Computer programming activities will be continued.

### ANELEX AND HITACHI, LTD. SIGN AGREEMENT FOR ASIA SALES

ANalex Corp., Boston, Mass., has signed an agreement with Hitachi, Ltd., a large Japanese electronics and industrial company, under which Hitachi will market ANalex products in Japan and other Asian countries. ANalex manufactures high-speed printers and other peripheral equipment for computers.

### NEW FIRM FORMED BY FORMER C-E-I-R EMPLOYEES

Former employees of C-E-I-R, Inc. have organized a new firm -- Systems Programming Inc., Arlington, Va. -- to build highly specialized programming and applications systems for the electronic computing industry.

Wm. Orchard-Hays, president and principal founder of the new company, was formerly vice president for information processing and programming at C-E-I-R. Other principal officers and co-founders of SPI are David M. Smith, vice president and treasurer; R. W. Rumsey, Secretary; and David M. Carstens, Assistant Secretary.

The new company is beginning operations with subcontracts from

C-E-I-R, Inc., one of its original stockholders. SPI expects to provide a wide range of services to aid clients, including consultation, training, and comprehensive documentation. The early work of the new firm will be concentrated in linear programming. The company also will build systems for mathematical and statistical analysis, special purpose and general purpose processors, and language systems.

### HONEYWELL EDP EXPANDS UTILITY ADVISORY COUNCIL

A newly created "Utilities Industry Council" will expand the previous industrial-specialist group maintained by Honeywell EDP, Wellesley Hills, Mass. Its purpose will be to help computer users, actual and prospective, in the utilities industry.

The primary responsibilities of the Utilities Industry Council will be to help companies: define computer-systems requirements; specify computer systems; develop applications; check progress of systems from initial concept to actual productive utilization; and spread the news of technological developments.

The office of the Council will be in New York City.

### KANEMATSU TO REPRESENT SCIENTIFIC DATA SYSTEMS

Scientific Data Systems, Santa Monica, Calif. and F. Kanematsu & Co., Ltd., of Japan, have concluded an agreement for the marketing of SDS products in Japan. Under terms of the agreement, Kanematsu will be responsible for the introduction of SDS 910 and 920 general purpose digital computers to the Japanese market.

### HUGHES DYNAMICS INCORPORATES

Hughes Tool Company has announced the incorporation of its Hughes Dynamics division as a wholly-owned subsidiary. The new subsidiary will be known as Hughes Dynamics, Inc.

F. William Gay, senior vice president of the parent company and chairman of the new corporation's executive committee, said Hughes Dynamics was formed, "to make available to businesses and institutions, of whatever size, a

team of management scientists who can help the organization exploit to the fullest potential all of the recent advances in management technology". Offices are maintained in Los Angeles; Houston; New York; Dallas and Midland, Tex.; and Monterey, Calif.

### EMR ACQUIRES COMPUTER COMPANY

Electro-Mechanical Research, Inc., Sarasota, Fla., has acquired Advanced Scientific Instruments, Inc., Minneapolis, Minn. The purchase by EMR of the assets, organization and good will of the company was approved by ASI stockholders at a special stockholders meeting. ASI will be operated as a division of EMR under the direction of Mr. Ralph E. Mueller (former Executive Vice President) as Division General Manager.

Present plans are to develop and expand the ASI digital computers and peripheral equipment. Operations will remain in Minneapolis using present facilities and personnel.

### DATA PROCESSING FIRMS MERGE

Research Calculations, Inc., and Data Systems, Inc., both of Boston, Mass., have merged, forming one of the largest single independent data-processing services in the Greater Boston area.

Operations will be centralized at 200 Boylston St., Chestnut Hill. The merged organization employs more than 100 experienced data-processing personnel.

A new IBM 1401 computer will be used for all types of data processing and scientific data handling.

### COMPUTING CENTERS

#### EASTERN AIRLINE'S COMPUTER CENTER CELEBRATES FIRST ANNIVERSARY

Eastern Air Lines' Electronic Computer Center completed its first continuous year of operation in Charlotte, N.C., in March. Since officially opening, the Center has handled over 33.8 million transactions between reservation offices and airports in 14 different cities and the Charlotte Center. During the same



time, the computer a UNIVAC 490 Real-Time Computing System, composed and transmitted over 400 thousand teletype messages to various stations in the Eastern system, keeping them posted with up-to-the-minute operating and flight information.

A continuing program of additional applications, and, improvements to the original application of passenger reservations is being carried out at the Center. A smaller UNIVAC Solid-State II magnetic tape computing system has been added to the original system for producing various management reports and processing some data collected by the main system.

In February the UNIVAC 490 began the automatic production and transmission of Flight Plans for each scheduled Air-Shuttle flight from New York. This Flight Plan is complete and is filed with the FAA by teletype directly from the computer. The computer-prepared Flight Plan gives the flight number, proposed departure time, type of equipment, true air speed, altitude, preferential routing, and elapsed time. The Captain has the option to file an alternate plan should operating conditions warrant a change from the computer prepared plan. This new application has eliminated departure delays due to late arrivals of flight plans at the Air Route Traffic Control Center.

The next use of the Univac system which is now contemplated is the automatic recording of flight departure time. This is known as the "Wheels Up" routine. As the wheels of the aircraft are retracted, an electronic signal from a device installed on the plane triggers an agent set at the airport which automatically sends the departure information to the computer. The information will be used to provide accurate flight arrival and departure information for Eastern's customers and will also be used by the computer to maintain accurate flying times and aircraft part usage times.

### **SIMULATION AND RESEARCH CENTER OPENED BY CONTROL DATA DIVISION**

Control Data's System Sciences Division has established a completely equipped computing center as part of its machine simulation and research activity. The center will be in the System Sciences Division, Los Angeles, Calif.

The center will execute research and analysis projects, investigations in machine learning and adaptation, and contract-supported machine-technique research.

Equipment will include a Control Data 1604A/160A Computer System with 8 magnetic tape units, a 650-card-per-minute card reader, and a card punch. The system permits direct access from card reader, printer, or card punch, to either computer. In addition, the 160A computer can communicate with the 1604A computer.

### **BANKS FORM DATA PROCESSING CORPORATION**

Nine banks in upstate New York have formed a data processing corporation to handle the checking accounts of their 78,000 customers. The new organization, known as the Financial Computer Center of Eastern New York, Inc., will provide these banks with the use of modern data processing equipment.

The firm's processing center will be located in Schenectady, N.Y. The data processing equipment, a General Electric 225 all-transistorized computer system, is expected to be installed this fall, and to be fully operational by January 1964.

Participating banks include the Adirondack Trust Company, Saratoga Springs; Ballston Spa National Bank, Ballston Spa; Citizens Trust Company, and Schenectady Trust Company, both of Schenectady; City National Bank and Trust Company of Gloversville; First National Bank of Glen Falls; First Trust Company of Albany, and Mechanics and Farmers Bank, Albany; and the Montgomery County Trust Company, Amsterdam.

Work on the computer center began more than two years ago when the banks engaged the management consulting firm of Booz, Allen & Hamilton Inc. Bank automation specialists from the consulting firm and system analysts from the Financial Computer Center, working with General Electric, designed and are now programming the system and establishing operating procedures for the center.

### **MILLIONTH TELETYPE MESSAGE HANDLED BY WESTINGHOUSE COMPUTER**

Westinghouse Electric Corporation's Tele-Computer Center,

Pittsburgh, Pa., has switched its millionth message on the company teletype network. The computer-controlled teletype system serves as the hub of a nationwide network connecting almost 300 company locations by automatically switching messages from one location to another.

The installation of the Univac 490 Real-Time Computing System (Computers and Automation, February, 1963) increased the speed of message transmissions from 75 to 100 words a minute. In addition to teletype switching, the computer is now being used simultaneously in payroll computation, fixed assets accounting, and sales statistics.

## EDUCATION NEWS

### **AUDIO-VISUAL AIDS CATALOG**

The 1963 edition of its Audio-Visual Aids Catalog, a compilation of films in the field of data processing, systems and automation, has been released by the Data Processing Management Association, Park Ridge, Ill. The 24-page booklet gives short descriptions, running times, sources, and rental fees for over 150 films. Data processing equipment manufacturers' films are included as well as institutional education films.

### **"PERT COST" FILM**

Industrial Education Films, Inc., Princeton, N.J., has added a new film to its library of audio-visual aids for use by industry and government. The new film, "PERT Cost" is a film for management which shows the planning and control of details of work, the network of projects, and the account code structure, used to generate integrated time and cost status. It shows specific examples of information generated by computer printouts, summary reports, and graphic displays. It shows the step-by-step procedure in applying PERT.

The film was produced under contract with the U.S. Navy by Management Systems Corp., prime contractor for the development of the PERT cost system of the Department of Defense and the National Aeronautics and Space Agency.

## Newsletter

### NEW PRODUCTS

#### Digital

### MICROMINIATURE, AEROSPACE COMPUTER

General Electric Company  
Light Military Electronics Dept.  
Utica, N.Y.

This company is developing a microminiature, real-time, general-purpose computer for aerospace use, designated A-236. The new digital computer is a micro-electronic version of GE's M-236 computer, developed for ground-based, real-time military systems.

All software produced for the M-236 will be compatible for the A-236.

Due to the 1/2 microsecond adder cycle, the speed of the A-236 depends almost entirely on the particular memory chosen for the system. The present model has a 4-microsecond core memory. With this memory, most instructions are executed in 8 microseconds, although some can be executed in 4 microseconds.

The computer is expandable. The magnetic core memory, which stores 4096 words, can be increased to 262,144 words. Any number of input/output channels from 3 to 256 can be provided. One index register is standard, but, where necessary, as many as 32 index registers can be supplied. The basic word length is 36 bits but 24 or 30 bits can be made available.

In addition to the basic instructions common to scientific computers, common requirements in aerospace applications of the new device are: 1) flexible input/output capability; 2) interrupt control of the multi-level programs executed by the computer; and 3) a set of instructions for use in data sorting, correlation, and track-while-scan. The A-236 has 111 decoded instructions with 9 methods of address modification to meet the requirements of real-time control and data processing applications.

### GE-235 COMPUTER 3 TIMES AS FAST AS GE-225

General Electric Company  
Computer Department  
Phoenix, Ariz.

This company has added a new computer to its medium-priced line of electronic data-processing systems. The new GE-235 is three times as fast as the GE-225. The new computer, designed for the medium class market, is for computer users requiring higher speed and greater capability than available in their current machines. Such markets include financial institutions, manufacturing industries, and scientific/engineering users.

The GE-235 is compatible with General Electric's other medium-class computers (GE-215 and GE-225) and can use programs written for them, as well as the same peripheral equipment. Although similar in appearance to the GE-225, the new computer has been completely re-engineered to include higher-speed circuits, faster memory and smaller components. The GE-235 is available in memory capacity of 4096, 8182 and 16,384 words. Memory cycle time is six microseconds.

#### Analog

### PNEUMATIC ANALOG COMPUTER

AiResearch Manufacturing Division  
The Garrett Corporation  
Phoenix, Ariz.

The AiResearch pneumatic analog computer was designed for the petro-chemical process industry and can control most processes which can be described by equations or functions. It is modular in design and is compatible with pneumatic controls currently in operation. Modules are easily changed as process requirements are changed.

The computer can add, subtract, multiply, divide, and extract square root, and multiple operations are possible. Standard, high-utilization components can be assembled in such a way that a single module can perform from one to six, or more, mathematical functions. Limited and pure differentiation, proportional gain, integration, and proportional plus integral functions can also be performed.

The computer has three major components: a "Signal Cart" (which converts pneumatic pressure to mechanical force); a Servo Positioner (which changes the position of the lever arm in a way proportional to an input pneumatic signal); and a Lever Box (the main housing of a module, which contains a lever and pneumatic sensor and provides for signal cart and servo positioner installation). The arrangement of these components in each module is determined by the mathematical functions to be performed. By appropriately locating the signal carts, servo positioners and lever boxes to perform the required mathematical functions, the pneumatic computer can be mechanized to solve a set of equations.

### DYSTAC SS-100, NEW ANALOG COMPUTER

Computer Systems, Inc.  
Industrial Park  
Fort Washington, Pa.

This company has developed an all solid-state analog computer, the DYSTAC SS-100, with a computing range of plus 100 to minus 100 volts -- and which uses the full 100 volt dynamic range. Recent developments in semiconductor technology made possible the design of a solid-state operational amplifier whose output covers the full computing range.

The 100-volt solid-state amplifier, with its reduced size and low heat generation, in turn, has made possible the design of a general purpose computer with such advanced capabilities as: (1) precision at computing speeds from real-time to iterative rates in excess of 1000 solutions per second; (2) modular construction, for rapid expansion up to systems able to solve great, complex problems; (3) adaptability to linkage with digital computers in hybrid installations; (4) compatibility with current analog computing equipment; (5) ease in installation with no requirements for air conditioning; and (6) light weight construction for a high degree of mobility.

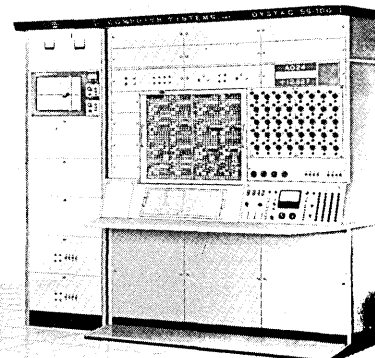

**Digital-Analog**

**HYBRID AIRBORNE NAVIGATION COMPUTER**

Kearfott Division  
General Precision, Inc.  
Little Falls, N.J.

The MINAC-5, developed by this company, is a miniature airborne computer designed to tell the pilot where he is and how he can get to his destination. It is a 30-pound hybrid computer using both analog and digital techniques to supply the pilot with his position, ground track, and wind information. The addition of more sensors will enable the computer to supply destination information such as course and distance to the target and steering error for auto-pilot systems.

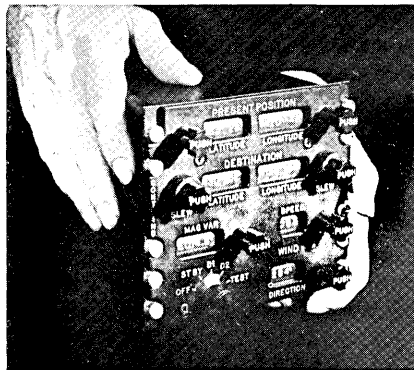

MINAC-5 is easy to operate. The pilot may change destinations, set required inputs, and correct position information without loss of computations, during flight. The computer can store an alternate destination which may be selected at any time during flight.

The device uses solid-state components and has a self-contained power supply. With simple modifications it can be used with inertial systems. The computer can be tied in with inertial platforms, autopilots, micro-electronic digital integration, moving map displays, and automatic variation computation.

**Data Transmitters and A/D Converters**

**HIGH-SPEED ELECTRONIC SYSTEM IDENTIFIES AND RECORDS RAILROAD CARS**

Sylvania Electric Products Inc.  
Waltham, Mass.

A high-speed electronic system, which identifies and records railroad freight and passenger cars at speeds up to 60 miles per hour, has been developed by this company. The system has performed successfully even in blinding rain and snow storms.

A prototype model of the Sylvania system is being tested at Woburn, Mass. in cooperation with the Boston & Maine Railroad. It reads and prints out the direction of travel and the serial numbers of all Budd commuter cars passing through Woburn to and from Boston. The system consists of an unmanned scanner, installed at trackside (see picture below), and a decoding device which converts colors "read" by the scanner into numbers which are printed onto paper tape and transmitted to a central record bureau.

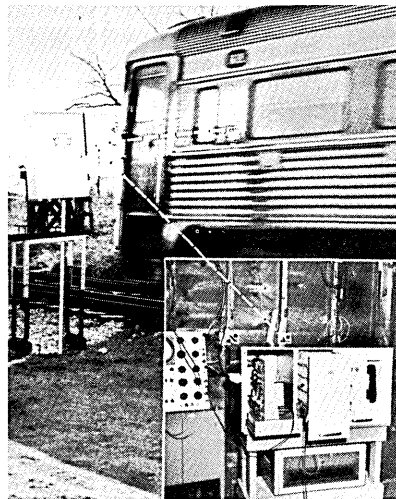

-- An electronic scanner identifies and records a moving passenger car of the Boston & Maine Railroad. The decoding and printing units are shown in the insert.

Each railroad car is labeled with a six-inch wide pattern of colored strips of retro-reflective material, one strip for each digit to be identified. The strips can be located anywhere within a six-foot vertical portion of the side of each car. The scanner

reads the label from bottom to top by sending out a beam of white light and receiving the reflected colored light. In the time it takes the car to pass, the coding device converts the colors to numbers.

The strips of color making up the coded label can be arranged to provide the car's number, its weight and its type of cargo. The stripping has an adhesive backing for easy attachment. It is known as "Scotchlite" and was developed by the Minnesota Mining and Manufacturing Company.

The system has proved reliable in day or night, and in all kinds of weather. The coded label is visible to the scanner even when a covering of snow or ice make it unrecognizable to the human eye. In this way, railroads can further automate signaling, scheduling, classification and interchange of freight cars.

Two years of field testing of the system show it can meet "any practical error rate requirements for Automatic Car Identification (ACI) as determined by railroad users".

**TWO NEW ANALOG-TO-DIGITAL CONVERTERS**

Packard Bell Computer  
1905 Armacost Ave.  
Los Angeles 25, Calif.

This company has developed two new high-speed, high-accuracy, analog-to-digital converters. The two new units are the M20 and the M21.

The M20 is a 30KC converter, producing 30,000 15-bit conversions per second (2 microseconds per bit) with long-term accuracy of 0.01%  $\pm 1/2$  of the least significant bit, including allowance for temperature drift. The M21 is a 70KC converter handling 70,000 12-bit conversions per second (1.2 microseconds per bit) with a long-term accuracy of 0.05%.

Major improvements are foreseen in the following applications because of the converters' higher speed and accuracy:

1. Elimination of multiple converters in systems where input data speed is too fast for a single conventional slower converter to handle.
2. Accurate and practical digitizing of unusually fast

## Newsletter

transient phenomena, such as shock, vibration, electrical network and acoustical data.

3. Reduction or elimination of dispersion or skew error in multichannel analog-to-digital computer linkage systems.

4. On-line digitizing of telemetry data three to four times faster than present equipment will permit.

New approaches to current reference and comparator circuitry contribute to the higher conversion speeds and accuracies of the two new converters. Current switching combined with a continuous oven provides a current reference supply with very fast settling time and unusual stability. In the comparator, continuous sensing of the summing junction helps the converters provide precision accuracy and resolution at high conversion rates.

### COMPUTER-BASED COMMUNICATIONS SYSTEM

IBM Corporation  
Data Processing Division  
White Plains, N.Y.

A communications terminal with unusual flexibility has been developed by this company. The IBM 1050 data communications system provides communication and recording of data for companies with more than one plant or office, that desire centralized data processing.

The system can transmit information recorded in punched cards, punched paper tape, or edge-punched documents, as well as through an operator's keyboard. It can receive information in the form of printed copy or punched into cards, paper tape, or edge-punched documents. These functions are performed by six separate units, any or all of which can be combined to form a single, compact system. The 1050 sends and receives at up to 148 words a minute over public or private communication lines.

### Software

#### FORTRAN COMPILER FOR THE GE-225

General Electric's Computer Department, Phoenix, Ariz., has developed a FORTRAN compiler for

the GE 225 general-purpose computer. FORTRAN can therefore now be used by users of GE's high-speed equipment. The new program also eliminates the need to train programmers specifically on the GE 225. The compiler is called FORTRAN II, and is available through the GE user's library (GET).

#### MAGNETIC INK CODING USED IN NEW COUPONING PROGRAM

Lever Brothers Company, New York, N.Y., has developed a new program for the electronic processing of consumer merchandise coupons using the American Bankers Association's system of magnetic-ink coding. The new program will allow both manufacturers and retailers to take advantage of the automated equipment now used by many banks and the Nielsen Clearing House.

The new program uses convenient dollar-bill size coupons instead of the smaller punch-card type. The coupons can be accurately counted, sorted and their values totaled in the same way that checks are processed. The magnetic-ink codes, in accordance with American Bankers Association specifications, will be printed in single rows at the top and bottom of the back of each coupon. These indicate the manufacturer's code, coupon value and other pertinent data in MICR characters for subsequent "reading" in the electronic processing. The uniform coupons and a standard coding format will allow retailers' banks and clearing houses to mechanically sort and process magnetic ink coupons from all manufacturers on a uniform basis, thereby assuring significant savings for dealers and manufacturers alike.

Lever Brothers has requested the Grocery Manufacturers of America to assign "company codes" and distribute the MICR coding format to other manufacturers interested in using magnetic-ink coded coupons. The GMA now provides this function in connection with punch-card coupons.

#### SPARC PROGRAM

Autonetics Industrial Products, a division of North American Aviation, Inc., Long Beach, Calif., has developed a computer software package, called SPARC, for design of electronic circuits and subsystems. It is designed

for engineering use, and provides its own translations into computer language. Engineers and designers can operate the Recomp computers, using SPARC, without previous computer experience and with little training.

SPARC programs perform a.c. analysis, d.c. analysis, and transient analysis of circuit designs. They greatly reduce development costs while improving reliability. Development schedules and manhours required can be reduced by 60% or more. Design optimization and reliability assurance can be automatically built into designs. Breadboarding and testing operations are greatly reduced.

SPARC has been used successfully in design of circuits for the Minuteman and Hound Dog missiles, and is used on Project Apollo. It also has been selected for work on such projects as Mariner, Explorer, Ranger, Advanced Minuteman, Saturn IV, and Polaris.

#### AUTOPROPS FOR NUMERICAL CONTROL

IBM's 1401 data processing system is now able to produce instructions for numerically-controlled, point-to-point machine tools, through the use of a new program developed by IBM Corp., White Plains, N.Y. The new program AUTOPROPS (AUTOMATIC PROGRAMMING for POSITIONING SYSTEMS), produces instructions which direct numerically-controlled machine tools to compute points and point arrays used in drilling, boring, tapping, stamping and riveting. In tests of the program, tapes were prepared by the computer in less than 20 per cent of the time required using manual methods.

The machining instructions in the form of punched tape are fed into the control device of a machine tool, which then begins the machining process. Instructions produced by AUTOPROPS can be converted to punched tape by an IBM 1012 tape punch under control of the computer. Or the instructions, in the form of punched cards, can be converted to tape off-line by an IBM 063 card-to-tape converter.

Since AUTOPROPS source statements need only simple arithmetic descriptions, an engineer does not need special computer knowledge to use the program. A print-out of the points to be machined is provided, giving the parts programmer a chance to visually examine the computer's output and thus insure greater accuracy.

The AUTOPROPS program is available without charge from IBM branch offices.

### Input-Output

#### READER AUTOMATES PROCESSING OF "HARD-COPY" COMPUTER RECORDS

National Cash Register Company  
Dayton 9, Ohio

A magnetic ledger card reader has been developed by this company to automate routine processing of "hard-copy" records used with NCR's desk-size 390 computer system. Magnetic ledger cards used with the NCR 390 computer resemble conventional business forms, with machine-printed entries on the face of the document. The back of the forms carry magnetic stripes which electronically store data shown on the face of the form and instructions to the computer for handling the account.

The new automatic device can read the ledger cards at speeds up to 2750 cards an hour. Approximately 1000 ledger cards of the same size can be placed in the loading receptacle. Size can range from 6 to 20 inches in width and 8 to 15 inches in depth.

Data stored in magnetic ledger cards are read directly into the memory of the 390 computer which, under program control, can read and pass certain types of accounts or select accounts in a specific category. The new ledger feeder will automate such office procedures as periodic trial balancing of accounts, and delinquency reporting.

#### ELECTRONIC, VERSATILE SORTER OF PUNCHED CARDS COMBINING MANY FUNCTIONS

National Cash Register Company  
Dayton 9, Ohio

A high-speed punched-card sorter has been produced and is on sale by this company, which combines in a single unit several functions normally requiring more than one type of card-handling equipment.

The new machine, designated Class 406 sorter-comparator, is compatible with both electronic and tabulating systems. It can

sort, verify, and perform sequence and selection routines on 80-column punched cards, alphabetically or numerically, at a rate of 1000 cards a minute. There are two separate reading stations and a programmable electronic memory for verifying data and for controlling the distribution of cards into the machine's 14 classification pockets.

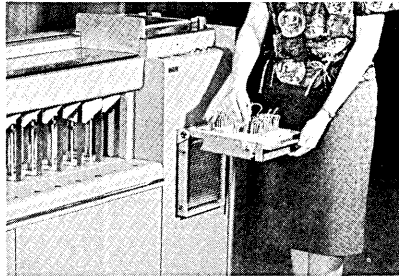

-- NCR Class 406 sorter-comparator can be quickly programmed to perform various types of sort, sequence, and selection routines on 80-column punched cards.

The sorter can read and compare up to 12 columns of punched data in a single pass of the cards at full sorting speed. A typical "sequence check" involves the comparison and verification of unsorted cards in which "master" cards, containing constant data, are sorted into account number sequence followed by related "detail" cards containing transaction data. All master cards without accompanying detail cards and all detail cards without master cards are extracted by sorting these cards into an assigned pocket.

The Class 406 sorter-comparator also counts cards; changes sorting routines quickly; selects cards between two dates (or numbers) and extracts the cards prior, between, and after the specified time; selects cards containing specific numbers from an unsorted group of cards; and performs any other sorting on a logical configuration of alphabetic, numeric, or binary code punched in a card.

#### DIGITAL EVENT RECORDER

Packard Bell Computer  
1905 Armacost Ave.  
Los Angeles 25, Calif.

This company has developed a Digital Event Recorder which monitors up to 2000 independent bistable conditions every two milliseconds -- 100 times faster than any comparable equipment. The

new device scans groups of 200 input channels in parallel at a 100KC rate, printing or reading out the time of condition change, the sequential number of the channel or event, and the nature of the change. Any two desired symbols can be used to indicate a change in channel condition.

The Digital Event Recorder has a high cycling rate and high speed storage which permits backlogging of events for a subsequent read-out on paper tape or digital printer or into a high speed computer-type buffer. The ability to backlog allows accurate monitoring of events which occur hundreds of times faster than it is possible to read them out.

Two models of the Recorder are available -- the DER-600 which can monitor up to 600 inputs and the DER-2000 which can monitor a maximum of 2000 channels.

Applications for the Digital Event Recorder include monitoring automatic checkout procedures for missiles, fire control, navigation, guidance and other complex systems; monitoring and control of chemical, petroleum or other continuous process operations; and control of automated manufacturing processes.

### Components

#### HARD MAGNETIC COATING FOR DISCS, DRUMS, RODS

Lockheed Electronics Company  
6201 East Randolph St.  
Los Angeles 22, Calif.

A new development in magnetic surfaces for rotating data storage equipment has been announced by this company. The new coating, called DATAKOTE, offers high metallurgical hardness, greater uniformity, and magnetic properties to exact specifications. A wide range of coercivity and remanence values can be obtained.

The DATAKOTE magnetic surfaces permit operating speeds, bit-packing densities, and freedom from dropouts never before obtained. The high metallurgical hardness (50 to 55 on the Rockwell C scale) eliminates surface damage due to mechanical malfunction and permits use of direct head contact techniques.

## Newsletter

This company does not intend to enter the magnetic disc or drum storage field, but will offer the new magnetic surfaces as a service to manufacturers of such systems.

### DISCRETE TRACK MAGNETIC RECORDING METHOD

IBM Corporation  
General Products Division  
San Jose, Calif.

Engineers at IBM's development laboratory have experimented with new approaches to digital magnetic recording techniques. At the IEEE International Convention, held in New York, Lester F. Shew described test results of his experimentation with discrete-track recording. This method uses a single-gap head and a discrete-track medium to increase the head-repositioning tolerance in saturation digital recording.

Conventional recording methods for minimizing the undesirable effects in digital computers require a head with two or more separate magnetic elements. When two elements are used, each performing a distinct function, a physical distance exists between the gaps, resulting in a time difference with respect to the index pulse (or reference point). In addition the multiple-element scheme may require additional transverse width, thus reducing the number of tracks possible for a given area on the recording surface.

The discrete-track recording method avoids the time differential, makes better use of the recording area, and tolerates larger head-repositioning error. The recording medium consists of discrete magnetic tracks separated by non-magnetic lands. Width of the magnetic tracks depends largely on the desired track density and the maximum tolerable head-repositioning error.

Discrete-track recording has several definite advantages over conventional continuous-magnetic surface recording methods. For the same read-track width and same track density, discrete-track recording can tolerate head-repositioning errors greater than twice that which can be tolerated by the conventional methods. Thus, with a given head-repositioning error, it is possible to attain higher track density for a given area of the recording surface. With proper design, the readback-signal amplitude can be made less sensitive to a wide range of head

displacement. Residual noise and crosstalk are low because of the nonmagnetic land between the tracks.

The experiments have demonstrated that a track density of 100 tracks per inch can be successfully achieved, with a head-repositioning error of  $\pm 2.25$  thousandths of an inch and at a recording density of 1000 bits per inch.

### MICROMINIATURE GLASS WIRES

Corning Glass Works  
Corning, N.Y.

Microminiature "glass wires" have been developed by this company for use in electroluminescent X-Y coordinate display panels. The transparent conductors consist of glass fibers coated with a transparent electrically conductive film and a transparent insulation. Resistivity of the E-C coating is approximately 80 ohms per square, permitting light transmission of about 70 per cent. Tensile strength of the finished fibers lies between 12,000 and 50,000 pounds per square inch.



Corning's Industrial Bulb Sales Department is initially marketing two-inch long arrays containing 300 parallel strands in width of one inch. The diameter of the glass wires, the number of fibers per inch of width in an array, and the size of the array itself, are all variable to meet custom designs.

Electroluminescent X-Y display panels are made by sandwiching a phosphor between a layer of parallel metal conductors on the X-axis and an array of Corning's glass wires parallel to the Y-axis. A spot of light appears where current in the conductors intersects on the grid. Transparent conductors are necessary so that the light spots can be observed.

Devices such as these are being considered for use in navigational or tactical plotting boards to display direction and speed of moving objects. By sequential pulsing, the display can be made continuous.

### NEW CONCEPT IN DIGITAL MAGNETIC TAPE SYSTEMS

Digital Equipment Corporation  
Maynard, Mass.

This company has introduced a compact magnetic tape system which has two major new features: low cost and fixed-position addressing. Units of information as small as three binary bits can be replaced on the tape without disturbing adjacent information.

The Micro Tape 555 is based on an approach developed at M.I.T. Lincoln Laboratory in connection with the TX-2 and Linc computers. It combines an updating capability, absent in paper tape, with the much higher data rate of magnetic tape. Readout of the updated program can be immediate. The user can take with him his own individual pocket-sized reel of tape. Each  $3\frac{1}{2}$ -inch reel holds 250 feet of  $3/4$ -inch tape. Density is 400 bits per track inch. Total storage is approximately four million bits per reel, the equivalent of about 4000 feet of paper tape.

The electrical design of Micro Tape uses phase (rather than amplitude) recording and has a permanent timing track. The mechanical characteristics include a simple drive system that requires no capstan, no pressure pads, and no mechanical buffering. Read, write, and search speed is 80 inches per second. Searching can be carried out in either direction.

Micro Tape 555 is made for use with high speed, general purpose computers.

### FLYING SPOT SCANNER SYSTEMS

Litton Industries  
Electron Tube Division  
San Carlos, Calif.

Flying-spot scanner systems, for a variety of applications including real-time display and information storage and retrieval, are now available from this company.

These scanners are assembled from a wide range of standard display-system components, which offer variations in scan rate, scanning mode, video bandwidth and other parameters.

PEOPLE OF NOTE

ANDERSON REELECTED CHAIRMAN OF IEE ELECTRONIC COMPUTER GROUP

Walter L. Anderson has been reelected Chairman of the Professional Technical Group on Electronic Computers, Institute of Electrical and Electronics Engineers. Mr. Anderson, executive vice president of General Kinetics Inc., Arlington, Va., has held numerous offices as an IEEE and IRE member. The international Electronic Computer Group is responsible for the publication of technical material relating to computers and for the sponsorship of conventions, six of which are held annually. Chapters of the group are located in 23 major cities.

DR. JOHN M. SALZER ASSOCIATE DIRECTOR

Dr. John M. Salzer has been appointed associate director of advanced systems for General Precision, Inc.'s Information Systems Group. He will be concerned with advanced programs and future planning for the group's military and government business. Dr. Salzer, widely experienced in both technical and managerial areas, held top-level positions with Thompson Ramo Wooldridge, Inc., before joining General Precision. He is a lecturer at UCLA, where he teaches courses in sampled-data controls and computers. Dr. Salzer holds a patent in industrial instrumentation, and has authored numerous technical articles.



APPOINTMENTS BY RCA

Theodore W. Helweg has been appointed Manager, Industry Marketing Operations. RCA Electronic

Data Processing. Mr. Helweg, formerly manager of RCA optical character reading programs, will be responsible for market development and sales support for RCA computer systems in fields ranging from manufacturing through scientific markets.

Dale P. Whiteherse has been appointed Manager of the RCA Electronic Data Processing Service Center in Washington, D.C. He was formerly account representative for the RCA Electronic Data Processing Division with the Whirlpool Corporation in Detroit.

CHANGES AT ANELEX

Anelex Corporation, Boston, Mass. is expanding (sales, \$3.7 million in 1960, were \$12.5 million in 1962). This has resulted in several personnel promotions and changes.

Vice President Robert L. Williams will be responsible for the management of a Marketing and Products Division.

John F. Koch, Jr. will be head of a Government Services Department.

Kenneth W. Galeucia, Anelex Treasurer, has been elected to the newly created post of Executive Vice President -- he will continue to serve as Treasurer.

David F. Sweeney has been promoted to Director of Engineering.

Eugene C. Gilbert has been made Assistant to the Executive Vice President.

PERSONNEL CHANGES AT IBM

International Business Machines Corporation has announced the promotion of T. Richard Hunter to administrative assistant in the office of the IBM board chairman. Mr. Hunter had been a program manager with the company's General Products Division Development Laboratory at Endicott, N.Y.

Carl H. Reynolds has been named Manager of Programming Systems for IBM's Data Systems Division, Poughkeepsie, N.Y. Six functional groups, located in Poughkeepsie, New York City, Boston, and Los Angeles, under Mr. Reynolds, make up this expanded programming organization.

Maxwell O. Paley has been named Manager of Systems Planning and Development in the IBM Data Systems Development Laboratories, also at Poughkeepsie, N.Y. He was formerly Advanced Systems Manager at the Laboratories.

BOWLES ELECTED VICE PRESIDENT



Harry G. Bowles, vice president and controller, Burroughs Corp., has been elected vice president, finance. Mr. Bowles has been with Burroughs since 1929.

SCHLESSEL NAMED PRESIDENT OF THE AUTOMATION DIVISION, U.S. INDUSTRIES, INC.

Joseph H. Schlessel has been appointed President of the Automation Division of U.S. Industries, Inc. This division, located in Silver Spring, Md., manufactures the USI line of teaching machines; its services also include automation engineering consultation, engineering and fabrication of custom automation systems; and production of off-the-shelf automation components.

DOC INC. NAMES DUNLOP TO HEAD NASA INFORMATION FACILITY

Woodrow W. Dunlop has been appointed Director of the Scientific and Technical Information Facility, which Documentation Inc., Bethesda, Md., operates for the National Aeronautics and Space Administration. Mr. Dunlop joined DOC Inc. to assume operation. He was previously employed in the Information System Operation of the General Electric Company.

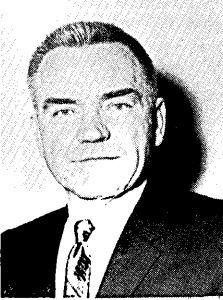

The Scientific and Technical Information Facility is the first completely-integrated technical information center dealing in the space and aeronautical sciences.

**BUSINESS NEWS**

**STUDY SHOWS ONLY ONE-THIRD OF COMPUTER USERS RUNNING PROFITABLE OPERATIONS**

A study of 27 leading industrial and merchandising firms, which use more than 300 computers in their operations, has revealed that only one-third are achieving efficiency in their applications. These results appear in a recent report on the impact of computers on corporate management by McKinsey & Company, Inc., international management consultants.

The study considered over fifty factors believed important in the profitable use of computers in data processing systems. The signs of a successful company application were judged to be a reduction in clerical costs, increased operating efficiency, more accurate market forecasting, better customer service, and management reports that were more current.

The attitudes of top-executives toward the computer was found to be the very significant variable in the success of a computer operation. High-achieving companies had an organization around the computer where:

- (a) The director of the computer system reports directly to the company president, or to a vice-president.
- (b) The chief executive devotes a substantial amount of time to the computer application.
- (c) The chief executive insists that sound techniques are developed to plan and control each step of the computer application.
- (d) The chief executive makes operating managers responsible for putting the computer to work profitably in their own departments.

Low-achieving companies tended to have executives who regarded the computer as a mysterious device to be delegated down-the-line to technical experts. These companies failed to achieve either tangible or intangible benefits from their computer installation.

Surprisingly, some factors often highly promoted by computer manufacturers had little relationship to the success of the computer application. For example, the operating speeds and input/output capacities of the computer used

were not significant factors. Nor was their a relationship between the length of time that a company had had a computer and the degree of success of the application.

**BUY MORE COMPUTERS OUTRIGHT, GOVERNMENT AGENCY RECOMMENDS**

The U.S. Government Accounting Office has recently reported to Congress that substantial amounts of money can be saved if the Federal Government purchased more of its data processing equipment needs. In the GAO's March, 1963, report to Congress, it also recommends that the President establish a small, highly placed, central management office to coordinate procurement and utilization of EDP equipment.

In its report, the GAO detailed cost comparisons of 18 different computers and indicated potential savings of approximately \$148 million over a five-year period from purchase instead of rental. These savings were determined for only 523 of the 1004 computers expected to be installed in government operations by June 30, 1963. For additional use of the 523 machines after five years, the GAO said, there would be further savings at the rate of over \$100 million annually.

The GAO calculated the costs of leasing, purchasing, and maintenance for each computer system, and the interest applicable to these costs. It compared the total cost of each system's rental over a five-year period with the cost of outright purchase, plus the cost of maintenance. All comparisons were made on a one-, two- and three-shift basis. Of the 18 computers evaluated, only four showed a lease cost advantage. These were the Philco 2000, the UNIVAC III, the UNIVAC SS-90, and the IBM 1401 card system.

To illustrate the purchasing advantages of the other computers, the GAO projected the estimated savings that would be realized over a five-year period for 36 IBM 7090 and 7094 systems to be leased as of June, 1963. Over the period, the savings amounted to \$57,449,000. After that there would be a \$34,378,000 savings for each additional year, according to the GAO.

The GAO's recommendation that the President set up a central management office was seen as a reaction to the present system where each agency makes its own decision as to the method of acquiring EDP equipment. As an interim measure, pending action on the recommendation, the GAO suggested that all agency heads re-appraise their current plans to lease computing equipment.

**THE COMPUTER FIELD ACHIEVES \$3.4 BILLION IN SALES, D & B REPORTS**

Making and servicing electronic computing machines is now a \$3.4 billion industry, according to a recent report to COMPUTERS AND AUTOMATION from Dun & Bradstreet, Inc., New York. The figures, derived from 17 firms in the field listed in D&B's new Million Dollar Directory, also show that there are over 280,000 people currently employed in the computer and electronic data processing in-

dustry. The Million Dollar Directory lists over 23,000 firms in the United States which have a net worth of a million dollars or more.

The D&B statistics for S.I.C. (Standard Industrial Classification of the U.S. Department of Commerce) No. 3571, "electronic computing machines", are summarized below:

<u>STATE</u>	<u>NUMBER OF COMPANIES</u>	<u>SALES VOLUME</u>	<u>NUMBER OF EMPLOYEES</u>
California	5	\$123 millions	10,714
Florida	1	3 "	425
Illinois	1	60 "	4,600
Massachusetts	1	7 "	525
Michigan	2	409 "	37,800
Minnesota	1	39 "	2,200
New Jersey	1	N/A "	9,000
New York	4	2,235 "	162,017
Ohio	1	519 "	56,000
Totals	17	\$3,395 millions	283,281



A CASE FOR OPTICAL READERS

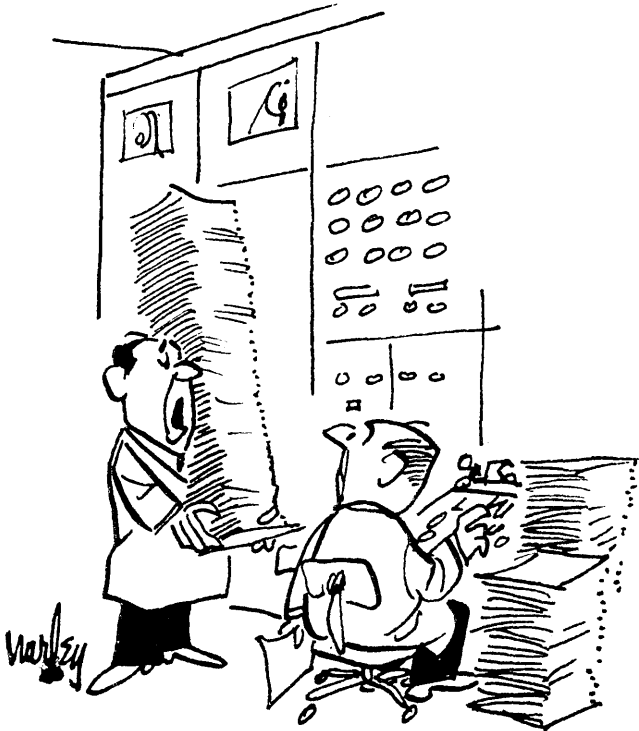

"You just finished keypunching problem 10673-B?  
It was supposed to be 10673(b)."



**PERSONNEL SPECIALISTS**

Missiles and Aerospace  
Electronics Systems and Products  
Data Processing  
Nuclear  
Industrial

**EXECUTIVE SEARCH**

Salaries commensurate with senior status and degree of contribution. Send resume or write for our Professional Information Form. Client companies assume all expenses.



**VALLEY CONSULTANTS, Inc.**  
716 YORK ROAD • BALTIMORE 4, MD.  
AREA CODE 301 VALLEY 5-0256  
*Designed to Serve the Professional  
... in a Professional Manner*

*Programmers are cordially invited  
to discuss interesting career opportunities  
at all experienced levels  
in the IBM Data Systems Division*

Immediate assignments are open with  
programming research, development, and applications teams in:

**Advanced programming  
Advanced programming techniques**

**Programming languages  
Business-oriented programming**

**Supervisory programs**

Automatic Operator  
Systems Supervisor  
Symbolic I/O  
Interrupt Control

Machine Control  
Stack Job Scheduling  
IOCS  
Symbolic Debugging

**IBM benefits include:**  
Advanced-degree program  
Relocation expenses  
Locations are in  
Poughkeepsie and New York City, N.Y.;  
Beverly Hills, Calif.; Boston, Mass.  
Promotion from within

If you have one or more years of experience, please write, outlining your background and qualifications, to:  
**J. B. Zwynenburg**  
IBM Corp., Dept. 539EI  
Box 390  
Poughkeepsie, N. Y.



IBM is an Equal Opportunity Employer

# MONTHLY COMPUTER CENSUS

The number of electronic computers installed, or in production at any one time has been increasing at a bewildering pace in the past several years. New vendors have come into the computer market, and familiar machines have gone out of production. Some new machines have been received with open arms by users -- others have been given the cold shoulder.

To aid our readers in keeping up with this mushrooming activity, the editors of COMPUTERS AND AUTOMATION present this monthly report on the number of American-made general purpose computers installed or on order as of the preceding month. We update this computer census monthly, so that it will serve as a

"box-score" of progress for readers interested in following the growth of the American computer industry.

Most of the figures are verified by the respective manufacturers. In cases where this is not so, estimates are made based upon information in the reference files of COMPUTERS AND AUTOMATION. The figures are then reviewed by a group of computer industry cognoscenti.

Any additions, or corrections, from informed readers will be welcomed.

AS OF APRIL 20, 1963

NAME OF MANUFACTURER	NAME OF COMPUTER	SOLID STATE?	AVERAGE MONTHLY RENTAL	DATE OF FIRST INSTALLATION	NUMBER OF INSTALLATIONS	NUMBER OF UNFILLED ORDERS
Addressograph-Multigraph Corporation	EDP 900 system	Y	\$7500	2/61	11	11
Advanced Scientific Instruments	ASI 210	Y	\$2850	4/62	8	1
	ASI 420	Y	\$12,500	2/63	1	0
Autonetics	RECOMP II	Y	\$2495	11/58	125	5
	RECOMP III	Y	\$1495	6/61	32	18
Burroughs	205	N	\$4600	1/54	72	X
	220	N	\$14,000	10/58	58	X
	E101-103	N	\$875	1/56	170	X
	B250	Y	\$4200	11/61	52	43
	B260	Y	\$3750	11/62	31	45
	B270	Y	\$7000	7/62	15	25
	B280	Y	\$6500	7/62	18	22
	B5000	Y	\$16,200	4/63	1	20
Clary	DE-60/DE-60M	Y	\$675	2/60	98	1
Computer Control Co.	DDP-19	Y	\$2800	6/61	3	X
	DDP-24	Y	\$2750	-/63	0	3
	SPEC	Y	\$800	5/60	10	0
Control Data Corporation	G-15	N	\$1000	7/55	350	2
	G-20	Y	\$15,500	4/61	21	4
	160/160A	Y	\$1750/\$3000	5/60 & 7/61	280	53
	924/924A	Y	\$11,000	8/61	7	10
	1604/1604A	Y	\$35,000	1/60	45	9
	3600	Y	\$52,000	4/63	0	5
Digital Equipment Corp.	6600	Y	\$120,000	2/64	0	1
	PDP-1	Y	Sold only about \$120,000	11/60	42	9
	PDP-4	Y	Sold only about \$60,000	8/62	13	14
El-tronics, Inc.	ALWAC IIIE	N	\$1820	2/54	33	X
General Electric	210	Y	\$16,000	7/59	73	10
	215	Y	\$5500	-/63	0	15
	225	Y	\$7000	1/61	118	88
	235	Y	\$10,900	-/64	0	1
General Precision	LGP-21	Y	\$725	12/62	5	33
	LGP-30	semi	\$1300	9/56	400	12
	L-3000	Y	\$45,000	1/60	1	0
	RPC-4000	Y	\$1875	1/61	68	17
Honeywell Electronic Data Processing	H-290	Y	\$3000	6/60	9	3
	H-400	Y	\$5000	12/61	42	67
	H-800	Y	\$22,000	12/60	49	7
	H-1400	Y	\$14,000	5/64	0	2
	H-1800	Y	\$30,000 up	-/63	0	2
	DATAmatic 1000	N	-	12/57	5	X
H-W Electronics, Inc.	HW-15K	Y	\$490	3/63	0	2

NAME OF MANUFACTURER	NAME OF COMPUTER	SOLID STATE?	AVERAGE MONTHLY RENTAL	DATE OF FIRST INSTALLATION	NUMBER OF INSTALLATIONS	NUMBER OF UNFILLED ORDERS
IBM	305	N	\$3600	12/57	830	X
	650-card	N	\$4000	11/54	690	X
	650-RAMAC	N	\$9000	11/54	205	X
	1401	Y	\$3500	9/60	5400	3400
	1410	Y	\$12,000	11/61	170	380
	1440	Y	\$1800	4/64	0	800
	1460	Y	\$9800	10/63	0	18
	1620	Y	\$2000	9/60	1400	260
	701	N	\$5000	4/53	4	X
	7010	Y	\$19,175	2/64	0	32
	702	N	\$6900	2/55	4	X
	7030	Y	\$160,000	5/61	4	1
	704	N	\$32,000	12/55	75	X
	7040	Y	\$14,000	6/63	0	45
	7044	Y	\$26,000	6/63	0	12
	705	N	\$30,000	11/55	145	X
	7070, 2, 4	Y	\$24,000	3/60	340	235
	7080	Y	\$55,000	8/61	47	27
	709	N	\$40,000	8/58	37	X
	7090	Y	\$64,000	11/59	245	120
7094	Y	\$70,000	9/62	7	12	
Information Systems, Inc.	ISI-609	Y	\$4000	2/58	20	1
ITT	7300 ADX	Y	\$35,000	7/62	6	2
Monroe Calculating Machine Co.	Monrobot IX	N Sold only	\$5800	3/58	165	2
	Monrobot XI	Y	\$700	12/60	250	190
National Cash Register Co.	NCR - 102	N	-	-	30	X
	- 304	Y	\$14,000	1/60	30	0
	- 310	Y	\$2000	5/61	38	45
	- 315	Y	\$8500	5/62	55	140
	- 390	Y	\$1850	5/61	333	230
Packard Bell	PB 250	Y	\$1200	12/60	145	20
	PB 440	Y	\$3500	9/63	0	10
Philco	1000	Y	\$7010	-/63	0	27
	2000-212	Y	\$52,000	1/63	2	14
	-210, 211	Y	\$40,000	10/58	24	10
	4000	Y	\$6000	-/63	0	10
Radio Corp. of America	Bizmac	N	-	-/56	4	X
	RCA 301	Y	\$6000	2/61	233	288
	RCA 501	Y	\$15,000	6/59	92	14
	RCA 601	Y	\$35,000	11/62	5	9
Scientific Data Systems Inc.	SDS-910	Y	\$1700	8/62	12	41
	SDS-920	Y	\$2690	9/62	8	10
TRW Computer Co.	TRW-230	Y	\$1800	9/63	0	8
	RW-300	Y	\$5000	3/59	32	3
	TRW-330	Y	\$6000	12/60	6	20
	TRW-340	Y	\$8000	-/63	0	4
	TRW-530	Y	\$2500	8/61	17	6
UNIVAC	I & II	N	\$25,000	3/51 & 11/57	55	X
	Solid-State II	Y	\$8500	9/62	7	30
	III	Y	\$20,000	8/62	6	64
	File Computers	N	\$15,000	8/56	70	1
	60 & 120	N	\$1200	-/53	888	15
	Solid-state 80, 90, & Step	Y	\$8000	8/58	545	140
	490	Y	\$26,000	12/61	6	10
	1004	Y	\$1500	2/63	50	1500
	1050	Y	\$7200	9/63	0	2
	1100 Series (except 1107)	N	\$35,000	12/50	28	X
	1107	Y	\$45,000	10/62	2	16
LARC	Y	\$135,000	5/60	2	X	
X -- no longer in production				TOTALS	15,036	8770

# BOOKS AND OTHER PUBLICATIONS

Moses M. Berlin  
Allston, Mass.

We publish here citations and brief reviews of books and other publications which have a significant relation to computers, data processing, and automation, and which have come to our attention. We shall be glad to report other information in future lists if a review copy is sent to us. The plan of each entry is: author or editor / title / publisher or issuer / date, publication process, number of pages, price or its equivalent / comments. If you write to a publisher or issuer, we would appreciate your mentioning **Computers and Automation**.

Huskey, Harry D., and Granino A. Korn, eds., and 65 contributors / **Computer Handbook** / McGraw-Hill Book Co., Inc., 330 W. 42nd St., New York 36, N. Y. / 1962, printed, approx. 1,255 pp, \$25.00

This important book presents, in extensive detail, the principles of design and of utilization of analog and digital computers. In either field sufficient detail is presented so that anyone competent in the field can proceed to construct a computer, or having a computer, can proceed to use it. Components are discussed in detail; actual circuit designs have been included. Sections 1 through 9 concern analog computers, and Sections 10 through 21 concern digital computers. Section four, "Electronic Analog Computers: Control Circuits, Computer Operation, and System Design," deals with the design of analog-computer systems, problem checking, computer-laboratory organization, and computer maintenance. Section 10, "Components," presents the details of components used in digital computers, with particular emphasis on semiconductor diodes and transistors. Section 14, "Information Coding and Switching Theory," presents material on error-detecting and error-correcting codes and on the use of Boolean algebra in switching-circuit design. Recent advances such as late amplifier and multiplier circuits, precision electronic switches, hybrid analog-digital computers, and network computer techniques are also discussed. Index.

Pontryagin, L. S., V. G. Boltyanskii, R. V. Gamkrelidze, and E. F. Mishchenko / **The Mathematical Theory of Optimal Processes** / translated from the Russian by K. N. Trivogoff / John Wiley & Sons, Inc., Interscience Division, 440 Park Ave. S., New York 16, N. Y. / 1962, printed, 360 pp, \$11.95

This work makes available to persons with advanced mathematical training the powerful results in optimal control theory obtained by a group of mathematicians at the Steklov Mathematical Institute in Moscow, recipients of the 1962 Lenin Prize for Science and Technology. One of the significant features of the theory as developed in the book is the "maximum principle," which makes it possible to solve a number of pure and applied mathematical problems, variational in character and lying outside of the classical calculus of variations. Seven chapters include: "The Maximum Principle," "Linear Time-Optimal Processes," "Optimal Processes with Restricted Phase

Coordinates," and "A Statistical Optimal Control Problem." List of references to works in both Russian and English. Index.

Moulton, Forest Ray / **Methods in Exterior Ballistics** / Dover Publications, Inc., 180 Varick St., New York 14, N. Y. / 1962, printed, 257 pp, \$1.75

This book, an excellent introduction to the mathematics of projective motion, was originally published in 1926, as a result of work done for the U. S. Army. The theories discussed were developed in coordination with extensive proving-ground wind-tunnel experiments. The book treats from a theoretical point of view, the general problem of exterior ballistics. Six chapters include: "Gravity and the Resistance Function," "Numerical Solution of Differential Equations," "Theory of Differential Variations," and "Motion of a Rotating Projectile." Index.

Macon, Nathaniel / **Numerical Analysis** / John Wiley & Sons, Inc., 440 Park Ave., South, New York 16, N. Y. / 1963, printed, 161 pp, \$5.50

This book is an introduction to numerical analysis, and places strong emphasis on applicability to high-speed computing. Among the subjects covered are: approximation by Taylor's series, iterative methods of solving equations, numerical methods of linear algebra, interpolation with polynomials, numerical differentiation and integration, and numerical solution of ordinary differential equations. The author is Professor and Director of the Computing Laboratory at Auburn University. The book requires only a knowledge of freshman mathematics and calculus. Twelve chapters include: "Computational Methods with Matrices," "Remainder Terms for the Integration Formulas," "Systems of First-Order Equations," and "Difference Equations." Exercises at the end of each chapter. Index.

Macmillan, R. H., T. J. Higgins, and P. Naslin, eds., and nine authors / **Progress in Control Engineering: Vol. 1** / Academic Press Inc., 111 Fifth Ave., New York 3, N. Y. / 1962, printed (in Great Britain), 260 pp, \$10.00

The purpose of this series of books is to fill the gap left between introductory texts which deal with fundamental principles and the latest advances reported in specialist journals. Since the subject of Control Engineering has progressed so markedly, it has become necessary to supplement an ordinary text with a work of this sort. Each author, a recognized authority in his field, discusses his limited topic in sufficient detail to give the reader a broad historical view of its development and a sufficient understanding of underlying theory. Eight articles include: "The Place of Digital Computers in Control," by M. V. Wilkes; "Time Lag Systems," "The Human Operator in Control Instrumentation," and "Automatic Control by Pneumatics."

Bartee, Thomas C., Irwin L. Lebow, and Irving S. Reed / **Theory and Design of Digital Machines** / McGraw-Hill Book Co., Inc., 330 W. 42 St., New York 36, N. Y. / 1962, printed, 324 pp, \$11.50

The primary purpose of this book is the presentation of techniques for digital-

machine design. It was written by three members of Lincoln Laboratory, Mass. Inst. of Technology, as a text for senior or first-year graduate students. The theoretical and practical aspects of much of the material lying between circuit design and programming form the subject matter for this book. The book may be divided into three parts: Chapters 1 through 3 are "Digital Machines and Systems, Binary Cells and Registers, Boolean Algebra and Logic Design." Chapters 6 to 10 cover the various aspects of actual machine design. The remaining three chapters, 4, 5, and 11, discuss material of a more theoretical nature. The book contains problems at the end of each chapter, and numerous references at the end of most chapters. An appendix, "Number Representation Systems," and an index are included.

Pfeiffer, John / **The Thinking Machine** / J. B. Lippincott Co., Phila., Penn. / 1962, printed, 242 pp, \$5.95

Written in an entertaining and easily understandable style, this book is an introduction to the workings, accomplishments, and future possibilities of general-purpose electronic computers, and their possible contribution to the solution of man's most pressing problems. In the chapter "Artificial Intelligence," the author discusses computer accomplishments such as: writing scripts for Westerns, translating from Russian into English, preparing indexes and abstracts. In "Games, Strategies, Learning," Mr. Pfeiffer discusses the evolution of chess-playing machines, the latest models of which play a "passable" amateur game. There is a total of eleven chapters and an index.

Alt, Franz L. and Morris Rubinoff, editors and eight authors / **Advances in Computers, Vol. 3** / Academic Press Inc., 111 Fifth Ave., New York 3, N. Y. / 1962, printed, 361 pp, \$12.00

This book attempts a broad coverage of different selected aspects of the computer field, as opposed to the ever-increasing specialization found in many recent publications in the field. The following areas are represented: applications, both scientific and data processing; methods, both of numerical analysis and of computer programming; engineering considerations in computer selection. The book contains six articles or reports which include: "The Computation of Satellite Orbit Trajectories," "Multi-programming," "Recent Developments in Nonlinear Programming," "Alternating Direction Implicit Methods," "Information Technology and the Law." Each article contains a bibliography. Author Index. Subject Index.

Yovits, Marshall C., editor, and 59 authors / **Large-Capacity Memory Techniques for Computing Systems** / The Macmillan Co., 60 Fifth Ave., New York 11, N. Y. / 1962, printed, 440 pp, \$ ?

This monograph comprises the proceedings of the "Symposium on Large Capacity Memory Techniques for Computing Systems" in Washington, D. C., May 23-25, 1961. Although high-speed computers have become considerably faster and larger, the limited random-access memory of the computing system is the major difficulty in solving a large number of problems. The objective of this symposium was to focus attention on new ideas, research, and de-

velopments which would lead to novel computer memories capable of storing very large amounts of information. There are 30 papers which include: "Organization of Large Memory Systems," "Capacitance-Type Fixed Memory," "MAGOP—A New Approach to High-Density Digital Magnetic Recording," and "The Metal Card Memory—A New Semipermanent Store." References contained in most of the articles. Numerous illustrations.

**Sebestyen, George S. / Decision-Making Processes in Pattern Recognition / The Macmillan Co., 60 Fifth Ave., New York 11, N. Y. / 1962, photooffset, 162 pp, \$7.50**

This monograph approaches problems of machine learning and deciding in the recognition of patterns "from a point of view motivated by statistical theory." From a finite number of samples—since, in practice, an infinite number is not available—the author derives linear and nonlinear methods for separating patterns from one another so that the probability of error in distinguishing them shall be minimized. Five chapters include: "Linear Methods in Classification and Learning," "Nonlinear Methods in Classificatory Analysis," and "Approximate and Adaptive Techniques of Classification." Includes a bibliography and an index.

**Hildebrand, F. B. / Advanced Calculus for Applications / Prentice-Hall, Inc., Englewood Cliffs, N. J. / 1962, printed, 646 pp, \$9.75**

The purpose of this text is to present an integrated treatment of certain topics in mathematics which can be made to depend only upon a sound course in elementary calculus. The first four chapters deal with ordinary differential equations, including analytical, operational, and numerical methods of solution, and with special functions generated as solutions of such equations. Chapter 5 deals with boundary-value problems governed by ordinary differential equations. Chapter 6 develops useful ideas and tools of vector analysis. Chapter 7 provides brief introductions to some special topics in higher-dimensional calculus. In Chapter 8, certain basic concepts associated with the simpler types of partial differential equations are introduced. Chapter 9 makes use of tools developed in earlier chapters for the purpose of formulating and solving a variety of problems governed by the partial differential equations of mathematical physics. Chapter 10 deals with topics in the theory of analytic functions of a complex variable. Extensive sets of problems are included at the end of each chapter. Answers to all problems are either incorporated into the statement of the problem or listed at the end of the book. Index included.

**Jacobowitz, Henry / How to Solve Problems in Electricity and Electronics / John F. Rider Publisher, Inc., 116 West 14 St., New York 11, N. Y. / 1962, printed, 152 pp, \$3.50**

Techniques and methods for solving typical problems in electricity and electronics are here described. The first three chapters present a review of electrical and electromagnetic principles and includes more than 80 worked-out solutions to AC and DC problems. Chapter 4 covers linear tube problems and standard electron tube circuits. Chapter 5 attacks transistor parameters from both the hybrid and T-equivalent viewpoints. A final chapter deals briefly with the advanced topics of modulation and transmission. Index included.

**Gillie, Angelo C. / Principles of Electron Devices / McGraw-Hill Book Co., Inc., 330 West 42 St., New York 36, N. Y. / 1962, printed, 576 pp, \$11.50**

This book was written for use in technical institutes, junior colleges, service schools, and industrial in-plant programs, for aid in developing technicians. The latest techniques for the design of new circuits as well as troubleshooting analysis of electronic problems are applied to design circuitry. In this text more than thirty-five control-device circuits have been designed for analysis and development. The book contains fifteen chapters which include the following: "Fundamentals of Nonlinear Resistive Control Devices," "Semiconductor Physics," "Junction Transistor Characteristics." An entire chapter is devoted to basic transistor and vacuum-tube logic circuits because of their increasing importance to modern industry. Hundreds of problems have been provided throughout the text. The book also presents practical applications as well as the theory of several relatively new devices including: Zener diode, tunnel diode, silicon controlled rectifier, unijunction transistor, and semiconductor photo-electric devices. Index included.

**Lindgren, B. W. / Statistical Theory / The Macmillan Co., 60 Fifth Ave., New York 11, N. Y. / 1962, printed, 427 pp, \$?**

This book is intended as a text for a year's course in present-day statistical theory that can be used and built upon (without having to be replaced) as the student progresses to later work. A first course in differential and integral calculus is a prerequisite. The author, Assistant Professor of Mathematics at the Inst. of Technology of the Univ. of Minnesota, expounds some modern statistical theory, together with the elements of the more "classical" theory. Chapters 1 through 4 provide a mathematical study of probability distribution, random variables, and independence, culminating in the Central Limit Theorem. Chapters 5 through 7 present the basic theory of statistical decision-making. The remaining chapters are: "Some Distribution Theory," "Some One-Sample Problems," "Comparisons," and "Linear Models and Analysis of Variance." Contains a short list of references, 15 appendix-tables, and answers to problems. Index.

**Arnold, B. H. / Logic and Boolean Algebra / Prentice-Hall, Inc., Englewood Cliffs, N. J. / 1962, printed, 144 pp, \$9.00**

The main purpose of the book is to develop the theory of Boolean algebras via the study of simpler algebraic systems. Chapter 3 begins this study with a simple case, partially ordered sets. Definitions are given for an arbitrary algebraic system and for an isomorphism between two such systems. Finite ordered sets are represented graphically. Chapter 8 presents a brief introduction to the uses of Boolean algebra in the design and analysis of switching circuits and computers. The other chapters are: "Some Concepts of Intuitive Logic," "Boolean Functions," "Lattices," "Boolean Algebras," "Boolean Rings," and "Normal Forms, Duality." There are problems at the end of each chapter. A short bibliography is included which lists references at all levels from freshman texts to current research papers. Index.

**Chace, William G., and Howard K. Moore, editors and 48 authors / Exploding Wires, Vol. 2 / Plenum Press, Inc., 227 West 17 St., New York 11, N. Y. / 1962, printed, 321 pp, \$10.50**

This volume contains the proceedings of the Second Conference on the Exploding

# DISCOURSE ON MAGNETIC LOGIC IS FREE

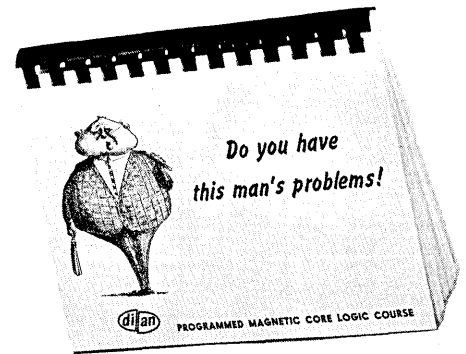

**Book Free — No Matriculation Fee**

**Registration will be held at  
SJCC, Booth No. 330 May 21,  
22, 23, Detroit, Michigan**

This flip-page programmed course on Magnetic Core Logic is yours for the asking. If you are unaware of how Magnetic Core Logic may help you in your systems problems, you cannot afford to miss this opportunity. A real bargain in a simplified, down-to-earth, unique approach.

A request on your company letterhead, in lieu of registration at SJCC, will hurry your copy on its way.

This offer is good while the supply lasts. (Matter of fact this is a good offer any time).

**Di/An Controls, Inc.**  
944 Dorchester Avenue, Boston  
25, Mass. • TEL: AV 8-7700  
TWX: 617-288-5963



Here is the smallest, least expensive way  
to generate standard non-linear functions...  
**THE DOUGLAS QUADRATRON®**

This unique, passive squaring element is normally used with analog operational DC amplifiers to generate many of the most useful non-linear functions. Included are the following:

- SQUARE      SQUARE ROOT
- MULTIPLICATION      SINE
- COSINE      TANGENT

Multi-function versatility is obtained entirely by variations in the external circuitry. Models are available with either axial leads or standard octal plug-in base.

**MODEL SPECIFICATIONS**

*For use with vacuum tube amplifiers*

- Type A, Model 100 (leads)
- Type P, Model E (plug)
- Input signal range  $\pm 100$  volts
- Maximum squaring error, 0.2 volts (.2% of 100 volt peak input).
- Current from driving source, 1.5 ma. typical

*For use with transistorized amplifiers*

- Type A, Model 10 (leads)
- Type P, Model F (plug)
- Input signal range  $\pm 10$  volts
- Maximum squaring error, 0.02 volts (.2% of 10 volt peak input).
- Current from driving source, 1.5 ma. typical

Douglas will supply complete details related to specific applications.



----- MAIL COUPON FOR FULL INFORMATION -----

Dept. G-76 A Douglas Aircraft Company  
3000 Ocean Park Boulevard, Santa Monica, California  
Please send me descriptive material relating to the QUADRATRON

NAME \_\_\_\_\_ TITLE \_\_\_\_\_  
COMPANY \_\_\_\_\_  
ADDRESS \_\_\_\_\_  
CITY \_\_\_\_\_ ZONE \_\_\_\_\_ STATE \_\_\_\_\_

Wire Phenomenon held at Boston, Mass., Nov. 13-15, 1961. This conference considered the subjects of: general theory of exploding wires; the generation by exploding wires of extreme temperatures, X-rays, and very high pressures; instrumentation problems in wire explosions; exploding foils. Among the papers included are: "Factors Affecting the Time to Burst in Exploding Wires," "Recent Contributions to the Macroscopic Analysis of Conducting Electro-mechanical Solids," "The Electrical and Optical Properties of Rapidly Exploded Wires," and "High-Speed Cinemicrographic Studies of Electrically Exploded Metal Films." A "Cumulative Subject Index" and a "Cumulative Author Index" for use with both volumes 1 and 2 are included.

Ford, L. R., Jr., and D. R. Fulkerson / **Flows in Networks / Princeton University Press, Princeton, N. J.; / 1962, printed, 194 pp, \$6.00**

People engaged in operations research, industrial and communications engineering or combinatorial mathematics are likely to enjoy this book which might have been titled, albeit too narrowly, "Transportation Problems." In it, the authors, a senior operations analyst with C-E-I-R, Inc., and a mathematician at the RAND Corporation respectively, present methods for dealing with problems having formulations in terms of flows in capacity-constrained networks.

The four chapters are, "Static Maximal Flow," "Feasibility Theorems and Combinatorial Applications," "Minimal Cost Flow Problems" and "Multi-terminal Maximal Flows." The authors have omitted the simplex method of solution. Index.

Smallwood, Richard D. / **A Decision Structure for Teaching Machines / The M.I.T. Press, Cambridge, Mass. / 1962, offset, 122 pp, \$4.00**

This extended research report, the fourteenth in the series of M.I.T. Press Research Monographs, describes in detail an artful decision structure which it is claimed, will enable a teaching machine 1) to adjust its presentation to the specific knowledge and capabilities of the individual student and 2) to improve its own teaching technique with experience. Preliminary experiments involving the use of the decision structure in actual teaching are recounted. A familiarity with probability theory will probably be a sufficient mathematical background for understanding most of this doctoral dissertation. There is a table of references and an index.

Overhage, Carl F. J., editor, and eight authors / **The Age of Electronics / McGraw-Hill Book Co., Inc., 330 W. 42 St., New York 36, N. Y. / 1962, printed, 218 pp, \$7.95**

This book was based on and evolved from the Lincoln Laboratory Decennial Lectures, 1961-1962, marking the tenth anniversary of the founding of the Lincoln Laboratory of the Massachusetts Institute of Technology. There are eight essays and an introductory chapter. The selection of the eight subjects for lectures emphasized "Topics close to our own pursuits [Lincoln Laboratory's] without too much concern for universal approbation of the balance of our choice." The subjects are as follows: "Maxwell, Hertz, and Lorentz"; "Communications"; "Radar"; "Electronic Computers and Scientific Research" (by S. M. Ulam); "Radio Astronomy and Radio Telescopes"; "Transistors"; "Masers"; and "Satellite Relays." References are listed at the end of each essay. The volume is amply illustrated and contains an index.

# PB

# 440

We'll be at the Spring Joint Computer Conference

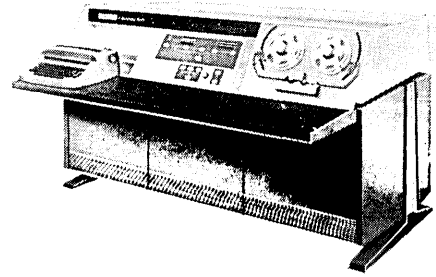

**"THE COMMON-LANGUAGE COMPUTER"**

## PACKARD BELL BREAKS THE COMPUTER LANGUAGE BARRIER

NOW—a small computer designed so that your programmer can create a command list to fit his particular problem. A program written with his commands will require less memory and take less machine time than one he would write if restricted to the single command list of conventional computers. Example: Our programmers created a command list especially for use in writing a scientific compiler. Object programs produced by the resultant FORTRAN II compiler require about half the memory and run far faster than corresponding programs for conventional computers.

**INTERCHANGEABLE PROGRAMS**—You can use your existing FORTRAN library on the latest high-speed hardware without reprogramming...run PB440 FORTRAN programs on other computers...even program the PB440 to utilize your existing machine language library.

The PB440 is a product of a new technology we call Dual Memory-Stored Logic. Its tremendous power can be applied to realtime systems, scientific/engineering problems, business data processing...wherever computers have an application.

The PB440 has an outstanding display console, can add in one microsecond, input-output at speeds to 800 kc, has program interrupt and many other brilliant features. Call or write today for complete data on the computer which is establishing a new plateau in the technology.

### Condensed Specifications

#### DUAL MEMORY

Main Memory: Size.....	4096 words expandable to 28,672
Speed.....	.5 microseconds cycle time
Word Length.....	24 bits single precision
	36 bits expanded precision
	48 bits double precision
Logic Memory: Size.....	256 words expandable to 4,096
Speed.....	1 microsecond read time

**INPUT-OUTPUT**—Typewriter, and choice of paper tape, cards, line printer, magnetic tape.

System input-output transfer rates 140,000 words per second.  
400,000 characters per second (optional 800,000 characters per second).

#### EXECUTION TIMES (24 bit fixed point operands)

add .....	1 to 11 microseconds
subtract .....	3 to 13 microseconds
multiply .....	25 to 33 microseconds
divide .....	47 to 57 microseconds

FOR FULL INFORMATION ON THE PB440 WRITE FOR DATA FILE NO. C11-9

**pb Packard Bell Computer**

1905 ARMACOST AVENUE, LOS ANGELES 25, CALIFORNIA  
A Division of Packard Bell Electronics

## MANUSCRIPTS

WE ARE interested in articles, papers, reference information, and discussion relating to computers and automation. To be considered for any particular issue, the manuscript should be in our hands by the first of the preceding month.

**ARTICLES:** We desire to publish articles that are factual, useful, understandable, and interesting to many kinds of people engaged in one part or another of the field of computers and automation. In this audience are many people who have expert knowledge of some part of the field, but who are laymen in other parts of it.

Consequently, a writer should seek to explain his subject, and show its context and significance. He should define unfamiliar terms, or use them in a way that makes their meaning unmistakable. He should identify unfamiliar persons with a few words. He should use examples, details, comparisons, analogies, etc., whenever they may help readers to understand a difficult point. He should give data supporting his argument and evidence for his assertions.

We look particularly for articles that explore ideas in the field of computers and automation, and their applications and implications. An article may certainly be controversial if the subject is discussed reasonably. Ordinarily, the length should be 1000 to 3000 words. A suggestion for an article should be submitted to us before too much work is done.

**TECHNICAL PAPERS:** Many of the foregoing requirements for articles do not necessarily apply to technical papers. Undefined technical terms, unfamiliar assumptions, mathematics, circuit diagrams, etc., may be entirely appropriate. Topics interesting probably to only a few people are generally not acceptable.

**REFERENCE INFORMATION:** We desire to print or reprint reference information: lists, rosters, abstracts, bibliographies, etc., of use to computer people. We are interested in making arrangements for systematic publication from time to time of such information, with other people besides our own staff. Anyone who would like to take the responsibility for a type of reference information should write us.

**NEWS AND DISCUSSION:** We desire to print news, brief discussions, arguments, announcements, letters, etc., anything, in fact, if it is likely to be of substantial interest to computer people.

**PAYMENTS:** In many cases, we make small token payments for articles, if the author wishes to be paid. The rate is ordinarily  $\frac{1}{2}$ ¢ a word, the maximum is \$15, and both depend on length in words, whether printed before, etc.

All suggestions, manuscripts, and inquiries about editorial material should be addressed to: *The Editor*, COMPUTERS and AUTOMATION, 815 Washington Street, Newtonville 60, Mass.

## NEW PATENTS

RAYMOND R. SKOLNICK

Reg. Patent Agent

Ford Inst. Co., Div. of Sperry Rand Corp., Long Island City 1, New York

The following is a compilation of patents pertaining to computer and associated equipment from the "Official Gazette of the U. S. Patent Office," dates of issue as indicated. Each entry consists of patent number / inventor(s) / assignee / invention. Printed copies of patents may be obtained from the U. S. Commissioner of Patents, Washington 25, D. C., at a cost of 25 cents each.

### February 12, 1963 (Continued)

- 3,077,583 / Louis Allen Russell, Poughkeepsie, N. Y. / I.B.M. Corp., New York, N. Y., a corp. of N. Y. / Magnetic Core Flux Steering Device.  
3,077,584 / Andrew H. Eschenfelder, Poughkeepsie, N. Y. / I.B.M. Corp., New York, N. Y., a corp. of N. Y. / Magnetic Memory Technique.  
3,077,586 / Norman C. Ford, Jr., Poughkeepsie, N. Y. / I.B.M. Corp., New York, N. Y., a corp. of N. Y. / Magnetic Storage Device.  
3,077,589 / Robert E. Loudon, Los Angeles, Calif. / Clary Corp., San Gabriel, Calif., a corp. of Calif. / Read-Out System.

### February 19, 1963

- 3,078,445 / Andrew R. Sass, Rego Park, N. Y. / Radio Corp. of America, a corp. of Delaware / Information Storage.  
3,078,446 / Sonia Francey, Champigny-Seine, and Jacques Albin, Viroflay-Seine-et-Oise, France / I.B.M. Corp., New York, N. Y., a corp. of N. Y. / Transfer Circuit Employing Magnetic Cores.  
3,078,447 / Raymond W. Ketchledge, Whippany, N. J. / Bell Telephone Labs., Inc., New York, N. Y., a corp. of New York / Coincident Flux Memory Device.

### February 26, 1963

- 3,079,590 / James D. Confeld, Rochester, N. Y., and Robert K. Kaye, Medford Lakes, N. J. / General Dynamics Corp., Rochester, N. Y., a corp. of Delaware / Data Handling System.  
3,079,591 / John R. Anderson, Los Altos, Calif. / The National Cash Register Co., Dayton, Ohio, a corp. of Maryland / Memory Devices.  
3,079,592 / Smil Ruhman, Waltham, Mass. / Raytheon Co., Lexington, Mass., a corp. of Delaware / Magnetic Computing.

### March 5, 1963

- 3,080,548 / Glenn E. Hagen, Southfield, Mass., and Joseph Allan Beck, Jr., Rolling Hills, Calif. / Alwac International,

## COMPUTER BRAGGADOCIO

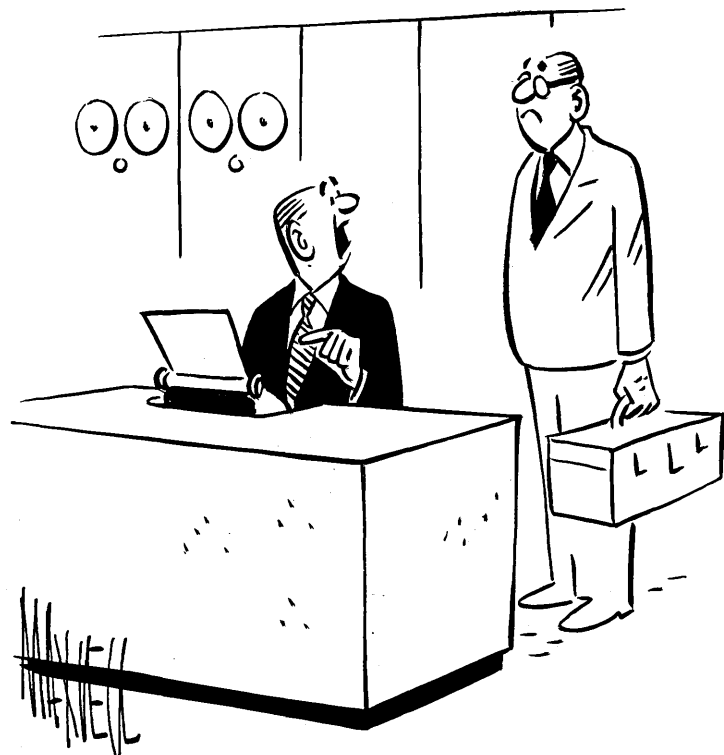

"Actually it's a small thing . . . it prints exclamation marks after all its answers."



Lots of people could link your computers

(but it takes  
a rare talent  
to marry them)

A hybrid worth its salt — with real power, efficiency, and flexibility — should include more than mere side-by-side operation of your digital and analog machines. It should have the touch of Adage expertise in system integration. □ Call on us to help build your hybrid facility. We provide unbeatable hardware (all of it) . . . experience second to none . . . a design inventiveness demonstrated again and again. □ Dubious? Ask the people at Grumman Aircraft. Or McDonnell Automation Center. Or Digital Equipment Corporation. Computers we've worked with over the years include the REAC 400, IBM 7090, EA231, PDP-1 and UNIVAC 1218 . . . to name-drop a few. □ Write today for detailed information. Better yet, call I. R. Schwartz, Sales Manager.

*Adage*  
INC

292 Main St., Cambridge, Mass.

1145 East Ash Ave., Fullerton, Cal.

*Adage, Inc. welcomes employment inquiries from professional engineers.*

**FOR SALE** — 704, 705, 1401, RRS-80, 650, 416, Burroughs 205, LGP-30, Friden CTS/STR 8 Channel, 604-521, 514,523,024,056.

**WANTED** — 1401 A-3 B-3, 077, 087,089.

BUY or SELL used DP equipment, KP's through computers, in confidence through

**DATA PROCESSING  
EQUIPMENT EXCHANGE CO.**  
**Nicholas H. Dosker, Jr., Manager**  
**366 Francis Building**  
**Louisville, Kentucky**  
**GL 1-7457      JU 5-5454**

Nassau, Bahamas, a corp. of Panama / Computer Memory Section Selection System.

3,080,550 / Friedrich Kuhrt, Nurnberg, Germany / Siemens-Schuckertwerke Aktiengesellschaft, Berlin-Siemensstadt, Germany, a corp. of Germany / Magnetic Data Processing Apparatus.

3,080,552 / Nils Gustaf Erik Stemme, Nasbypark, and Sven Erik Wahlström Enskede, Sweden / Aktiebolaget Atvidabergs Industrier, Atvidaberg, Sweden, a joint-stock company of Sweden / Memory Device.

#### March 12, 1963

3,081,032 / Roy A. Keir, Inglewood, and Jesse T. Quatse, Los Angeles, Calif. / Bendix Corp., a corp. of Delaware / Parallel Digital Adder System.

3,081,407 / William G. Hall, Morris Township, Morris Co., N. J. / Bell Telephone Labs., Inc., New York, N. Y., a corp. of N. Y. / Unanimity Memory Circuit Utilizing Transistor Resistor Logic Means.

3,081,445 / Edward Rogal, North Scituate, Mass. / Universal Controls, Inc., New York, N. Y., a corp. of Maryland / Automatic Data Sorting Devices.

3,081,447 / Hugh M. Sierra, Santa Clara, Calif. / I.B.M. Corp., New York, N. Y., a corp. of New York / Apparatus and Methods for Automatic Indexing and Storage.

3,081,448 / Esmond Philip Goodwin Wright, Desmond Sydney Ridler, and Wincenty Bezdell, London, England / International Standard Electric Corp., New York, N. Y. / Intelligence Storage Equipment.

3,081,453 / David Nitzan, Palo Alto, Calif. / AMP Inc., Harrisburg, Pa., a corp. of New Jersey / Magnetic-Core Decoding Circuit.

#### March 19, 1963

3,082,403 / Sheldon D. Silliman, Forest Hills, and Willard A. Derr, Pittsburgh,

Pa. / Westinghouse Electric Corp., East Pittsburgh, Pa., a corp. of Pennsylvania / Binary Self-Checking Supervisory Control System.

3,082,404 / Harry Kihn, Lawrenceville, N. J., and William E. Barnette, Levittown, Pa. / Radio Corp. of America, a corp. of Delaware / Decoder Circuits.

3,082,406 / Louis D. Stevens, San Jose, Calif. / I.B.M. Corp., New York, N. Y., a corp. of N. Y. / Decoding Device.

3,082,407 / Edward E. Warnick and Rudolf van den Berge, Rochester, N. Y. / Eastman Kodak Co., Rochester, N. Y., a corp. of New Jersey / Device for Transferring Digital Data from a Medium to a Recording Device.

#### March 26, 1963

3,083,352 / Robert C. Kelner, Concord, Mass. / Laboratory for Electronics, Inc., Boston, Mass., a corp. of Delaware / Magnetic Shift Register.

3,083,353 / Andrew H. Bobeck, Chatham, N. J. / Bell Telephone Laboratories, Inc., New York, N. Y., a corp. of New York / Magnetic Memory Devices.

3,083,354 / Lorenz Hanewinkel, Neukirchen, Germany / Zuse KG, Neukirchen, Germany / Information Storage Device.

3,083,355 / Douglas C. Engelbart, Palo Alto, Calif. / Stanford Research Institute, Palo Alto, Calif., a corp. of Calif. / Magnetic Logic Device.

3,083,356 / Frank A. Morris, Fishers, N. Y. / General Dynamics Corp., Rochester, N. Y., a corp. of Delaware / Data Transmitting and Recording System.

## ADVERTISING INDEX

Following is the index of advertisements. Each item contains: Name and address of the advertiser / page number where the advertisement appears / name of agency if any.

Adage, Inc., 292 Main St., Cambridge, Mass. / Page 65 / Quinn & Johnson Advertising, Inc.

American Telephone & Telegraph Co., 195 Broadway, New York 7, N. Y. / Page 2 / N. W. Ayer & Son, Inc.

Ampex Corporation, 934 Charter St., Redwood City, Calif. / Page 8 / Cunningham & Walsh, Inc.

Bellcomm, Inc., 1100 17th St., N. W., Washington 6, D. C. / Page 67 / N. W. Ayer & Son, Inc.

Benson-Lehner Corp., 1476 Califa St., Van Nuys, Calif. / Page 11 / Studio Artists, Inc.

Career Center, 770 Lexington Ave., New York 21, N. Y. / Between Pages 6 & 7 / Mohr & Eicoff, Inc.

Comcor, Inc., 430 S. Navajo, Denver 4, Colo. / Page 13 / Marshall Robertson Advertising Agency

Computer Control Co., Inc., Old Connecticut Path, Framingham, Mass. / Page 6 / de Garmo-Boston, Inc.

Data Processing Equipment Exchange Co., 366 Francis Building, Louisville 2, Ky. / Page 66 / —

DI/AN Controls, 944 Dorchester Ave., Boston 25, Mass. / Page 61 / Larcom Randall Advertising, Inc.

Douglas Aircraft Co., Inc., 3000 Ocean Park Blvd., Santa Monica, Calif. / Page 62 / J. Walter Thompson Co.

Drake Manufacturing Co., Inc., 4624 N. Olcott Ave., Chicago 31, Ill. / Page 40 / Armstrong Advertising Agency, Inc.

Herbert Halbrecht Associates, Inc., 332 So. Michigan Ave., Chicago 4, Ill. / Page 3 / J. D. Culea Advertising, Inc.

International Business Machines Corp., 590 Madison Ave., New York 22, N. Y. / Page 31 / Benton & Bowles, Inc.

International Business Machines Corp., Box 390, Poughkeepsie, N. Y. / Page 57 / Benton & Bowles, Inc.

LFE Electronics, Inc., 305 Webster St., Monterey, Calif. / Page 37 / Fred L. Diefendorf Agency

Litton Systems, Inc., Guidance & Control Systems Div., 5500 Canoga Ave., Woodland Hills, Calif. / Page 35 / Ellington & Co.

National Cash Register Co., Main & K Sts., Dayton 9, Ohio / Page 12 / McCann-Erickson, Inc.

Navigation Computer Corp., 932 Rittenhouse Rd., Valley Forge Industrial Park, Norristown, Pa. / Page 41 / The Roland G. E. Ullman Organization

Packard Bell Computer Corp., 1905 Armacost Ave., W. Los Angeles, Calif. / Page 63 / Anderson-McConnell Advertising Agency, Inc.

Photocircuits Corporation, Glen Cove, N. Y. / Page 17 / Duncan-Brooks, Inc.

Potter Instrument Co., Inc., E. Bethpage Rd., Plainview, N. Y. / Page 4 / Gamut, Inc.

Reeves Soundcraft Corp., Great Pasture Rd., Danbury, Conn. / Page 23 / The Wexton Co., Inc.

Technical Operations, Inc., 3600 M St., N. W., Washington, D. C. / Page 21 / Edwin F. Hall

Valley Consultants, Inc., 716 York Rd., Towson 4, Md. / Page 57 / George C. Ruehl, Jr.

Washington Aluminum Co., Panel Products Div., Baltimore 29, Md. / Page 38 / Azrael Advertising Co.

John Wiley & Sons, Inc., 605 Third Ave., New York 16, N. Y. / Page 39 / Needham & Grohmann, Inc.



LITTLE BY LITTLE, SPACE IS YIELDING its mysteries to man's inspection... the previously unknown is becoming knowledge to help attack further unknowns. ● One important attack is NASA's manned space flight program leading to exploration of the moon. Bellcomm was formed by the Bell Telephone System to carry out systems planning and evaluation for this exciting effort. ● This new company offers fine opportunities to experienced men in such fields as computing and programming, physics, mathematics, engineering, man-machine relationships, aerodynamics and aeronautical engineering. ● The work is creative, the staff is highly professional, and the location is stimulating. Bellcomm, an equal opportunity employer, works in Washington, D. C. Interested? Bellcomm will give your résumé prompt and thoughtful study. It should be sent to Mr. W. W. Braunwarth, Personnel Director, Bellcomm, Inc., Room 1100U, 1100 17th Street, N. W., Washington 6, D. C. <sup>D-44</sup>



**BELLCOMM, INC.**

A Bell Telephone System Company

