

~~LIBRARY~~

**computers**  
and  
**automation**



Computers and  
Political Strategy

Data Processing  
as a Universal  
Approach  
to Cataloging  
Parts

City Traffic  
Simulated by  
Computer

---

1962 Spring  
Joint Computer  
Conference

MAY  
1962

Vol. XI — No. 5



EVER  
HEAR  
OF  
**SUPER-PHONIC**  
SPEED?

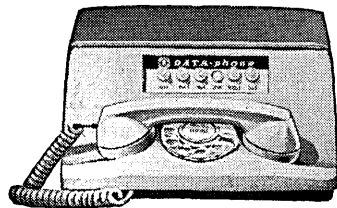

It's not in your dictionary—but it could be someday.

*"Super-ponic" describes the speed with which business machines can "talk" data over telephone lines when Bell System DATA-PHONE service is used.*

At this speed, you could transmit every word on the front page of the *Wall Street Journal* coast to coast in two minutes, 20 seconds!

It means you can send payroll or production figures, inventories or sales orders anywhere they are needed in a small fraction of the time it takes you now.

And for all its *super-ponic* speed, new DATA-PHONE service costs no more per data call than you pay for a regular telephone call.

Let one of our Communications Consultants *show you* how DATA-PHONE service can help you speed up your data handling, reduce your costs and bolster your profits.

Just call your nearest Bell Telephone Business Office and ask for him. There's no obligation, of course.



**BELL TELEPHONE SYSTEM**

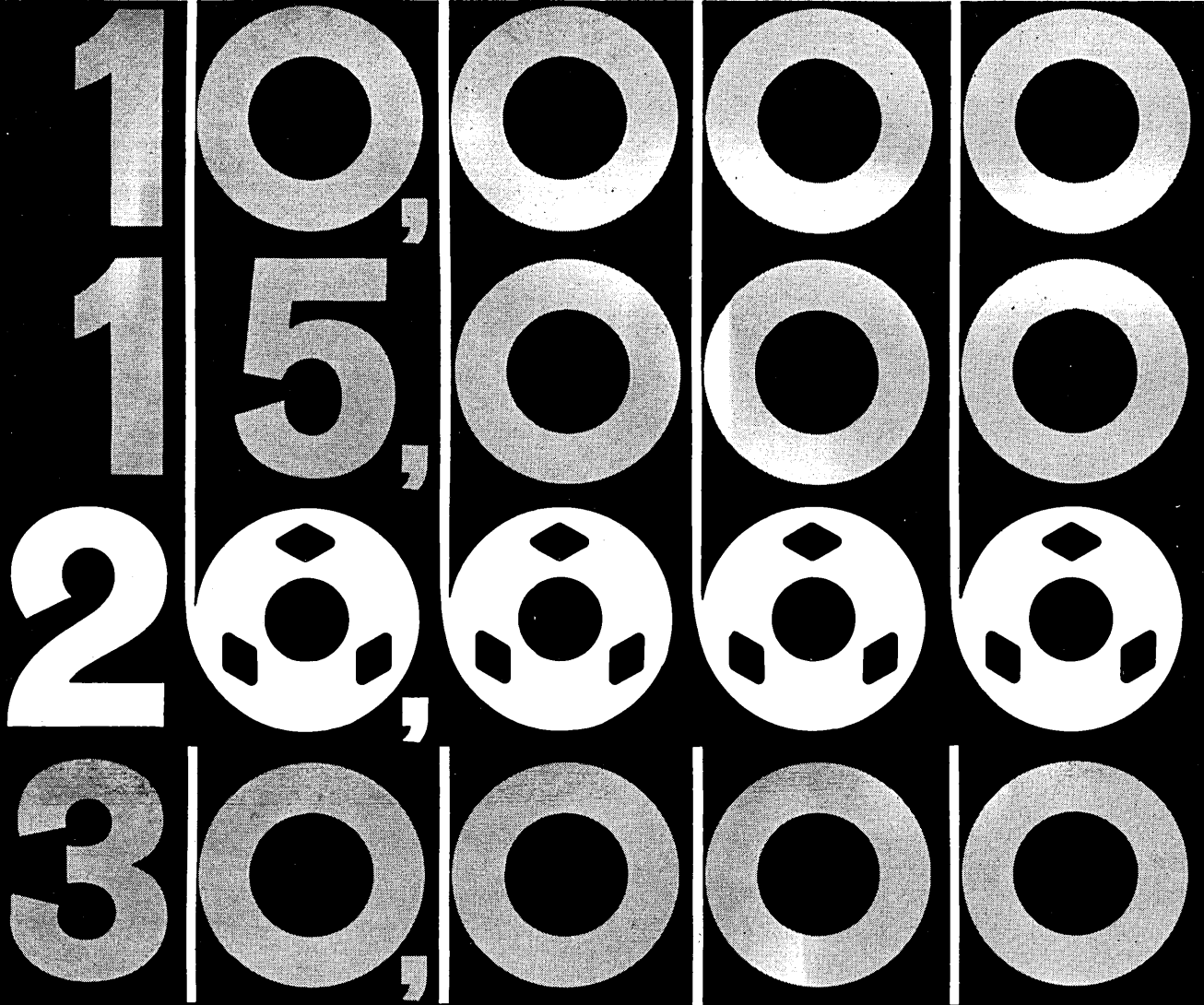

**PASSES**

**NEW: A LONGER LASTING COMPUTER TAPE!**

**SOUNDCRAFT TYPE LWD HEAVY DUTY/HIGH DENSITY**

Longer life, flawless performance! These are the advantages of Soundcraft LWD heavy duty/high density tape—the most advanced computer tape available today! In specific tests, Soundcraft new LWD achieved more than 20,000 passes across recording heads with absolutely no sign of breakdown. Heretofore, 15,000 passes had been considered maximum for a heavy duty magnetic recording tape. Soundcraft combines a unique binder system with Mylar\*base, producing superior adhesion and cohesion. Result: a heavy duty tape with blemish-free oxide coating, superior surface characteristics and a pulse packing capability that exceeds the requirements of all existing computer systems. Furthermore, Soundcraft LWD more closely approaches the ideal hysteresis curve than any competitive computer tape. Its improved square BH characteristic makes the computer system less susceptible to non-repetitive errors. For an LWD "confidence—level" test in your system, write:



**NEEVES SOUNDCRAFT CORP.**  
 Main Office: Great Pasture Road, Danbury, Connecticut • New York: 10 East 52nd St.  
 Chicago: 28 E. Jackson Blvd. • Los Angeles: 342 N. LaBrea • Toronto: 700 Weston Rd.

\*DUPONT T.M.

each  
by  
ce  
and  
ter  
ory  
oint.

ion  
nute,  
to  
he  
tory

S

ter  
n-  
lec-  
Cal-  
e  
il-  
ng

ces-  
sing  
ac-  
n-  
one

Ser-

uter,  
ired  
ur-

agnet-  
h as-  
have  
n  
444  
e  
re

s  
ut

sts  
ble.



NEW GROWTH AND NEW DEVELOPMENTS CALL FOR A NEW MARK!



To symbolize the many new systems, services and products which THE NATIONAL CASH REGISTER COMPANY offers businesses everywhere, we have adopted a new business mark...



*New mark of The National Cash Register Company, dedicated to providing the finest in total systems . . . from original entry to final report—through NCR accounting machines, cash registers, adding machines and electronic data processing. 1,039 offices in 121 countries—78 years of helping business save money.*

**NEW FROM NCR—"TOTAL SYSTEMS" TO SERVE YOU BETTER.** New technological developments now enable NCR to serve business faster, more efficiently than ever before with "Total Systems."

An NCR cash register in a retail store . . . an NCR accounting machine in an office or bank . . . NCR adding machines wherever figures are handled—all can provide media that flows to NCR electronic data processing systems.

Today you'll find NCR Data Processing Centers in certain major cities . . . which represent the beginning of a nationwide network.

**NEW FROM NCR—NEW DEVELOPMENTS IN HIGH SPEED COMPUTER SYSTEMS.** The unique Card Random Access Memory ("CRAM") developed for the NCR 315 computer stores more than 5 million characters of information on plastic cards.

The versatile NCR 390 and NCR 310 computers bring electronics to thousands of businesses of all kinds.

NCR's new optical reading system, which permits direct processing of printed data without first converting it to a machine language, will create revolutionary advances in handling records.

**NEW FROM NCR—NEW PRODUCTS FROM RESEARCH AND DEVELOPMENT.** More than 2,000 people are working at NCR on many new and important projects.

Encapsulation—the method by which liquids or solids can be enclosed in microscopic capsules—holds the promise of tasteless castor oil, "dry gasoline," more stable rocket fuels, and many other things.

Other dramatic developments are a new NCR "rod memory" that switches in billionths of a second, and new photochromic data-storage techniques based on color changes which occur under varying wave lengths of light.

puter  
a gro  
Weather  
aid i  
hurri  
gists  
are u  
225 c  
of th  
Their  
cal m  
more

fly t  
lect  
on th  
day.  
on ma  
of th  
taken  
place  
of pr

search  
Congr  
group  
Facil  
spons  
colle

AN

New Y  
Gear,  
oped  
ing t  
on th

air i  
son a  
into  
are f  
purpo  
puter  
cial  
which  
cells  
durin  
This  
a mea  
respi  
and t  
of th  
ous d

have  
ation

COM

# COMPUTERS and AUTOMATION

COMPUTERS AND DATA PROCESSORS, AND THEIR CONSTRUCTION,  
APPLICATIONS, AND IMPLICATIONS, INCLUDING AUTOMATION

Volume XI  
Number 5

MAY, 1962

Established  
September 1951

EDMUND C. BERKELEY *Editor*  
PATRICK J. MCGOVERN *Assistant Editor*  
MOSES M. BERLIN *Assistant Editor*  
NEIL D. MACDONALD *Assistant Editor*  
ANN B. BAKER *Production Manager*

## CONTRIBUTING EDITORS

ANDREW D. BOOTH  
NED CHAPIN  
JOHN W. CARR, III  
ALSTON S. HOUSEHOLDER  
PETER KUGEL

## ADVISORY COMMITTEE

MORTON M. ASTRAHAN  
HOWARD T. ENGSTROM  
GEORGE E. FORSYTHE  
RICHARD W. HAMMING  
ALSTON S. HOUSEHOLDER  
HERBERT F. MITCHELL, JR.

## SALES AND SERVICE DIRECTOR

PATRICK J. MCGOVERN  
815 Washington St.  
Newtonville 60, Mass.  
DEcatur 2-5453

## ADVERTISING REPRESENTATIVES

*Los Angeles 5* WENTWORTH F. GREEN  
439 So. Western Ave. DUnkirk 7-8135  
*San Francisco 5* A. S. BABCOCK  
605 Market St. YUkon 2-3954  
*Elsewhere* PATRICK J. MCGOVERN  
815 Washington St. DEcatur 2-5453  
Newtonville 60, Mass.

COMPUTERS and AUTOMATION is published monthly at  
815 Washington St., Newtonville 60, Mass., by Berkeley Enter-  
prises, Inc. Printed in U.S.A.

SUBSCRIPTION RATES: United States, \$15.00 for 1 year,  
\$29.00 for 2 years, including the June Directory issue; Canada,  
add 50c a year for postage; foreign, add \$1.50 a year for post-  
age. Address all Editorial and Subscription Mail to Berkeley  
Enterprises, Inc., 815 Washington St., Newtonville 60, Mass.

ENTERED AS SECOND CLASS MATTER at the Post Office  
at Boston, Mass.

POSTMASTER: Please send all Forms 3579 to Berkeley Enter-  
prises, Inc., 815 Washington St., Newtonville 60, Mass.

Copyright, 1962, by Berkeley Enterprises, Inc.

CHANGE OF ADDRESS: If your address changes, please send us  
both your new address and your old address (as it appears on the  
magazine address imprint), and allow three weeks for the change  
to be made.

## 1962 SPRING JOINT COMPUTER CONFERENCE

List of Exhibitors. . . . .	27
Locations of Exhibit Areas. . . . .	28
Program . . . . .	29

## FRONT COVER

Mountain-Edge Diffraction for Computer Communications . . . . .	1, 6
--	------

## ARTICLES

Data Processing as a Universal Approach to Cataloging Parts, by P. F. SANTARELLI. . . . .	12
Computers and Political Strategy, by PETER KUGEL . . . . .	17
City Traffic Simulated by Computer, by NATIONAL BUREAU OF STANDARDS . . . . .	23

## READERS' AND EDITORS' FORUM

What is "Computers and Automation", and What Does It Try to Do? . . . . .	6
Reader's Reply Label . . . . .	6
Computers and World Peace . . . . .	44
Calendar of Coming Events . . . . .	60

## ACROSS THE EDITOR'S DESK . . . . .

New Installations . . . . .	46
New Firms, Divisions, and Mergers . . . . .	48
Publications . . . . .	50
Teaching Machines . . . . .	50
People of Note . . . . .	50
Automation . . . . .	52
New Products . . . . .	53
New Contracts . . . . .	58
New Applications . . . . .	61

## INDEX OF NOTICES

Advertising Index . . . . .	60
Computer Directory and Buyers' Guide . . . . .	see Mar., page 24
Glossary of Computer Terms . . . . .	see Mar., page 24
Manuscripts . . . . .	see Mar., page 18
Reference and Survey Information . . . . .	see Mar., page 24
Who's Who Entry Form . . . . .	22

# Readers' and Editors' Forum

## FRONT COVER: MOUNTAIN-EDGE DIFFRACTION FOR COMPUTER COMMUNICATIONS

The front cover shows a ten-foot microwave antenna which implements — and a schematic model which illustrates — a new experimental technique for transmitting data over the horizon at high speeds without using relay stations.

Computer data is being transmitted over a mountain edge, using a technique called "knife-edge diffraction", at speeds as high as 500,000 bits of information per second, with power as low as 16 watts. These experiments are being conducted at IBM Corp., San Jose, Calif.; the path of experimental transmission lies between a transmitter at Monterey and a receiver at San Jose 45 miles distant. Both are focused directly at the Loma Prieta Ridge, 3800 feet high, in the Santa Cruz mountains. One of the reasons for the success of the experiments is a novel frequency-modulation feedback loop incorporated in the microwave equipment, which was developed and manufactured by the Nippon Electric Company, Tokyo, Japan.

## WHAT IS "COMPUTERS AND AUTOMATION", AND WHAT DOES IT TRY TO DO?

3000 copies of this issue, Vol. X1, No. 5, of "Computers and Automation" are being distributed to persons attending the Spring Joint Computer Conference, San Francisco, May 1 to 3.

We greet you in this way.

To many of you, perhaps, this is the first issue of "Computers and Automation" you have seen. So we should like to say who we are and what we are trying to do.

This magazine is the first one published in the computer field. Our first issue, consisting of seven purple ditto pages and entitled "Roster of Organizations in the Computer Field", was distributed in September, 1951. Since that time, we have become a magazine publishing over 700 pages annually.

Our goal is "to publish information which is factual, useful, and understandable, about computers and data processors, and their construction, applications, and implications, including automation." We want to be of help to people in

the field of computers and data processors to the extent that we can. That impulse stirred our editor, Edmund C. Berkeley, when he helped found — and was the first secretary of — the Association for Computing Machinery (his tenure was 1947-53). That impulse has always motivated "Computers and Automation".

We publish articles, reference information, news, pictures, discussion, argument, etc. Magazine departments include: Across the Editor's Desk (news); Readers' and Editors' Forum (discussion, etc.); Books and Other Publications; New Patents; Who's Who in the Computer Field (supplements); etc. Special or extra issues include: Glossary of Terms in Computers and Data Processing; Who's Who in the Computer Field (cumulative); and the Computer Directory and Buyers' Guide (the regular June issue). An annual index is published in the January issue each year; the 1961 index published January, 1962, contained over 1100 entries by subject, author, and title.

In the last six months we have published groups of articles on the following subjects:

Computers, Teaching Machines, and Programmed Learning (Feb., 1962), 18 pp  
Annual Pictorial Report on the Computer Field (Dec., 1961), 41 pp  
The ABC's of Computers (April, 1962), 17 pp  
Computers and War Safety Control (January, 1962), 14 pp  
Some Novel Applications of Computers (March, 1962), 9 pp

Whether or not you are a subscriber, if you think that any of the material that we publish or might have published in our magazine can be useful to you in the work that you do in the computer field, please drop us a line on your letterhead or on a postcard, telling us what you would like, and let us see if we can help you. We'd like to if we can. Write to:

Neil Macdonald, Readers' Editor  
Computers and Automation  
815 Washington St.,  
Newtonville 60, Mass.

(And if you have no stamp handy, use the business reply label on page 26.)

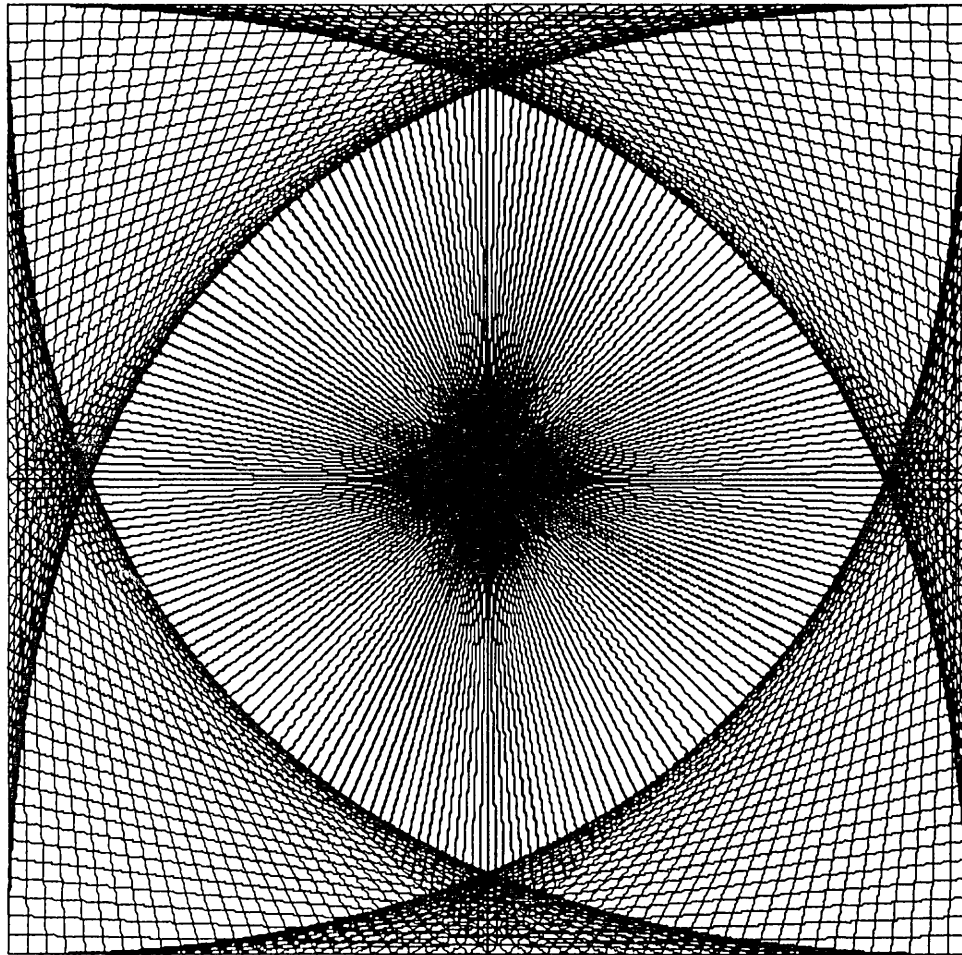

## try this on a \$60,000 plotter

THIS COMPUTER-CONTROLLED PATTERN IS USED TO TEST EACH CALCOMP DIGITAL INCREMENTAL PLOTTER. CALCOMP PLOTTERS AND PLOTTER SYSTEMS RANGE IN PRICE FROM \$3,300 TO \$11,500 FOR ON-LINE APPLICATION AND FROM \$24,500 TO \$39,200 FOR OFF-LINE APPLICATION.

CALCOMP equipment provides an unrivaled combination of economy, speed, accuracy and broad spectrum of flexibility. Compatible on-line with any digital computer, and off-line with any digital computer using the IBM, Remington Rand, or Honeywell tape format. Provides high-speed plotting in 1/100 inch increments at speeds of 200 and 300 steps per second. Requires only one setup for continuous production. Easily operated by relatively unskilled personnel.

*Write for complete data or demonstration.*

### CALCOMP SALES REPRESENTATIVES

**Boston** • Brogan Associates, 2300 Washington St. (Zone 62) ■ **Dallas** • Forsyth Sales Company, Box 637, Garland  
**Detroit** • K-R Engineering Services, 13612 Fenkell ■ **Houston** • Computer Laboratories, Inc., 6001 Gulf Freeway  
**Milwaukee** • Arthur Engineering Sales Co., 11216 West Mallory Avenue, Hales Corners, Wisconsin  
**New York** • Brogan Associates, 220 Jericho Turnpike, Mineola, New York — 102 Forest Way, Camillus, New York  
**Philadelphia** • Brogan Associates, P.O. Box 781, Levittown, New Jersey  
**San Francisco** • Calma Company, 5546 Amby Drive, San Jose, California  
**St. Paul** • Justin W. Moen, 3264 N. Victoria Ave. ■ **Washington, D.C.** • Gregory M. Bell, Jr., 927 15th Street, N.W.



**CALIFORNIA COMPUTER PRODUCTS, INC.**  
8714 CLETA STREET • DOWNEY, CALIFORNIA  
*See a demonstration at Booth 417-418, Spring Joint Computer Conference*

TS

ATION

, Sil-  
n  
ional  
gate  
nical  
lary  
em to  
er.

phase,  
lents  
cript-  
s  
in  
loyed  
on.  
ts  
in  
l be  
The  
or

iego  
king  
ver-  
west  
re-  
c are  
con-

cted  
em  
Vec-  
as an  
eme-  
lo-  
ly  
,  
r  
to  
rmat  
air

MENT

ion,  
an  
mag-  
Vet-  
this  
it  
of  
ne

als  
pro-

962

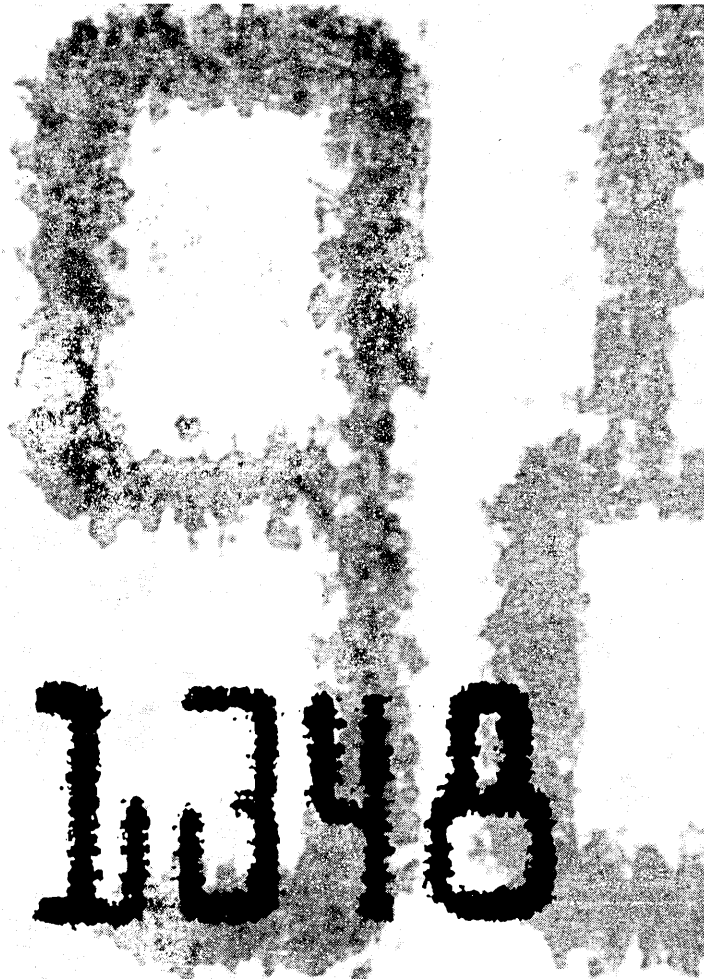

70000070670  
 3012201222114  
 6724508886008  
 8045705800002  
 3402670047800  
 5055079960700  
 2450040505220  
 5007475057470  
 9866505770888  
 6443006660024  
 3560056624040  
 3408888620483  
 6780060606060  
 3778000040099  
 1300020060653  
 7256006500542  
 3367000406727  
 5666800070858  
 7543210012300  
 7650087603211  
 7605032111085  
 1336745707675  
 6425058727302  
 2560205626060  
 2560772465015  
 7772603337044  
 3500445520440  
 3506516036080  
 7327706056653  
 5423676606740  
 8654565434567  
 8631688501467  
 5421277579049  
 5455885500024  
 8765432456786  
 5780586072903  
 6736731582732  
 6846685848998  
 1234567898765  
 9876543212345  
 2360840633444  
 5796447896447  
 4059930369064  
 8086868048099  
 5685793697568

2 3 4 5 6 7 8 9 0 4 1  
 3 4 6 7 8 9 0 1 2

## Data processing design problem: FOOLPROOF FIGURES

Thanks to the figures above, designed by the NCR Electronics Division, computer systems can now read "on sight" the printed output of cash registers and business machines. As a result, data processing systems have a key to greater speed, efficiency and economy.

A unique double code within the figures eliminates the problem of incorrect readings. This code, by making the characters self-checking, also permits important reductions in the cost and complexity of the reading equipment. Even though ink splotches, skew and weak print conspire constantly to "fool" the system, infallible recognition is now possible with relatively simple equipment — at laboratory speeds to 11,000 characters per second!

### CAREERS NOW OPEN IN THESE AREAS:

- SYSTEMS EVALUATION  TRANSISTOR CIRCUITRY
- SYSTEMS ENGINEERING  SYSTEMS TEST ENGINEERING
- PRODUCT ENGINEERING  PRODUCT DESIGN ENGINEERING  PROGRAMMING

Please send resume to Norval E. Powell, Director of Industrial Relations. Interviews may be arranged for the Spring Joint Computer Conference in San Francisco, May 1-3.



The National Cash Register Company  
ELECTRONICS DIVISION  
1401 E. El Segundo Blvd., Hawthorne (Los Angeles), Calif./Phone PL 7-1811

netic  
id c  
cord  
lint  
part  
tape

tirel  
any v  
tape  
as a  
sions

NEW

the A  
Data-  
contr  
comp  
rate

digit  
such  
furth  
to di  
The c  
and h  
signe  
quent

logi  
by th

ic, c  
brea  
shot  
pers  
has e

COM



# Why we believe the Tally Mark 50 introduces the Second Generation in Data Communications

Briefly, this is why: Tally's Mark 50 series is the only complete equipment ready now for *parallel* Bell System DATA-PHONE Service.

A little backtracking here may be enlightening before we tell you about the Mark 50.

During the past year, a number of perforated tape communications systems designed to operate computers and other data handling equipment in combination with Bell DATA-PHONE Service have been introduced. All of them, including our own, suffered from the basic disadvantages inherent in the serial mode of operation.

The serial system has two major weaknesses. One, the equipment is highly susceptible to bit dropout and bit insertion caused by switching transient generated noise. Two, high equipment requirements for serializing, character indexing, character recognition, and character re-assembly.

New *parallel* DATA-PHONE Service completely eliminates all of these problems. In the parallel system, character condition is present for several cycles because of the 13 millisecond time interval between characters. Consequently, high network noise rejection. Parallel operation also means lowered business machine hardware requirements coupled with a modest increase in telephone company equipment. The result: A major cost reduction with a simultaneous increase in accuracy, and—a second dimension in communications.

## About the Mark 50 Series

The Tally Mark 50 series is a complete perforated tape preparation and bi-directional communications center which combines a Tally perforator and reader, Tally transmit, receive, and error detection equipment, the new IBM Selectric typewriter, and the Bell System Parallel DATA-PHONE, 402A Transmitter and 402B Receiver.

In one compact console, the user can prepare data tape as a by-product of a useful typing operation and then, at any convenient time, he can transmit the data at 750 words per minute

over the dial-up telephone network. On mating Tally equipment, the data is received at 750 words per minute and recorded on perforated tape, followed by printout at 155 words per minute using the IBM Selectric typewriter. The new Selectric prints out 25% faster than the IBM model B or other equivalent automated typing equipment.

## Unique Code Structure

The Mark 50 Series is offered with the Tally 1501 code structure, an 8 level code on a 1" wide perforated tape. Whenever one Selectric is pre-

ment simply because of inherent switching transients in the automatic dial-up telephone network. Indeed, the telephone people themselves recommend that business machines be equipped to recognize and re-transmit those data portions necessary to provide error-free data. Tally Mark 52 and 53 systems carry a "forward skip" feature so that data prepared on source machines, such as billing typewriters, can be block error coded and transmitted in reverse. The data block in error is recognized because of the error code and transmission is suspended while

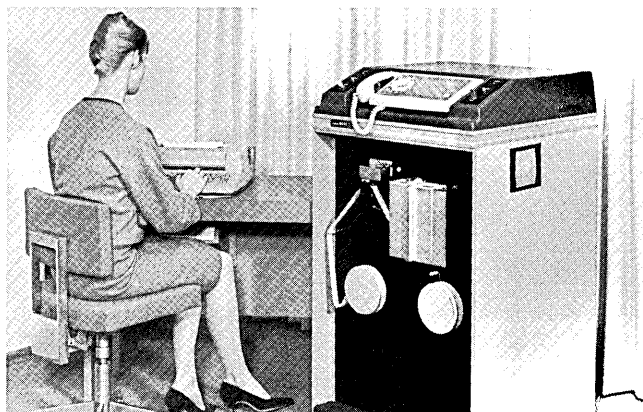

Mark 51  
Data  
Communications  
Center using  
IBM Selectric  
typewriter.

paring information for another Selectric, code variations are of no importance. Where code translation is required, note that the Tally 1501 code corresponds generally with character assignment in IBM and other codes minimizing the code conversion problem. Where the tape is used for computer input, the program can be written to perform the translation.

## About Mark 50 Series Readers and Perforators

Tally produces its own perforators and readers which have been proven in hundreds of customer installations from coast to coast. By manufacturing all of the equipment in data communications systems except the DATA-PHONE, Tally maintains *complete* system control.

## Automatic Error Detection

Error detection and correction is important in data transmission equip-

the reader passes over the block in error. This same feature facilitates tape clean-up and off-line error-free tape duplication. In summary, Tally Mark 52 and 53 systems can check errors prior to sending, during the receiving process, or as a re-read operation after receiving.

## More Information

Further information on the powerful new Mark 50 series can be obtained by calling your nearest Tally engineering representative (sales and service in more than 30 cities), or writing directly to our Marketing Manager.

# TALLY

REGISTER CORPORATION  
1310 Mercer Street  
Seattle 9, Washington  
Phone: MAIn 4-0760 • TWX SE 551

# ANNOUNCING

Control Data Corporation is proud to announce the new Control Data 606 high performance magnetic tape transport for the storage and manipulation of digital information. The 606 features pneumatic control of tape movement that provides smooth, uniform tape acceleration with minimum stress and stretch to the tapes.

The head assembly consists of individual read/write heads, an erase head, pressure pad, and vacuum-operated tape cleaners—designed to maintain precise head-to-tape contact pressure and reduce head and tape wear. The dual-gap 7-channel head construction provides read-while-write capabilities . . . as well as format compatibility with most major existing tape systems.

Designed for full computer control with no programming restrictions, the 606 was developed by Control Data computer engineers who know the value and importance of reliable, trouble-free operation in high performance equipment. Electrical and mechanical adjustments in the 606 have been minimized. The inherent reliability of all solid-state components is safe-guarded by direct-blast cooling.

Ease of maintenance is facilitated by provisions which permit quick replacement of major components through the use of pluggable modules and sub-assemblies. In multiple-unit systems, each 606 can be individually serviced for testing and maintenance without effecting the operation of other units.

The Control Data 1615 Tape Control Unit is used to connect the 606 Tape Transport to Control Data's large-scale computers. Up to eight 606 Transports can be controlled from a single 1615. As a standard feature, electronic circuitry is included in the 1615 to operate Control Data computers in the Satellite Computer System.

## DETAILED SPECIFICATIONS

### RECORDING FORMAT

- Method—NRZ (non-return to zero—change on ones)
- Seven-Track Recording: Data—6 bits; Parity—1 bit
- Inter-Record Gap— $\frac{3}{4}$  inch
- Tape Markers
  - End-of-Tape & Load Point reflective spot
- Compatible with IBM 727 and 729, I, II, III and IV Tape Units

### TAPE

- Width— $\frac{1}{2}$  inch
- Length—2400 feet with  $1\frac{1}{2}$  mil base Mylar tape
- Reels— $10\frac{1}{2}$  inch NARTB hub with file-protect ring

### TAPE SPEED

- Read/Write—150 inches/sec.
- Reverse Movement—150 inches/sec.
- Rewind & Unload—225 inches/sec.
- Start Time—4 millise. max.
- Stop Time—4 millise. max.

### RECORDING DENSITY—Selectable

- Low—200 frames per inch
- High—556 frames per inch

### CHARACTER RATE

- 83,400 per sec. @ High Density & 150 inches/sec.
- 30,000 per sec. @ Low Density & 150 inches/sec.

### HEADS

- Physical Spacings (forward direction):
  - Erase gap-to-write gap— $\frac{7}{16}$  inches
  - Write gap-to-read gap—0.300 inches

### PANEL

- Operator Controls with Indicators:
  - Power/Load Point/Forward/Hi-Lo Density/Reverse/Ready/Unload/Clear/Unit No. Selector
- Operation Indicators Only
  - Read/Fault/Write/File Protect

### PHYSICAL CHARACTERISTICS

- Size: Height—72 inches
  - Depth—33 inches
  - Width—28 inches
- Weight: 800 pounds
- Power—115v, 60 cycle, 3 KW

The

will  
1,620  
velop  
panie

will  
of va  
weigh  
incor  
port  
which  
bank  
times

the p  
but i  
check  
a com  
315 e  
tem,  
check  
ly in  
prepa  
posit  
The 4  
with  
er, w  
gramm  
autom  
clear

the m  
sorte  
elect  
sorte  
exclu

0

Far

capab  
from  
verti  
puter  
by th

of 20  
Punch  
perfo  
able.  
obtai  
wirin  
lecti  
any p  
nitio  
tion  
tion

COM

# CONTROL DATA

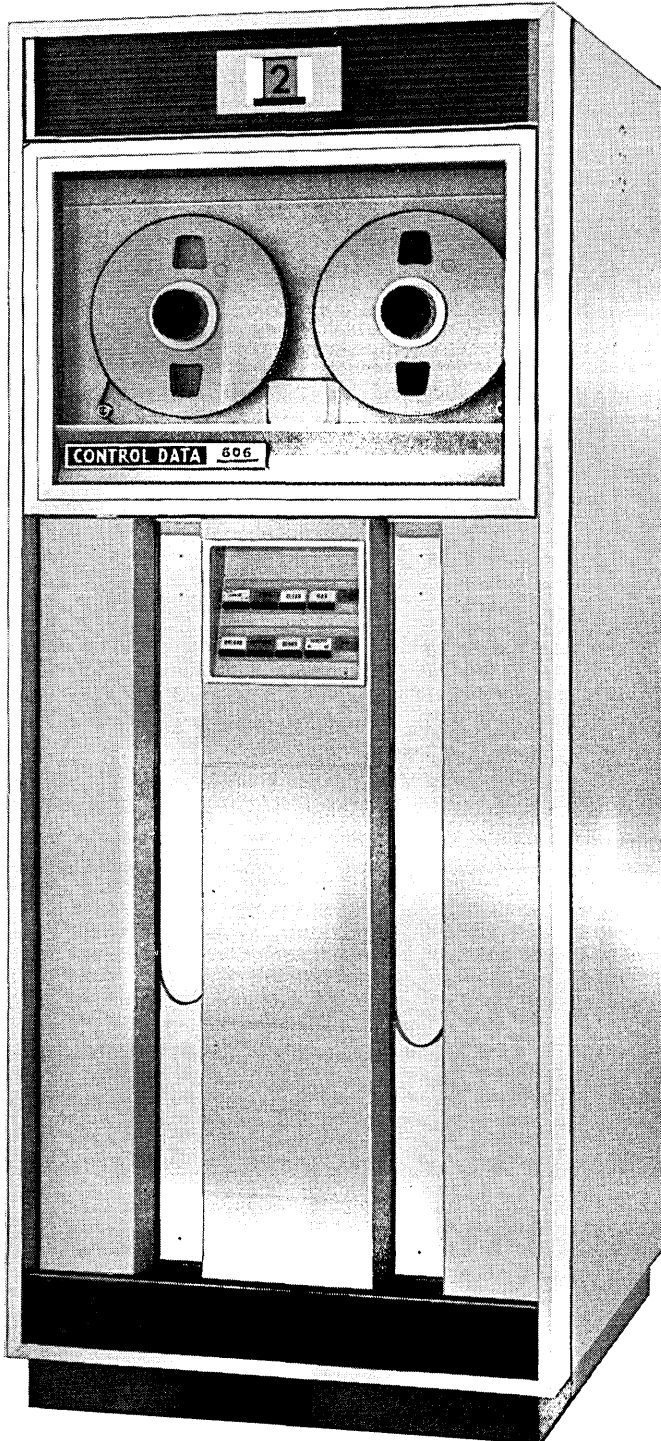

## 606 MAGNETIC TAPE TRANSPORT

The 606 Tape Transport is available with Control Data's large-scale computers, as well as for O.E.M. For further information on the Control Data 606, call the Control Data Sales Office in your area . . . or write for Publication No. 196.

**CONTROL DATA**

**CORPORATION**

8100 34TH AVENUE SOUTH, MINNEAPOLIS 20, MINNESOTA

# DATA PROCESSING AS A UNIVERSAL APPROACH TO CATALOGING PARTS

P. F. Santarelli  
IBM Corp.  
Kingston, N. Y.

The purpose of this report is to present a brief outline of the problem of preparing parts cataloging information for the provisioning of end items and to show the potential for data processing techniques in future applications. This report also briefly outlines the progress IBM has made in this area to date.

## The Technical Documentation Problem

One of the most perplexing problems facing industry and various government agencies today is the preparation and rapid publication of technical data in complete, concise, accurate, and usable form. Such data is vital to the design, production, operation, and maintenance of the myriad products of modern industry. This technical data is also used for provisioning of equipment procured by industry and the Department of Defense.

This problem has increased a hundredfold over the past ten years, due to (1) the demand for technical information necessary to keep the equipment operative and (2) the tremendous increase in the size and complexity of the equipment being manufactured today. Adding to the problem have been the varied methods of preparing, compiling, and recording this information. In most cases, this data is compiled by highly specialized technicians and typists. They have been aided to some extent by the application of internal data processing methods developed by individual industries and various departments of the government. Variations of the data processing methods used has been a limiting factor in a wider acceptance of data processing techniques.

It has become increasingly necessary to devise new methods of compilation and dissemination of technical data. To some extent this can be accomplished by fuller utilization of present-day data processing equipment and techniques. This in itself is only a stop-gap measure affording us temporary relief. In general, industrial management has not yet devoted the time or the money required for a thorough study of this area. Organization and selection of data processing techniques have been left largely to specialists in this field; thus, in their interpretation, they have dealt mainly with the problem at hand. In exercising these functions, little time, thought, or consideration has been given to the development of uniform data processing techniques. Recently renewed interest in data processing techniques with its significant potential has placed technical data processing and analysis in better

perspective, as evidenced by the release of the Department of Defense Instruction Bulletin 3232.7. The purpose of this document is to establish uniform Department of Defense provisioning requirements through the utilization of data processing techniques. This document is in furtherance of the provisioning objectives cited in Department of Defense Instruction Bulletin 3232.4, subject: "Policy and Principles Governing Provisioning of End Items of Material."

On January 8 and 9, 1959, a Department of Defense Seminar on Provisioning Technical Documentation (D. O. D. Instruction Bulletin 3232.7) was jointly sponsored by industrial associations and the Department of Defense for the purpose of instructing all concerned with the technical documentation requirements of D. O. D. Instruction Bulletin 3232.7. Attending the seminar were approximately 1,000 interested representatives of industry and the military services. The large attendance and thorough discussion of Bulletin 3232.7 at the seminar lends credence to the increased interest and wider acceptance of data processing techniques for the preparation of technical data.

## Progress to Date

For the past five years, Kingston IBM has pioneered in the application of technical data processing techniques to the preparation of catalog information. In 1954, for example, Kingston IBM was confronted with a tremendous parts-cataloging task. They were committed to supply the Air Force with an illustrated parts breakdown for the IBM engineered and manufactured SAGE Computer. Because of the magnitude of the task, Kingston developed a data processing technique that was designed to minimize time, effort, and costs. It was evident from the start that a significant saving could be achieved by employing data processing techniques. Because of this, specific approval to use data processing methods for preparation of the Illustrated Parts Breakdown manual for the SAGE Computer was granted by the procuring government agency. The result of this endeavor was extremely successful. A significant reduction in cost and time was realized in the preparation, publication, and maintenance of a manual consisting of over 5,000 pages of listings and over 1,200 illustration pages. Time is a factor of paramount importance in publication schedules.

With the SAGE catalog successfully completed on punched-card equipment, the entire process was re-



viewed to determine whether the preparation of parts catalogs could be further automated:

How could the manual insertion and extraction of revision cards and the semi-automated preparation of reproducible copy be eliminated?

How could production time and costs be further reduced and still utilize the same punched-card input?

With these thoughts in mind the decision was made to try programming an IBM 704 computer to completely process and maintain the SAGE Computer Illustrated Parts Catalog.

Research along these lines culminated in November 1959 in an operational Issue-and-Revision computer program which retained all the advantages of the earlier data processing techniques and added unique features of its own. This computer program accomplishes the following:

1. Integrates all Group Assembly Parts List (GAPL) entries;
2. Completely paginates the GAPL including the following features:
  - a. Placement of illustrations and titles in relation to an applicable list;
  - b. Formulation of revision pages as applicable to accommodate overflow;
  - c. Placement of list captions at the beginning of a list and at the head of each page;

- d. Automatic deletion of lists and illustrations;
- e. Placement of running heads and feet, including automatic insertion of deletion notices when sheets have been deleted;
- f. Automatic page numbering and revision date as applicable;
- g. Elimination of the manual preparation and/or sorting of a numerical index;
- h. Completely paginates the numerical index including the following:
  1. A three-column numerical arrangement of part numbers;
  2. As in the GAPL above, the automatic placement of running heads and feet including the insertion of deletion notices, revision dates, and page numbers.

In addition, the computer program provides the following:

1. An edit tape of improper entries—this greatly facilitates the visual editing of the catalog;
2. A new GAPL detail tape which provides the input data for subsequent revisions—this tape is essentially the same as the GAPL repro print tape, except that information which is not required for the printed catalog but is essential for subsequent computer operation is maintained on this tape.

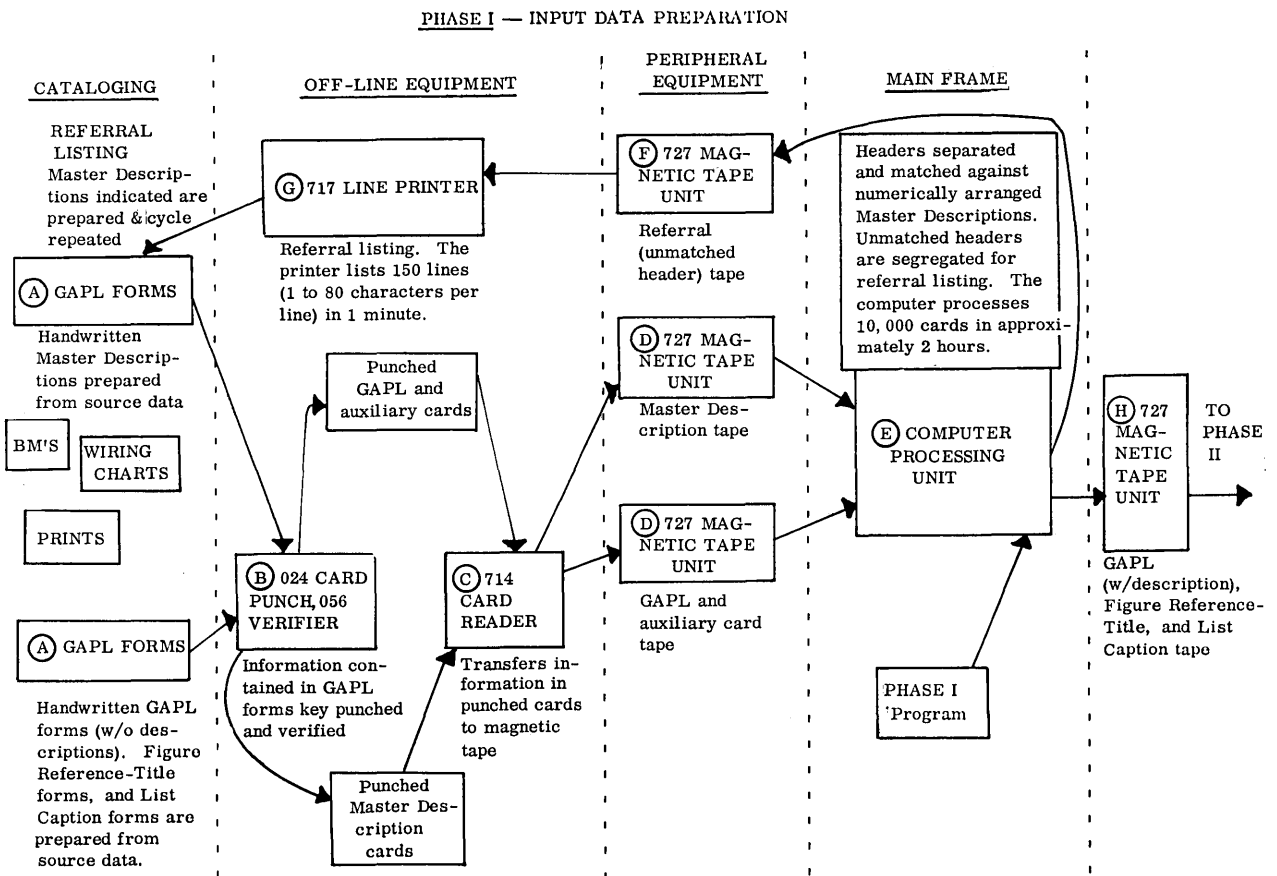

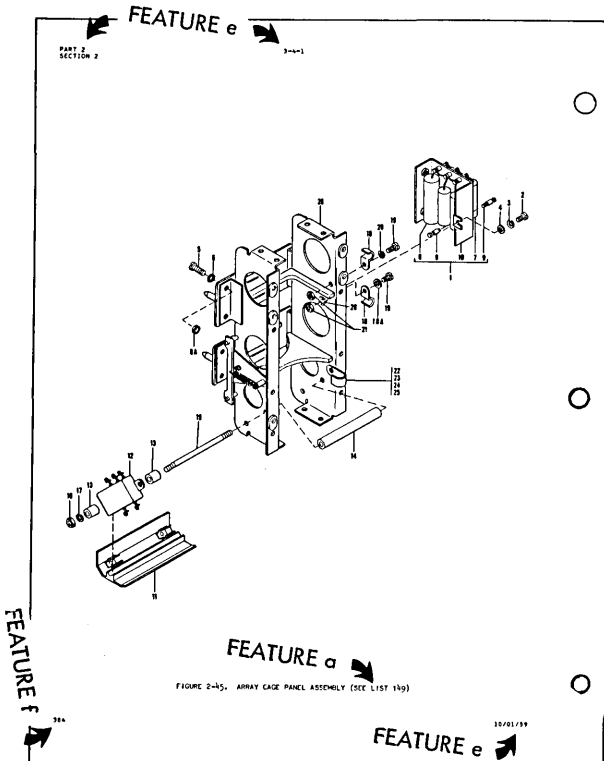

Array Cage Panel Assembly  
 - Exploded Drawing Identifying Parts

3-4-1

FEATURE e

LIST AND INDEX NO.	PART NO.	1 2 3 4	DESCRIPTION	UNITS	USABLE
				REF	OR CODE
148 - 9	3000216		JT/MALFEED TRMU		
- 10	3000217		BRACKET ASSY/TRANSFORMER DECOUPLING BOARD		SEAC
- 11	3000218		GUARD ASSY/TRANSFORMER		
- 12	3000219		TRANSFORMER/CLIP 1000MS 18 1/2		
- 13	3000220		SPACER/TRANSFORMER DRIVER PANEL ASSY		
- 14	3000221		SPACER/TRANSFORMER MTS HD		
- 15	3000222		MOD/TRANSFORMER WH		
- 16	3000223		MUT PLAT/HEXAGON 10-32		ATT PT AN340-10
- 17	3000224		WASHER/LOCK SPRING TENSION NDL 10		ATT PT AN353-10L
- 18	3000225		CLAMP/MECHANICAL 1/8 IN. ID		ATT PT AN353-10L
- 19	3000226		SCREW/MACHINE FIL HD 4-32 X 3/8		ATT PT AN353-10L
- 20	3000227		WASHER/LOCK SPRING TENSION NDL 8		ATT PT AN353-8L
- 21	3000228		MUT PLAT/HEXAGON 4-32		ATT PT AN340-8
- 22	3000229		CLAMP/CABLE		BE HP-48
- 23	3000230		SCREW/MACHINE FIL HD 4-32 X 1/2		ATT PT AN353-8
- 24	3000231		WASHER/PLAT NO. 8		ATT PT AN353-8
- 25	3000232		WASHER/LOCK SPRING TENSION NDL 8		ATT PT AN353-8L
- 26	3000233		MUT PLAT/HEXAGON 4-32		ATT PT AN340-8
- 27	3000234		ARRAY CAGE CONNECTOR PANEL ASSEMBLY		
- 28	3000235		SEE LIST 150 FOR DETAIL BREAKDOWN		
ARRAY CAGE CONNECTOR PANEL ASSEMBLY					
149 - 1	3000950		ARRAY CAGE CONNECTOR PANEL ASSEMBLY		REF
- 2	3000951		SEE LIST 149-29 FOR NEXT HIGHER ASSEMBLY AND FIG 2-44 FOR DETAIL BREAKDOWN		
- 3	3000952		CONNECTOR PANEL & GUIDE STRIP/FRONT		
- 4	3000953		CONNECTOR PANEL & GUIDE STRIP/REAR		
- 5	3000954		SCREW/MACHINE FIL HD 4-32 X 1 1/2 IN. LG		ATT PT AN353-4L
- 6	3000955		WASHER/LOCK SPRING TENSION NDL 8		ATT PT AN340-8
- 7	3000956		MUT PLAT/HEXAGON 4-32		ATT PT AN340-8
- 8	3000957		SCREW/MACHINE FIL HD 4-32 X 1/2		ATT PT AN353-4L
- 9	3000958		WASHER/LOCK SPRING TENSION NDL 8		ATT PT AN353-4L
- 10	3000959		SCREW/MACHINE FIL HD 4-32 X 1/2		ATT PT AN353-4L
- 11	3000960		WASHER/LOCK SPRING TENSION NDL 8		ATT PT AN353-4L
- 12	3000961		SCREW/MACHINE FIL HD 4-32 X 3/8		ATT PT AN353-4L
- 13	3000962		WASHER/LOCK SPRING TENSION NDL 8		ATT PT AN353-4L
- 14	3000963		SCREW/MACHINE FIL HD 4-32 X 3/8		ATT PT AN353-4L
- 15	3000964		WASHER/LOCK SPRING TENSION NDL 8		ATT PT AN353-4L
- 16	3000965		SCREW/MACHINE FIL HD 4-32 X 3/8		ATT PT AN353-4L
- 17	3000966		WASHER/LOCK SPRING TENSION NDL 8		ATT PT AN353-4L
- 18	3000967		SCREW/MACHINE FIL HD 4-32 X 3/8		ATT PT AN353-4L
- 19	3000968		WASHER/LOCK SPRING TENSION NDL 8		ATT PT AN353-4L
- 20	3000969		SCREW/MACHINE FIL HD 4-32 X 3/8		ATT PT AN353-4L
- 21	3000970		WASHER/LOCK SPRING TENSION NDL 8		ATT PT AN353-4L
- 22	3000971		SCREW/MACHINE FIL HD 4-32 X 3/8		ATT PT AN353-4L
- 23	3000972		WASHER/LOCK SPRING TENSION NDL 8		ATT PT AN353-4L
- 24	3000973		SCREW/MACHINE FIL HD 4-32 X 3/8		ATT PT AN353-4L
- 25	3000974		WASHER/LOCK SPRING TENSION NDL 8		ATT PT AN353-4L
- 26	3000975		SCREW/MACHINE FIL HD 4-32 X 3/8		ATT PT AN353-4L
- 27	3000976		WASHER/LOCK SPRING TENSION NDL 8		ATT PT AN353-4L
- 28	3000977		SCREW/MACHINE FIL HD 4-32 X 3/8		ATT PT AN353-4L
- 29	3000978		WASHER/LOCK SPRING TENSION NDL 8		ATT PT AN353-4L
- 30	3000979		SCREW/MACHINE FIL HD 4-32 X 3/8		ATT PT AN353-4L
- 31	3000980		WASHER/LOCK SPRING TENSION NDL 8		ATT PT AN353-4L
- 32	3000981		SCREW/MACHINE FIL HD 4-32 X 3/8		ATT PT AN353-4L
- 33	3000982		WASHER/LOCK SPRING TENSION NDL 8		ATT PT AN353-4L
- 34	3000983		SCREW/MACHINE FIL HD 4-32 X 3/8		ATT PT AN353-4L
- 35	3000984		WASHER/LOCK SPRING TENSION NDL 8		ATT PT AN353-4L
- 36	3000985		SCREW/MACHINE FIL HD 4-32 X 3/8		ATT PT AN353-4L
- 37	3000986		WASHER/LOCK SPRING TENSION NDL 8		ATT PT AN353-4L
- 38	3000987		SCREW/MACHINE FIL HD 4-32 X 3/8		ATT PT AN353-4L
- 39	3000988		WASHER/LOCK SPRING TENSION NDL 8		ATT PT AN353-4L
- 40	3000989		SCREW/MACHINE FIL HD 4-32 X 3/8		ATT PT AN353-4L
- 41	3000990		WASHER/LOCK SPRING TENSION NDL 8		ATT PT AN353-4L
- 42	3000991		SCREW/MACHINE FIL HD 4-32 X 3/8		ATT PT AN353-4L
- 43	3000992		WASHER/LOCK SPRING TENSION NDL 8		ATT PT AN353-4L
- 44	3000993		SCREW/MACHINE FIL HD 4-32 X 3/8		ATT PT AN353-4L
- 45	3000994		WASHER/LOCK SPRING TENSION NDL 8		ATT PT AN353-4L
- 46	3000995		SCREW/MACHINE FIL HD 4-32 X 3/8		ATT PT AN353-4L
- 47	3000996		WASHER/LOCK SPRING TENSION NDL 8		ATT PT AN353-4L
- 48	3000997		SCREW/MACHINE FIL HD 4-32 X 3/8		ATT PT AN353-4L
- 49	3000998		WASHER/LOCK SPRING TENSION NDL 8		ATT PT AN353-4L
- 50	3000999		SCREW/MACHINE FIL HD 4-32 X 3/8		ATT PT AN353-4L
- 51	3001000		WASHER/LOCK SPRING TENSION NDL 8		ATT PT AN353-4L
- 52	3001001		SCREW/MACHINE FIL HD 4-32 X 3/8		ATT PT AN353-4L
- 53	3001002		WASHER/LOCK SPRING TENSION NDL 8		ATT PT AN353-4L
- 54	3001003		SCREW/MACHINE FIL HD 4-32 X 3/8		ATT PT AN353-4L
- 55	3001004		WASHER/LOCK SPRING TENSION NDL 8		ATT PT AN353-4L
- 56	3001005		SCREW/MACHINE FIL HD 4-32 X 3/8		ATT PT AN353-4L
- 57	3001006		WASHER/LOCK SPRING TENSION NDL 8		ATT PT AN353-4L
- 58	3001007		SCREW/MACHINE FIL HD 4-32 X 3/8		ATT PT AN353-4L
- 59	3001008		WASHER/LOCK SPRING TENSION NDL 8		ATT PT AN353-4L
- 60	3001009		SCREW/MACHINE FIL HD 4-32 X 3/8		ATT PT AN353-4L
- 61	3001010		WASHER/LOCK SPRING TENSION NDL 8		ATT PT AN353-4L
- 62	3001011		SCREW/MACHINE FIL HD 4-32 X 3/8		ATT PT AN353-4L
- 63	3001012		WASHER/LOCK SPRING TENSION NDL 8		ATT PT AN353-4L
- 64	3001013		SCREW/MACHINE FIL HD 4-32 X 3/8		ATT PT AN353-4L
- 65	3001014		WASHER/LOCK SPRING TENSION NDL 8		ATT PT AN353-4L
- 66	3001015		SCREW/MACHINE FIL HD 4-32 X 3/8		ATT PT AN353-4L
- 67	3001016		WASHER/LOCK SPRING TENSION NDL 8		ATT PT AN353-4L
- 68	3001017		SCREW/MACHINE FIL HD 4-32 X 3/8		ATT PT AN353-4L
- 69	3001018		WASHER/LOCK SPRING TENSION NDL 8		ATT PT AN353-4L
- 70	3001019		SCREW/MACHINE FIL HD 4-32 X 3/8		ATT PT AN353-4L
- 71	3001020		WASHER/LOCK SPRING TENSION NDL 8		ATT PT AN353-4L
- 72	3001021		SCREW/MACHINE FIL HD 4-32 X 3/8		ATT PT AN353-4L
- 73	3001022		WASHER/LOCK SPRING TENSION NDL 8		ATT PT AN353-4L
- 74	3001023		SCREW/MACHINE FIL HD 4-32 X 3/8		ATT PT AN353-4L
- 75	3001024		WASHER/LOCK SPRING TENSION NDL 8		ATT PT AN353-4L
- 76	3001025		SCREW/MACHINE FIL HD 4-32 X 3/8		ATT PT AN353-4L
- 77	3001026		WASHER/LOCK SPRING TENSION NDL 8		ATT PT AN353-4L
- 78	3001027		SCREW/MACHINE FIL HD 4-32 X 3/8		ATT PT AN353-4L
- 79	3001028		WASHER/LOCK SPRING TENSION NDL 8		ATT PT AN353-4L
- 80	3001029		SCREW/MACHINE FIL HD 4-32 X 3/8		ATT PT AN353-4L
- 81	3001030		WASHER/LOCK SPRING TENSION NDL 8		ATT PT AN353-4L
- 82	3001031		SCREW/MACHINE FIL HD 4-32 X 3/8		ATT PT AN353-4L
- 83	3001032		WASHER/LOCK SPRING TENSION NDL 8		ATT PT AN353-4L
- 84	3001033		SCREW/MACHINE FIL HD 4-32 X 3/8		ATT PT AN353-4L
- 85	3001034		WASHER/LOCK SPRING TENSION NDL 8		ATT PT AN353-4L
- 86	3001035		SCREW/MACHINE FIL HD 4-32 X 3/8		ATT PT AN353-4L
- 87	3001036		WASHER/LOCK SPRING TENSION NDL 8		ATT PT AN353-4L
- 88	3001037		SCREW/MACHINE FIL HD 4-32 X 3/8		ATT PT AN353-4L
- 89	3001038		WASHER/LOCK SPRING TENSION NDL 8		ATT PT AN353-4L
- 90	3001039		SCREW/MACHINE FIL HD 4-32 X 3/8		ATT PT AN353-4L
- 91	3001040		WASHER/LOCK SPRING TENSION NDL 8		ATT PT AN353-4L
- 92	3001041		SCREW/MACHINE FIL HD 4-32 X 3/8		ATT PT AN353-4L
- 93	3001042		WASHER/LOCK SPRING TENSION NDL 8		ATT PT AN353-4L
- 94	3001043		SCREW/MACHINE FIL HD 4-32 X 3/8		ATT PT AN353-4L
- 95	3001044		WASHER/LOCK SPRING TENSION NDL 8		ATT PT AN353-4L
- 96	3001045		SCREW/MACHINE FIL HD 4-32 X 3/8		ATT PT AN353-4L
- 97	3001046		WASHER/LOCK SPRING TENSION NDL 8		ATT PT AN353-4L
- 98	3001047		SCREW/MACHINE FIL HD 4-32 X 3/8		ATT PT AN353-4L
- 99	3001048		WASHER/LOCK SPRING TENSION NDL 8		ATT PT AN353-4L
- 100	3001049		SCREW/MACHINE FIL HD 4-32 X 3/8		ATT PT AN353-4L
- 101	3001050		WASHER/LOCK SPRING TENSION NDL 8		ATT PT AN353-4L
- 102	3001051		SCREW/MACHINE FIL HD 4-32 X 3/8		ATT PT AN353-4L
- 103	3001052		WASHER/LOCK SPRING TENSION NDL 8		ATT PT AN353-4L
- 104	3001053		SCREW/MACHINE FIL HD 4-32 X 3/8		ATT PT AN353-4L
- 105	3001054		WASHER/LOCK SPRING TENSION NDL 8		ATT PT AN353-4L
- 106	3001055		SCREW/MACHINE FIL HD 4-32 X 3/8		ATT PT AN353-4L
- 107	3001056		WASHER/LOCK SPRING TENSION NDL 8		ATT PT AN353-4L
- 108	3001057		SCREW/MACHINE FIL HD 4-32 X 3/8		ATT PT AN353-4L
- 109	3001058		WASHER/LOCK SPRING TENSION NDL 8		ATT PT AN353-4L
- 110	3001059		SCREW/MACHINE FIL HD 4-32 X 3/8		ATT PT AN353-4L
- 111	3001060		WASHER/LOCK SPRING TENSION NDL 8		ATT PT AN353-4L
- 112	3001061		SCREW/MACHINE FIL HD 4-32 X 3/8		ATT PT AN353-4L
- 113	3001062		WASHER/LOCK SPRING TENSION NDL 8		ATT PT AN353-4L
- 114	3001063		SCREW/MACHINE FIL HD 4-32 X 3/8		ATT PT AN353-4L
- 115	3001064		WASHER/LOCK SPRING TENSION NDL 8		ATT PT AN353-4L
- 116	3001065		SCREW/MACHINE FIL HD 4-32 X 3/8		ATT PT AN353-4L
- 117	3001066		WASHER/LOCK SPRING TENSION NDL 8		ATT PT AN353-4L
- 118	3001067		SCREW/MACHINE FIL HD 4-32 X 3/8		ATT PT AN353-4L
- 119	3001068		WASHER/LOCK SPRING TENSION NDL 8		ATT PT AN353-4L
- 120	3001069		SCREW/MACHINE FIL HD 4-32 X 3/8		ATT PT AN353-4L
- 121	3001070		WASHER/LOCK SPRING TENSION NDL 8		ATT PT AN353-4L
- 122	3001071		SCREW/MACHINE FIL HD 4-32 X 3/8		ATT PT AN353-4L
- 123	3001072		WASHER/LOCK SPRING TENSION NDL 8		ATT PT AN353-4L
- 124	3001073		SCREW/MACHINE FIL HD 4-32 X 3/8		ATT PT AN353-4L
- 125	3001074		WASHER/LOCK SPRING TENSION NDL 8		ATT PT AN353-4L
- 126	3001075		SCREW/MACHINE FIL HD 4-32 X 3/8		ATT PT AN353-4L
- 127	3001076		WASHER/LOCK SPRING TENSION NDL 8		ATT PT AN353-4L
- 128	3001077		SCREW/MACHINE FIL HD 4-32 X 3/8		ATT PT AN353-4L
- 129	3001078		WASHER/LOCK SPRING TENSION NDL 8		ATT PT AN353-4L
- 130	3001079		SCREW/MACHINE FIL HD 4-32 X 3/8		ATT PT AN353-4L
- 131	3001080		WASHER/LOCK SPRING TENSION NDL 8		ATT PT AN353-4L
- 132	3001081		SCREW/MACHINE FIL HD 4-32 X 3/8		ATT PT AN353-4L
- 133	3001082		WASHER/LOCK SPRING TENSION NDL 8		ATT PT AN353-4L
- 134	3001083		SCREW/MACHINE FIL HD 4-32 X 3/8		ATT PT AN353-4L
- 135	3001084		WASHER/LOCK SPRING TENSION NDL 8		ATT PT AN353-4L
- 136	3001085		SCREW/MACHINE FIL HD 4-32 X 3/8		ATT PT AN353-4L
- 137	3001086		WASHER/LOCK SPRING TENSION NDL 8		ATT PT AN353-4L
- 138	3001087		SCREW/MACHINE FIL HD 4-32 X 3/8		ATT PT AN353-4L
- 139	3001088		WASHER/LOCK SPRING TENSION NDL 8		ATT PT AN353-4L
- 140	3001089		SCREW/MACHINE FIL HD 4-32 X 3/8		ATT PT AN353-4L
- 141	3001090		WASHER/LOCK SPRING TENSION NDL 8		ATT PT AN353-4L
- 142	3001091		SCREW/MACHINE FIL HD 4-32 X 3/8		ATT PT AN353-4L
- 143	3001092		WASHER/LOCK SPRING TENSION NDL 8		ATT PT AN353-4L
- 144					

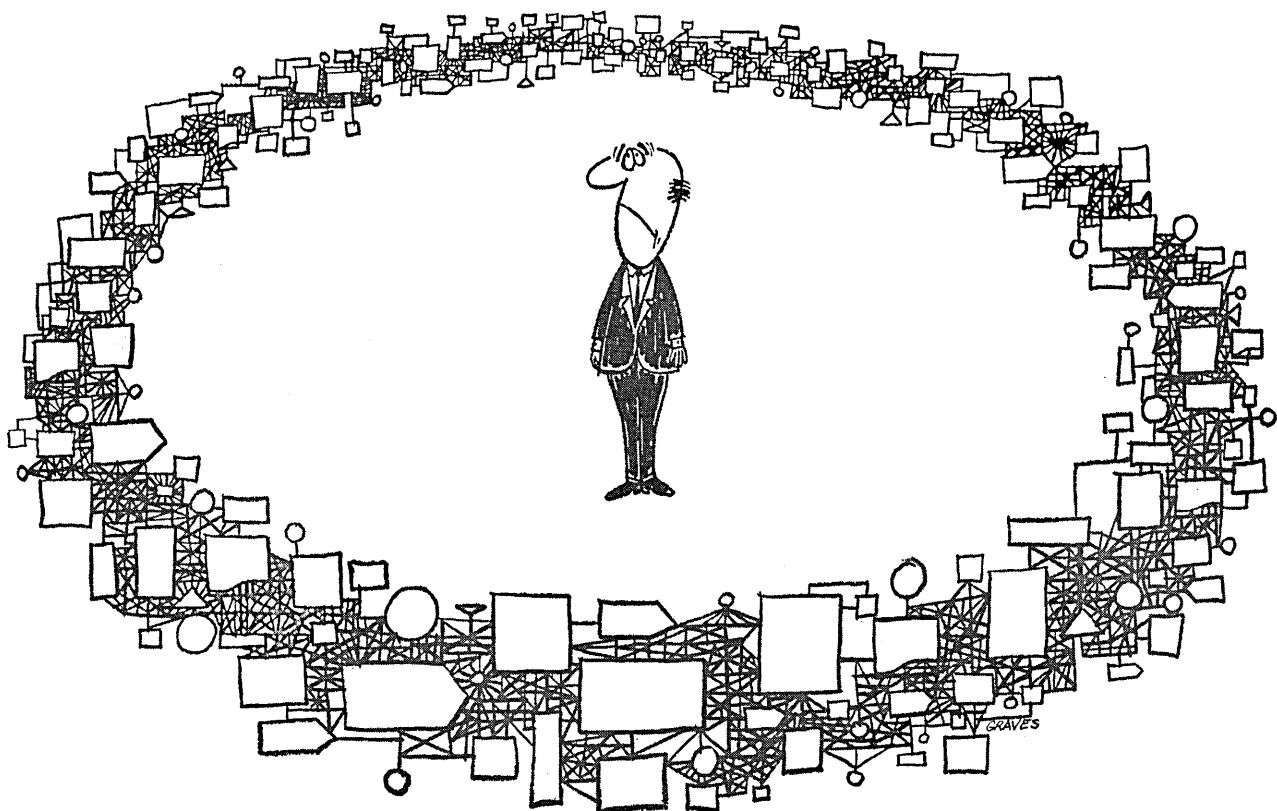

## *is your electronics career in a closed loop?*

Have you programmed your career into a corner? Create a loop exit for yourself...apply for one of several senior openings for **MILITARY SALES ENGINEERS, DIGITAL COMPUTER SYSTEMS ENGINEERS** and **SYSTEMS PROGRAMMERS** at Bendix Computer Division. Bendix Computer has been a leading manufacturer of digital computing systems for 10 years...has long enjoyed a reputation for leadership. Growing acceptance of the Bendix G-20 and new military computer systems has created exceptional opportunities. The resulting combination of leadership and growth will help you out of that iterative loop...and into a new open-ended career. Check it out for yourself. Call or write: Mr. William Keefer, Manager, Professional Staff Relations, Bendix Computer Division, 5630 Arbor Vitae Street, Los Angeles 45, California.

AN EQUAL OPPORTUNITY EMPLOYER

**Bendix Computer Division**



MEET US AT THE SPRING JOINT COMPUTER CONFERENCE, FAIRMONT HOTEL, SAN FRANCISCO

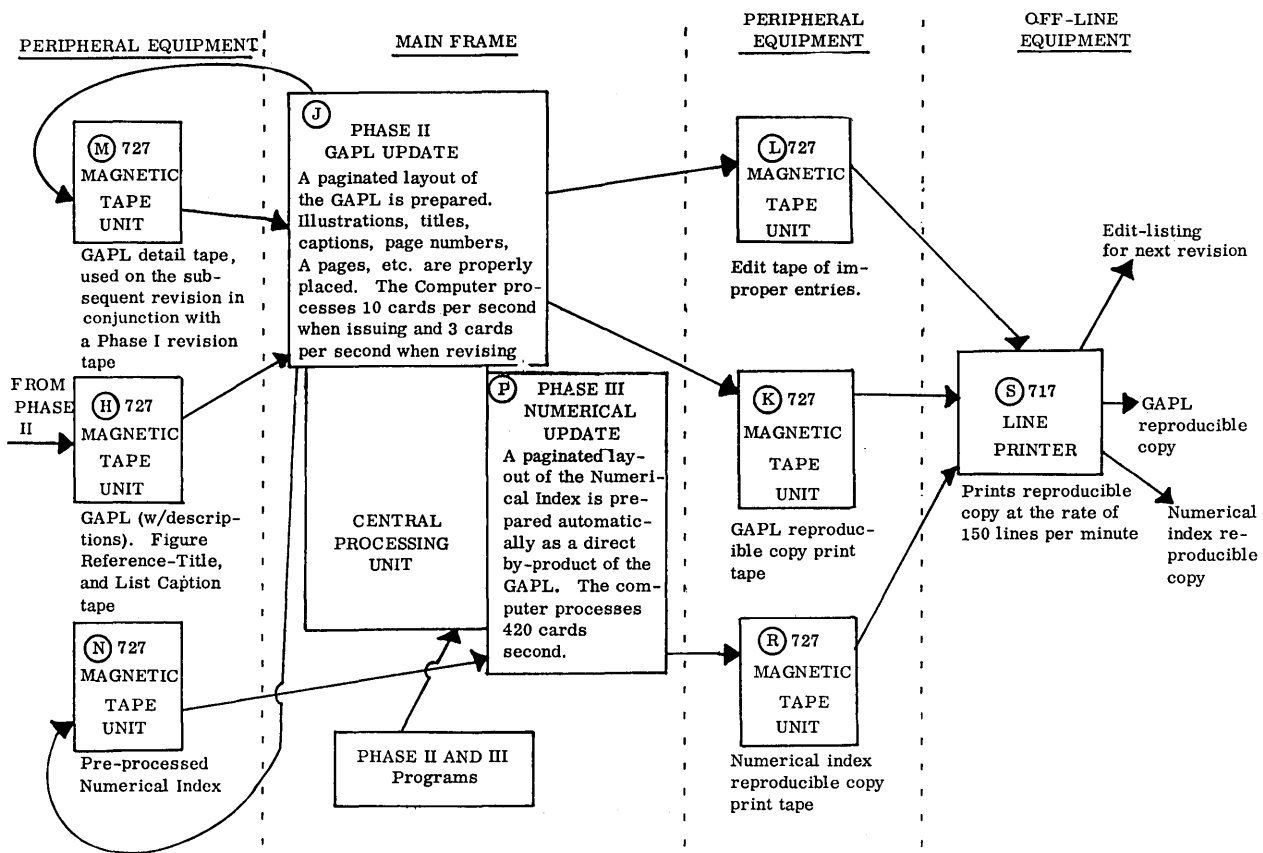

The computer greatly facilitated the preparation of the parts catalog and in addition retained all the primary advantages inherent in the earlier technique: greater consistency and accuracy, relative ease of revision, faster compilation, and more economical preparation of repro copy.

In conjunction with the advances made in the processing of raw data, experiments are being conducted to improve the reproduction quality of printed material. Along these lines, various ribbons and paper have been tested in an effort to achieve the highest reproduction quality obtainable by data processing techniques. The results of these experiments have been more than gratifying.

Although pleased with the progress made to date, Poughkeepsie Product Publications plans to continue investigating the possibilities available from current research in such areas as magnetic inks, magnetic typewriter ribbons, magnetically sensitized cards, photo recognition, and high-speed readout devices capable of printing speeds up to one million characters a minute. We hope the mediums just mentioned will permit us to speed up reproduction considerably. Speed and quality are essential in the preparation of technical data. Short deadlines make it almost mandatory that better means be devised to maintain schedules. Quality is essential from the viewpoint of the customer, since most of this material is distributed in manual form. Use of these mediums would permit us to reduce the time and amount of work necessary

to perform these functions. Reduced time and reduced work mean reduced costs and increased production capabilities.

### Conclusion and Recommendations

Realizing the rapidly growing need for a solution to the problem of technical documentation and the vast potential for data processing techniques in this field, the following information should be considered.

Factors for evaluating any approach to the technical documentation problem are time, work, costs, duplication of effort, and quality of the end item. These factors become even more significant with the increased complexity of the equipments being manufactured today. With the advent of D. O. D. 3232.7 and its stringent requirements for provisioning of end items, reliable equipment operation is affected unless adequate technical documentation is made available at the proper time. This document emphasizes the growing importance for technical data processing techniques. There is little doubt that automatic processing of technical data is essential and that the demand for these services will grow in the very near future. Thus, from a competitive viewpoint, it is extremely important that present data processing techniques be exploited to the fullest extent.

Millions of dollars are expended annually in the preparation of technical data. This should be an incentive as well as an exciting challenge to those of us involved in the design, manufacture, and application of data processing equipment.



# COMPUTERS AND POLITICAL STRATEGY

Peter Kugel

Technical Operations, Inc.  
Burlington, Mass.

At the end of the 1960 campaign, computers made brief, and not always auspicious, appearances as side-show curiosities on television news programs. In future campaigns, the role of computers promises to be somewhat more impressive. This will not be merely because the quality of their predictions will be improved (although this appears likely) but because we can also expect computers to be applied in new and important ways in the political campaigns of the future. If the elections are close and the computers are used well, such applications may conceivably determine the outcomes of these campaigns.

Perhaps the most important application of computers in future political campaigns will be their use in helping to devise optimal campaign strategies. Strategies chosen with the help of computers can be far more effective than strategies developed without them. Therefore it is possible that some future election may be won by the party with the best computer program rather than the party with the best candidate. To show how this might come about is one purpose of this article. To show why this is not as threatening to the future of democracy as it might at first appear, is another.

## Technological Innovations

The computer is a technological innovation, and like many technological innovations of the past, it can be expected to have unexpected effects. Technological innovations have, of course, already had their influence on the practice of politics. For example, rapid communication has outmoded (but not eliminated) the electoral college. The jet plane has increased the mobility of national candidates; and there are those who credit (or blame) the outcome of the 1960 campaign on the effects of the television set.

Computers can be expected to exert their influence on politics in several ways. The automation brought about by their use may provide campaign issues. Computers may be used to simplify the tabulation of results, increase the difficulty of perpetrating voting frauds, increase the frequency with which elections are held, and so forth. Most importantly, computers will be able to influence results of campaigns through their ability to make information available to those in charge of running the campaigns.

## Transformations of Data

Information is more useful than it might at first appear, and examples which suggest this fact are easy to find. Much of the activities of military intelligence and research groups are "nothing more" than obtain-

ing information. Computers are, in a sense, more limited in their activities than research groups. The information the computer can produce for its users is nothing more than the results of applying rules with which the computer has been provided to a set of facts with which it has also been provided. In spite of these apparent limitations, however, the results computers can obtain can be of considerable value, for transformations of data can be far more valuable than the original raw data.

This fact is, of course, familiar to most scientists, since much of their work consists not of gathering data but of summarizing and analyzing it appropriately.

A familiar, if somewhat mundane, example of how merely summarizing data can increase its value is provided by the cash register in a supermarket. Its use enables a clerk to take data from the customer's purchases and to provide that customer, fishing in her pocketbook, with precisely the summary of the data which she needs.

The information processing done by computers is, at least on occasion, somewhat more sophisticated. Although the use of computers to provide summaries, as when they are used to produce financial reports, is familiar and, in many applications, extremely useful, yet computers can do more than merely summarize information. They can perform a variety of logical and mathematical operations on data to extrapolate it, correct it, analyze it, and provide much information from it which does not, at first sight, appear to be contained in the original data.

## Correcting Polls

One application of this ability to politics, which is already familiar and is being used with increasing sophistication and success, is to "correct" the data obtained from public opinion polls for biased samples, voters who express an opinion but will not show up at the polls, and similar factors. Of far more importance in the future will be the computer's ability to calculate the effects of decisions and changes in the situation on the opinion (and the voting behavior) of the electorate, and to analyze the results of such calculations. Such an ability includes the ability to predict the effects of various alternative choices open to party leaders.

If one also provides the computer with a way of evaluating these effects (and the number of electoral votes it would win for a party suggests itself as a pretty good measure of the value of a possible alternative to a political party in a national campaign), then the computer may be capable of choosing the best from

among the possible courses of action. If the values one provides the computer for this evaluation are one's own (or those of one's party) then there is a sense in which the computer is telling the user what he ought to do.

### **Resources for a Political Campaign Manager**

Thus, the computer (appropriately programmed, of course) can provide the manager of a political campaign with three kinds of information. It can provide him with descriptive information which tells him what is going on; it can provide him with predictive information, or information of what will be going on in the future (with emphasis on what will happen on the first Tuesday after the first Monday in November); and it can provide him with prescriptive information which tells him what he ought to do. How valuable might these different types of information be in a political campaign?

Much of the answer to this question depends, of course, on how sound the information is, and how well it will be applied. Consider however, as an example, the application of computers to the problem of planning a campaign itinerary for a presidential candidate. Assume (and it seems to be a reasonable assumption) that the candidate's personal appearance in a particular area will pick up a certain number of votes in that area which he would not have gotten otherwise. Assume also, that this is the only factor with which we are concerned. In actual fact, of course, there will be other factors involved in planning campaign itineraries. There will be the effect of local appearances of national candidates on the results of local elections, there will be the question of how much money is available for transportation, of a candidate's varying appeal to varying audiences, and of personal factors. However, we can simplify our example by disregarding these factors (although we cannot do this in actual fact).

Given this simplified problem, then, consider the relative values of the different kinds of information which a computer can provide for a campaign manager.

### **Focusing a Candidate's Energy**

If the campaign manager has available to him a computer-produced summary of political opinion polls, which describes for him the current state of the electorate, he can focus his candidate's time and energy on those areas where his personal appearance will have the maximum effect on the eventual electoral vote. He will thus send his candidate to the states with the largest groups of undecided voters, or those where opinion is most evenly divided. By his ability to focus the power of his candidate's personality on those areas where it will have the greatest effect on the final result, this campaign manager clearly has the advantage over the campaign manager who (and he is surely only an imaginary character) plans his candidate's itinerary completely at random.

The manager who uses the high speed and relatively low cost of the computer to provide him with more frequent descriptive summaries of the situation is one step ahead in that he can (insofar as previous commitments permit) adapt his itinerary to unex-

pected changes during the course of the campaign, and thus he increases the effectiveness with which he uses his resources.

### **Predictive Information**

These examples indicate how descriptive information obtained with the help of computers can be helpful. Predictive information, or information which tells one what will happen, can be even more useful. Suppose, for example, that we have a computer program which uses information gleaned from the experiences of past elections to predict the effects of different itineraries. Computers can be used to consider the effects of various possible alternative itineraries on the eventual electoral vote and can take into account a large number of relevant factors in making such predictions.

The capabilities of such a predictive program differ, of course, from those of the crystal ball. Whereas the crystal ball tells us what will happen no matter what, our computer program tells us what will happen if we do certain things and if we have taken all the relevant factors into account. In other words, it has all the limitations of any of the more familiar parts of science. In general, however, these limitations need not be serious. We often know what most of the relevant factors are, and can often predict quite well within what range our predictions will be accurate. Thus, to take what is, perhaps, a frivolous example of the use made of a scientific principle, the law of reflection (which says that the angle of incidence equals the angle of reflection) may not tell us precisely how a billiard ball (hit without spin) will bounce off the edge of the table, because it ignores the imperfections of the table, but it comes as close as we need for any practical purposes. And, as most billiard players know, it only predicts what will happen if the ball is hit correctly. In other words, it does not predict the outcome of a game, or even the effects of a shot, but knowledge of it does help one to play the game well.

Similarly, our computer program will tell us what will happen if the factors we have not considered can be ignored, but one of the reasons we ignored them is because it seems quite reasonable that they will not make a difference. And, of course, it can predict only what would happen if we actually do as we said we would. But even such predictions can be of extraordinary help in making rational decisions. The predictions made by applying political science are not guaranteed to the same degree as those offered by those who read crystal balls, but, in spite of this, there are good reasons for taking them more seriously. By predicting the consequences of the various alternatives open to us, a predictive program tells us how to bring the consequences about, for by predicting which alternative itinerary is most likely to win an election, the information may, indeed, enable us to win the election.

There are several ways we can still improve upon our program. One way involves retaining its essentially predictive nature, but making it more adaptive. Our predictions in the previous case were based on the information at hand when we planned out the itinerary. However, these predictions were based on

certain assumptions as to what would happen during the campaign (such as the continued good health of the candidate) and such assumptions are notorious for their ability to go wrong. During the campaign, events will occur that weren't anticipated, and the effects of other events may not be quite what we predicted. The clerical capabilities of the computer can be used to revise our estimates of the situation in the light of these changes. If something unexpected happens to make one state's elections closer than anticipated, we may, as a result of the more recent information, change the itinerary to put more emphasis there.

### Prescriptive Information

Finally, suppose that we have a prescriptive device: that is, a device that tells us what to do. Here again it is important to distinguish such devices from other prescriptive devices, such as Fairy Godmothers, which tell us what to do no matter what. Our prescriptive device, like our predictive device, is conditional. It only tells us what to do if we wish to accomplish certain aims, and if other assumptions are made. In this application, such a device would consider the presidential candidate as a resource to be allocated. Acting on the basis of experience fed to it from past campaigns it would attempt to determine where and when our candidate should speak in order to maximize his chances of winning the election. Its aims in such an effort would have to be determined by us. We would have to tell our device that we wanted to win the most electoral votes, and not the most popular votes, to indicate the relative importance of presidential, gubernatorial, senatorial and other campaigns and so forth. What our device would do is to take into account all of these factors, and by applying rules provided by mathematicians and political scientists, attempt to calculate the best policy using many of the same techniques that are now being used to write computer programs to optimize delivery schedules, inventories, and other allocations for industry.

The outputs of this device would be the best policy for achieving the aims we had provided to it. In its ability to take into account a larger variety of factors, and to apply some powerful mathematical techniques, it might considerably change the itinerary we had worked out intuitively, and perhaps pick one quite different from any that had occurred to us.

### Intangible Factors

Such devices as we have outlined above, will not actually run campaigns. Some decisions will be made on the basis of factors too intangible for precise computations, and human judgment will still be required in applying these results. However, these devices will provide information, and by providing information which can considerably amplify the effectiveness of campaign managers' decisions, can thus influence the courses and outcomes of political campaigns.

### Political Positions

More striking than the ability of such computed information to change itineraries is the possibility that it might change the political positions (or at least the avowed positions) of the parties.

As an example of how this could come about, suppose that one wishes to determine the platform to be

submitted to the national convention. Again, in order to simplify matters for our example, let us further assume that whatever platform we submit will be accepted.

Since civil rights planks are currently *de rigueur* we shall, of course, include such a plank. Suppose that we, personally, prefer a strong civil rights plank. Again we consult a device which is essentially predictive. We know that both strong and weak civil rights planks will win some votes and lose others. What we do not know is how many each will win or lose, and what the importance of the changed votes will be to the outcome of the election. This is precisely what our device can tell us by projecting the lessons of past campaigns onto the facts of the current one. Let us suppose that in this case it tells us that, either due to the number or to the distribution of the votes that a strong civil rights plank will lose, its inclusion in the platform (assuming everything else remains unchanged) will probably lose the election for us. If we believe strongly enough in the rest of the platform, this information may well lead us to propose the weaker plank, in spite of our personal feelings. This is not to say that the selection of a platform is totally a matter of expediency, or that our device tells us what we must do. The only thing that our device has done is to spell out the consequences of our alternatives. However, this spelling out may determine our choice between them.

### Models of the Electorate

How can the computer, a device which (as many programmers will be delighted to explain) has an imagination somewhat smaller than that of a salted peanut, be programmed to turn it into devices of the sort we have suggested above?

Basic to these capabilities is the use of computers to project the partial information obtained from public opinion polls into a description of the electorate. Public opinion polls have been suspect ever since the Truman debacle when they almost uniformly erred in their attempts to predict the outcome of an election. However, precisely because of the lessons learned from this failure, and because of the availability of computers to perform the necessary clerical work and calculation to correct for past errors, such polls, or rather the interpretation of their results, has been considerably improved. They can now be corrected for their limited, and possibly biased sampling, for voter apathy which can lead to a felt opinion not being translated into a vote, as well as a number of other factors. By correcting for previous mistakes, such interpretations can now provide surprisingly accurate pictures of what the vote would be if it were taken on the day of the poll.

This information underlies the other applications of computers to the management of election campaigns and is used to produce a "model" of the electorate. Such models are fundamental to the potential roles of computers in future campaigns.

### Models in General

Models, in general, are imitations of their objects intended to behave like them in some particular way. Perhaps the most familiar kinds of models are those built by and for children. Such models are gen-

S  
memory,  
a high-  
card  
per  
soci-  
mpment.  
NTER  
data  
erlin  
for  
sidi-  
ale com-  
tape  
e in-  
s ready  
a speed  
ble the  
ase in  
opera-  
rent  
trans-  
TEM  
INC.  
nc. will  
computer  
urity  
es, La.  
rm a  
ons, in-  
bal-  
ds.  
em in-  
ts,  
ables,  
ords.  
E  
R  
e, Mel-  
n de-  
ronic  
d Dy-  
ch.  
sed by  
of chem-  
ical  
y math-  
include  
ch.

erally intended largely to look like what they are models of (although modern toy makers are pushing resemblances in various other directions).

The models with which our computers will work will not look like what they are imitations of. Indeed, to the unpracticed eye they will not look like much at all. They will consist (in some sense) of symbols and numbers. However, such symbols and numbers can produce models much like the child's model plane or house. They are models because they maintain the relationships (or at least those relationships relevant to our concerns of the moment) inherent in the original situation.

Most of us are familiar with such mathematical models. Thus the equation:  $V = 32 \times T$  is a model of a falling object (on or near the surface of the earth in a vacuum). It is a model in spite of the fact that it neither looks like or behaves like a falling object. It is a model because it describes the relationships between two characteristics of such falling objects: namely how fast it is falling ( $V$ ) and how long it has been falling ( $T$ ).

As a model, it has two further defects. It does not tell us precisely what this relationship will be in actual fact because it leaves out a number of important factors such as air resistance, and it tells us nothing about the "real" nature of gravity itself. However, in spite of these shortcomings, it can be an extremely useful model in a surprising number of applications.

#### Computer Models

Generally, the models one puts on computers are considerably more complex. There are more equations involved, and the equations are a bit more complicated, but the basic considerations are roughly the same.

For one thing, computerized models frequently deal with numerically measurable quantities. This often raises a number of problems. Perhaps crucial to the particular application with which we are here concerned is the problem of assigning numbers to indicate the values, to us, of effects produced by various strategies.

In trying to plan an optimal itinerary for a presidential candidate, for instance, one would have to compare the importance of the presidential election with that of governors, senators, and congressmen. In general, it is clear that (barring some exceptional cases) the presidential election is more important than any given senatorial election. Thus, the numerical value assigned as the value of winning the presidency should be greater than that of winning a Senate seat. However, one might be willing to risk losing a presidential election in order to win a large number of senatorial elections. There is a problem here in attempting to ascertain exactly how many.

Another similarity between our first equation and the more complex equations which make up a computerized model is that, like the simpler model and in spite of its greater complexity, the computer model leaves a large number of things out. In general, these things are left out because they are not thought to have any important influence on the relationships that concern us. Thus, a lead ball dropped from the Lean-

ing Tower of Pisa may not be appreciably influenced by air resistance, but a piece of paper under similar circumstances would be. Our model, thus, is limited in scope. The importance of such omissions should not, however, be overemphasized. In general, they occur because they make no practical difference. Where they do, however, the other factors involved can be added in a relatively straightforward manner where their behavior is understood. Where they are not understood, the partial understanding of the situation produced by the partial model defines the problem involved in this lack of understanding far more precisely. Indeed, it is by regularly defining such new problems, made apparent by a fuller understanding of grosser relationships that have been more thoroughly studied, that science of all kinds, and in this case, a political science in particular, advances and increasingly refines its tools.

#### Utility of Abstract Models

A final similarity of the computerized model to the simple equation is that it is abstract and can thus be studied mathematically. Our gravity equation can be subjected to simple mathematical analysis without further investigation of falling objects to yield an equation for acceleration, or a model of how much the speed of a falling object is increasing at any moment. Similarly, mathematical tools devised originally for quite different purposes, can be applied to models of the electorate to produce information quite strikingly different from the information that appears to be contained in the model, but which is implied by it.

The utility of such abstraction is quite similar to the utility of less complicated toys for children. A model train that smokes and emits various noises can serve only as a model of a train. A wooden block, on the other hand, can serve not only as a train, but also as a car, a gun, a house, or what have you. A mathematical model, sufficiently lacking in the specific detail tying it to a particular application, has a similarly broad range of applications and has, in all likelihood already been studied in some of these. One is thus capable of applying work already done in other areas to the area one is interested in merely because one has constructed a sufficiently abstract model.

Once one has such a mathematical model of the electorate (and the nature of the model depends in large part on what one plans to do with it), one can use the computer in calculating the effects of changes in various parts of the model (just as one can use Galileo's equation to calculate the effects of changes in speed as the result of changes of the time of fall). In the case of the more complex model of the electorate, one requires the assistance of a computer partly because there are so many relationships to be considered, and partly because some of the relationships are rather complicated.

#### Models of the Electorate

The first step in using computers to help determine campaign strategy is the construction of such a model of the electorate. The kind of model we need must contain a large number of factors, and interrelationships between them. It must relate factors we can



observe (such as opinions expressed in polls), and factors we can control (such as itineraries and platforms) to the future behavior of the electorate.

The factors underlying such relationships are extremely complex, involving factors such as unconscious motivation, which are not fully understood. However, just as it was not necessary for Galileo to fully understand the mechanism of gravity to produce an equation describing its effects, so it is not necessary for the political scientist to fully understand the mechanisms underlying political behavior in order to describe them accurately and precisely.

Indeed, as contrasted to Galileo (but not to the contemporary physicist) he does not even have to describe these interactions exactly. It is sufficient for him to describe such interactions statistically. He need not, in other words, say that a given kind of speech will influence so and so to change his vote, but only that it will change a certain percentage of such and such a group. And he need not even specify what the percentage is. It will suffice if he predicts merely the probabilities with which different percentage changes will occur.

The computerized study of such dynamic models can give one not only the examination we outlined in the examples above, but information on far more complex situations. The computer can be programmed to apply the change rules discovered by political scientists to the initial condition of the model as it is determined by the results of public opinion polls. By experimenting with the effects of different changes it can predict the effects of choosing these changes, just as one might predict the speed of a body dropped from different buildings by feeding different times into Galileo's equation.

However, we can go considerably beyond such experimentation. We can, by studying the model mathematically, derive some general truths about all changes of a certain kind. A number of different mathematical techniques, many of which were developed during the course of World War II and are now part of the arsenal used by workers in operations research, can be brought to bear upon these models to yield results "all" possible values of their variables. In particular, such techniques can be used to yield courses of action which will maximize some effect among the wide spectrum of available alternatives.

### The Campaign Manager's Power

It is, then, these two results of studying the behavior of mathematical models of the electorate on computers, the one giving the probable effects of a decision and the other yielding the best policy for achieving one's aims, that will strengthen the hand of the campaign manager. Do these results give the campaign manager a Svengali-like control over the vote of the American people?

The answer to this question is, of course, no. In the first place, it is clear that such information cannot by itself win any election. It can only enable those who manage the campaign to make the best use of those capabilities which their party has at its command. It may, in other words, be a factor in elections, but it will not be the sole factor.

For another thing, such programs will, in one form or another, be available to both sides. This is not to overlook the fact that one party may make better use of this tool than the other, or that one party may have this tool before the other. (Thus, in the 1960 election, several political scientists and mathematicians built a model of the electorate for the Democratic party.) But the general underlying scientific information is available to both parties, just as the basic findings of scientists in both the USSR and the USA are, in general, available to the scientists of both countries.

### Computers Lack Imagination and Judgment

Finally, although computers can determine strategies, no way has yet been found to have them do so with imagination or with much judgment.

Thus, a computer currently lacks imagination in that it can only consider the alternatives that have been suggested to it. There is a sense, although it is not precisely the sense in which it is commonly believed, that computer programs cannot come up with any really original ideas.

However, perhaps the most striking shortcoming of computers as applied to politics is their lack of judgment when it comes to applying their results. This lack of judgment suggests that the job of the campaign manager has not yet been made obsolete by automation. But, on the other hand, the computer provides the campaign manager with more information than he would have without it, and thus enables him to make a sounder, more rational, judgment.

The computer will be merely one factor in future elections although, in some, it may be a crucial one. It, like any other technological innovation, opens up new possibilities which one party may manage to exploit more successfully than the other.

Thus it can, perhaps, be compared to the television set. Both the computer and the television set were around for some time without having any appreciable effect on elections. Both are currently more widely spread, cheaper and efficient than before, and the uses of both in areas closely related to those involved in political campaigning are becoming more fully understood. There are those who contend that the television set determined the outcome of the 1960 elections by limiting the importance of the fact that Kennedy was not as widely known as Nixon at the beginning of the campaign, and by allowing Kennedy to take advantage of his better television image.

Similarly, the appropriate use of computers can help win (or lose) elections by providing new tools for fighting campaigns. However, the more widely these tools are understood, the less will be their influence for they will be used by both sides, and their effects may thus cancel each other out.

### Improving Efficiency of Democracy

However, it might well be argued that the computer will improve the efficiency and reliability of the democratic process. By making the consequences of their choices known to the leaders of both parties it makes a more rational selection from among these alternatives possible. Thus, to return to a previous example, if a computer program tells a party that it takes a considerable risk of losing the election by including a

lems  
of a  
ly  
of  
an  
com-  
n  
lip-  
nel.  
ES  
l.  
om  
of  
tim-  
a  
s  
i-  
meter  
ding,  
con-  
ected  
n is  
Ex-  
de-  
de-  
until  
of  
DES  
d.  
bin's  
Com-  
to  
ly  
out  
on  
ssion.  
sans  
of  
as  
prob-  
well  
lex  
ought  
- and  
war  
ve  
ain-  
ept-  
he

strong civil rights platform, it does not thereby tell that party to leave the plank out. Rather it makes it clear what the consequences of leaving it in are going to be on voters and makes it clear to that party what it is choosing. By making such consequences apparent to the policy makers in both parties, the com-

puter may contribute to making the policies of these parties more responsive to the actual wishes of the people. One may question whether or not this is desirable, but then one is questioning the validity of a notion basic to a democratic society. In a democratic society, this is, of course, one's privilege.

## WHO'S WHO IN THE COMPUTER FIELD — CUMULATIVE EDITION, 1962

Computers and Automation will publish this summer a cumulative edition of "Who's Who in the Computer Field." The closing date for receiving entries is June 30, 1962. If you are interested in computers, please fill in the following Who's Who entry form (which may be copied on any piece of paper) and send it to us for your free listing. If you have friends in the computer field, please call their attention to sending us their Who's Who entries. The cumulative edition will include only the entries

of persons who send us their Who's Who information.

Name? (please print) .....

Your Address? .....

Your Organization? .....

Its Address? .....

Your Title? .....

Your Main Computer Interests?

- Applications
- Business
- Construction
- Design
- Electronics
- Logic
- Mathematics
- Programming
- Sales
- Other (specify):

Year of birth? .....

College or last school? .....

Year entered the computer field? ....

Occupation? .....

Anything else? (publications, distinctions, etc.) .....

.....

.....

.....

.....

.....

.....

.....

.....

.....

.....

.....

.....

.....

.....

.....

.....

.....

.....

.....

.....

.....

.....

.....

.....

.....

.....

.....

.....

.....

.....

.....

.....

.....

.....

.....

.....

.....

.....

.....

.....

.....

.....

.....

.....

.....

.....

.....

.....

.....

.....

.....

.....

When you have filled in this entry form please send it to: Who's Who Editor, **Computers and Automation**, 815 Washington Street, Newtonville 60, Mass.

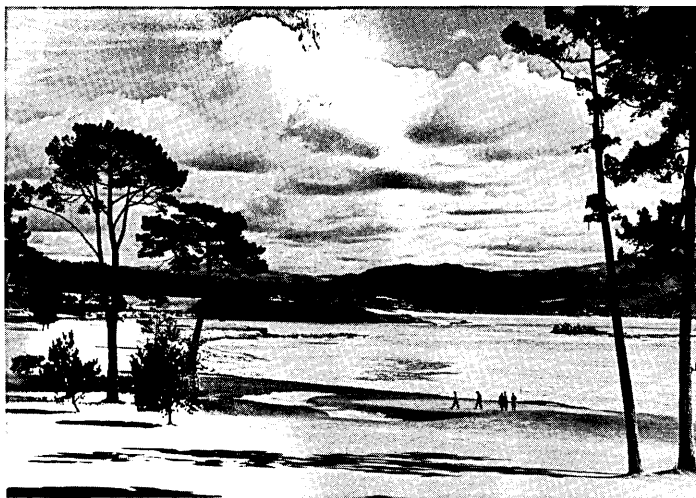

Expansion of our technical staff offers substantial growth opportunities for professional advancement in the areas of mathematical analysis and programming, systems design, and data handling.

Positions currently available at all levels for graduate mathematicians or physicists with large scale digital computer experience. Please send resume in complete confidence to:

**Mr. W. E. Daly, 305 Webster Street, Monterey, California**

**LABORATORY FOR ELECTRONICS, INC.**

**An Equal Opportunity Employer**

## SPACE SYSTEMS PROGRAMMING!

### *This May Be Your Opportunity*

Here you can work in a completely scientific atmosphere while enjoying the ideal climate and living conditions of beautiful Monterey Peninsula.

Just two hours from San Francisco in the heart of historic

### **MONTEREY, CALIFORNIA**

Laboratory For Electronics, Inc. programming staff is engaged in developing satellite tracking programs for research and operational applications.

# CITY TRAFFIC SIMULATED BY COMPUTER

National Bureau of Standards  
Washington 25, D. C.

The National Bureau of Standards has programmed high-speed data processing and display equipment to simulate traffic flow over a nine-block length of a principal traffic artery in downtown Washington, D. C. After information on volume of traffic and traffic controls has been fed into the system, the simulated traffic flow is tabulated on printouts and is also shown in a motion picture of simulated cars moving, changing lanes, and stopping for lights, as in a helicopter view of the actual streets. This result has been attained in a three-year program<sup>1</sup> conducted by M. C. Stark of the NBS data processing systems laboratory for the Bureau of Public Roads.

For some time the rapid increase of traffic on city streets has been a source of concern to traffic engineers and city planners. Municipalities must assume that streets now used to near capacity will have to carry even more traffic in the future. Thus traffic experts feel that detailed studies to correct congestion points—which even now are urgently needed—may become absolutely essential within perhaps the next decade. In such studies the problem is to determine the results of proposed changes in traffic control measures without actually disrupting traffic.

Automatic data processing to determine the optimum use, timing, and placement of traffic control devices appears to offer a promising approach to this problem. Simulation runs can be made with a computer to study the sensitivity of the traffic flow to proposed changes in the signal system and to explore the capacity of an existing system to handle different patterns or increased volumes of traffic. Many other traffic engineering situations—such as use of one-way streets, banning left turns, location of bus stops, and restriction of parking—also can be studied in this way.

## Previous Work

In 1956, H. H. Goode, of the University of Michigan, and his colleagues reported the use of computer techniques in traffic engineering<sup>2</sup> by setting up a computer model of two north-south and two east-west streets, both two-lane and two-way. All four intersections were signal-controlled and the route (straight through, right turn, or left turn) for each car was randomly assigned at each intersection. Each car was identical to all others and was represented by one binary digit or "bit"; all moved at the same speed and maintained the same spacing between cars. Traffic flow in the Goode model was presented in motion picture form for analysis.

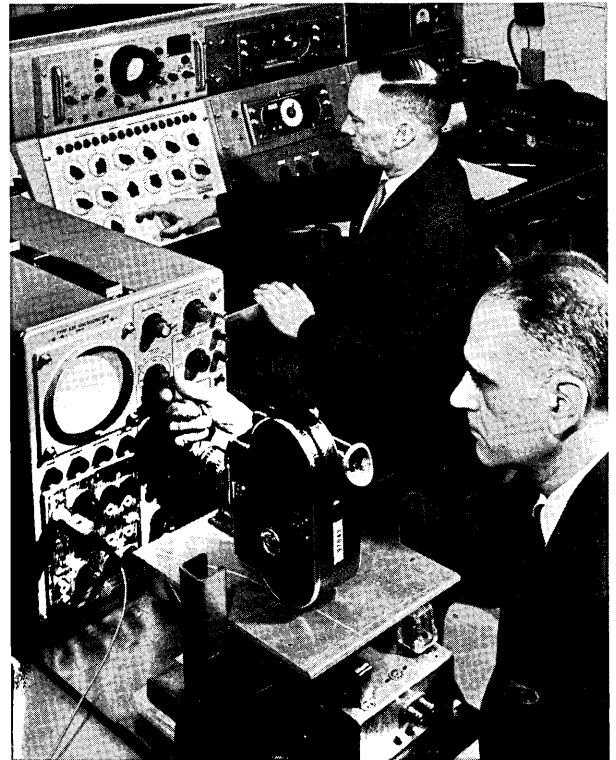

FIGURE 1

National Bureau of Standards computer scientists prepare to make a motion picture of an oscilloscopic presentation of city traffic simulated by a computer. The magnetic tape used as an input is obtained from a previous computer operation, which produces tabular printouts also.

## Configuration of Model

In 1958 the Bureau of Public Roads requested the National Bureau of Standards to conduct a traffic research study by means of a simulation model using several improvements over the earlier work as suggested by Professor Goode. The most significant improvement was the use of a computer "word" to permit the use of more variables and a planned route for each car instead of tabulating it as an undistinguished computer bit.

The model selected for use was based on a heavily traveled 0.6-mile stretch of Washington, D. C.'s 13th Street, N.W., which includes ten intersections from Euclid Street to Monroe Street. Seven of the intersections had traffic signals and three were controlled by stop signs at the east-west streets. The model in-

cludes several two-way cross streets (two at a 60° angle), one T-intersection, and several one-way cross streets. The study was restricted to the peak evening rush configuration in which all four lanes of 13th Street are used for northbound traffic.

Previously acquired traffic-survey information was used to determine the volume of cars traversing the entire course on 13th Street and those entering, crossing, and leaving it at each intermediate point. This permitted the computer program to show traffic composed of purposefully operated vehicles, each having a route assigned at the time of its generation.

The streets of the model were divided up into 12-foot long rectangles called "unit blocks." The unit blocks in each lane were numbered in sequence, from entrance to exit of the course and crosswise at each side street, so that any position could be given by unit block number. The computer required the position of each vehicle for each computation and assigned a new position (if changed) as part of each computation.

### Operation of Model

Vehicles of the model were "generated" at each of the possible entrances to the course by means of random number generators in proportion to their numbers in the real course. At the same time each vehicle was assigned characteristics determining its route and behavior in traffic, also by means of random number generation and in numbers corresponding to the proportions in actual traffic. Most vehicles used 13th Street as an artery, being generated below the simulated stretch and leaving it at its northern end. Each vehicle destined for the end of the course continued at its desired speed unless forced to reduce speed for traffic signals and slower traffic in the same lane; each continued in its original lane unless forced to change to avoid being slowed by overtaken vehicles.

The vehicles generated at each entrance to the model were described by two words in digital format. Characteristics determined at "launch time" included: *Time of departure* in  $\frac{1}{4}$ -second intervals; *type of vehicle*—automobile, small truck, or large truck; *exit point* to be used (determining the route); and *desired speed category*—15, 20, 25, 30, or 35 mph. All of these characteristics were chosen by means of random number selection from a series proportioned according to empirical knowledge.

Additional information was added within the vehicle two-word format as the computer surveyed the entire course at  $\frac{1}{4}$ -second real time intervals. Its computations determined for each vehicle the length of its "jump," or distance traversed during an interval, and assigned to each its new *actual speed* and *position*, given by its unit block number and the hundredths of the block length to which the vehicle's nose had penetrated.

FIGURE 2

A strip of four frames of motion picture of computer simulation of city traffic is here shown; it is obtained by photographing the oscilloscope screen. The model is formed by computer operations repeated for each  $\frac{1}{4}$ -second real-time interval. When processed and projected at 16 frames per second, the film presents the model operating in real time. Several runs of three complete 80-second traffic-light cycles (four minutes) were obtained by this method.

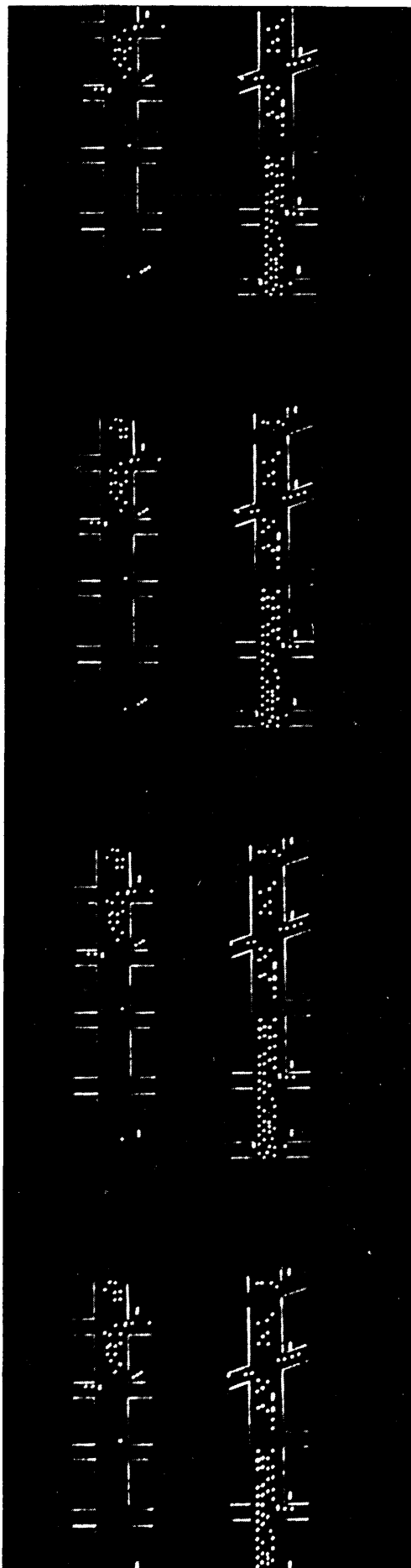



Vehicles approaching stopped vehicles in the same lane (where lane changing was not possible), a stop sign, or a red light were decelerated gradually; this took the form of  $\frac{1}{4}$ -second jumps of decreasing size. A stopped vehicle was identified by its two-word digital description showing a zero jump and indicating the same position at successive intervals.

When the distance between any two vehicles in the same lane became less than the allowable net clear sight distance determined by both vehicles' speeds, the net clear sight distances for the overtaking vehicle in the two neighboring lanes were determined as part of the computations of each  $\frac{1}{4}$ -second interval. The three alternatives (stay in lane, switch to right, or switch to left) were evaluated at each interval and the one chosen which best permitted the desired speed to be attained. The overtaking car was switched to the lane selected by being moved through progressive intermediate *straddle positions* during the time required to make the change. Vehicles obliged to stay in the same lane were gradually decelerated to the speed of the leading vehicle.

The routes assigned to vehicles at the time of generation determined their behavior in complex intersection situations. Westbound vehicles were not permitted to turn left (13th Street being one-way northbound) and hence could always proceed through or make a right turn in the lane determined by route or *lane preference* assigned at time of generation. Eastbound vehicles assigned a turn onto 13th Street were obliged to await a gap in westbound traffic. Those requiring a near or far lane because of a later turn waited to enter 13th Street on the appropriate lane. Those not assigned a later turn entered on the preferred lane (1 or 4), except for vehicles having a LANE 4 preference, which if blocked by oncoming traffic went on to enter at LANE 1, waiting there to turn if necessary.

Vehicles assigned a turn off of 13th Street were "coaxed" into the appropriate lanes when within 1200 feet (100 unit blocks) of the turn. A definite pattern of "last chance" unit blocks for each lane shift approaching each intersection was programmed into the computer. The cars made the necessary shifts in as rapid succession as possible when approaching the turning point, following the lane-switching rules.

### Computer Operation

The computer operation was performed by first programming the "rules of the road" into a high-speed computer and "filling" the model course with vehicles in a pre-production run. Several computer runs, each of three complete 80-second traffic light cycles (four minutes), were made. Sixty minutes of computer time was needed to process each run because of the many computations required—as many as 500 (in the complex lane-changing situation)—for more than a hundred vehicles each  $\frac{1}{4}$  second.

A magnetic tape recording of the simulation and four tabular printouts were obtained from the computer; all were used in later analysis. One of the printouts, the VEHICLE GENERATION TABLE, gives for each vehicle the launch time, the exit, the type of vehicle (car, truck 1, truck 2, or marked vehi-

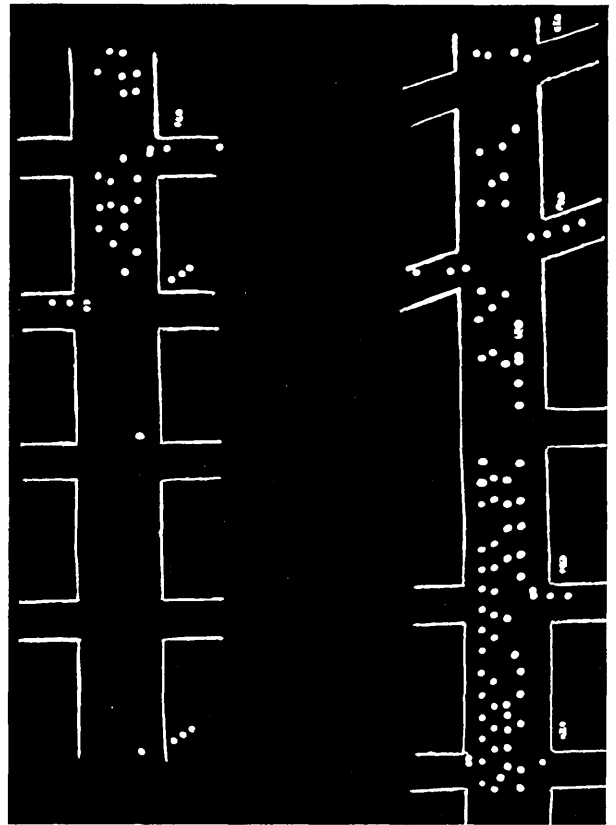

FIGURE 3

Single frame of motion picture produced at NBS in traffic simulation program shows traffic flow on map-like presentation. A 0.6-mile stretch of Washington, D. C.'s 13th Street, N.W., composed of four northbound (up) lanes, was simulated in this model and supplied the field data for operation and evaluation of the model. The course is photographed in two segments because of its shape, beginning at the lower left, the lower right continuing where the upper left ends, and ending at the upper right. Traffic lights are shown as a bar of three lights at northeast corners of some intersections; the vertical configuration indicates green for 13th Street traffic; horizontal, red; and diagonal, amber. The two lower traffic lights of the left-hand segment of 13th Street have just turned amber, the lower one being about to turn green for 13th Street traffic. The end of the platoon of cars just got through the middle light above on green, leaving only one car to be stopped for red. The green-light condition is continued for the entire upper half of the course, shown on the right. Single dots represent cars, double dots small trucks, and triple dots large trucks.

cle), the generating point, the desired speed, and the lane preference. Another printout, the STATION B CHECK, tabulates vehicles passing the maximum-load point of the course for comparison with empirical data. The third printout, the VEHICLE RETIREMENT TABLE, tabulates the individual running times and actual speed of vehicles completing the course in each lane, also for comparison with empirical data. Finally, the MARKED CAR CHRONOLOGICAL PRINTOUT gives the location of each marked car every  $\frac{1}{4}$  second for analysis of its progress.

The magnetic tape obtained from the computer was used to make a motion picture film of the simulated model in operation, resembling a helicopter view of traffic flow on the course. The tape supplied the input to the Bureau's SEAC computer, which operated an oscilloscope to produce a visual presentation of the computed vehicle movements. This presenta-

icient  
te the

am-  
t  
ener-  
in  
ted  
tem  
crip-  
ciated  
se  
re-  
object  
' in-  
a re-  
epen-  
the  
ooth  
of

ata  
mer-  
ibing  
own how  
otion  
ge and  
e map-  
erenced  
the  
data  
e ex-  
how,  
storage

s, the  
ref-  
c gen-  
ions

ghs  
am  
a re-  
g the  
that  
ence

tion was retained for repetition and analysis by triggering a 16-mm motion picture camera, mounted in front of the oscilloscope, for four frames to depict the situation at the completion of each 1/4-second real-time computation. The processed film, when projected at 16 frames per second, shows the simulated

traffic movement in the model for the four-minute run in real time.

### Analysis of Results

Analysis of the tabular data and the film showed that the computer program caused the "vehicles" to behave in what seems to be a very realistic manner. They stopped at red lights, yielded right of way at stop signs, moved at various speeds, maneuvered for turns and to overtake slower cars, and formed queues when necessary; in short they did most of the definable things that are done by real cars in city traffic. During runs of the model, vehicles actually came to a stop if they reached the last chance position without making the lane shift, just as seen occasionally in real traffic.

The simulation technique has produced a model which apparently can be made to correspond reasonably well with actual field situations. Thorough evaluation of the model will require new field data, as traffic on 13th Street has changed considerably since the original counts were made. When validated this technique will be useful in predicting the detailed effects on traffic flow due to changed parameters—moved or removed bus stops, altered signal light timing, and the like. Computer simulation will make possible experimental manipulation of traffic situations without the possibility of snarling the real traffic. Most important, experimental manipulation of traffic loads in models of today's streets should make it possible to estimate how long these streets can be used without change and to predict what changes will then be needed.

1. Computer simulation of street traffic, by M. C. Stark, NBS Technical Note 119.
2. The use of a digital computer to model a signalized intersection, by H. H. Goode, C. H. Pollmar, and J. B. Wright, in Proceedings of Highway Research Board, 1956, vol. 35, pp. 548-557.

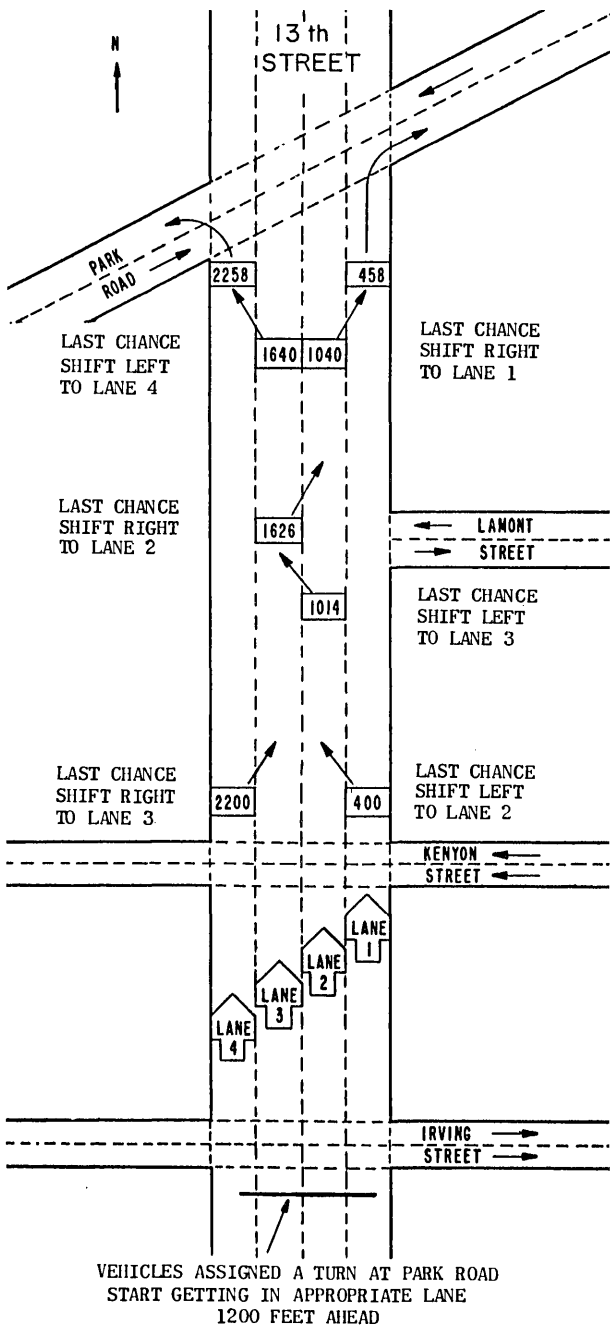

FIGURE 4

Vehicles in NBS computer simulation of city traffic were programmed to prepare for turns assigned them by trying to get into the correct lane 1200 feet before arriving at the turn intersection. The map of part of Washington's 13th Street shows, for cars planning turns at Park Road (top), the start-preparation line (bottom). The numbers in the lanes are the course "unit block" numbers of the "last-chance" positions to make lane shifts in preparation for these turns. The left shift at UB 1014 is offset from the right shift at UB 1626 to avoid the possibility of a stalemate. Vehicles were programmed to slow to a stop at the last-chance position if prevented by traffic from making a lane shift needed for their turn.

For instructions, see page 6.

**BUSINESS REPLY LABEL**

NO POSTAGE STAMP NECESSARY IF MAILED IN THE UNITED STATES

**5c POSTAGE WILL BE PAID BY**

**BERKELEY ENTERPRISES, INC.**

815 Washington St.  
Newtonville 60, Mass.

FIRST CLASS  
Permit No. 33531  
BOSTON, MASS.

# LIST OF EXHIBITORS

## AT THE

### 1962 SPRING JOINT COMPUTER CONFERENCE

- Aeronutronic, Div. of Ford Motor Co., Ford Road,  
Newport Beach, Calif. / ORiole 5-1234 / 512-513
- AMP, Inc., Harrisburg, Pa. / JORDAN 4-0101 / 217-  
219, 317-319
- Ampex Corp., 934 Charter St., Redwood City, Cal-  
if. / EMerson 9-7111 / 505-508
- ANElex Corp., 150 Causeway St., Boston 14, Mass.  
/ RIchmond 2-1720 / 204-205
- Applied Dynamics, Inc., Box 612, Ann Arbor, Mich.  
/ NO 2-4493 / 511
- Automatic Electric Sales Corp., Northlake, Ill.  
/ FILLmore 5-7111 / 412-413
- Bell Telephone System, Pacific Telephone Co. &  
Long Lines Dept., San Francisco, Calif. / 107-  
109
- The Bendix Corp., Bendix Computer Div., 5630 Arbor  
Vitae St., Los Angeles 45, Calif. / ORchard  
0-3640 / 501-504
- Berkeley Div. of Beckman Instruments, 2200 Wright  
Ave., Richmond, Calif. / LA 6-7730 / 308
- Brush Instruments, Div. of Clevite Corp., 37th &  
Perkins Ave., Cleveland 14, Ohio / ENdicott 1-  
3315 / 802
- Bryant Computer Products, 850 Ladd Rd., Walled  
Lake, Mich. / MARket 4-4571 / 105-106
- The Bureau of National Affairs, Inc., Washington,  
D.C. / 304
- Burrughs Corp., 6071 Second Ave., Detroit 32,  
Mich. / TRinity 5-2260 / 704-706
- California Computer Products, Inc., 8714 Cleta  
St., Downey, Calif. / SPRuce 3-4921 / 417-418
- C-E-I-R, Inc., New York, N. Y. / 823-824
- Collins Radio Co., Dallas, Texas / 815-818
- Comcor, Inc., Denver, Colo. / 514
- Computer Control Co., Inc., Los Angeles, Calif.  
/ 410-411
- Computer Systems, Inc., Culver Rd., Monmouth Jct.,  
N.J. / DA 9-2351 / 609-610
- Consolidated Electrodynamics Corp., 360 Sierra  
Madre Villa, Pasadena, Calif. / MURray 1-8421  
/ 820
- Control Data Corp., 501 Park Ave., Minneapolis,  
Minn. / FEderal 9-0947 / 201-203
- Datamation, 141 E. 44 St., New York 17, N.Y. /  
305
- Data Products Corp., Culver City, Calif. / 616-618
- Datapulse, Inc., 509 Hindry Ave., Inglewood 1,  
Calif. / 415
- DI/AN Controls, Inc., 944 Dorchester Ave., Boston  
25, Mass. / 611
- Digital Equipment Corp., Main St., Maynard, Mass.  
/ TWinoaks 7-8821 / 211-214
- Digitronics Corp., 10 E. 40 St., New York 16, N.Y.  
/ 401-403
- Dymec, Div. of Hewlett-Packard Co., 1501 Page Mill  
Rd., Palo Alto, Calif. / DAVenport 6-7000 / 903
- Electro Instruments, Inc., Sunnyvale, Calif. / 515
- Electronic Associates, Inc., Long Branch Ave.,  
Long Branch, N.J. / CAPital 9-1100 / 404-405
- Electronic Engineering Co. of California, 1601 E.  
Chestnut Ave., Santa Ana, Calif. / KIMberly 7-  
5501 / 315
- Electronic Memories, Inc., 9430 Bellanca Ave.,  
Los Angeles 45, Calif. / 701
- Engineered Electronics Co., 1441 E. Chestnut Ave.,  
Santa Ana, Calif. / KIMberly 7-5651 / 313-314
- Epsco, Inc., 275 Mass. Ave., Cambridge 3, Mass. /  
UNiversity 4-4950 / 215-216
- Fabri-Tek, Inc., Amery, Wis. / 416
- Fairchild Semiconductor Corp., 545 Whisman Rd.,  
Mountain View, Calif. / YORkshire 8-8161 / 406-  
407
- Ferranti Electric, Inc., Industrial Park #1,  
Plainview, L.I., N.Y. / 509
- Friden, Inc., 2350 Washington Ave., San Leandro,  
Calif. / NEptune 8-0700 / 102-104
- General Dynamics/Electronics, Information Tech-  
nology Div., 1895 Hancock St., San Diego 12,  
Calif. / CYpress 8-8331 / 112-114
- General Electric Co., Computer Dept., 13430 No.  
Black Canyon Highway, Phoenix, Ariz. / WINDsor  
3-2351 / 808-811
- The Hallicrafters Co., Berwyn, Ill. / 902
- Indiana General Corp., Electronics Div., Memory  
Products Dept., Keasbey, N.J. / 110-111
- Informatic, Inc., Culver City, Calif. / 616-618
- International Business Machines Corp., 590 Madi-  
son Ave., New York 22, N. Y. / 601-605
- ITT Information Systems Div., International Tel-  
ephone and Telegraph Corp., New York, N.Y. /  
803-804
- Invac Corporation, 26 Fox Road, Waltham 54, Mass.  
/ 899-2380 / 517
- Kearfott Div., General Precision, Inc., Little  
Falls, N.J. / 316
- Laboratory for Electronics, 1079 Commonwealth  
Ave., Boston 15, Mass. / ALgonquin 4-4235 /  
208-209
- Litton Systems, Inc., 336 No. Foothill Rd., Bev-  
erly Hills, Calif. / CR 4-7411 / 812-813
- McGraw-Hill Book Co., Inc., Corte Madera, Calif.  
/ 518
- Memorex Corporation, Santa Clara, Calif. / 801
- Moxon Electronics Corp., Beverly Hills, Calif. /  
516
- National Cash Register Co., Main & K Sts., Dayton,  
Ohio / BALdwin 6-1411 / 206-207, 306-307
- North American Aviation, Inc., Los Angeles, Calif.  
/ 807
- Omnitronics, Inc., 511 N. Broad St., Phila. 23,  
Pa. / WALnut 5-4343 / 819
- Packard Bell Computer Corp., 1905 Armacost Ave.,  
Los Angeles 25, Calif. / BR 2-9161 / 612-615

Philco Corporation, Computer Div., Philadelphia, Pa. / 606-608  
 Photocircuits Corporation, 31 Sea Cliff Ave., Glen Cove, N.Y. / 814  
 Potter Instrument Co., Inc., Sunnyside Blvd., Plainview, L.I., N.Y., / Overbrook 1-3200 / 702-703  
 Raytheon Company, Waltham, Mass. / 821-822  
 Radio Corporation of America, Semiconductor and Materials Div., Route 202, Somerville, N.J. / Randolph 2-3200 / 825-826  
 Remington Rand UNIVAC, 315 Park Ave. So., New York 10, N.Y. / Spring 7-8000 / 301-303  
 Rese Engineering, Inc., "A" and Courtland Sts., Phila. 20, Pa. / GL 5-9000 / 510  
 Rheem Electronics, Div. of Rheem Manufacturing Co., Los Angeles, Calif. / 210

Rotron Manufacturing Co., Inc., Hasbrouck Lane, Woodstock, N.Y. / Oriole 9-2401 / 901  
 Royal McBee Corp., 850 Third Ave., New York 22, N.Y. / 805-806  
 Scientific Data Systems, Inc., Santa Monica, Calif. / 309-310  
 The Service Bureau Corp., 425 Park Ave., New York 22, N.Y. / Plaza 1-5600 / 414  
 Soroban Engineering, Inc., Box 1717, Melbourne, Fla. / Parkway 3-7221 / 408-409  
 Tally Register Corp., 1310 Mercer St., Seattle 9, Wash. / Main 4-0760 / 311-312  
 Teletype Corporation, 5555 Touhy Ave., Skokie, Ill. / Orchard 6-1000 / 904-905  
 John Wiley & Sons, Inc., 440 Park Ave. So., New York 16, N.Y. / 101

## LOCATIONS OF EXHIBIT AREAS

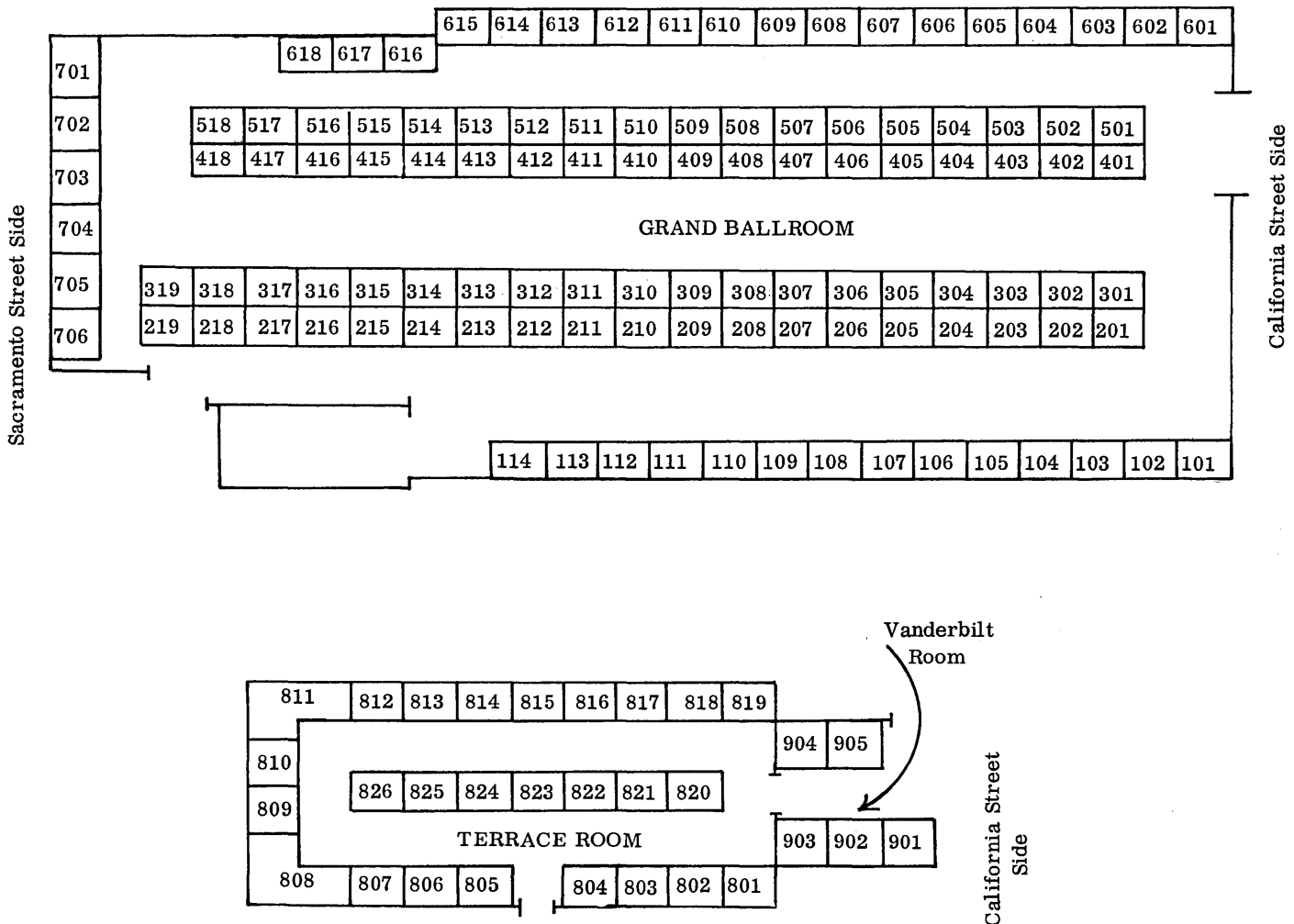

Integrat  
 grammi  
 ing th  
 plex o  
 tem in  
 same t  
 ance n  
 for al  
 during  
 Navy T  
 duced  
 using  
 in the  
 this a  
 comput  
 ated w  
 cuntry  
 final  
 facili  
 toring  
 minimu  
 a syst  
 high d  
 the sy  
 Chairm  
 enc  
 Ann  
 Paneli  
 tro  
 Cal  
 Eng  
 Mei  
 Cit  
 Lab  
 del  
 T  
 intell  
 accur  
 in cur  
 T  
 this s  
 plicat  
 proble  
 duce i  
 serve  
 in sol  
 comput

# 1962 SPRING JOINT COMPUTER CONFERENCE — PROGRAM

Fairmont Hotel, San Francisco, Calif.

May 1-3, 1962

## OPENING SESSION

Tuesday, May 1 -- 10 a.m. to 12 noon  
Gold Room

Introduction: Dr. Richard I. Tanaka, Lockheed Missiles and Space Co., Program Chairman of 1962 SJCC

Opening Remarks: George A. Barnard, Philco Western Development Laboratories. General Chairman of 1962 SJCC / Dr. Willis H. Ware, Rand Corporation, Chairman of AFIPS Governing Board

Keynote Address: Dr. Edward Teller, Professor of Physics at Large, University of California, Berkeley, Calif.

## SESSION A

Tuesday, May 1 -- 2 p.m. to 5 p.m.  
Venetian Room

### Study of Business Information Systems

Chairman: Fred M. Tonge, Stanford University

Panelists: C. B. McGuire, University of California, Berkeley, Calif. / Richard L. Van Horn, The Rand Corporation, Santa Monica, Calif.

Organizations have always had information systems. The computer has focussed increasing attention on these systems by magnifying both their potential benefits and their directly attributable costs. Since the problems of constructing, using and improving these systems are largely ill-structured, optimizing techniques that have served in other areas cannot be transferred intact. There is much to learn about how to effect such systems and about how they affect the organization.

Within the framework of the study of business information systems we propose the following areas for specific discussion, to relate the formal papers and to explore their implications.

1) What useful formal descriptions exist of business information systems, and what techniques are available for manipulating and extracting consequences from such formal descriptions? 2) What specific studies have been made of these systems, and what are their implications? 3) Of what relevance are disciplines such as information theory, theory of teams, feedback control systems theory? 4) What will be the impact of hardware and programming developments in such areas as

display systems, pseudo-English input, etc? 5) What is the appropriate division of research between industry and the university? 6) How can we best profit from the ongoing diverse systems activities in industry?

Toward a General Simulation Capability

Michael R. Lackner  
System Development Corporation  
Santa Monica, Calif.

Simulation of a system by digital computer requires a model of the system which is intelligible to the student of the system while compatible with the limitations of the computer, translation of the model to computer code, movement of the model through time, recording the performance of the model.

SIMPAC, a "simulation package," incorporates coherent techniques and devices for the accomplishment of these objectives: modeling concepts for building a computer-compatible model, a vocabulary for encoding the model, a computer program for moving the model through time and recording its performance, and an output presentation program.

A model of an hypothetical business system has been implemented with the first version of SIMPAC for the purpose of studying management controls in a complex system.

This paper discusses digital simulation and SIMPAC, and introduces modeling concepts which may lead to a set of simulation systems which would assemble models of varying complexity from descriptive statements and analyze the models prior to simulation.

A Non-Linear Digital Optimizing Program for Process Control

Raymond A. Mugele  
IBM Corporation  
San Jose, Calif.

A new program has been developed for optimizing a computer-controlled process. This program applies probing and restraint-following algorithms which permit solving the optimization problem in difficult cases. These cases include non-linear or discontinuous restraint functions, and non-convex domains.

The program requires relatively little storage for program and data, and no special modifications of objective or restraint functions. It

# Meet our new heavyweight

Here's the newest entry in our line-up of computers: the Honeywell 1800 Series. The 1800 is a heavyweight champ from the word go. It has the speed, capacity and capability to handle the very biggest business, scientific or real-time applications. If you're familiar with the Honeywell 400 and 800 computers, you're already aware of many of the advantages of the 1800. Some of these are: Parallel Processing, Orthotronic Control, FACT, vacuum-actuated tape units, control memory, Polyphase and Cascade sort techniques, and COP. This heritage is important. But so are the many new features. Especially if you have a big job in mind. Here, then, are the highlights of the new Honeywell 1800:

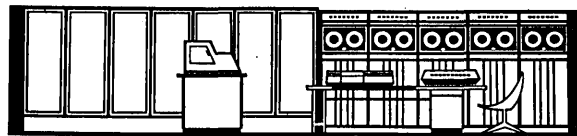

men in  
can an  
extend  
behavi  
comple  
genera  
be bet  
when i

A  
orator  
how th

Chairma  
Mass  
ing

Panelis  
Jr.  
Jos  
Med

TI  
problem  
system  
availab  
tion.  
mental  
models  
cation  
to anal  
ena obs  
systems  
and met  
systems  
the pr  
others.

Prob

A  
and the  
study o  
are il  
certain  
behavi  
groups  
observ  
from e  
cussed  
perime  
larly  
comput  
featur  
problem  
some o

COMPT



## 2-microsecond memory cycle time

The 1800 Central Processor (Model 1801) has an internal operating speed of more than 120,000 three-address operations per second for typical arithmetic instructions such as additions and subtractions. Memory cycle time is two microseconds. Memory modules contain 8,192 48-bit words, and up to four modules may be utilized (maximum of 262,144 alphabetic characters or 393,216 decimal digits). As in the Honeywell 800, a separate control memory containing 256 special registers automatically supervises simultaneous and parallel execution of as many as eight independent programs. These can be business or scientific programs or a mixture of both.

## Nanosecond floating-point option

An optional floating-point unit for the H1800 (Model 1801B) makes extensive use of tunnel diode circuitry and achieves speeds up in the nanosecond range. The Honeywell floating-point word utilizes a 40-bit mantissa and a 7-bit exponent, permitting a range of values from  $10^{-65}$  to  $10^{65}$  in decimal, or from  $10^{-78}$  to  $10^{76}$  in binary. Nanosecond speeds, plus the ability to work in fixed or floating-point arithmetic give the 1800 an outstanding scientific and real-time capability. Couple this with its bent for business data processing and its ability to run independent jobs in parallel, and you begin to see what a real work horse the H1800 can be.

## Complete software package now ready

The Honeywell 1800 has the same command list and instruction format as the Honeywell 800. Thus the two systems are completely compatible and all Honeywell 800 software is immediately usable for the 1800. This includes machine-oriented assembly systems, problem-oriented

business and scientific compilers and COP (Computer Optimization Package), a collection of programming aids that greatly increases the day-to-day operating efficiency of Honeywell computers.

## Your pick of peripheral units

The Honeywell 1800 uses the same peripheral units as the Honeywell 800. In addition to high-density magnetic tapes (133,000 digits per second), available units include card readers and punches, optical scanners, paper tape readers and punches, high-speed printers, and data transmission controls. The magnetic tape units, in addition to speed, feature exceptionally gentle vacuum-drive mechanisms, variable length records, fast rewind, and speedy tape changing. There are no untried units here. All have been thoroughly tested in extensive field use.

## Just feel our muscle now

The addition of the 1800 tops off our broad line of magnetic tape computers. For those taking their first EDP steps or maybe adding a satellite to a central computing system, there's the Honeywell 400. For full-scale solid-state processing with 8-jobs-at-once efficiency there's the Honeywell 800. Now the Honeywell 1800 brings nanosecond speeds to bear on the biggest business, scientific or real-time problems. For more information contact any Honeywell EDP sales office or write to Honeywell EDP, Wellesley Hills 81, Mass. In Canada, Honeywell Controls Limited, Toronto 17, Ontario.

# Honeywell



*Electronic Data Processing*

is primarily applicable to some medium-sized digital computers now used in process control.

Various control strategies are compatible with this program. It can be used to generate an operator guide for a process operating in the steady state. It can also be used for optimizing the control of a process with perturbed inputs, i.e., in the transient state. It can also be interrupted, before completion, in order to determine the degree of improvement available, or to impose new restraints.

#### A Simulation of a Business Firm

Charles P. Bonini  
Graduate School of Business  
Stanford University

This paper describes a simulation model of a hypothetical business firm. The model was constructed to include not only the accounting and economic factors of costs, profits, sales, units produced, etc., but also psychological and behavioral concepts. Individuals in the firm have aspiration levels, feel pressure, and react in accordance with behavioral theory.

The purpose of the model is to study the effects of informational and organizational factors upon the decisions of a business firm. We have had limited knowledge of such variables as: the effects of tardy information, the effects of different distributions of information within the firm, the effects of differing degrees of centralization or decentralization, etc. A comprehensive model, such as the one proposed, is necessary to answer such questions.

Eight specific hypotheses involving changes in the organization and information system of the firm were formulated and tested using a factorial experimental design. The results of this experiment demonstrate the usefulness of this model as a research tool.

#### SESSION B

Tuesday, May 1 -- 2 p.m. to 5 p.m.  
Gold Room

#### Theoretical Problems in Artificial Intelligence

Chairman: Russell A. Kirsch, National Bureau of Standards, Washington, D.C.

Panelists: Edward A. Feigenbaum, University of California, Berkeley, Calif. and Rand Corporation, Santa Monica, Calif. / Marvin L. Minsky, Computation Center, Massachusetts Institute of Technology, Cambridge, Mass. / Norman Z. Shapiro, National Institutes of Health, Bethesda, Md.

The three papers in this session represent contributions to artificial intelligence from diverse sources. Ernst draws upon techniques related to heuristic programming to solve a problem in tactile and visual sensing and control of a

real environment. Reiss draws from classical associationist psychology to provide models for machines that would exhibit association of ideas. Cannonito draws from mathematical logic to study the nature of fundamental limitations on the behavior of intelligent machines.

The papers and the subsequent discussion will be directed more to the specialist in artificial intelligence than to the specialist in the source disciplines from which the contributions derive. To the computer specialist this session will be of interest because artificial intelligence research makes essential use of computers in non-trivial ways and because some of the by-products of such research (most notably the design of programming languages) contribute directly to the further development of computers.

#### MH-1, a Computer-Operated Mechanical Hand

Heinrich A. Ernst  
IBM Research Laboratory  
San Jose, Calif.

MH-1 is a motorized and sensitized servomanipulator operated by the TX-0 computer at the Massachusetts Institute of Technology. Unlike in a conventional digital control system, the computer in the MH-1 system is not used to process quantitative information. Its function is rather to perceive and appreciate the environment of the hand qualitatively. On this basis, the computer determines a reasonable course of action after a goal has been specified for the hand.

Because of the automatic execution of these higher control functions, the system, by itself, in its attempt to reach that goal, behaves sensibly even in unexpected situations for which no explicit instructions have been given. For example, it makes reasonably successful attempts to resolve inconsistencies between the plan of action and the situation in the environment, it finds a way around obstacles hindering the hand, or it accepts help from a human assistant without fighting back, but it still resists unwanted interference. A film of MH-1 in action, demonstrating these properties, will be shown.

#### An Abstract Machine Based on Classical Association Psychology

Richard F. Reiss  
Librascope Division  
General Precision, Inc.  
Glendale, Calif.

Classical association psychology (circa 1750-1900) described, and proposed to explain, human thought processes in terms of a few kinds of forces operating on discrete entities called "sensations," "images," "ideas," etc. The classical theory was not given a precise, quantitative formulation and has been generally abandoned for a variety of reasons. However, the problem of developing artificial intelligence in digital machines provides new grounds for evaluating and perhaps extending association theory.

Or  
postula  
the fun  
and ana  
minimal  
its beh  
finite  
types o  
modifie  
"attent  
by the  
regist  
over-si  
theory,  
haviora

TH  
Incompl  
incapab  
The pap  
limit m  
belief,  
set of  
appeali  
basic i  
itial fi  
tive se  
after s  
sets of  
nique,  
is defi  
set of  
consist  
given a  
stated  
compute

TH  
cept of  
Moore,  
argue t  
tegers  
under s  
as remo  
chines  
Incompl

Chairma  
Mass  
ingt

Panelis  
Inc.  
Thor  
Yorl

One method of evaluation is the synthesis by postulation of abstract "machines" which reflect the fundamental insights of association theory, and analyses of their behavior. In this paper a minimal machine is defined and certain aspects of its behavior are examined. It is restricted to a finite system of discrete objects coupled by two types of associative bonds, some of which are modified by passage of the objects through an "attention" register. The system grows in size by the admission of new objects via a "sensory" register. Although this "machine" constitutes an over-simplified interpretation of association theory, it does display some of the diverse behavioral potentialities of such systems.

The Gödel Incompleteness Theorem and Intelligent Machines

Frank B. Cannonito  
Grumman Aircraft Engineering Corp.  
Bethpage, N.Y.

This paper considers whether or not Gödel's Incompleteness Theorem implies that machines are incapable of operating as intelligent robots. The paper's view is that the theorem does not limit machines in this sense. To support this belief, the concept of a recursively enumerable set of integers is developed via the intuitively appealing properties of programs made up from basic instructions similar to the well-known initial functions of primitive recursion. Productive sets of integers are then introduced and after some remarks relating formal languages to sets of integers via the Gödel numbering technique, a formal axiomatic arithmetic language L is defined and the recursive enumerability of L's set of theorems is asserted. The notions of consistency and interpretation of L are then given and Gödel's Incompleteness Theorem is stated and interpreted vis-à-vis digital computers.

The paper then attempts to modify the concept of a program so that the theorem of De Leeuw, Moore, Shannon and Shapiro can be introduced to argue that nonrecursively enumerable sets of integers can be generated by the modified programs under suitable restrictions. This is regarded as removing the restrictions on the use of machines as creative robots, implied by the Gödel Incompleteness Theorem.

SESSION C

Wednesday, May 2 -- 9 a.m. to 12 noon  
Venetian Room

Digital Storage and Circuits

Chairman: Jack I. Raffel, Lincoln Laboratory,  
Massachusetts Institute of Technology, Lexington, Mass.

Panelists: Kent D. Broadbent, American Systems, Inc., Inglewood, Calif. / Munro K. Haynes, Thomas J. Watson Research Center, IBM Corp., Yorktown Heights, N.Y.

The session on digital storage and circuits will emphasize the continuing attempt on the part of components designers to perform more complicated functions faster and cheaper. Two of the papers are devoted to cryogenic associative memory work, the third to a technique for high-speed transistor logic. While they represent widely different ends of the component spectrum with respect to environment, switching speed, stage of development and familiarity, they, as well as all other developments, will be measured ultimately in common units of bits, dollars, and microseconds. It is hoped that this session will make some contribution to this difficult process of evaluation.

A Superconductive Associative Memory

Paul M. Davies  
Abacus, Inc.  
Santa Monica, Calif.

The general properties of an associative memory are explained, and their advantages relative to a random access memory discussed. Then a superconductive mechanization of such a memory is described which is based upon the cross film cryotron. The memory requires 5 cryotrons per bit and 9 cryotrons for a control module associated with each word. Any combination of bits of the word can be used as the key, and any number of records in the memory can be identified and read out as the result of a single association. The speed of various circuitry in the memory is approximated and some applications are suggested.

A Cryogenic Data Addressed Memory

V. L. Newhouse  
General Electric Research Laboratory  
Schenectady, N.Y.

and

R. E. Fruin  
General Electric Heavy Military Electronic Dept.  
Syracuse, N.Y.

A computer storage system which is addressed by content rather than location is described. The design has been verified by constructing and successfully operating a three-word module consisting of 81 crossed-film-cryotrons on a six-inch by three-inch substrate.

Circuits for the FX-1 Computer

Kenneth H. Konkle  
Massachusetts Institute of Technology  
Lexington, Mass.

A set of circuits capable of 50 megapulse operation is described. Included are gated and mixing pulse amplifiers, a static flip-flop, a diode logic unit with current-steering amplifier, a passive delay line, and an active variable delay circuit; all of which are designed to operate with terminated 75 ohm transmission lines. Ten nsec. pulses and 20 nsec. flip-flop transition times are provided through use of very-high-speed

MADT transistors. The circuits have been successfully employed in the FX-1, a small general purpose computer with high-speed magnetic film memory.

#### SESSION D

Wednesday, May 2 -- 9 a.m. to 12 noon  
Gold Room

#### Man-Machine Cooperation

Chairman: Douglas C. Engelbart, Stanford Research Institute, Menlo Park, Calif.

Panelists: Frederick P. Brooks, Jr., IBM Corp., Poughkeepsie, N.Y. / Richard S. Hirsch, IBM Corp., San Jose, Calif. / Herbert Martin Teager, Massachusetts Institute of Technology, Cambridge, Mass.

Bringing the human into on-line association with the computer, to interact in real time, is a trend motivated by several goals. Computerized systems, with real-time missions, often need to utilize some of the still-unique human capabilities, such as pattern recognition and judgment. Here the goal is to get best possible system performance, and the problem in the man-machine relationships is to try to couple the man in the best manner to this end. This goal has prompted most of the man-machine work to date.

Another goal, still to be generally appreciated and pursued, is that of extending the individual human's self-directed problem-solving capability by means of more intimate cooperation with the computer. This session is concerned, relative to both goals, with the current possibilities and problems of real-time, on-line, man-computer cooperation.

#### On-Line Communication Between Man and Computers

J. C. R. Lickliger  
Bolt Beranek and Newman, Inc.  
Cambridge, Mass.

and

Welden Clark  
Bolt Beranek and Newman, Inc.  
Los Angeles, Calif.

The paper first reviews briefly the main problems and existing techniques of on-line communication between men and computers, and then describes three current developments:

1. A time-sharing system that permits several operators with independent problems to use one computer simultaneously, each operator having sensibly continuous access to its facilities.
2. A set of programs and techniques to facilitate planning and design of buildings.
3. Techniques that provide pictorial displays of what is going on inside the computer and reveal basic characteristics of traced-operating programs.

The paper concludes with a brief discussion of man-computer communication problems that call for basic advances in concept and hardware.

#### Solution of Non-Linear Integral Equations Using On-Line Computer Control

Glen J. Culler  
Ramo-Wooldridge, a Division of  
Thompson-Ramo-Wooldridge  
Canoga Park, Calif.

and

Robert W. Huff  
University of California  
Radiation Laboratory  
Berkeley, Calif.

This paper contains results from some computer experiments performed as part of a study concerning more effective utilization of computers as research tools for scientific problems. A display and analysis console permitting direct control of the computer was used to solve a non-linear integral equation occurring in the Bardeen-Cooper-Schrieffer theory of superconductivity. This equation gives the energy gap in a superconductor as a function of energy after three physical parameters have been specified. In each case, the method of solution was constructed by the problem solver through direct interaction with the computer, the strategy of solution of each stage being based on information obtained from the computer in the course of the solution process. Thus, characteristic features of the problem and the pitfalls involved were discovered and controlled during the process of solution.

According to the parameter values specified, the problems ranged from very easy to quite difficult, and thus provided a basis for testing our approach. Extension of this technique to other digital equations, to more general one-dimensional problems, and to a wide class of physical and mathematical problems appears entirely feasible.

#### Are the Man and the Machine Relations?

Burton R. Wolin  
System Development Corporation  
Santa Monica, Calif.

As environments requiring control have become more complex, and the speeds of events in those environments have increased, there has been a trend to use computers to supplement or replace men or the functions they have traditionally performed.

The decision as to how to use computers in systems has been influenced by beliefs about what men can and cannot do or should and should not do.

Additionally, attempts to employ computers have frequently failed because not enough has been known, either about the function, or how to program the computer to perform the function.

A research program is described which has two objectives: First, to study the behavior of

men in complex environments to find out what they can and cannot do well, and what factors limit or extend their effectiveness. Second, to study the behavior of men to determine how they perform complex functions, using the men as analogues of general-purpose computers, so that computers can be better programmed to perform such functions when it is necessary to do so.

A brief description of the computerized laboratory in which the research is being done, and how the laboratory is being used, is included.

#### SESSION E

Wednesday, May 2 -- 2 p.m. to 5 p.m.  
Venetian Room

#### Data Analysis and Model Construction in the Study of the Nervous System

Chairman: Belmont G. Farley, Lincoln Laboratory,  
Massachusetts Institute of Technology, Lex-  
ington, Mass.

Panelists: T. H. Bullock, UCLA / M. H. Goldstein,  
Jr., Massachusetts Institute of Technology /  
Josiah Macy, Jr., Albert Einstein College of  
Medicine, New York City, N.Y.

The complexity and non-linearity of the problems encountered in the study of the nervous system make necessary the use of the most capable available tools for progress toward their solution. Problems arise both in processing experimental data, and in constructing theoretical models. The theme of this session is the application of advanced analog and digital techniques to analysis and synthesis of experimental phenomena observed in both animal and human nervous systems. Emphasis will be placed on problems and methods peculiar to the study of biological systems, but an attempt will be made to assess the present status of the field and relate it to others.

#### Problems in the Study of the Nervous System

Belmont G. Farley  
Lincoln Laboratory  
Massachusetts Institute of Technology  
Lexington, Mass.

A survey is given of the main experimental and theoretical difficulties encountered in the study of the nervous system. These difficulties are illustrated by specific examples of the uncertainties still existing in knowledge of the behavior of neurons, both individually and in groups, and in the interpretation of experimental observations. Concepts of the reduction of data from electrophysiological experiments are discussed and compared with those in physical experiments. Some theoretical problems are similarly treated. Examples of analog and digital computers having both special and general-purpose features which have been used to attack these problems are given, with a brief discussion of some of the results.

#### Neural Analogs

Leon D. Harmon  
Bell Telephone Laboratories, Inc.  
Murray Hill, N.J.

Information processing in the nervous system is receiving increasing attention by researchers in the communications sciences. One of the most prolific areas of activity has been neural modeling. Simple electrical and mathematical models were described over half a century ago; in recent years there has been a growing array of chemical, electronic, mathematical and computer-simulated analogs.

Two quite different kinds of neural modeling have resulted. In one category the intent is to simulate the complex parameters of the biological original closely in order to consider functions of the nervous system, hopefully to supplement neuro-physiological research. In the second kind of neural modeling the idea is to explore the single-element logical behavior or the self-organizing properties of ensembles of relatively simple quasi-neural elements.

It is the purpose of this paper to emphasize the differences between these two approaches, to review briefly some of the main streams of activity in neural modeling, and to show, by way of example, the results of one particular line of investigation -- the work dealing with real-time electronic neural analogs.

#### The Caudal Photoreceptor of the Crayfish: A Quantitative Study of Responses to Intensity, Temporal and Wavelength Variables

William R. Uttal  
IBM Research Center  
Yorktown Heights, N.Y.

This paper describes the results of a study which has been made of the caudal photoreceptor of the crayfish. Pooled pulse potentials evoked by photic stimuli were recorded from the ventral nerve cord and these data digitized and recorded on magnetic tape. A digital computer was then used to analyze the data and recognize certain specific features. The coding of the nerve action potentials, as a function of the stimulus dimensions, was investigated and it was determined that the stimulus amplitude-response magnitude relation was a power function with the same exponent as that found in human perception. Furthermore, the spectral luminosity curve was determined to coincide with that of the human eye.

The similarities of these two functions suggest a common photochemical medium which thus allows a detailed study to be made of these human perceptual processes in a highly reduced model preparation.

A Theory and Simulation of Rhythmic Behavior Due to Reciprocal Inhibition in Small Nerve Nets

Richard F. Reiss  
Librascope Division  
General Precision, Inc.  
Glendale, Calif.

An elementary theory predicts that neurons which inhibit each other, and which suffer "fatigue" with repeated firing, can produce alternate bursts of pulses, a "multivibrator" effect, under certain conditions. Fragmentary physiological evidence suggests that reciprocal inhibition does occur in sensory and muscle control systems, and may in particular explain rhythmic behavior of the sort seen in alternating reflexes-responsible for animal locomotion.

On the basis of a specific conceptual model of signal processing in neurons, analog and digital simulation models have been constructed and used to explore the multivibrator effect. The effect is rather easily produced with model neurons operating in either "coincidence" or "relaxation" modes, and is facilitated within limits by asymmetric parameters.

The reported simulation experiments are restricted to reciprocal inhibition of just two neurons and indicate that a neuron couplet, with a few sensory inputs and proprioceptive feedbacks, could provide an economical control system for alternating reflexes or for synergetic muscle groups which time-share a common load. Such a system could rapidly adapt to varying loads and would require minimal control from higher nervous centers. The exploration of many other possible functions for two (and more) multivibrator effects in small nerve nets has only begun.

SESSION F

Wednesday, May 2 -- 2 p.m. to 5 p.m.  
Gold Room

Computer Systems

Chairman: James H. Pomerene, Thomas J. Watson  
Research Center, IBM Corporation, Yorktown  
Heights, N.Y.

Panelists: Erich Bloch, IBM Corporation, Pough-  
keepsie, N.Y. / Howard R. Nonken, Burroughs  
Laboratories, Paoli, Pa. / Herbert Martin  
Teager, Massachusetts Institute of Technology,  
Cambridge, Mass.

Faster computer systems can usually be expected from faster technology, but there are other areas where improvement is needed and can be obtained. Some of these are described.

The processes themselves can be defined in new ways which make solution of many problems more convenient. The use of content-addressed, or "associative" memories can greatly speed up and simplify the searching operations characteristic of many non-numerical problems. Final re-

sults can often be presented to the user in visual displays conveying the essential information compactly and in minimum time; the example described primarily concerns maintenance but has implications for operational results as well.

The Maniac III Arithmetic System

Robert L. Ashenurst  
Institute for Computer Research  
University of Chicago  
Chicago, Ill.

Unlike most computers, for which there is a formal distinction between "fixed-point" and "floating-point" numbers, the University of Chicago Maniac III computer handles all numbers in a single format (exponent and coefficient, with the coefficient in general not normalized). This permits several types of arithmetic to be defined, which differ in that results are adjusted (coefficient scaled) according to different rules. For example, a "floating-point" operation adjusts the result according to a "significant digit" criterion, while a "specified point" operation adjusts the result to the exponent of the first operand. Normalized arithmetic and a fourth type called "basic" are also available. Since the format for operands is the same for all these types, they can be processed by the various arithmetics without intermediate conversion, thus adding a dimension of flexibility to the computing process.

This paper discusses the arithmetic rules in some detail, showing how consistent conventions for rounding, adjustment of zero and formation of low-order parts are established. The trapping system used for the detection of anomalous results is also described.

An Organization of an Associate Cryogenic Computer

Robert F. Rosin  
Department of Electrical Engineering  
University of Michigan  
Ann Arbor, Mich.

This paper is concerned with the organization of a computer built entirely of cryotrons and operating with an associative (content addressed) memory in which the location of words stored or retrieved is determined by all or part of the contents of the words.

Since cryogenic circuitry is used throughout, the speed of the machine is relatively uniform in both memory and other functions. Thus, the traditional balance of operation time is changed from that existing in more contemporary devices. Moreover, the problem of hardware maintenance has changed due to the very cold environment which must exist for the machine to operate.

A design approach to these and other considerations is evolved which includes putting more logic than usual into the memory and eliminating the necessity for a distinct instruction location counter, address decoder, etc. Problems considered include multi- and parallel processing, indexing and indirect addressing, input-output processing and self-monitoring functions.

Introdu  
Miss  
1962

Opening  
ern  
of l  
or at

Keynote  
Phys  
Berk

Chairma

Panelis  
nia,  
Rand

Or  
systems  
attenti  
their p  
tributa  
structi  
largely  
that ha  
ferred  
to effe  
the org

Wi  
ness in  
areas f  
al page

1)  
busines  
are ava  
consequ  
What sp  
tems, a  
what re  
theory,  
theory?  
and pro

COMPU



Integration and Automatic Fault Location Techniques  
in Large Digital Data Systems

Donald W. Liddell  
U. S. Navy Electronics Laboratory  
San Diego, Calif.

A digital computer, if used with proper programming techniques, can be a powerful tool during the processes of physical integration of complex digital data processing systems. After system integration as such has been completed, the same techniques may be used to provide performance monitoring and daily calibration status data for all or any part of a system.

Investigation of such programming techniques during system integration of the Developmental Navy Tactical Data System (NTDS) at USNEL produced results which indicated the possibility of using the computer for automatic fault location in the system. Some progress has been made in this area, and a program which allows the NTDS computer to identify a failing logic card associated with its own memory logic and switching circuitry has been successfully demonstrated. The final objectives of this approach are to provide facilities to perform on-line performance monitoring and automatic fault location, reduce to a minimum the external test equipment required for a system, and eliminate insofar as possible the high degree of training presently required in the system maintenance technician.

SESSION G

Wednesday, May 2 -- 2 p.m. to 5 p.m.  
Peacock Court (Mark Hopkins Hotel)

Analog Applications and Techniques

Chairman: Vernon L. Larrowe, Institute of Science and Technology, University of Michigan, Ann Arbor, Mich.

Panelists: Arthur D. Bridgman, Sylvania Electronic Defense Laboratories, Mountain View, Calif. / P. J. Hermann, Dept. of Aerospace Engineering, Iowa State University / Hans E. Meissinger, Hughes Aircraft Company, Culver City, Calif. / James E. Wolle, Analog Computer Laboratory, General Electric Company, Philadelphia, Pa.

The modern electronic analog computer, when intelligently programmed, is capable of solving accurately many engineering problems which arise in current technological research and development.

The papers scheduled for presentation at this session represent a sampling of the many applications of the analog computer to contemporary problems. They are intended, not only to introduce ideas and stimulate thinking, but also to serve as valuable references for persons engaged in solving similar problems on electronic analog computers.

The Use of Computers in Analysis

Walter J. Karplus and Ladis D. Kovach  
Department of Engineering  
University of California  
Los Angeles, Calif.

The computer is recognized as an important engineering design tool permitting the student to test the efficacy of a large number of design hypotheses to determine an optimum design. The application of automatic computers to courses in methods of analysis, however, has not been clearly defined.

This paper gives a number of specific examples of the utilization of computers in engineering analysis. Foremost among these examples are two categories of computer utilization: 1) The application of computers to aid the student in the visualization of dynamic or mathematical phenomena; and 2) The opening up of new approaches to the explanation of system behavior -- approaches which are out of reach of conventional analytical methods.

Analog Simulation of Particle Trajectories  
in Fluid Flow

Vance D. Norum  
Space-General Corporation  
Glendale, Calif.

and

Marvin Adelberg and Robert L. Farrenkopf  
Space Technology Laboratories, Inc.  
Redondo Beach, Calif.

This paper presents a detailed account of the analog simulation of particle trajectories in a two-dimensional fluid flow field governed by Laplace's equation. A conductive surface is used as a direct analog of the two-dimensional fluid flow field in conjunction with an electronic analog computer to determine the trajectories of particles in the presence of fluid flow. Emphasis is placed on the concept of accuracy of the particle trajectories as well as error criteria by which trajectory accuracy can be judged; and on the sources of error inherent in their determination.

A detailed error analysis is presented in which a suitable error model is derived and certain inaccuracies in the computing equipment are assumed in order to predict their effect on the particle trajectories. An example is presented to illustrate the types and magnitudes of errors that exist in a typical problem. The analog simulation is also used to obtain trajectories in a potential flow field distorted by the presence of a cylinder and the results are then compared to a similar case obtained by other authors using a different approach. These results were comparable, with suitable explanations for the difference.

California Street Side

The Application of Finite Fourier Transforms to Analog Computer Simulations

Eric Liban  
Grumman Aircraft Engineering Corp.  
Bethpage, L.I., N.Y.

An analog computer technique for the solution of certain classes of boundary value problems of partial differential equation based on Finite Fourier Transforms is presented, which requires considerably less computer components than conventional finite difference methods. The derivation of the Finite Fourier Transform method is briefly stated and then applied to analog computer simulations of heat transfer equations with linear and nonlinear boundary conditions.

Analog Simulation of the Re-Entry of a Ballistic Missile Warhead and Multiple Decoys

L. E. Fogarty and R. M. Howe  
University of Michigan  
Ann Arbor, Mich.

The basic problem considered here is the computation of the re-entry trajectory of a single ballistic missile warhead as well as the trajectories of a number of decoys which originate from the warhead trajectory. Suitable three-dimensional equations of motion are presented for a re-entry vehicle with arbitrary drag coefficient, mass, and area, and the analog computer circuit for solving these equations in real time is given. Then a method of using several such circuits to compute simultaneously the trajectories of multiple targets with variations in all three initial velocity components as well as variations in ballistic coefficient is presented.

SESSION H

Thursday, May 3 -- 9 a.m. to 12 noon  
Venetian Room

Information Retrieval

Chairman: Jack Goldberg, Stanford Research Institute, Menlo Park, Calif.

Panelists: Charles P. Bourne, Stanford Research Institute, Menlo Park, Calif. / R. K. Wakerling, Lawrence Radiation Laboratory, University of California, Berkeley, Calif.

Two basic tasks in an information retrieval system presently requiring human judgment are the establishment of the indexing categories and the indexing of incoming items. There have been numerous suggestions for the mechanization of the latter task, using semantic or statistical analysis. One of the papers at this session will describe a statistical method for establishing the categories themselves, by analysis of the text of a representative body of items. The method might also be useful in mechanizing item indexing in a so-called probabilistic indexing and retrieval system.

Machine retrieval has been proposed for more than just library service. A second paper discusses the possibilities of a mechanized retrieval system at the center of a very complicated technical and human organization -- the hospital. The paper illustrates the complexity of the problem, and the diversity of techniques which the system designer must employ.

The Construction of an Empirically Based Mathematically Derived Classification System

Harold Borko  
System Development Corp.  
Santa Monica, Calif.

This study describes a method for developing an empirically based, computer derived classification system. Six hundred and eighteen psychological abstracts were coded in machine language for computer processing. The total text consisted of approximately 50,000 words of which nearly 6,800 were unique words. The computer program arranged these words in order of frequency of occurrence. From the list of words which occurred 20 or more times, excluding syntactical terms such as and, but, of, etc., the investigator selected 90 words for use as index terms. These were arranged in a data matrix with the terms on the horizontal and the document number on the vertical axis. The cells contained the number of times the term was used in the document. Based on these data, a correlation matrix, 90x90 in size, was computed which showed the relationship of each term to every other term. The matrix was factor analyzed and the first 10 eigenvectors were selected as factors. These were rotated for meaning and interpreted as major categories in a classification system. These factors were compared with, and shown to be compatible but not identical to, the classification system used by the American Psychological Association. The results demonstrate the feasibility of an empirically derived classification system and establish the value of factor analysis as a technique in language data processing.

The Storage and Retrieval of Physiological and Medical Data in a Modern Hospital

Paul C. Tiffany  
Aerospace Corporation  
El Segundo, Calif.

As an introduction, this paper considers some of the problems of data handling in a modern hospital. Next, the needs of the users of the data are considered. The principal area of interest is directed toward the hospital function which deals with the storage and retrieval of the clinical record after the patient's hospitalization. An estimation is made of the large amounts of terms used in medicine, and of two currently employed schemes for the indexing of diseases and operations. A description is made of a storage and retrieval system which allows the medical researcher to examine and browse through clinical records or abstracts of the records. The paper concludes with observations on the need for applied research and system development to acquire pilot systems for the storage and retrieval of physiological and medical data.

Aeronu  
Newp  
AMP, I  
219,  
Ampex  
if.  
ANelex  
/ RI  
Applie  
/ NO  
Automa  
/ FI  
Bell T  
Long  
109  
The Be  
Vita  
0-36  
Berkel  
Ave.  
Brush  
Perk  
3315  
Bryant  
Lake  
The Bu  
D.C.  
Burrou  
Mich  
Califo  
St.,  
C-E-I-  
Collin  
Comcor  
Comput  
/ 41  
Comput  
N.J.  
Consol  
Madr  
/ 82  
Contro  
Minn  
Datama  
305  
Data F  
Datapu  
Cali  
DI/AN  
25,  
Digit  
/ TW  
Digitr  
/ 40  
Dymec,  
Rd.,

ute  
to  
er.  
at  
for  
ues  
na-  
ffic.  
o a  
out  
real  
del  
on-  
gh  
ata,  
nce  
this  
led  
s—  
im-  
ake  
qua-  
raf-  
of  
ake  
be  
will  
tech-  
tion,  
gs of  
For instructions, see page 6.

at **IBM**<sup>®</sup>

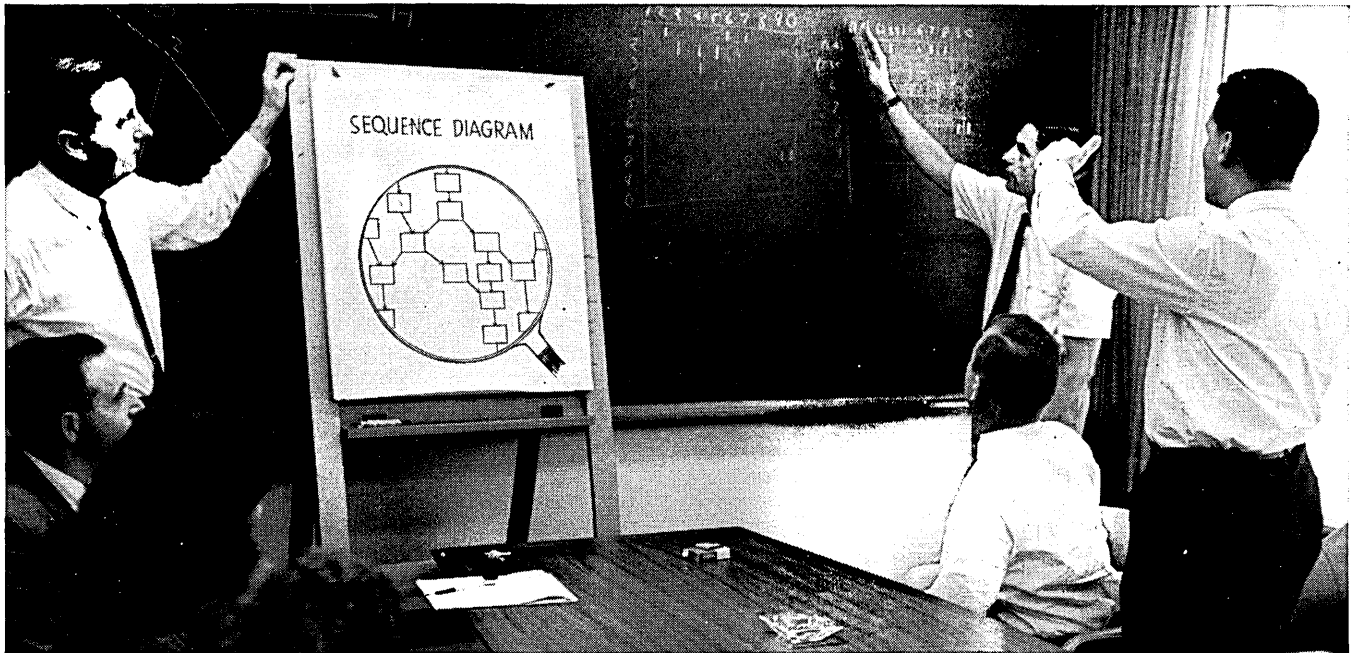

## **PROGRAMMERS shape the future of a new technology**

IBM programmers, working with professional associates in research, development and manufacturing, are contributing expert knowledge and ideas in the creation of future computing systems.

This teamwork represents a striking advance in the role of the programmer and dramatizes the important part being played by this young but rapidly growing profession. At IBM, programmers are creating new concepts in software, and contributing to the design of new systems for virtually every phase of business, science and industry.

In response to the vastly increasing versatility of computers and their widespread applications, IBM programmers at all levels of endeavor are establishing new standards of achievement. They are designing programs that will simulate business and industrial operations. They are developing systems for government projects in space, defense and communications, where their data processing skills will help produce significant advances in tomorrow's computer technology. They are also studying the complex programs for . . . information-handling systems . . . scheduling methodology . . . information-retrieval studies.

IBM programmers also face challenging tasks in developing new programming systems. For example, they are devising programs that in turn use machine capability

for formulating new programs. They are creating programs that enable computers to diagnose their own faults through self-checking. And they are helping to design the systems that will let scientists and engineers "talk" to machines in the everyday language of science and engineering.

Programmers at IBM take pride in their professional status and enjoy the unusual opportunities offered by a leader of the computer industry. In an atmosphere so receptive to new ideas, their concepts flourish. They find that their keen interest in exploring the capabilities of electronic computing is supported by IBM's full resources. This combination results in significant accomplishments recognized throughout the field.

Openings for programmers exist in all IBM facilities, including: San Jose, California; the Washington, D. C., area; Lexington, Kentucky; Rochester, Minnesota; Omaha, Nebraska; and New York City, Endicott, Kingston, Owego, Poughkeepsie and Yorktown Heights, New York. In addition to its extensive benefits programs, the IBM Educational Program is one of the most extensive in the country today. IBM is an Equal Opportunity Employer.

If you have experience in computer programming and would like to have more information about careers with IBM, we'd like to hear from you. Please write to:

**Manager of Professional Employment  
IBM, Dept. 539 R  
590 Madison Avenue  
New York 22, New York**

SESSION I

Thursday, May 3 -- 9 a.m. to 12 noon  
Gold Room

Programming and Coding -- Part 1

Chairman: Bernard A. Galler, Computing Center,  
University of Michigan

Panelists: Richard W. Hamming, Bell Telephone  
Labs, Murray Hill, N.J. / Edwin L. Jacks, Data  
Processing Section, General Motors, Inc., De-  
troit, Mich. / Alan J. Perlis, Computation  
Center, Carnegie Tech, Pittsburgh, Pa. /  
Francis V. Wagner, North American Aviation  
Company, Los Angeles, Calif.

The most striking feature about programming  
today is the variety of problems on which work is  
being done. We normally think of activity in  
programming as being concerned with sub-routines,  
translators, or system development, but as we  
shall see in the papers presented here, there are  
other areas under active investigation.

Two of the papers are concerned with new de-  
velopments in the languages which we use in ex-  
pressing algorithms. The very existence of these  
papers testifies that the topics which concern  
them must inevitably be provided for in comput-  
ing languages. Two of the papers deal with new  
requirements on operating systems. As problems  
become more complex, we find that we must consid-  
er the implications of dynamic storage allocation,  
and these two papers are pointing up some of the  
different approaches to the problem.

The fifth paper in this session is also con-  
cerned with the complexity of future problems,  
but from a different point of view. Here we need  
to examine the methods used to determine when a  
program is working correctly. The trend toward  
putting the burden more squarely on the "should-  
ers" of the computer continues, and, of course,  
it must.

Fact Compiler Segmentation

Martin N. Greenfield  
Minneapolis-Honeywell EDP Division  
Wellesley Hills, Mass.

The manner in which the Fact Compiler han-  
dles segmentation of programs is described. Pro-  
grams are divided into many interdependent seg-  
ments in order to optimize the use of core stor-  
age. For instance, the internal storage required  
to handle a tape file (buffers, labels, controls)  
would be one segment. This segment would be op-  
erated upon by other processing segments. Each  
of the segments may be activated or released in-  
dependently as required. Each of the segments  
is relocated at execution time. Segments in mem-  
ory may be subsequently moved by the monitor in  
order to fit additional segments in core. The  
monitor has the ability to organize the required  
rearrangement. A hardware error detection fea-  
ture is used to make the currently operating  
segments sensitive to the absence of a segment

about to be addressed. This provides an efficient  
linkage to the monitor enabling it to activate the  
segment.

A General Test Data Generator for Cobol

Lt. Richard L. Sauder  
Wright-Patterson Air Force Base  
Ohio

Program checkout procedures are often ham-  
pered by the nonavailability of adequate test  
data. To reduce this problem, a Test Data Gener-  
ator is currently being developed to operate in  
conjunction with the Cobol Compiler implemented  
by the Air Force Logistics Command. The system  
not only builds data items conforming to descrip-  
tions given in the Data Division of the associated  
Cobol Source Program but also inserts in these  
items necessary data relationships and require-  
ments to test various branches of the Cobol object  
program. The generator is labelled "general" in-  
asmuch as the method of expressing these data re-  
quirements is designed to be as hardware independ-  
ent as the Cobol compiler employed to build the  
program being tested. This paper discusses both  
the utilization and the method of operation of  
the Data Generator.

Data Structures that Generalize  
Rectangular Arrays

Samuel A. Hoffman  
Kettelle & Wagner  
Paoli, Pa.

A class of data structures, useful in data  
processing, is defined. These are called gener-  
alized structures. A formal method of describing  
a generalized structure is given. It is shown how  
a compiler program, once given such a description  
or descriptor, can allocate contiguous storage and  
determine the appropriate form of the storage map-  
ping function which will relate suitably referenc-  
ed positions in the structure with positions in the  
linear storage. The suitable referencing of data  
in the structure is accomplished by reference ex-  
pressions; these are defined and it is shown how,  
at run time, they are operated upon by the storage  
mapping function.

The class of structures, the descriptors, the  
form of the storage mapping function and the ref-  
erence expressions are all shown to be direct gen-  
eralizations of the corresponding considerations  
for n-dimensional rectangular arrays.

Finally, an Algol program for the Burroughs  
220 computer is briefly described. The program  
simulates the functions that a compiler, upon re-  
ceiving a descriptor, would perform in forming the  
storage mapping function, and the processing that  
would be carried out at run time when a reference  
expression is presented.

lan  
sign  
too  
A  
dig  
ing  
V  
sar  
sigh  
the  
in t  
of t  
thru  
swit  
the  
to l  
the  
inte  
in  
spe  
T  
erat  
sect  
mit  
bou  
mak  
lan  
bou  
obli  
quie  
wai  
The  
ferr  
LA  
traf  
tur  
V  
"co  
120  
pat  
shif  
into  
shif  
ing  
rule  
T  
pro  
spe  
veh  
run  
cyc  
com  
cau  
as  
for  
A  
fou  
put  
pri  
giv  
typ

## Scientific programmers for Space Technology Leadership



*"And, thinking it would not be improper, I have . . . plotted in the plane of the curve, a true representation of the orbit which this comet (Halley's) described . . ." Isaac Newton—Mathematical Principles of Natural Philosophy—book III: The Systems of the World, 1687*

REPRINTS OF THE DRAWINGS CREATED FOR THIS SERIES, SUITABLE FOR FRAMING, ARE AVAILABLE ON REQUEST.

Thinking it not improper, we invite your attention to the challenging opportunities for scientific programmers at Space Technology Laboratories, Inc. In the tradition of Newton, you might well be interested in helping to develop a better understanding of such phenomena as the orbiting of bodies—celestial and man-made. At STL there is continuing interest in the solution of the broad spectrum of unsolved problems relating to space technology using two IBM 7090's, and extensive peripheral equipment. Opportunities also exist for Computational Systems Programmers, Data Analysts and Applied Mathematicians. Please write Dr. R. C. Potter, Manager of Professional Placement and Development at STL. STL is an equal opportunity employer.

**SPACE TECHNOLOGY LABORATORIES, INC.** P.O. BOX 95005BB, LOS ANGELES 45, CALIFORNIA

a subsidiary of Thompson Ramo Wooldridge Inc.

Los Angeles • Santa Maria • Cape Canaveral • Washington, D. C.



Boston • Dayton • Huntsville • Edwards AFB • Canoga Park • Hawaii

Spring Joint Computer Conference Delegates: San Francisco interviews May 1-3. Call F. C. Nagel at Conference Hotel, SUTTER 170909

SESSION I

Thursday, May 3 -- 2 p.m. to 5 p.m.  
Gold Room

Programming and Coding -- Part 2

Chairman: Same as Part 1

Panelists: Same as Part 1

An Experimental Time-Sharing System

Fernando J. Corbato  
MIT Computation Center  
Cambridge, Mass.

Time-sharing a digital computer is subject to two common interpretations. One can mean using different parts of the hardware at the same time for different tasks, or one can mean several persons making use of the computer at the same time. The first meaning, often called multiprogramming, is oriented towards hardware efficiency in the sense of attempting to attain complete utilization of all components. The second meaning of time-sharing, which is meant here, is primarily concerned with the efficiency of persons trying to use a computer. Computer efficiency must still be considered but only in the perspective of the total system utility.

The motivation for time-shared computer usage arises out of the slow man-computer interaction rate possible with the bigger, more-advanced computers. This rate has changed little (and become worse in some cases) in the last decade of widespread computer use. The desired performance of a time-shared computer will be discussed as well as specific hardware, programming and usage problems. The operational characteristics of an experimental time-sharing programming system prepared for an IBM 7090 will be described. Consideration will be given to the design compromises and to the future avenues of improvement.

A Programming Language

Kenneth E. Iverson  
Thomas J. Watson Research Center  
IBM Corporation  
Yorktown Heights, N.Y.

The paper describes a succinct problem-oriented programming language. The language is broad in scope, having been developed for, and applied effectively in, such diverse areas as microprogramming, switching theory, operations research, information retrieval, sorting theory, structure of compilers, search procedures, and language translation. The language permits a high degree of useful formalism. It relies heavily on a systematic extension of a small set of basic operations to vectors, matrices, and trees, and on a family of flexible selection operations controlled by logical vectors. Illustrations will be drawn from a variety of applications.

SESSION J

Thursday, May 3 -- 2 p.m. to 5 p.m.  
Venetian Room

World Peace and Role of Computers\*

Chairman: Louis Fein, Consultant, Palo Alto, Calif.

Panel Discussion

Political scientists, behavioral scientists and computer scientists will explore some of the general problem areas of peace research and some of those specific classes of problems -- if any -- amenable to solution with the aid of computers. Finally, the credibility of computer-generated recommendations will be discussed.

Peace research appears to deal with five main problem areas: (1) Identifying necessary and sufficient conditions (economic, political, sociological, psychological, cultural, military, religious, moral, ethical, ideological, legal and semantic) for preventing major international conflicts -- conflicts for whose resolution nations seriously consider all-out nuclear war as an acceptable instrument; (2) generating alternative models of society whose most important property is that they meet these necessary and sufficient conditions; (3) generating alternative routes of getting from our present world condition to a condition of society with no major conflicts.

In the event of conflict, the research would concentrate on (1) generating alternative non-destructive strategies and policies to resolve conflicts, and (2) generating detailed ways of implementing these policies in practice.

Papers will be integrated with a continuity of subject matter from paper to paper. The format and content of the session may be considered as a very small scale model of the whole process of analyzing important sociological problems and solving them with the aid of computers. (\*See note on page 44.)

SESSION K

Thursday, May 3 -- 2 p.m. to 5 p.m.  
Peacock Court (Mark Hopkins Hotel)

DDA and Hybrid Computation

Chairman: Harold K. Skramstad, Naval Ordnance Laboratory, Corona, Calif.

Panelists: Robert M. Barnett, Ames Research Center, Moffett Field, Calif. / W. N. McLean, North American Aviation, Los Angeles, Calif. / Fred Shaver, National Aeronautics and Space Administration, Marshall Space Flight Center, Huntsville, Ala.

The Digital Differential Analyzer or DDA is a special-purpose digital computer of the incremental type which has the ability to solve dif-



# WHY

■ *does one computer system take maximum advantage of its computing speed, peripheral equipment and storage capacity at all times and under all conditions—whereas others do not (and cannot)?*

■ *do three jobs that each take an hour to do on other systems take only  $1\frac{1}{4}$  hours all told on this system?*

■ *do interrupt conditions that make other systems bog down have no effect on this system?*

■ *do you get more throughput per dollar with this system than with any other?*

■ *can this equipment lay claim to a totally new concept in computer system operation?*

The Master Control Program (MCP) of a Burroughs B 5000 Information Processing System is the answer. It's one of the primary answers to all the questions above, and it's also the solution to just about every operational drawback that's ever drained away a computer user's time, money and patience.

Take the question of interrupts, for example. Conventional systems employ programmed interrupt detection. In the B 5000, interrupt detection is built right into the hardware. The hardware then switches electronically to the appropriate portion of the MCP for automatic handling of that specific interrupt condition. Meanwhile, the current program is processed further or another program is run instead, if preferred. In either event, the B 5000's MCP assures that an interrupt *condition* does not mean an interruption of the system itself or the work in progress.

Or consider the paradox of how three jobs that each take one hour to do on other systems can be completed in less than half that time by the B 5000. It's easy—the way the MCP does it. Since some jobs need a lot of processor time but little input-output time, whereas some jobs need just the opposite, the MCP cuts the total processing time of each by running them *concurrently*. The programmer needs to write only the basic program and the MCP takes over from there, scheduling and assigning different components when free. This ability to time-share unused processor and input-output capacities is one of the main reasons the B 5000 can give you more throughput per dollar.

Versatile as it is, however, the MCP doesn't fully account for the fact that the B 5000 is a totally new concept in system operation. There's the B 5000's ability to incorporate a second central processor, for instance—without reprogramming. And there's the fact that the B 5000's basic design concept provides effective and productive use of the higher level languages of ALGOL and COBOL. Plus enough other reasons to fill a whole booklet—which we'll be glad to send to you. It's called *The B 5000 Concept* and is available from our main office at Detroit 32, Michigan.

Burroughs—TM

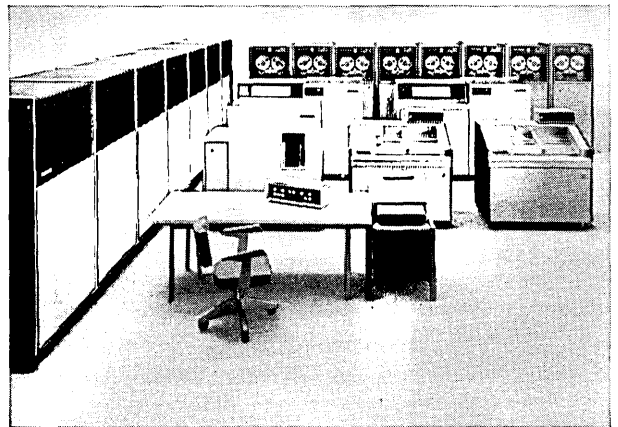

Burroughs Corporation



ferential equation problems with high efficiency. Programmed in the manner of analog computers, but free of analog limitations on precision, they are being increasingly used in real-time simulation and control, due primarily to the order of magnitude increases in speed attainable in recent years.

The first paper "Design of a One-Megacycle Iteration Rate DDA" describes a new DDA of exceptionally high speed. The second paper "DDA Error Analysis Using Sampled Data Techniques" is a thorough analytical study of the errors produced in DDA's in which a conceptually simple error theory is evolved.

The third paper "Hybrid Techniques for Optimization Problems" describes a hybrid technique, combining analog and digital hardware, for minimizing a function dependent on the solution of a set of differential equations, by means of a systematic search procedure in parameter space.

#### Design of a One-Megacycle Iteration Rate DDA

R. E. Bradley, Design Engineer  
J. F. Genna, Project Engineer  
Hazeltine Technical Development Center, Inc.  
Indianapolis, Ind.

This paper discusses the special design features of a digital differential analyzer (DDA) which operates at a rate of one million iterations per second. SPEDAC (Solid-state Parallel Expandable Differential Analyzer Computer) features parallel organization of the integrators, serial-parallel arithmetic within the iteration cycle, 26-bit word length, and the integral inclusion of a multi-function digital function generator. The computer is programmed in analog computer fashion by means of plug board interconnection of the integrators.

To achieve a one-megacycle iteration rate, the arithmetic circuits operate at a six-megacycle clock rate. Trapezoidal integration is performed. Initial conditions and function generator breakpoints and slopes are stored as parallel words in a multiplane magnetic core memory. The use of a parallel memory is exploited to permit direct parallel communication and hybrid operation with external large-scale general-purpose digital computers.

#### DDA Error Analysis Using Sampled Data Techniques

Don J. Nelson  
University of Nebraska  
Department of Engineering  
Lincoln, Neb.

The Z or W-Transforms may be combined with matrix techniques to analyze errors in digital differential analyzers. This analysis demonstrates how errors in the solution of linear differential equations with constant coefficients can be simply determined and how solutions to these equations can be developed, the accuracy of which is limited only by round-off.

#### Hybrid Techniques Applied to Optimization Problems

Hans S. Witsenhausen  
Electronic Associates, Inc.  
Princeton, N.J.

A hybrid system is described consisting of a general-purpose analog computer and a specially designed digital expansion system (DES). One of the functions of this expansion is to act as an intelligent operator of the analog high-speed computing capability. To this end, the expansion contains logic building blocks (essentially flip-flops and gates) interconnected on a patch-panel. Switching commands are transmitted from the DES to analog gates, memory units and mode control. Comparators transmit quantized information from the analog to the DES.

Application of this simplest capability of the hybrid approach is illustrated for the optimization problem, stated as follows:

A function dependent on the solution of a set of differential and/or algebraic equations containing adjustable parameters is to be minimized by systematic search procedures in parameter space. Among the applications are model building, process optimization and matching of boundary conditions. One possible procedure has been selected for illustration and its hybrid implementation is carried out for the general n-parameter case. Exploratory runs determine approximate partial derivatives from which a quantized direction is determined. Steps are taken in this direction until lack of improvement forces a redetermination of partials. The techniques of programming the DES and the hybrid interconnections are emphasized.

---

#### COMPUTERS AND WORLD PEACE

It is worth quoting a paragraph from Louis Fein's "Introduction to the Session: Peace and the Role of Computers":

"... The prime reason for having this session is to ascertain what, if anything, we can do professionally in the cause of peace ... and how we might go about doing it. We do not intend ... to attempt the solution of specific problems of peace at this three-hour session. Nor is this a peace rally. We are here not as partisans but as technicians confronting ourselves with a set of problems. We have had a good deal of experience as technicians in trying to solve moderately complex problems with the aid of computers. Appreciating full well that the problems of peace are probably more complex than those with which we've already dealt, still we ought to be able to identify what we might do effectively — and what we cannot do at all — to help prevent nuclear war now and help establish world peace in the future. We ought also to be able to provide methods for ascertaining what can and cannot be done effectively and acceptably, how to do what can be done, and to estimate the magnitude of such tasks. ..."

obse  
tors  
to th  
T  
trem  
scio  
How  
fully  
an e  
for  
mec  
to d  
In  
tem  
thes  
desc  
in o  
infl  
it w  
a gr  
cent  
prob  
will  
T  
can  
in t  
com  
gran  
poli  
as i  
poll  
char  
char  
drop  
time  
H  
peri  
mat  
of a  
cal  
the  
arse  
be  
sult  
ticu  
acti  
wid  
I  
of  
put  
cisi  
ing  
can  
pai  
of  
] the  
by  
wh  
the  
ma  
bu

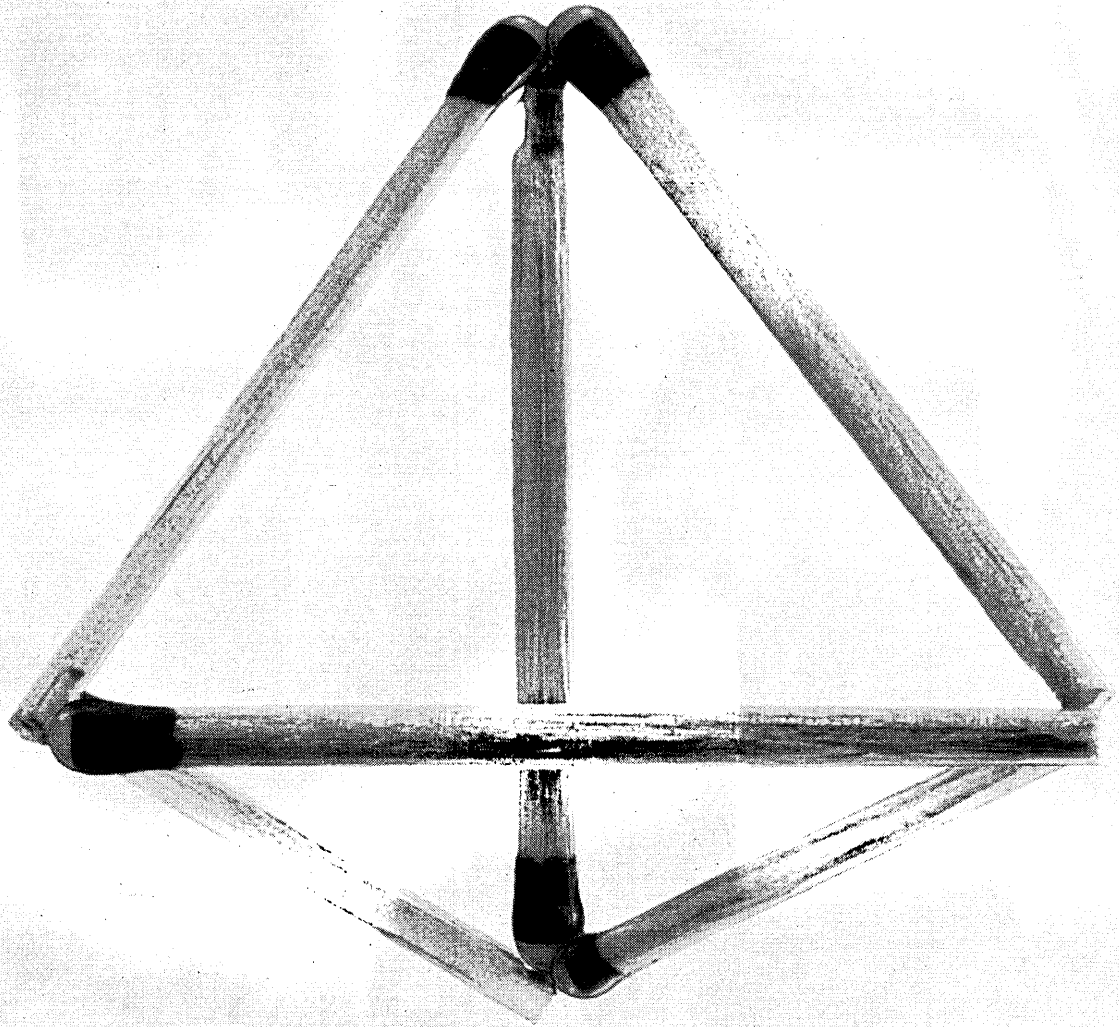

## ACHPHENOMENON

Somewhere between the problem of forming six matches into four equilateral triangles and seeing the solution as a tetrahedron . . . . . Achphenomenon occurs. Call it insight, inspiration, or perception. It is that sudden impulse to think in another direction. Such impulses have produced our greatest achievements.

We welcome engineers who think in new dimensions, who form uncommon conclusions, who are not afraid to go outside the confines of accepted concepts. Insightful thinkers are invited to send a resume to Mr. Nick B. Pagan, Manager Professional and Scientific Staffing. You may expect prompt attention.



**LITTON SYSTEMS, INC.**  
**GUIDANCE AND CONTROL SYSTEMS DIVISION**

5500 CANOGA AVENUE, WOODLAND HILLS, CALIF.  
Guidance Systems • Control Systems • Computers • Computer Components

An Equal Opportunity Employer

ed  
lar  
ed  
uld  
oc-  
ere  
be  
ere  
not  
on  
in-  
re-  
ew  
ing  
or-  
his  
nd

he  
be  
be  
out  
an  
ch  
no-  
lly  
els  
ik-  
to  
it.  
to  
A  
can  
on  
lso  
he-  
de-  
rly  
od  
us  
eas  
one

the  
in  
can  
ges  
use  
ges  
ll).  
lec-  
tly  
sid-  
are

ine  
del  
ust  
on-  
can

# "ACROSS THE EDITOR'S DESK"

## NEWS of Computers and Data Processors

### NEW INSTALLATIONS

#### IBM STRETCH COMPUTER SYSTEM AIRLIFTED TO LONDON

A large-scale IBM 7030 "STRETCH" electronic data processing system was airlifted by two cargo planes from New York's Idlewild airport to London. It will be delivered by IBM-United Kingdom to the United Kingdom Atomic Energy Authority.

The solid-state STRETCH can perform more than 30 billion multiplications in a 24-hour period. The computer attains its high speeds through use of ultra-fast circuits, transistors and circuit components. Its speed makes possible solutions to scientific problems for which equations are known but which were previously too large or complex for solution for a reasonable cost, or in a reasonable length of time.

This is the third STRETCH system to be delivered by IBM to an atomic energy organization.

#### AUTOMOBILE INSURANCE COMPANY INSTALLING DATA PROCESSING EQUIPMENT

State Farm Mutual Ins. Co., Bloomington, Ill., has begun installation of 38 solid-state computers. They are part of a decentralized computing and data processing system, having both disk and tape storage at each of the regional offices.

An IBM 1410 and a 1401 are being installed in each regional office. Another 1401 will be installed in the home office in Bloomington.

Each 1410 system will include a new IBM 1301 disk storage unit, offering either 28 or 56 million digits of capacity. Access to the 1301 unit will be provided by one or two IBM 1014 remote-inquiry stations, as the region requires. Each 1401 will also have five magnetic tape units for processing the master policy file with from 300 to 2400 characters per policy; a 1403 printer which operates at up to 600 lines a minute, and a 1402 card unit which reads 800 cards a minute and punches 250.

#### H-400 EDP SYSTEM FOR PUBLIC HEALTH APPLICATIONS

The U. S. Public Health Service, Cincinnati, Ohio has installed a Honeywell 400 electronic computer at the Robert A. Taft Sanitary Engineering Center. It will be used in studies of radiation, water purification, air pollution, and other environmental factors in all parts of the country.

The new computer, which the Public Health Service will use on a lease-purchase basis, is a high-speed, medium-scale electronic data processing system. It will include a central processor, with a 3,000 word memory; four magnetic tape transports, each capable of reading or writing 96,000 decimal digits per second; a high-speed printer; a high-speed card reader; and a card punch.

#### GERMAN NUCLEAR RESEARCH FIRM INSTALLS LARGE-SCALE ANALOG COMPUTER SYSTEM

Interatom, a German company specializing in nuclear reactor research and construction, has installed a large-scale analog computer system in its laboratories near Cologne. The system is made by Electronic Associates, Long Branch, N.J. and consists of two large-scale PACE 231R general purpose analog computers. Interatom is using the computing system in research and design of nuclear reactors.

#### HONEYWELL 800 AIR SHIPPED TO LONDON

Minneapolis-Honeywell's Electronic Data Processing Division, Wellesley, Mass., has shipped by air a large-scale Honeywell 800 computer to London, England. There it will be installed in the company's first overseas EDP Service Bureau. The Service Bureau will serve as a data center handling electronic data processing on a contract basis. It will also function as an educational and demonstration center to help acquaint European EDP users with Honeywell equipment.

The computer, which weighs more than 33,000 pounds, required the entire carrying capacity of a KLM DC-7F cargo plane. Equipment includes a powerful central pro-

cessor with 8,000 words of memory, eight magnetic tape drives, a high-speed printer, a high-speed card reader and card punch, a paper tape reader and punch and associated electronic control equipment.

#### BANK OPENS LARGEST EDP CENTER IN WEST BERLIN

The largest electronic data processing center in West Berlin has been opened by the Bank for Commerce and Industry, a subsidiary of Dresdner Bank A.G.

Two IBM 1401 medium-scale computers, backed up by eleven tape units, are the center of the installation. Bank statements ready for mailing are printed at a speed of 600 lines per minute.

The equipment will enable the bank to meet the sharp increase in demand deposit bookkeeping operations resulting from the current German trend away from cash transactions.

#### TRW COMPUTER CONTROL SYSTEM FOR PETROLEUM CHEMICALS, INC.

Petroleum Chemicals, Inc. will install a TRW-330 digital computer control system at its high-purity ethylene unit in Lake Charles, La.

The TRW-330 will perform a number of control calculations, including material and energy balances, conversions, and yields. Other functions of the system include scanning of instruments, alarming of off-normal variables, and logging of operating records.

#### UNIVERSITY OF MELBOURNE TO USE ANALOG COMPUTER

University of Melbourne, Melbourne, Australia, has taken delivery of an AD-1-64PB electronic analog computer from Applied Dynamics, Inc., Ann Arbor, Mich.

The computer will be used by the university departments of chemical, electrical, and mechanical engineering, and engineering mathematics. Applications will include both instruction and research.

# MANAGEMENT ENGINEERED

Engineered to meet the major demands of modern management, the Bendix G-20 data processing system is designed to increase profits in an era of critically spiralling costs. ■ Specifically designed as a central, integrated system, the G-20 is capable of concurrently handling the computer workloads of all of your company's major departments: accounting, marketing, engineering, manufacturing, administration, warehousing and distribution. ■ Bendix G-20 automatic programming and linear programming systems open the door to a vast range of applications. For instance, a Bendix G-20 in a typical business organization could, at this moment, be performing these functions: *design automation and cost analysis, inventory control, budget analysis, production and facility control, sales analysis and forecasting, raw material flow, market research and product planning, order processing, advertising planning, and operations research...* all these in addition to more standard business and scientific applications. As workloads increase, G-20 modularity allows you to expand your system without reprogramming. ■ Backing up the proven hardware-software capabilities of the Bendix G-20 is a nationwide team of experienced applications specialists, providing systems support in depth... from preliminary evaluation through systems analysis, programming, installation and on-site maintenance and service. ■ Your nearby Bendix Computer representative will be glad to introduce you to the Bendix G-20 solution to swiftly rising costs: or write for the brochure, "A Solution to the Profit Squeeze," Bendix Computer Division, 5630 Arbor Vitae Street, Los Angeles 45, California, Dept. D39.

**Bendix Computer Division**



## THE BENDIX G-20 COMPUTING SYSTEM

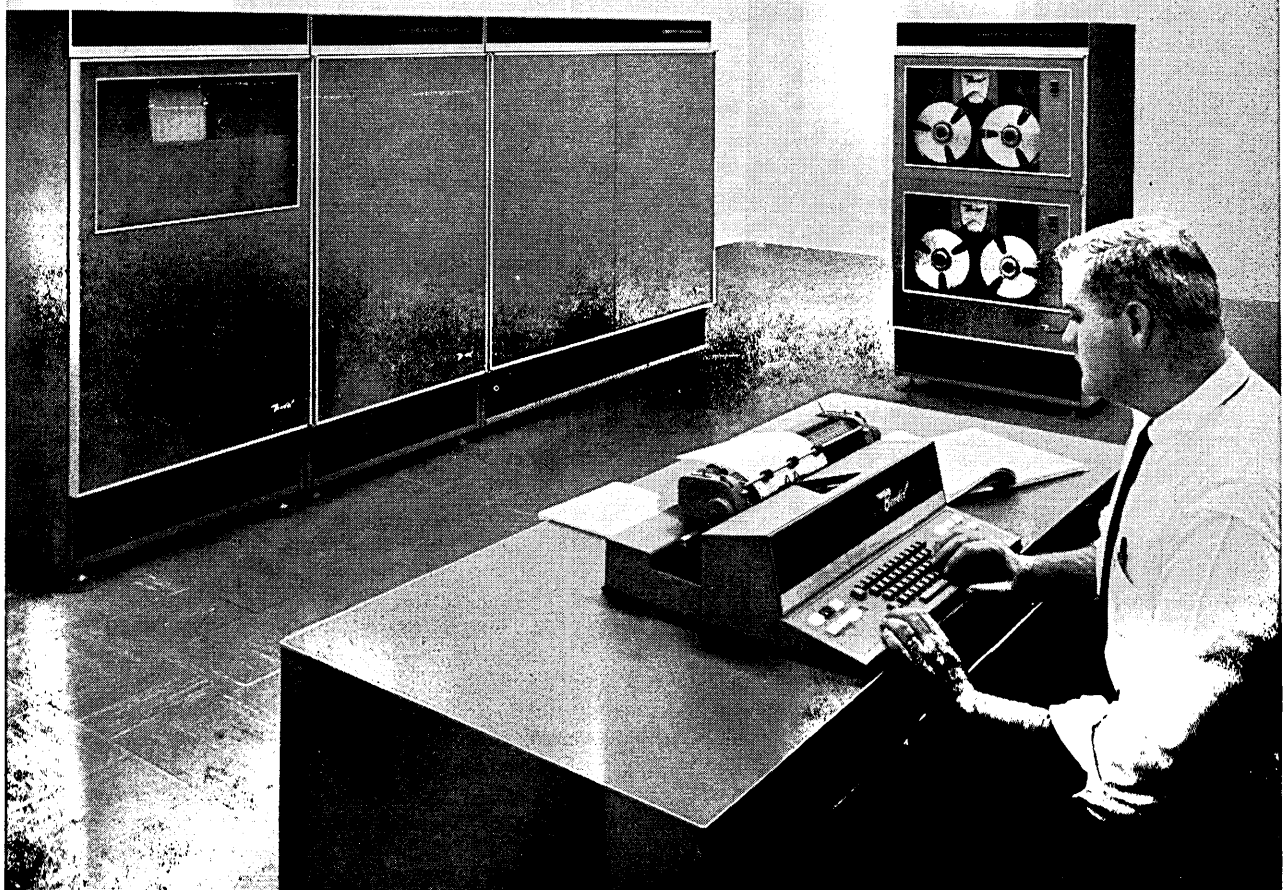

NOW IN OPERATION—Battelle Memorial Institute, Columbus, Ohio

## CAPE CANAVERAL AND ASCENSION ISLAND HAVE NEW ELECTRONIC DATA SYSTEM

A new electronic data processing system has been placed in operation at Cape Canaveral and Ascension Island for improved radar tracking of ICBM's and earth satellites launched at Cape Canaveral along the 5,000-mile Atlantic Missile Range.

The system has a Univac 1206 Military computer, a "real-time data handling system", made by Univac Military Operations, St. Paul, Minn.

The computer operates on stored trajectory information, and tracking data radioed and teletyped from Cape Canaveral; it also assists down-range radar stations in "locking on" and tracking spaceborne vehicles, even though the vehicle may be only intermittently visible to the radar.

"Mission replays" stored on magnetic tape will be used by the Air Force for simulating launchings for the training of Range personnel.

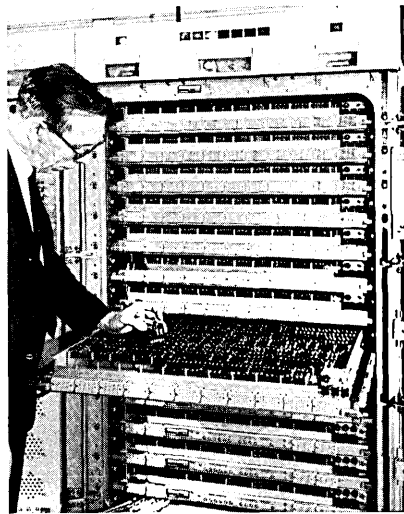

Small circuit cards, 2 1/2" by 1 3/4", are the basic modules in the Univac 1206 Real-Time computer. They are shown here extended from one of the computer's 13 chassis trays. The Univac 1206 computer is about 3 feet square and 6 feet high, and houses about 4,000 circuit cards. They are easily removed for servicing and quick replacement.

## HONEYWELL 400 TO ANALYZE DIAGNOSTIC AND HOSPITAL RECORDS

A Honeywell 400 made by Honeywell EDP Division, Wellesley Hills, Mass., has been delivered to the Commission on Professional

and Hospital Activity, Ann Arbor, Mich. The equipment will be used in the analysis of clinical records of millions of hospital patients throughout the U.S. and Canada. A wide range of diagnostic and hospital care records, covering some 2.5 million patients a year, will be studied under the commission's Professional Activity Study (PAS), a long-range project to help improve medical and hospital practice.

The Honeywell 400 delivered to the Commission consists of a central processor with a 3000-word memory, a high-speed card reader, a card punch, a high-speed printer, and related electronic control equipment.

## New Firms, Divisions, and Mergers

### C-E-I-R, INC. APPEALS COURT DECISION

C-E-I-R, Inc., Washington, D.C., has appealed to the Maryland Court of Appeals the decision of Judge Kathryn L. Shook of the Circuit Court of Montgomery County, Maryland, dismissing C-E-I-R's suit for an injunction against Computer Dynamics, Inc.

### MILITARY PRODUCTS GROUP FOR BENDIX COMPUTER

The Bendix Corporation's Computer Division has created a military computer products group. The group will specialize in research, engineering, production and sales of special-purpose computing systems, with initial emphasis in the growing area of military ground and shipboard computers. This will include tactical and strategic command and control, intelligence and surveillance data gathering, fire control, simulator and training, launch control and automatic checkout systems.

### ASI CELEBRATES FIRST ANNIVERSARY

Advanced Scientific Instruments, Inc., 5249 Hanson Court, Minneapolis, Minn., is celebrating its first anniversary as a manufacturer of computers. To date the company has announced the sale of two ASI 210 computers: one to NASA and the other to Argonne National Laboratory of the Atomic Energy Commission. ASI is completing

checkout of the prototype ASI 420, second in the ASI family of three high-speed, general-purpose computers. The third member of this computer family is the Advance II, a large scale machine.

### GENERAL PRECISION COMPLETES PURCHASE OF ROYAL MCBEE INTEREST IN COMPUTER COMPANY

General Precision, Inc., a subsidiary of General Precision Equipment Corporation, has purchased for \$5,000,000 the 50 percent interest held by Royal McBee Corporation in Royal Precision Corporation. Royal Precision, which manufactures and markets scientific and data processing computers, has been jointly owned by General Precision Equipment and Royal McBee.

It is expected that Royal Precision will shortly operate as the Data Processing Division of General Precision.

### NCR TO MARKET GENERAL TIME'S 'TRANSACTIONER' DATA-COLLECTION SYSTEMS

The National Cash Register Company, Dayton, Ohio, and General Time Corporation, New York, N.Y., have made an agreement under which NCR will market and service General Time's "Transactioner" data collection systems in the United States and Canada and in various overseas countries. General Time will continue its own marketing and servicing program for Transactioner systems.

### IBM SHIFTS HEADQUARTERS OF CHARACTER RECOGNITION DEVELOPMENT

International Business Machines Corporation is shifting all of its character-recognition development work to its new laboratory in Rochester, Minn. The developments to be carried on will involve both magnetic and optical recognition systems.

It was believed that the former laboratory at Endicott, N.Y. had reached its maximum effective size and that the Rochester plant was suited to build the type of equipment that would come out of the development work.

### AIEE-IRE BOARDS APPROVE MERGER PRINCIPLES

The Boards of Directors of the Institute of Radio Engineers and the American Institute of Electrical Engineers, in separate meet-



## WHAT GOES INTO A SUPERIOR COMPUTER TAPE?

Many things, tangible and intangible, go into the making of EP Computer Audiotape. On the tangible side, only the finest materials and equipment—meticulously selected and constantly tested—are used in producing this extra precision computer tape. In addition, every reel is 100% checked on specially-designed Automatic Certifiers to insure that each of the 112 million test pulses (161 million on high density tapes) reproduce properly . . . Less tangible but just as important are our years of experience in this exacting field. Experience that tells you Extra Precision Computer Audiotape consistently lives up to its name. Once you try this superior computer tape, we're certain that you'll agree.

**EP COMPUTER AUDIOTAPE / AUDIO DEVICES INC., 444 MADISON AVE., N. Y.**

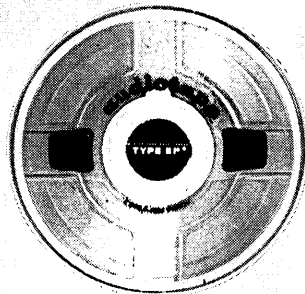

ings, approved in general the principles of the proposed consolidation of the two engineering societies.

At present, the IRE's membership is 97,000 and AIEE's 70,000. (Both figures include students.) Combined assets of the two societies total over \$6 million.

The proposed constitution, agreement of merger, and principles of consolidation will be submitted to the combined membership of both organizations for approval. If the memberships approve the consolidation, it is expected that the combined society will be operating by January 1, 1963.

## PEOPLE OF NOTE

H. W. THUE PROMOTED  
TO VICE PRESIDENT



An announcement has been made of the promotion of H. W. Thue to Vice President, Manufacturing, of the General Products Division of the International Business Machines Corp.

Mr. Thue was formerly Assistant General Manager for Manufacturing. He has been with IBM since August 1957. General Products Division is one of two IBM Divisions manufacturing data processing equipment in the United States. Mr. Thue is responsible for all manufacturing activities in the division.

POTTER NAMES RUDY TO EDP POST

Andrew R. Rudy has been named Supervisor of Electronic Data Processing at Potter Instrument Company, Inc., Plainview, N.Y. Mr. Rudy previously was tabulation supervisor of the Suffolk County Police Department.

COMPUTER DYNAMICS NAMES EXECUTIVES  
TO MANAGE NEW SERVICES DIVISIONS

Charles W. Burris, Jr., of Washington, D.C. was appointed Vice President and Manager of the new Systems Division of Computer Dynamics Corp., Silver Spring, Md.

Michael W. Pulscak, of Rockville, Md., was named Manager of the IMPACT Division.

Mr. Burris was formerly Manager of Systems Analysis and Government Marketing for Remington Rand Univac. He will be responsible for probing the decision-making process of management to determine and synthesize into a computer process those policies, techniques and procedures which govern and direct the most vital operations of an organization.

Mr. Pulscak, a senior systems analyst, is a specialist in the design and implementation of integrated processing systems. He is the originator of this company's new technique -- IMPACT -- Implementation Planning And Control Technique.

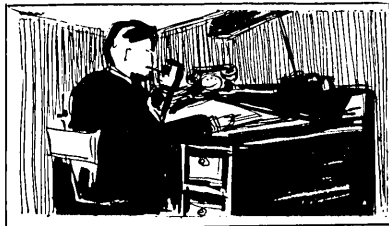

## Teaching Machines

TEACHING BY LONG-PLAYING RECORD

About 2½ million of the nation's sales people are getting some part of their job training through long-playing hi-fi-records, according to Sales and Marketing Executives -- International, 630 3rd Ave., New York. Most salesclerks respond well to this method of training, while sales managers like flicking a switch and letting somebody else give the "pep talk" to salesmen.

Sales training records bring the nation's experts to the trainee. Personal appearance fees of training specialists would be more than most companies could afford to pay.

One recording company has reported that it will alone sell more than 65,000 sales training records this year. A typical title among these best-sellers is "How to Win a Sales Argument Without Arguing".

## PUBLICATIONS

A STANDARD COMPUTER LANGUAGE  
FOR DEFENSE DEPARTMENT

The Defense Supply Agency has published a standard language applicable to an aspect of computers. The standard language is known as Military Standard MIL-STD-806B, "Graphic Symbols for Logic Diagrams". It will be used by engineering, training, and maintenance personnel who deal with the design, construction, installation, and maintenance of digital computers.

The Air Force introduced an early form of the standard two years ago and found it satisfactory. The present version incorporates the requirements of all military departments. It was prepared by the Electronics Systems division of the Air Force Systems Command, Bedford, Mass.

Copies are available from the Government Printing Office, Washington, D.C. or from military contracting officers.

NEWSLETTER "MODERN USES OF  
LOGIC IN LAW" -- MULL

The quarterly newsletter MULL, for "Modern Uses of Logic in Law" will henceforth be published at the American Bar Association headquarters in Chicago.

M.U.L.L. deals with the applications of modern logic, computer technology, and other aspects of information technology to law. It has been published to date by the special Committee on Electronic Data Retrieval of the American Bar Association in collaboration with Yale Law School.

Persons, whether or not members of the American Bar Association, may subscribe to M.U.L.L., at \$4 per year and \$10 for three years.

Subscriptions should be sent to the American Bar Association (Attention: Publications Department), American Bar Center, 1155 East 60th Street, Chicago 37, Ill

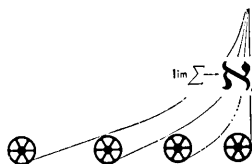

## ADVANCED AIR DEFENSE SYSTEMS WITH FIRST-DAY CAPABILITY

The needs of today's air defense systems pose a problem that would have seemed insoluble ten short years ago. The problem of furnishing mixed-weapons command and control, with first-day capability, in a system that is portable to any place in the world.

Here is how that problem has been solved through creative engineering utilizing a decade of industry progress in tactical data systems.

Systems already delivered by Litton to the military, or in the advanced state of development and production, include: Airborne Tactical Data Systems (AN/ASQ-54, AN/ASA-27) for the U.S. Navy, the Marine Corps Tactical Data System (AN/TYQ-1, AN/TYQ-2) for the U.S. Marine Corps, and the AN/FSG-1 Retrofit Improvement System (OA-3063/FSG-1 (V)) for the U.S. Army.

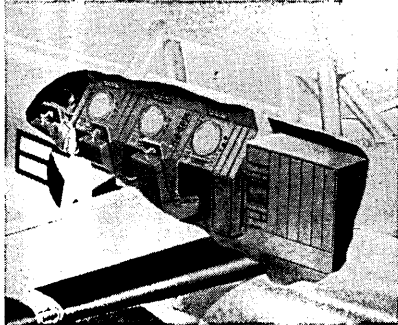

The first of these, the Airborne Tactical Data Systems, provides a capability for the mission of Airborne Early Warning and Control (AEW & C) in defense of large land masses, attack carrier task groups and other naval units. Both the AN/

ASQ-54, installed in a land-based AEW & C aircraft, and the AN/ASA-27, installed in a carrier-based AEW & C aircraft, furnish early warning data on enemy raids to surface elements of an air defense network and provide airborne control of interceptors.

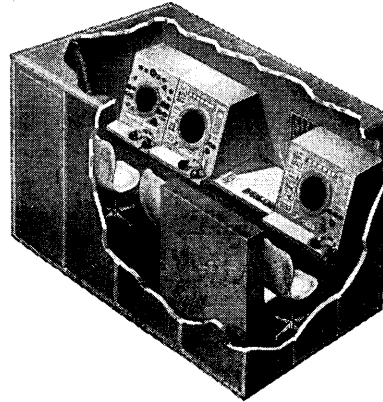

The second of these systems, the Marine Corps Tactical Data System (MTDS), features capabilities for continuous and effective control of Combat Air Operations during an amphibious assault. Facilities are available for control of aircraft on missions such as close air support, reconnaissance, and interdiction and for air defense with mixed weapons, both ship-based and shore-based surface-to-air missiles and interceptors. An integral air traffic control system assists in initial and continuous identification of friendly aircraft.

The third, the AN/FSG-1 Retrofit Improvement System, significantly increases the counter-countermeasures capability of the AN/FSG-1

Missile Master System deployed within the Continental United



States to furnish surface-to-air missile battery coordination in the defense of large cities and industrial areas.

Through the successful design, development and manufacture of systems for air defense missions, Litton has demonstrated its capability to proceed with even further advanced data systems. Such systems are now under conception and development at Litton.

*Air defense systems that not only fulfill today's defense requirements but also defy obsolescence for years to come require engineering that is versatile, inventive, aggressive, and adaptable. This is the kind of engineering Litton expects from its people. If you are qualified to perform engineering at this level, you are invited to write: H. E. Laur, Litton Systems, Inc., Data Systems Division, 6700 Eton Avenue, Canoga Park, California; or telephone DIamond 6-4040.*

An Equal Opportunity Employer

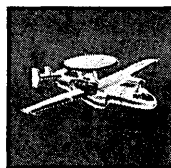

**DATA SYSTEMS DIVISION  
LITTON SYSTEMS, INC.**

A DIVISION OF LITTON INDUSTRIES

DATA HANDLING & DISPLAY SYSTEMS • COMPUTER SYSTEMS • MODULAR DISPERSED CONTROL SYSTEMS

## AUTOMATION

### AUTOMATIC STEEL ANALYZING SYSTEM OF BETHLEHEM STEEL

A fast, error-free data-conversion system utilizing a computer-printer combined with a spectrograph and teletype equipment, permits close analytical control on heats of carbon and alloy steels. The new equipment makes up a system for automatically analyzing steel samples and printing the results simultaneously in the laboratory and plant shop. An analysis can be obtained within two minutes after a test cycle is started.

The Bethlehem system does all operations automatically, including typing in both the laboratory and shop. It makes it possible to prevent heats being held overlong in the furnaces or from being downgraded because of incorrect analysis.

Bethlehem has installed the computer-printer in three plants.

### POLARIS PRODUCTION USES AUTOMATION

The reliability and efficiency of the Navy's Polaris missile is being further improved by tape-controlled equipment.

After "hand-building" the first of the Polaris missile systems, Lockheed Missiles and Space Co., Sunnyvale, Calif., decided to use tape-controlled equipment.

Among the benefits of numerical control machine tools are minimized tooling, reduced human error, increased reliability and a significant saving in time and money from the engineering drawing to the finished part.

The initial requirement was for three advanced tape-controlled machines -- a turret-type drill, an automatic multiple tool changer and a profiler-type milling machine. The multiple-tool-changer milling machine has 31 different tools which can be selected automatically and used for specific operations as directed by the computer. The computer does this operation by translating written specifications into commands directing the machine to produce the part. It interprets design information and calculates appropriate directions for the tool control system. These calculations are fed out on

a series of punched cards and the directions are converted to coded tape for the actual control of the tool.

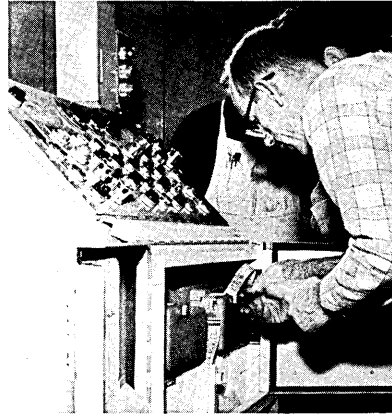

### JAPANESE ULTRA-MODERN CEMENT PLANT TO BE CONTROLLED BY TRW DIGITAL COMPUTER SYSTEM

Chichibu Cement Company's new plant at Kumagaya, near Tokyo, will be one of the world's first cement plants designed and constructed around a computer control system.

The computer, a Thompson Ramo Wooldridge Inc. RW-300, will be the heart of the closed-loop system for integrated control of wet blending and clinker burning operations in the plant. Four wet-process rotary kilns will be controlled and optimized by the system. In addition, the TRW computer system will schedule raw material -- from hoppers to mills, mills to slurry tanks, and slurry tanks to slurry basins.

### CONTROL OF MILLING MACHINE AND OF DRAWING MACHINE BY SAME COMPUTER TAPE

Thompson Ramo Wooldridge, Dage Division, 455 Sheridan Ave., Michigan City, Ind., is demonstrating a numerical-contouring control system in two combinations, one with a new automatic drafting machine, and the other with a contour-milling machine.

A TRW-3000 control system operates Universal Drafting Machine Company's new "Orthomat" machine to produce a verification drawing of a metal part.

The same tape is also used on a Gorton rail-type milling machine where another TRW-3000 numerical control system controls the actual production of the metal part.

The application of numerical control to the Orthomat machine allows information on the tape to be drawn on paper for verification, instead of being verified more expensively by machining with a machine tool. Thus advanced computer routines can be effectively verified at low cost.

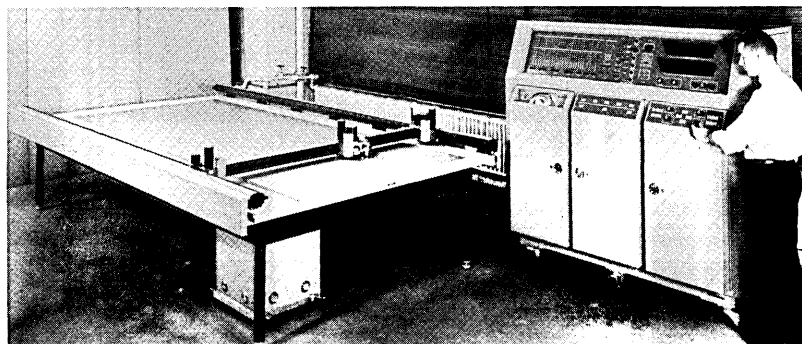
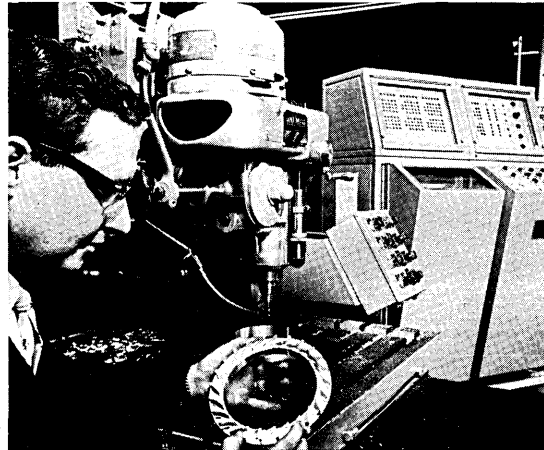

## NEW PRODUCTS

### ALTITUDE CONTROL SYSTEM

M. ten Bosch, Inc.  
Pleasantville, N.Y.

A device that can automatically control a plane's altitude has been developed by this company. This new system has made it possible to fly reliably at altitudes as low as 50 feet at speeds approaching that of sound. It has been successfully tested in low-flying U. S. Navy drones. A plane can travel at pre-determined heights with an accuracy in altitude of better than one foot, even when the plane is making a sharp turn. Accuracy is independent of the load, speed, or shape of the aircraft.

The altitude control system works by bouncing radar signals continuously off the ground below the aircraft. The resulting information is relayed to an electronic brain which makes sure that the plane's actual height above ground and the pre-programmed height are the same. The system uses a computer-controller which can be operated by manual or radio command. Signals received by the computer-controller are compared in the equipment, and an altitude signal is computed for the autopilot. The equipment disengages and the aircraft is maintained in a safe flying condition if a deviation from the pre-programmed instructions occur.

The equipment can be matched to any type of aircraft by a single adjustment.

### THIRTY-INCH PLOTTER FOR COMPUTER DATA

California Computer Products, Inc.  
8714 East Cleta St.  
Downey, Calif.

A new plotter, the CalComp 563, has been developed by this company. It provides for computer-controlled plots up to 29½ inches wide on 30 inch paper, and of any length from usual flat-bed size up to 120 feet on continuous-feed from the standard paper roll supplied for use with the plotter.

The CalComp 563 x-y plotter is capable of 200 steps/second operation in step increments of 1/100 inch. It operates on-line, through CalComp adapters, from the output

of medium-scale computers such as the IBM 1401 and 1620. Off-line operation from the output of large-scale computers is done with the CalComp 570 converter. The new plotter records data remotely when connected by telephone line with the computer source.

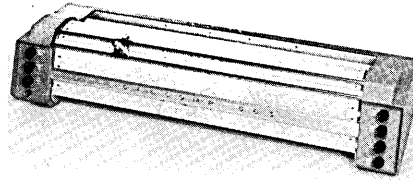

The CalComp 563 is designed for all graphic applications of computer-controlled digital operation.

### ANALOG COMPUTER CONTROLLING COLOR FILM PRINTER

The Pavelle Corp.  
New York, N.Y.

A new, three-minute, color-film developing process, which makes it possible for the photographic amateur to make his own color prints at home from color negatives, has been developed by this company.

What makes the printer-processor possible is a miniaturized analog computer. It determines the color balance and exposure from all popular-sized color negatives, and controls the making of enlarged 3½" square and 2½" x 3½" wallet-size color prints, and the processing of the prints -- all automatically in about 3 minutes.

### SHAFT-TO-DIGITAL CONVERTER

Rheem Manufacturing Co.  
Electronics Division  
5200 West 104th St.  
Los Angeles, Calif.

A new shaft-to-digital converter has been developed. This new product, the T-1000, provides 1000 increments for each revolution of the shaft. It senses shaft rotation and changes this information to digital pulses for measuring linear motion. Non-contacting magnetic sensing heads are used to improve reliability. The magnetic heads detect rotation of the shaft by impedance change in the head. The device has low torque load and precision construction.

## COMPUTER RESEARCH ENGINEERS & LOGICAL DESIGNERS

Rapid expansion of the Computer Laboratory at Hughes-Fullerton has created several attractive professional opportunities for qualified Computer Research Engineers and Logical Designers. These positions require active participation in broad computer R & D activities in connection with Army/Navy computer systems and new large-scale, general-purpose computers. These multiple processor computers utilize advanced solid-state circuitry, gating and resolution times in the millimicrosecond regions; combine synchronous and asynchronous techniques for maximum speed and reliability.

These professional assignments involve broad areas of logical design, programming and system conception. Fields of interest include:

- Distributed computers ■ Advanced arithmetic processing techniques ■ Mechanized design
- Asynchronous design techniques ■ Utilization of parametrons in computers ■ Studies in the utilization of multiple processor computers.

These professional assignments involve such R & D areas as:

- Solid state digital circuitry involving millimicrosecond logic
- Microwave carrier digital circuits
- Sub-microsecond core memory
- Thin film storage techniques
- Functional circuit concepts
- Micro-miniaturization concepts
- Tunnel diodes ■ Microwave parametrons ■ Circuit organization for maximal-speed computing.

Located in Southern California's Orange County (the nation's fastest growing electronics center), Hughes-Fullerton offers you: a stimulating working environment; private or semi-private offices; long-term stability.

**CALL COLLECT TODAY!**  
For complete information on these challenging assignments, call us collect today! Ask for:

**Mr. J. E. TENNEY at:**  
TROjan 1-4080, ext. 3741.

Or, airmail resume to: HUGHES-FULLERTON R & D, P. O. Box 2097, Fullerton 1, California.

An equal opportunity employer.

## HUGHES

# Engineers

## What do you know about the H1800?

This newest digital computer system has just been announced by Honeywell Electronic Data Processing. Here are a few features of this latest system you should find quite interesting.

The H1800 has a new central processor with an internal operating speed of more than 120,000 three-address operation a second — a two micro-second memory access speed time, and a new floating point unit that operates at nano-second speeds, using tunnel-diode circuitry.

The H1800 utilizes the ability to operate eight different programs simultaneously and to perform automatic error detection and correction. The H1800 is one more proof that Honeywell EDP is setting the pace for the EDP industry and for EDP career opportunities.

Other computer systems in Honeywell's growing line include the H800, its medium-scale counter part the H400 and the H290 industrial process control system. Professional opportunities to work on the design of present and future computer systems exist in the following areas:

**Circuit Designers**  
**Logical Designers**  
**Electrical Engineers**  
**Product Designers**

San Francisco interviews:  
Call Richard Bueschel at  
DOuglas 2-8800 during the  
SJCC May 1-3 in San Francisco.

As a member of our Engineering and Research Center in suburban Boston, you will be able to take advantage of Honeywell's tuition-support at any of the world-renowned universities in the area. Honeywell also provides a liberal fringe benefits program and will pay all normal relocation costs.

Address your resume to:  
Richard T. Bueschel,  
Personnel Manager  
Engineering and Research  
Center  
151 Needham Street, Dept.  
Newton Highlands, Massachusetts

# Honeywell



*Electronic Data Processing*

Opportunities also exist in other Honeywell divisions coast to coast. Send resume to H. E. Eckstrom, Minneapolis-Honeywell, Minneapolis 8, Minnesota. "An equal opportunity employer"

### HIGH-SPEED DIGITAL DATA RECORDER

Perkin-Elmer Corporation  
Norwalk, Conn.

A new, high-speed digital data recorder with an output rate of 110 characters per second has been developed by this company.

The data recorder was developed to serve as a flexible link between data-logging systems and general computers. The basic system consists of an analog-digital converter, a translator and a tape punch. A wide flexibility in modes of recording binary data has been provided.

### NEW HIGH-SPEED TAPE PERFORATOR

Anadex Instruments, Inc.  
Van Nuys, Calif.

A new, high-speed tape perforator has been developed by this company. It offers speeds up to 60 cps and has a non-synchronous drive. Five to eight code channels are available. Paper or mylar tape in widths up to one inch is used.

The perforator is designed for recording digital data in punched tape from computer output, data logging systems, machine control systems, automatic test and simulation systems, data transmission systems, and keyboard or other manual systems.

### NEW X-Y RECORDER HAS SOLID STATE CIRCUITRY

Electronic Associates, Inc.  
Long Branch, N.J.

A new X-Y plotter-recorder having 100 microvolt/inch sensitivity, solid-state circuits and dual-mode hydraulic damping has been developed by this company.

The new instrument, known as the Series 1110 Variplotter, produces an inked plot of two input voltages (X and Y) on either standard 11 x 17 inch or 8½ x 11 inch graph paper. The 1110 will operate in any position, 0 through 360 degrees and is suitable for table top use or rack mounting.

Two types of hydraulic damping are included, so the operator can select either viscous-coupled inertia damping for high-speed plotting, or velocity damping for point plotting or lower-speed line plotting.

#### NEW DOCUMENT SORTER

Pitney-Bowes, Inc.  
Stamford, Conn.  
and  
The National Cash Register Co.  
Dayton, Ohio

A new document sorter, which will electronically read and sort 1,620 checks a minute, has been developed jointly by these two companies.

The new "Class 403" machine will handle intermixed documents of varying sizes, thicknesses, and weights. The new 403 sorter will incorporate a new high-speed transport and a new reading mechanism which will make it possible for a bank to sort checks more than 30 times faster than by manual methods.

The sorter not only automates the physical paper-handling job, but is a link in the automation of checking-account record-keeping in a computer system. With the NCR 315 electronic data processing system, information can be read from checks and other documents directly into the computer for automatic preparation of all subsequent depositor statements and bank records. The 403 sorter can also be operated with the NCR 310 desk-size computer, which provides high-speed programmed sorting and listing to automate a bank's transit and clearing operations.

Pitney-Bowes will manufacture the mechanical transport of the sorter and NCR will produce the electronic reading mechanism. The sorter will be marketed to banks exclusively by NCR.

#### OPTICAL SCANNER OF PAGES OF SELECTED DATA

Farrington Electronics, Inc.  
Alexandria, Va.

An electronic reading machine capable of selecting specified data from a business document and converting the information into computer language has been developed by this company.

This machine reads at the rate of 200 characters per second. Punched card, magnetic tape or perforated tape output is available. Programming flexibility is obtained with an interchangeable wiring panel. Control of the selection of a scanning field within any particular line permits recognition of the groups of information selected, all other information being ignored automatically.

## Programmers

### What do you know about the H1800?

If your answer is "Nothing", you're probably wrong. This newest member of Honeywell's growing line of digital computer systems will seem quite familiar to many business and scientific programmers.

The H1800 is a powerful extension of Honeywell's other computer systems, the H800, and its medium-scale counterpart, the H400.

All three systems utilize the unique and proven software packages that have made Honeywell's EDP systems one of the most competent and versatile in the industry. The H1800 now makes them one of the most powerful.

Honeywell's growing line of automatic programming aids, including FACT, EASY, COBOL, ARGUS, ALGOL-type Compilers, etc., can handle a broad variety of computer applications. The addition of the new H1800, with its great central processor and magnetic tape speeds, now permits Honeywell programmers to engage in larger business data processing jobs, more complex scientific computations and real-time applications. These broadening horizons of work at Honeywell have created unique opportunities for professional growth and personal advancement to those Programmers who join us now. Immediate opportunities exist in the following areas:

#### **Automatic Programming Operational Programming Compiler Development Systems Analysis**

**San Francisco interviews:  
Call Dr. Roger Bender at  
YUkon 1-8010 during SJCC,  
May 1-3 in San Francisco.**

*In addition to the usual professional employee benefits, Honeywell offers a unique educational-support program:*

Address your resume to:  
**Mr. John L. Ritchie**  
Personnel Manager  
Programming Systems Division  
60 Walnut Street  
Dept. 519,  
Wellesley Hills, Mass.

## Honeywell

 *Electronic Data Processing*

Opportunities also exist in other Honeywell divisions coast to coast. Send resume to H. E. Eckstrom, Minneapolis-Honeywell, Minneapolis 8, Minnesota. "An equal opportunity employer"



## Curious About Computers?

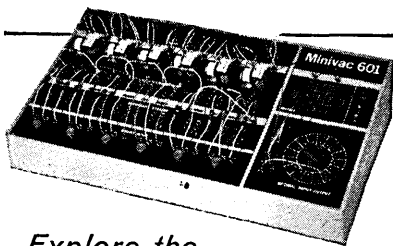

Explore the exciting world of electronic brains with

# Minivac

Learn digital computer theory. Discover how large multimillion dollar computers operate... what they can and cannot do. Construct and understand circuits similar to those of the most advanced data processing machines. You can do all this and more with MINIVAC — a unique scientific educational device. It receives, processes and remembers information and communicates answers to questions and problems based on the data it's given — in the same manner as full-scale commercial computers!

### EASY TO USE

A set of illustrated manuals — containing easy-to-follow, step-by-step instructions — accompanies each MINIVAC. Experiments teach you basic principles... demonstrate how computers do arithmetic, solve mathematical problems, use logic to make decisions.

### BY ANYONE

No knowledge of electronics, higher mathematics or computer technology is necessary. Anyone with an inquiring mind can use MINIVAC — teenagers and adults... students and teachers... businessmen, engineers, hobbyists.

### AND UNCONDITIONALLY GUARANTEED

MINIVAC is fully guaranteed against defects in manufacture and, in addition, carries a 10-day unconditional money-back guarantee.

### TWO MODELS AVAILABLE

MINIVAC 601, a computer simulator with which you can learn basic principles and operations \$95.00

MINIVAC 6010, an advanced model that lets you perform more sophisticated experiments, solve more complex problems..... \$155.00

### SEND FOR DESCRIPTIVE LITERATURE — TODAY!

Scientific Development Corporation  
Dept. CA-5  
372 Main Street  
Watertown, Massachusetts

Please send literature on MINIVAC 601  MINIVAC 6010

Name.....

Street.....

City..... Zone..... State.....

The first Selected Data Page Scanner will be delivered to Aetna Insurance Co., Hartford, Conn. This will be used to scan insurance policy declaration forms and extract the pertinent individual data for computer input. The machine is expected to find application in a wide variety of industries which use complex business forms governed by legal, regulatory, or accounting standards.

### DATAKOM FOR DIAL TWX SERVICE

Automatic Electric Co.  
Subsidiary of General Telephone and Electronics Corp.  
Northlake, Ill.

Equipment called DATAKOM for dial TWX (teletypewriter switching) service has been made available by this company. This equipment will allow independent telephone companies to convert from manual TWX service to dial operation. They are preparing now to join in Bell System's plans for a nationwide cutover to dial TWX on Labor Day, 1962.

A TWX subscriber will be able to dial directly to any other TWX unit in the country. The plan requires the transmission of teletypewriter (digital) data over existing voice (analog) channels. To do this, the DC signal from a teletypewriter must be transformed into voice-frequency tones and then reconverted at the receiving end. Two special devices will be a part of every teletypewriter station, in order to accomplish this. The DATAKOM subset AE 691A permits the subscriber to dial directly. The phone handset will have a receiver only, which will allow supervisory tones and signals to be heard. After connection is made, 60 words per minute data transmission will follow. The DATAKOM data set AE 101A, which mounts on the side of the teletypewriter, converts the DC signals to tone signals on the sending end, and reconverts them to DC signals on the receiving end.

### LOW-COST PUNCH AND READER UNITS

Royal McBee Corporation  
850 Third Avenue  
New York 22, N.Y.

This company has developed a Punched Tape Reader and a Punched Tape Perforator to serve the data-processing component needs of business equipment manufacturers. The Royal McBee Series 500 punch and reader has a basic speed of 50

characters per second. The devices weigh only 2 3/4 pounds and combine flexibility of input-output with high operating speeds, accuracy and low cost.

The punched paper-tape reader is suited to message relaying, data collection, business machines, computer input, or machine tool and plotter control. A semi-automatic tape insertion feature reduces tape loading and unloading time.

The punched-tape perforator feeds in either forward or reverse directions at the same speed as the reader. It makes use of a new principle which uses the holding power of small electromagnets in combination with off-center springs to engage the selected punches.

### 10 MILLISECOND MAGNETOSTRICTIVE DELAY LINE

Deltime Inc.  
608 Fayette Ave.  
Mamaroneck, N.Y.

This company has developed a magnetically-shielded, magnetostrictive delay line providing a delay length of 10 milliseconds. The new Deltime Type 174 operates at 655 KC/S pulse repetition rate with return-to-zero.

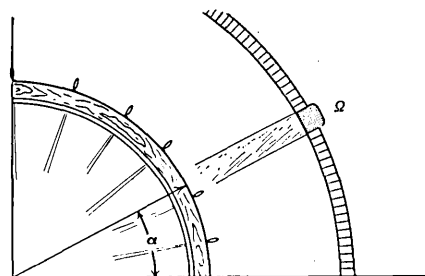
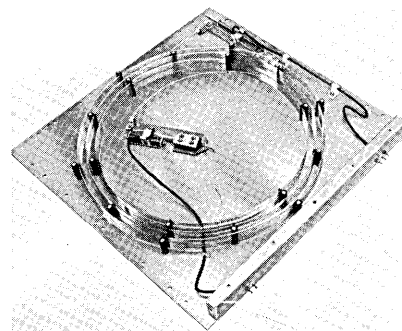

## MAGNETIC-TAPE CLEANER

Cybetronics, Inc.  
132 Calvary St.  
Waltham 54, Mass.

The Cybetronics Model E magnetic-tape cleaner gives safe, rapid cleaning of both blank and recorded tapes. The device removes lint, dirt, loose oxide, or Mylar particles from both sides of the tape in a single pass.

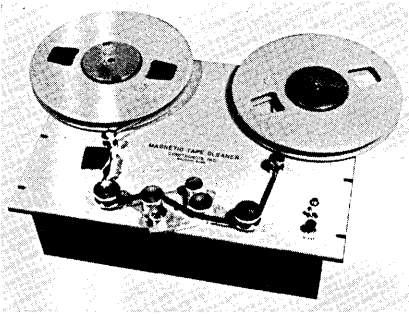

The cleaning process is entirely dry and does not affect, in any way, the data stored on the tape. The machine also operates as a tape rewinder. Its dimensions are 19" x 14" x 8".

## NEW APD DATA ACQUISITION SYSTEM

Genisco Inc.  
2233 Federal Ave.  
Los Angeles 64, Calif.

A new high-speed version of the Analog-to-Pulse-Duration (APD) Data-Acquisition System for process control has been developed by this company. The device has a sampling rate of 200 channels per second.

The pulse-duration output is digitally measured for other uses, such as display, recording, and further processing to become input to digital computing equipment. The device has a permanent "sample and hold" feature and can be designed to operate either in sequential or parallel data-sampling.

## DIGITAL LOGIC MODULES

Harman-Kardon, Inc.  
Data Systems Division  
Plainview, N.Y.

A line of rentable digital logic modules has been developed by this company.

These modules, called Facilogic, can be incorporated in systems breadboarding or in designing one-shot specialized systems or for personnel training. When the need has ended, the modules can be re-

turned to the manufacturer eliminating investment in permanent equipment.

Power connections are automatically made to each module as it is plugged into the rack. The schematic of the individual module is silk-screened onto its face. The logical diagrams conform to applicable military specs. Connections may be made at the front or rear of the module. Each module contains an indicator light to show the logical statement of the circuit. Simplified loading rules are printed on the front of each module. Each module has built-in short circuit protection.

Blank modules are available for construction of special circuits by the customer.

## NEW ITT-025 DATA PROCESSOR

ITT Federal Laboratories  
Division of International  
Telephone and Telegraph Co.  
Nutley, N.J.

A data processor for communication purposes, adapted to a variety of military applications, has been developed by this company.

This equipment is a military switching system for storing and forwarding communications. Called the ITT-025, it is able to receive, process, and transmit messages of a large number of communication lines simultaneously. Up to 256 separate jobs can be handled at the same time. Its functions include automatic alternate routing of messages, message verification, retransmission of garbled messages, continuous self-checking, and traffic accounting to ensure that all messages are properly received.

## MEDIUM-SCALE COMPUTER ANNOUNCED FOR JAPANESE MARKET

Nippon Electric Co., Ltd.  
Tokyo, Japan

A new medium-scale business and scientific computer made by this company will be marketed in Japan this fall. The new computer is specifically intended to compete with some American medium-sized computers, which are gaining popularity with Japanese users.

The medium-size system, called NEAC 2230, has operating speeds on the order of 100 microseconds for fixed-point addition and subtraction, 3 milliseconds for fixed-point multiplication, 6 milli-

# COMPUTER PROGRAMMERS

7030  
(STRETCH),  
7090,  
AN/FSQ-7  
(SAGE)

C  
O  
M  
P  
R  
O  
G  
R  
A  
M  
M  
E  
R  
S

MITRE is expanding its effort on the design and development of computer programs for critical experiments in the area of large-scale computer-based command and control systems. Test facilities are now equipped with 7090, 1401, and AN/FSQ-7 (SAGE) computers. These facilities will soon be expanded to include a 7030 STRETCH computer.

Experienced Programmers interested in important assignments can find professional fulfillment in these areas:

- Problem-Oriented Languages
- Computer Applications
- Programming Research
- Numerical Analysis
- Real Time System Design
- Utility Program Design
- System Programming Techniques
- Information Storage and Retrieval
- Facility Operations
- Computer System Evaluation

Recent college graduates with high scholastic achievements and an interest in helping us develop these fields are also invited to apply.

Inquiries may be directed in confidence to: Vice President — Technical Operations, The MITRE Corporation, Post Office Box 208, Dept. ME5, Bedford, Massachusetts.

MITRE is an independent, nonprofit corporation working with — not in competition with — industry. Formed under the sponsorship of the Massachusetts Institute of Technology, MITRE is Technical Advisor to the Air Force Electronic Systems Division, and chartered to work for such other Government agencies as FAA.

THE  
**MITRE**  
CORPORATION

An Equal Opportunity Employer



**ADVANCED  
PROGRAMMING  
RESEARCH**

The expanding utilization of NCR's computer systems has created new opportunities for experienced programmers familiar with automatic programming techniques. College education, plus 2-5 years' experience with large scale magnetic tape systems can qualify you for a rewarding career with NCR, one of the world's leading business machine manufacturers. Recognized and respected wherever men trade, NCR stands alone for its creative and flexible approach to business system development.

*Aside from the opportunities present in Programming Research, other openings in our expanding operation include:*

- **Installation Representative:** experience required, covers magnetic tape system programming, knowledge of complete business systems, and ability to work effectively as a representative of NCR.
- **Programmer:** for small systems work which requires good background in data processing as related to normal business functions and some knowledge of programming of magnetic tape systems. Intermittent customer contact.
- **Instructor:** experience and education should be such that the person employed can effectively train programming personnel. Familiarity with math and business systems is desirable. Programming of magnetic tape systems necessary.

Other opportunities may more nearly meet your particular experience and aspirations. To investigate, you need only write, sending complete resume to:

**T. F. Wade, Technical Placement,  
The National Cash-Register Company,  
Main & K Streets, Dayton 9,  
Ohio**

*An Equal Opportunity Employer*

seconds for fixed-point division, and an internal core memory of 2400 words capacity with an average access time of 5 microseconds.

Along with the medium-sized computer, NEC also has developed a large computer system for business and scientific data processing.

**NEW PERFORATED TAPE READER**

Potter Instrument Company, Inc.  
Plainview, N.Y.

This company has shown its new PTR-50 perforated tape reader and its companion PTS-50 spooler.

The PTR-50 reader uses photoelectric sensing for two-way high-speed reading and introduces the Potter Monobrake Tape Stop System, a device to eliminate tape bounce and buckling at the read station. The companion PTS-50 spooler is an improved version of the Potter Model 3299 Dual Spooler. Either two-speed or single-speed units are available. The PTR-50 and PTS-50 combination takes tape widths of 11/16", 7/8", or 1", with changeover accomplished by repositioning the tape guide posts.

**NEW HIGH-SPEED  
DIGITAL CONTROL COMPUTER**

Thompson Ramo Wooldridge Inc.  
TRW Computers Company  
Canoga Park, Calif.

A new, high-speed control computer system that can perform over 20,000 operations per second has been developed by this company. The new machine, called TRW-340, combines a rapid core memory with a high-volume drum memory.

The computer's core memory is expandable from 4,000 to 16,000 words; drum memory is expandable from 8,000 to over 112,000 words. The TRW-340 has the capacity for almost unlimited expansion of the number of digital and analog inputs and outputs. The computer is designed to be compatible with all optional equipment, including programming software, available with the previous computer TRW-330.

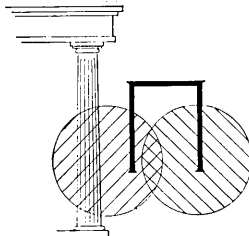

**NEW CONTRACTS**

DATATROL CORPORATION  
AWARDED NATIONAL SCIENCE FOUNDATION  
STUDY CONTRACT

The Datatrol Corporation, Silver Spring, Maryland, has been awarded a contract by the National Science Foundation to investigate problems in applying the technical indexing and retrieval vocabulary of one large information system to documents catalogued in another.

In the project's initial phase, a preliminary table of equivalents will be developed for the descriptors used by the Armed Services Technical Information Agency in terms of subject headings employed by the Atomic Energy Commission. After the tables of equivalents are compiled and established in suitable form, a computer will be used to edit and update them. The results will be printed out for publication.

**CUBIC BUILDS PACIFIC  
TRACKING STATIONS**

Cubic Corporation, San Diego 11, Calif., is supplying tracking systems for locating and recovering satellites in a vast area west of the Hawaiian Islands. Two recovery stations in the Pacific are being supplied under separate contracts totaling \$800,000.

The stations are constructed around the Diamond AGAVE system (Automatic Gimballed Antenna Vectoring Equipment) which acts as an acquisition, tracking and telemetry antenna. The AGAVE will locate, lock-on and automatically track the re-entering vehicle, providing direction and vector coordinates in a digital form to be converted into teletype format for real-time transmission to air and sea recovery forces.

**VA TO USE DIAL-O-VERTER EQUIPMENT**

The Digitronics Corporation, Albertson, N.Y., has received an order for four Dial-o-verter magnetic tape terminals from the Veterans Administration. Using this equipment, the VA will transmit approximately 4,000,000 words of insurance data daily over phone lines.

Two Dial-o-verter terminals will be installed in the data pro-

THE  
DIG  
RAN  
AND

cessing center in Philadelphia. Similar terminals will be installed in insurance centers in Denver and St. Paul.

**OVER \$2 MILLION CONTRACT FOR COLLINS RADIO CO.**

Aeronautical Radio, Inc., (ARINC) has awarded Collins Radio Company, Dallas, Texas, a contract for over \$2 million for the first Collins C-8000 Communication Switching System.

ARINC is one of the world's largest specialized communication companies, furnishing air-ground-air and point-to-point communication through domestic and overseas facilities. It serves all U.S. airlines, foreign flag aircraft entering the U.S., and several hundred corporate aircraft operators.

The Collins system is an electronic automatic telegraph-message switching and processing exchange which integrates high-speed teletype communication with data-processing techniques.

**PACKARD BELL COMPUTER CORP. AWARDED CONTRACT**

The Ford Instrument Division of Sperry Rand Corporation has awarded a contract to Packard Bell Computer Corp., Los Angeles 25, Calif., for two Nontrajectory Recording Systems for shipboard use. These digital data systems, to be used as part of the Mobile Atlantic Missile Range System (MARS), will accept 64 channels of analog information; convert the information to digital form; and record it on magnetic tape in proper format for automatic processing by a computer. The systems will be used in tracking missiles and satellites fired out over the Atlantic Missile Range.

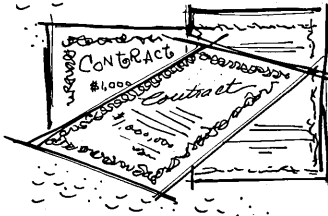

**INFORMATION RETRIEVAL APPLIED TO INTELLIGENCE DATA PROCESSING SYSTEMS**

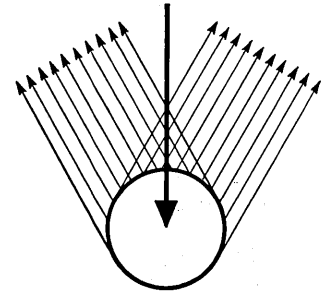

**REQUIRING DATA SYSTEM ANALYSTS SENIOR COMPUTER PROGRAMMERS**

MITRE's expanding role in systems engineering for the Air Force Electronic Systems Division has led to an increased effort in the design and development of intelligence data processing systems. There are new opportunities for creative work in automatic indexing and retrieval, systems analysis and synthesis.

MITRE is engaged in the analysis of intelligence operations at several Air Force Commands. Command requirements for accurate and timely intelligence support is leading to the use of automatic data processing systems. MITRE is assisting the Air Force in determining the extent and means of applying automatic data processing to the intelligence problems. This work is supported by experimental activities at our Bedford operation in pleasant suburban Boston. Positions are also available in Colorado Springs, Colo., Omaha, Neb., and Washington, D. C.

Write in confidence to Vice President — Technical Operations, The MITRE Corporation, P. O. Box 208, Dept. ME5, Bedford, Mass.

MITRE is an independent, nonprofit corporation working with — not in competition with — industry. Formed under the sponsorship of the Massachusetts Institute of Technology, MITRE is Technical Advisor to the Air Force Electronic Systems Division, and chartered to work for such other Government agencies as FAA.

**THE MITRE CORPORATION**

*An Equal Opportunity Employer*

**CAREER DATA for COMMERCIAL & SCIENTIFIC PROGRAMMERS**

You are invited to consult with our electronics engineering oriented staff to evaluate your peak professional potential in the dynamically expanding field of automation...

Discuss your technical capabilities, specialized experience and professional goals with one of our experienced staff members; choose an assignment with the optimum future potential for you... Our clients are selected companies in the electronics industry and assume all expenses.

**Immediate Responsible Positions For:**

- Computer Programmers
- Applied Mathematicians
- Systems & Methods Analysts
- Digital Circuit Designers
- Logic Circuit Designers
- Sales Engineers
- Electronic Engineers
- Operations Research

Direct resumes in confidence to:  
EDP Search—Dept. 10

**E. J. BETTINGER COMPANY**

*Technical Personnel Consultants to the Electronics Industry*  
20 South 15th Street, Philadelphia 2, Pennsylvania  
LOcust 4-0700

# CALENDAR OF COMING EVENTS

- May 7-8, 1962: Fifth Annual Conference of the Association of Records Executives and Administrators, Waldorf-Astoria Hotel, New York City; contact Miss Judith Gordon, AREA Conference publicity chairman, Metal & Thermit Corp., Rahway, N. J.
- May 8-10, 1962: Electronic Components Conference, Marriott Twin Bridges Hotel, Washington, D. C.; contact Henry A. Stone, Bell Tel. Lab., Murray Hill, N. J.
- May 9-11, 1962: Operations Research Society of America, Tenth Anniversary Meeting, Shoreham Hotel, Washington, D. C.; contact Harold O. Davidson, Operations Research Inc., 8605 Cameron St., Silver Spring, Md.
- May 14-16, 1962: National Aerospace Electronics Conference, Biltmore Hotel, Dayton, Ohio; contact George A. Langston, 4725 Rean Meadow Dr., Dayton, Ohio
- May 21-25, 1962: Institute on Electronic Information Display Systems, The American University, Washington, D. C.; contact Dr. Lowell H. Hattery, Director, Center for Technology and Administration, The American University, 1901 F St., N.W., Washington 6, D. C.
- May 22-24, 1962: Conference on Self-Organizing Systems, Museum of Science and Industry, Chicago, Ill.; contact Mr. George T. Jacobi, COSOS Conference Sec'y, Armour Research Foundation, 10 W. 35 St., Chicago 16, Ill.
- May 28-June 1, 1962: Colloquium on Modern Computation Techniques in Industrial Automatic Control, Paris, France; contact French Association of Automatic Control (AFRA), 19, Rue Blanche, Paris 9, France.
- June 4-14, 1962: Mathematical Techniques of Optimization (10-Day Short Course on Operations Research), Purdue University, Lafayette, Ind.; contact Div. of Adult Education, Purdue University, Lafayette, Ind.
- June 11-July 20, 1962: Summer Institute on Advanced Topics in the Computer Sciences, Computation Center, University of North Carolina, Chapel Hill, N. C.; contact Dr. John W. Carr, III, Computation Center, University of North Carolina, P. O. Box 929, Chapel Hill, N. C.
- June 18-Sept. 14, 1962: Engineering Summer Conference Courses, Univ. of Mich., Ann Arbor, Mich.; contact Raymond E. Carroll, Univ. of Mich., 126 West Engineering Bldg., Ann Arbor, Mich.
- June 19-21, 1962: Fourth Joint Automatic Control Conference, Univ. of Texas, Austin, Tex.; contact Prof. Otis L. Updike, Dept. of Chemical Engineering, Univ. of Va., Charlottesville, Va.
- June 19-21, 1962: Second Annual San Diego BioMedical Engineering Symposium and Exhibit, Stardust Motor Hotel, San Diego, Calif.; contact The Program Committee, Inter-Science, Inc., 8484 La Jolla Shores Dr., La Jolla, Calif.
- June 19-22, 1962: National Machine Accountants Association International Conference, Hotel Statler, New York, N. Y.; contact R. Calvin Elliott, Exec. Dir., NMAA, 524 Busse Highway, Park Ridge, Ill.

## ADVERTISING INDEX

Following is the index of advertisements. Each item contains: Name and address of the advertiser / page number where the advertisement appears / name of agency if any.

- American Telephone & Telegraph Co., 195 Broadway, New York 7, N. Y. / Page 2 / N. W. Ayer & Son, Inc.
- Audio Devices, Inc., 444 Madison Ave., New York, N. Y. / Page 49 / Charles W. Hoyt Co., Inc.
- Bendix Computer Division, 5630 Arbor Vitae St., Los Angeles 45, Calif. / Pages 15, 47 / John B. Shaw Co., Inc.
- E. J. Bettinger Co., 20 So. 15 St., Philadelphia 2, Pa. / Page 59 / Diener & Dorskind
- Burroughs Corp., Detroit 32, Mich. / Page 43 / Campbell-Ewald Co.
- California Computer Products, Inc., 8714 Cleta St., Downey, Calif. / Page 7 / Hal Stebbins, Inc.
- Computron Inc., 122 Calvary St., Waltham, Mass. / Page 64 / Larcom Randall Advertising, Inc.
- Control Data Corp., 501 Park Ave., Minneapolis 15, Minn. Pages 10, 11 / -
- Honeywell Electronic Data Processing, Newton Highlands, Mass. / Page 54 / Allied Advertising Agency, Inc.
- Honeywell Electronic Data Processing, Wellesley Hills 81, Mass. / Page 55 / Allied Advertising Agency, Inc.
- Honeywell Electronic Data Processing, Wellesley Hills 81, Mass. / Pages 30, 31 / Batten, Barton, Durstine & Osborn
- Hughes Aircraft Co., Culver City, Calif. / Page 53 / Foote, Cone & Belding
- International Business Machines Corp., 590 Madison Ave., New York 22, N. Y. / Page 39 / Benton & Bowles, Inc.
- Laboratory for Electronics, Inc., 305 Webster St., Monterey, Calif. / Page 22 / -
- Litton Systems, Inc., Data Systems Div., 6700 Eton Ave., Canoga Park, Calif. / Page 51 / Compton Advertising, Inc.
- Litton Systems, Inc., Guidance and Control Systems Div., 5500 Canoga Ave., Woodland Hills, Calif. / Page 45 / Compton Advertising, Inc.
- The Mitre Corp., Box 208, Bedford, Mass. / Pages 57, 59, 61 / The Bresnick Co., Inc.
- The National Cash Register Co., Main & K Sts., Dayton 9, Ohio / Pages 4, 58 / McCann-Erickson, Inc.
- The National Cash Register Co., Electronics Div., 1401 E. El Segundo Blvd., Hawthorne, Calif. / Page 8 / Allen, Dorsey & Hatfield, Inc.
- Potter Instrument Co., Inc., Plainview, N. Y. / Page 62 / Gamut, Inc.
- Reeves Soundcraft Corp., Great Pasture Rd., Danbury, Conn. / Page 3 / The Wexton Co., Inc.
- Scientific Development Corp., 372 Main St., Watertown, Mass. / Page 56 / Chirurg & Cairns, Inc.
- Space Technology Laboratories, Inc., P. O. Box 95005, Los Angeles 45, Calif. / Page 41 / Fuller & Smith & Ross, Inc.
- Tally Register Co., 1310 Mercer St., Seattle 9, Wash. / Page 9 / Bonfield Associates, Inc.
- Technical Operations, Inc., 3600 M St., N. W., Washington 7, D. C. / Page 63 / Edwin F. Hall

## NEW APPLICATIONS

### COMPUTER TO AID IN BATTLE AGAINST HURRICANES

A high-speed scientific computer is being put into service by a group of Department of Commerce Weather Bureau meteorologists to aid in their battle against the hurricane. Twenty-five meteorologists and data processing experts are using a new General Electric 225 computer to process hundreds of thousands of weather readings. Their goal is to build a mathematical model of a hurricane to permit more rapid forecasting.

Reconnaissance aircraft, which fly through live hurricanes, collect approximately 100,000 readings on their instruments in a single day. The collected data are stored on magnetic tapes until completion of the flight. The tapes are then taken to the computer center and placed in the computer for a series of processing routines.

The National Hurricane Research Project was authorized by Congress in late 1955. A sister group of NHRP, the Research Flight Facility, is charged with the responsibility for airborne data collection.

### ANALOG COMPUTING TECHNIQUE SIMPLIFIES RESEARCH ON EFFECTS OF DRUGS

Sloan-Kettering Cancer Center, New York, N.Y., and Electronic Gear, Inc., have together developed a machine useful in analyzing the effects of different drugs on the human body.

The equipment analyzes the air inhaled and exhaled by a person and converts the measurements into electrical signals, which are fed directly to a special-purpose analog computer. The computer was designed to solve a special equation, the solution of which shows how completely the air cells of the lungs are ventilated during the breathing process. This ventilation factor serves as a measure of the response of the respiratory center of the brain, and this is useful in the study of the depressant effects of various drugs.

Medical researchers will now have a simple technique for evaluation of new drugs by simultaneous

study of many physiological factors. It is also expected that the equipment will improve understanding of respiration during anesthesia.

### SECRET SERVICE PUTS ELECTRONIC EYE ON FORGERS

The U. S. Secret Service, Washington, D.C., after two years of testing, is convinced that electronic classification of handwriting characteristics could serve to alert all areas of the nation to a check forging operation. It has asked Congress for \$10,000 to rent its own computer time.

The service's forgery section handles about 40,000 forgeries a year. Professional forgers steal government checks, mostly from mail boxes, in one city, forge the endorsement, and cash them elsewhere. They keep on the move so that by the time the theft and forgery are discovered the culprit is no longer nearby. It is hard to watch out for him because the forger never uses the same name twice.

Careful study of past forgeries by the same person produces clues about him. James L. Lewis, special agent in charge of the service's forgery section, has developed a system for classifying the letters as appearing in forged signatures. He enters such letters in a master file. By scanning the file, Mr. Lewis or his assistant, Special Agent Paul E. Henne, often can match a batch of checks forged by the same person.

Scanning the master file by hand and eye, however, is slow and time consuming. But it can be done electronically -- by a computer which then prints a list of all forged checks featuring the same unusual letter or letters.

### ELECTRONICS INVENTORY CONTROL PROBLEM SOLVED BY COMPUTER

A major electronics distributor has tight control of inventory covering 30,000 items through a continuous processing system that reports activity and status for all items daily. The New York computer center of Statistical Tabulating Corporation processes the card input on its 1400-series computer.

About 600 orders are processed daily. A daily report is given to the electronics distributor showing activity customer by

## OPENINGS IN AIR TRAFFIC CONTROL

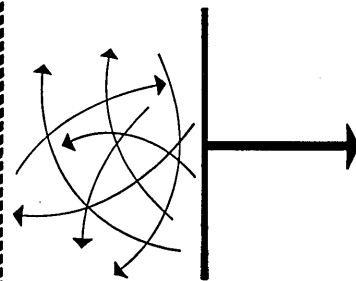

The Federal Aviation Agency has selected MITRE to establish an experimental air traffic control "system test bed." Operations, equipment, and computer program techniques will be designed, implemented, tested, and evaluated in the "system test bed" prior to incorporation in a new national air traffic control system.

Challenging assignments are now available for individuals with demonstrated ability in any of the following areas:

- Operations Research or Operations Analysis related to real time control systems
- Large-scale system design, test, or evaluation
- Computer program design for real time systems

Scientists and engineers are needed immediately for this important job and thereafter for MITRE's expanding role in the design and development of real time computer-based systems.

Recent college graduates with high scholastic achievements and an interest in these fields are also invited to apply. MITRE is located in pleasant suburban Boston.

Write in confidence to Vice President — Technical Operations, The MITRE Corporation, P. O. Box 208, Dept. ME5, Bedford, Mass.

MITRE is an independent, nonprofit corporation working with — not in competition with — industry. Formed under the sponsorship of the Massachusetts Institute of Technology, MITRE is Technical Advisor to the Air Force Electronic Systems Division, and chartered to work for such other Government agencies as FAA.

THE  
**MITRE**  
CORPORATION

An Equal Opportunity Employer

at  
*Remington Rand*

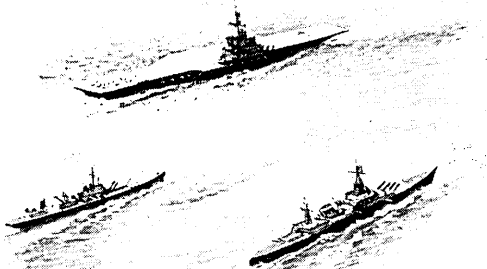
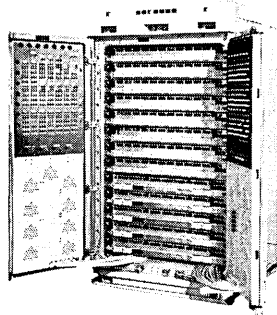

they chose  
**POTTER**  
Tape Transports  
for  
**NTDS**

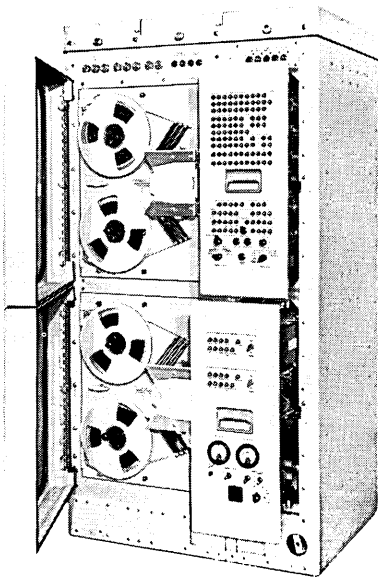

NTDS is a shipboard computer system designed to speed the processing of tactical information. It provides rapid communication of combat data between ships—permitting them to act faster and with greater accuracy in tactical situations.

Potter M906 II Tape Transports were chosen for the NTDS 1206 Military Computer because they provide optimum reliability.

In actual operation, units like these can read or write at the fantastic rate of 360,000 alpha-numeric characters per second at packing densities to 1500 per inch on 1-inch tape... with drop-outs fewer than 1 in 10<sup>8</sup>!

**To learn how Potter Digital Tape Drives can be applied to your computer system, write today for details!**

**POTTER**



INSTRUMENT CO., INC.

PLAINVIEW, NEW YORK

customer. An order point for each item is established each month by the computer to reflect the pace of orders, sales, deliveries, and incoming shipments. The computer signals management when inventory of an item falls below order point.

The firm reports information is now maintained up to the minute, closing up a lag of one month to six weeks which existed when the company used a perpetual inventory control card system and manual computation. In addition, substantial savings are being realized from faster turnover and reduced inventories.

## New Computing Centers

CENTER FOR TRANSLATION OF  
COMPUTER LANGUAGES

A half-million dollar center for the translation of data languages is being built at the Electronic Engineering Company of California, Santa Ana, Calif. The Translation Center will be available to all organizations having computers that must "talk" to each other.

Translation has become necessary in electronic data processing because various computer manufacturer's systems employ data languages which are "foreign" to one another.

The equipment used in the EECO Computer Tape Conversion Service includes a magnetic tape adapter unit, an IBM 1401 computer, and various tape machines required for RCA, Remington Rand, and Burroughs computer systems.

CHICAGO UNIVAC  
SERVICE CENTER EXPANDS

Two Univac solid-state magnetic tape computing systems, with associated peripheral equipment have been installed at the Remington Rand Univac branch offices at 444 N. Michigan Ave., Chicago. The Center will now occupy an entire floor of the building.

The new equipment includes both 80 and 90 column card input as well as magnetic tape. A trained staff of systems analysts and programmers will be available.



# A MESSAGE FROM **tech/ops** TO PROGRAMMING SCIENTISTS ATTENDING THE SPRING JOINT COMPUTER CONFERENCE



We are addressing this message to programming scientists on a project leader level who have been in one phase or another of programming work over the past few years and are now seriously assessing their long-range professional development. We are particularly interested in programming scientists who feel that their assignments have not been broad enough to develop their professional and managerial capabilities to the fullest extent. If this strikes a responsive chord with you, we may have a position of more than casual interest.

Tech/Ops' work in Washington, where our staff numbers almost a hundred, consists of solving through the use of rather advanced computer simulation, operations research and related techniques, somewhat complex problems for a variety of different organizations. Sponsors range from Headquarters, U.S. Air Force, for whom we operate Project Omega (a simulation of a large scale strategic air war battle), to the Federal Aviation Agency (analysis of air traffic control systems). Some of the kinds of problems in a little more detail:

- *Development of programming systems (assemblers, compilers, translators, generators, string handling packages, and the like). We have constructed and are using CL-1 and are now ready to build a more powerful computer language.*
- *Simulation techniques: using high-speed computers to determine the impact of new operational procedures, plans or equipment, when direct experimentation is too costly or otherwise impractical.*
- *Analysis and programming for command control systems; status and employment of resources; routing and scheduling; information storage, retrieval and display; report generation.*
- *Evaluation of large, complex weapons and communications systems, studies of logistic systems to increase operational efficiency.*
- *Mathematical analysis and its application to operational problems; e. g., queueing theory, linear programming, inventory control analysis, equations describing combat operations.*

Scientists who fare best in our environment essentially have the problem-solving approach coupled with a specialty in one or more of the following fields: programming; programming systems; information storage, retrieval and display; simulation models; command control systems and man-machine war games. In addition to programming scientists on a project leader level, appointments are also available for promising programmers of lesser experience.

Contact Mr. Kingsley Andersson at the Mark Hopkins Hotel, May 1st to 3rd

## **TECHNICAL OPERATIONS, INCORPORATED**

3600 M STREET N. W., WASHINGTON 7, D. C.

P.S. While at the Conference, don't forget to pick up from Tech/Ops a free copy of THE GAME of WAR which traces the history of war gaming from ancient chess as played 3,000 years ago through modern computer gaming with authentic illustrations of each period.

*Computape, you never change a bit.*

Penelope, you're exactly right. One can't change a bit if one expects to run around with computers all day. That's why I'm guaranteed to deliver 556 or 800 bits per inch with no dropouts in severest computer applications.

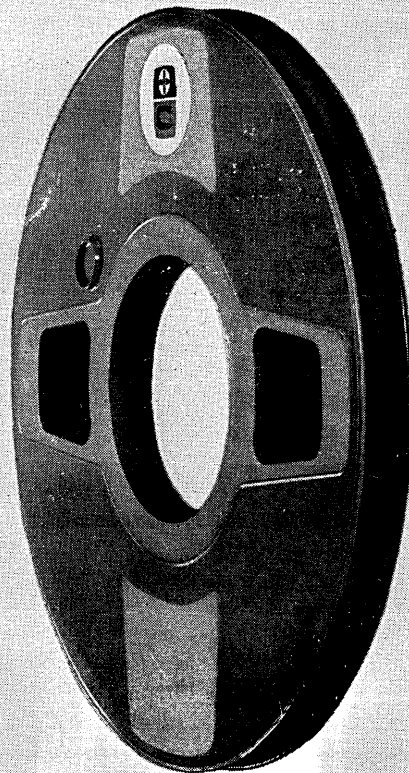

P. S. Computape doesn't really talk, of course. But in a computer, Computape *reliability* will deliver its own message. New COMPUTAPE, the premium quality computer and instrumentation tape, is the product of the only company devoted exclusively to the manufacture of quality tapes for data processing and instrumentation. *Investigate new Computape today. Better still, immediately.*



**COMPUTRON INC.**  
122 Calvary Street, Waltham, Massachusetts