**CONTROL DATA®
3248-A, 3447-A/B/C, 3447-2, 3649-A
CARD READER CONTROLLERS
STANDARD OPTION 10194-2**

REFERENCE MANUAL

PREFACE

This publication contains reference information for CONTROL DATA® 3248-A, 3447-A/B/C, 3447-2, 3649-A Card Reader Controllers and Standard Option 10194-2 which may be used in conjunction with standard Control Data 3000 series data channels. The reader should be familiar with characteristics of the 3000 series data channels. The 3447-A/B/C with Standard Option 10194-2 installed is identical to the 3447-2.

CONTENTS

1. GENERAL DESCRIPTION Functional Description 1-2 System Relationship 1-2 Card Format 1-3 Read Operation 1-4 Suppress Assembly Mode 1-5 Buffer Memory (3649, 3447-A/B/C, and 3447-2 Controllers only) 1-5 Input to A (3649 Controller only) 1-6 Sorting 1-6 Parity 1-6 Interrupt 1-8	2. OPERATION AND PROGRAMMING Programming 2-1 Codes 2-1 Programming Considerations 2-10 Operation 2-13 Switches and Indicators 2-13 Operating Procedure 2-18 APPENDIX A
---	---

FIGURES

1-1 Typical System Configurations 1-1 2-1 Card Cycle Timing (3649, 3447-A/B/C, and 3447-2) 2-11 2-2 Card Cycle Timing (3248) 2-12 2-3 Card Reader Switches and Indicators (Used with 3649 Controller) 2-13 2-4 Card Reader Switches and Indicators (Used with 3447-A/B/C and 3447-2 Controllers) 2-14	2-5 Card Reader Switches and Indicators (Used with 3248 Controller) 2-14 2-6 3447-A/B and 3649 Controller Switches and Indicators 2-16 2-7 3248 Controller Switches and Indicators 2-17
---	---

TABLES

1-1 System Specifications 1-1	2-1 Connect, Function, and Status Codes 2-1
-------------------------------	---



3649 CARD READER CONTROLLER

GENERAL DESCRIPTION

1

This manual describes card reader systems consisting of a CONTROL DATA® 405 Card Reader controlled by either a CONTROL DATA 3248, 3447-A/B/C, with Standard Option 10194-2, 3447-2, or a 3649 Card Reader Controller. The 3447-A/B/C with Standard Option 10194-2 and the 3447-2 permit the 405 Card Reader to read cards in ASCII format. These systems operate with any 3000 series data channel. Figure 1-1 shows typical system configurations. Table 1-1 gives system specifications.

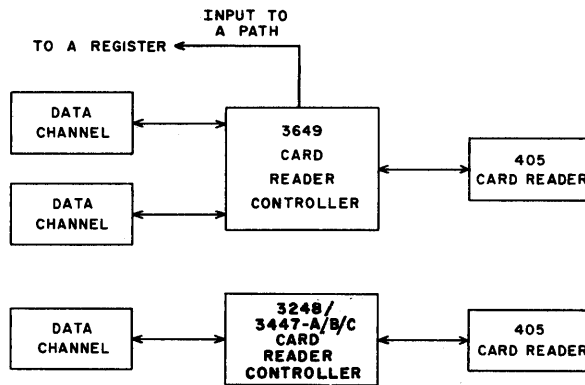

Figure 1-1. Typical System Configurations

TABLE 1-1. SYSTEM SPECIFICATIONS

Reading Rate	1, 200 80-column cards per minute
Input Tray	1, 600 51-column cards per minute
Receiving Trays	4, 000 - card capacity 4, 000-card primary receiving tray 240-card secondary receiving tray
Data Transfer Rate	Buffer memory in the 3447-A/B/C, 3447-2, and 3649 controllers permits high speed transfer to data channel: 390 microseconds per 80-column card

The controllers supplement basic reader logic and are mounted in the 405 reader cabinet.

The four controllers are similar; however, there are four major differences as follows.

1. The 3649 controller is a two-channel device; the 3447-A/B/C, 3447-2, and 3248 controllers are single-channel devices.
2. The 3649 provides an input to A path directly to the A register in the central processor. The 3447-A/B/C, 3447-2, and 3248 do not provide this feature.
3. The 3649, 3447-A/B/C, and 3447-2 provide a buffer memory. The 3248 does not.
4. The 3447-A/B with Standard Option 10194-2 and the 3447-2 installed permits the 405 Card Reader to read cards punched in ASCII Hollerith format and converts them to internal BCD.

This manual presents data formats, the function of the controller, programming information, and operating instructions.

FUNCTIONAL DESCRIPTION

SYSTEM RELATIONSHIP

The 3649, 3447-A/B/C, 3447-2, and 3248 controllers perform control and data conversion functions necessary to operate a 405 Card Reader on a 3000 series data channel.

The 3649 controller contains two connect-reserve controls and can be connected by cables to two data channels. Reserve logic in each controller prevents both data channels from communicating simultaneously with the 3649 controller. An equipment number is assigned to each connect-reserve control.

The 3447-A/B/C, 3447-2, and 3248 controllers are single-channel controllers and are connected by cables to only one data channel. They are assigned a unique equipment number (0 through 7) to distinguish them from other equipments attached to the data channel.

CARD FORMAT

The 405 Card Reader controlled by the 3649, 3447-A/B/C, 3447-2, or 3248 handles either 80- or 51-column, 12-row cards. Punched card format codes (appendix A) describe the card.

The 3649, 3447-A/B/C, 3447-2, and 3248 treat data received from the card reader as being in either standard Hollerith or binary. Also, the 3447-A/B/C with Standard Option 10194-2 and the 3447-2 installed, in addition to accepting data in standard Hollerith or binary, will accept data in ASCII Hollerith format. However, it will not recognize data as being in ASCII Hollerith format unless a select ASCII Hollerith to BCD function code is sent.*

Provided the card is not a binary card (described later), the controller will treat the data as if in standard Hollerith** format:

1. A manual master clear.
2. A clear channel instruction.
3. A clear function code,
4. A release and disconnect function code (3649, 3447-A/B/C, and 3447-2 only).

Thus, the controllers normally convert each 12-bit card code into one 6-bit internal BCD code. Unless in suppress assembly mode (described later), the controller then assembles two 6-bit BCD codes into one 12-bit word and transmits it to the data channel. The code received from an odd-numbered column is placed in the upper 6-bit positions and the code received from an even-numbered column is placed in the lower 6-bit positions. When a 51-column card is read, the lower 6 bits of the last input byte (byte 26) contain all zeroes.

NOTE

The controller does not distinguish between legal (listed) Hollerith codes and illegal ones. It supplies a listed BCD code for each Hollerith code received. This BCD code, however, may not have meaning. There is no alarm or indication that an illegal code has been processed.

*Table A-1 (appendix A) lists the ASCII Hollerith codes and corresponding BCD codes.
**Table A-2 (appendix A) lists the standard Hollerith codes and corresponding BCD codes. Any combination of bits not shown is an illegal Hollerith code.

When issued a negate Hollerith to BCD conversion function code, the 3649, 3447-A/B/C, 3447-2, and 3248 controllers treat data received from the reader as being binary. Also, any card with a punch in rows 7 and 9 of column 1 is a binary card. The 7 and 9 punch overrides any previously selected read mode and forces a binary read of that card only. In binary reading, each 12-bit column is transmitted without translation directly to the data channel. The top row (row 12) is the upper bit of the byte. The bottom row (row 9) corresponds to bit 0.

A card with a punch in rows 7 and 8 of column 1 is a file card. It may be used to indicate the last card in a deck and/or it may be used to send an interrupt signal to the computer (interrupt on abnormal end of operation function code). When reading in negate Hollerith to BCD mode, the 7 and 8 punches are treated as binary data instead of recognizing them as indicating a file card.

When the 3447-A/B/C with either Standard Option 10194-2 or the 3447-2 is issued, a select ASCII Hollerith to BCD function code, the data received will be recognized as being in ASCII Hollerith format. Thus, the data is routed through a matrix translator to perform the additional code conversion necessary to handle the ASCII code set. The controller then assembles the BCD codes and transmits them to the data channel.

READ OPERATION

The card reader system is controlled by the data channel. Card motion begins when the data channel requests data in response to a read (input) instruction. A card is then read on a column-by-column basis beginning with column 1. When the data channel terminates the read operation, card motion stops as soon as the last card read is in the receiving tray. If a read operation terminates when only a portion of a card has been read, this card continues through the read station and data on the unread portion of the card is lost. The next read operation reads the next card.

Each card is a record of data. After each card is read, the controller sends an end of record signal to the data channel. This signal in some cases, causes the data channel to terminate the read operation.*

*In 3100/3200/3300/3500 systems, the end of record signal always terminates a read operation. In 3400 and 3800 systems, this use is optional.

SUPPRESS ASSEMBLY MODE*

The controller automatically enters suppress assembly mode in response to either of the following 6-bit input instructions.

1. Character addressed input to storage (INPC) in which H (bit 18) = 0.
2. Input, character to A (INAC).

When this mode is in effect the controller does not pack two BCD codes into each byte. Instead, it places each BCD code into the lower 6 bits of a separate 12-bit byte. The upper 6 bits of each byte contain all zeroes.

The 6-bit input is not permitted if the negate Hollerith to BCD mode is in effect or if a binary card is read. In either of these cases, the controller generates an interrupt signal if interrupt on abnormal end of operation has been selected.

BUFFER MEMORY (3649, 3447-A/B/C, AND 3447-2 CONTROLLERS ONLY)

The 3649, 3447-A/B/C, and 3447-2 controllers contain a buffer memory that holds one card image of 80 12-bit words. The reader enters data from each card into memory at a relatively slow rate (50 milliseconds per 80-column card). After a complete card has been entered, the data channel can read the information from memory at a rapid rate (maximum rate: 390 microseconds per 80-column card). The reader automatically enters another card into memory after the data channel has read out the first card. During the 50-millisecond period required to reload the buffer memory, the data channel can be used to service some other device.

Card motion stops if the data channel does not unload the buffer memory within 1.5 milliseconds after the buffer is loaded.

If a read operation unloads only a portion of memory and then terminates, the next card immediately enters memory.

*Applicable in 3100/3200/3300/3500 systems only.

INPUT TO A (3649 CONTROLLER ONLY)*

The card mode switch on the computer console selects the reader for input to A. During input to A operations, the 3649 controller transmits 12-bit bytes to the A register in the central processor via a direct path. A data channel is not used. Each time the computer executes an input to A instruction, the controller sends one 12-bit byte to lower 12 bits of the A register. A 12-bit byte consists of one card column in binary form. There is no Hollerith to BCD conversion.

As long as the reader remains selected for input to A, a new card enters into the buffer memory only after the previous card has been completely read by the computer. However, if the reader is deselected when a card is only partly read, a new card immediately enters the buffer memory.

Input to A operations cannot proceed if the controller is connected to or reserved by a data channel. In this case, the controller does not respond to an input to A instruction, and the program stops.

SORTING

A special function code (set gate card) permits a limited sorting operation. As cards are read, they normally flow to the primary stacker. Each time the set gate card code is received, the reader diverts the current card to the secondary stacker.

PARITY

Connect codes, function codes, and data are transmitted between the data channel and the controller in odd parity (for example, the number of 1 bits transmitted must be odd). If the number of 1 bits in a data byte is even, a 1 is transmitted on the parity line to make the total number of 1 bits odd. ** If the number of 1 bits in the data byte is odd, a 0 is transmitted on the parity line.

*Only the 3600/3800 systems have a direct input to A path.
**Do not confuse this line with the parity error line.

Parity is checked when information is transmitted on the 12 data lines and the parity line. If the total number of 1 bits on these 13 lines is even, a transmission parity error has occurred indicating that a bit has been lost or picked up.

PARITY ERROR IN A CONNECT CODE

If a parity error is detected in a connect code, the device does not connect* and neither a reject nor a reply is returned to the data channel. Instead, the parity error indicator lights. These parity error conditions must be cleared by either a clear channel instruction or a manual master clear prior to a new connect attempt.

PARITY ERROR IN A FUNCTION CODE

If a parity error is detected, the requested functions are not performed, a parity error signal is returned to the data channel, and the parity error indicator lights. Since neither a reject nor a reply is returned to the data channel, the data channel generates an internal reject after a delay of 100 microseconds. These parity error indicators must be cleared by a clear channel instruction or a manual master clear.** The equipment must then be reconnected before a new function code can be examined by the controller.

PARITY ERROR IN INPUT DATA

Transmission parity errors may be detected by the data channel on data received from the equipment during a read operation. If a parity error is detected, a parity error signal is returned to the data channel and a parity error indicator on either the channel or console is lighted. (The faulty data is entered into either core storage or the A register.)

*If the device is connected, it automatically disconnects.

** Though operations may continue normally, the validity of a new function and/or data prior to a master clear or clear channel is questionable.

INTERRUPT

An interrupt feature enables the card reader system to notify the processor when it can start an operation, when it has completed an operation, or when an abnormal condition makes further operation impossible. Thus, the main program can proceed with minimum regard for card reading operations. The reader notifies the central processor when it requires service.

The desired interrupts are selected by function codes. When one of the selected interrupt conditions occurs, the controller sends an interrupt signal via the data channel to the central processor. If the interrupt system in the central processor is set to recognize an input/output interrupt signal, the main program halts. Usually, the processor executes a short program to service the card reader and then resumes the main program.

If the processor's interrupt system has not been enabled, it is still possible to sense for these conditions via sense status and copy status instructions written into the main program.

Regardless of which of the above actions is followed, the interrupt signal remains on the line until cleared by reselection of the interrupt condition (function code), release of the interrupt condition (function code), selection of the release and disconnect function code*, a clear channel instruction, or a manual master clear. All except reselecting the interrupt will also clear the interrupt selection.

The card reader system transmits the interrupt signal to the data channel on one of eight interrupt lines. The setting of the 8-position equipment number switch on the controller determines which line is used. For example, if the switch is set to 4, the interrupt signal goes out on line 4. A channel product register jump instruction** or copy status instruction*** can identify which of several equipments attached to a data channel sends an interrupt by inspecting the eight interrupt lines.

Refer to the appropriate system reference manual for interrupt processing details.

*3447-A/B/C, 3447-2, and 3649 only.

**3600/3800 systems.

***3100/3200/3300/3400 systems.

PROGRAMMING

CODES

All connections and operations are controlled by 12-bit connect and function codes in conjunction with an appropriate connect or function instruction. When the connect or the function is executed, a reply signal is returned to the computer. This signal allows the computer to read the next programmed instruction. If the connect or the function cannot be executed immediately, a reject signal is returned to the computer. This signal instructs the computer to read the next instruction at the reject jump address specified by the instruction currently being executed.

Table 2-1 lists all the codes applicable to the 3649, 3447-A/B/C, 3447-2, and 3248 controllers. A detailed description of each code follows the table.

TABLE 2-1. CONNECT, FUNCTION, AND STATUS CODES

Connect	
Connect Reader	N000*
Function	
Release and Disconnect (3447-A/B/C, 3447-2, and 3649 only)	0000
Negate Hollerith to Internal BCD Conversion	0001
Release and Negate Hollerith to Internal BCD Conversion (3649, 3447-A/B/C, 3447-2, and 3248 only)	0002
Select Standard Hollerith**	0002
Set Gate Card	0004
Clear	0005
Select Interrupt on Ready and Not Busy	0020
Release Interrupt on Ready and Not Busy	0021

*N = equipment number of controller

**Applicable to 3447-A/B/C with Standard Option 10194-2 and the 3447-2.

TABLE 2-1. CONNECT, FUNCTION, AND STATUS CODES (Cont'd)

Function (Cont'd)	
Select Interrupt on End of Operation	0022
Release Interrupt on End of Operation	0023
Select Interrupt on Abnormal End of Operation	0024
Release Interrupt on Abnormal End of Operation	0025
Ready Clear (Not applicable to 3248)	0026
Select ASCII Hollerith to BCD*	0042
Status	
Ready	XXX1
Busy	XXX2
Binary Card	XXX4
File Card	XX1X
Fail to Feed or Stacker Full or Jam	XX2X
Input Tray Empty	XX4X
End of File	X1XX
Interrupt on Ready and Not Busy	X2XX
Interrupt on End of Operation	X4XX
Interrupt on Abnormal End of Operation	1XXX
Read Compare or Preread Error**	2XXX
Reserved (by other channel) (3649 only)	4XXX

CONNECT CODE

The card reader system must be connected to a data channel before it responds to a function code or an input operation.

CONNECT READER (N000)

This code is the lower 12 bits of the connect instruction. The N portion of the code specifies the controller equipment number.

Each controller examines every connect code received from its attached data channel. The controller connects and returns a reply signal to the data channel if a transmission parity error is not detected and the N portion of the connect code matches the setting of its equipment number switch.

*Applicable to 3447-A/B/C with Standard Option 10194-2 and the 3447-2.

**Column count error in 3447 and 3649.

The controller does not connect and neither a reply nor a reject signal is returned to the data channel from the controller if either a parity error is detected in the connect code or the N portion of the code does not match the equipment setting of the controller.

In either case, if already connected, the controller will disconnect. If no other equipment returns a reply signal, the channel generates an internal reject after 100 microseconds. This reject acts the same as one from a peripheral equipment.

The 3649 controller contains a channel reservation feature that prevents interference between the two data channels. When the 3649 controller connects, a reservation is established for the connecting data channel. This reservation remains in effect even if the data channel disconnects the 3649 controller by connecting another device. A reservation can be cleared only by a master clear, clear channel instruction, or release and disconnect function code (0000) sent from the reserving channel.

If a data channel attempts to connect the 3649 controller while it is reserved by the other data channel, the 3649 controller generates a reject signal. This signal causes the central processor to jump to the reject jump address contained in the connect instruction. Even though a connect operation results in a reject, the 3649 controller enables status information to the rejected data channel so that the reason for the reject can be determined.

FUNCTION CODES

Function codes set up or clear various operating conditions in the reader system. Table 2-1 lists all the function codes applicable to the 3649, 3447-A/B/C, 3447-2, and 3248 controllers. All codes not listed are do-nothing codes. The controller returns a reply in response to such codes but no action follows.

A function code is the lower 12 bits of a function instruction. When the central processor executes a function instruction, the selected data channel sends the function code to all attached devices but only the connected device responds.

The 3447-A/B/C and 3447-2 controllers respond to all function codes by returning a reply signal. The 3649 and 3248 controllers cannot accept certain function codes when busy. If a 3649 or 3248 accepts a code, it returns a reply signal. If the 3649 or 3248

cannot accept a code because it is busy when the code arrives, it returns a reject signal to the data channel. If for any reason a controller fails to return either a reply or a reject, the channel generates an internal reject after 100 microseconds.

RELEASE AND DISCONNECT (0000)

This code disconnects the controller and clears the channel reservation. All interrupt selections and the negate BCD to Hollerith selection are cleared. When busy, the 3649 controller rejects this code. The 3447-A/B/C and 3447-2 controllers accept this code at any time. This code does not apply to the 3248.

NEGATE HOLLERITH TO INTERNAL BCD CONVERSION (0001)

This code eliminates the standard Hollerith to BCD conversion and the ASCII Hollerith to BCD conversion (Standard Option 10194-2 and 3447-2 only) so that all cards are treated as binary.

RELEASE NEGATE HOLLERITH TO INTERNAL BCD CONVERSION (0002)

SELECT STANDARD HOLLERITH (0002)*

When the controller is in binary mode (all controllers) or ASCII Hollerith to BCD mode (Standard Option 10194-2 and 3447-2 only), code 0002 will return the controller to the standard Hollerith to BCD mode.

SET GATE CARD (0004)

The set gate card code allows the reader to do a limited card sorting operation. The selected cards are directed to the secondary stacker. The code must be given for each card that is to be gated and must arrive within 1.5 milliseconds after the last column of the selected card has been read.

*Applicable to 3447-A/B/C with Standard Option 10194-2 and the 3447-2.

CLEAR (0005)

The clear code clears any interrupt selection, interrupt signal, or negate condition. It does not release a reservation or connection.

SELECT INTERRUPT ON READY AND NOT BUSY (0020)

The select interrupt on ready and not busy code conditions the 3447-A/B/C, 3447-2, or 3649 to send an interrupt signal whenever data is available in the buffer memory for input and the data channel has not initiated a read operation. It conditions the 3248 to send an interrupt signal when it is idle and ready to begin an operation. The 3248 is ready as long as cards are in the input tray, the primary and secondary stackers are not full, and no abnormal conditions exist. The reader becomes not busy after a card is read if the data channel terminates the read operation.

RELEASE INTERRUPT ON READY AND NOT BUSY (0021)

The release interrupt on ready and not busy code inhibits interrupt on ready and not busy. It also clears the interrupt signal when caused by the ready and not busy condition.

SELECT INTERRUPT ON END OF OPERATION (0022)

The select interrupt on end of operation code conditions the reader system to send an interrupt signal whenever the data channel terminates a read operation and the reader system becomes not ready.

RELEASE INTERRUPT ON END OF OPERATION (0023)

The release interrupt on end of operation code inhibits interrupt on end of operation. It also clears the interrupt signal when caused by an end of operation.

SELECT INTERRUPT ON ABNORMAL END OF OPERATION (0024)

The select interrupt on abnormal end of operation code conditions the reader system to send an interrupt signal when one of the following conditions occurs.

1. Stacker full or jammed.
2. Input tray empty.
3. Feed failure.
4. Illegal suppress assembly (6-bit input) operation.
5. Compare or preread error (malfunctions).
6. The AUTO/MAN switch is changed to the MAN position.
7. A file card (punches in rows 7 and 8 in column 1) is read.

Any of the first six conditions disable the device and cause the reader to become not ready. Thus, if interrupt on end of operation has been selected it may occur along with interrupt on abnormal end of operation. These conditions must be corrected before read operations can resume.

RELEASE INTERRUPT ON ABNORMAL END OF OPERATION (0025)

This code inhibits interrupt on abnormal end of operation. It also clears the interrupt signal when caused by an abnormal condition.

READY CLEAR (0026) - NOT APPLICABLE TO 3248

This code clears the ready condition in the reader. It will prevent any new reads from occurring. If a read is requested, the controller will not return a reply and will send a busy status to the I/O channel. No data transfer or card motion will take place. It turns off the card reader ready status light and causes the ready status bit to be a 0. The ready and not busy interrupt will remain disabled until the reload memory button on the reader is pressed. Pressing the switch also does the following.

1. Turns on the ready status light and the ready status bit will change to 1.
2. Enables the interrupt on ready and not busy.
3. Returns the reader to normal operation readiness.

The controller accepts this code at all times.

SELECT ASCII HOLLERITH TO BCD (0042)*

Function code 0042 permits the 3447-A/B with Standard Option 10194-2 and the 3447-2 to convert ASCII Hollerith punch codes BCD.** This code is acceptable at all times.

STATUS CODES

Various operating conditions of the reader system are indicated to the data channel on the 12 status lines. Each line is one bit of a 12-bit quantity. The information is available to the channel during the entire time the reader is connected and can be sensed by the copy and sense status instructions. If two or more conditions exist simultaneously, the status response code is the sum of the individual codes. Table 2-1 lists the status conditions.

Three of the status lines indicate the three conditions that can cause the controller to send an interrupt signal. Thus, the status feature can be used to identify the condition causing the interrupt.

READY (XXX1) - BIT 0

The 3447-A/B/C, 3447-2, and 3649 reader systems become ready when the first card has been loaded into memory and remain ready throughout read operations. The 3248 reader system becomes ready when it is prepared to read cards under program control (that is, the input tray contains cards, the stacker is not full, and the AUTO/MAN switch is in the AUTO position). Any of the following conditions cause the 3248, 3447-A/B/C, 3447-2, or 3649 to become not ready (status bit becomes 0).

1. Stacker full or jammed.
2. Input tray empty.
3. Illegal suppress assembly (6-bit input) operation.
4. Compare or preread error.
5. The AUTO/MAN switch is changed to the MAN position.

*Applicable to 3447-A/B/C with Standard Option 10194-2 and 3447-2.

**Table A-1 (appendix A) lists the ASCII Hollerith punch codes and corresponding BCD codes.

6. Feed failure.
7. Function code XX26 (ready clear).

These conditions also cause interrupt on end of operation and interrupt on abnormal end of operation if selected.

BUSY (XXX2) - BIT 1

The 3447-A/B/C, 3447-2, and 3649 reader systems are busy whenever a card is being entered into buffer memory, or the data channel is reading data from the buffer memory, and when a read is requested after being issued a ready clear function code (0026).

The 3248 reader system is busy whenever a card is passing through the read station or the data channel is reading data from the reader system.

BINARY (XXX4) - BIT 2

The presence of punches in rows 7 and 9 in column 1 on a card flags a binary card. The read station senses information in this column when reading the card. For the 3347-A/B/C, 3447-2, and 3649, status bit 2 is present after memory is unloaded and the binary card is read. For the 3248 this status bit becomes a 1 when column 1 is read and remains up until 1 millisecond before the next card is read. The negate Hollerith to BCD conversion function code also sets this bit.

FILE CARD (XX1X) - BIT 3

This condition exists when a card containing a punch in rows 7 and 8 of column 1 of a Hollerith card is detected. This code is not generated when the negate Hollerith to BCD mode is in effect. The file card status bit is cleared by negate Hollerith to internal BCD conversion (function code 0001), clear (function code 0005), or re-initiating a read operation. The controller also generates an abnormal end of operation interrupt after reading a file card if this interrupt condition has been selected.

FAIL TO FEED OR STACKER FULL OR JAM (XX2X) - BIT 4

This status condition is an abnormal condition and is self-explanatory.

INPUT TRAY EMPTY (XX4X) - BIT 5

This status condition is an abnormal condition and is self-explanatory.

END OF FILE (X1XX) - BIT 6

This status bit becomes 1 when the input tray is empty (and buffer memory unloaded for 3649, 3447-A/B/C, and 3447-2) if the END OF FILE switch is on. When the input tray does not contain the last card of a file, the switch should be off to inhibit this status bit.

INTERRUPT ON READY AND NOT BUSY (X2XX) - BIT 7

This bit indicates that interrupt on ready and not busy was selected and that this condition now exists.

INTERRUPT ON END OF OPERATION (X4XX) - BIT 8

This bit indicates that interrupt on end of operation was selected and that this condition now exists.

INTERRUPT ON ABNORMAL END OF OPERATION (1XXX) - BIT 9

This bit indicates that interrupt on abnormal end of operation was selected and that one of the abnormal conditions now exists.

READ COMPARE, PREREAD, OR COLUMN COUNT ERROR (2XXX) - BIT 10

Bit 10 indicates that either a comparison error was detected during the transfer of card information to memory or a read amplifier was not functioning properly prior to reading the information from the card to memory. This bit may indicate that an incorrect column count occurred at END OF CARD signal in the 3447 and 3649.

RESERVED (BY OTHER CHANNEL) (4XXX) - BIT 11

This code indicates that the reader is reserved by the other channel (3649 controller only).

PROGRAMMING CONSIDERATIONS

PROGRAMMING PROCEDURES

A typical order of steps in programming the reader system is as follows.

1. Clear (by external master clear or clear channel instruction).
2. Connect.
3. Function (select interrupts and operating mode).
4. Initiate read operation.
5. Copy status when end of operation interrupt occurs to determine reason for end of operation.

CARD CYCLE TIMING FOR 3649,3447-A/B/C, AND 3447-2

Figure 2-1 shows the timing for one card cycle with the 3649, 3447-A/B/C, or 3447-2. The data channel must be connected to the reader system only while the contents of the buffer memory is read in. As soon as the data channel has unloaded buffer memory, the reader automatically enters the next card into memory. During the advance and load periods, the channel can disconnect from the reader system to service some other device.

After a card has been entered into memory, the data channel must complete reading in this data within 1.5 milliseconds or card motion stops. Unloading the memory requires a minimum of 384 microseconds for 80-column cards and 245 microseconds for 51-column cards.

When a card has been loaded into memory, the reader system becomes not busy if the data channel does not begin a read operation. In this case, the controller generates an interrupt if interrupt on ready and not busy has been selected.

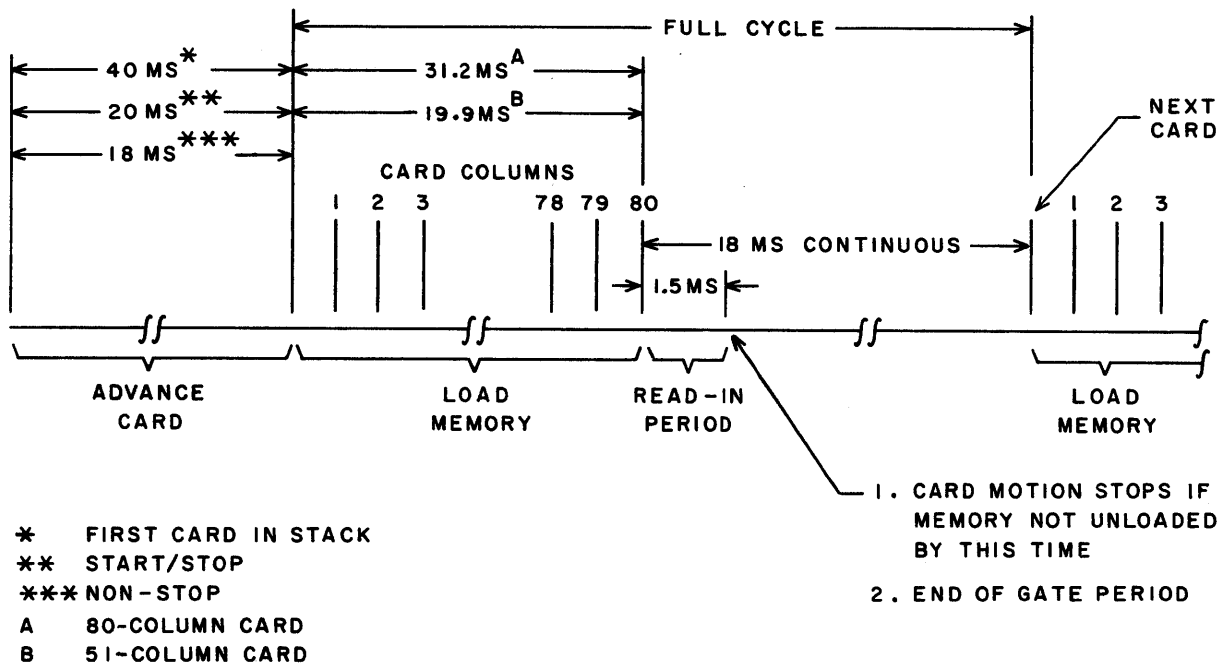

Figure 2-1. Card Cycle Timing (3649, 3447-A/B/C, and 3447-2)

The two 3100 and 3200 input to A instructions INAC (input character to A) and INAW (input word to A) have limited use for the 3447-A/B/C, 3447-2, and 3649 controllers. These instructions transfer a single byte or character to the A register via a data channel and thus constitute a single-byte read operation. The reader system loads a new card into memory each time a read operation terminates. Therefore, the above instructions read only the first one or two columns on a card. A new card is entered into memory after one of these instructions is executed.

CARD CYCLE TIMING FOR 3248

Figure 2-2 shows timing for one card cycle. The diagram shows that after a card is read, a period of 1.5 milliseconds is available in which the data channel can be used to service another device. However, if the program does not initiate a new input operation from the reader by the end of this period, card motion stops.

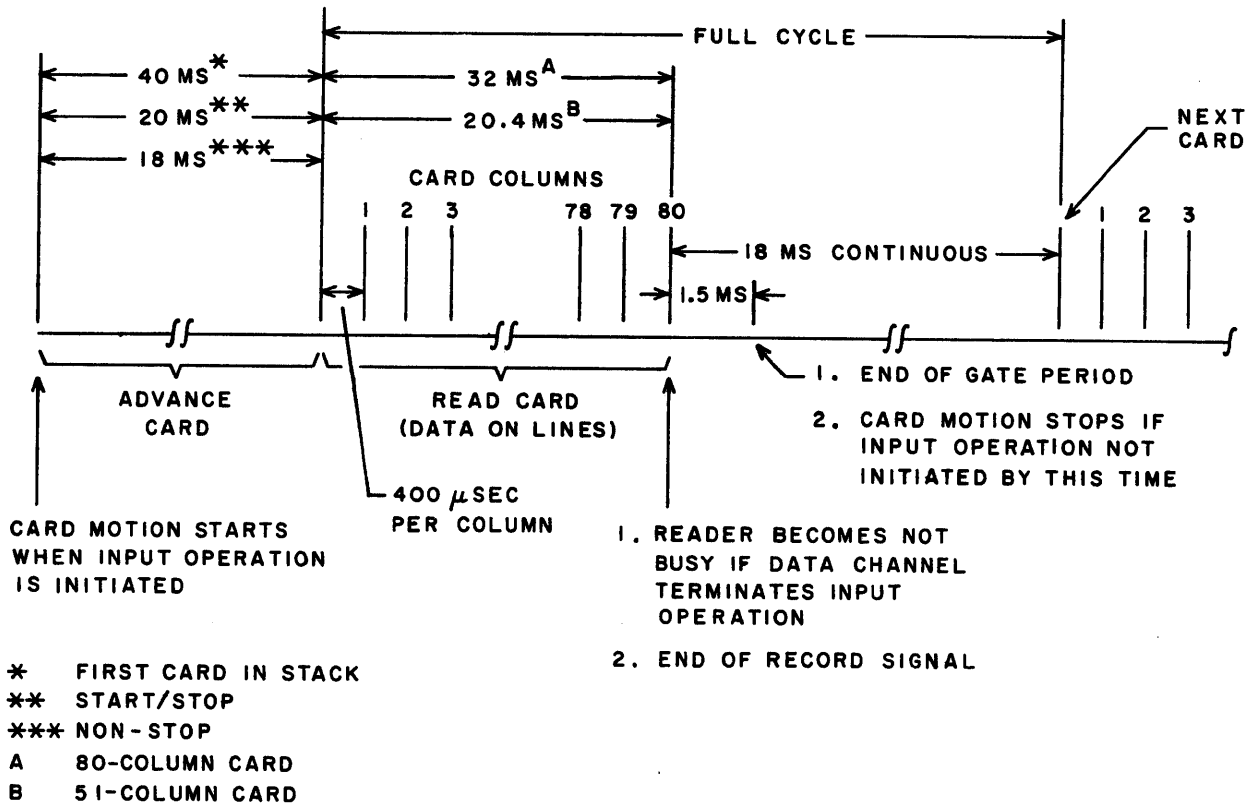

Figure 2-2. Card Cycle Timing (3248)

The diagram also indicates when the reader system becomes not busy and when it sends an end of record signal to the data channel.

The input word to A instruction (INAW)* transfers a single 12-byte from an external device to the A register. A series of these instructions can be used to read cards. The timing diagram shows the rate at which INAW instructions must be executed to read in each card column. If Hollerith cards are read, an input is required for each two card columns or every 800 microseconds. When binary cards are read, an input is required for each card column or every 400 microseconds.

The input character to A instruction (INAC)* transfers a single 6-bit byte from an external device to the A register. A series of these instructions can also be used to read cards. An input is required for each card column or every 400 microseconds. Only Hollerith cards may be used (suppress assembly mode).

OPERATION

SWITCHES AND INDICATORS

SWITCHES AND INDICATORS ON 405 CARD READERS

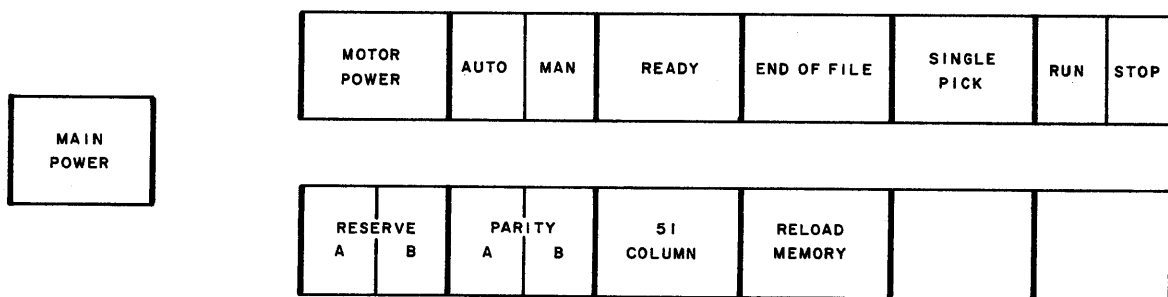

Figure 2-3. Card Reader Switches and Indicators (Used with 3649 Controller)

*3100/3200/3300 systems only.

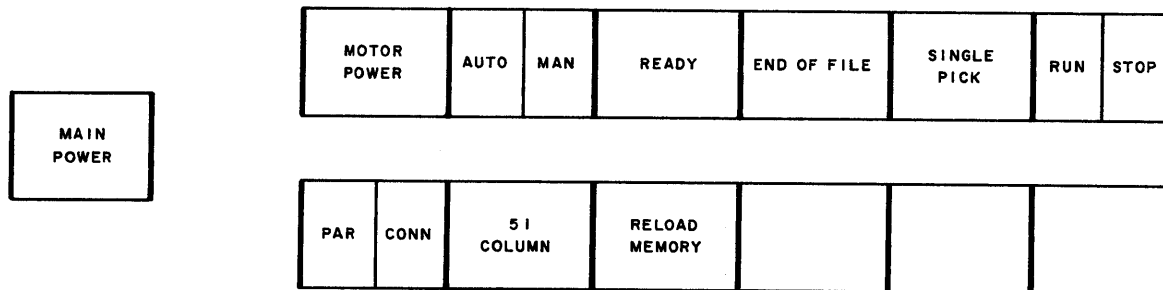

Figure 2-4. Card Reader Switches and Indicators
(Used with 3447-A/B/C and 3447-2 Controllers)

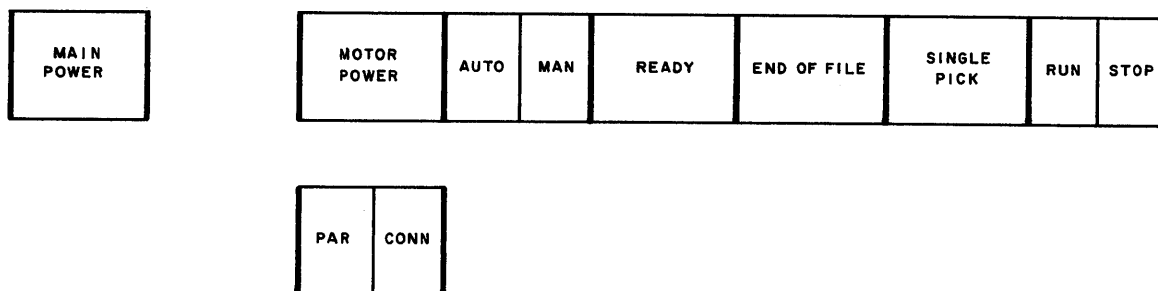

Figure 2-5. Card Reader Switches and Indicators (Used with 3248 Controller)

MAIN POWER SWITCH/INDICATOR

MAIN POWER controls all primary power and turns on the photocell light source. It is lighted when power is ON.

MOTOR POWER SWITCH/INDICATOR

The MOTOR POWER switch controls power to the drive motors, the vacuum-pressure system, and the hopper-stacker vibrators. It is lighted when power is ON.

AUTO/MAN SWITCH/INDICATOR

This 2-position switch selects manual or program-controlled modes of operation. Changing switch position to MAN drops the ready status bit. The switch must be in the AUTO position when the reader system is used for computer input operations.

READY SWITCH/INDICATOR

The READY switch makes the reader READY if input tray is not empty, no error conditions exist in the unit, and primary and secondary stackers are not full.

The switch lights to indicate the ready condition. When the switch is pressed the first card is read into buffer memory for the 3649, 3447-A/B/C, and 3447-2. Thereafter, the reader system is under program control.

END OF FILE SWITCH/INDICATOR

Pressing the END OF FILE switch enables the reader system to generate an end of file status bit after the last card in the input tray is read. It is lighted when selected.

SINGLE PICK SWITCH

The SINGLE PICK switch allows a single card to be cycled through the reader when the AUTO/MAN switch is in the MAN position. It does not light.

RUN/STOP SWITCH/INDICATOR

The RUN/STOP switch allows manual control of card feed when the AUTO/MAN switch is in the MAN position. The selected side is lighted.

RESERVE A/B INDICATOR (3649 only)

The RESERVE A/B indicator lights if either of the associated data channels is reserving the read station. The side corresponding to the reserving channel is lighted.

PARITY A/B INDICATOR (3649 only)

The PARITY A/B indicator indicates the channel on which a parity error occurred during the transmission of a connect or function code.

PAR/CONN INDICATOR (3447-A/B/C, 3447-2, and 3248 only)

If the PAR side is lighted, it indicates a transmission parity error has occurred in a connect or function code. If the CONN side is lighted, it indicates that the reader system is connected to the data channel.

51 COLUMN SWITCH/INDICATOR (3447-A/B/C, 3447-2, and 3649 only)

Pressing the 51 COLUMN switch allows reading short (51-column) cards. It is lighted when set for 51-column card reading.

RELOAD MEMORY SWITCH (3447-A/B/C, 3447-2, and 3649)

Pressing the RELOAD MEMORY switch feeds data from a new card into memory when the AUTO/MAN switch is in the AUTO position. After a ready clear function code is issued, pressing the switch returns the controller to normal operation readiness. It does not light.

SWITCHES AND INDICATORS ON THE CONTROLLER

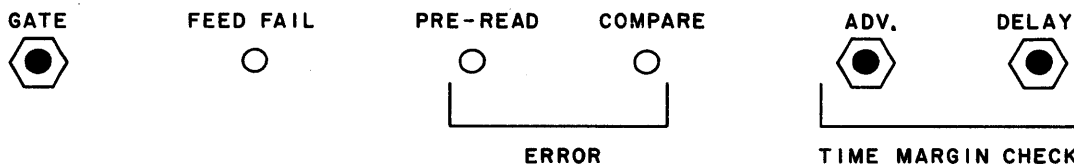

Figure 2-6. 3447-A/B/C, 3447-2, and 3649 Controller Switches and Indicators

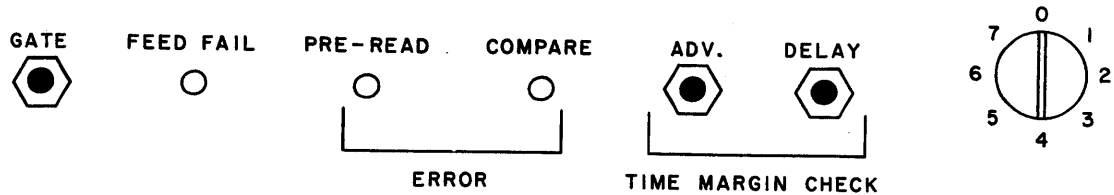

Figure 2-7. 3248 Controller Switches and Indicators

EQUIPMENT NUMBER SWITCH

This 8-position switch (0 through 7) determines the equipment number (corresponds to the upper three bits of connect code) of the reader. It also determines on which one of the eight interrupt lines the interrupt signal is sent. This switch is located on the logic panel which is mounted on the back side of the 405 Card Reader cabinet for the 3447-A/B/C, 3447-2, and 3649. The 3649 controller has two equipment number switches, one for each connect reserve control.

GATE SWITCH

This switch is for use by maintenance personnel only.

NOTE

If a card enters the read station prior to a feed command the FEED FAIL and PRE-READ indicators will light simultaneously.

FEED FAIL INDICATOR

This indicator indicates a feed failure.

PRE-READ ERROR INDICATOR

This indicator indicates an error in photocell logic. If the cards have not been mutilated, call maintenance personnel for a read circuitry checkout. In the 3447 or 3649, this error indicates an incorrect column count at END OF CARD signal.

COMPARE ERROR INDICATOR

This indicator indicates that the read and checkout stations each gave a different hole count. Reread the card.

TIME MARGIN CHECK SWITCHES

These two switches are for use by maintenance personnel only.

OPERATING PROCEDURES

The following steps are necessary to prepare the reader system for use.

1. Turn equipment number switch to desired position.
2. Place cards in input tray (refer to section Z for card load procedure).
3. Press MAIN POWER switch ON.
4. Press MOTOR POWER switch ON.
5. Press AUTO/MAN switch to AUTO.
6. Press END OF FILE switch OFF unless the hopper load is a complete file.
7. Press READY switch*.
8. Issue master clear from the computer.
9. The READY switch should be lighted, indicating the controller is now ready.



Cards may not be removed from the secondary stacker while the card reader is operating. With care, cards may be added to the input tray or removed from the primary stacker during operation.

*For 3447-A/B/C, 3447-2, and 3649, one card feeds through reader to initially load buffer memory.

SUPPLEMENTARY CARD EQUIPMENT INFORMATION A

This section contains information common to several of the card handling equipments as follows.

1. BCD/standard Hollerith and BCD/ASCII Hollerith codes
2. Card format
3. Control Data 405 Card Reader loading procedure
4. Control Data 3142 Card Reader card handling and loading information
5. Control Data 415 Punch switches and indicators
6. IBM 523 Punch switches and indicators

PUNCHED CARD FORMAT AND CODES

A punched card contains either 51 or 80 12-bit columns arranged as in Figure A-1. A punch in any bit position is a 1. Cards may be either Hollerith or binary format. In Hollerith format, each column contains a combination of punches that specifies one alphanumeric character. Table A-1 lists the Hollerith codes. In binary format, each card column is a 12-bit binary quantity.

TABLE A-1. BCD/ASCII HOLLERITH CARD CODES

Internal BCD Code	ASCII Char	ASCII Hollerith Code	Internal BCD Code	ASCII Char	ASCII Hollerith Code
00	0	0	40	-	11
01	1	1	41	J	11-1
02	2	2	42	K	11-2
03	3	3	43	L	11-3
04	4	4	44	M	11-4
05	5	5	45	N	11-5
06	6	6	46	O	11-6
07	7	7	47	P	11-7
10	8	8	50	Q	11-8
11	9	9	51	R	11-9
12	:	8-2	52	Y	11-0
13	=	8-6	53	\$	11-8-3
14	"	8-7	54	*	11-8-4
15	<	12-8-4	55	@	8-4
16	%	0-8-4	56	?	0-8-7
17	'	8-5	57	>	0-8-6
20	+	12-8-6	60	SPACE	NO PUNCH
21	A	12-1	61	/	0-1
22	B	12-2	62	S	0-2
23	C	12-3	63	T	0-3
24	D	12-4	64	U	0-4
25	E	12-5	65	V	0-5
26	F	12-6	66	W	0-6
27	G	12-7	67	X	0-7
30	H	12-8	70	Y	0-8
31	I	12-9	71	Z	0-9
32	{	12-0	72	!	12-8-7
33	.	12-8-3	73	,	0-8-3
34)	11-8-5	74	(12-8-5
35	\	0-8-2	75	_	0-8-5
36	^	11-8-7	76	#	8-3
37	;	11-8-6	77	&	12

TABLE A-2. BCD/STANDARD HOLLERITH CARD CODES

Internal BCD Code	Char	Hollerith Code	Internal BCD Code	Char	Hollerith Code
00	0	0	40	(minus) -	11
01	1	1	41	J	11, 1
02	2	2	42	K	11, 2
03	3	3	43	L	11, 3
04	4	4	44	M	11, 4
05	5	5	45	N	11, 5
06	6	6	46	O	11, 6
07	7	7	47	P	11, 7
10	8	8	50	Q	11, 8
11	9	9	51	R	11, 9
12		8, 2	52	-0	11, 0
13	=	8, 3	53	\$	11, 8, 3
14	(dash) -	8, 4	54	*	11, 8, 4
15		8, 5	55		11, 8, 5
16		8, 6	56		11, 8, 6
17		8, 7	57		11, 8, 7
20	+	12	60	(Space)	Blank
21	A	12, 1	61	/	0, 1
22	B	12, 2	62	S	0, 2
23	C	12, 3	63	T	0, 3
24	D	12, 4	64	U	0, 4
25	E	12, 5	65	V	0, 5
26	F	12, 6	66	W	0, 6
27	G	12, 7	67	X	0, 7
30	H	12, 8	70	Y	0, 8
31	I	12, 9	71	Z	0, 9
32	+0	12, 0	72		0, 8, 2
33	.	12, 8, 3	73	,	0, 8, 3
34)	12, 8, 4	74	(0, 8, 4
35		12, 8, 5	75		0, 8, 5
36		12, 8, 6	76		0, 8, 6
37		12, 8, 7	77		0, 8, 7

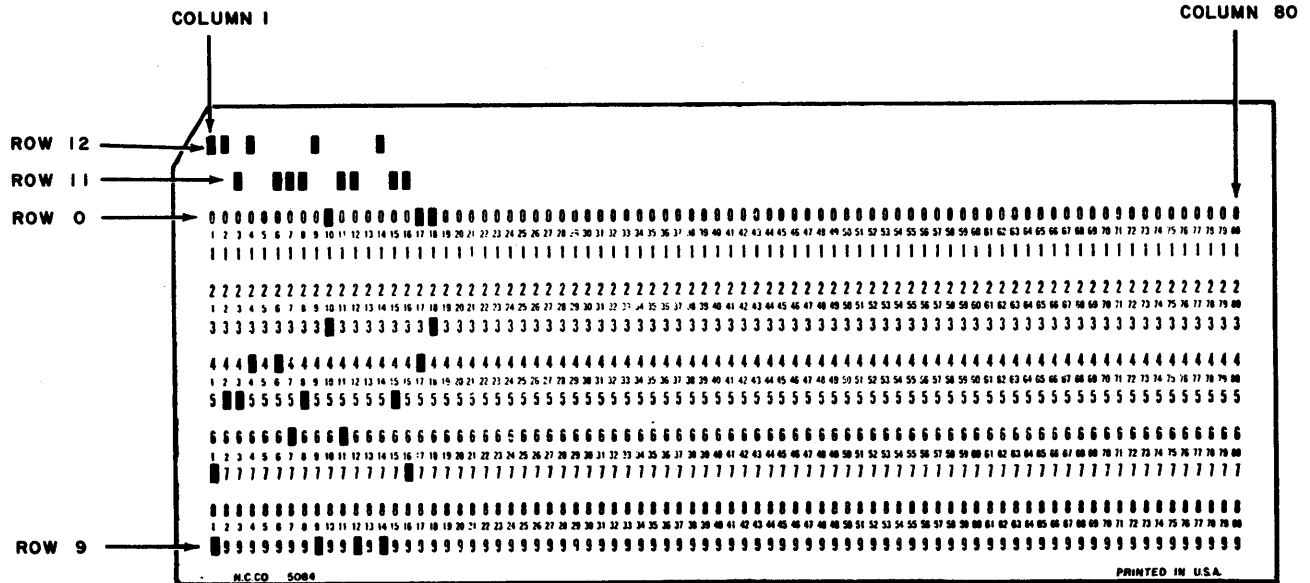

Figure A-1. Punched Card Format

405 CARD READER LOADING PROCEDURES

1. Set guide edge of supply tray and receiving tray for length of card being used. Narrow half of each tray may be removed, turned end-for-end and re-assembled as necessary.
2. Load cards into supply tray, placing column 1 at right as cards face entrance of read station.
3. Check input wall of secondary and main receiving trays if 80-column (long) cards are used. Hinged card-stopping blocks should be positioned so that a flush surface is formed at each input wall (Figure A-2). The hinged block assemblies must be pivoted to protrude from the wall surfaces of each receiving tray if 51-column (short) cards are to be used (Figure A-3).
4. At input tray, set card-stopping pin to protrude from the face plate if short cards are to be used. Turn pin clockwise to form flush wall if long cards are being used (Figures A-2 and A-3).
5. Place equipment in manual mode of operation by pressing AUTO/MAN switch (MAN indicator ON).

6. STOP indicator (controller panel) should be on. If not, press RUN/STOP switch (controller panel).
7. Press MOTOR POWER switch (controller panel). Indicator should light.
8. Press READY switch (controller panel).
9. Press SINGLE PICK switch (operator panel) to initiate transport of single card from supply tray to receiving tray. If difficulty is experienced in performing this operation (failure to pick single card), check input throat for possible obstruction.
10. Remove card from receiving tray or secondary bin and replace in supply tray.
11. Press AUTO/MAN switch to return unit to auto mode.

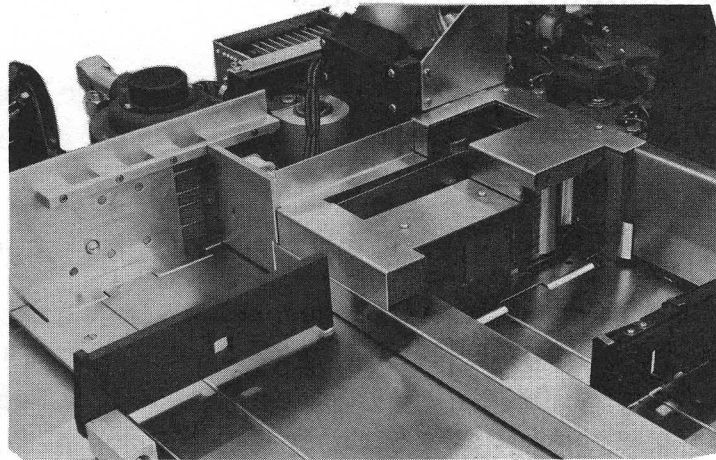

Figure A-2. Card Trays Set for 80-Column Cards

3142 CARD HANDLING AND LOADING INFORMATION

To obtain maximum efficiency from the 3142 Card Reader, care in card handling and loading is necessary. The user who familiarizes himself with the following instructions before operating the 3142 is far less likely to damage the reader or to encounter reading difficulties.

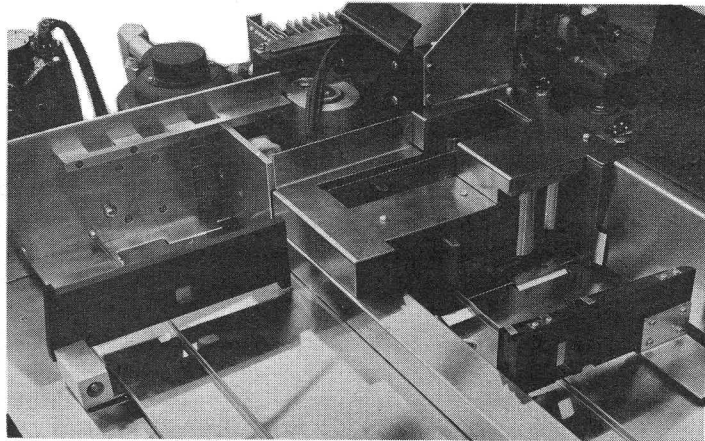

Figure A-3. Card Trays Set for 51-Column Cards

CARD CARE

No extraordinary care is required of card decks to be run through the 3142. However, best machine feeding results from perfectly flat cards. If the cards exhibit slight distortion, the operator can generally eliminate the distortion by gently binding the cards back and forth a few times.

More severe distortion is usually caused by incorrect storage procedures. Cards should be stored so they cannot bind or buckle (either firmly packed into a box or a drawer with an adjustable divider). Occasionally it may be necessary to control storage area humidity in order to prevent permanent warping of cards.

Mechanical damage to cards also causes feeding problems. Any practice which damages the edge, surface, or contour of the card should be avoided. Use of paper clips, staples, rubber bands, and so on, mars the card and may cause machine feeding difficulties.

NATIONAL CASH REGISTER EM-D2 (PE) PUNCHED CARD READER

Use Figure A-4 to locate the parts of the 3142 Card Reader that are referred to in this section.

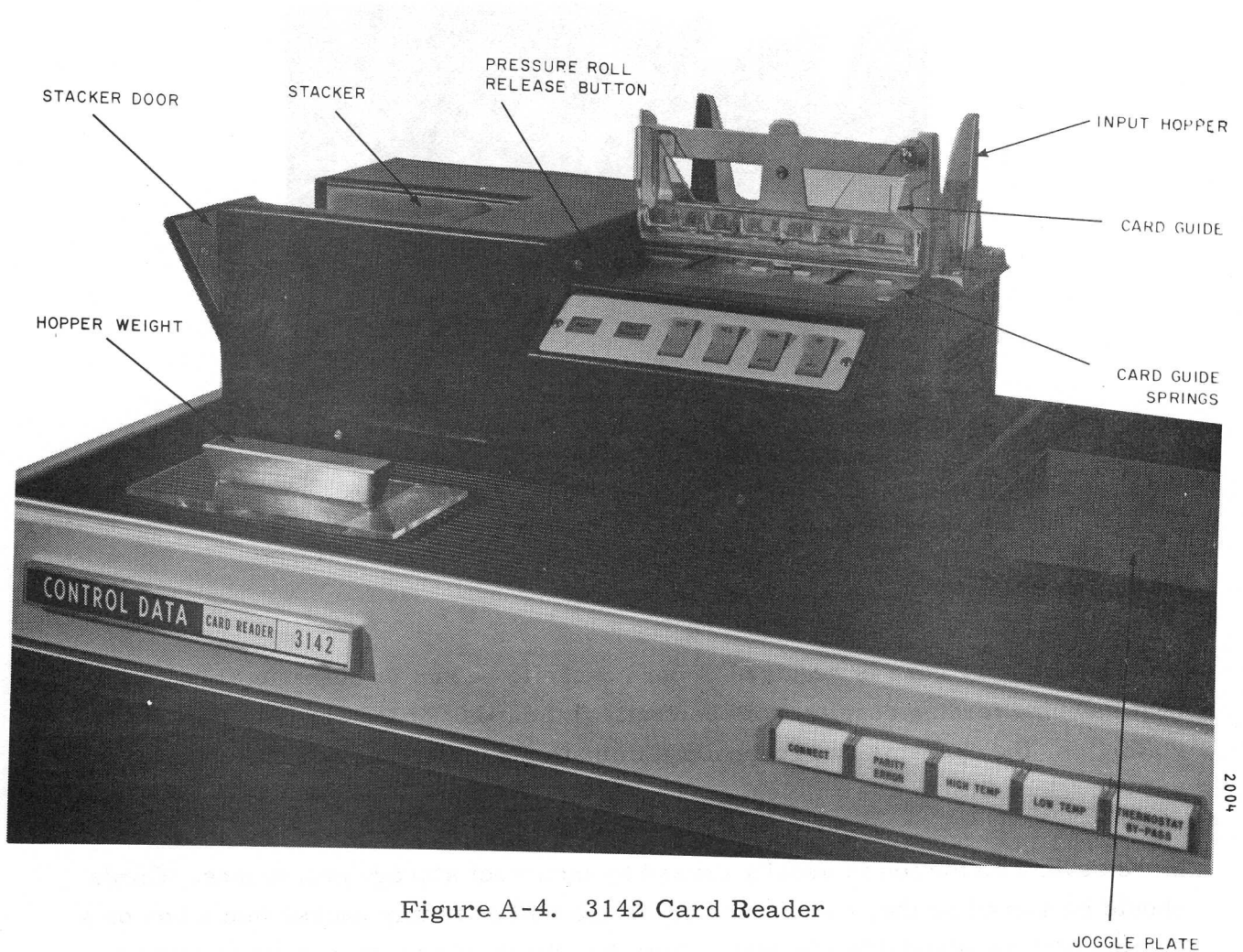

Figure A-4. 3142 Card Reader

READER LOADING

1. Align the cards on the joggle plate by gentle tapping. If the card edges do not align easily, do not damage the edges by banging the deck against the plate. Instead, lightly fan the deck and try again.
2. Using both hands as shown in Figure A-5, transfer the squared deck to the reader hopper without destroying the alignment. The proper card position is face down with the nine edge (bottom) toward the rear of the reader.

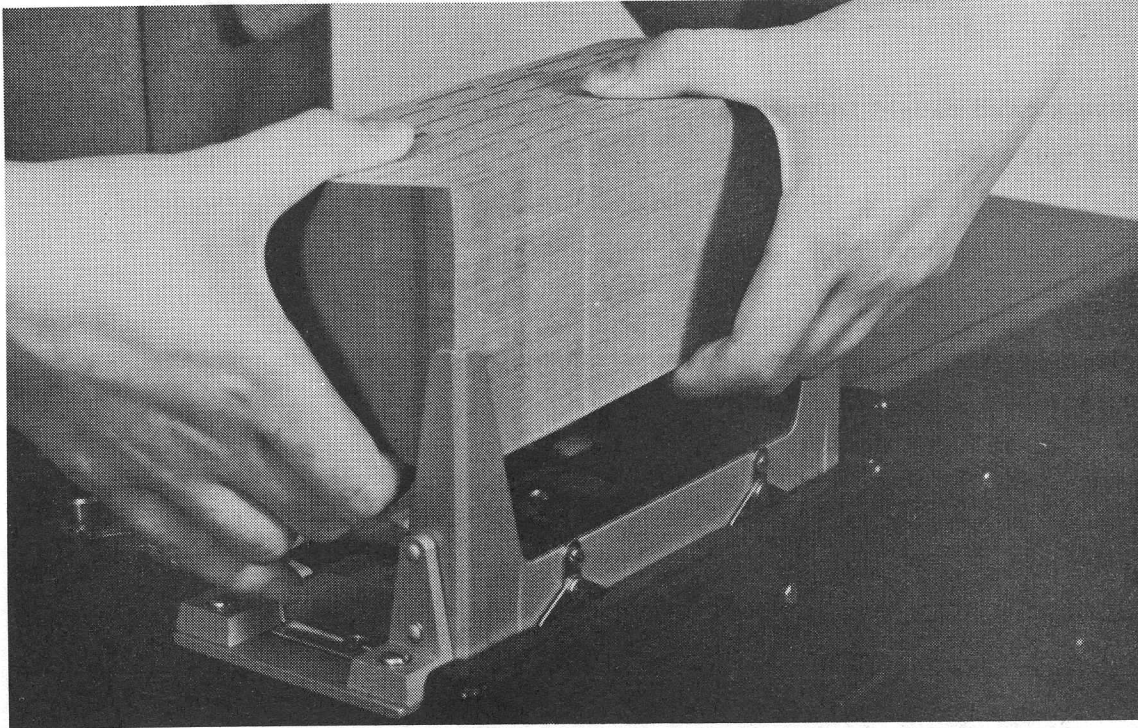

Figure A-5. Transferring Aligned Deck to Reader Hopper

3. Replace the hopper weight.
4. Check that the plastic card guide on the reader table is down.
5. Depress the REG key once.

JAM REMOVAL

To remove a card caught in the hopper throat area:

1. Protect fingers by turning reader power off or depressing the MAN switch. Either operation prevents feed knife motion.
2. Pull the card gently toward the front of the machine. This prevents bending the card guide springs.

CAUTION

Some models of the reader have four fragile card guide springs in the hopper throat area. These are shown in Figure A-4. Care must be exercised to prevent damage to these springs.

To remove a card caught in the read station actuate the pressure roll release button as shown in Figure A-6.

PRESSURE ROLL RELEASE BUTTON

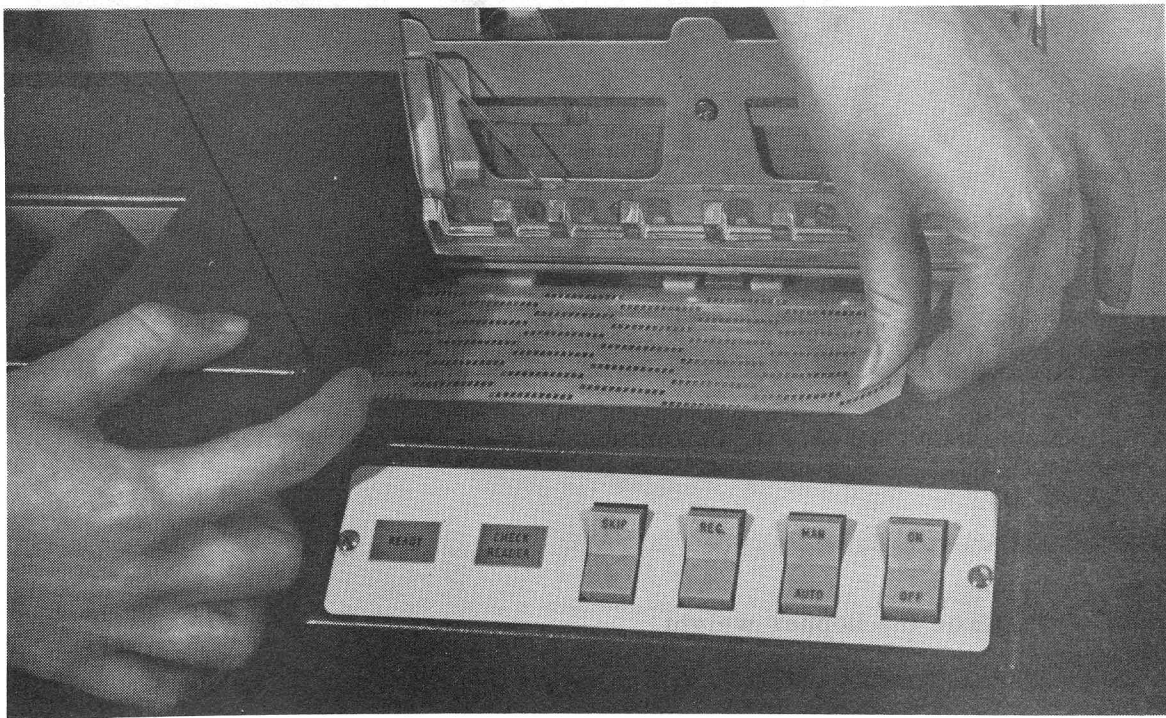

Figure A-6. Removal of Card from Read Station

READER UNLOADING

1. Open the stacker door at the left end of the card reader.
2. Pull the deck out through the door.

415 CARD PUNCH SWITCHES AND INDICATORS

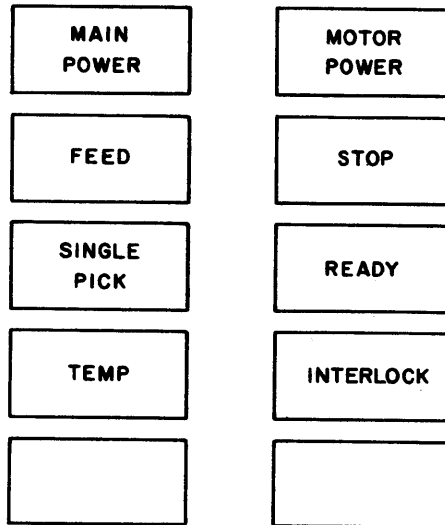

Figure A-7. 415 Punch Switches and Indicators

MAIN POWER SWITCH

This switch applies power to the cooling fans and the power supplies. It is lighted when power is on.

MOTOR POWER SWITCH

This switch applies power to the punch motor. It is lighted when power is on.

FEED INDICATOR

This indicator is lighted when a card jam exists.

STOP SWITCH

This switch causes the punch to become not ready. It is lighted when the punch is in a not ready condition.

SINGLE PICK SWITCH

This switch advances cards one cycle. It is lighted until the advance has been completed.

READY SWITCH

This switch clears punch logic and puts the punch in automatic mode. It is lighted when punch is in ready condition.

TEMPERATURE INDICATOR

This indicator is lighted whenever the card punch temperature exceeds 100^o F.

INTERLOCK INDICATOR

This indicator is lighted when the head panel, hood panel, or right door is open.

523 CARD PUNCH SWITCHES AND INDICATORS

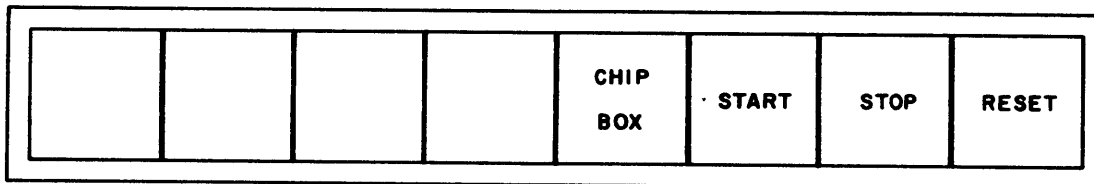

Figure A-8. 523 Punch Switches and Indicators

OFF/ON SWITCH

This switch applies power to the punch. It is located on the end panel on the right.

START SWITCH

This momentary-contact switch causes the cards to advance one cycle. From an initial load, pressing this switch twice advances cards into all stations. At the end of the operation, pressing switch twice unloads punched cards.

STOP SWITCH

This switch causes the punch to become not ready.

RESET SWITCH

This switch causes the punch to become ready following a reload or unload. It does not advance the cards.

CHIP BOX INDICATOR

This indicator is lighted whenever the chip box is full.

COMMENT SHEET

MANUAL TITLE CDC 3248-A, 3447-A/B/C, 3447-2, 3649-A Standard Option
10194-2 Card Reader Controllers Reference Manual

PUBLICATION NO. 60332300 REVISION F

FROM: NAME: _____
BUSINESS ADDRESS: _____

CUT ALONG LINE

PRINTED IN U.S.A.

AA3419 REV. 7/75

NO POSTAGE STAMP NECESSARY IF MAILED IN U. S. A.
FOLD ON DOTTED LINES AND STAPLE

STAPLE

STAPLE

FOLD

FOLD

FIRST CLASS
PERMIT NO. 8241
MINNEAPOLIS, MINN.

BUSINESS REPLY MAIL
NO POSTAGE STAMP NECESSARY IF MAILED IN U.S.A.

POSTAGE WILL BE PAID BY
CONTROL DATA CORPORATION
Publications and Graphics Division
ARH219
4201 North Lexington Avenue
Saint Paul, Minnesota 55112

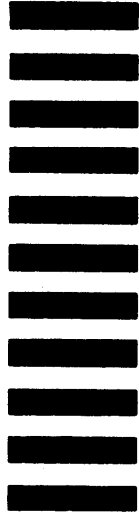

CUT ALONG LINE

FOLD

FOLD