



**CONTROL DATA[®]
SYSTEM 17
1732-3 MAGNETIC TAPE
TRANSPORT CONTROLLER**

HARDWARE REFERENCE MANUAL

PREFACE

This manual supplies hardware reference information for the CONTROL DATA^R System 17 1732-3 Magnetic Tape Transport Controller, which may be used with the 1784 Computer and the 6173 or 6193/6195 Magnetic Tape Transports.

This manual covers the two following equipments:

FA446-A NRZI-LCTT Magnetic Tape Transport Controller

FV618-A LCTT Phase Encoding Formatter

The following CONTROL DATA^R publications may be useful references:

1784 Computer Hardware Reference Manual	89633400
AB107/AB108 Computer Hardware Maintenance Manual	89633300
Input/Output Specification	89673100
FA442-A NRZI ICL Magnetic Tape Transport Controller and FA446-A NRZI LCTT Magnetic Tape Transport Controller	
Hardware Maintenance Manual	89637700
FV497-A ICL Phase Encoding Formatter and FV618-A LCTT Phase Encoding Formatter Hardware Maintenance Manual	89796100

	<u>Page</u>
3. <u>Operation</u>	3-1
Equipment Number	3-1
<u>Jumper Plugs</u>	
Scanner Jumper	3-1
<u>Plugs</u>	
Protect On/Off	3-2
<u>Jumper Plugs</u>	
Speed Select Jumper	3-2
<u>Plugs</u>	
Modulation Select	3-2
<u>Jumper Plugs</u>	
Dual Mode	3-3
<u>Jumper Plugs</u>	
Example for Jumper Plug Usage	3-4

FIGURES

	<u>Page</u>
1-1 Typical 1732-3 Configuration	1-3
1-2 7 Track Nrzi Tape Format	1-5
1-3 9 Track Nrzi Tape Format	1-6
1-4 PE Tape Format	1-8
1-5 PE File Mark Format	1-9
1-6 File Protection Ring	1-13
2-1 Format of Q Register	2-2
2-2 Control Function for A	2-5
2-3 Unit Select for A	2-5

TABLES

		<u>Page</u>
1-1	Tape Format - NRZI and PE	1-12
2-1	Hexadecimal Code for Controller Addresses	2-3
2-2	1732-3 Operations	2-4
2-3	Motion Control	2-7
2-4	Non Stop Motion Transition	2-9
2-5	Tape Unit Select Codes	2-10
2-6	Director Status 1 Response Bits	2-15
2-7	Director Status 2 Response Bits	2-15
3-1	Jumper Plug Locations	3-3
3-2	Legal Track-Mode-Modulation Jumper Plug Settings	3-3

1732-3 MAGNETIC TAPE TRANSPORT CONTROLLER (LCTT)
REFERENCE MANUAL

INTRODUCTION The CONTROL DATA[®] 1732-3 NRZI and PE LCTT Magnetic Tape Transport Controller controls tape motion and transfers conditioned data between a 1784 computer system and up to four LCTT tape transports. This reference manual describes the physical system, the programming requirements and the operating procedures for the controller.

FUNCTIONAL
DESCRIPTION

System

Relationship

The magnetic tape transport controller is normally installed in slots 11 through 14 of the 1784 enclosure. Up to four LCTT tape transports can be used with each controller. These may be either the seven or nine-track, 25 or 50 ips, NRZI or Phase Encoded modulation types, with densities of 556 or 800 bpi for the seven-track or 800 (NRZI)/1600 (PE) bpi for the nine-track. The tape transports may be intermixed in any combination in daisy-chain (see Figure 1-1).

The CONTROL DATA[®] 6173, 6193 or 6195 Magnetic Tape Transports are used with this controller.

The CONTROL DATA[®] 10300-2 Phase Encoding Formatter provides the 1732-3 controller with the additional capability of handling PE data at 1600 bpi on a dual mode nine-track LCTT transport.

Power for the controller is derived from the computers power supply.

The 1732-3 contains the logic that executes the following:

- 1) Selects the LCTT.
- 2) Decodes the CPU function codes.
- 3) Controls the LCTT operation.
- 4) Assembles, disassembles and transfers data between the CPU and the LCTT.
- 5) Detects operation and transmission errors.
- 6) Provides the LCTT status information to the CPU.

Character-Assembly/Disassembly Operating Modes

The 1732-3 operates in either the Character mode or Assembly/Disassembly mode. In the Character mode the 1732-3 sends data bits 0-5 or 0-7 to the tape transport (depending upon whether the tape unit is seven- or nine-track). The upper eight or 10 bits are ignored by the controller. Likewise, when the computer reads data from the tape via the 1732-3 in Character mode, each tape word is sent to the computer in bit positions 0-5 (or 0-7); the remaining bits are ignored by the computer.

In A/D mode each computer word sent to the tape via the 1732-3 is disassembled into two sections before being sent to the tape unit. If the computer sends data to a seven-track (6173) tape unit, data bits 8-13 comprise the first tape word and data bits 0-5 comprise the alternate tape word. Bits 6, 7, 14 and 15 are ignored.

When the computer sends data to a nine-track (6193/6195) tape unit, data bits 8-15 comprise the first tape word and data bits 0-7 comprise the alternate tape word.

1784 COMPUTER

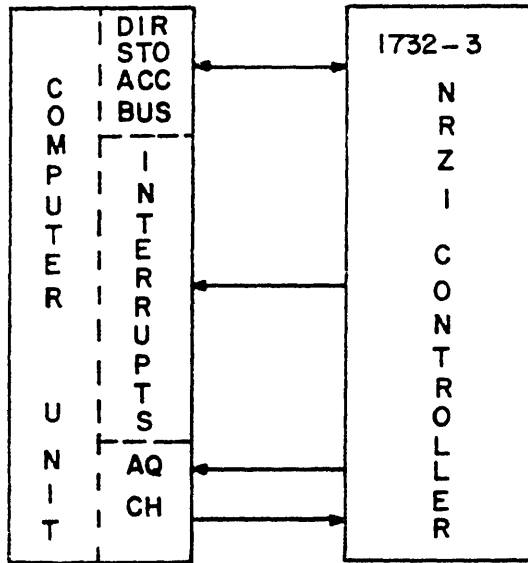

TAPE TRANSPORTS

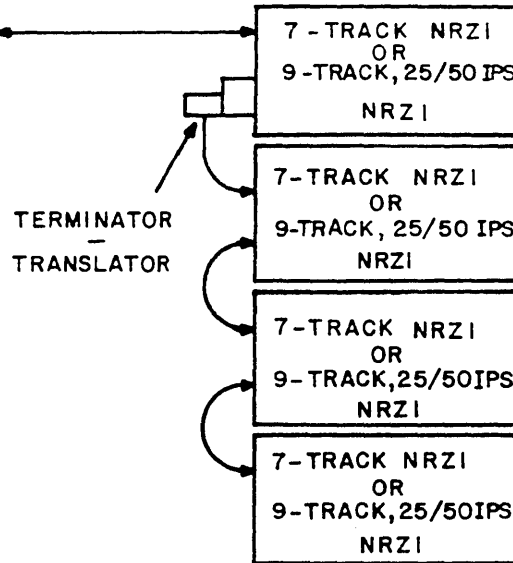

CONTROLLER WITHOUT PE FORMATTER

1784 COMPUTER

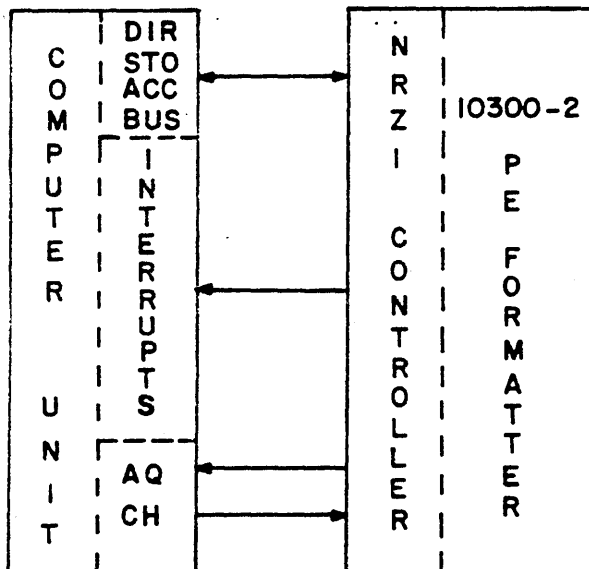

TAPE TRANSPORTS

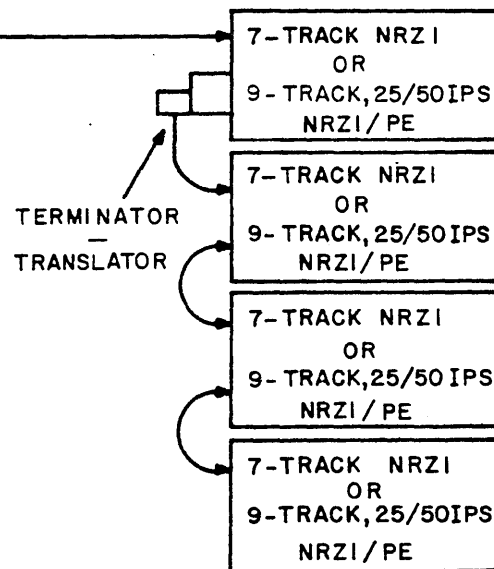

CONTROLLER WITH PE FORMATTER

Figure 1-1. Typical 1732-3 Configuration

If the controller, operating in A/D mode, reads an odd number of tape words, the lower bits of the last assembled word will be filled with zeros. The Fill status bit will be set to indicate that this portion of the assembled word is not data.

The equipment number jumper plug, located on the controller, designates the controller address (0 through F hexadecimal). Any one of the four associated tape transports attached to the controller may be selected.

Magnetic Tape

Magnetic tape provides a high-speed, nonvolatile storage medium. The tape has a plastic base and is coated on one side with magnetic oxide. Information is recorded on this coating. Extreme care is taken to prevent error-causing imperfections.

Information is read (detected) or written (stored) by passing the oxide side of the tape over read/write heads. During a Read or Write operation, the tape passes seven or nine evenly aligned heads: therefore, all bits of the tape word may be simultaneously recorded, one bit on each track.

Load Point

The load point is a reflective marker indicating the beginning of the usable portion of the tape. It is located at least 10 feet from the beginning of the tape.

End-of-Tape Marker

The end-of-tape marker is a reflective marker placed not less than 18 feet from the end of the tape.

Tape Format

The 1732-3 Magnetic Tape Transport Controller generates a 556 or 800 bpi NRZI format. With the addition of the 10300-2, a 1600 bpi phase encoded format may also be generated. Both formats are IBM and ANSI compatible.

NRZI Format

In a non-return-to-zero (NRZI) system, magnetic particles on the tape are aligned in either the positive or negative direction. A binary "1" is recorded by reversing the alignment (polarity); no polarity reversal indicates a "0". Thus, each track of the tape is fully magnetized and the polarity is reversed as each "1" bit is recorded. Figures 1-2 and 1-3 show the NRZI tape format for the seven- and nine-track tapes.

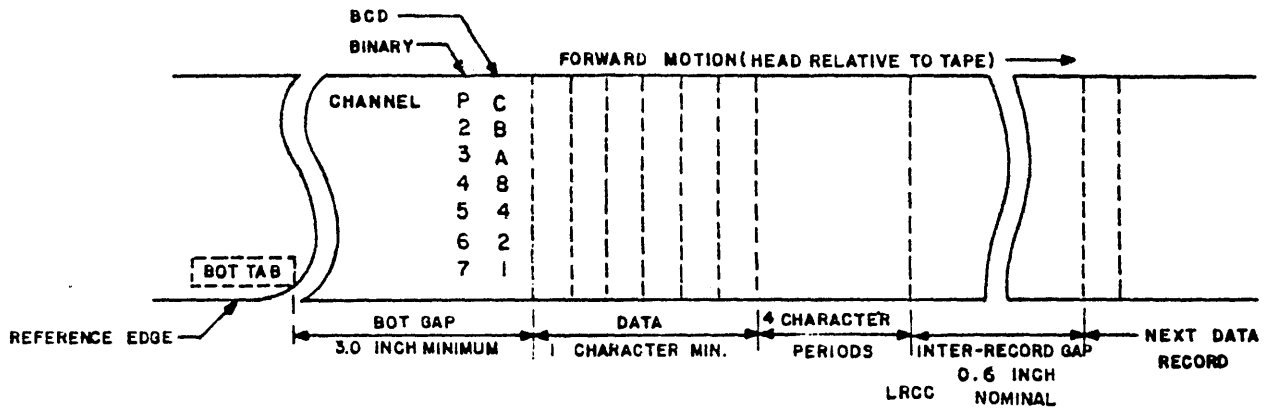

Legend

- BOT beginning of tape
- LRCC longitudinal redundancy check character
- CRCC cyclic redundancy check character

NOTES:

1. Tape is shown with oxide side up, Read/Write head on same side as oxide. Tape shown representing "1" bits in all NRZI recording; "1" bit produced by reversal of flux polarity, tape fully saturated in each direction.
2. Tape to be fully saturated in the erased direction in the interlock gap and the initial gap.
3. All dimensions are given in inches.

Figure 1-2. 7-Track NRZI Tape Format

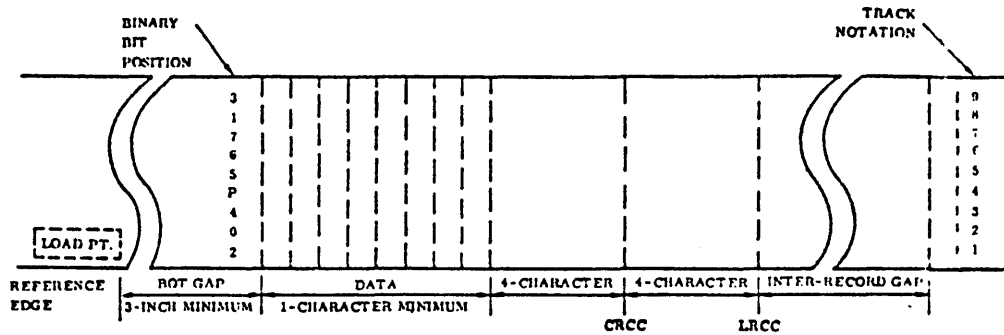

Legend:

- BOT beginning of tape
- LRCC longitudinal redundancy check character
- CRCC cyclic redundancy check character

NOTES:

1. Tape is shown with oxide side up, Read/Write head on same side as oxide. Tape shown representing "1" bits in all NRZI recording; "1" bit produced by reversal of flux polarity, tape fully saturated in each direction.
2. Tape to be fully saturated in the erased direction in the interlock gap and the initial gap.
3. All dimensions are given in inches.

Figure 1-3. 9-Track NRZI Tape Format

ID Burst

Details of the phase encoded (PE) format are shown in Figure 1-4. A tape which has been recorded using the PE method is identified by an Identification (ID) Burst of alternate ones and zeros in the parity track. This burst begins 1.7 inches before the trailing edge of the BOT tab and terminates past the tab.

Preamble

Each PE data block is preceded by a Preamble consisting of 40 bytes of all zeros followed by one byte of all ones. The Preamble is read at the beginning of each data block for the purpose of electronic synchronization. When lock-on or synchronization is achieved, the all ones byte defines the end of the Preamble and the beginning of data.

Postamble

Following each PE data block is a Postamble which is the mirror image of the Preamble; i.e., one byte of all ones followed by 40 bytes of all zeros, as shown in Figure 1-4.

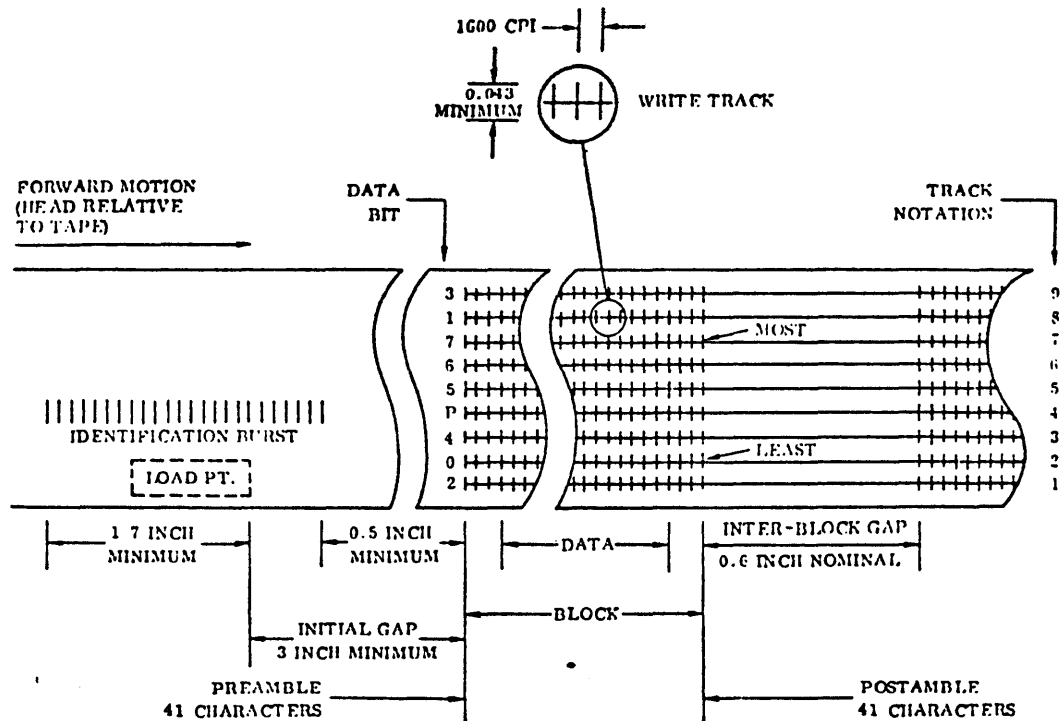

NOTES:

1. Tape is shown with oxide side up, Read/Write head on same side as oxide.
2. Tape to be fully saturated in the erased direction in the Inter-Block Gap and the Initial Gap.
3. The Identification burst must extend past the end of the BOT marker.

Figure 1-4. PE Tape Format

File Mark

Figure 1-5 illustrates the format of PE File Mark. The PE File Mark is defined as 32 to 128 zero bits in tracks 2, 5 and 8. The 10300-2 writes a File Mark as 40 zero bits in tracks 2, 4, 5, 7 and 8, with tracks 1, 3, 6 and 9 DC erased.

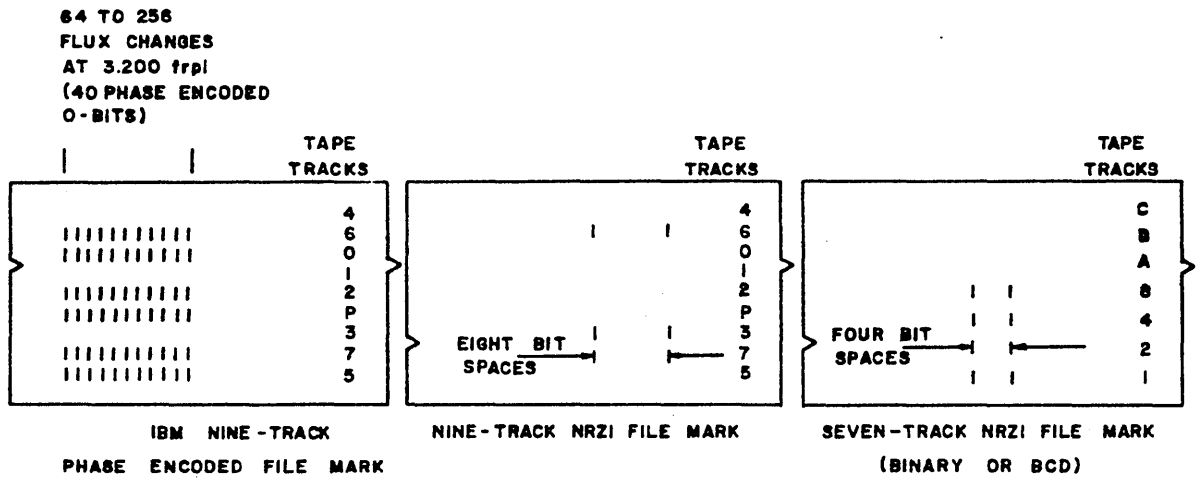

Figure 1-5. PE File Mark Format

Density and Speed

The controller, when connected to the seven-track tape transport, may be selected to synchronize data at a rate of 556 or 800 bits per inch. When the controller is connected to a nine-track tape, either 800 bpi or 1600 bpi density may be selected.

Code

The seven-track tape transport records data in either of two codes: binary code which uses odd parity; or BCD, which uses even parity. Since there is no BCD conversion in the 1732-3 the BCD "zero" character is illegal and should not be used.

Cyclic Redundancy Check (CRC)

The Cyclic Redundancy feature is an additional check of the accuracy of transmission and reception between the controller and the tape unit. The CRC, used by the controller only in conjunction with the nine-track NRZI, is accomplished by writing a Cyclic Code word at the end of each record. When the record is read by the controller, the code word should toggle the CRC output lines to an all clear condition if the data is correct. If the CRC determines that the data is incorrect, a parity error is indicated via the Parity Error Status response.

Records and Files

Data recorded on the tape is arranged in groups called records and files. A record consists of consecutive frames of information. A minimum of one frame for NRZI and 18 frames of information for PE constitutes a record. Adjacent records are separated by an unrecorded area called record gap (see Table 1-1).

A file consists of a group of records. Adjacent files are separated by recording an End-of-File marker seven inches from the last record in the file. In the seven-track the End-of-File marker is called File Mark; in the nine-track, the End-of-File marker is called Tape Mark.

Parity

The controller may be selected to operate with even BCD or odd binary vertical parity. The controller generates an even longitudinal parity check character for each physical record.

During a Write, the Read heads of the tape transport transfer the newly written character to the controller. The controller performs a Vertical and Longitudinal parity check and sets the Parity Error status bit if an error has occurred. If the Alarm interrupt has been selected, an interrupt occurs.

During a Read operation the parity bit, LRCC and CRCC recorded on the tape is checked against the character. The Parity Error status bit sets if an error occurs. If the Alarm interrupt has been selected, an interrupt may occur.

A summary of the preceding information may be found in Table 1-1.

TABLE 1-1. TAPE FORMAT - NRZI AND PE

Specifications	6173 Tape Transport	6193/6195 Tape Transports
Tracks	seven	nine
Tape Speed (ips)	25	25 or 50
Density (bpi)* NRZI	556 800	800
PE**		1600
Parity Vertical	Binary-odd BCD-even placed in seventh track	odd - placed in fourth track
Longitudinal	even parity check character spaced 4 frames from last data character.	even parity check character spaced 4 frames from the CRC code word.
Cyclic Redundancy Code Word	none	spaced 4 frames from last data character
File Mark	A BCD 17 _g six inches from last record. The File Mark is followed by a longitudinal check character of BCD 17 _g , spaced after 4 frames.	
Tape Mark		A 023 _g character 6" from the last record. It is followed by an identical check character, after 8 frames.
Initial Gap	4.0 inches minimum	4.0 inches minimum
Record Gap	0.81 inches minimum	0.61 inches minimum

* NRZI: Non-Return-to-Zero
PE: Phase Encoded

** Using 10300-2 Phase Encoding Formatter (available with 6193/6195 Magnetic
Tape Transport only)

File Protection

The back of a tape reel has a slot near the hub for a plastic file protection ring (Figure 1-6). Writing on a tape is possible only when the reel contains a file protection ring. Reading from the tape is possible with or without the ring. Removal of the file protection ring after writing avoids loss of valuable records due to accidental rewriting.

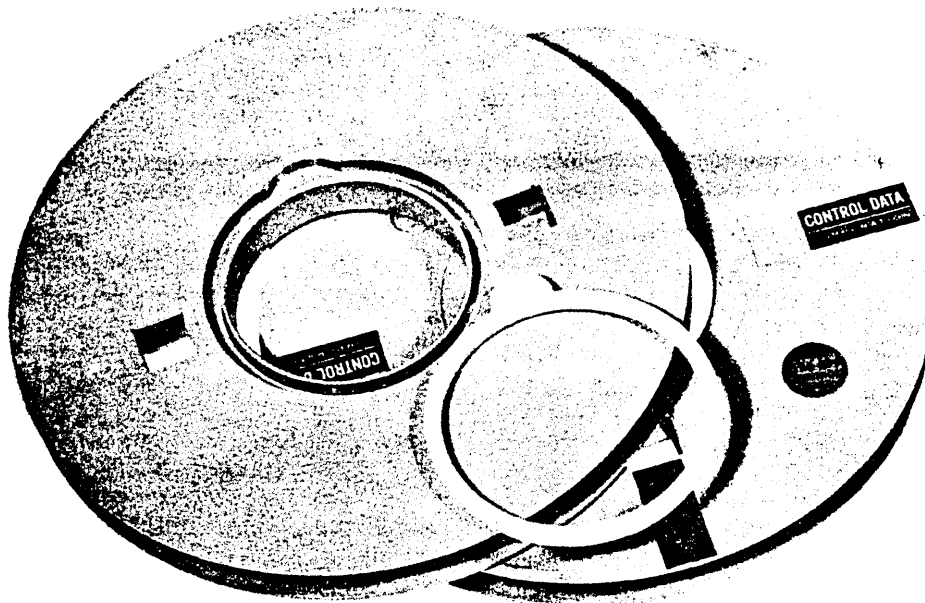

Figure 1-6. File Protection Ring.

Program Protection

The 1784 I/O system has a program protect feature which reserves protected equipment for use by protected programs. A 6173 or 6193 Tape Transport is protected by setting the Program Protect jumper plug on the 1732-2 Controller which corresponds to the setting of its Unit Select jumper plug. When its Program Protect jumper plug is set, all instructions for that tape transport (except the three status requests) are rejected if their Program Protect bit is not set or the 1784 protect system is not enabled. To explain in more detail:

- 1) A protected program may select any unit that is physically in the system, loaded, under external control, and Not Busy.
- 2) An unprotected program cannot select a tape unit whose switch is in the protected position.

After an attempt by an unprotected program to select a protected transport, the status is:

- 1) Not Ready, Protected - No tape transport is selected and the requested transport is protected. Any previously selected transport is unprotected and is now deselected.
- 2) Ready, Protected - The previously selected tape transport is still selected. Once selected, a protected transport can be deselected only by using an Output from the A instruction whose Program Protect bit is set to initiate either a Deselect Tape Unit function or a new Select Tape Unit function.

SECTION 2

PROGRAMMING

PROGRAMMING

Summary of Programming Information

Tables 2-1 through 2-7 and Figures 2-1 through 2-9 provide the experienced programmer with the information necessary to program the 1732-3. The following paragraphs further define this information.

The 1732-3 communicates with the 1784 Processor via the computer A/Q channel and DSA channel.

The Q register designates the equipment to be referenced and directs the operation to be performed upon the input or output instruction execution. Figure 2-1 illustrates the format of the Q register:

- Bits 11 - 15 should always be zero.
- Bits 7 - 10 select the 1732-3; these bits must match the equipment number of the controller.
- Bits 2 - 6 are ignored.
- Bits 0 - 1 (the Director) specify an operation according to Table 2-2.

The 1732-3 has two modes of operation:

1) Direct:

Operation is initiated and data is transferred via the A/Q channel.

Direct transfer shall be accomplished by the following sequence:

1. Control Function (Read Motion and Write Motion).
2. Input to A or Output from A instruction for every data word.

2) Buffered:

Operation is initiated through the A/Q, and data transfer is via the DSA.

Buffered I/O transfer shall be accomplished by issuing the following sequence:

1. Buffered I/O instruction
(Controller fetches LWA+1 from FWA-1 and waits)
2. Control Function (Read Motion or Write Motion) instruction. Read Data transfer starts when data block moves under the Read head.
Write Data transfer starts when pre-record gap has passed under the Write head.

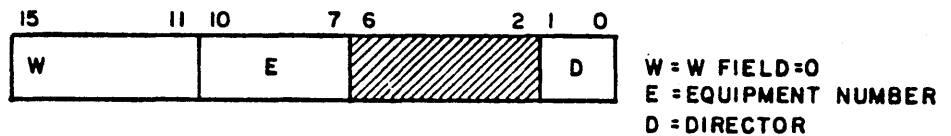

Figure 2-1. Format of Q-Register

Addresses

The W = 0 signal plus bits 10-7 of the Q register are used to select the 1732-3. The W field of Q is always loaded with zeros. Bits 0-1 of Q are used to specify an operation. Figure 2-1 illustrates the format of the Q-Register. Table 2-1 lists the values of E required to select a controller with a given equipment number setting.

TABLE 2-1. HEXADECIMAL CODE FOR CONTROLLER ADDRESSES (E FIELD)

Hexa- decimal Code	Q-Register			
	Q10	Q09	Q08	Q07
0	0	0	0	0
1	0	0	0	1
2	0	0	1	0
3	0	0	1	1
4	0	1	0	0
5	0	1	0	1
6	0	1	1	0
7	0	1	1	1
8	1	0	0	0
9	1	0	0	1
A	1	0	1	0
B	1	0	1	1
C	1	1	0	0
D	1	1	0	1
E	1	1	1	0
F	1	1	1	1

Note

A "1" in the binary code (Q10 - Q07) indicates the presence of a jumper plug in that position on the PW assembly matching the signal present in that bit of the Q-Register. A "0" indicates the absence of a jumper plug matching the Q-Register bits.

Bits 10-7 of the A register are used along with the contents of Q and Output from A to select a tape transport. (See Unit Select).

OPERATIONS

The D field of Q is combined with an AB107/AB108 Input from A or Output from A instructon to specify an operation (see Table 2-2). The operations initiated by an Output from A may be further modified by the contents of the A register (see Table 2-3, Figures 2-2 and 2-3). The following paragraphs define these operations.

Operations Defined by Q and Output from A

Write: A Write transfers data from the computer to the controller which generates a parity bit and writes the data plus parity bit on the tape. To perform a Write, load Q with W = 00*, E = Equipment number setting of

* W is written as two digits; the left, binary; the right, hexadecimal.

1732-3 controller and D = 00. An Output from A instruction initiates the transfer of the computer word to the tape. Any number of consecutive characters sent to the tape are written (along with a parity bit) on the tape as a single record. Whenever the computer breaks the continuity of the computer word outputs, the controller initiates an End-of-Record sequence. A Write is rejected if Not Ready, Write Motion has not been initiated, Data Status is not set, if Buffered I/O is set or a Program Protect fault occurs. If no new Control Function is received from the computer, tape motion stops at the next interrecord gap.

TABLE 2-2. 1732-3 OPERATIONS

Computer Instruction		
D	Output from A	Input to A
00	Write	Read
01	Control Function	Director Status 1
10	Unit Select	Director Status 2
11	Buffered input/Output	Current Address

Control Function: The Control Function specifies operating conditions for the selected controller and transport and initiates tape motion. To perform a Control Function, load Q with W=00, E=equipment number, and D=01. Load A according to Figure 2-2 and Table 2-3, and execute an Output from A.

If bits 7-10 of A equal zero, the control function is rejected only if a protect fault occurs. Otherwise the controller rejects control functions if it is Not Ready, the End-of-Operation status condition is not present, an illegal code exists in bits 7-10 of A, the tape transport is Busy or if a protect fault occurs. Control Function is not rejected if it is issued after EOP status is set and same motion direction is requested and same data transfer direction (Read or Write) is requested. (See Table 2-3), otherwise Reject will occur. Write Motion or Write FM/TM is rejected if the file protect ring is absent.*

*Caution: Control Functions to change directions after EOP will be accepted, however mispositioning of tape may occur. A direction change function should not be issued while busy status is active.

Table 2-3 lists the legal motion control codes. One Motion Function plus any or all Clear and Interrupt selections may be selected simultaneously or individually. The requests are honored in this order: Clears, Interrupt selections and Motion Control.

A New Motion Function clears EOP, Alarm and all causes for Alarm.

The following describes these codes:

- 1) Clear Controller (A00 = 1) - Master clears the 1732-3 with the following exceptions: Unit Select, Mode Select, Code Select and Format Select.
- 2) Clear Interrupt (A01 = 1) - clears all interrupts and interrupt requests. If an interrupt request is coded along with a Clear Interrupt, that selection is honored, but any previous selections are cleared.
- 3) Data Interrupt Request (A02 = 1) - causes an interrupt to be generated when an information transfer through A/Q channel may occur. The interrupt response is cleared by the Reply to the data transfer. The request and response are cleared by a Clear Controller or a Clear Interrupt code.

- 4) End-of-Operation Interrupt Request (A03 = 1) - causes an interrupt to be generated at the end of an operation. The request and response are cleared by a Clear Controller or a Clear Interrupt code.
- 5) Alarm Interrupt Request (A4 = 1) - causes an interrupt to be generated upon a condition which warrants program or operator attention. The Alarm Interrupt is generated by any of the following conditions:
 1. End of Tape
 2. Parity Error
 3. Lost Data
 4. File Mark/Tape Mark
 5. The controller goes Not Ready during an operation.
 6. Storage Parity Error
 7. Protect Fault
 8. ID - Abort
 9. PE - Lost Data
 10. PE - Warning
- 6) Write Motion (A10-7 = 0001) - initiates Write Motion. If Buffered Input/Output is not set, the Data Status goes true which initiates Direct Data Output. Write Motion is terminated (EOP set) when End-of-Record is detected by the Read head.

If buffered I/O is not set, Write Motion is selected and no data transfer follows, the controller locks out and terminates the Write Motion function when it is time to write the first character on tape. Forward drops to the selected transport and the transport goes Not Busy, but no End-of-Operation is generated. To recover from this error condition, a Unit Select or Clear Controller function is issued to accept another motion function.

- 7) Read Motion (A10-7 = 0010) - initiates Direct or Buffered Data input. Read Motion terminates by absence of data from the magnetic tape transport. If the computer stops requesting characters, data transfer stops, but the tape continues to move to the end of the record. If a data transfer request is not received by the controller in time to complete the transfer properly, the Lost Data status bit is set and subsequent data requests are rejected. If a File Mark is encountered the File Mark status is set.

- 8) Backspace (A10-7 = 0011) - moves tape backward one record. Backspace from Load Point is not rejected (however the tape will not move) and non-stop backspace is possible.
- 9) Write File Mark (A10-7 = 0101) - moves tape forward approximately 6 inches and writes a File Mark. The normal End-of-Operation sequence follows the File Mark, writing the longitudinal check character.
- 10) Search File Mark Forward (A10-7 = 0110) - moves tape forward until a File Mark* is detected; an End-of-Operation (EOP) is generated and tape motion stops.

TABLE 2-3. MOTION CONTROL

Bits 10-7 of A	Motion Function
0001	Write Motion
0010	Read Motion
0011	Backspace
0101	Write File Mark/Tape Mark
0110	Search File Mark/Tape Mark Forward
0111	Search File Mark/Tape Mark Backward
1000	Rewind Load

* A parity error is indicated together with File Mark status if the MTTC is operating in binary format (seven and nine track).

- 11) Search File Mark Backward (A10-07= 0111) - moves tape backward until a File Mark is detected. When it has been detected, an End-of-Operation is generated, and tape motion stops. If no File Mark is detected, an End-of-Operation will be generated and motion will stop at Load Point.
- 12) Rewind Load (A10-07= 1000) - rewinds tape at high speed to Load Point. The controller remains Busy until tape is positioned at load point and End-of-Operation Status/Interrupt occurs. The 1732-3 stays Ready upon acceptance of this command.

Non-Stop Motion: Table 2-4 shows transition time in which a New Motion Function must be initiated to achieve Non-stop Motion after End-of-Operation Status/Interrupt occurs.

TABLE 2-4. NON-STOP MOTION TRANSITION

LCTT Speed	Transition Time		
	Write (Forward)	Read (Forward)	Backspace
25 ips	3.6 msec	2.6 msec	2.6 msec
50 ips	1.8 msec	0.5 msec	0.5 msec
Alternative for next Control Function	1. Write Data Record 2. Write File Mark/ Tape Mark	1. Read Motion 2. Search File Mark/ Tape Mark Forward	1. Backspace 2. Search File Mark/ Tape Mark Backward

Unit Select: A Unit Select selects a tape transport and its operating conditions or deselects a transport. To perform a Unit Select, load Q with W = 00, E = equipment number, D = 10. Load A according to Figure 2-3 and Table 2-5, and do an Output from A. Tape unit, density, and mode (BCD or binary) can be selected simultaneously or individually. Unit Select is rejected if Controller Active or a Program Protect fault occurs or if an illegal code is selected (for example, two densities chosen) or selection does not match the tape transport or controller settings. Unit Select clears the controller.

TABLE 2-5. TAPE UNIT SELECT CODES

Bits 9-7 Of A	Unit Select Jumper Setting
000	0
001	1
010	2
011	3

- 1) Character (A0 = 1) - In this format the computer word consists of the lower 6 or 8 bits only. Master Clear sets character format.
- 2) BCD (A1 = 1) - Data is read or written in even parity (6173 only).
- 3) Binary (A2 = 1) - Data is read or written in odd parity. Master Clear sets Binary code. Binary is selected by each Director Function.
- 4) Select 800 bpi (A3 = 1) - Data is recorded at a density of 800 bits per inch.
- 5) Select 556 bpi (A4 = 1) - Data is recorded at a density of 556 bits per inch.

- 6) Select 1600 bpi (A5 = 1) - Data is recorded at a density of 1600 bpi in the PE format. This bit can only be used with the PE formatter. Switching between NRZI and PE occurs only when tape is at Load Point (BOT).
- 7) Assembly/Disassembly Mode (A6 = 1) - In this format the computer word consists of 12 or 16 bits which, during a Write, are disassembled into two 6- or 8-bit tape words. During a Read, the tape words are assembled into the original computer word.
- 8) Tape Unit 0-7 (A9 = 7) - This code matches the Unit Select setting of the desired transport.
- 9) Select Tape Unit (A10 = 1) - This code and bits 9-7 of A selects a tape transport.
- 10) Deselect Tape Unit (A11 = 1) - This bit disconnects a tape transport that is selected and protected, thus allowing an unprotected program access to the controller. The tape does not have to be protected to deselect. Master Clear deselects all units.
- 11) Select Low Read Threshold (A12 = 1) - This bit is used to select the low read threshold level used for data recovery.

The controller reverts to normal read threshold when:

- (a) The Unit-Select function contains A12 = 0.
- (b) After any EOP.
- (c) Master Clear.

Buffered Input/Output: A Buffered I/O instruction initiates the transfer of data between the controller and the computer memory via the DSA. To execute Buffered I/O, load Q with W=00, E= (equipment number) and D=11. Load A with the first word address minus one (FWA-1) which contains the last address plus one (LWA+1). An Output from A instruction transfers the FWA-1 and LWA+1 into the controller (via the A/Q and DSA respectively).

The transfer of data will start after Write or Read Motion. The data transfer will terminate when current word address equals LWA+1, or when reading the End-of-Record is sensed. Lost Data conditions will occur when the DSA does not keep up with the transfer rate.

A Buffered I/O instruction is rejected if EOP status is not set and Busy is set, the tape transport is not ready or a Program Protect Fault occurs.

Operation Defined by Q and Input to A

Read (D = 00): A Read operation transfers data from tape to the computer and checks parity. To perform a Read, load Q with W = 00, E = Equipment Number, and D = 00. An Input to A initiates the transfer of one 6-, 8-, 12- or 16-bit character to the lower bits of the A register.

The controller transfers characters to the computer until the computer stops requesting characters, or until the controller senses the end of a record. If the computer stops requesting characters, data transfer to the computer stops, but tape motion continues until the end of the record. A read is rejected if the controller is Not Ready, read motion has not been set, data status is not set, a Program Protect fault occurs, or a Buffered I/O operation is in process.

Director Status 1 (D = 01): Director status 1 is a status request which loads into the A register a status reply word showing the current operating conditions of the MTTC. The request is initiated by loading Q with W = 00, E = Equipment Number, D = 01, and executing an Input to A. Table 2-6 describes the contents of A register following the execution of this function. The Status Response section defines these bits.

Director Status 2 (D = 10): Director Status 2 is a status request which loads into the A register a status reply word of the MTTC. The request is initiated by loading Q with W = 00, E = equipment number, D = 10, and executing an Input to A. Table 2-7 describes the contents of A register following the execution of this function. The Status Response section defines these bits.

Current Address (D = 11): This instruction is a status request which loads into the A register the address of the next word being transferred. To perform a Current Address, load Q with W = 00, E = equipment number and D = 11, and initiate an Input to A.

Status Response

Director Status 1

Table 2-6 lists the meaning of bits set in the A register following a Status 1 request. These bits are further defined below.

Ready (A0 = 1): The tape transport is connected to the equipment and the tape system can perform a command.

Busy (A1 = 1): Equipment is in motion. The MTTC becomes Busy before a Reply is returned if a function can be performed.

Interrupt (A2 = 1): An interrupt condition exists and interrupt upon this condition has been selected. This bit is cleared when the interrupt is cleared.

Data (A3 = 1): A Read/Write data transfer can now be performed. It is cleared by a data transfer request, Lost Data or End-of-Record sequence.

End of Operation (A4 = 1): A new tape function can now be accepted. This bit sets at the completion of all tape motion functions. During Read and Write, End-of-Operation (EOP) signifies that parity status is valid. Master Clear clears EOP. A New Motion Function can also be used to clear EOP.

TABLE 2-6. DIRECTOR STATUS 1 RESPONSE BITS

Bit Set In A-Register	Meaning
0	Ready
1	Busy
2	Interrupt
3	Data
4	End-of-Operation
5	Alarm
6	Lost Data
7	Protected
8	Parity Error
9	End-of-Tape
10	BOT
11	File Mark
12	Controller Active
13	Fill
14	Storage Parity Error
15	Protect Fault

TABLE 2-7. DIRECTOR STATUS 2 RESPONSE BITS

Bit Set In A-Register	Meaning
0	556 bpi
1	800 bpi
2	1600 bpi
3	Seven Track
4	Write Enable
5	PE-Warning
6	PE-Lost Data
7	PE-Transport
8	ID-Abort
9	Low Read Threshold
10-15	(Not Used)

Alarm (A5 = 1): This status bit monitors those conditions requiring the attention of the program or the operator. The following conditions set this bit as well as their own status bit:

- | | |
|--|-------------------------|
| 1) End-of-Tape | 6) Storage Parity Error |
| 2) Parity Error | 7) Protect Fault |
| 3) Lost Data | 8) ID - Abort |
| 4) File Mark | 9) PE - Lost Data |
| 5) The Controller goes Not Ready during an operation | 10) PE - Warning |

A New Motion Function or Clear Controller will clear Alarm.

Lost Data(A6=1): This bit indicates during an A/Q Read transfer that the Data Transfer register was not empty when a new frame of data was received from the tape transport. This clears Data Status and Data Interrupt.

This bit indicated during a Buffered I/O transfer that the computer's DSA bus has not been able to keep up to the MTTC data transfer requirements. During Buffered Output it initiates an End-of-Record sequence. During Buffered Input it stops data transfer. A New Motion Function clears Lost Data.

Protected (A7=1): This bit indicates that the Program Protect Jumper Plug of the selected tape transport is set.

Parity Error (A8=1): An error was detected during data transfer, or the controller has read or written a File Mark in binary mode, or done a Read operation or Backspace operation in the wrong mode or density. The parity check is complete and a Parity Error status is valid at the end of operation.

This condition responds to transverse, longitudinal, and cyclic redundancy parity errors. When reading PE tapes, this bit indicates a Parity Error only when no dropout is detected. Parity Error is cleared by issuing a New Motion function.

End-of-Tape (A9 = 1): An End-of-Tape (EOT) marker has been sensed. A New Motion Function clears EOT.

Load Point (A10 = 1): The tape Load Point has been sensed.

File Mark (A11 = 1): A File Mark has been sensed. It is cleared on a New Motion Function.

Controller Active (A12 = 1): MTT Controller is active controlling tape motion.

CAUTION: Write motion functions should not be issued between the time Controller Active status goes not active and Busy status goes not active. Non uniform record gaps may result.

Fill (A13 = 1): If an off number of tape words is read, this status will be set to indicate that the lower portion of the Read word is not a tape word. A New Motion Function clears Fill.

Storage Parity Error (A14 = 1): Storage Parity Error has occurred during a DSA channel transfer. A MTT controller New Motion Function clears Storage Parity Error.

Protect Fault (A15 = 1): The computer's Protect Fault flag was active during a MTT controller-DSA channel transfer New Motion Function clears Protect Fault.

Director Status 2

Table 2-7 lists the meaning of bits set in the A register following a Status 2 request. These bits are further defined below:

556 bpi (A0 = 1): The selected tape unit is set to operate at a density of 556 bits per inch.

800 bpi (A1 = 1): The selected tape unit is set to operate at a density of 800 bits per inch.

1600 bpi (A2 = 1): The selected tape unit (nine-track MTT only) is set to operate at a density of 1600 bits per inch.

Seven Track (A3 = 1): The selected tape unit is a seven-track transport.

Write Enable (A4 = 1): The File Protect Ring is in the supply reel and the tape has been loaded. Write operations may now be performed.

PE-Warning (A5 = 1): This bit indicates an error in the PE Formatter which did not affect the data transfer. The following conditions set this bit:

- a) Corrected Dropout; one dropout occurred during reading of present record.
- b) Wrong Postamble; Postamble exceeds 48 zeros or contains ones. This is cleared by a New Motion Function.

PE-Lost Data (A6 = 1): This bit indicates an error in the PE formatter which affected the data transfer. The following conditions set this bit:

- a) skew buffer overflow
- b) multitrack dropout
- c) preamble format error

PE Transport (A7 = 1): Selected transport (nine-track MTT only) can record 1600 bpi density and the PE Formatter is in.

ID Abort (A8 = 1): 1600 bpi was selected (nine-track MTT only) but no Identification burst was detected after starting of tape motion from BØT. ID Abort triggers Alarm and tape motion is stopped. Operation will continue after issuing a New Motion Function and without further check of ID.

Low Read Threshold (A9 = 1): The Low Read Threshold is selected.

INTERRUPTS

Interrupts are selected by the Control Function. They may be cleared by:

- 1) Issuing a Clear Interrupt which clears both the Interrupt request and the interrupt.
- 2) Re-issuing the Interrupt Request except for the Alarm Interrupt when the Alarm condition still exists, e.g., End-of-Tape.
- 3) Issuing a Clear Controller.
- 4) Transferring data in the case of the data interrupt.
- 5) Reselecting a unit.

SECTION 3
OPERATION

OPERATION

The positions for the jumper plugs indicated herein are located on the PWB's as shown in Table 3-1 and in Figures 3-1 and 3-2. The PWB's referred to may be accessed by opening the front cover of the enclosure and removing them after turning power off.

On the Q-Channel PWB (installed in Location 12):

Equipment Number Jumper Plugs

These four jumper plugs are used to represent any number from 0 to 15₁₀. They are used to assign an equipment number to the MTTC. Any instruction sent by the computer must be accompanied by an equipment number (bits Q7-Q10) that matches the settings of the jumper plugs. The W=0 must also be set. The position is set if the jumper plug is inserted. Refer to Figure 3-1.

Scanner Jumper Plug

When performing maintenance operations and for initial installation of the controller, the Scanner jumper plug should be adjusted. These are four jumper plugs, only one of which should be inserted as follows:

- 1) Middle
- 2) First
- 3) Last
- 4) One
- 5) Out (no jumper)

These names reflect the controller's position within the DSA bus and varies with each system.

Protect On/Off Jumper Plugs

There are four jumper plugs; one per tape transport. When any tape transport is selected, this jumper when placed allows only protected instructions (except status requests) to access the MTTC.

If a buffered input is initiated by a Protected instruction, a Protect signal is sent to the computer allowing data to be written into any storage location, regardless of Protect setting.

Speed Select Jumper Plugs

There are four jumper plugs; one per tape transport. These jumpers should be set according to the speed of the corresponding tape transport - either high speed (High = 50 ips) or low speed (25 ips) is selected. With the jumper plug inserted, High speed is selected. With the jumper plug out the low speed is selected.

Track Select Jumper Plugs (Table 3-2)

There are four jumper plugs; one per tape transport. These jumpers should be set according to the track type (seven-track or nine-track) of the corresponding tape transport. With the jumper inserted, it represents a nine-track tape transport.

Modulation Select Jumper Plugs (Table 3-2)

There are four jumper plugs; one per tape transport. These jumpers should be set according to the capability of the tape transport - either NRZI or PE (provided nine-track and Not Dual Mode are selected). With the jumper in, it represents a tape transport using PE modulation only.

Dual Mode Jumper Plugs (Table 3-2)

There are four jumper plugs; one per tape transport. These jumpers must be inserted when the MTT is capable of dual mode operation (NRZI/PE) provided the Track Select jumper plugs are also set to nine-track.

TABLE 3-1. JUMPER PLUG LOCATIONS

Jumper Plug	Assembly	Slot	Position
Equipment Number	Q-Channel	12	At U2
Scanner Select	Q-Channel	12	At U2
Protect On/Off	Lower Data	13	At U1
Speed Select	↑ ↓	13	At U1
Track Select		13	At U18
Modulation Select		13	At U18
Dual Mode Select	Lower Data	13	Above U35

TABLE 3-2. LEGAL TRACK-MODE-MODULATION JUMPER PLUG SETTINGS

Transport Type	Jumper Setting					
	Track 7 <u>9</u>		Mode Single <u>Dual</u>		Modulation NRZI <u>PE</u>	
7 Track NRZI	OUT	OUT	OUT	OUT	OUT	OUT
9 Track NRZI Only	OUT	IN	OUT	OUT	IN	OUT
9 Track PE Only	OUT	IN	OUT	OUT	OUT	IN
9 Track Dual Mode	OUT	IN	OUT	IN	OUT	OUT

Example for using jumper plugs:

7-Track, Protected, 25 ips:

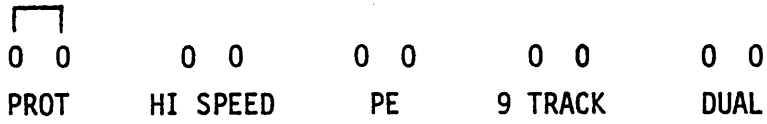

9-Track, 50 ips, Dual Mode:

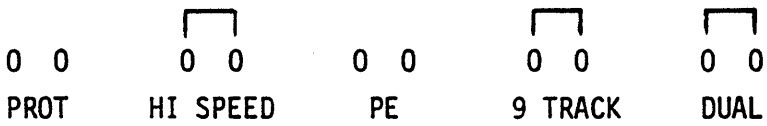

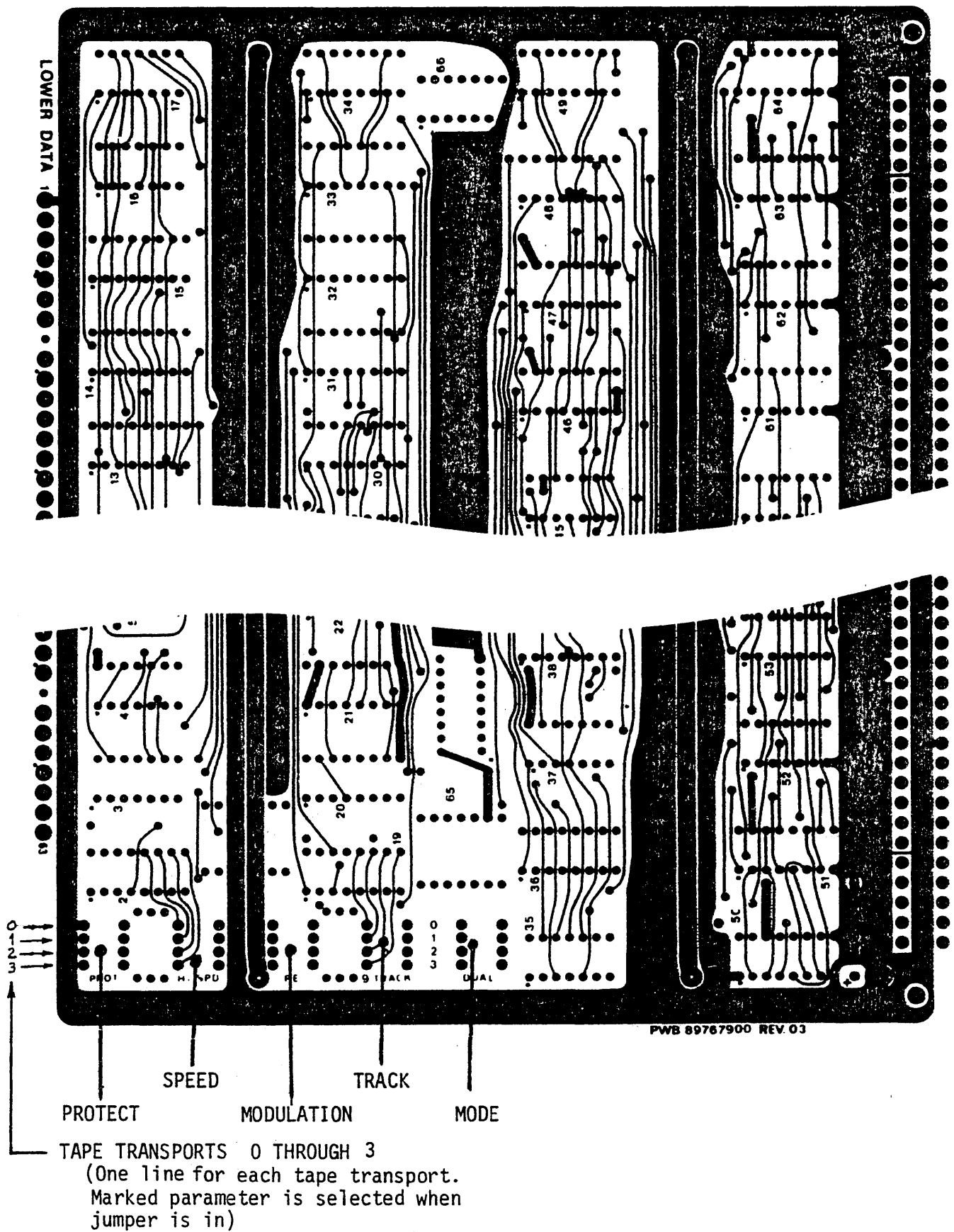

Figure 3-2. Lower Data Section Showing Jumper Plug Positions

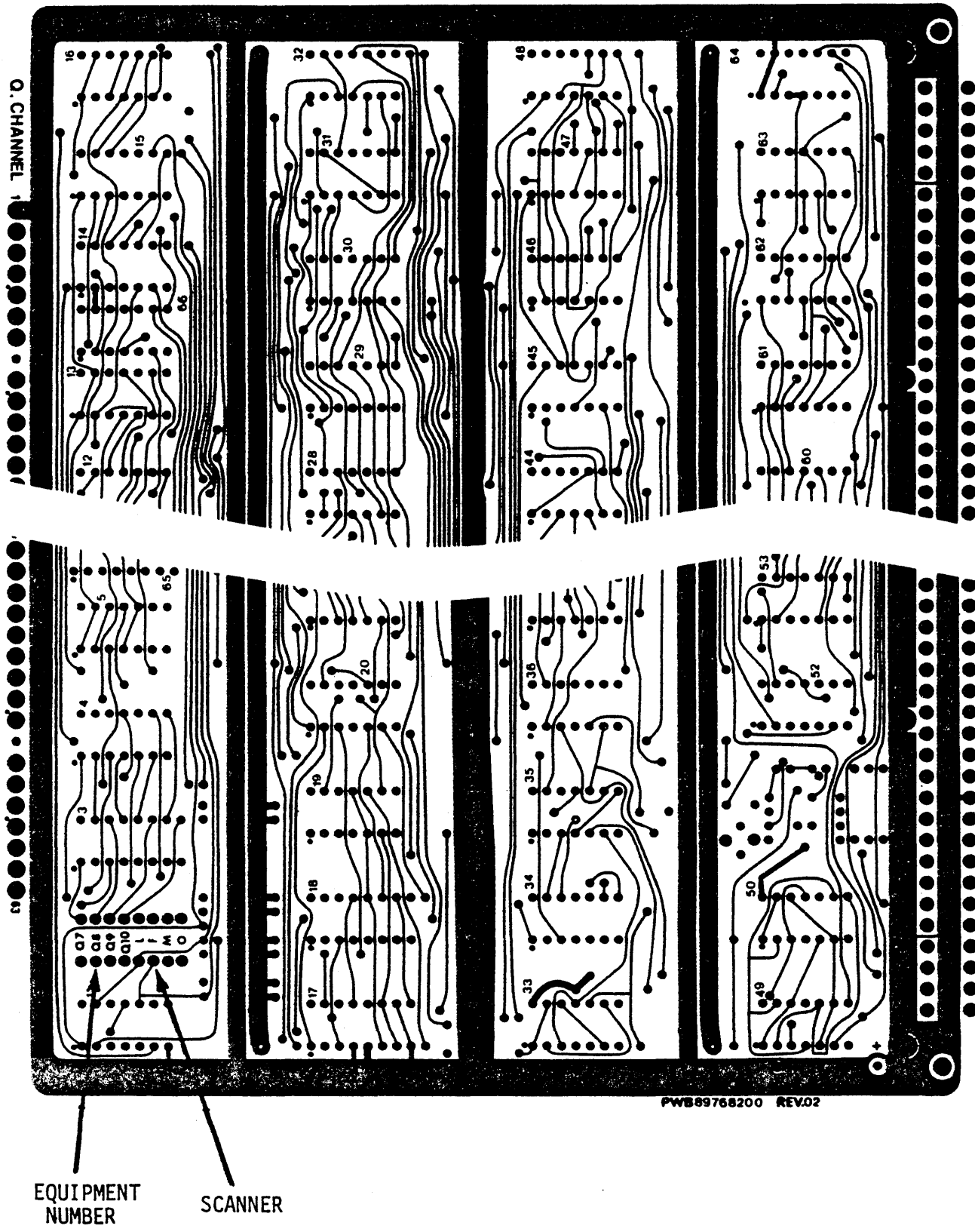

Figure 3-1. Q-Channel Showing Jumper Plug Positions

COMMENT SHEET

MANUAL TITLE CONTROL DATA 1732-3 Magnetic Tape Transport Controller
Hardware Reference Manual

PUBLICATION NO. 89769400 REVISION C

FROM: NAME: _____
BUSINESS ADDRESS: _____

COMMENTS:

This form is not intended to be used as an order blank. Your evaluation of this manual will be welcomed by Control Data Corporation. Any errors, suggested additions or deletions, or general comments may be made below. Please include page number references and fill in publication revision level as shown by the last entry on the Record of Revision page at the front of the manual. Customer engineers are urged to use the TAR.

CUT ALONG LINE

PRINTED IN U.S.A.

AA3419 REV. 11/69

NO POSTAGE STAMP NECESSARY IF MAILED IN U. S. A.

FOLD ON DOTTED LINES AND STAPLE

STAPLE

STAPLE

FOLD

FOLD



NO POSTAGE
NECESSARY
IF MAILED
IN THE
UNITED STATES

BUSINESS REPLY MAIL
FIRST CLASS PERMIT NO. 8241 MINNEAPOLIS, MINN.

POSTAGE WILL BE PAID BY

CONTROL DATA CORPORATION
PUBLICATIONS AND GRAPHICS DIVISION
4455 EASTGATE MALL
LA JOLLA, CALIFORNIA 92037



CUT ALONG LINE

FOLD

FOLD

CORPORATE HEADQUARTERS, P.O. BOX 0, MINNEAPOLIS, MINN. 55440
SALES OFFICES AND SERVICE CENTERS IN MAJOR CITIES THROUGHOUT THE WORLD

LITHO IN U.S.A.



CONTROL DATA CORPORATION