



Applied
Microsystems
Corporation



Time Stamp Module for ES 1800 Emulators: User's Manual Addendum



Applied
Microsystems
Corporation

Time Stamp Module for ES 1800 Emulators: User's Manual Addendum

P/N 923-00010-00

March 1988

Copyright © 1988 Applied Microsystems Corporation

All rights reserved.

SECTION 1

Table of Contents

Time Stamp Module

TIME STAMP MODULE	1-1
How To Use This Manual Addendum	1-1
Time Stamp Module Features	1-1
Possible Measurements	1-1
Using the Time Stamp Counter Value as a Condition	1-3
Installation	1-4
Hardware Installation	1-4
Software Installation	1-5
Using the Time Stamp Module	1-6
Getting Started	1-6
Steps for Using the Time Stamp Module	1-8
Step 1: Set ESL Soft-Switch 9	1-8
Step 2. Set Time Stamp Module Switch	1-9
Step 3. Set Up TGR Input	1-11
Step 4. Set up the Event Monitor System	1-11
Step 5. Run your Program	1-12
Step 6. View Time Stamp Information	1-12
Step 7. Interpret Time Stamp Information	1-12
Examples	1-14
Measuring Elapsed Time	1-14
A to B Mode	1-15
Range Mode	1-17
Interrupt Latency	1-20
Counting Occurrences	1-23
A to B Mode	1-23
Range Mode	1-26
Using the Time Stamp Counter Value as a Condition	1-28

TIME STAMP MODULE

How To Use This Manual Addendum

This addendum describes what the Time Stamp Module does, and how to install and use the module. Complete examples are provided for using the module to do each possible type of measurement.

Time Stamp Module Features

The Time Stamp Module adds performance analysis to the ES 1800 Series emulators for 16 bit microprocessors. You can use this module when you use your ES 1800 in stand-alone mode, or from your host computer, using ES Driver control software. There are two ways the module can be used:

1. To measure elapsed or absolute time.
2. To trigger the Event Monitor System to cause an action such as breaking emulation once a time stamp counter value is reached.

Possible Measurements

There are eight distinct measurements that can be made using the Time Stamp Module:

Elapsed Time Measurements

- Measure time spent in a module

- Measure time spent between modules
- Measure duration of time when memory is accessed (opcode or data)
- Measure duration of time when code is accessed (opcode only)
- Measure interrupt response time directly

Count Occurrences

- Count number of times address or range of memory is accessed (opcode or data)
- Count number of times code is accessed (opcode only)
- Count module linkage activity (the number of times one module calls another)

Each time measurement can be based on one of five scales: .1uS, 1uS, .01mS, .1mS or 1mS, so you can collect your data using the appropriate time scale. The maximum number of counts for any time base is 65,535 so you have a maximum period of 65 seconds without overflow.

Time can be measured on an absolute time frame, or on a relative time frame. When you use the absolute time frame, the measurement is from when the counter is reset. When you use the relative time frame, the measurement is from one traced cycle to the next traced cycle. For example, if you were measuring the elapsed time for entering and exiting a module, the time displays would show as follows:

	<i>Absolute</i>	<i>Relative</i>
enter	3000	3000†
exit	3005	5
enter	3007	2
exit	3012	5
enter	3014	2
exit	3019	5

† The first line on the relative trace screen shows the absolute count.

Using the Time Stamp Counter Value as a Condition

The ES 1800 Event Monitor System lets you specify complex program states, using WHEN-THEN statements:

WHEN *conditions* **THEN** *actions*

You can use the absolute value of the time stamp counter as one condition. For more details on using CTS, see the example on page 1-28.

Installation

Hardware Installation

The Time Stamp Module consists of the module and the cable to connect it to the emulator.

There are three steps to hardware installation:

1. Turn the emulator off.

CAUTION

The ES 1800 emulator must be off before plugging in the Time Stamp Module, or the cable and module may be damaged. Do not plug in or unplug the Time Stamp Module with power turned on.

2. Connect the module to the LSA port on the front of the ES 1800 emulator as shown in the following illustration. Note that you cannot use the Logic State Analysis pod and the Time Stamp Module at the same time.

Figure 1-1. Connecting the Time Stamp Module to the ES 1800

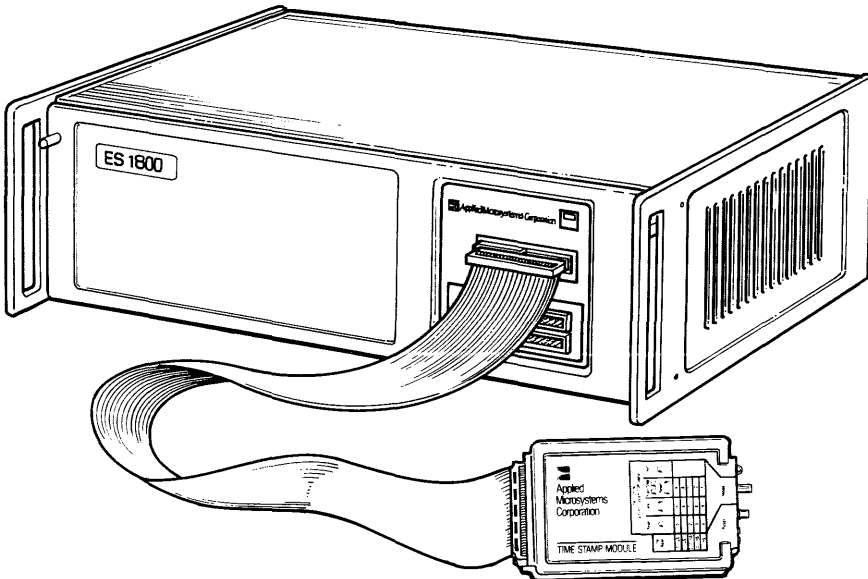

3. The Time Stamp Module requires a certain revision of ESL (the Emulator Standard Language). To check your revision:

from stand-alone mode Type **REV** from the ES 1800 prompt.

from ES Driver Enter the Target Emulation menu, and type **REV** from the ES 1800 prompt.

If you have an ESL equal to or greater than that shown in the chart below, you can use your Time Stamp Module as is. If your ESL is below the revision shown below, please contact your local sales office or representative, or call the Order Administration department at 1-800-426-3925 for information on upgrading your ESL revision.

<i>Product</i>	<i>Minimum Revision Level</i>
68000	ESL 3.3
68010	ESL 2.5
Z8000	ESL 3.1
80286	ESL 2.1
808x/18x	ESL 3.2
808X Genesis	ESL 3.2G

Software Installation

No software changes are required to operate the Time Stamp Module for any of the following software packages available from Applied Microsystems Corporation.

- ES Driver
- VALIDATE/XEL
- VALIDATE/Soft-Scope
- GeneProbe

Using the Time Stamp Module

This section explains the meaning of the labels, buttons, switches and LEDs on the Time Stamp Module, and then provides complete information on how the unit works.

Figure 1-2. Time Stamp Module

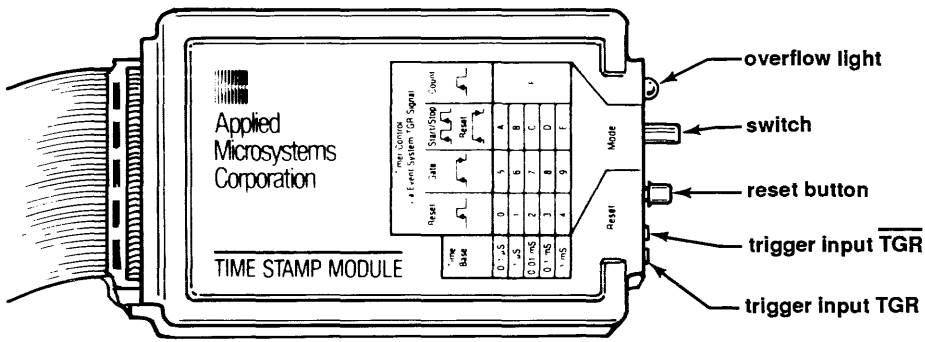

Getting Started

Look at the end of your Time Stamp Module and identify the trigger inputs, reset button, switch and overflow indicator LED as shown in the following diagram.

Figure 1-3. End View of Time Stamp Module

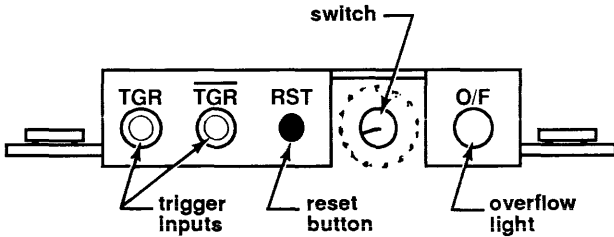

- TGR The TGR input is used to measure interrupt latency directly. You connect the TGR input directly to the interrupt line in your target circuit, avoiding any logic delays due to use of the Event Monitor System. It is designed for processors that pull lines low for interrupts. (Motorola and Zilog processors) (see page 1-20)
- $\overline{\text{TGR}}$ The $\overline{\text{TGR}}$ input is used to measure interrupt latency directly. You connect the $\overline{\text{TGR}}$ input directly to the interrupt line in your target circuit, avoiding any logic delays due to use of the Event Monitor System. It is designed for processors that pull lines high for interrupts. (Intel processors) (see page 1-20)
- RST The reset button is used to reset the time stamp counter to 0.
- Switch The switch is used to determine the time base and the type of counting done. (see page 1-9)
- O/F The overflow LED is lit when the counter overflows the 65,535 limit.

The examples of each type of measurement give complete information on when to use the manual reset button, TGR and $\overline{\text{TGR}}$, and how to use the switch to choose the time stamp mode and time base.

CAUTION

Do not plug in or unplug the Time Stamp Module when power is turned on to the emulator.

Steps for Using the Time Stamp Module

In order to make a measurement, there are seven steps you must follow:

1. Set the ESL soft-switch 9 to the appropriate position for the measurement you want to make.
2. Choose a switch setting on the Time Stamp Module.
3. Set up your trigger inputs.
4. Set up the Event Monitor System to trigger the Time Stamp Module at the appropriate program states.
5. Run your program.
6. View the time stamp information.
7. Interpret the time stamp information.

Each step is described in detail below.

Step 1: Set ESL Soft-Switch 9

ESL soft-switch 9 controls the LSA display of information coming in on the LSA port. Settings 1 and 2 are used with the Time Stamp Module. Setting 0 is used when you use the LSA pod.

- 0 Default: LSA value shown as 16 bits
- 1 Display the absolute time value
- 2 Display the relative time value

Absolute time values are used when you want to measure the total amount of time spent or the number of occurrences. Relative time values are used when you are interested in the time spent between points A and B in your code, but are not interested in how long it takes to get to point A.

To get to ESL soft-switch 9:

from stand-alone mode

Type **SET 9, n**, where *n* is 0, 1 or 2.

from ES Driver

Select Target Emulation mode, and type **SET 9, n**, where *n* is 0, 1 or 2.

Step 2. Set Time Stamp Module Switch

Choose a switch setting on your Time Stamp Module based on your measurement type and preferred time base. We recommend starting with the slowest time frame: 1 mS. The table below shows the maximum measurable time period for each switch setting.

<i>Time Base</i>	<i>Maximum Measurable Time Period</i>
0.1 uS	6.5 milliseconds
1.0 uS	65 milliseconds
.01 mS	.65 second
0.1 mS	6.5 seconds
1.0 mS	65 seconds

IMPORTANT

If the counter overflows, the yellow overflow LED will be lit. Check to see if you are using the correct time base for the duration of your measurements. When the counter overflows the 65,355 limit, it starts again at 0.

When the emulator is paused, no TGR is generated by the Event Monitor System in positions 0-4, so the counter is not reset and is likely to overflow. This is not a problem.

For example, the DRT display might be as follows. The highlighted counter value in the last line of the example shows the counter overflow.

LINE	ADDRESS	DATA	R/W	M/IO	BCYC	QUE	ABS TIME
#20	000344	> E2FD	R	TAR	M	IF 2	#63590
#19	000346	> 80F9	R	TAR	M	IF 2	#64592
#18	000342	> 754B	R	TAR	M	IF F 3	#65032
#17	000344	> E2FD	R	TAR	M	IF 2	#01222

Time Stamp Module User's Manual Addendum

The following table summarizes the switch positions.

The trigger to start and stop the counter in the Time Stamp Module is either the TGR signal from the Event Monitor System (Step 4), or the TGR or $\overline{\text{TGR}}$ direct input from your target interrupt line (Step 3).

<i>Position</i>	<i>Time Base</i>	<i>Effect of TGR on Time Stamp Counter</i>	<i>Useful Measurements</i>
0 1 2 3 4	.1 μS 1 μS .01 mS .1 mS 1 mS	Any TGR high causes the time stamp counter to be reset to 0. No manual reset is required in this mode for either absolute or relative time stamping.	Elapsed time
5 6 7 8 9	.1 μS 1 μS .01 mS .1 mS 1 mS	While the TGR is held high by the Event Monitor System, the time stamp counter counts. Manual reset is required in this mode for absolute time stamping, but not for relative time stamping.	Elapsed time
A B C D E	.1 μS 1 μS .01 mS .1 mS 1 mS	In this mode, a long TGR signal ¹ from the Event Monitor System resets the counter. After that, successive short TGR signals turn the counter on and off. Manual reset stops the counter and sets it to zero.	Elapsed time
F	n.a.	This setting is used to count occurrences. Each time the TGR signal goes high, the time stamp counter is incremented. Manual reset is required.	Count occurrences

¹ A long TGR is defined as being longer than 1.6 μS . This is the only mode where the length of the TGR matters. The following diagram shows what happens to the counter depending on the TGR signal.

Figure 1-4. Positions A-E: Effects of Multiple TGR Signals

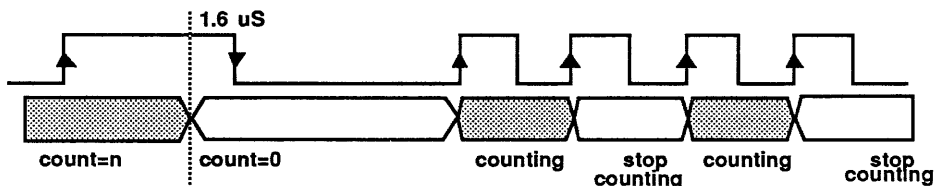

Step 3. Set Up TGR Input

The counter in the Time Stamp Module can be controlled in one of three ways:

1. The Event Monitor System TGR action.
2. The TGR input.
3. The $\overline{\text{TGR}}$ input.

The default is the Event Monitor System trigger input. No additional wires are necessary.

To use the TGR and $\overline{\text{TGR}}$ lines to measure interrupt latency, you must connect one of these lines to an interrupt line on your target. Use of the TGR and $\overline{\text{TGR}}$ external inputs is described fully in the example on page 1-20.

Step 4. Set up the Event Monitor System

In this step, you set up the Event Monitor System to selectively trace the memory, program activity, or modules you are interested in time stamping. Setting up the Event Monitor System can be done through ESL or through the Target Emulation menu in ES Driver.

There are three steps to setting up the Event Monitor System:

1. Decide what condition you want to look at, and what actions to take when that condition is reached.
2. Set up the comparators to isolate that condition.
3. Set up WHEN/THEN statements using the appropriate conditions and actions.

For more information on using the Event Monitor System, please see section 7 in your ES 1800 manual. The examples beginning on page 1-14 of this addendum provide examples of using the Event Monitor System to specify conditions appropriate for time stamping.

Step 5. Run your Program

from stand-alone mode Run the program using the **RUN** command, or run to a breakpoint using **RBK**.

from ES Driver Select the Target Emulation menu, and the Run or Run-to-Breakpoint command.

Step 6. View Time Stamp Information

There are several ways to display the time stamp information.

from stand-alone mode The first step is to display the trace by either:

- stopping emulation with the **STP** command
- using the Event Monitor System to break emulation
- if you have Dynamic Trace available, you can use the **OFF TCE** command to view the trace while your program is still running

Then view the trace, using the **DRT** command. The last column shows the absolute or relative time stamp, depending on the position you specified with the **SET** command.

from ES Driver Enter the Target Emulation menu, and do the same commands as listed in stand-alone mode.

Step 7. Interpret Time Stamp Information

The time stamp information is always given as a number of units: the units are the ones you specify when you set the switch on the Time Stamp Module.

IMPORTANT

You must multiply this number by the time base you selected on the Time Stamp Module switch in order to determine the elapsed time in seconds.

Collecting Time Stamp Information in a File

After setting up your Event Monitor System and Time Stamp Module to provide just the information you need, you can use ES Driver to save the specific DRT displays to an ASCII file. Once the information is stored in the file, you can use a spreadsheet or data base management program to analyze the data.

While in Target Emulation mode,

1. Press <F3> to open a file to save the session record in. You will be prompted to enter a file name. The default extension for this file is .rec.
2. Run the DRT command to print the trace. It will appear on the screen, and also be stored in the file. Note the prompt on the bottom of the screen "SAVE *file.rec* <F8>=close."
3. Press <F8> to close the session record file.

Examples

There are two basic measurement modes: Elapsed Time and Counting Occurrences. The examples are organized as follows:

Measuring elapsed time

- measuring the time it takes to go from event A to event B
- measuring the time the program is in the specified range
- measuring the time between an interrupt and interrupt servicing

Counting occurrences

- counting the number of times the program transitions from event A to event B
- counting the number of accesses to a memory location or range

Measuring Elapsed Time

The elapsed time measurement can be used to measure in-module time, out-of-module time, inter-module time, and memory and program access time. These measurements use switch positions 0 to E.

Conceptually, there are three types of elapsed time measurements:

1. Measuring the time from event "A" to event "B"
 - used for measuring program time, out-of-module execution time, and inter-module execution time
2. Measuring the time spent in an address range
 - used for measuring memory time and program time (excluding calls to other modules)
3. Measuring the time between an interrupt and interrupt servicing
 - used for measuring interrupt latency

A to B Mode

To measure the time it takes a program to get from event "A" to event "B," the easiest way is to set up the Event Monitor System so only event "B" appears in the trace display.

Step 1. Set LSA Display Type

SET 9, 1 Set display format to absolute time stamp

Step 2. Select Time Stamp Module Switch Setting

Use positions 0-4, depending on your preferred time base. In positions 0-4, the TGR from the Event Monitor System resets the time stamp counter to 0.

If you're not sure which time base to use, use position 4 for the slowest. If the counter overflows, the yellow overflow LED will light. See page 1-9 for a chart of maximum time periods per setting.

Step 3. Set up the Trigger Input

To measure elapsed time, use the Event System Trigger input.

Step 4. Set up the Event Monitor System

AC1 = 'a	Specify address comparator 1 in group 1 to be event A
AC2 = 'b	Specify address comparator 2 in group 1 to be event B
WHEN AC1 THEN TGR	The TGR action resets the time stamp counter to 0 at event A
WHEN AC2 THEN TRC	Trace event B

Step 5. Run your Program

from stand-alone mode	RUN	Run program
from ES Driver	Target Emulation Menu	Run

Step 6. View Time Stamp Data

from stand-alone mode	DRT	Display the trace
from ES Driver	Trace Menu:	Display the trace

Step 7. Interpret Time Stamp Information

The last column of the trace display gives you the absolute time stamp information. Note that if event A and B are called more than once, you will get the time between events for each occurrence.

IMPORTANT

You must multiply this number by the time base you selected on the Time Stamp Module switch in order to determine the elapsed time in seconds.

The following screen shows the raw trace display. Since the Time Stamp Module switch was set to position #1 (1 uSec), the time to go from A to B is shown to vary from 29 uSec to 39 uSec.

Figure 1-5. Sample DRT Screen for Measuring Time from A to B

```

>DRT
  LINE   ADDRESS   DATA  R/W    FC    IPL  ABS TIME
#20     001100>   4E71  R    OVL  SP    0    #35
#19     001100>   4E71  R    OVL  SP    0    #32
#18     001100>   4E71  R    OVL  SP    0    #30
#17     001100>   4E71  R    OVL  SP    0    #30
#16     001100>   4E71  R    OVL  SP    0    #29
#15     001100>   4E71  R    OVL  SP    0    #30
#14     001100>   4E71  R    OVL  SP    0    #30
#13     001100>   4E71  R    OVL  SP    0    #31
#12     001100>   4E71  R    OVL  SP    0    #30
#11     001100>   4E71  R    OVL  SP    0    #38
#10     001100>   4E71  R    OVL  SP    0    #31
#9      001100>   4E71  R    OVL  SP    0    #34
#8      001100>   4E71  R    OVL  SP    0    #34
#7      001100>   4E71  R    OVL  SP    0    #36
#6      001100>   4E71  R    OVL  SP    0    #32
#5      001100>   4E71  R    OVL  SP    0    #30
#4      001100>   4E71  R    OVL  SP    0    #31
#3      001100>   4E71  R    OVL  SP    0    #39
#2      001100>   4E71  R    OVL  SP    0    #34
#1      001100>   4E71  R    OVL  SP    0    #30
#0      BREAK
  
```

Range Mode

In range mode, the trace display will show the amount of time the program is in the specified range.

The manual reset button should be pressed prior to performing this measurement.

Step 1. Set LSA Display Type

SET 9, 1 Set display format to absolute time stamp

Step 2. Select Time Stamp Module Switch Setting

Use positions 5-9, depending on your preferred time base. In these positions, the Event Monitor System TGR enables the counter.

If you're not sure which time base to use, use position 9 for the slowest. If the counter overflows, the yellow overflow LED will light. See page 1-9 for a chart of maximum time periods per setting.

Step 3. Set up the Trigger Input

To measure elapsed time, use the Event System Trigger input.

Step 4. Set up the Event Monitor System

AC1 = 'range Specify address comparator 1 in group 1 to be the specified address range

AC1.2 = 'range Specify address comparator 1 in group 2 to be the specified address range

WHEN AC1 THEN TGR,GRO2
While the range is being accessed, enable the counter and go to group 2

WHEN AC1.2 OR NOT AC1.2 THEN TGR
Keep counter enabled while in group 2

WHEN NOT AC1.2 THEN GRO1
Disable counter when not accessing range

If you are tracing program flow rather than just memory access, the addresses need to be qualified with status. The following is an example for the 80186:

AC1 = 'range Specify address comparator 1 in group 1 to be the specified address range
S1 = COD Qualify access as program code
AC1.2 = 'range Specify address comparator 1 in group 2 to be the specified address range
S1.2 = COD Qualify access as program code
WHEN AC1 AND S1 THEN TGR,GRO2 While the range is being accessed, enable the counter and go to group 2
WHEN AC1.2 OR NOT AC1.2 THEN TGR Keep counter enabled while in group 2
WHEN S1.2 AND NOT AC1.2 THEN GRO1 Disable counter when not accessing range

Step 5. Run your Program

<i>from standalone mode</i>	RUN	Run program
<i>from ES Driver</i>	Target Emulation Menu	Run

Step 6. View Time Stamp Data

<i>from stand-alone mode</i>	DRT	Display the trace
<i>from ES Driver</i>	Trace Menu:	Display the trace

Step 7. Interpret Time Stamp Information

The last column of the trace display gives you the amount of time accumulated while the program was in the specified range.

IMPORTANT

You must multiply this number by the time base you selected on the Time Stamp Module switch in order to determine the elapsed time in seconds.

The following screen shows the raw trace display, for the above example using a range of \$1100 to \$1110. Since the Time Stamp Module switch was set to position #5 (0.1 uSec), the time spent in this range was 13.2 uSec.

Figure 1-6. Sample DRT Screen for Measuring Time in Range

```

>DRT
LINE  ADDRESS  DATA  R/W      FC      IPL  ABS TIME
#20  001012>  4EB8  R      OVL  SP      0      #0
#19  001500      <04D7  W      OVL  SD0     0      #0
#18  001014>  1100  R      OVL  SP      0      #0
#17  001100>  4E71  R      OVL  SP      0      #0
#16  001102>  3410  R      OVL  SP      0      #10
#15  0016F8      <0000  W      OVL  SD      0      #23
#14  0016FA      <1016  W      OVL  SD      0      #36
#13  001104>  D440  R      OVL  SP      0      #40
#12  001500>  04D7  R      OVL  SD      0      #50
#11  001106>  3082  R      OVL  SP      0      #64
#10  001108>  4E75  R      OVL  SP      0      #77
#9   001500      <04DC  W      OVL  SD      0      #90
#8   00110A>  FFFF  R      OVL  SP      0      #103
#7   0016F8>  0000  R      OVL  SD      0      #116
#6   0016FA>  1016  R      OVL  SD      0      #129
#5   001016>  4E71  R      OVL  SP      0      #132
#4   001018>  60E6  R      OVL  SP      0      #132
#3   00101A>  FFFF  R      OVL  SP      B      0#132
#2   001000>  4E71  R      OVL  SP      B      0#132
#1   001002>  3038  R      OVL  SP      B      0#132
#0  BREAK

```

Interrupt Latency

To measure the amount of time between when an interrupt is detected and when it is serviced, you must connect your target interrupt line directly to the TGR or \overline{TGR} lines on the Time Stamp Module. As you can see in Figure 1-7, these lines perform exactly the same function as the Event Monitor System TGR signal, but the direct trigger bypasses the delays inherent in going through the additional Event Monitor System logic.

Figure 1-7. Trigger Input Logic

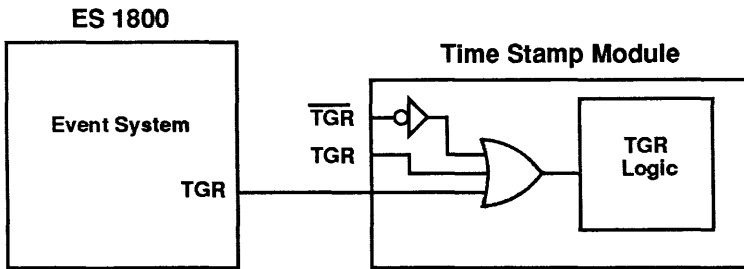

There are two external TGR inputs: TGR and \overline{TGR} . The external TGR is used with Motorola and Zilog processors: when the line is pulled low, the interrupt is asserted. The external \overline{TGR} is used with Intel processors: when the line is pulled high, the interrupt is asserted.

Figure 1-8 shows the trigger pattern for the TGR and \overline{TGR} inputs.

Figure 1-8. Trigger Pattern for TGR and \overline{TGR}

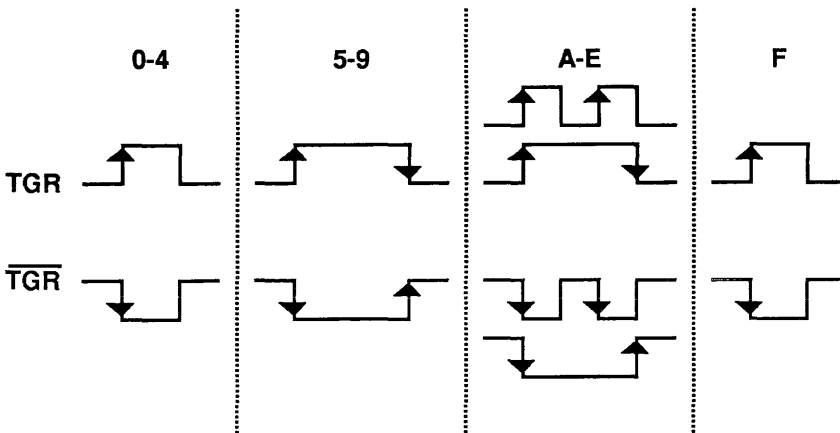

*Step 1. Set LSA Display Type***SET 9, 1**

Set display format to absolute time stamp

Step 2. Select Time Stamp Module Switch Setting

Use positions 0-4, depending on your preferred time base. In positions 0-4, the TGR from the external TGR, external $\overline{\text{TGR}}$ or Event Monitor System TGR resets the time stamp counter to 0.

If you're not sure which time base to use, use position 4 for the slowest. If the counter overflows, the yellow overflow LED will light. See page 1-9 for a chart of maximum time periods per setting.

Step 3. Set up the Trigger Input

Connect either the TGR or $\overline{\text{TGR}}$ input on the Time Stamp Module to the interrupt line on your target that you want to check. For example, to check the interrupt latency for interrupt INT0 on the 80186, use the setup shown in Figure 1-9.

Figure 1-9. Target Setup for Measuring Interrupt Latency

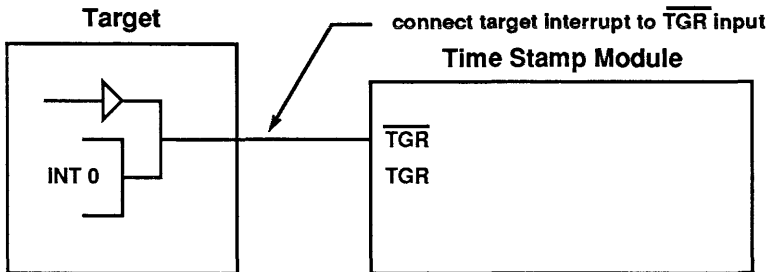

Step 4. Set up the Event Monitor System

- AC1 = 'intservice_start** Specify address comparator 1 in group 1 to be the start of the interrupt service routine
- WHEN AC1 THEN TRC** Start tracing at the beginning of the interrupt service routine

Step 5. Run your Program

- from standalone mode* **RUN** Run program
- from ES Driver* Target Emulation Menu Run

Step 6. View Time Stamp Data

- from stand-alone mode* **DRT** Display the trace
- from ES Driver* Trace Menu: Display the trace

Step 7. Interpret Time Stamp Information

The Event Monitor System traces the first cycle of the interrupt service routine. The last column of the the trace display shows the amount of time elapsed between the start of the interrupt service routine and the actual interrupt processing.

IMPORTANT

You must multiply this number by the time base you selected on the Time Stamp Module switch in order to determine the elapsed time in seconds.

Counting Occurrences

The number of occurrences measurement can be used to measure memory and program activity, module linkage activity and program flow activity. Use switch position F (count TGR pulses) for all counting measurements.

Conceptually, there are two types of counting occurrences measurements:

1. Counting the number of times the program transitions from event "A" to event "B"
 - used for measuring module linkage activity
2. Counting the number of accesses to some memory location(s).
 - used for measuring memory program activity

A to B Mode

This mode records the number of times the transition from event "A" to event "B" occurs. Trace is only recorded on exit from module A. The manual reset button should be pressed prior to performing this measurement.

Step 1. Set LSA Display Type

SET 9, 1

Set display format to absolute time stamp

Step 2. Select Time Stamp Module Switch Setting

Use position F. For counting occurrences, the time base is irrelevant. In position F, when the TGR from the Event Monitor System goes high, the time stamp counter increments.

Step 3. Set up the Trigger Input

To count occurrences, use the Event System Trigger input.

Step 4. Set up the Event Monitor System

- AC1.1 = 'start-a** Specify address comparator 1 in group 1 to be the start of module A
- AC1.2 = 'start-b** Specify address comparator 1 in group 2 to be the start of module B
- AC2.2 = 'end-a** Specify address comparator 2 in group 2 to be the end of module A

- WHEN AC1 THEN GRO2** Go to group 2 while in module A
- WHEN AC1.2 THEN TGR** Increment counter when entering module B from module A

- WHEN AC2.2 THEN TRC, GRO1** Exit module A, record count in trace memory

Step 5. Run your Program

- from stand-alone mode* **RUN** Run program
- from ES Driver* Target Emulation Menu Run

Step 6. View Time Stamp Data

- from stand-alone mode* **DRT** Display the trace
- from ES Driver* Trace Menu: Display the trace

Step 7. Interpret Time Stamp Information

The last column gives you the number of times module B was entered from module A. Note that only the location end-a is traced. In the following screen we see that module B is called once each time from module A. The total number of calls is 145.

Figure 1-10. Sample DRT Screen for Counting Occurrences

```
>DRT
```

LINE	ADDRESS	DATA	R/W	FC	IPL	ABS TIME
#20	001108>	4E75	R	OVL SP	0	#126
#19	001108>	4E75	R	OVL SP	0	#127
#18	001108>	4E75	R	OVL SP	0	#128
#17	001108>	4E75	R	OVL SP	0	#129
#16	001108>	4E75	R	OVL SP	0	#130
#15	001108>	4E75	R	OVL SP	0	#131
#14	001108>	4E75	R	OVL SP	0	#132
#13	001108>	4E75	R	OVL SP	0	#133
#12	001108>	4E75	R	OVL SP	0	#134
#11	001108>	4E75	R	OVL SP	0	#135
#10	001108>	4E75	R	OVL SP	0	#136
#9	001108>	4E75	R	OVL SP	0	#137
#8	001108>	4E75	R	OVL SP	0	#138
#7	001108>	4E75	R	OVL SP	0	#139
#6	001108>	4E75	R	OVL SP	0	#140
#5	001108>	4E75	R	OVL SP	0	#141
#4	001108>	4E75	R	OVL SP	0	#142
#3	001108>	4E75	R	OVL SP	0	#143
#2	001108>	4E75	R	OVL SP	0	#144
#1	001108>	4E75	R	OVL SP	0	#145
#0	BREAK					

Range Mode

This mode records the number of accesses to some memory location(s). Trace is always recorded. The last trace cycles recorded show the accumulated access counts. The manual reset button should be pressed prior to performing this measurement.

Step 1. Set LSA Display Type

SET 9, 1 Set display format to absolute time stamp

Step 2. Select Time Stamp Module Switch Setting

Use position F. For counting occurrences, the time base is irrelevant. In this position, when the TGR from the Event Monitor System goes high, the time stamp counter increments.

Step 3. Set up the Trigger Input

To count accesses, use the Event System Trigger input.

Step 4. Set up the Event Monitor System

AC1.1 = 'here TO 'there Specify the range to be monitored
WHEN AC1 THEN TGR Increment counter whenever range is accessed

Step 5. Run your Program

from stand-alone mode **RUN** Run program
from ES Driver Target Emulation Menu Run

Step 6. View Time Stamp Data

from stand-alone mode **DRT** Display the trace
from ES Driver Trace Menu Display the trace

Step 7. Interpret Time Stamp Information

The last column of the last line of the trace display gives you the number of times the range was accessed. In the following sample screen, the range is set from \$1400 to \$1500.

Figure 1-11. Sample DRT Screen Counting Occurrences in a Range

```

>DRT
LINE ADDRESS DATA R/W FC IPL ABS TIME
#20 001104> D440 R OVL SP 0 #29668
#19 001500> 04D7 R OVL SD 0 #29668
#18 001106> 3082 R OVL SP 0 #29669
#17 001108> 4E75 R OVL SP 0 #29669
#16 001500 <04DC W OVL SD 0 #29669
#15 00110A> FFFF R OVL SP 0 #29670
#14 0016FC> 0000 R OVL SD 0 #29670
#13 0016FE> 1016 R OVL SD 0 #29670
#12 001016> 4E71 R OVL SP 0 #29670
#11 001018> 60E6 R OVL SP 0 #29670
#10 00101A> FFFF R OVL SP 0 #29670
#9 001000> 4E71 R OVL SP 0 #29670
#8 001002> 3038 R OVL SP 0 #29670
#7 001004> 1400 R OVL SP 0 #29670
#6 001006> 3200 R OVL SP 0 #29670
#5 001400> 0005 R OVL SD 0 #29670
#4 001008> 0641 R OVL SP 0 #29671
#3 00100A> 04D2 R OVL SP 0 #29671
#2 00100C> 307C R OVL SP 0 #29671
#1 00100E> 1500 R OVL SP 0 #29671
#0 BREAK

```

Using the Time Stamp Counter Value as a Condition

The ES 1800 Event Monitor System lets you specify complex program states, using WHEN-THEN statements:

WHEN *conditions* **THEN** *actions*

You can use the absolute value of the time stamp counter as one condition.

Conditions are defined as logical combinations of address, data and status comparators. The comparator LSA reads the value of the time stamp counter.

Due to the sequencing of the bit information from the Time Stamp Module, the count value needs to be converted to the same format used by the ES 1800, using the CTS (convert time stamp)command.

Sample Situation:

Suppose you want to break 2 seconds after reaching a specified address. If the pod is set to the 1 millisecond setting, this is 2000 counts. It would make sense to say 'LSA=#2000' as the Event Monitor System condition, but as we've explained above, this value must be converted.

Step 1. Set LSA Display Type

SET 9, 1 Set display format to absolute time stamp

Step 2. Select Time Stamp Module Switch Setting

Use position 4 to count every millisecond. In this position, the TGR from the Event Monitor System resets the counter.

Step 3. Set up the Trigger Input

To measure elapsed time, use the Event System Trigger input.

Step 4. Convert Value

CTS #2000 Convert time stamp value for ES 1800. The ES 1800 responds with \$0438. This is the value the LSA port actually sees when the pod has counted 2000 times

Step 5. Set up the Event Monitor System

AC1 = address to reset counter Specify the address at which to reset the counter

WHEN AC1 THEN TGR,GRO 2 Reset counter and switch to group 2 when AC1 is reached

LSA.2=\$0438 Specify the converted time stamp value to break at

2 WHEN LSA THEN BRK Break when counter value is reached.

IMPORTANT

The ES 1800 Event Monitor System samples address, data and status once every processor bus cycle. If the time base is shorter than the bus cycle, then a particular LSA value may be missed by the Event Monitor System.

For most processor systems, a time base of 0.01 mS, 0.1 mS or 1 mS is slow enough to prevent this problem.

Step 6. View Time Stamp Data

<i>from stand-alone mode</i>	DRT	Display the trace
<i>from ES Driver</i>	Trace Menu	Display the trace

Step 7. Interpret Time Stamp Information

The last column of the last line of the trace display gives you the number of times the range was accessed.

In the following sample screen, the LSA register was set to break at #2000 (CTS #2000 is converted to \$0438).

Figure 1-12. Sample DRT Screen After Breaking at Time Stamp Counter Value

LINE	ADDRESS	DATA	R/W	FC	IPL	ABS TIME
#20	001016>	4E71	R	OVL SP	0	#1999
#19	001018>	60E6	R	OVL SP	0	#1999
#18	00101A>	FFFF	R	OVL SP	0	#1999
#17	001000>	4E71	R	OVL SP	0	#1999
#16	001002>	3038	R	OVL SP	0	#1999
#15	001004>	1400	R	OVL SP	0	#1999
#14	001006>	3200	R	OVL SP	0	#1999
#13	001400>	0005	R	OVL SD	0	#1999
#12	001008>	0641	R	OVL SP	0	#1999
#11	00100A>	04D2	R	OVL SP	0	#1999
#10	00100C>	307C	R	OVL SP	0	#1999
#9	00100E>	1500	R	OVL SP	0	#1999
#8	001010>	3081	R	OVL SP	0	#1999
#7	001012>	4EB8	R	OVL SP	0	#2000
#6	001500	<04D7	W	OVL SD B	0	#2000
#5	001014>	1100	R	OVL SP B	0	#2000
#4	001100>	4E71	R	OVL SP B	0	#2000
#3	001102>	3410	R	OVL SP B	0	#2000
#2	0016FC	<0000	W	OVL SD B	0	#2000
#1	0016FE	<1016	W	OVL SD B	0	#2000
#0	BREAK					

INDEX

- A -

Absolute time, 1-2

- B -

Break emulation, 1-28

- C -

Count occurrences

 A to B, 1-23

 code access, 1-2

 memory access, 1-1

 memory and program activity, 1-23

 module linkage activity, 1-2, 1-23

 program flow activity, 1-23

 range, 1-26

Counter overflow, 1-9

- E -

Elapsed time, 1-1

 A to B, 1-14, 1-15

 between module time, 1-1

 code access, 1-1

 in range, 1-14, 1-17

 in-module time, 1-1

 inter-module, 1-14

 memory access, 1-1

 memory time, 1-14

 out-of-module, 1-14

 program time, 1-14

 units, 1-12

ESL revisions, 1-5

Event monitor system

 setup, 1-11

 speed, 1-29

Examples, 1-14

- F -

Features, 1-1

File,

 collecting time stamp info, 1-13

Time Stamp Module User's Manual Addendum

- I -

Installation, 1-4
 hardware, 1-4
 software, 1-5
Interrupt latency, 1-20

- L -

Logic state analysis pod, 1-4

- O -

Overflow LED, counter, 1-9

- P -

Performance analysis
 collecting data, 1-13

- R -

Relative time, 1-2
Reset button, 1-6
Run program, 1-12

- S -

SET command, 1-8
Summary,
 switch settings, 1-10
Switch positions, 1-10
Switch setting: ESL, 1-8

- T -

TGR
 choose input, 1-11
 Event Monitor System, 1-10
 external, 1-7, 1-10
Time base
 maximum, 1-2
 switch, 1-9
Time period
 maximum, 1-9
Time stamp module
 label, 1-6
Time units, 1-12
 reset button, 1-6

- U -

Units, 1-12

- V -

View time stamp information, 1-12



Applied Microsystems Corporation

5020 148th Ave. N.E.
P.O. Box 97002
Redmond, WA 98073-9702

(206) 882-2000
1-800-426-3925
TRT TELEX 185196
FAX (206) 883-3049

Applied Microsystems Corporation maintains a worldwide network of Direct Sales Offices and Representative Organizations committed to quality service and support. For the address and phone number of the Applied Microsystems Corporation Sales Office nearest you, call 1-800-426-3925 (in WA, call 206-882-2000).

Applied Microsystems' products are available throughout Europe. For the address and phone number of your nearest distributor, contact: Applied Microsystems Corporation, Ltd. Chiltern Court, High Street, Wendover, Aylesbury, Bucks, HP22 6EP, England. Tel 44(0) 296-625462

P/N 923-00010-00
March 1988