

AMPEX

Ampex Corporation · One of The Signal Companies 

AMPEX 210 VIDEO DISPLAY TERMINAL OPERATION MANUAL

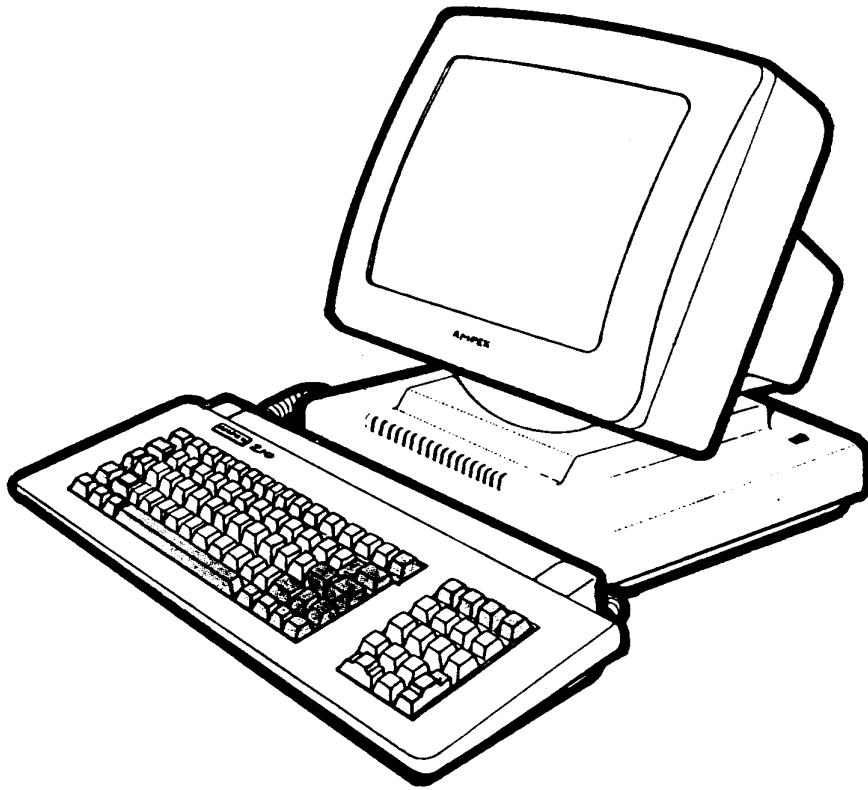

3515196

APRIL 1984

AMPEX

Ampex Corporation • One of The Signal Companies 

AMPEX 210 VIDEO DISPLAY TERMINAL OPERATION MANUAL

3515196

APRIL 1984

DISCLAIMER

AMPEX CORPORATION MAKES NO REPRESENTATION OR WARRANTIES WITH RESPECT TO THE CONTENTS OF THIS MANUAL AND DISCLAIMS ANY IMPLIED WARRANTIES OR FITNESS FOR ANY PARTICULAR APPLICATION. AMPEX CORPORATION RESERVES THE RIGHT TO REVISE THIS MANUAL WITHOUT OBLIGATION OF AMPEX CORPORATION TO NOTIFY ANY PERSON OR ORGANIZATION OF SUCH REVISION.

COPYRIGHT NOTICE

COPYRIGHT 1984 BY AMPEX CORPORATION. ALL RIGHTS RESERVED WORLDWIDE. NO PART OF THIS PUBLICATION MAY BE REPRODUCED WITHOUT THE EXPRESS WRITTEN PERMISSION OF AMPEX CORPORATION.

WARNING

THIS EQUIPMENT GENERATES, USES, AND CAN RADIATE RADIO FREQUENCY ENERGY AND IF NOT INSTALLED AND USED IN ACCORDANCE WITH THE INSTRUCTIONS IN THIS BOOK, MAY CAUSE INTERFERENCE TO RADIO COMMUNICATIONS. IT HAS BEEN TESTED AND FOUND TO COMPLY WITH THE LIMITS FOR A CLASS A COMPUTING DEVICE PURSUANT TO SUBPART J OF PART 15 OF FCC RULES, WHICH ARE DESIGNED TO PROVIDE REASONABLE PROTECTION AGAINST SUCH INTERFERENCE WHEN OPERATED IN A COMMERCIAL ENVIRONMENT. OPERATION OF THIS EQUIPMENT IN A RESIDENTIAL AREA IS LIKELY TO CAUSE INTERFERENCE IN WHICH CASE THE USER AT HIS OWN EXPENSE WILL BE REQUIRED TO TAKE WHATEVER MEASURES MAY BE REQUIRED TO CORRECT THE INTERFERENCE.

SECOND EDITION: JUNE 1984**SAFETY WARNING**

Dangerous voltages are present when the terminal is on, and may remain after the power is off. Use caution whenever connecting/disconnecting serial interfaces or cables to the Ampex 210 Video Display Terminal.

The internal phosphor of the cathode ray tube is toxic. Use extreme caution whenever the protective housing is removed and the tube is exposed. If the tube breaks, exposing skin or eyes to the phosphor, rinse the affected area with cold water and consult a physician.

The terminal power cable is supplied with a safety ground. Do not use the terminal with an ungrounded outlet.

Do not connect or disconnect the keyboard cable when the power is on; doing so may result in damage to the terminal that is not covered under the warranty.

DISCLAIMER

Ampex Corporation makes no representation or warranties with respect to the contents of this manual and disclaims any implied warranties or fitness for any particular application. Ampex Corporation reserves the right to revise this manual without obligation of Ampex Corporation to notify any person or organization of such revision.

COPYRIGHT NOTICE

Copyright 1984 by Ampex Corporation. All rights reserved worldwide. No part of this publication may be reproduced without the express written consent of Ampex Corporation.

WARNING

This equipment generates, uses, and can radiate radio frequency energy and if not installed and used in accordance with the instructions provided in this manual, may cause interference to radio communications. It has been tested and found to comply with the limits for a Class A computing device pursuant to Subpart J of Part 15 of FCC Rules, which are designed to provide reasonable protection against such interference when operated in a commercial environment. Operation of this equipment in a residential area is likely to cause interference in which case the user, at the user's expense, will be required to take whatever measures required to correct the interference.

SERVICE AND ASSISTANCE

Ampex Corporation provides a comprehensive post sales service and support program for the Ampex 210 product line. This service program is structured to provide immediate access to support assistance and information.

Customer commitment is maintained through the expertise and skills of a competent, professional staff whose dedication assures all Ampex 210 customers the maximum benefits of quality support.

Limited Warranty

Ampex Corporation warrants products sold to the buyer against defects in material or workmanship.

To obtain warranty and arrange for factory repair, refer to the Warranty documentation and Registration Card (3515020-01 and 3514020-02, respectively) enclosed with each Ampex 210 Video Display Terminal.

Technical Assistance

Technical assistance may be obtained through the Customer Service Department, Terminals, within the Computer Products Division of Ampex Corporation. To obtain such assistance, call:

800-538-7838 (outside California)
800-524-2850 (within California, except 415 area code)
408-725-2069 (locations having 415 area code)

TABLE OF CONTENTS

Section	Paragraph	Page
I.	OVERVIEW	
1.1	Purpose And Scope	1-1
1.2	General Description	1-1
1.2.1	Physical Description	1-2
1.2.1.1	Keyboard	1-2
1.2.1.2	Display Unit	1-2
1.2.2	Display Terminal Features	1-2
1.2.3	Operating Modes	1-4
1.3	Emulation Capabilities	1-6
1.4	Specifications	1-6
II.	INSTALLATION	
2.1	Introduction	2-1
2.2	Primary Port Interface	2-1
2.3	Interface Jumper Option	2-2
2.4	Installation Requirements	2-2
2.4.1	Space Allocation	2-3
2.4.2	Input Power	2-4
2.4.3	AC Power Cord and Plug	2-6
2.4.4	Interface Cable Connections	2-6
2.4.5	Keyboard Cable Connection	2-6
2.5	Power-on and Reset	2-8
2.6	Self-Test	2-8
III.	SETTING UP	
3.1	Set-Up Mode	3-1
3.2	Entering Set-Up Mode	3-1
3.2.1	Viewing Status Lines	3-1
3.2.2	Modifying Parameters	3-1
3.2.2.1	Saving Individual Modifications	3-2
3.2.2.2	Saving Multiple Modifications	3-2
3.3	Exiting The Set-Up Mode	3-2
3.4	Status Line Display	3-3
3.4.1	Status Line 1	3-3
3.4.2	Status Line 2	3-5
3.4.3	Status Line 3	3-8
3.4.4	Status Line 4	3-10
3.4.5	Status Line 5	3-12

TABLE OF CONTENTS (Continued)

Section	Paragraph	Page
IV.	TERMINAL CONTROLS	
4.1	Display Unit Controls	4-1
	4.1.1 Power Switch	4-1
	4.1.2 Intensity Control Dial	4-1
4.2	Keyboard Controls	4-1
	4.2.1 Lock And Unlock.	4-1
	4.2.2 Character Set Group.	4-2
	4.2.3 Numeric Keypad Keys Group.	4-4
	4.2.4 Cursor Control Keys Group.	4-5
	4.2.4.1 BACK TAB Key.	4-5
	4.2.4.2 TAB Key	4-5
	4.2.4.3 BACK SPACE Key.	4-6
	4.2.4.4 HOME Key.	4-6
	4.2.4.5 RETURN Key.	4-6
	4.2.4.6 LINE FEED Key	4-7
	4.2.4.7 Key (Down Cursor).	4-7
	4.2.4.8 Key (Up Cursor).	4-8
	4.2.4.9 Key (Left Cursor).	4-8
	4.2.4.10 Key (Right Cursor)	4-8
	4.2.5 Edit Keys Group.	4-11
	4.2.5.1 SHIFT Key	4-12
	4.2.5.2 CAPS LOCK Key	4-12
	4.2.5.3 DELETE CHAR Key	4-13
	4.2.5.4 INSERT CHAR Key	4-13
	4.2.5.5 DELETE LINE Key	4-13
	4.2.5.6 INSERT LINE Key	4-14
	4.2.5.7 ERASE PAGE Key.	4-14
	4.2.5.8 ERASE LINE Key.	4-14
	4.2.6 Control Keys Group	4-15
	4.2.6.1 PRINT Key	4-15
	4.2.6.2 FUNCT Key	4-16
	4.2.6.3 CTRL Key.	4-16
	4.2.6.4 ESC Key	4-16
	4.2.6.5 LOC ESC Key	4-16
	4.2.6.6 CLEAR Key	4-17
	4.2.6.7 BREAK Key	4-17
	4.2.6.8 DEL Key	4-17
	4.2.6.9 SETUP Key	4-17
	4.2.6.10 SEND Key.	4-17
	4.2.6.11 NO SCRL Key	4-18

TABLE OF CONTENTS (Continued)

Section	Paragraph	Page
V.	OPERATION	
5.1	Introduction.	5-1
	5.1.1 Full Duplex Conversational Mode (FDX).	5-1
	5.1.2 Half Duplex Conversational Mode (HDX).	5-1
	5.1.3 Character Mode	5-1
	5.1.4 Block Mode	5-1
	5.1.5 Line Mode.	5-2
	5.1.6 Local Mode	5-2
	5.1.7 Write Protect and Protect Modes.	5-2
	5.1.7.1 Write Protect Mode.	5-2
	5.1.7.2 Protect Mode.	5-2
	5.1.8 Monitor Mode	5-2
5.2	Editing Modes	5-3
	5.2.1 Local Edit Mode.	5-3
	5.2.2 Duplex Edit Mode	5-3
	5.2.3 Edit Commands.	5-3
	5.2.3.1 Character Insert.	5-3
	5.2.3.2 Character Delete.	5-4
	5.2.3.3 Line Insert	5-4
	5.2.3.4 Line Delete	5-4
	5.2.3.5 Erase To End Of Line.	5-4
	5.2.3.6 Erase To End Of Screen.	5-5
5.3	Clear Functions	5-5
5.4	Send Commands	5-6
	5.4.1 Send Line Unprotected.	5-6
	5.4.2 Send Line All.	5-7
	5.4.3 Send Page Unprotected.	5-7
	5.4.4 Send Page All.	5-7
	5.4.5 Send Unprotected Message	5-7
	5.4.6 Send Entire Message.	5-8
	5.4.7 Terminator Character Selection	5-8
	5.4.7.1 Line Terminator	5-8
	5.4.7.2 Page Terminator	5-8
5.5	Tabulation.	5-9
	5.5.1 Tab Key.	5-9
	5.5.1.1 Protect Mode Off.	5-9
	5.5.1.2 Protect Mode On	5-9
	5.5.2 Back Tab	5-9
	5.5.2.1 Protect Mode Off.	5-9
	5.5.2.2 Protect Mode On	5-9
	5.5.3 Setting Tab Stops.	5-10
	5.5.4 Clearing Tab Stops	5-10
5.6	Function Key Mode	5-10
	5.6.1 Function Key Mode.	5-11
	5.6.2 Program Function Key Mode.	5-11
	5.6.3 "FUNCT" Key with Numeric Keypad Mode	5-11
	5.6.4 ADDS Regent 20/25 and Viewpoint Program Function Key Mode	5-12
5.7	Visual Attribute System	5-13
5.8	Setting The Time.	5-14

TABLE OF CONTENTS (Continued)

Section	Paragraph	Page
V.	OPERATION (Cont.)	
	5.9 Print Functions	5-14
	5.9.1 Page Print	5-15
	5.9.2 Transparent Print.	5-15
	5.9.3 Copy Print	5-15
	5.9.4 Bidirectional Printer Port	5-15
VI.	EMULATION MODES	
	6.1 Introduction.	6-1
	6.2 Emulation Modes	6-1
	6.2.1 ADDS Regent 20/25 Mode	6-1
	6.2.2 ADDS Viewpoint	6-1
	6.2.3 Hazeltine 1410 (1400) Mode	6-1
	6.2.4 Hazeltine 1500 Mode.	6-1
	6.2.5 Lear Siegler ADM5 Mode	6-2
	6.2.6 Qume QVT102 Mode	6-2
	6.2.7 TeleVideo 910 and 910+ Modes	6-2
	6.2.8 TeleVideo 920 Mode	6-2
	6.2.9 TeleVideo 925 Mode	6-2
	6.3 Emulation Mode Operating Parameters and Escape Sequences.	6-3
APPENDIX A	Escape Sequences and Control Codes.	A-1
APPENDIX B	ASCII Code Chart.	B-1
APPENDIX C	Line Graphic Symbols.	C-1
APPENDIX D	National Character Sets	D-1
APPENDIX E	Cursor Addresses.	E-1
APPENDIX F	Monitor Mode Facsimile Symbols.	F-1
APPENDIX G	Simplified Troubleshooting Guide.	G-1
APPENDIX H	Operator's Questionnaire.	H-1

LIST OF ILLUSTRATIONS

Figure	Title	Page
1-1	Ampex 210 Video Display Terminal	1-1
2-1	Overall Dimensions	2-3
2-2	Voltage Strapping Plug (Version 1 and Version 2)	2-5
2-3	Ampex 210 Video Display Terminal (Back Panel View)	2-7
2-4	Keyboard Port on Display Terminal.	2-7
3-1	Status Line 1.	3-3
3-2	Status Line 2.	3-5
3-3	Status Line 3.	3-8
3-4	Status Line 4.	3-10
3-5	Status Line 5.	3-12

LIST OF ILLUSTRATIONS (Cont.)

Figure	Title	Page
4-1	Standard (United States/United Kingdom) Character Set.	4-2
4-2	Keycap Remover	4-3
4-3	Numeric Keypad Group	4-4
4-4	Cursor Control Keys Group.	4-5
4-5	Edit Keys Group.	4-12
4-6	Control Keys Group	4-15

LIST OF TABLES

Table	Title	Page
1-1	Display Terminal Features.	1-2
1-2	Operating Modes.	1-4
1-3	Emulated Terminals	1-6
2-1	Primary Port Pin Signal Assignments.	2-1
2-2	Jumper Options	2-2
2-3	Input Power Requirements	2-4
3-1	Status Line 1.	3-3
3-2	Status Line 2.	3-6
3-3	Status Line 3.	3-8
3-4	Status Line 4.	3-10
3-5	Status Line 5.	3-12
4-1	Cursor Control Keys Movement Guide	4-9
5-1	Summary of Clear Commands.	5-6
5-2	Function Key Code Sequences.	5-11
5-3	TeleVideo 910 "FUNCT" Key Code Sequences	5-12
5-4	ADDS Regent 20/25 Program Function Key Codes	5-12
5-5	ADDS Viewpoint A1 and A2 Program Function Key Codes.	5-13
5-6	Visual Attributes and Escape Sequences	5-13
6-1	TeleVideo 910/910+/925/950 Visual Attributes	6-3
6-2	Emulation Mode Escape Sequences and Control Codes.	6-4

SECTION I

OVERVIEW

1.1 PURPOSE AND SCOPE

This manual provides the information necessary to operate the Ampex 210 video display terminal while in Ampex native mode. Included are installation and set-up instructions as well as explanations of all operating functions. The manual is intended to be useful to both terminal operators and computer programmers.

1.2 GENERAL DESCRIPTION

The Ampex 210 is a desktop video display terminal (Figure 1-1) designed to function as an input/output peripheral for a computer system. Physical and functional descriptions are provided in the remaining paragraphs of this section.

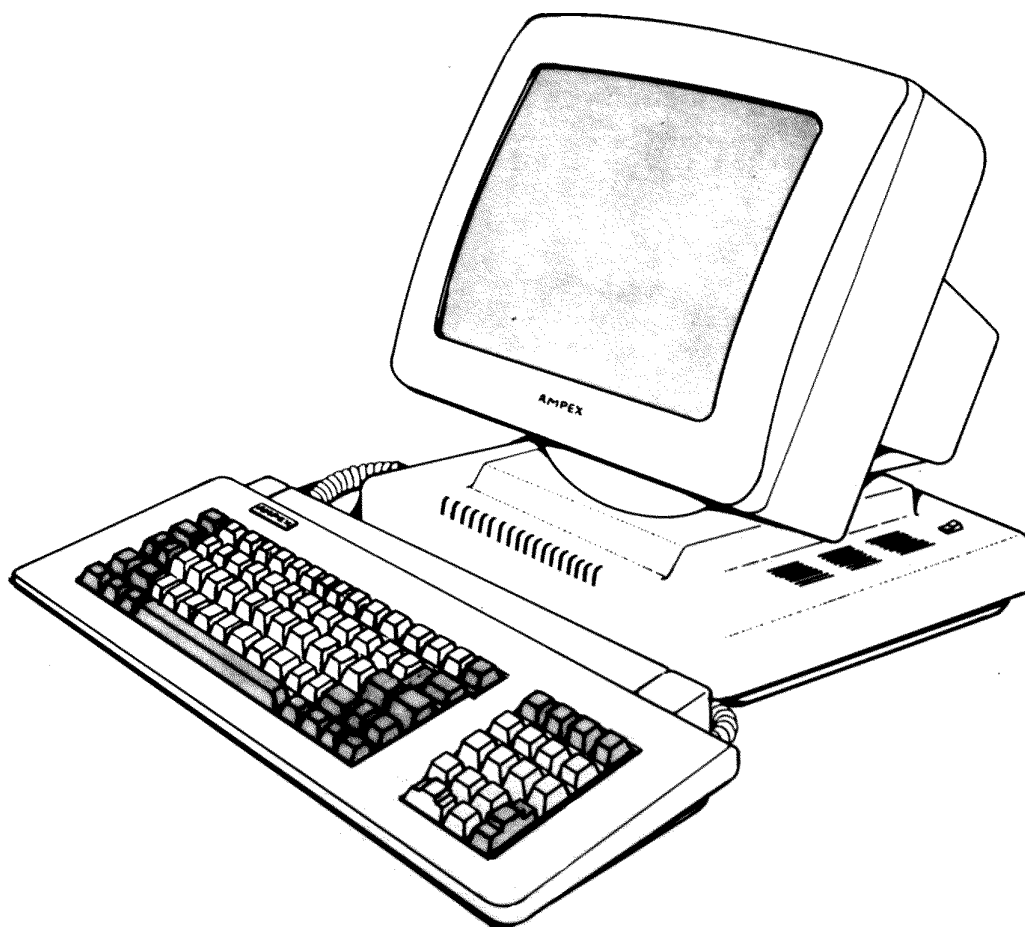

FRONTPIECE

6097

Figure 1-1. Ampex 210 Video Display Terminal

1.2.1 Physical Description

The Ampex 210 consists of two major subassemblies: the keyboard and the display unit.

1.2.1.1 Keyboard

The keyboard provides the means for the operator to input information and commands to the computer system. The detached keyboard attaches to the display unit via a coiled cable extending to a maximum of six feet. This provides flexibility and comfort to the operator during use of the terminal.

The keyboard has a step-sculptured profile and adjustable slope to 7, 11, and 15 degrees. Key cap surfaces are a nonflare gray with selected keys a darker shade of gray for ease of access. Key legends are black.

1.2.1.2 Display Unit

The display unit consists of a molded plastic case which houses the electrical and electronic circuitry necessary to display and transmit information, and a cathode ray tube (CRT) for displaying the information. The display has a 14-inch (diagonal) viewing screen. The display unit is seated on a pedestal which allows the unit to tilt and swivel.

1.2.2 Display Terminal Features

Table 1-1 lists and describes the various features of the Ampex 210 terminal.

Table 1-1. Display Terminal Features

Features	Description
DISPLAY FORMAT	The viewing screen can display a page of 2,000 characters, formatted in twenty-four horizontal lines of eighty characters each. An additional status line, located at the bottom of the screen, may be selected for display by the user. The status line provides a display of current operating and emulation modes, functions, and other useful information.

**Table 1-1. Display Terminal Features
(Cont.)**

Features	Description
CRT SAVER CIRCUIT	After about 10 minutes if no information is sent to the terminal by either the operator or host computer, all information displayed on the viewing screen, disappears from the screen. The screen reactivates as soon as any key is depressed or prompted by the host computer. Any information previously displayed on the screen will reappear. The purpose of the CRT saver circuit is to prolong the operating life of the CRT.
DISPLAY MEMORY	The Ampex 210 terminal can store one page (or screen) of data.
AUDIBLE KEY CLICK	An electronically-generated click (operator-selectable) occurs whenever a key is depressed. The audible key click feature may be turned on and off while in the Set-Up mode.
CHARACTER SET	The Ampex 210 can display 168 letters, numerals, and symbols. Included is the 96-character American Standard Code for Information Interchange (ASCII) set, 15 line graphic symbols, 32 control character facsimiles, and 25 national characters and symbols. In addition to the standard character set, United States/United Kingdom, there are five optional character sets for the following countries: Germany, France, Sweden, Norway, and Denmark.
CHARACTER PRESENTATION	Each alphanumeric or symbolic character is presented on the screen in a 7 by 10 dot matrix within a position field of nine dots horizontally by twelve dots vertically.

**Table 1-1. Display Terminal Features
(Cont.)**

Features	Description
CHARACTER VISUAL ATTRIBUTES	Each character can be assigned visual attributes from either the terminal keyboard or the host computer. Character visual attributes are designed to not extend character positions (except for half-intensity), can be assigned to single characters or to fields of characters, and can be used in combination. Refer to Table 5-6 for a list of possible visual attributes and combinations thereof.
CURSOR	The cursor is the pointer-indicator used to designate the current character position; also defined as the position at which the next character received will be displayed. The cursor is readable and addressable.

1.2.3 Operating Modes

Operating modes are host computer- or operator keyboard-selectable and determine the effects of the terminal's functions. The various operating modes are discussed in Table 1-2.

Table 1-2. Operating Modes

Mode	Description
HALF DUPLEX/ FULL DUPLEX	In order to properly communicate with the host computer, a selection must be made between these two conversational modes.
BLOCK	This operating mode provides for a block of data to be entered from the keyboard to the terminal display memory without immediate transmission to the host computer. This allows for editing of data locally before transmitting to the host.
LINE	This operating mode is the same as Block mode except that a line, not a block, of data may be edited and then transmitted to the host computer.

**Table 1-2. Operating Modes
(Cont.)**

Mode	Description
CHARACTER	This operating mode provides for the entry of data from the keyboard and for transmission of each character to the host computer immediately upon depression of a key.
LOCAL	This operating mode provides for the local execution of terminal functions. Transmission between the terminal and the host computer is prohibited.
WRITE PROTECT	In Write Protect mode, characters are written in half intensity on the screen and will be protected when the terminal is in Protect mode.
PROTECT	In Protect mode, areas previously written in Write Protect can be designated as protected against erasure, change, or transmission. These areas are displayed in half-intensity.
MONITOR	Monitor mode permits entry and display of all control characters to the screen. The displayed control characters will not be interpreted or executed.
FUNCTION KEYS	14 function key sequences are available for the operator to transmit code sequences to the host computer.
AUTO SCROLL	Scrolling may be enabled and disabled by making the appropriate selection while in Set-Up mode. It may also be enabled and disabled by toggling ESC H. When scrolling is disabled, the cursor will wrap around to line 1 column 1 if a carriage return line feed or line feed is issued while the cursor is on line 24.

Operating modes and their functions are explained in more detail in Section Five of this manual.

1.3 EMULATION CAPABILITIES

The Ampex 210 terminal is capable of emulating the functions, escape and control code sequences, operator-selectable options, and ASCII code structure of the terminals listed in Table 1-3.

Table 1-3. Emulated Terminals

Manufacturer	VDT Model
ADDS Corp.	Regent 20/25, Viewpoint A1, A2
Hazeltine Corp.	1400, 1410, 1500
Lear Siegler, Inc.	ADM5 (ADM3, 3A, 3A+)
Qume Corp.	QVT102
TeleVideo Systems Inc.	910, 910+, 920, 925

1.4 SPECIFICATIONS

The following is a list of operating characteristics and specifications for the Ampex 210 video display terminal.

Display Screen

14-inch nonglare screen
 Green or amber phosphor
 60 or 65 Hz refresh rate (operator-selectable)

Displayed Character Set

168 displayable characters
 96 ASCII characters
 32 control characters
 15 line graphic characters
 25 national characters
 24 data lines; 25th status line
 80 characters per line
 2000 characters per screen

Character Typestyle

7 x 10 dot matrix in a 9 x 12 dot field

National Character Sets

United States/United Kingdom
 German
 French
 Swedish
 Danish
 Norwegian

Visual Attributes

Flash
Blank (security)
Reverse video
Underline
Half-intensity
Combination attribute

Cursor

9 x 12 dot matrix
Block or underline
Flashing or Steady
No cursor
Readable and addressable

Cursor Control Keys

↓, ↑, ←, →, Home, Tab, Back Tab, Retu
Linefeed, Backspace

Edit Keys

Line insert/delete
Character insert/delete
Erase to end of line
Erase to end of page

Emulations

ADDS Regent 20/25, Viewpoint A1, A2
Hazeltine 1400, 1410, 1500
Lear Siegler ADM5, ADM3, ADM3A, ADM3A
Qume QVT 102
TeleVideo 910, 910+, 920, 925

Operating Modes

Half-duplex/full-duplex
Block, line, character, local
Protect, write protect
Function Key
Monitor
Auto Scroll
Set-Up

Primary Port and Printer Port**Data Transmission Rates****(Independently-Selectable)**

50, 75, 110, 135, 150, 300, 600, 1200
1800, 2400, 3600, 4800, 7200, 9600,
19,200 (19.2) bits per second.

Interfaces

Standard RS232C port
RS232C printer port (bi-directional)

Printer Functions

Local print (page print)
Transparent print
Copy print

Operating Environment

Temperature: 32°F to 104°F (0°C to 40°C)
Humidity: 5% to 95%

Physical Dimensions

	<u>Display Unit</u>	<u>Keyboard</u>
Width	13.5in (343mm)	19.0in (483mm)
Depth	13.5in (343mm)	7.5in (191mm)
Height	14.5in (369mm)	1.5in (38mm)
Weight	19.4lb (8.7kg)	2.01lb (.9kg)

Power Requirements

115 vac (+10%, -15%) at 0.5 amp
230 vac (+10%, -15%) at 0.25 amp
50/60 Hz (±3%), 55W

Transmission Protocol

XON/XOFF
DTR High/DTR Low

Regulatory Compliance

UL (United States)
FCC Class A (United States)

SECTION II
INSTALLATION

2.1 INTRODUCTION

The Ampex 210 video display terminal may be operated in a wide variety of physical environments. The remainder of this section provides explanations and diagrams to assist the user during installation of the Ampex 210.

2.2 Primary Port Interface

The Ampex 210 terminal uses a standard RS232C primary port interface to connect the terminal to a host computer or modem.

Table 2-1 provides interface pin signal assignments at the primary port.

Table 2-1. Primary Port Pin Signal Assignments

Pin No.	Signal Name	Mnemonic	Signal Direction
1	Chassis ground		
2	Transmit Data Output		From Terminal
3	Receive Data Input		To Terminal
4	Request-to-Send Output	RTS	From Terminal
5	Clear-to-Send Input	CTS	To Terminal
6	Data-Set-Ready Input (optional)	DSR	To Terminal
7	Signal Ground		
8	Data Carrier Detect	DCD	To Terminal
20	Data-Terminal-Ready Output	DTR	From Terminal

2.3 Interface Jumper Option

The Ampex 210 terminal offers an alternative to the standard primary interface. Table 2-2 lists and describes the jumper options available.

Table 2-2. Jumper Options

Jumper	Description
W23-W24	Allows Data Carrier Detect to monitor the readiness of an external modem.
W20-W21	<p>Data Terminal Ready. Output signal sent from the terminal to the host to enable communications.</p> <p><u>Options</u></p> <ol style="list-style-type: none"> 1. Cutting W23-W24 and connecting W24 and W25 allows Data Set Ready to monitor the readiness of an external modem. 2. Cutting W20-W21 and connecting W21 to W22 uses a Request to Send (RTS) signal to the computer to enable communications.

2.4 Installation Requirements

The Ampex 210 terminal is designed to be mounted on a flat, hard surface such as a desk or table top capable of supporting at least 22 pounds (10 kg). Ambient temperature of the operating environment must be within 32° F to 104° F (0° to 40° C) range.

CAUTION

Do not block any of the air vents on the unit. All air vents in the terminal case must be kept clear in order to provide proper cooling during operation.

2.4.1 Space Allocation

The detached keyboard permits considerable flexibility in positioning the unit for use. Figure 2-1 illustrates the terminal's overall dimensions as well as the minimum surface area required for installation.

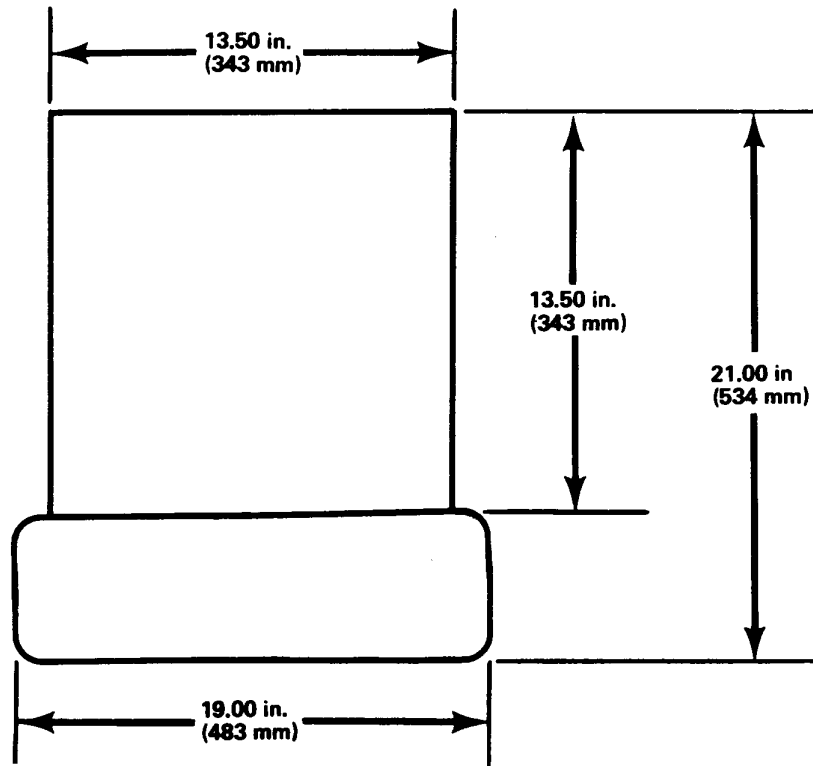

6151

Figure 2-1. Overall Dimensions

2.4.2 Input Power

The Ampex 210 is configured at the factory for either 115 or 230 vac. Installation site power requirements for both versions are listed in Table 2-3.

Table 2-3. Input Power Requirements

Version	Phasing	Frequency	Current
115 vac +10% -15%	Single Phase	60 Hz \pm 3%	0.50 A
230 vac +10% -15%	Single Phase	50 Hz \pm 3%	0.25 A

WARNING

High voltage is present within the case when power is on. Remove the power cable from the ac receptacle before removing the top cover. Only authorized service personnel should open the case.

The Ampex 210 may be strapped for 115 or 230 vac. Figure 2-2 contains drawings showing the two versions of the strapping plug. Refer to these drawings when changing the voltage from 115 vac (applicable in the United States) to 230 vac (applicable outside the United States) or vice versa as needed.

NOTE

The fuse, located in fuseholder on back panel of the VDT (Figure 2-3), must be changed when the voltage is changed. For:

115 vac - Use a 2A fuse
230 vac - Use a 1A fuse

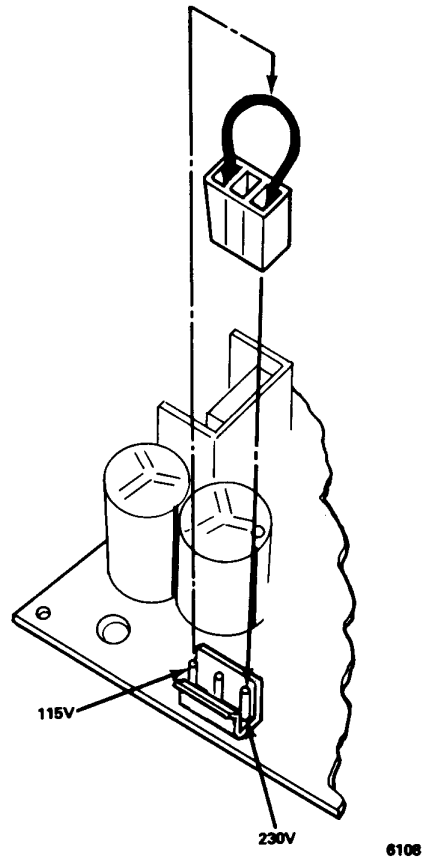

Version 1

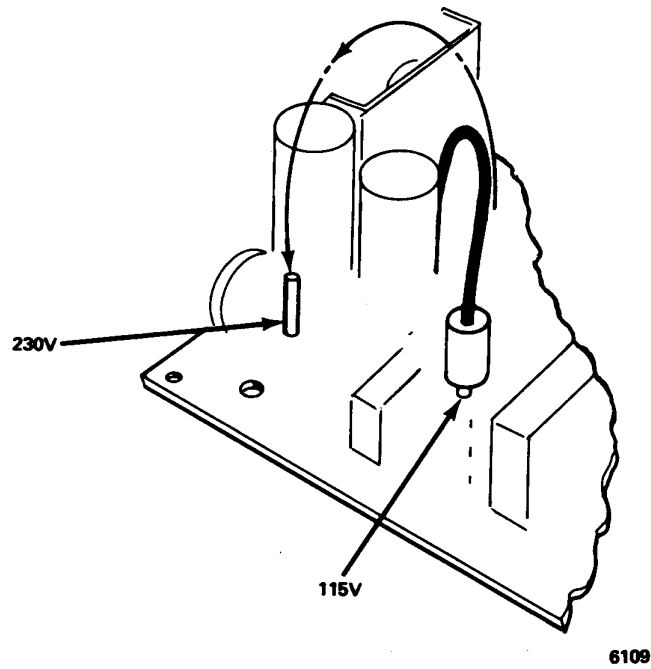

Version 2

Figure 2-2. Voltage Strapping Plug (Version 1 and Version 2)

2.4.3 AC Power Cord and Plug

Each terminal is shipped with either a 115vac/60 Hz power plug (for use in the United States) or a 230vac/50 Hz power plug (for use outside the United States). Ampex 210 terminals in the United Kingdom and Australia may need customized power plugs to fit the receptacles in these countries.

WARNING

Electric shock may result if the power cord is connected to ac power when the plug is cut off. Be sure to disconnect the cord from ac power before customizing the power plug.

2.4.4 Interface Cable Connections

Figure 2-3 is a view of the back panel of the Ampex 210 video display terminal. Refer to this figure when attaching the primary port (to computer) and the printer port (to printer) interface cables.

WARNING

It is recommended that any cable used be shielded and jacketed. Using such a cable properly will help to minimize electromagnetic interference. Reducing such interference will not only protect your terminal from signal noise, but will also protect other devices near your terminal (e.g., a TV or radio) from interference radiated by an improperly shielded cable.

2.4.5 Keyboard Port Connection

Figure 2-4 shows the location of the keyboard cable port. Refer to this figure when attaching the keyboard cable to the display terminal.

CAUTION

Do not connect or disconnect the keyboard to or from the display unit when power is on. Erratic performance may result.

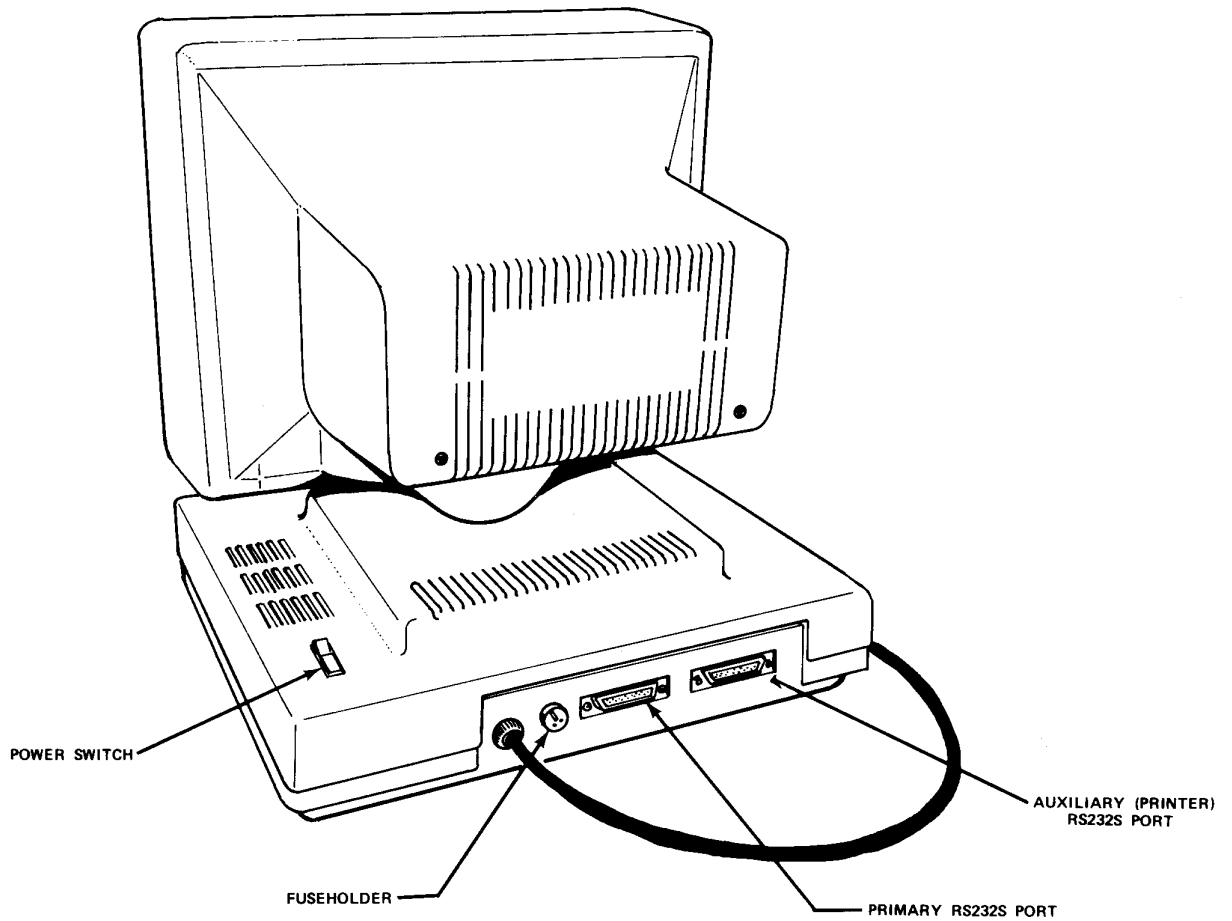

REAR PANEL VIEW

6098

Figure 2-3. Ampex 210 Video Display Terminal (Back Panel View)

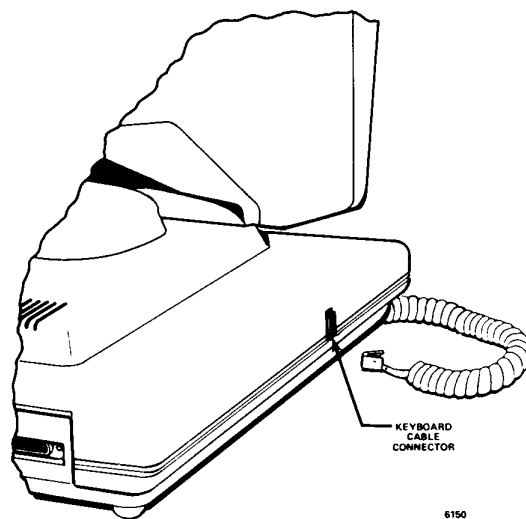

6150

Figure 2-4. Keyboard Port on Display Terminal

2.5 Power-on and Reset

To power-on the terminal:

1. Make sure all interface cables are connected properly to their respective ports (see 2.4.4 Interface Cable Connections and 2.4.5 Keyboard Port Connection).
2. Make sure the power cable is plugged into the proper outlet (see 2.4.3 AC Power Cord and Plug).
3. Within seconds, the unit undergoes its self-test.
4. After the self-test is completed, the cursor will display in the top left-hand corner of the screen.
5. Adjust the phosphor intensity by rotating the intensity control dial, located underneath the right-hand portion of the display unit.
6. The terminal is now ready to begin performing the operations described in the remaining sections of this manual.

To reset the terminal while performing normal operations press SHIFT and the BREAK key twice simultaneously.

2.6 SELF-TEST

The self-test feature is activated each time the terminal is powered on. For the most part, the test pattern on the screen cannot be viewed at initial power-up. To view the test pattern, initiate a self-test while the terminal is already "on" by entering an **ESC V**.

The self-test operation checks the following:

CMOS RAM (a check sum of the terminal set-up information)
 DATA RAM
 DISPLAY RAM
 ROM
 VISUAL ATTRIBUTES (displays the test pattern)

Result of Terminal Self-Test

A test pattern will display, showing all character sets, visual attributes, firmware version number, and copyright information. If any component errors are detected, a message will display on the lower portion of the screen. Possible error messages are:

CMOS CHECKSUM ERROR
 DATA RAM ERROR
 DISPLAY RAM ERROR
 ROM ERROR

If any of the above error messages display on the screen:

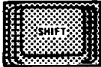
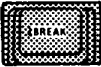
1. Reset the terminal. Press   twice.
2. Enter ESC V. (System will undergo another self-test procedure).
3. Verify any error messages.
 - a. If the error message is no longer on the screen, the terminal is ready to operate.
 - b. If the error message still displays on the screen, contact an Ampex service location immediately. Do not attempt to correct the problem.

SECTION III

SETTING UP

3.1 SET-UP Mode

Operating parameters of the Ampex 210 terminal may be selected while in the Set-Up mode. When Set-Up mode is entered, status lines containing operating default parameters will display. This chapter provides instructions for entering Set-Up mode, viewing the status lines, and selecting and saving operating parameters.

3.2 Entering Set-Up Mode

To enter Set-Up mode, press SHIFT/SETUP. This signals to the host computer (XOFF or DTR Low) to stop transmission. When Set-Up mode is exited, an appropriate signal (XON or DTR High) will be sent to the host computer to resume transmission.

3.2.1 Viewing Status Lines

Once in the Set-Up mode, the first of five (5) status lines will appear on the 25th line of the display screen. Status lines will display in half-intensity reverse video unless the data area has been set to reverse video. In that case, the status lines will display in normal video at half-intensity. To display the next status line, press the cursor down key. This action will position the cursor at the first parameter of the next status line. Continue viewing succeeding lines in this manner.

To return to a previous status line, depress the cursor up key. This action will position the cursor at the first parameter of the previous status line. Continue viewing preceding status lines in this manner.

3.2.2 Modifying Parameters

To modify existing parameters, move the cursor to the parameter needing modification using either the cursor right key or the cursor left key. Once the cursor is at the parameter to be changed, depress the space bar (or T key) to view the various selections in the status line area. When the appropriate selection appears on the status line, go on to the next parameter.

Modified parameters are in effect as long as the terminal maintains power. Once the terminal is reset or has loss of power, these modifications will be lost. To save modifications so that they are still in effect at terminal reset and power on/off, follow the instructions provided in the following paragraphs.

3.2.2.1 Saving Individual Modifications

Once the appropriate selection appears on the status line, save the selection by depressing SHIFT/S. Any of the parameters may be modified and saved in this manner except:

Protect ON/OFF
Keyboard LOCK/UNLOCK
Monitor mode ON/OFF
Auxiliary Port ON/OFF
Graphics mode ON/OFF
BIDIR ON/OFF

These parameters may not be saved and will default to their original setting at power-on. Once SHIFT/S is issued, the parameter is saved and the terminal exits the Set-Up mode. The screen displayed before entering Set-Up will reappear.

3.2.2.2 Saving Multiple Modifications

Multiple changes on any or all status lines may be saved as well as individual changes. To do so, make the appropriate selections on any given status line. After all selections have been made, depress SHIFT/S. This action causes all of the modified parameters of the current status lines to be saved and the terminal to exit the Set-Up mode.

Saved selections are stored in nonvolatile memory and will still be effective at power-off and power-on except for those mentioned in paragraph 3.2.2.1. To return all of the parameters to their default selections, depress SHIFT/D. This action will also cause the terminal to exit the Set-Up mode. To recall the most current "saved" selections, depress the SHIFT/R key. The most recent "saved" selections will be in effect and the terminal will exit the Set-Up mode.

3.3 EXITING THE SET-UP Mode

The Set-Up mode is exited when Shift/Set-Up, SHIFT/S, SHIFT/R, or SHIFT/D keys are depressed. Exiting the Set-Up mode effects two reactions: the cursor returns to its original position on the screen displayed before entering Set-Up mode and a signal is sent to the host computer allowing the resumption of transmission.

3.4 STATUS LINE DISPLAY

Status lines consist of operational parameters and selections within those parameters. There are five different status lines (Figures 3-1 through 3-5).

3.4.1 Status Line 1

Figure 3-1 illustrates the default operating parameters and corresponding selections of Status Line 1. Parameters and selections are described in Table 3-1.

	CHAR	FDX	A210	USA	KB ON	MON OFF	AUX OFF	NUMER	PROT OFF	GFX OFF	DSR ON	00:00
CAPS	BLOCK	HDX	TV925	FRE	KB LK	MON ON	AUX ON	FUNCT	PROT ON	GFX ON	DSR OFF	
LINE			TV920	UK			TPR ON					
LOCAL			T910+	GER								
			TV910	SWD								
			QT102	NOR								
			ADM5	DAN								
			VP									
			R25									
			H1500									
			H1400									

6153-1

Figure 3-1. Status Line 1

Table 3-1. Status Line 1

Default Parameter	Other Parameters	Field Description
CHAR	CAPS BLOCK LINE LOCAL	At power on, the state of the CAPS LOCK key is retrieved from the parameter, LWCS/UPCS on Status Line 2. When set to UPCS, all alpha characters will display and transmit in their shifted state. The message, "CAPS," will display on the status line. When LWCS is selected, alpha characters will return to their unshifted state and the "CAPS" message will no longer display. Defines the mode of communication with the host computer. If communication with a host computer is not required, select Local.

Table 3-1. Status Line 1 (Cont.)

Default Parameter	Other Parameters	Field Description
FDX	HDX	Indicates the method of communication with a host computer. Set to FDX (full duplex) if the host computer is capable of echoing received character codes back to the terminal. Set to HDX (half duplex) if the host computer cannot echo received character codes back to the terminal.
A210	TV925 TV920 T910+ TV910 QT102 ADM5 VP R25 H1500 H1410	Indicates the terminal model being emulated. Emulation models include TeleVideo systems, Qume system, Lear Siegler system, ADDS systems, and Hazeltine systems. Refer to Section VI for more information on emulation capabilities.
USA	FRE UK GER SWD NOR DAN	<p>The type of national character set utilized by the keyboard. Choices include: FRE -French, UK -United Kingdom, GER -German, SWD -Swedish, NOR -Norwegian, DAN -Danish.</p> <p>All Ampex 210 terminals are supplied with the standard U.S./U.K. keycap set. For those terminals requiring other keycap sets, refer to 4.2.2, Character Set Group, for instructions in adapting the standard keycap set to the desired national character set.</p>
KB ON	KB LK	When set to LK, the keyboard becomes inoperable.
MON OFF	MON ON	When set to ON, monitor mode is in effect and all characters, including escape sequences and control characters, will display.

Table 3-1. Status Line 1 (Cont.)

Default Parameter	Other Parameters	Field Description
AUX OFF	AUX ON TPR ON	Indicates the status of the printer port. AUX OFF- Data received from the host computer will be directed to the screen only. AUX ON - Data received from the host computer will be directed to both the screen and the printer port. TPR ON - Data received from the host computer will be directed to the printer port only. When a page print command is executed, the message "PTG" will appear here.
NUMER	FUNCT	Indicates the status of the numeric keypad. When set to NUMER, the unshifted state of the numerical keys will respond as numbered keys while at the same time the shifted state of the numeric keys will operate as lead-in function keys. When set to FUNCT, numeric keys will respond only as lead-in function keys.
PROT OFF	PROT ON	Indicates whether write-protected characters are protected.
GFX OFF	GFX ON	Indicates whether or not graphics mode is in effect. Applies only to Ampex 210 and Qume QT102 emulations.
DSR ON	DSR OFF	Indicates the state of the DCD (Data Carrier Detect). This parameter can be changed to indicate the state of the DSR (Data Set Ready) by following the instructions in Table 2-2.
01:01		Indicates the cursor's current position on the screen (in rows and columns).

3.4.2 Status Line 2

Figure 3-2 illustrates the default operating parameters and corresponding selections of Status Line 2. Parameters and selections are described in Table 3-2.

STAT ON	NORVID	BLK FLH	JUMP		LN ATB	DUPE		KB CLICK	KB RPT	LWCS
STAT OFF	REVVID	BLK CUR UDL FLH UDL CUR CUR OFF	SMOOTH	ESC CR ESC STX CR STX	PG ATB	LOCE	AUX/KB:KB AUX/KB:AUX	CLK OFF	RPT OFF	UPCS

6153-2

Figure 3-2. Status Line 2

Table 3-2. Status Line 2

Default Parameter	Other Parameters	Field Description
STAT ON	STAT OFF	Indicates whether a status line is to be displayed during normal operation.
NORVID	REVVID	If REVVID is selected, the screen displays in reverse video with the status line shown in half-intensity normal video.
BLK FLH	BLK CUR UDL FLH UDL CUR CUR OFF	Indicates the cursor configuration. Selections are: BLK FLH - Cursor appears as a flashing block. BLK CUR - Cursor appears as a steady block. UDL FLH - Cursor appears as a flashing underline. UDL CUR - Cursor appears as a steady underline. CUR OFF - No cursor will display.
JUMP	SMOOTH ESC CR ESC STX CR STX	Indicates the scrolling mode. When set to JUMP, the data is scrolled vertically on the screen as fast as it is received from the host computer. When set to SMOOTH, the data is scrolled vertically on the screen, one scan line at a time. Indicates the configuration of the program function key code sequences. Applies to VP and R25 emulation modes only. ESC CR - Escape; carriage return ESC - Escape; no code STX CR - Start of text; carriage return STX - Start of text; no code
LN ATB	PG ATB	A selection of "LN ATB" will cause any visual attribute(s) selected to affect one line. The other selection, "PG ATB" will cause the attribute(s) to affect an entire page. For example, if the attribute, underline, was activated and "PG ATB" was selected, then all data displayed on the screen (page) would be underlined.

Table 3-2. Status Line 2 (Cont.)

Default Parameter	Other Parameters	Field Description												
DUPE	LOCE AUX/KB:KB AUX/KB:AUX	<p>This parameter designates the communications mode of edit keys with the host computer.</p> <p>DUPE - Codes will be transmitted to the host computer.</p> <p>LOCE - Editing is done locally and will not transmit any codes to the computer.</p> <p>Applies only to ADM5 emulation.</p> <p>Selection of:</p> <p>AUX/KB:KB - Locks and unlocks the keyboard when a CTRL/N (locks) or CTRL/O (unlocks) is issued.</p> <p>AUX/KB:AUX - Enables and disables the auxiliary port as a gating function when a CTRL/N (enables) or CTRL/O (disables) is issued.</p>												
KB CLICK	CLK OFF	<p>When KB Click is designated, an electronically synthesized click sounds whenever a key is depressed. Set to "CLK/OFF" if click is not desired.</p>												
KB RPT	RPT OFF	<p>Repeating keys will repeat when depressed for any length of time if KB RPT is selected. The keys will not repeat if RPT OFF is selected. Keys that will never repeat are:</p> <table data-bbox="749 1353 1290 1539"> <tr> <td>LOC ESC/ESC</td> <td>FUNCT</td> </tr> <tr> <td>CTRL</td> <td>PRINT</td> </tr> <tr> <td>CAPS LOCK</td> <td>CLEAR/HOME</td> </tr> <tr> <td>BACK TAB</td> <td>BREAK</td> </tr> <tr> <td>SHIFT</td> <td>SET UP/SEND</td> </tr> <tr> <td>NO SCRL</td> <td></td> </tr> </table>	LOC ESC/ESC	FUNCT	CTRL	PRINT	CAPS LOCK	CLEAR/HOME	BACK TAB	BREAK	SHIFT	SET UP/SEND	NO SCRL	
LOC ESC/ESC	FUNCT													
CTRL	PRINT													
CAPS LOCK	CLEAR/HOME													
BACK TAB	BREAK													
SHIFT	SET UP/SEND													
NO SCRL														
LWCS	UPCS	<p>Indicates the shift state of alpha keys at power up.</p> <p>UPCS - indicates upper case letters.</p> <p>LWCS - indicates the default lower case letters.</p> <p>If UPCS is selected, then the message "CAPS", will display in the first position of Status Line 1.</p>												

3.4.3 Status Line 3

Figure 3-3 illustrates the default operating parameters of Status Line 3. Parameters and selections are described in Table 3-3.

TIME AM 08:00	SAV ENB	CUR 950	SCROLL ON		WRAP ON	BELL ON	CR=CR
TIME PM 08:00	SAV OFF	CUR 920	SCROLL OFF	LEAD=ESC	WRAP OFF	BELL OFF	CR=CRLF
				LEAD=HZ~			

6153-3

Figure 3-3. Status Line 3

Table 3-3. Status Line 3

Default Parameter	Other Parameters	Field Description
TIME AM 08:00	TIME PM 08:00	Real time indication. At initial power on, an internal 12-hour clock will begin measuring the time of day starting at its default 08:00 AM setting. To alter this setting, press the right cursor key to the "08" (hours) setting and depress the space bar until the correct hour(s) display. To change the minutes, press the cursor right key to the "00" (minutes) setting and depress the space bar until the correct number of minutes are displayed.
SAV ENB	SAV OFF	If "on", this parameter activates the CRT saver feature. In other words, if the terminal is left "on" with data displayed on the screen; that data will disappear after a period of 10 minutes in order to prolong the life of the video display. Pressing any key or receiving any data from the host will cause the display to reappear. SAV OFF disables this feature.

Table 3-3. Status Line 3 (Cont.)

Default Parameter	Other Parameters	Field Description
CUR 950	CUR 920	<p>Cursor down key selection for the TeleVideo 910 + emulation mode.</p> <p>CUR 950 - CTRL/V moves cursor down one line.</p> <p>CUR 920 - CTRL/J moves cursor down one line.</p>
SCROLL ON	SCROLL OFF	<p>Indicates the terminal's scrolling status.</p> <p>SCROLL ON - Causes all data lines to move up one line when line 24 is exceeded in order to make room for the next line.</p> <p>SCROLL OFF - Data lines will remain stationary when data entered exceeds line 24. Exceeding data will cause cursor to return to the Home position and overwrite existing lines.</p>
	LEAD=ESC LEAD=HZ~	<p>Indicates the type of lead-in code affecting escape sequences. Applies to Hazeltine emulations only.</p>
WRAP ON	WRAP OFF	<p>If cursor is at column 80 and data is entered, WRAP ON will cause the cursor and exceeding data to wraparound to the start of the next line. If WRAP OFF is selected, cursor will not move at column 80.</p>
BELL ON	BELL OFF	<p>If "on", a bell sounds when the cursor reaches column 72. This feature acts as an indication of the right margin when entering data.</p>
CR=CR	CR=CRLF	<p>Indicates terminal response to a carriage return received from the keyboard or host.</p> <p>CR=CR - cursor will move to column 1 of the same line when a carriage return is executed.</p> <p>CR=CRLF - cursor will move to column 1 of the next line when a carriage return is executed.</p>

3.4.4 Status Line 4

Figure 3-4 illustrates the default operating parameters and corresponding selections of Status Line 4. Parameters and selections are described in Table 3-4.

HOST 9600	DTR	AUX 9600	BIDI OFF	BIT 8-0	STOP 1	PAR OFF	NO PAR CHK	FREQ 65
19.2	DTR-XON	19.2	BIDIR ON	BIT 8=1	STOP 2	PAR ODD	PAR CHECK	FREQ 60
50	MODEM	50		7 BITS		PAR EVEN		
75	XON/XOFF	75				PAR = 1		
110		110				PAR = 0		
135		135						
150		150						
300		300						
600		600						
1200		1200						
1800		1800						
2400		2400						
3600		3600						
4800		4800						
7200		7200						

6153-4

Figure 3-4. Status Line 4

Table 3-4. Status Line 4

Default Parameter	Other Parameters	Field Description
HOST 9600	19.2 50 75 110 135 150 300 600 1200 1800 2400 3600 4800 7200	Indicates the rate of transmission (in bits per second) of data sent between the terminal and the host computer.
DTR	DTR-XON MODEM XON/XOFF	Indicates the transmission protocol. Selections are: DTR - Data Terminal Ready only. DTR-XON - Data Terminal Ready and XON/XOFF protocol. MODEM - Modem transmission. XON/OFF - XON/XOFF protocol only.

Table 3-4. Status Line 4 (Cont.)

Default Parameter	Other Parameters	Field Description
AUX 9600	19.2 50 75 110 135 150 300 600 1200 1800 2400 3600 4800 7200	Defines the rate of transmission (in bits per second) data is sent through the printer port.
BIDIR OFF	BIDIR ON	Indicates whether the direction of data transmission from the printer port to the host computer is enabled. If BIDIR ON is selected, the print information will be bidirectional.
BIT 8=0	BIT 8=1 7 BITS	Indicates the data word configuration and the contents of Bit 8.
STOP 1	STOP 2	Indicates the stop bit configuration.
PAR OFF	PAR ODD PAR EVEN PAR=1 PAR=0	Indicates the type of parity applicable to each data word.
NO PARCHK	PAR CHECK	If the terminal, when receiving a data word, requires a parity check for compatibility with the host computer, select PAR CHECK.
FREQ 65	FREQ 60	Indicates the refresh rate of the terminal. Select: FREQ 65 - When the terminal being operated is in a 50 Hz line power area (eliminates flicker and ambient magnetic field interference). FREQ 60 - When the terminal being operated is in a 60 Hz line power area.

3.4.5 Status Line 5

Figure 3-5 illustrates the default operating parameters and corresponding selections of Status Line 5. Parameters and selections are described in Table 3-5.

HEOL - ^ _	HEOM - ^ M	AEOM - ^ F	HERE IS -
------------	------------	------------	-----------

0183-5

Figure 3-5. Status Line 5

Table 3-5. Status Line 5

Default Parameter	Other Parameters	Field Description
HEOL = ^ _		Indicates the host's end of line terminator. The default setting is a US (unit separator, 1FH Hex). Any two characters may be entered.
HEOM = ^ M		Indicates the host's end of message terminator. The default setting is a CTRL/M (carriage return). Any two characters may be entered.
AEOM = ^ F		Indicates the auxiliary port's end of message terminator. The default setting is CTRL/F (ACKnowledge). Any two characters may be entered.
Here Is =		This is a 20-character field available to the operator for entering a message that specifically identifies a particular terminal to the host computer. In this field, the first key entered and the last key entered must be the same characters in order to act as message delimiters (delimiters are not transmitted or displayed). Use a cursor key to exit this field before performing a Save function. Issuing a CTRL/E will cause the message to be transmitted to the host computer.

SECTION IV

TERMINAL CONTROLS

4.1 DISPLAY UNIT CONTROLS

There are two operator controls located on the exterior of the video display unit: the power switch and the intensity control dial.

4.1.1 Power Switch

The power switch is located to the right and towards the back of the unit when facing the screen. The switch is a rocker-type, and is designed to be operated by touch. A short time after the power is switched on, an alarm (beep) will sound indicating the completion of the self-test, the cursor will appear on the screen (unless cursor off was selected in Set-Up mode) at the Home position and the unit will be ready for use.

4.1.2 Intensity Control Dial

The intensity control dial is positioned underneath the right-hand portion of the screen. Adjust the intensity when sufficient video is displayed on the screen to establish the most comfortable level of intensity/ contrast.

CAUTION

Do not leave intensity at a high level for long periods of time; to do so may wear the phosphor-coated screen unnecessarily. The CRT Saver Circuit, which is operator selectable while in the Set-Up mode, blanks the display of on-screen information after a period of about 10 minutes, if the terminal is turned on but is not being used.

4.2 KEYBOARD CONTROLS

Keyboard controls, as shown in Figures 4-1 and 4-3, through 4-6, can be divided into five groups: Character Sets, Numeric Keypad, Cursor Control Keys, Edit Keys, and Control keys.

4.2.1 Lock and Unlock

The keyboard may be disabled by a command issued from the keyboard or host computer and enabled from the host computer. For:

Keyboard Lock - Enter Set-Up mode and select KB LK on Status Line 1 or receive an ESC # from the host computer.

Keyboard Unlock - ESC " from the host computer will enable keyboard operation. In addition, there are two ways of unlocking the keyboard from the keyboard.

1. Reset the terminal to its default unlock setting.

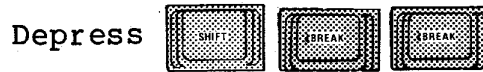

2. Return to Set-Up mode.



The keyboard automatically returns to its default setting of KB ON.

During print and send operations, the keyboard will remain locked until the operations are complete with the exception that Set-up mode may be entered and parameters changed. After exiting Set-up, the keyboard resumes its locked state until completion of the print or send command.

4.2.2 Character Set Group

The Character Set group contains alphabetic, numeric, and special symbol keys whose functions and arrangements are similar to those of an IBM Selectric III typewriter (Figure 4-1).

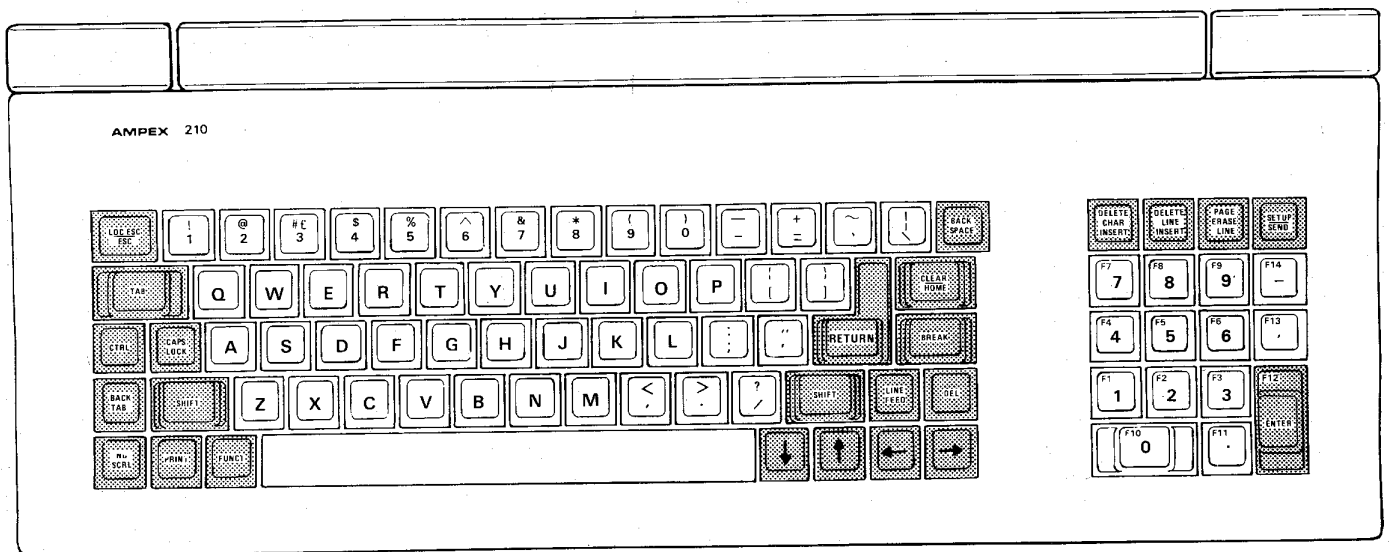
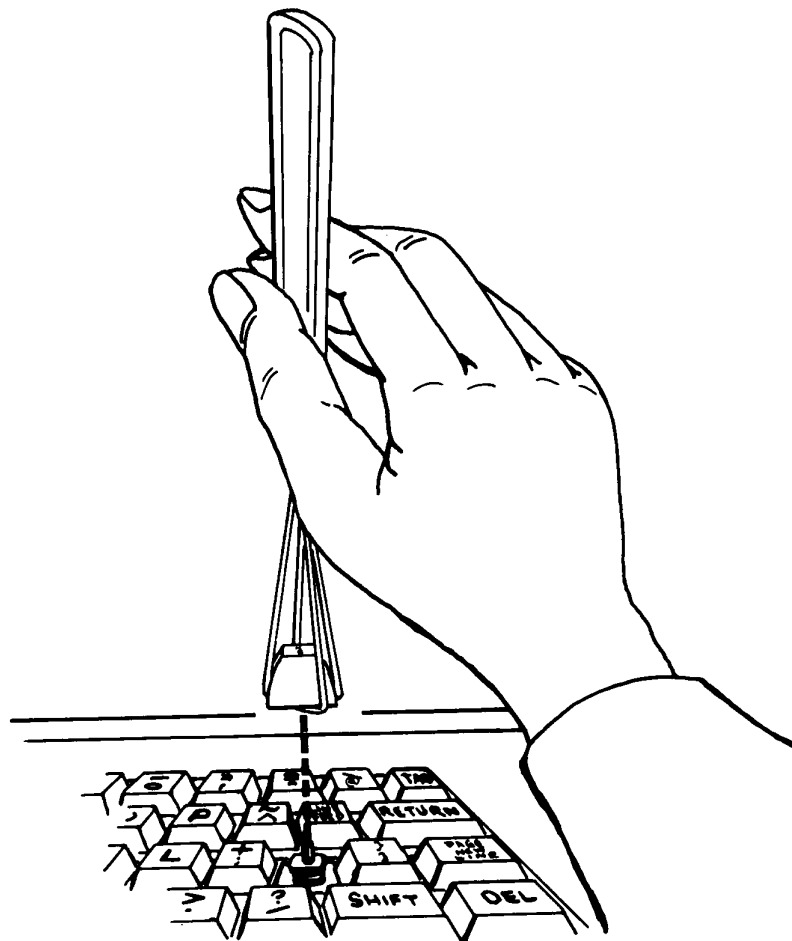

Figure 4-1. Standard (United States/United Kingdom) Character Set

In addition to the standard Character Set group, United States/United Kingdom, any one of five national character sets may be selected when in Set-Up mode. These national character sets are German, French, Swedish, Norwegian, and Danish (refer to Appendix D).

When using one of the optional national character sets, remove and replace keycaps properly using the keycap remover provided by Ampex (Part No. 074-297) in each character set kit or use an equivalent device (Figure 4-2). Position replacement keycaps and snap in place by hand. The optional national character sets illustrated in Appendix D identify the correct location of replacement keycaps.

Appendix D also provides hexadecimal codes and a comparison of special symbols for the national character sets (Figure D-6).



5783

Figure 4-2. Keycap Remover

4.2.3 Numeric Keypad Group

The keys constituting the Numeric Keypad Group are shown in Figure 4-3. All keys function identically to their counterparts in the Character Set and Edit Keys Groups while in the (Numer)ic mode. If in the Funct (function) mode, numeric keys will respond only as function lead-in keys (refer to paragraph 5.6 for more information concerning the Function Key modes).

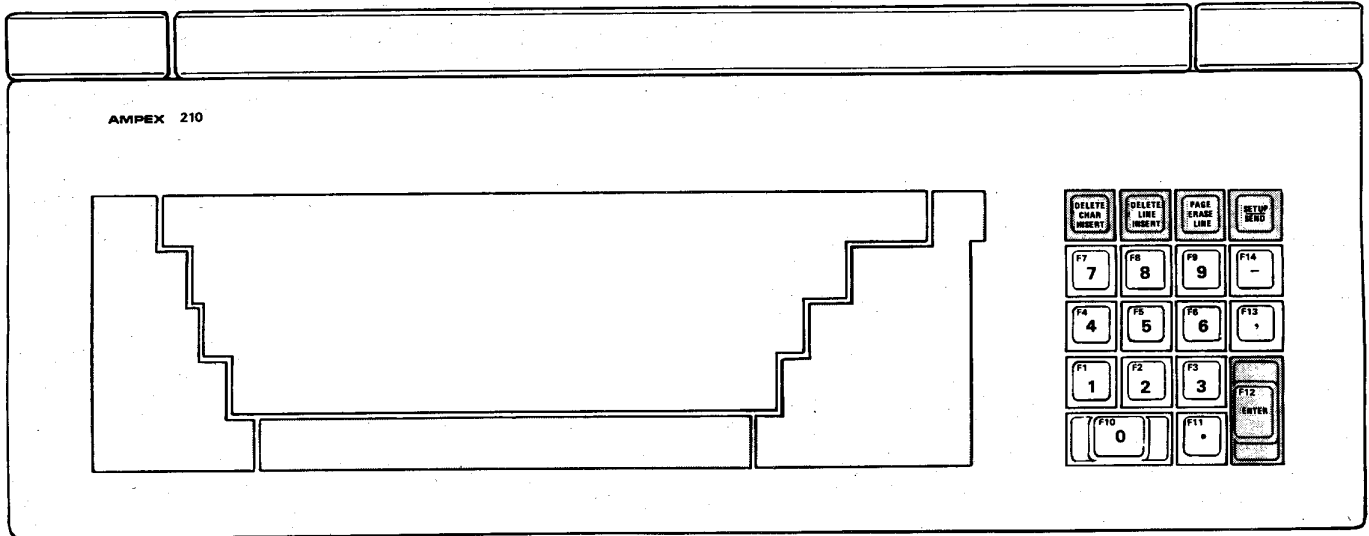

0095

Figure 4-3. Numeric Keypad Group

When Numeric keypad is enabled, the keys generate codes for numbers, 0 through 9, period, comma, minus, and Enter. In their shifted state, these keys act as program function keys and send a three-character code to the host computer.

The numeric keypad may be enabled either as a program function keypad or as a numeric keypad by toggling, **ESC c**, or by making the appropriate selection in Set-Up mode.

4.2.4 Cursor Control Keys Group

The keys in this group dictate the cursor movement on the display page (Figure 4-4). Table 4-1 provides a cursor movement guide.

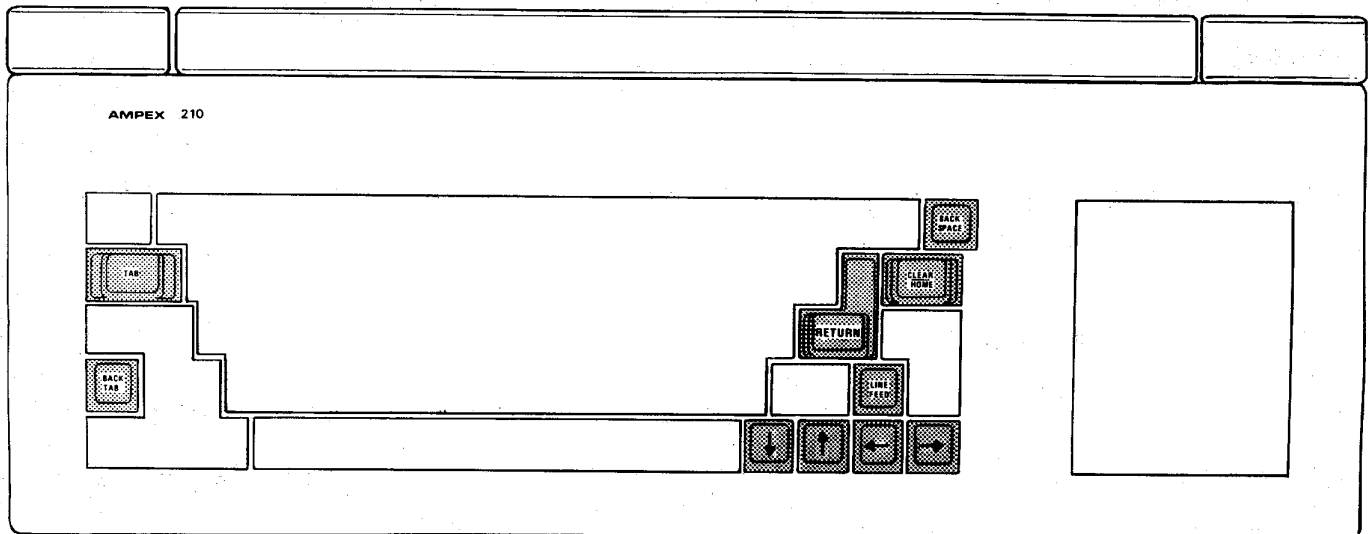



Figure 4-4. Cursor Control Keys Group

4.2.4.1 BACK TAB Key

Depression of the  key generates an ESC I to return the cursor to the previous tab stop when Protect mode is off or to the start of the previous unprotected field when Protect mode is on.

If there are no previous tab stops (when Protect mode is off) the cursor returns to column 1 of the same line.

4.2.4.2 TAB Key

When depressed, the  key moves the cursor forward to the next tab stop when Protect mode is off or to the first character of the next unprotected field when Protect mode is on. The cursor will not move if no tab stops are set or if the cursor is on the last tab position. This key generates a CTRL/I code.

4.2.4.3 BACK SPACE Key

When depressed, the  key causes the cursor to move backward one column. If the cursor is at the first position on a line, the cursor will move to the last position of the preceding line. If the cursor is at the home position when the Back Space key is depressed, the cursor will move to the last column of line 24 if Auto Scroll is disabled and will cause no cursor movement if Auto Scroll is enabled. This key generates a CTRL/H code.

4.2.4.4 HOME Key

The unshifted state of the  key causes the cursor to return to the first position of the display page when Protect Mode is off and to the first unprotected position of the display page when Protect Mode is on. When depressed, this key generates a CTRL/^ code.

4.2.4.5 RETURN Key

When depressed, the  key causes the cursor to return to the first unprotected position of the same line when auto line feed is disabled. When auto line feed is enabled, the cursor moves to the first position of the next line or the first unprotected position of the next line. If that entire line is protected, the cursor will move to the next unprotected position on the display page.

The local action of this key is dependent on which operating mode is selected. For example, if auto scroll is enabled, a CRLF (carriage return line feed) activated while on the 24th line will cause the screen to scroll up one line. If auto scroll is disabled, then a CRLF while on the 24th line will cause the cursor to return to the first unprotected position on the current display page with no scrolling taking place.

This key generates a CTRL/M.

4.2.4.6 LINE FEED Key

The  key causes the cursor to descend one line. If the cursor is on line 24 and auto scroll is enabled, then depression of this key causes the screen to scroll up one line. If the cursor is on line 24 and auto scroll is disabled, then depression of this key causes the cursor to return to line 1 of the current screen with no scrolling taking place.

This key generates a CTRL/J .

4.2.4.7 Key (Down Cursor)

The  key causes the cursor to descend one line. If the cursor is on line 24, then depression of this key will cause no movement.

This key generates a CTRL/V.

4.2.4.8  **Key (Up Cursor)**

When depressed, the  key causes the cursor to move up one line (in the same column). When line 1 is reached, the cursor will not move. This key generates a CTRL/K.

4.2.4.9  **Key (Left Cursor)**

The  key responds in the same manner as the BACK SPACE key (4.2.4.3) and also generates a CTRL/H.

4.2.4.10  **Key (Right Cursor)**

When depressed, the  key causes the cursor to move one position to the right. If the cursor is at the last column on a line, it will move to the first position of the next line if wraparound is on or it will not move if wraparound is off. If the cursor is positioned at the last column of line 24 and auto scroll is on, the screen will scroll up one line and the cursor will move to the first position of the new line. This key generates a CTRL/L code. If auto scroll is off, the cursor will return to the home position with no scrolling taking place.

Table 4-1. Cursor Control Keys Movement Guide



Key	Command Code	Mode	Cursor Movement
	ESC I	Protect Mode On	Cursor returns to the start of the previous unprotected field.
		Protect Mode Off	Cursor returns to a previous tab stop or to column 1 of the current line if there are no previous tab stops.
	CTRL/I	Protect Mode On	Cursor moves forward to next unprotected field.
		Protect Mode Off	Cursor moves forward to next tab stop or remains stationary if there are no tab stops.
	CTRL/^	Protect Mode On	Cursor returns to first unprotected field on screen display.
		Protect Mode Off	Cursor returns to Column 1, Line 1 (first position) on screen display.
	CTRL/H		Cursor moves backward one space. If cursor is at Column 1 of a line, it will move to the last position on previous line.
		Auto Scroll Off	If at Home position, cursor will move to the last position of line 24.
		Auto Scroll On	If at Home position, cursor will not move.

Table 4-1. Cursor Control Keys Movement Guide (Cont.)





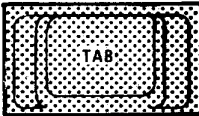

Key	Command Code	Mode	Cursor Movement
	CTRL/M	<p>Auto Linefeed On Protect Mode On</p> <p>Auto Linefeed On Protect Mode Off</p> <p>Auto Linefeed Off Protect Mode On</p> <p>Auto Linefeed Off Protect Mode Off</p> <p>Auto Scroll On Auto Linefeed On</p> <p>Auto Scroll Off Auto Linefeed On</p>	<p>Cursor moves to first unprotected position of the next line. If next line is protected, cursor moves to the next unprotected position on screen display.</p> <p>Cursor moves to the first position of the next line.</p> <p>Cursor returns to first unprotected position of the same line. If that line is protected, cursor will move to the next unprotected position on the screen display.</p> <p>Cursor returns to the first position of the same line.</p> <p>Screen will scroll up one line if cursor is on line 24 and a carriage return is executed.</p> <p>Cursor returns to the Home position with no scrolling taking place.</p>
	CTRL/J	<p>Auto Scroll On</p> <p>Auto Scroll Off</p>	<p>Cursor descends one line at the same vertical column.</p> <p>Screen scrolls up one line, if cursor was on line 24. Cursor is positioned on the new line 24.</p> <p>Cursor returns to line 1 of the current screen. No scrolling takes place.</p>
	CTRL/Y		<p>Cursor descends one line at the same vertical column. If on line 24, the cursor will not move.</p>

Table 4-1. Cursor Control Keys Movement Guide (Cont.)

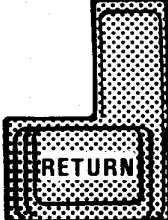
Key	Command Code	Mode	Cursor Movement
  	CTRL/K CTRL/H CTRL/L	Wraparound Wraparound Off Auto Scroll On Wraparound On Auto Scroll Off Wraparound On	Cursor moves up one line. Same as Back Space key. Cursor moves one position to the right. If at last position of line, cursor moves to the first position of the next line. If at last position of line, cursor will not move. If at last position of line 24, screen scrolls up one line, and cursor moves to the first position of the new line. If at last position of line 24, cursor returns to the Home position with no scrolling taking place.

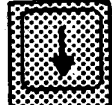
4.2.5 Edit Keys Group

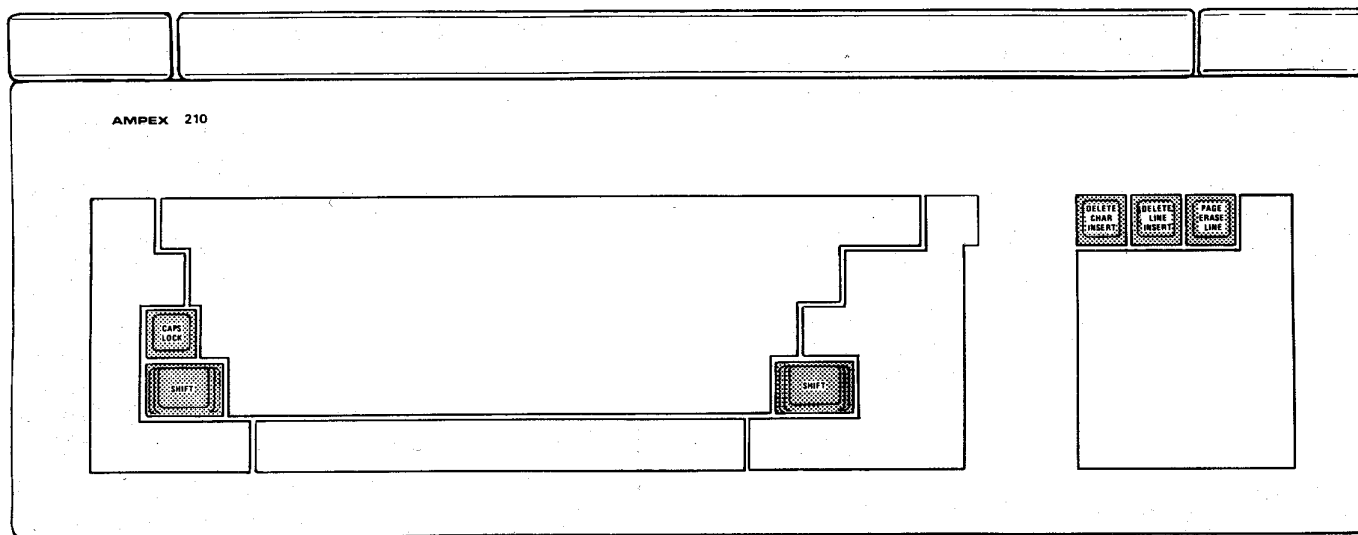

The keys in the Edit group are primarily used to alter the display of text and data. The following paragraphs will present these keys and give a description of their functions. Figure 4-5 will show the location of these keys on the keyboard.



6095

Figure 4-5. Edit Keys Group

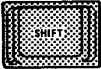
4.2.5.1 SHIFT Key

When used with another key, the  key causes the shifted state of the other key to be activated. The  key must be depressed first and then held down during depression of the second key.

4.2.5.2 CAPS LOCK Key

The  key toggles the alphabetic keys into and out of the shifted state. When activated, this key causes alphabetic keys to display in their upper-case state and the message "CAPS" to appear in half intensity at the bottom left-hand corner of the screen.

4.2.5.3 DELETE CHAR Key

The shifted state of the  key deletes the character at the cursor position and causes the remaining characters on the line to move one position to the left. A space character is written to the last position on the line.

When Protect mode is on, character delete operates only from the cursor position to the end of the first unprotected field or line.

This action generates an ESC W.

4.2.5.4 INSERT CHAR Key

The unshifted state of the  key causes all characters at and to the right of the cursor to move one column to the right. This action enters a space character at the cursor position. The character at column 80 is lost.

If protect mode is on, character insert operates from the cursor position to the end of the line or to the first protected field.

This action generates an ESC Q.

4.2.5.5 DELETE LINE Key

The shifted state of the  key deletes the entire line the cursor is positioned on. All remaining lines move up one line. The cursor will move to column 1 of the replaced line and space characters will be added to the last line of the screen. This function has no effect when Protect mode is on.

This action generates an ESC R.

4.2.5.6 INSERT LINE key

The unshifted state of the  key causes a line to be inserted consisting of spaces at the cursor position. This action moves the cursor to the start of the new line and all remaining lines down one line, resulting in the loss of the last line of the screen.

When Protect mode is on, this command has no effect.

This action generates an ESC E.

4.2.5.7 ERASE PAGE Key

The shifted state of the  key causes all unprotected characters starting from the cursor position to the end of the page, to disappear from the screen and be replaced with spaces if Protect mode is on. If Protect mode is off, all characters starting from the cursor position to the end of the page will disappear from the screen.

If the half intensity attribute is on, the characters are replaced with half intensity spaces.

This action generates an ESC Y.

4.2.5.8 ERASE LINE Key

The unshifted state of the  key causes all unprotected characters, starting from the cursor position to the end of the line, to be erased from the screen if protect mode is on. If protect mode is off, all characters, starting from the cursor position to the end of the line, will be erased. Space characters

will replace erased characters. If half intensity is enabled, the characters are replaced with half intensity spaces.

This action generates an ESC T.

4.2.6 Control Keys Group

The keys in this group perform special control functions (Figure 4-6).

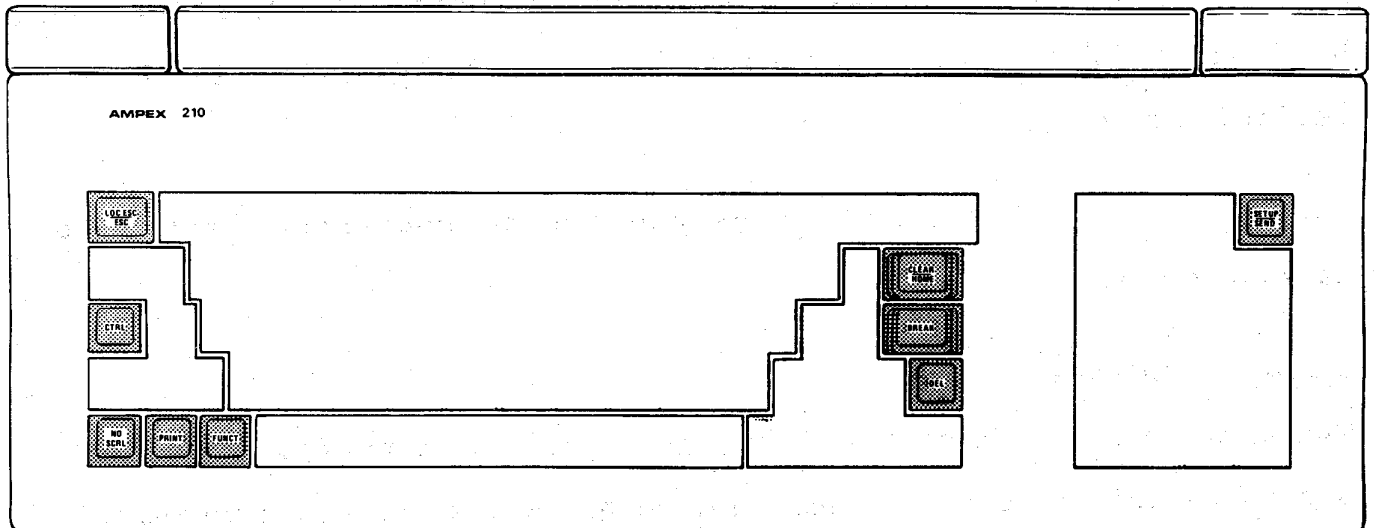



Figure 4-6. Control Keys Group

4.2.6.1 PRINT Key



When depressed, the  key causes the terminal to transmit, to a printer, all characters from the Home position to and including the current cursor position.

This key generates and ESC P.

4.2.6.2 FUNCT Key

When the  key is depressed first and then held down in conjunction with another alphanumeric key, a three-character code sequence is transmitted (e.g., "FUNCT/6" will transmit SOH 6 CR [carriage return]).

4.2.6.3 CTRL Key

The  (control) key is used as a prefix for control codes initiated at the terminal. To implement a control code, press and hold the  key while pressing the key corresponding to the desired function.

For a listing of control codes and escape sequences, refer to Appendix A or B.

4.2.6.4 ESC Key

The unshifted state of the  key is used as a prefix for escape sequences initiated at the terminal to allow the user to momentarily leave a program and perform a specific function. To implement an escape sequence at the terminal, press and release the **ESC** key. Then press the key corresponding to the desired function.

Depressing the ESC key also causes the next control character entered to be displayed without having to enter the monitor mode.

For a listing of escape sequences and control codes, refer to Appendix A or B.

4.2.6.5 LOC ESC Key

The shifted state of the  key causes local action only of escape sequences.

4.2.6.6 CLEAR Key

The shifted state of the  key generates the control code for clear unprotected to the space character. (**CTRL/Z**).

4.2.6.7 BREAK Key

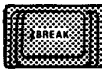
When the  key is pressed in conjunction with the CTRL key, a nondisplayable standard teletypewriter signal (a 250 millisecond break pulse) is transmitted to the host computer. Depressing the SHIFT key first and holding it down, then depressing the BREAK key twice will cause the terminal to reset.

4.2.6.8 DEL Key

The  key transmits a nondisplayable ASCII delete code to the host computer. Display memory is unaffected.

4.2.6.9 SETUP Key

Depression of the shifted state of the  key toggles the terminal in and out of Set-Up mode. The Set-Up mode consists of a series of parameter-selectable status lines (refer to Section III; Setting Up).

4.2.6.10 SEND Key

When depressed, the unshifted state of the  key causes unprotected blocks (in Block mode) or lines (in Line mode) to be sent to the host computer. The SEND key is effective only in Block or Line mode.

4.2.6.11 NO SCRL Key

When depressed, the  key toggles the host computer to stop scrolling the screen (i.e., transmitting characters to the terminal). A second depression of this key signals the host computer to resume scrolling.

SECTION V

OPERATION

5.1 USING THE OPERATING MODES

This section describes the various operating modes of the Ampex 210 terminal.

5.1.1 Full Duplex Conversational Mode (FDX)

In full duplex mode, all escape sequences, control codes, and data entered at the keyboard are sent to the host computer only. To select this mode, enter Set-Up mode and make the appropriate selection.

5.1.2 Half Duplex Conversational Mode (HDX)

This mode is the conversational alternative to full duplex mode. When in half duplex mode, all escape sequences, control codes, and data entered at the keyboard are sent to the display screen and host computer simultaneously. Half duplex mode may be selected while in Set-Up mode.

5.1.3 Character Mode

This operating mode provides for entry of data from the keyboard and for transmission of each character as it is received from the keyboard to the host computer.

The display of data as it is received from the keyboard will depend on what conversational mode is selected; i.e., full or half duplex.

To change this mode to another mode (block, line, or local) enter Set-Up mode and make the appropriate selection. Character mode may also be enabled with an **ESC C**.

5.1.4 Block Mode

When in Block mode, data is entered from the keyboard to the terminal display without immediate transmission to the host computer. It is entered in a protected format displayed on the screen, edited, and then transmitted in entirety or in unprotected parts only to the host computer.

Block mode may be selected while in Set-Up mode or enabled with an **ESC B**. To disable Block Mode, enter Set-Up mode and make another selection.

5.1.5 Line Mode

Line mode operates in the same manner as Block mode except that only the contents of the line, on which the cursor is positioned, are transmitted.

This mode may be selected while in Set-Up mode or enabled with an **ESC D**. To disable Line mode, enter Set-Up mode and make another selection.

5.1.6 Local Mode

Local mode provides for the local execution of terminal functions. In this mode, transmission of data and commands between the terminal and the host are prohibited.

This mode is enabled and disabled via the Set-Up mode.

5.1.7 Write Protect and Protect Modes

These modes allow the user to designate certain areas on the screen in half-intensity and to later protect them from change and transmission during operator input.

5.1.7.1 Write Protect Mode

When this mode is set, each written character will appear in half-intensity, designating a protected area, and when Protect mode is enabled, the cursor is prevented from entering the protected area. Write Protect is entered with an **ESC)** [before entering information] and is disabled with an **ESC (** [after entering information].

5.1.7.2 Protect Mode

This mode protects designated character positions (those positions written while in Write Protect mode). Protect mode is enabled while in the Set-Up mode or with an **ESC &** and can be disabled while in the Set-Up mode or with an **ESC '.**

5.1.8 Monitor Mode

Monitor mode permits the display of all characters, without interpretation, including all escape sequences and control characters. This mode may be enabled when in the Set-Up mode or by a **CTRL/1** and disabled in the Set-Up mode or by a **CTRL/2**.

For a listing of Monitor mode facsimile characters, refer to Appendix F.

5.2 EDITING MODES AND COMMANDS

The following paragraphs describe the editing modes and commands available on the Ampex 210 terminal.

5.2.1 Local Edit Mode

Local edit mode may be enabled while in the Set-Up mode or with an **ESC k**. When set to local edit mode, the following keys will affect only the display page (they are not transmitted to the host computer):

- | | |
|----------------|--------------------|
| o Back Space | o Back Tab |
| o Cursor Up | o Erase Line |
| o Cursor Down | o Erase Page |
| o Cursor Left | o Insert Character |
| o Cursor Right | o Delete Character |
| o Tab | o Insert Line |
| o Home | o Delete Line |

5.2.2 Duplex Edit Mode

Duplex edit mode may be enabled while in Set-Up mode or with an **ESC l** (lower case L). When set to duplex edit mode, those edit keys indicated in paragraph 5.2.1 will operate in the same manner as the alphanumeric keys (they will be transmitted to the host computer).

5.2.3 Edit Commands

The following paragraphs contain descriptions of the various edit commands available to the user.

5.2.3.1 Character Insert

This command may be executed either by depressing the **CHAR INSERT** key or by issuing an **ESC Q**. Execution of this command causes all characters at and to the right of the cursor to move one column to the right while inserting a space character at the cursor position. The character at column 80 is lost.

If Protect mode is on, this command will insert from the cursor position to the end of the line or to the start of the first protected field.

5.2.3.2 Character Delete

This command may either be executed by depressing the SHIFT DELETE CHAR keys or by issuing an **ESC W**. Execution of this command will delete the character at the cursor position and move the remaining characters of that same line one position to the left. At the end of the delete function, a space character will be written to column 80 of that line.

If Protect mode is on, character delete operates only from the cursor position to the end of the first unprotected field or line.

5.2.3.3 Line Insert

This command may either be executed by depressing the LINE INSERT key or by issuing an **ESC E**. This action inserts a line consisting of space characters at the cursor position. The result of this command causes the cursor to move to column 1 of the inserted line. This command has no effect when protect mode is on.

5.2.3.4 Line Delete

To execute a line delete command either depress the SHIFT/DELETE LINE keys or issue an **ESC R**. This action will delete the line the cursor is positioned on and move the remaining lines on the screen up one line.

At the completion of this command, the cursor will move to column 1 of the line replacing the deleted line and spaces will be written to the last line of the screen.

This command has no effect when protect mode is on.

5.2.3.5 Erase To End of Line

Erasing to the end of the line with spaces (**ESC T**) erases all unprotected characters from the cursor position to the end of the line and replaces them with space characters. If protect mode is on, only those characters from the cursor position to the first protected field are erased. If half-intensity is on, then half-intensity spaces replace the erased characters.

Erasing to the end of the line with nulls (**ESC t**) erases all unprotected characters starting from the cursor position to the end of the line and replaces them with null characters. If half-intensity is enabled, then half-intensity null characters will replace erased characters. If protect mode is on, only those characters starting from the cursor position to the end of the unprotected field are erased and then replaced with nulls.

NOTE

When the terminal is in the Qume QVT 102 emulation mode, all characters protected and unprotected, are erased with this command.

5.2.3.6 Erase To End of Screen

Erasing to the end of a screen with spaces (**ESC Y**) erases unprotected characters (Protect mode On), starting from the cursor position to the end of the screen and replaces those characters with spaces. When Protect mode is off, all characters, starting from the cursor position to the end of the screen, are erased. If half-intensity is on, erased characters are replaced with half-intensity space characters.

Erasing to the end of a screen with nulls (**ESC y**) erases all unprotected characters, starting from the cursor position to the end of the screen, and replaces them with null characters. If half-intensity mode is on, then half-intensity null characters will replace erased characters.

NOTE

When terminal is in the Qume QVT 102 emulation mode, all characters are erased, not just unprotected characters.

5.3 CLEAR FUNCTIONS

Clear functions are used to clear data from the display and/or the host computer memory. Since some of the clear commands during TeleVideo emulation and Qume emulation do not always correspond, a summary of those clear commands is shown in Table 5-1.

Table 5-1. Summary of Clear Commands

Command	Emulation Mode					
	A210	TV925	TV920	TV910+	TV910	QVT102
CLEAR UNPROTECTED TO NULLS	ESC:	ESC:	ESC:	ESC:		ESC:
CLEAR UNPROTECTED TO SPACES			ESC; CTRL/Z	ESC; ESC+ CTRL/Z		ESC;
CLEAR ALL TO NULLS	ESC*	ESC*	ESC*	ESC*	ESC*	ESC*
CLEAR ALL TO SPACES			ESC+		ESC+ CTRL/Z	ESC+ CTRL/Z
CLEAR UNPROT TO HALF INTENSITY SPACES	ESC,	ESC,		ESC,		
CLEAR ALL TO HALF-INTENSITY SPACES						ESC,
CLEAR UNPROT TO INSERT CHARACTER (DEFAULT = SPACE)	ESC; ESC+ CTRL/Z	ESC; ESC+ CTRL/Z				

5.4 SEND COMMANDS

There are six send commands available to the operator. These commands cause data to be transmitted from the display terminal to the host computer.

5.4.1 Send Line Unprotected

This command causes all unprotected characters from column 1 to and including the cursor position to be transmitted. Send line unprotected is initiated by an **ESC 4** or by depressing the SEND key while in Line mode. The result of this action sends an FS code (1C Hex)

The cursor must be positioned somewhere on the line being transmitted.

5.4.2 Send Line All

This command causes all data, from column 1 to, and including, the cursor position to be transmitted. This action is initiated by an **ESC 6**. This command also sends an **ESC)**, denoting the beginning of a protected field and an **ESC (**, denoting the end of a protected field. At the end of transmission, an end-of-message character will be sent. The result of this command causes attribute characters, as applicable, to be sent (the terminal automatically inserts the correct escape sequences) to the host computer.

The cursor must be positioned somewhere on the line being transmitted.

5.4.3 Send Page Unprotected

This command causes all unprotected characters from the Home position to, and including, the cursor position to be transmitted. Send page unprotected is initiated by an **ESC 5** or by depressing the **SEND** key while in Block mode. This command also sends an FS code (1C Hex) as a field delimiter in place of each protected field, an end-of-line character at the end of each line, and an end-of-message character at the end of the transmission.

5.4.4 Send Page All

This command causes all data, protected and unprotected, from the home position to, and including, the cursor position to be transmitted. This action is initiated by an **ESC 7**. This command also sends an **ESC)**, denoting the beginning of a protected field and an **ESC (**, denoting the end of a protected field. This command also sends an end-of-line character at the end of each line, and at the end of transmission an end-of-message character is sent.

5.4.5 Send UNPROTECTED Message

This command (**ESC S**) causes all unprotected data, bracketed by start of text (STX) and end of text (ETX) codes displayed on a screen, to be transmitted. After transmission, the cursor will be positioned after the ETX Code. If the screen contains no STX codes, transmission will begin from the Home position. If the screen contains no ETX codes, the terminal will transmit data to the end of the screen and the cursor will return to the Home position after the data is sent. If there are neither STX nor ETX codes, the entire screen will be transmitted.

This command sends an FS code (1C Hex) as a field delimiter in place of protected fields. It also sends an end-of-line character at the end of each line and an end-of-message character at the end of transmission.

5.4.6 SEND ENTIRE Message

This command, initiated by an **ESC s**, is similar to sending an unprotected message except that protected fields are also transmitted.

5.4.7 Terminator Character Selection

The terminal transmits delimiters (terminator characters) at the end of each transmitted line and at the end of text upon completion of each send command. Both line and page terminators are stored in nonvolatile memory and are not affected by power on/off transmission.

5.4.7.1 Line Terminator (Or End-Of-Line Character)

At the end of each transmitted line, a US (1FH Hex) is sent. This delimiter may be changed while in Set-Up mode or by entering an **ESC x 1 NN** (where NN is any two ASCII characters). The second character may be a null used as a filter code. For example, to change US to ETX, enter:

ESC x 1 CTRL/C (ETX) and CTRL/@ (null)

5.4.7.2 Page Terminator (Or End-Of-Message Character)

At the end of each transmitted page of text, a CR (carriage return) is sent. This delimiter may be changed while in Set-Up mode or for:

Ampex 210 and TeleVideo Emulation - Enter **ESC x 4NN**
(where NN is any two ASCII characters).

Qume QVT 102 Emulation - Enter **ESC x N** (where N is any ASCII character).

5.5 TABULATION

Cursor movement to designated areas on the screen may be initiated using the TAB and BACK TAB keys. There are two types of tab stops: column and field. Column tab stops are applicable only when protect mode is off and field tab stops are applicable only when Protect mode is on.

5.5.1 TAB Key

The TAB key (**CTRL/I**) moves the cursor forward to the next tab stop.

5.5.1.1 Protect Mode OFF

With Protect mode disabled the TAB key moves the cursor to the right to the next column tab stop. If no tab stops are set or if the cursor is on the last tab position, the cursor will not move.

5.5.1.2 Protect Mode ON

The TAB key moves the cursor to the first unprotected position following a protected field.

When protect mode is enabled, **ESC l** generates a vertical column of half-intensity spaces from the cursor position down the display column to the first write protected character or to the end of the page whichever comes first.

5.5.2 BACK Tab

The BACK TAB key (**ESC I**) moves the cursor backward to a previous tab stop.

5.5.2.1 Protect Mode OFF

When protect mode is off, the BACK TAB causes the cursor to go back to the previous tab position. If no tabs were set, or if the cursor is on the first tab position, the cursor will return to column 1 of the line.

5.5.2.2 Protect Mode ON

When protect mode is on, the BACK TAB key moves the cursor back to the start of the preceding unprotected field. If no unprotected fields precede the cursor's position, the cursor will not move.

5.5.3 Setting Tab Stops

Columnar tab stops (or typewriter tab stops) are set (when protect mode is off) by positioning the cursor at the desired column and then executing an ESC 1 from the keyboard or host.

The default tab stops at power-on are set at every eighth column, i.e., columns 8, 16, 24, 32, etc. To change these tab stops:

1. Clear all the default tab stops. Enter: **ESC 3**. (To clear individual tab stops, position the cursor at the applicable tab stop and enter **ESC 2**).
2. Position the cursor at the desired locations on the line and enter: **ESC 1**.
3. Enter Set-up Mode.
4. Execute a SHIFT/S to save the new tab stop(s) in nonvolatile memory. This action causes the new tab stop(s) to be in effect at power on.

Note: Tab stops cannot be cleared when protect mode is on.

5.5.4 Clearing Tab Stops

Columnar tab stops may be cleared when protect mode is off. **ESC 2** clears a single tab stop. **ESC 3** clears all tab stops.

5.6 Function Key Modes

There are two function key modes available to Ampex 210 operators and there are fourteen function key codes in all. In addition, some terminal emulations allow use of the function key modes:

Function Key Mode - For use with Ampex 210, TeleVideo 910+, 920, and 925 emulations.

Program Function Key Mode - For use with Ampex 210, TeleVideo 920, 925, and Qume QVT 102 emulations.

"FUNCT" Key with Numeric Keypad Mode - For use with TeleVideo 910 emulation only.

5.6.1 Function Key Mode

Using the FUNCT (Function) key in combination with another key enables transmission of a three-character sequence of commands.

To enter a function key command, press the FUNCT key and at the same time press another key. The first character which is transmitted will always be SOH (Control A). The second will be the ASCII character of the depressed key. The third character will always be a CR.

5.6.2. Program Function Key Mode

The program function key mode allows the operator to use the numeric keypad as function keys. To enable this mode, enter Set-Up mode and make the appropriate selection, or enter an **ESC c**. (Entering another **ESC c** will return the terminal to the numeric mode).

While in the Program (Funct)ion Key mode, unshifted numeric keys will transmit the codes listed in Table 5-2. If the terminal is in (Numer)ic mode, shifted numeric keys will operate as Function keys.

5.6.3 "FUNCT" Key with Numeric keypad Mode

This mode allows the operator to use the numeric keypad with the FUNCT key as function keys (Table 5-3).

Table 5-2. Function Key Code Sequences

Function Keys	Numeric Keypad key	Code Sequence TV920, TV925	Transmitted QVT102
F1	1	SOH @ CR	SOH @ CR
F2	2	SOH A CR	SOH A CR
F3	3	SOH B CR	SOH B CR
F4	4	SOH C CR	SOH C CR
F5	5	SOH D CR	SOH D CR
F6	6	SOH E CR	SOH E CR
F7	7	SOH F CR	SOH F CR
F8	8	SOH G CR	SOH G CR
F9	9	SOH H CR	SOH H CR
F10	0	SOH I CR	SOH I CR
F11	. (period)	SOH J CR	SOH J CR
F12	ENTER	SOH ` CR	SOH ` CR
F13	, (comma)	SOH a CR	SOH a CR
F14	- (minus)	SOH b CR	SOH b CR

Table 5-3. TeleVideo 910 "FUNCT" Key Code Sequences

Lead-In Key	Numeric Keypad Key	Code Sequence Transmitted
FUNCT	0	SOH @ CR
FUNCT	1	SOH A CR
FUNCT	2	SOH B CR
FUNCT	3	SOH C CR
FUNCT	4	SOH D CR
FUNCT	5	SOH E CR
FUNCT	6	SOH F CR
FUNCT	7	SOH G CR
FUNCT	8	SOH H CR
FUNCT	9	SOH I CR

5.6.4 ADDS Regent 20/25 and Viewpoint Program Function Key Mode

The ADDS Regent 20/25 and ADDS Viewpoint A1 and A2 emulations also utilize the Program Function Key mode. Tables 5-4 and 5-5 show the various code sequences transmitted for these emulations.

Table 5-4. ADDS Regent 20/25 Program Function Key Codes

Function Key	Numeric Keypad Key	Code Sequence Transmitted		
		Lead-In Code	ASCII Code	Terminator Code
F1	1	STX or ESC	1	CR or No Code
F2	2	STX or ESC	2	CR or No Code
F3	3	STX or ESC	3	CR or No Code
F4	4	STX or ESC	4	CR or No Code
F5	5	STX or ESC	5	CR or No Code
F6	6	STX or ESC	6	CR or No Code
F7	7	STX or ESC	7	CR or No Code
F8	8	STX or ESC	8	CR or No Code
F9	9	STX or ESC	9	CR or No Code
F10	10	STX or ESC	.	CR or No Code
F11	. (period)		CR	
F12	ENTER	STX or ESC	,	CR or No Code
F13	, (comma)		-	
F14	- (minus)			

Table 5-5. ADDS Viewpoint A1 and A2 Program Function Key codes

Function Key	Numeric Keypad Key	Code Sequences Transmitted
F1	1	STX 1
F2	2	STX 2
F3	3	STX 3
F4	4	STX !
F5	5	STX "
F6	6	STX #

5.7 Visual Attribute System

The Ampex 210 visual attributes provide reverse video, half-intensity, underline, flash, and blank. The attribute characters are normally displayed as a space on the screen. They also appear as a half intensity space on a reverse video background.

Attributes are implemented with an ESC G sequence followed by a parameter. Table 5-6 lists the attributes, possible combinations, and their respective escape sequences.

Table 5-6. Visual Attributes and Escape Sequences

Attribute(s)	Escape Sequences
Normal	ESC G0
Blank	ESC G1
Flash	ESC G2
Invisible Flash	ESC G3
Reverse Video	ESC G4
Invisible Reverse	ESC G5
Reverse Flash	ESC G6
Invisible Reverse Flash	ESC G7
Underline	ESC G8
Invisible Underline	ESC G9
Underline Flash	ESC G:
Invisible Underline Flash	ESC G;
Underline Reverse	ESC G<
Invisible Underline Reverse	ESC G=
Underline Reverse Flash	ESC G>
Invisible Underline Reverse Flash	ESC G?
Half Intensity On	ESC)
Half Intensity Off	ESC (

When used in combination with Protect Mode, all half intensity fields will denote a protected field. Half intensity fields do not take up a character space on the screen.

The entire screen may be reversed with an **ESC b** and returned to normal video with an **ESC d**. These codes do not take up a character space on the screen.

5.8 Setting The Time

An internal 12-hour clock provides the Ampex 210 terminal operator the opportunity to set the clock to the time of day. To do so, enter Set-Up mode and make the appropriate selection on Status Line 3, or:

Enter **ESC space 1n HH MM** (when in Local mode) or
SHIFT ESC Space N HH MM (when in Full Duplex mode)
 where N = A (am) or P (pm)
 HH = hours
 MM = minutes

Example:

To set the time to 3 o'clock in the afternoon, enter:

ESC space 1 P 03 00 (when in Local mode), or
SHIFT ESC Space 1 P 03 00 (when in Full Duplex mode)

The time of day may be read by entering Set-Up mode and advancing to Status Line 3. The time of day will also appear on a printout if a SHIFT/PRINT command is initiated after the time of day is set. The host computer may request the time by sending the following sequence:

ESC space 2

The Ampex 210 terminal will respond with a six-character code consisting of A (or P) HH MM CR.

5.9 PRINT FUNCTIONS

The Ampex 210 printer (auxiliary) port may be set for page print, transparent print, and copy print functions. If during a print operation, the printer connected to the auxiliary port cannot accept any more data, the printer may signal the terminal (lowering DTR signal) to stop sending data. The printer may then request the transmission of more data by signaling the terminal (raising DTR signal).

5.9.1 Page Print

Sends data from the Home position through the cursor position to the printer port. Initiate a Page Print command by an **ESC P**. This print mode prints page data exactly as entered including line delimiters (a carriage return and linefeed) at the end of each line. During the print process, the message "PTG" will appear on the status line. An ACK code (06 Hex) will be sent to the host computer at the end of the print process.

5.9.2 Transparent Print

When transparent print is in effect, escape sequences, control codes, and all characters received from the host computer are not acted upon, but are transmitted to the printer port. This print function is enabled by an **ESC `** and disabled by an **ESC a**.

5.9.3 Copy Print

This print function causes all subsequent data (including escape sequences and control codes) received by the terminal to be sent to the screen and to the printer port. Copy print is enabled by an **ESC @** and disabled by an **ESC A**.

5.9.4 Bidirectional Printer Port

This function allows a printer connected to the printer port to communicate directly with the computer while allowing screen editing to continue on the terminal. Bidirectional printer port is enabled by a **CTRL/R** and disabled by a **CTRL/T**.

SECTION VI

EMULATION MODES

6.1 INTRODUCTION

The Ampex 210 display terminal offers emulation of several terminal models without additional need of modifying host software. These emulations modes are operator-selectable while in the Set-Up mode.

6.2 EMULATION MODES

Descriptions of emulation modes are presented in an alphabetical order in the following paragraphs.

6.2.1 ADDS Regent 20/25 Mode

To emulate the ADDS, Regent 20/25, enter Set-Up mode and select R25 on Status Line 1. While in the Regent 20/25 mode, program function keys are available to the operator. Refer to Table 5-4 for a list of available function key code sequences.

6.2.2 ADDS Viewpoint

To emulate the ADDS Viewpoint terminal, enter Set-Up mode and select VP on Status Line 1. Program function keys are available to the operator while on Viewpoint emulation. Refer to Table 5-5 for a list of function key code sequences.

6.2.3 Hazeltine 1410 (1400) Mode

The Hazeltine 1400 and 1410 terminals are emulated when H1410 is selected in Set-Up mode. When using the German, French, Danish, Swedish, and Norwegian national character sets in conjunction with a Tilde (~) as the lead-in code (e.g. Lead = Hz~), the tilde is replaced with the appropriate national character or symbol (refer to Appendix D).

6.2.4 Hazeltine 1500 Mode

To emulate the Hazeltine 1500 terminal, select H1500 when in Set-Up mode. When using the optional national character sets in conjunction with a tilde (~) as the lead-in code (e.g. Lead = Hz~), the tilde is replaced with the appropriate national character or symbol (refer to Appendix D).

6.2.5 Lear Siegler ADM5 Mode

To emulate the Lear Siegler ADM5, ADM3, ADM 3A, and ADM 3A+ terminals, select ADM5 when in Set-Up mode. Also in Set-Up mode, ADM5 emulation offers the selection of the auxiliary port as a gating function (CTRL/N enables this feature; CTRL/O disables this feature) when AUX KB:AUX is selected. ADM5 also offers a keyboard lock function (CTRL/N locks the keyboard; CTRL/O from the host unlocks the keyboard) when AUX KB:KB is selected.

6.2.6 Qume QVT102 Mode

To emulate the Qume QVT102 terminal, select QT102 when in Set-Up mode. This emulation allows use of the Graphics mode and all of the printing functions. QVT102 emulation mode does not prevent protected characters from being erased when an ERASE command is issued (refer to paragraphs, 5.2.3.5 and 5.2.3.6).

6.2.7 TeleVideo 910 and 910+ Modes

To emulate the TeleVideo 910 and 910+ terminals, select TV910 and T910+, respectively, when in Set-Up mode. Escape sequences for the various visual attributes, as well as attribute delimiters for send operations, are listed in Table 6-1.

6.2.8 TeleVideo 920 Mode

To emulate the TeleVideo 920 terminal, select TV920 when in Set-Up mode. Escape sequences for the various visual attributes, as well as attribute delimiters for send operations, are listed in Table 6-1. When in this emulation, the transparent print feature is available.

6.2.9 TeleVideo 925 Mode

To emulate the TeleVideo 925 terminal, select TV925 when in Set-Up mode. Escape sequences for the various visual attributes, as well as attribute delimiters for send operations, are listed in Table 6-1.

The time of day is set by entering an ESC (space) l A (or P) HHMM where:

A = a.m., P = p.m.
 HH = hours
 MM = minutes

HH and MM must be two-digit entries. For example, to set the time of day to 1:15 p.m., enter:

```
ESC (space) l P 0 l 1 5
                p.m. hours minutes
```

Table 6-1. TeleVideo 910/910+/920/925/950 Visual Attributes

Attribute	Escape Sequence	Attribute Delimiter Control Code
Normal	ESC G0	DL
Blank	ESC G1	D1
Flash	ESC G2	D2
Invisible Flash	ESC G3	D3
Reverse Video	ESC G4	D4
Invisible Reverse	ESC G5	NK
Reverse Flash	ESC G6	SN
Invisible Reverse Flash	ESC G7	EB
Underline	ESC G8	CN
Invisible Underline	ESC G9	EM
Underline Flash	ESC G:	SB
Invisible Underline	ESC G;	ES
Underline Reverse	ESC G<	FS
Invisible Underline Reverse	ESC G=	GS
Underline Reverse Flash	ESC G>	RS
Invisible Underline Flash	ESC G?	US

6.3 Emulation Mode Escape Sequences

Table 6-2 provides a list of emulation mode escape sequences and control codes by function.

Table 6-2. Emulation Mode Escape Sequences and Control Codes

Function	AMPEX		ADDS		HAZELTINE		LEAR SIEGLER		QUME		TELEVIDEO		
	A210	R25	VP	1410	1500	ADM5	QT102	910	910+	925	920		
OPERATING MODES													
Block Mode ON	ESC B	--	--	--	--	--	ESC B	--	ESC B	ESC B	ESC B		
Character Mode ON	ESC C	--	--	--	--	--	ESC C	--	ESC C	ESC C	ESC C		
Line Mode ON	ESC D	--	--	--	--	--	ESC D	--	--	--	--		
Monitor Mode ON	CTRL/1 or ESC U	CTRL/1	CTRL/1	--	--	--	CTRL/1 or ESC U	CTRL/1 or ESC U	CTRL/1 or ESC U	ESC U	ESC U		
Monitor Mode OFF	ESC X	CTRL/2	CTRL/2	--	--	--	ESC X, or ESC u	ESC X, or ESC u	ESC X, or ESC u	ESC X, or ESC u	ESC X, or ESC u		
Protect Mode ON	ESC &	--	--	--	--	--	ESC &	--	ESC &	ESC &	ESC &		
Protect Mode OFF	ESC †	--	--	--	--	--	ESC †	--	ESC †	ESC †	ESC †		
Write Protect ON	ESC (--	--	--	--	--	ESC (ESC (ESC (ESC (ESC (
Write Protect OFF	ESC (--	--	--	--	--	ESC (ESC (ESC (ESC (ESC (
Jump Scroll ON	ESC 9	--	--	--	--	--	ESC 9	--	--	--	--		
Smooth Scroll ON	ESC 8	--	--	--	--	--	ESC 8	--	--	--	--		
Auto Scroll Mode ON/OFF	--	--	--	--	--	--	ESC H	ESC H	ESC H	--	--		
EDITING COMMANDS													
Set Local Edit	ESC k	--	--	--	--	--	ESC k	--	ESC k	ESC k	ESC k		
Set Duplex Edit	ESC l (1e L)	--	--	--	--	--	ESC l (1e L)	--	ESC l (1e L)	ESC l (1e L)	ESC l (1e L)		
Cursor Up	CTRL/K	CTRL/Z	CTRL/Z	CTRL/L	CTRL/K	CTRL/K	CTRL/K	CTRL/K	CTRL/K	CTRL/K	CTRL/K		
Cursor Down	CTRL/V	CTRL/F	CTRL/F	CTRL/P	CTRL/K	CTRL/L	CTRL/V	CTRL/V	CTRL/V	CTRL/V	CTRL/V		
Cursor Right	CTRL/H	CTRL/H or CTRL/U	CTRL/H or CTRL/U	CTRL/H	CTRL/H	CTRL/H	CTRL/H	CTRL/H	CTRL/H	CTRL/H	CTRL/H		
Cursor Left	CTRL/	CTRL/A	CTRL/A	CTRL/R	CTRL/H	CTRL/	CTRL/	CTRL/	CTRL/	CTRL/	CTRL/		
Cursor Home	CTRL/M	CTRL/M	CTRL/M	CTRL/M	CTRL/M	CTRL/M	CTRL/M	CTRL/M	CTRL/M	CTRL/M	CTRL/M		
Carriage Return	CTRL/J	CTRL/J	CTRL/J	CTRL/J	CTRL/J	CTRL/J	CTRL/J	CTRL/J	CTRL/J	CTRL/J	CTRL/J		
Linefeed	CTRL/J	CTRL/J	CTRL/J	CTRL/J	CTRL/J	CTRL/J	CTRL/J	CTRL/J	CTRL/J	CTRL/J	CTRL/J		
Reverse Linefeed	CTRL/J	CTRL/J	CTRL/J	CTRL/J	CTRL/J	CTRL/J	CTRL/J	CTRL/J	CTRL/J	CTRL/J	CTRL/J		
New Line	CTRL/I	CTRL/I	CTRL/I	CTRL/I	CTRL/I	CTRL/I	CTRL/I	CTRL/I	CTRL/I	CTRL/I	CTRL/I		
Tab	ESC I	ESC I	ESC I	ESC I	ESC I	ESC I	ESC I	ESC I	ESC I	ESC I	ESC I		
Back Tab	ESC 1	ESC 1	ESC 1	ESC 1	ESC 1	ESC 1	ESC 1	ESC 1	ESC 1	ESC 1	ESC 1		
Field Tab	ESC 1	ESC 1	ESC 1	ESC 1	ESC 1	ESC 1	ESC 1	ESC 1	ESC 1	ESC 1	ESC 1		
Set Column Tab	ESC 2	ESC 2	ESC 2	ESC 2	ESC 2	ESC 2	ESC 2	ESC 2	ESC 2	ESC 2	ESC 2		
Clear Column Tab	ESC 3	ESC 3	ESC 3	ESC 3	ESC 3	ESC 3	ESC 3	ESC 3	ESC 3	ESC 3	ESC 3		
Clear All Tabs	ESC Q	ESC Q	ESC Q	ESC Q	ESC Q	ESC Q	ESC Q	ESC Q	ESC Q	ESC Q	ESC Q		
Character Insert	ESC W	ESC W	ESC W	ESC W	ESC W	ESC W	ESC W	ESC W	ESC W	ESC W	ESC W		
Character Delete	ESC E	ESC E	ESC E	ESC E	ESC E	ESC E	ESC E	ESC E	ESC E	ESC E	ESC E		
Line Insert	ESC R	ESC R	ESC R	ESC R	ESC R	ESC R	ESC R	ESC R	ESC R	ESC R	ESC R		
Line Delete	ESC R	ESC R	ESC R	ESC R	ESC R	ESC R	ESC R	ESC R	ESC R	ESC R	ESC R		
Erase Line to Spaces	ESC T	ESC K	ESC K	ESC T	ESC T	ESC T	ESC T	ESC T	ESC T	ESC T	ESC T		
Erase Line to Nulls	ESC t	ESC k	ESC k	ESC t	ESC t	ESC t	ESC t	ESC t	ESC t	ESC t	ESC t		
Erase Page to Spaces	ESC Y	ESC k	ESC k	ESC Y	ESC Y	ESC Y	ESC Y	ESC Y	ESC Y	ESC Y	ESC Y		
Erase Page to Nulls	ESC y	ESC k	ESC k	ESC y	ESC y	ESC y	ESC y	ESC y	ESC y	ESC y	ESC y		
Erase Page to Background space	--	--	--	CTRL/W	CTRL/W	--	--	--	--	--	--		
Clear Foreground Clear All to Nulls	ESC *	ESC *	ESC *	CTRL/]	CTRL/]	ESC *	ESC *	ESC *	ESC *	ESC *	ESC *		

Table 6-2. Emulation Mode Escape Sequences and Control Codes (cont.)

Function	AMPEX	ADDS		HAZELTINE		LEAR	QUME	TELEVIDEO			
	A210	R25	VP	1410	1500	SIEGLER ADM5	QT102	910	910+	925	920
EDITING COMMANDS (Cont.)											
Clear All to Spaces	-- CTRL/Z or ESC #	CTRL/L	CTRL/L	~CTRL/\	~CTRL/\	CTRL/Z	CTRL/Z	CTRL/Z	-- CTRL/Z, ESC +, or ESC ;	-- CTRL/Z, ESC +, or ESC ;	ESC + CTRL/Z
Clear Unprotected to Spaces	ESC :	--	--	--	--	--	ESC :	--	ESC :	ESC :	ESC :
Clear Unprotected to Nulls	ESC ,	--	--	--	--	--	--	--	ESC ,	ESC ,	--
Clear Unprotected to Half-Intensity	--	--	--	--	--	--	ESC ,	--	--	--	--
SEND COMMANDS											
Send Line All	ESC 6	--	--	--	--	--	ESC 6	--	ESC 6	ESC 6	ESC 6
Send Line Unprotected	ESC 4	--	--	--	--	--	ESC 4	--	ESC 4	ESC 4	ESC 4
Send Page All	ESC 7	--	--	--	--	--	ESC 7	--	ESC 7	ESC 7	ESC 7
Send Page Unprotected	ESC 5	--	--	--	--	--	ESC 5	--	ESC 5	ESC 5	ESC 5
Send Message All	ESC s	--	--	--	--	--	--	--	ESC s	ESC s	ESC s
Send Message Unprotected	ESC S	--	--	--	--	--	--	--	ESC S	ESC S	ESC S
Send ID Message	CTRL/E	--	--	--	--	CTRL/E	CTRL/E	--	--	--	--
Program Line Terminator	ESC x1nn ¹	--	--	--	--	--	--	--	ESC x1nn ¹	ESC x1nn ¹	--
Program Page Terminator	ESC x4nn ¹	--	--	--	--	--	ESC xn ¹	--	ESC x4nn ¹	ESC x4nn ¹	--
Send Character	--	--	--	--	--	--	--	--	--	--	--
TRANSMISSION COMMANDS											
Enable XON/XOFF Protocol	CTRL/O	--	--	--	--	--	--	--	CTRL/O	CTRL/O	--
Disable XON/XOFF Protocol	CTRL/N	--	--	--	--	--	--	--	CTRL/N	CTRL/N	--
PRINT COMMANDS											
Page Print (From Home to Cursor)	ESC P	--	--	--	--	--	ESC N	--	--	ESC P	ESC P
Print Page (From Cursor to End)	--	--	--	--	--	--	ESC O	--	--	--	--
Page Print (Entire Screen)	--	--	--	--	--	--	ESC P	--	--	--	--

1 n = any ASCII Character
 2 From Host
 3 NHHMM -- N = A(am) or P(pm); HH=hours; MM=minutes
 4 = See Appendix C

Table 6-2. Emulation Mode Escape Sequences and Control Codes (cont.)

Function	AMPEX	ADDS	HAZELTIME	LEAR	QUIMS	TELEVIDEO			
	A210	R25	1#10	1500	ADM5	QT102	910	910+	920
PRINT COMMANDS (Cont.)									
Copy Print ON	ESC @	CTRL/R	--	CTRL/N (GT)	ESC @	ESC @	ESC @	ESC @	ESC @
Copy Print OFF	ESC A	CTRL/T	--	CTRL/O (GT)	ESC A	ESC A	ESC A	ESC A	ESC A
Transparent Print ON	ESC `	ESC 3	--	--	CTRL/R	ESC `	ESC `	ESC `	--
Transparent Print OFF	ESC a	ESC 4	--	--	CTRL/T	ESC a	ESC a	ESC a	--
Program Print Terminator	ESC pn ¹	--	--	--	--	ESC pn ¹	ESC pn ¹	ESC pn ¹	--
Bidirectional Print ON	CTRL/R	--	--	--	--	CTRL/R	CTRL/R	CTRL/R	--
Bidirectional Print OFF	CTRL/T	--	--	--	--	CTRL/T	CTRL/T	CTRL/T	--
SPECIAL FUNCTIONS AND MISCELLANEOUS COMMANDS									
Alarm (Beep)	CTRL/G	CTRL/G	--	CTRL/G	CTRL/G	CTRL/G	CTRL/G	CTRL/G	CTRL/G
Alignment E Pattern	--	--	--	CTRL/S	--	ESC V	ESC V	ESC V	--
Test Pattern	ESC V	--	--	--	ESC >	ESC >	ESC >	ESC >	--
Keystick ON	ESC <	--	--	--	ESC <	ESC <	ESC <	ESC <	--
Keystick OFF	ESC #	ESC 5 or CTRL/D	CTRL/U	CTRL/U	ESC #	ESC #	ESC #	ESC #	ESC #
Keyboard Lock ²	ESC "	ESC 6 or CTRL/B	CTRL/F	CTRL/F	ESC "	ESC "	ESC "	ESC "	ESC "
Keyboard Unlock ²	ESC \$	ESC 6 or CTRL/B	--	--	ESC \$	ESC \$	ESC \$	ESC \$	--
Graphic Mode ON	ESC %	--	--	--	ESC %	ESC %	ESC %	ESC %	--
Graphic Mode OFF	ESC space	--	--	--	ESC space	ESC space	ESC space	ESC space	--
Set Time of Day	1NHMM ³	--	--	--	1NHMM ³	ESC space 3	ESC space 3	ESC space 3	--
Read Time	ESC space 2	--	--	--	ESC space 2	ESC space 2	ESC space 2	ESC space 2	--
Print Time of Day	ESC L	--	--	--	ESC L	ESC L	ESC L	ESC L	--
Display Control Characters	ESC F	ESC Z	--	--	ESC F	ESC F	ESC F	ESC F	ESC F
Display Status Line	ESC }	--	--	--	ESC }	ESC }	ESC }	ESC }	--
Status Line OFF	ESC {	--	--	--	ESC {	ESC {	ESC {	ESC {	--
Write Message to User Line	ESC f	--	--	--	ESC f	ESC f	ESC f	ESC f	--
Display User Line Message	ESC g	--	--	--	ESC g	ESC g	ESC g	ESC g	--
User Line OFF	ESC h	--	--	--	ESC h	ESC h	ESC h	ESC h	--

¹ n = any ASCII Character
² From Host
³ NHMM -- N = A(am) or P(pm); HH=hours; MM=minutes
⁴ = See Appendix C

Table 6-2. Emulation Mode Escape Sequences and Control Codes (cont.)

Function	AMPEX A210		ADDS VP		HAZELTINE 1410 1500		LEAR SIEGLER ADM5	QUME QT102	910	910+	TELEVIDEO 925 920	
	CURSORS											
CURSOR ADDRESS												
Cursor Enable	--	--	CTRL/X		--		--	--	--	--	--	--
Cursor Disable	--	--	CTRL/W		--		--	--	--	--	--	--
Address Cursor (Row, Column)	--	ESC Y	ESC Y		--		ESC =	ESC =	ESC =	ESC =	ESC =	ESC =
Address Cursor (Row)	--	CTRL/K	CTRL/K		--		ESC [ESC [ESC [ESC [ESC [ESC [
Address Cursor (Column)	--	CTRL/P	CTRL/P		--		ESC]	ESC]	ESC]	ESC]	ESC]	ESC]
Read Cursor (Row, Column)	--	--	--		--		ESC ?	ESC ?	ESC ?	ESC ?	ESC ?	ESC ?
Address Cursor (Column, Row)	--	--	~CTRL/Q	~CTRL/Q	--		--	--	--	--	--	--
Read Cursor (Page, Row, Column)	--	--	~CTRL/E	~CTRL/E	--		--	--	--	--	--	--
Read Cursor (Page, Row, Column)	--	--	--		--		--	--	--	--	--	--
Flashing Block Cursor	ESC .1	--	--		--		--	--	ESC .1	ESC .1	ESC .1	ESC .1
Steady Block Cursor	--	--	--		--		--	--	ESC .2	ESC .2	ESC .2	ESC .2
Flashing Underline Cursor	--	--	--		--		--	--	ESC .3	ESC .3	ESC .3	ESC .3
Steady Underline Cursor	--	--	--		--		--	--	ESC .4	ESC .4	ESC .4	ESC .4
Cursor OFF	ESC .0	--	--		--		--	--	ESC .0	ESC .0	ESC .0	ESC .0
Cursor Visible/Invisible	--	--	--		--		ESC .	ESC .	ESC .	ESC .	ESC .	ESC .
VISUAL ATTRIBUTES												
Normal Video	ESC G0	--	--		--		ESC G0	ESC G0	ESC G0	ESC G0	ESC G0	ESC G0
Blank	ESC G1	--	--		--		ESC G1	ESC G1	ESC G1	ESC G1	ESC G1	ESC G1
Flash	ESC G2	--	--		--		ESC G2	ESC G2	ESC G2	ESC G2	ESC G2	ESC G2
Invisible Flash	ESC G3	--	--		--		ESC G3	ESC G3	ESC G3	ESC G3	ESC G3	ESC G3
Reverse	ESC G4	--	--		--		ESC G4	ESC G4	ESC G4	ESC G4	ESC G4	ESC G4
Invisible Reverse	ESC G5	--	--		--		ESC G5	ESC G5	ESC G5	ESC G5	ESC G5	ESC G5
Reverse Flash	ESC G6	--	--		--		ESC G6	ESC G6	ESC G6	ESC G6	ESC G6	ESC G6
Invisible Reverse Flash	ESC G7	--	--		--		ESC G7	ESC G7	ESC G7	ESC G7	ESC G7	ESC G7
Underline	ESC G8	--	--		--		ESC G8	ESC G8	ESC G8	ESC G8	ESC G8	ESC G8
Invisible	ESC G9	--	--		--		ESC G9	ESC G9	ESC G9	ESC G9	ESC G9	ESC G9
Underline	ESC G:	--	--		--		ESC G:	ESC G:	ESC G:	ESC G:	ESC G:	ESC G:
Underline Flash	ESC G;	--	--		--		ESC G;	ESC G;	ESC G;	ESC G;	ESC G;	ESC G;
Invisible Underline	ESC G<	--	--		--		ESC G<	ESC G<	ESC G<	ESC G<	ESC G<	ESC G<
Underline Reverse	ESC G=	--	--		--		ESC G=	ESC G=	ESC G=	ESC G=	ESC G=	ESC G=
Invisible Underline Reverse	ESC G>	--	--		--		ESC G>	ESC G>	ESC G>	ESC G>	ESC G>	ESC G>

Table 6-2. Emulation Mode Escape Sequences and Control Codes (cont.)

Function	AMPEX A210		ADDS B25 VP		HAZELTINE 1410 1500		LEAR SIEGLER ADM5	QUME QT102	910	910+	925	920
	TELEVIDEO											
VISUAL_ATTRIBUTES (Cont.)												
Invisible Under- line Reverse	ESC G?	--	--	--	--	--	--	ESC G?	ESC G?	ESC G?	ESC G?	ESC G?
Flash	ESC b	--	--	--	--	--	--	--	--	--	ESC b	--
Black on White	ESC d	--	--	--	--	--	--	--	--	--	ESC d	--
White on Black	ESC n	--	--	--	--	--	--	--	--	--	ESC n	--
Normal Screen	ESC o	--	--	--	--	--	--	--	--	--	ESC o	--
Blank Screen	--	--	--	--	--	--	--	--	--	--	--	--
Tag Bit Set	--	--	CTRL/N	--	--	--	--	--	--	--	--	--
Tag Bit Reset	--	--	CTRL/O	--	--	--	--	--	--	--	--	--
Set Attribute	--	--	ESC O	--	--	--	--	--	--	--	--	--
Background Follows	--	--	--	--	~CTRL/Y	--	--	--	--	--	--	--
Foreground Follows	--	--	--	--	~CTRL/_	--	--	--	--	--	--	--
Reverse Video	--	--	--	--	--	--	ESC G	--	--	--	--	--
ON/OFF	--	--	--	--	--	--	ESC)	--	--	--	--	--
Half-Intensity	--	--	--	--	--	--	ESC (--	--	--	--	--
ON	--	--	--	--	--	--	--	--	--	--	--	--
Half-Intensity	--	--	--	--	--	--	--	--	--	--	--	--
OFF	--	--	--	--	--	--	--	--	--	--	--	--

APPENDIX A

ESCAPE SEQUENCES AND CONTROL CODES

Function	Escape Sequence or Control Code	Key
<u>OPERATING MODES</u>		
Block Mode On	ESC B	
Character Mode On	ESC C	
Line Mode On	ESC D	
Monitor Mode On	CTRL/1 or ESC U	
Monitor Mode Off	CTRL/2, ESC X, or ESC u	
Protect Mode On	ESC &	
Protect Mode Off	ESC '	
Write Protect On	ESC)	
Write Protect Off	ESC (
Jump Scroll On	ESC 9	
Smooth Scroll On	ESC 8	
Function Key Mode On/Off	ESC c	
<u>EDITING COMMANDS</u>		
Set Local Edit	ESC k	
Set Duplex Edit	ESC l (lower case L)	
Cursor Up	CTRL/K	↑
Cursor Down	CTRL/V	↓
Cursor Left	CTRL/H	←
Cursor Right	CTRL/L	→
Cursor Home	CTRL/^	CLEAR HOME
Carriage Return	CTRL/M	RETURN
Linefeed	CTRL/J	LINEFEED OR SHIFT/↓
Reverse Linefeed	ESC j	
New Line	CTRL/-	
Tab	CTRL/I	TAB
Back Tab	ESC I	BACK TAB
Field Tab	ESC i	TAB
Set Column Tab	ESC 1	
Clear Column Tab	ESC 2	
Clear All Tabs	ESC 3	
Character Insert	ESC Q	DEL CHAR INS
Character Delete	ESC W	SHIFT/DEL CHAR INS
Line Insert	ESC E	DEL LINE INS
Line Delete	ESC R	SHIFT/DEL LINE INS
Erase Line to Spaces	ESC T	PAGE ERASE LINE
Erase Line to Nulls	ESC t	
Erase Page to Spaces	ESC Y	SHIFT/PAGE ERASE LINE
Erase Page to Nulls	ESC y	
Clear All to Nulls	ESC #	
Clear Unprotected to Spaces	CTRL/Z, ESC +	SHIFT/CLEAR HOME
Clear Unprotected to Nulls	ESC :	

ESCAPE SEQUENCES AND CONTROL CODES (Cont.)

Function	Escape Sequence or Control Code	Key	
<u>SEND COMMANDS</u>			
Clear Unprotected to Half-Intensity	ESC ,		
Send Line All	ESC 6		
Send Line Unprotected	ESC 4		
Send Page All	ESC 7		
Send Page Unprotected	ESC 5		
Send Message All	ESC s		
Send Message Unprotected	ESC S		
Program Line Terminator	ESC x1n ¹		
Program Page Terminator	ESC x4n ¹		
<u>TRANSMISSION COMMANDS</u>			
Enable XON/XOFF Protocol	CTRL/O		
Disable XON/XOFF Protocol	CTRL/N		
<u>PRINT COMMANDS</u>			
Page Print	ESC P	PRINT	
Copy Print On	ESC @		
Copy Print Off	ESC A		
Transparent Print On	ESC `		
Transparent Print Off	ESC a		
Program Print Terminator	ESC pn ¹		
Bidirectional Print On	CTRL/R		
Bidirectional Print Off	CTRL/T		
<u>SPECIAL FUNCTIONS AND MISCELLANEOUS COMMANDS</u>			
Alarm (beep)	CTRL/G		
Test Pattern	ESC V		
Keyclick ON	ESC >		
Keyclick OFF	ESC <		
Keyboard Lock	ESC # ²		
Keyboard Unlock	ESC n ²		
Graphic Mode On	ESC \$		
Graphic Mode Off	ESC %		
Set Time of Day	ESC space 1NHHMM ³		
Print Time of Day	ESC L		
Read Time	ESC space 2		

- ¹ = Any ASCII character
² = From Host
³ = NHHMM; N = A (am), P (pm), HH = hours, MM = minutes

ESCAPE SEQUENCES AND CONTROL CODES (Cont.)

Function	Escape Sequence or Control Code	Key
<u>SPECIAL FUNCTIONS AND MISCELLANEOUS COMMANDS</u> (CONT.)		
25th Line On	ESC }	
25th Line Off	ESC {	
Write Message to User Line	ESC f	
Display User Line Message	ESC g	
Display Status Line	ESC h	
Display Control Character	ESC F	
 <u>CURSOR ADDRESSES</u>		
Address Cursor (Row, Column)	ESC =	
Address Cursor (Row)	ESC [
Address Cursor (Column)	ESC]	
Read Cursor (Row, Column)	ESC ?	
Flashing Block Cursor	ESC .1	
Steady Block Cursor	ESC .2	
Flashing Underline Cursor	ESC .3	
Steady Underline Cursor	ESC .4	
Cursor Off	ESC .0	
 <u>VISUAL ATTRIBUTES</u>		
Normal Video	ESC G0	
Blank <i>darkel</i>	ESC G1	
Flash	ESC G2	
Invisible Flash	ESC G3	
Reverse	ESC G4	
Invisible Reverse	ESC G5	
Reverse Flash	ESC G6	
Invisible Reverse Flash	ESC G7	
Underline	ESC G8	
Invisible Underline	ESC G9	
Underline Flash	ESC G:	
Invisible Underline Flash	ESC G;	
Underline Reverse	ESC G<	
Invisible Underline Reverse	ESC G=	
Underline Reverse Flash	ESC G>	
Invisible Underline Reverse Flash	ESC G?	
Black on White	ESC b	
White on Black	ESC d	
Normal Screen	ESC n	
Blank Screen	ESC o	

APPENDIX B. ASCII CODE CHART

<div style="display: flex; align-items: center;"> <div style="margin-right: 10px;"> <p style="margin: 0;">b7</p> <p style="margin: 0;">b6</p> <p style="margin: 0;">b5</p> </div> <div style="margin-right: 10px;"> <p style="margin: 0;">→</p> <p style="margin: 0;">→</p> <p style="margin: 0;">→</p> </div> </div>					0	0	0	0	1	1	1	1	
					0	0	1	1	0	0	1	1	
					0	1	2	3	4	5	6	7	
Bits	b4	b3	b2	b1	Column →								
					Row ↓	0	1	2	3	4	5	6	7
0	0	0	0	0	0	NUL	DLE	SP ³²	0 ⁴⁸	@	P	`	p
0	0	0	1	1	1	SOH	DC1	! ³³	1 ⁴⁹	A	Q	a ⁹⁷	q
0	0	1	0	2	2	STX	DC2	" ³⁴	2 ⁵⁰	B	R	b ⁹⁸	r
0	0	1	1	3	3	ETX	DC3	# ³⁵	3 ⁵¹	C	S	c ⁹⁹	s
0	1	0	0	4	4	EOT	DC4	\$ ³⁶	4 ⁵²	D	T	d ¹⁰⁰	t
0	1	0	1	5	5	ENQ	NAK	% ³⁷	5 ⁵³	E	U	e	u
0	1	1	0	6	6	ACK	SYN	& ³⁸	6 ⁵⁴	F	V	f	v
0	1	1	1	7	7	BEL	ETB	' ³⁹	7 ⁵⁵	G	W	g	w
1	0	0	0	8	8	BS	CAN	(⁴⁰	8 ⁵⁶	H	X	h	x
1	0	0	1	9	9	HT	EM) ⁴¹	9 ⁵⁷	I	Y	i	y
1	0	1	0	A	A	LF	SUB	. ⁴²	: ⁵⁸	J	Z	j	z
1	0	1	1	B	B	VT	ESC	+ ⁴³	; ⁵⁹	K	[k	{
1	1	0	0	C	C	FF	FS	, ⁴⁴	< ⁶⁰	L	\	l	
1	1	0	1	D	D	CR	GS	- ⁴⁵	= ⁶¹	M]	m	}
1	1	1	0	E	E	SO	RS	* ⁴⁶	> ⁶²	N	^	n	~
1	1	1	1	F	F	SI	US	/ ⁴⁷	? ⁶³	O	_	o	DEL

32 ASCII
Control
Codes

96 ASCII
Character Set

Notes:

o Hexadecimal = ASCII Column + Row A = 41 Hex















o ASCII Encoded Letter A = Bits: P7654321
#1000001

(* = Parity Bit)

APPENDIX C

LINE GRAPHIC SYMBOLS

Fifteen line graphic symbols may be displayed on the screen when the terminal is in the Graphics Mode. Select GFX ON when in Set-Up Mode (refer to Table 3-1) or enable Graphics Mode by an ESC \$ and disable with and ESC %. The terminal must be in Ampex 210 or Qume QVT102 mode to enable graphics feature.

Description	Symbol	Key
Bottom Left Curve		a
Top Left Curve		b
Top Right Curve		c
Bottom Right Curve		d
Bottom Left Corner		e
Top Left Corner		f
Top Right Corner		g
Bottom Right Corner		h
Crossed Lines		i
Vertical Line		j
Horizontal Line		k
Right Intersection		l
Left Intersection		m
Top Intersection		n
Bottom Intersection		o

APPENDIX D
NATIONAL CHARACTER SETS

Any one of six national character sets may be selected when in Set-Up mode (refer to Table 3-1). The U.S./U.K. keycap is standard on each unit (see Figure 4-1). Optional German, French, Swedish, Norwegian, and Danish keycap sets are available for the alternate national character sets.

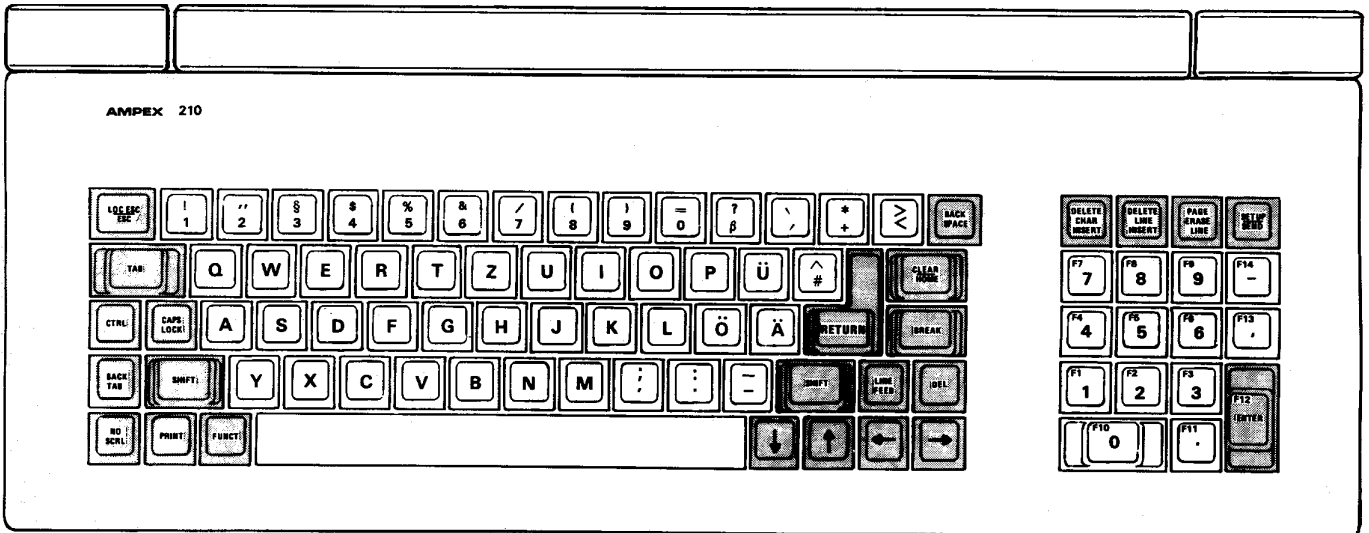
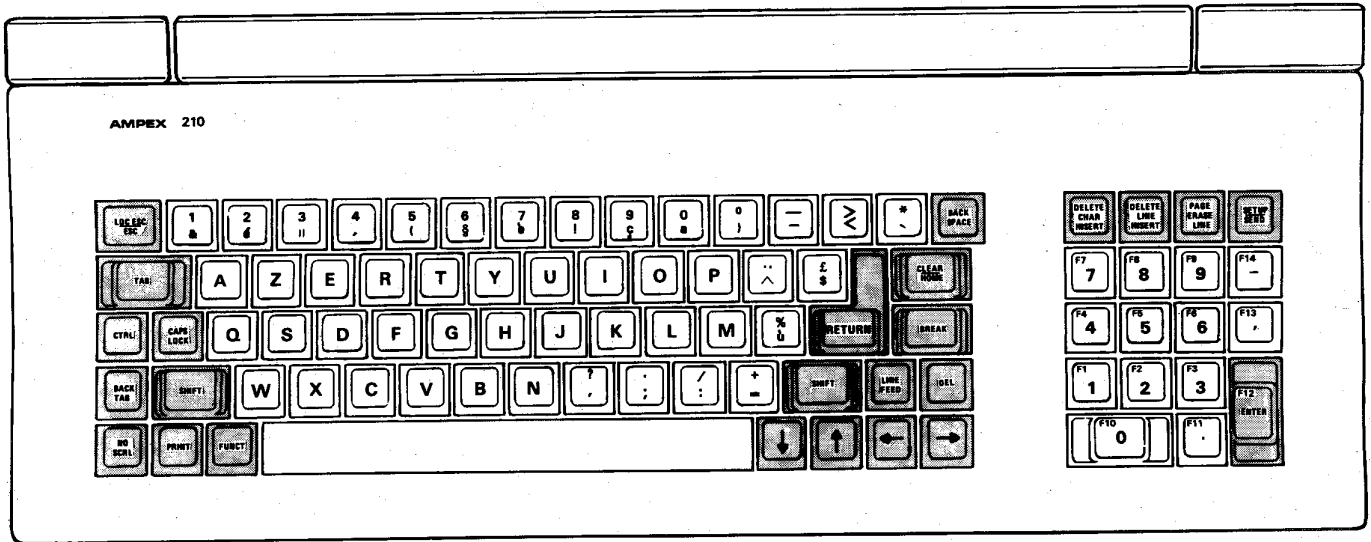
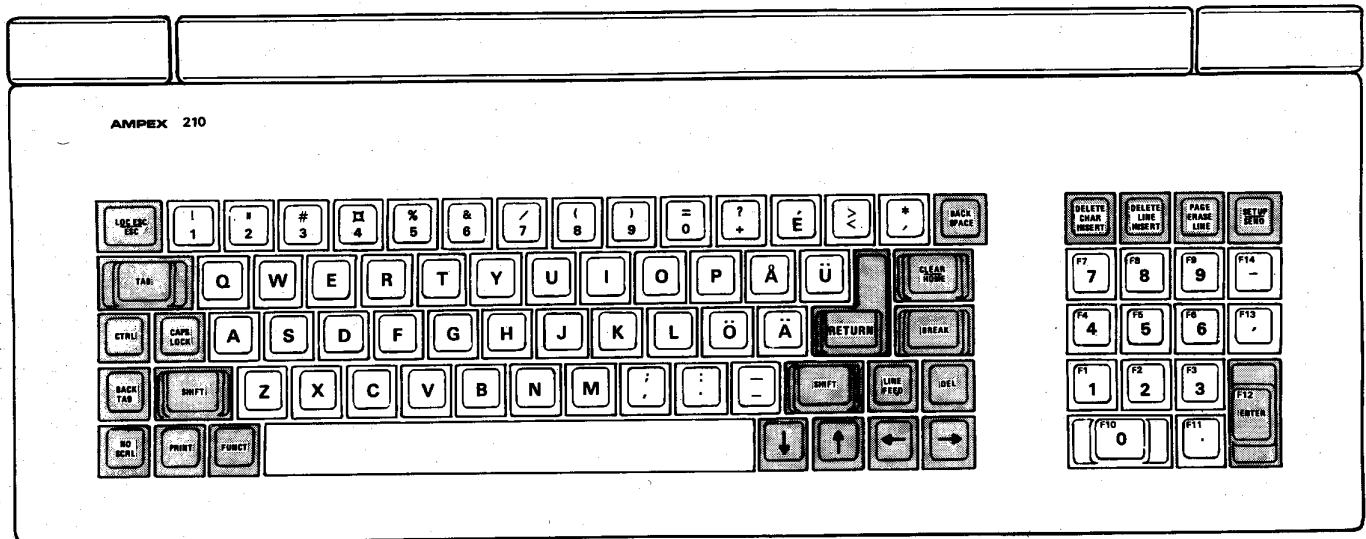

Figure D-1. Optional German Keyboard



6006

Figure D-2. Optional French Keyboard



6006

Figure D-3. Optional Swedish Keyboard

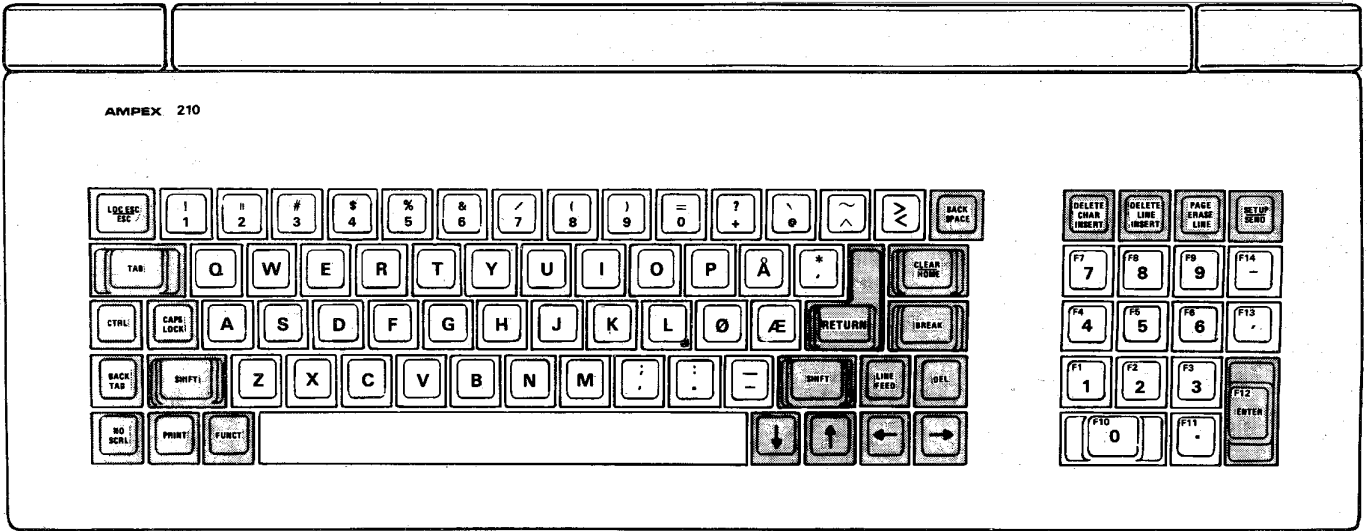

0096

Figure D-4. Optional Norwegian Keyboard

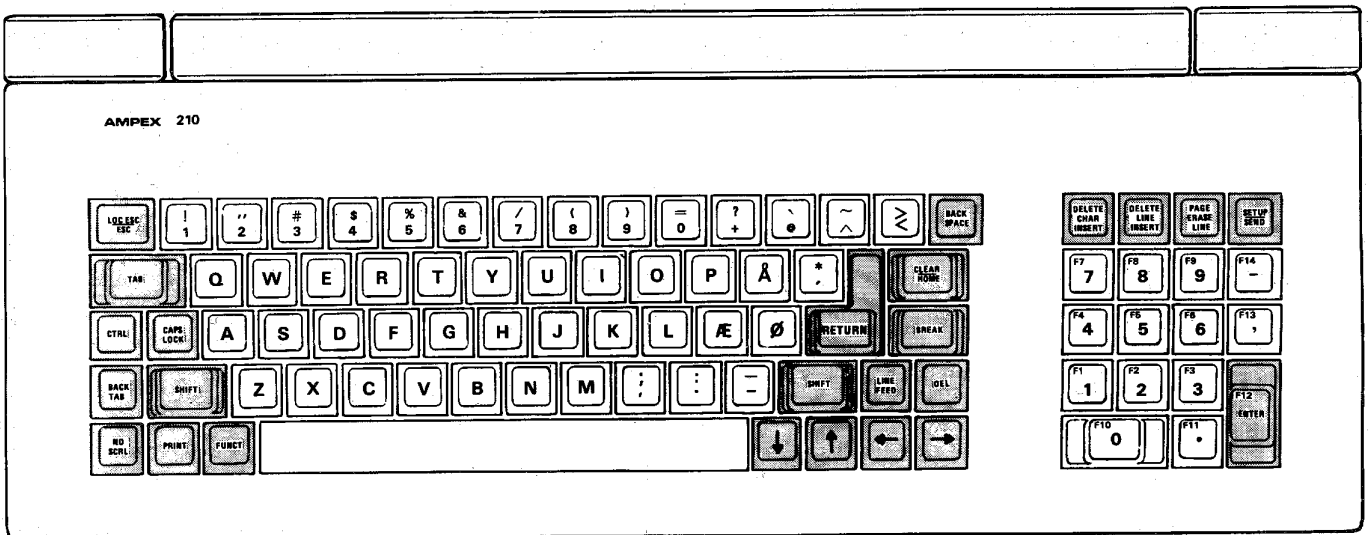

0096

Figure D-5. Optional Danish Keyboard

HEX CODE	23	24	40	5B	5C	5D	5E	60	7B	7C	7D	7E
UNITED STATES	#	\$	@	[\]	^	`	{		}	~
UNITED KINGDOM	£	\$	@	[\]	^	`	{		}	~
FRENCH (AZERTY)	£	\$	à	°	§	§	^	`	é	ù	è	..
GERMAN	#	\$	§	Ä	Ö	Ü	^	`	ä	ö	ü	ß
SWEDISH	#	¤	É	Ä	Ö	Å	Ü	é	ä	ö	å	ü
NORWEGIAN	#	\$	@	Æ	Ø	Å	^	`	æ	ø	å	~
DANISH	#	\$	@	Æ	Ø	Å	^	`	æ	ø	å	~

6146

Figure D-6. National Characters and Special Symbols

APPENDIX E
CURSOR ADDRESSES

Line			Column					
Line	Address (Hex)	Code	Column	Address (Hex)	Code	Column	Address (Hex)	Code
1	20	Space	1	20	Space	41	48	H
2	21	!	2	21	!	42	49	I
3	22	"	3	22	"	43	4A	J
4	23	#	4	23	#	44	4B	K
5	24	\$	5	24	\$	45	4C	L
6	25	%	6	25	%	46	4D	M
7	26	&	7	26	&	47	4E	N
8	27	'	8	27	'	48	4F	O
9	28	(9	28	(49	50	P
10	29)	10	29)	50	51	Q
11	2A	*	11	2A	*	51	52	R
12	2B	+	12	2B	+	52	53	S
13	2C	,	13	2C	,	53	54	T
14	2D	-	14	2D	-	54	55	U
15	2E	.	15	2E	.	55	56	V
16	2F	/	16	2F	/	56	57	W
17	30	0	17	30	0	57	58	X
18	31	1	18	31	1	58	59	Y
19	32	2	19	32	2	59	5A	Z
20	33	3	20	33	3	60	5B	[
21	34	4	21	34	4	61	5C	\
22	35	5	22	35	5	62	5D]
23	36	6	23	36	6	63	5E	
24	37	7	24	37	7	64	5F	
			25	38	8	65	60	^
			26	39	9	66	61	a
			27	3A	:	67	62	b
			28	3B	;	68	63	c
			29	3C	<	69	64	d
			30	3D	=	70	65	e
			31	3E	>	71	66	f
			32	3F	?	72	67	g
			33	40	@	73	68	h
			34	41	A	74	69	i
			35	42	B	75	6A	j
			36	43	C	76	6B	k
			37	44	D	77	6C	l
			38	45	E	78	6D	m
			39	46	F	79	6E	n
			40	47	G	80	6F	o

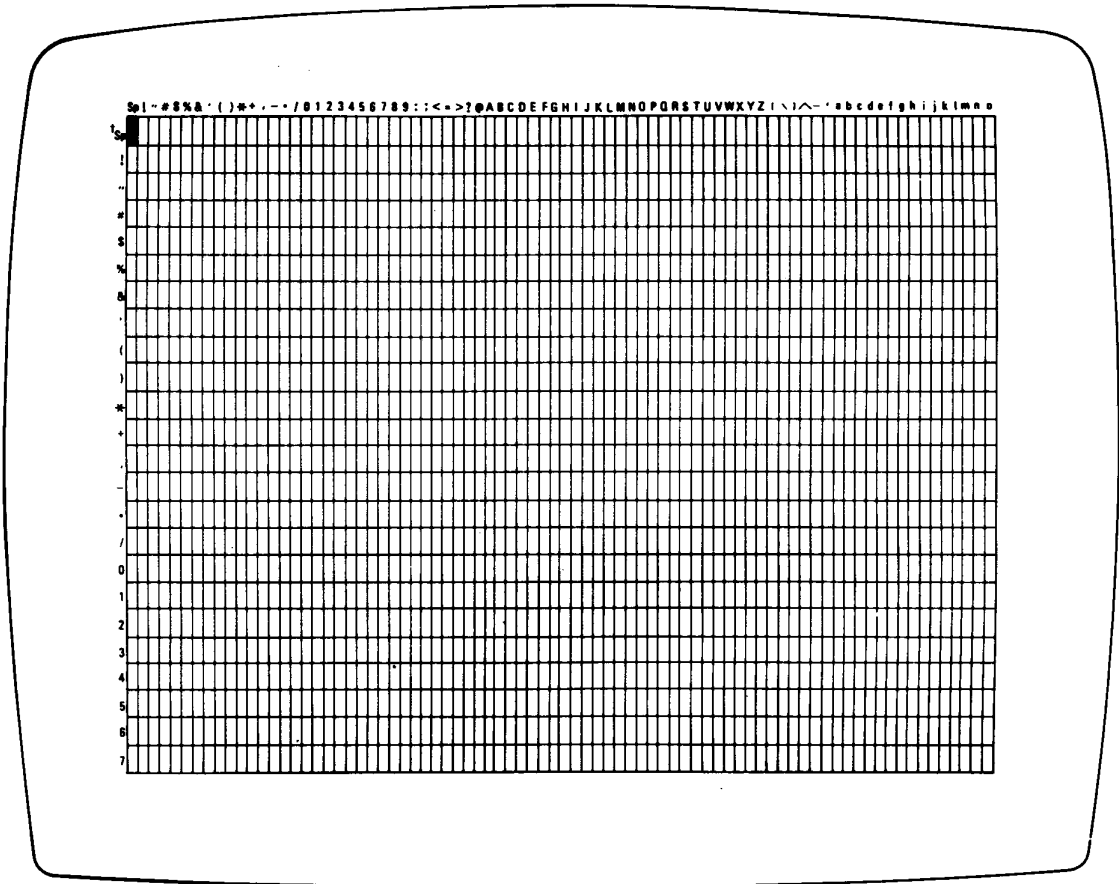

?Sp - SPACE BAR

NOTE: CURSOR SHOWN IN THE HOME POSITION

57708

Figure E-1. Cursor Addressing

APPENDIX F

MONITOR MODE FACSIMILE SYMBOLS

Facsimile	ASCII Mnemonic	Hexa-decimal Code	Description
N _U	NUL	00	Null
S _H	SOH	01	Start of Heading
S _X	STX	02	Start of Text
E _X	ETX	03	End of Text
E _T	EOT	04	End of Transmission
E _Q	ENQ	05	Enquiry
A _K	ACK	06	Acknowledge
B _L	BEL	07	Bell (beep)
B _S	BS	08	Back Space
H _T	HT	09	Horizontal Tab
L _F	LF	0A	Line Feed
V _T	VT	0B	Vertical Tab
F _F	FF	0C	Form Feed
C _R	CR	0D	Carriage Return
S _O	SO	0E	Shift Out
S _I	SI	0F	Shift In
D _L	DLE	10	Data Link Escape
D ₁	DC1	11	Device Control 1
D ₂	DC2	12	Device Control 2
D ₃	DC3	13	Device Control 3
D ₄	DC4	14	Device Control 4
N _K	NAK	15	Negative Acknowledge

APPENDIX F

MONITOR MODE FACSIMILE SYMBOLS

(Cont.)

Facsimile	ASCII Mnemonic	Hexadecimal Code	Description
S _N	SYN	16	Synchronous Idle
E _B	ETB	17	End of Transmission Block
C _N	CAN	18	Cancel
E _M	EM	19	End of Medium
S _B	SUB	1A	Substitute (clear all to spaces)
E _S	ESC	1B	Escape
F _S	FS	1C	File Separator
G _S	GS	1D	Group Separator
R _S	RS	1E	Record Separator, (Home)
U _S	US	1F	Unit Separator, (New Line)
	SP	20	Space, Blank

APPENDIX G

SIMPLIFIED TROUBLESHOOTING GUIDE

This appendix is intended to assist the terminal operator should there be any difficulty operating the terminal.

Non-Printer Related Problems/Causes

Problem	Possible Cause
Terminal will not turn on when power switch is set to ON.	<ol style="list-style-type: none">1. AC cord not plugged in to wall outlet.2. Blown Fuse. Replace (see Figure 1-2).3. No power at wall outlet.
Display screen on but will not display characters when keys are pressed.	<ol style="list-style-type: none">1. Keyboard cable not plugged in to display unit.2. Keyboard is locked -- Enter Set-Up mode and toggle to KB ON.
Unable to communicate with host computer.	<ol style="list-style-type: none">1. I/O cables not properly connected from terminal primary port to host computer.2. Incorrect operating mode - should be Character (CHAR) mode.
Jumbled display on screen.	<ol style="list-style-type: none">1. Incorrect primary port baud rate -- enter Set-up mode and correct the condition.2. Incorrect bits-per-character -- enter Set-up mode and correct the condition.3. Incorrect parity -- enter Set-up mode and correct the condition.4. Monitor mode is ON -- Enter Set-Up mode and toggle to MON OFF.
Continuous beeping when receiving data from host computer.	<ol style="list-style-type: none">1. Bell is ON. Enter Set-up mode and turn bell off.

Printer Related Problems/Causes

Problem	Possible Cause
Printer is not interfacing properly with the terminal.	<ol style="list-style-type: none">1. Printer is using a port other than an RS232 asynchronous interface port.2. The terminal's printer port is not set to "output".3. Incorrect data word structure. Change printer operating configuration.4. The printer's VDT port pins are set incorrectly to the printer's input and signal ground pins. Set VDT port pins to Pin 3 (output) and Pin 7 (signal ground).5. The "Printer Ready" signal is set incorrectly. Set this signal to Pin 20*.

* NOTE: Printer pin assignments may vary; consult the printer's manufacturer for more information.

PRINTER INTERFACE SELF-TEST

After checking the five possible causes and correcting, as necessary, the printer should interface properly with the terminal. To verify that all problems have been corrected, perform this self-test procedure on your terminal not connected to a modem or a host computer. If the unit is connected to a host or modem, disconnect before performing this self-test.

1. Set the terminal in Block Mode.
2. Type in several lines of information.
3. Depress the PRINT key.

Result: If interface problems have been resolved, all data from the Home position to, and including, the current cursor position should print.

APPENDIX H

OPERATOR'S QUESTIONNAIRE

Ampex Corporation is continuously searching for ways to improve its products and product documentation. Your comments will help.

1. What specific Ampex terminal(s) are you using? Check all that apply.

A210 D30 D80 D81 D125 D150 D175

2. Is this manual helpful to you? Why or why not? How can this manual be improved? Have you found any mistakes in the manual?

3. Describe any problems you have had in using your Ampex terminal.

4. Please give us any additional comments that you may have. If you like, use additional sheets of paper.

5. Would you like to be contacted by a representative of Ampex Corporation? If you would, why? (Need more terminals, equipment problem, etc.). Please supply us with your name, address, and telephone number so that we can reach you.

Name and address: _____

Telephone: _____

Mail your completed Operator's Questionnaire to: Ampex Corporation, Marketing Services Dept. Mail Stop M-22, Attn. VDT MANUALS, 200 N. Nash St., El Segundo, Calif., 90245, U.S.A.

WARRANTY

Your Ampex Video Display Terminal is supported by warranty service. The terms and conditions of this service, and the procedures to follow for exercising your warranty options are:

Ampex warrants that this Terminal, when used in the manner for which it was designed, will perform in accordance with Ampex's published specifications, and will be free from defects in material and workmanship for a period of six (6) months from date of shipment to the Buyer. Ampex will, without charge to the Buyer, repair any Terminal or part thereof which Ampex determines to have failed to meet Ampex specifications or to be defective within the terms and conditions of this warranty, provided that:

A. The Buyer shall have notified Ampex of any alleged defect in the Terminal within the period of this Warranty.

B. The Buyer shall have followed the instructions provided by Ampex pertaining to returning the Terminal within the period of this Warranty.

C. The Terminal has not been altered, damaged, or repaired in any way which Ampex reasonably determines to have adversely affected performance or reliability, nor has it been subjected to misuse, neglect, or accident, including, but not limited to, failure of or excessive electric power, failure of environmental-control equipment, failure of the Buyer's preventive maintenance program, or inadequate protection during transit to Ampex. Ampex shall not be obligated to repair or replace any Terminal, parts, or components for cosmetic or similar reasons.

The above Warranty extends to the original Buyer only, and repair or replacement of component parts shall not extend this Warranty, nor create any other warranty.

This Warranty shall survive acceptance and payment by the Buyer.

To exercise this Warranty:

1. Complete the Warranty Registration Card, 3515020-02, and mail to the designated Ampex location, postage-paid and pre-addressed, on that card.

2. If a defect in material or workmanship is determined within the six (6) month warranty period, notify Ampex and obtain further instructions. Call:

800-538-7838 (outside of California)

800-524-2850 (within California, except locations having a 415 area code)

408-725-2069 (locations having a 415 area code)

AMPEX 210



**Sie bestellen beim
authorisierten
Distributor**

SIGMA
COMPUTER GMBH

Nordstraße 5
6333 Braunfels-
Altenkirchen
Telefon (06445) 804
Telex 483800 sigma

Geben Sie die gewünschte
Bildschirmfarbe an und ob
Sie die deutschen Tasten-
kappen zusätzlich wün-
schen.

Das Ampex 210 ist unvergleichlich. In der Ergonomie, in den Möglichkeiten. Und im Preis.

Kein Wunder.

Das AMPEX 210 ist nicht einfach ein herkömmliches Bildschirmgerät zu einem Magerpreis, sondern eine Neukonstruktion mit allen Eigenschaften, die man von einem weit teureren Terminal erwartet. So bietet es unter anderem 14 verschiedene Emulationen und soft Scrolling.

Dazu kommt eine fla-

che Tastatur mit Dezimalblock (als Option nach DIN) und ein großer 14" Bildschirm, der in fast allen Richtungen geschwenkt werden kann. Bildschirmfarbe ist grün oder amber (bernsteinfarben).

Und wenn Sie jetzt fragen, wie das zu dem Preis zu machen ist – ganz einfach: AMPEX hat schließlich 30 Jahre Erfah-

rung in der Herstellung von Videogeräten und Computerperipherie und weiß, wie man preisgünstig fertigt. Wir geben 6 Monate Garantie auf das Gerät.

Sie können das AMP-EX 210 gerne mit Konkurrenzprodukten vergleichen. Bitte seien Sie nicht überrascht, wenn das nicht geht, weil Sie keine gefunden haben.

DM 1698,-
incl. MwSt.

AMPEX
Ampex Corporation • One of The Signal Companies

AMPEX 210

Technische Daten:

Bildschirm:

14 Zoll Bildröhre, entspiegelt
Amber oder grüner Phosphor
60 oder 65 Hz Refresh (ein-
stellbar)
Dreh- und schwenkbar ge-
lagert
24 Zeilen zu je 80 Zeichen
7*9 Punktmatrix im 9*12 Feld
15 Strichgrafikzeichen

Cursor

9*12 Punkt Matrix
Block oder Unterstreichung
Blinkend oder nicht blinkend
Les- und setzbar
An- und ausschaltbar

Nationale Zeichensätze

Vereinigte Staaten
Großbritannien
Frankreich
Deutschland
Norwegen
Schweden
Dänemark

Videoattribute

Blinken, inverse Darstellung,
Unterstreichen, halbe Inten-
sität

Tastatur

niedriges Profil nach DIN
(30 mm)
abgesetzt mit langem Spiral-
kabel
hörbarer Klick (kann abge-
schaltet werden)
Tastaturbelegung wie Selec-
tric
Option DIN Tastensatz
verschieden hohe Tasten-
reihen
14 Funktionstasten
Separate Editiertasten
Separater Numerik/Funk-
tionsblock
Neigungswinkel
verstellbar

Betriebsmodi

Voll- oder Halbduplex
Block, Zeile, Zeichen, Lokal
Monitor
weiches Rollen (smooth
Scroll)
Einstellmodus
Geschützt, schreibgeschützt
Strichgrafik

Kommunikation

2 serielle Ports
beide RS 232 C asynchron
mit 50 bis 19.200 Baud

Druckerfunktionen

lokaler Druck (Seitendruck)
Kopie der Bildschirmausgabe

Emulationen

ADDS Regent 20/25, View-
point
Hazeltine 1400/1410/1500
Lear Siegler
ADM 3/3A/3A+/5
Qume QVT 102
Televideo 910, 910+, 925

Stromversorgung

115/230 Volt umschaltbar,
55 Watt

erfüllte Sicherheitsnormen

UL, FCC Class A (USA)
CSA (Kanada)
VDE, FTZ (Deutschland)
EANGW (Australien)

Ausmaße in mm/kg

	Bildschirm	Tastatur
Breite	343	483
Tiefe	343	191
Höhe	369	38
Gewicht	8,7 kg	0,9 kg

AMPEX hat Niederlassungen in

Vereinigte Staaten

Allendale, New Jersey
Arlington Heights, Illinois
Carrollton, Texas
El Segundo, Kalifornien

International

Toronto, Kanada
Reading, Großbritannien
Paris, Frankreich
Frankfurt (Tel. 0611/60581)
Hong Kong
Rom, Italien
Stockholm, Schweden
Utrecht, Niederlande
Madrid, Spanien
Fribourg, Schweiz

