

ACB-5580
User's Manual

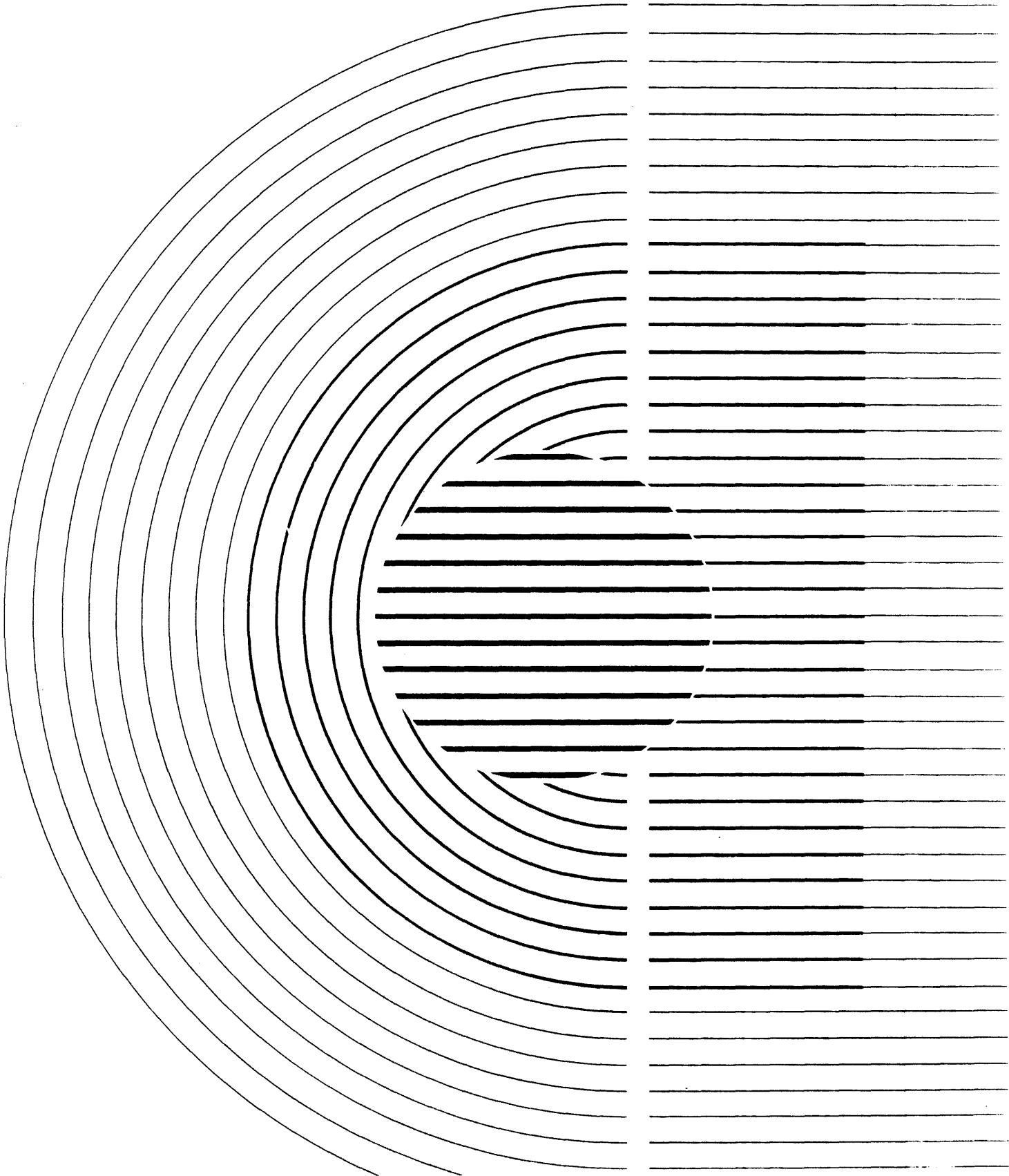



adaptec, inc.

ACB-5580 User's Manual SCSI to SMD Controller

October, 1985

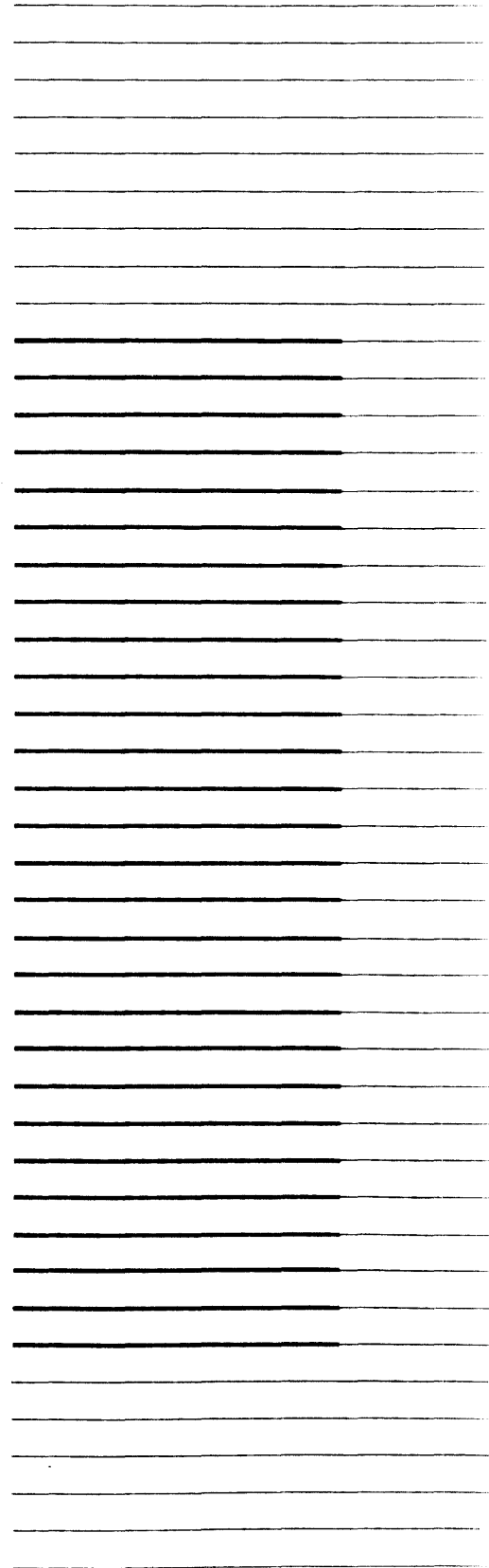

Additional copies of this manual, or other Adaptec literature, may be obtained from:

Adaptec, Inc.
Literature Department
580 Cottonwood Drive
Milpitas, CA 95035

The information in this document is subject to change without notice.

No part of this document may be copied or reproduced in any form or by any means without prior written consent of Adaptec, Inc.

Adaptec, Inc., 580 Cottonwood Drive, Milpitas, California 95035

Copyright 1984

TABLE OF CONTENTS

1.0	INTRODUCTION	1-1
1.1	Scope	1-1
1.2	Reference Documents	1-1
1.3	ACB-5580 Features	1-1
1.5	Hardware/Software Compatibility Requirements .	1-4
1.6	Product Specification	1-4
1.6.1	Physical Dimentions	1-4
1.6.2	Power Requirements	1-4
1.6.3	Environmental Requirements	1-5
1.7	Quality Assurance	1-5
2.0	THEORY OF OPERATION	2-1
2.1	System Configuration	2-1
3.0	INSTALLATION	3-1
3.1	Unpacking	3-1
3.2	Preparation of Installation Area	3-1
3.3	ACB-5580 Mechanical Specifications	3-2
3.4	Installation	3-4
3.5	Jumpering	3-5
3.6	Diagnostic Operation	3-6
4.0	SCSI INTERFACE DESCRIPTION	4-1
4.1	General Description of SCSI	4-1
4.1.1	Bus Signals	4-2
4.1.1.1	Busy (BSY)	4-2
4.1.1.2	Select (SEL)	4-2

4.1.1.3	Control/Data (C/D)	4-2
4.1.1.4	Input/Output (I/O)	4-2
4.1.1.5	Message (MSG)	4-2
4.1.1.6	Request (REQ)	4-2
4.1.1.7	Acknowledge (ACK)	4-2
4.1.1.8	Attention (ATTN)	4-3
4.1.1.9	Reset (RST)	4-3
4.1.1.10	Data Bus (DB: 7-0, Parity)	4-3
4.1.2	Bus Phases	4-3
4.1.2.1	Bus Free Phase	4-4
4.1.2.2	Arbitration Phase	4-4
4.1.2.3	Selection Phase	4-4
4.1.2.4	Reselection Phase	4-5
4.1.2.5	Information Transfer Phases	4-5
4.1.2.5.1	Command Phase	4-7
4.1.2.5.2	Data Phases	4-7
4.1.2.5.3	Status Phase	4-7
4.1.2.5.4	Message Phases	4-7
4.1.2.6	Signal Restrictions Between Phases	4-8
4.1.3	Bus Conditions	4-8
4.1.3.1	Attention Condition	4-8
4.1.3.2	Reset Condition	4-8
4.1.4	Phase Sequencing	4-9
4.1.5	Timing	4-10
4.1.6	Electrical Interface	4-10

4.1.7	Connection Diagram	4-11
4.2	Message Specification	4-12
4.2.1	Message System	4-12
4.2.2	SCSI Message Descriptions	4-13
4.2.2.1	Single Byte Messages	4-13
4.3	Functional Description of SCSI Commands	4-16
4.3.1	Single Command Example	4-16
4.3.2	Disconnect/Reconnect Example	4-17
4.3.3	Linked Command Example	4-17
4.4	Command and Status Structure	4-17
4.4.1	Command Descriptor Block (CDB)	4-18
4.4.2	Group Code	4-19
4.4.3	Operation Code	4-19
4.4.4	Logical Unit Number	4-19
4.4.5	Command Specific Bits	4-20
4.4.6	Relative Address Bit	4-20
4.4.7	Logical Block Address	4-20
4.4.8	Number of Blocks	4-20
4.4.9	Control Byte	4-20
4.5	Completion Status Byte	4-21
5.0	SMD INTERFACE DESCRIPTION	5-1
5.1	Introduction	5-1
5.2	Interface Signals	5-1
5.3	Optional Tags for Error Presentation	5-5
5.3.1	Tag 5 Errors	5-5
5.3.2	Tag 4 Errors	5-5

5.4	SMD Drive Preparation	5-5
5.4.1	Actuator/Spindle Lock	5-5
5.4.2	Disk Address	5-6
5.4.3	Sector Mode	5-6
5.4.4	AM Mode	5-6
5.4.5	RPS Mode Select	5-6
5.4.6	Format Write Release	5-6
5.4.7	Tag 4/5 Control	5-6
5.4.8	Interface Control Lines	5-6
5.4.9	Sector Selection Switches	5-7
5.4.10	Servo Offset Mode	5-7
5.4.11	Motor Start Delay	5-7
5.4.12	Remote/Local Control	5-7
5.4.13	Write Project	5-8
5.5	Electrical Interface	5-8
5.6	Connection Diagram	5-8
5.7	Remote and Power Control Interface	5-10
6.0	COMMAND DESCRIPTIONS	6-1
6.1	Test Unit Ready (00 _H)	6-3
6.2	Rezero Unit (01 _H)	6-4
6.3	Request Sense (03 _H)	6-5
6.3.1	Bad Format on Drive	6-12
6.4	Format Unit (04 _H)	6-14
6.4.1	Defect Handling.	6-16
6.5	Read (08 _H)	6-21
6.6	Write (0A _H).	6-23
6.7	Seek (0B _H)	6-25

6.8	Translate (0F _H)	6-26
6.9	Set Threshold (10 _H)	6-28
6.10	Read/Reset Usage Counter (11 _H)	6-29
6.11	Inquiry (12 _H)	6-31
6.12	Write Data Buffer (13 _H)	6-32
6.13	Read Data Buffer (14 _H)	6-33
6.14	Mode Select (15 _H)	6-34
6.15	Reserve (16 _H)	6-38
6.16	Release (17 _H)	6-42
6.17	Mode Sense (1A _H)	6-43
6.18	Start/Stop Unit (1B _H)	6-44
6.19	Receive Diagnostic (1C _H)	6-45
6.20	Send Diagnostic (1D _H)	6-47
6.20.1	Diagnostic 60	6-49
6.20.2	Diagnostic 61	6-49
6.20.3	Diagnostic 62	6-50
6.20.4	Diagnostic 63	6-50
6.20.5	Diagnostic 64	6-50
6.20.6	Diagnostic 65	6-50
6.20.7	Diagnostic 66	6-51
6.21	Read Capacity (25 _H)	6-54
6.22	Read (28 _H)	6-56
6.23	Write (Extended (2A)	6-57
6.24	Write and Verify (2E _H)	6-58
6.25	Verify (2F _H)	6-59
6.26	Search Data Equal (31 _H)	6-60
6.27	Set Limits (33 _H)	6-64

LIST OF FIGURES

Fig.	Title	Page
1-4	Block Diagram of ACB-5580	1-3
2-1	Minimum System	2-2
2-2	Simple Multi-Processor System	2-2
2-3	Complex Multi-Processor System	2-3
3-1	ACB-5580 Dimensions	3-3
4-1	Host Adapter Bus Termination	4-11
4-2	SCSI Bus Pin Assignments	4-12
4-3	Completion Status Byte	4-21
5-1	SMD Read Signal Timing Requirements	5-3
5-2	SMD Write Signal Timing Provided	5-4
5-3	SMD Track Format, Cylinder 0, 4 Sector Example . . .	5-5
5-4	SMD Track Format, Typical 256 Date Byte Format . . .	5-6
6-1	Test Unit Ready Command	6-3
6-2	REZERO UNIT Command	6-4
6-3	REQUEST SENSE Command	6-5
6-4	REQUEST SENSE Data	6-6
6-5	Extended Sense Byte Format	6-7
6-6	FORMAT UNIT Command	6-14
6-7	Sector Level Defect Skipping	6-16
6-8	Sector Spacing within Cylinders	6-17
6-9	Sector Sparing and Overflow Sectors	6-18
6-10	Format Unit Data Block (Drive Formatting)	6-19
6-11	Format Unit Data Block (Cylinder Level Formatting) .	6-20

6-12	READ Command	6-21
6-13	WRITE Command	6-23
6-14	SEEK Command	6-25
6-15	TRANSLATE Command	6-26
6-16	TRANSLATE Data	6-27
6-17	SET THRESHOLD Command	6-28
6-18	READ/RESET USAGE COUNTER Command	6-29
6-19	Parameters Returned by READ/RESET USAGE COUNTERS	6-30
6-20	INQUIRY Command	6-31
6-21	INQUIRY Command Parameter List	6-31
6-22	WRITE DATA BUFFER Command	6-32
6-23	READ DATA BUFFER Command	6-33
6-24	MODE SELECT Command	6-34
6-25	Drive Parameter List	6-35/36
6-26	RESERVE Command	6-38
6-27	RESERVE Command (Extent Descriptor Format)	6-40
6-28	RELEASE Command	6-42
6-29	MODE SENSE Command	6-43
6-30	START/STOP UNIT Command	6-44
6-31	RECEIVE DIAGNOSTIC Command	6-45
6-32	RECEIVE DIAGNOSTIC Data	6-46
6-33	SEND DIAGNOSTIC Command	6-47
6-34	SEND DIAGNOSTIC Parameter Format	6-48
6-35	READ CAPACITY Command	6-54
6-36	Returned Read Capacity, Parameters	6-55
6-37	READ Command	6-56

6-38	WRITE Command	6-57
6-39	WRITE and VERIFY Command	6-58
6-40	VERIFY Command	6-59
6-41	SEARCH DATA EQUAL Command	6-60
6-42	SEARCH DATA EQUAL Argument	6-62
6-43	SET LIMITS Command	6-64

LIST OF TABLES

Table	Title	Page
4-1	Information Transfer Phases	4-6
4-2	Message Codes Supported by the ACB-5580	4-13
4-3	Group 0 Commands (6-Byte Commands)	4-18
4-4	Group 1 Commands (10-Byte Extended Block Address)	4-19
5-1	Tag/Bus Lines	5-2
5-2	"A" Cable Pin Assignment	5-11
5-3	"B" Cable Pin Assignment	5-12
6-1	Command Code Summary	6-1/6-2
6-2	Mapping of SMD Bus In Lines	6-9
6-3	Class 00 Error Codes in Sense Byte (Drive Errors)	6-9
6-4	Class 01 Error Codes in Sense Byte (Media Errors)	6-10
6-5	Class 02 Error Codes (System-Related Errors)	6-11
6-6	Table of Sense Keys for 5580 (Extended Sense Only)	6-13
6-7	SEARCH DATA EQUAL Argument	6-63

1.0 INTRODUCTION

The ACB-5580 disk controller provides an intelligent interface from an ANSI X3T9.2 SCSI host interface to four SMD compatible disk drives.

1.1 SCOPE

This manual contains all of the information necessary to quickly install and operate the ACB-5580 with an SCSI compatible host adapter and up to four SMD disk drives.

1.2 REFERENCE DOCUMENTS

- o ANSI X3T9.2 Small Computer System Interface Specification
- o Magnetic Peripherals, Inc.--Flat Cable Interface Specifications for the SMD, MMD, FHT MMD, LMD, WMD, WMD-0, CMD, RSD, and FSD families. (Doc. #64712400 Rev. N, Nov. 1983)

1.3 ACB-5580 FEATURES

- o The ACB-5580 supports four SMD drives. The drives are used in hard sector mode and may transfer data at up to 1.2 Mbytes/sec.
- o Software support of the ACB-5580 is designed to be a superset of the software required for the ACB-5500. All normal ACB-5500 instructions operate unchanged on the ACB-5580 and no additional instructions are required for normal ACB-5580 operation. This allows systems to be upgraded to the very large capacity and very high performance of the SMD drive families with no software impacts. Advanced Functions supported by the ACB-5580 will require program extensions.
- o The ACB-5580, utilizing a 4K dual-ported buffer, eliminates the need for sector interleaving. This allows the host to read a track of data in a single revolution.
- o The ACB-5580 offers complete device independence by auto configuring to any size formatted drive. By storing drive parameters on the drive at format time, the need for host initialization of the controller for various drive types is eliminated.

- o The ACB-5580 may handle defects on a sector level by allowing the host to request that spare sectors be reserved on a cylinder basis. This provides formatted disks with constant data capacity and allows cylinder level formatting. An alternative format using maximum capacity and Adaptec's unique defect skipping algorithm may be selected.
- o The ACB-5580 guarantees excellent data integrity by utilizing a 32-bit error correction code on both the data and I.D. fields, SCSI bus parity checking and generation, and parity checking on the internal buffer memory.
- o The ACB-5580 provides great operating system flexibility by offering sector lengths of 256, 512, or 1024 bytes. The sector length is programmed at format time.
- o The ACB-5580 supports direct and relative addressing of logical blocks.
- o The ACB-5580 supports a fully arbitrating SCSI system with up to seven other controllers or hosts sharing the SCSI bus.
- o The ACB-5580 provides maximum SCSI bus throughput by supporting bus disconnection and reconnection for explicit and implied seeks.
- o The ACB-5580 allows the host to reserve an entire logical unit, or particular extents on a logical unit, limiting or prohibiting data access by other hosts on the SCSI bus.
- o The ACB-5580 reduces selection overhead by allowing the host to link commands. Once a command is completed, the controller will immediately request and execute the next linked command.
- o The ACB-5580 reduces system overhead by queuing commands to the controller. As commands are completed, the next queued command will be executed.
- o The ACB-5580 provides a high level of system flexibility and reliability by its support of the dual port option available on certain SMD drives.
- o The ACB-5580 is initialized by jumpers to support the following user-selectable functions:
 - . Hard or soft SCSI device reset
 - . Short or extended sense data
 - . Tag 4/5 error information
 - . Local or remote power control.

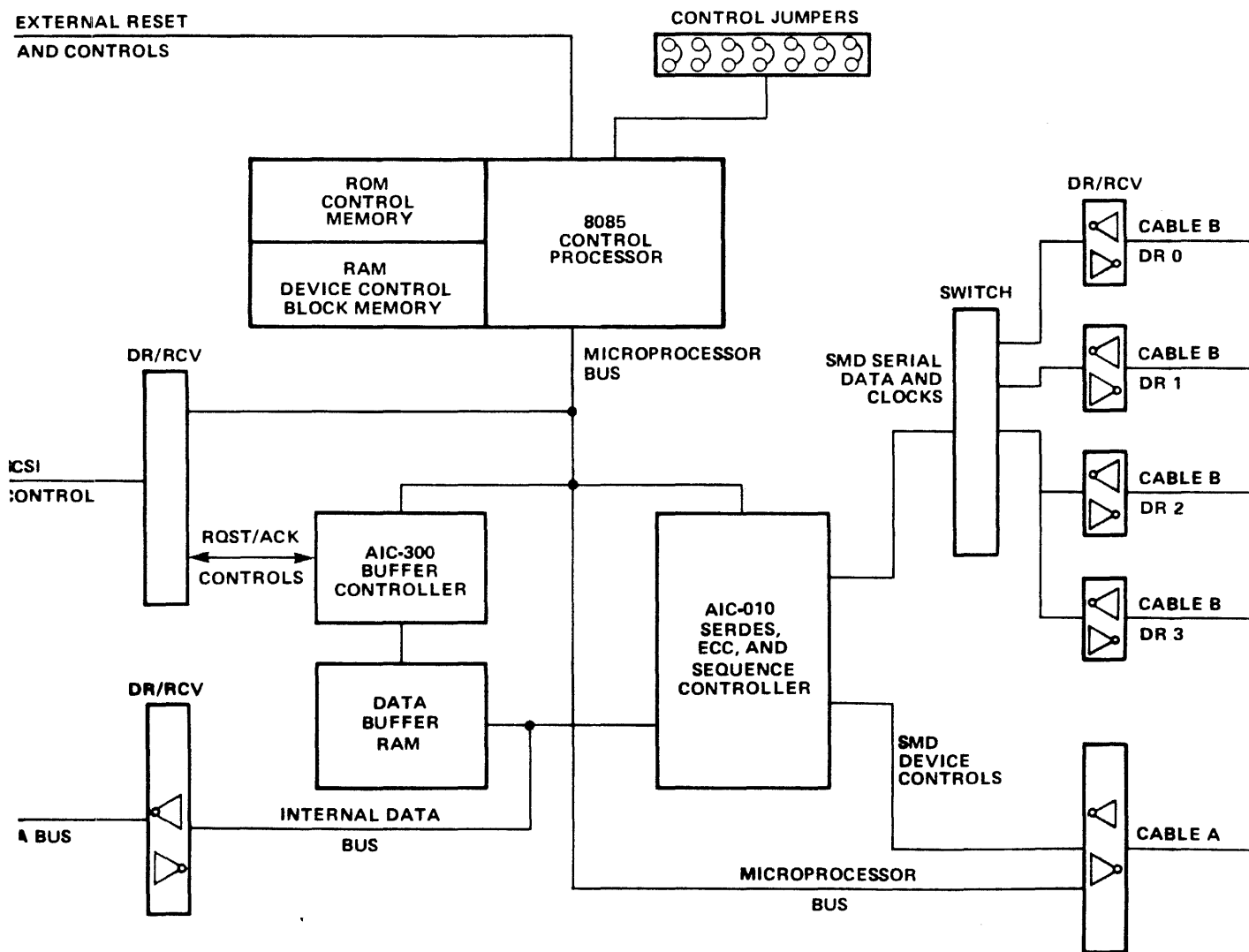

Figure 1-4. Block Diagram of ACB-5530

1.5 HARDWARE/SOFTWARE COMPATIBILITY REQUIREMENTS

The ACB-5580 requires application and system software that will provide correctly structured Command Descriptor Blocks and data and parameter fields. Low level control software or a properly structured host adapter or channel must be provided to control the SCSI protocols that transmit the Command Descriptor Blocks and other fields. Any system that supports the ACB-5500 will support all basic functions of the ACB-5580. Advanced ACB-5580 functions require system software extensions.

The SCSI must meet the arbitration requirements of Revision 14 if the ACB-5580 is installed in an arbitrating system. Certain lower levels of the SCSI may be supported. Contact Adaptec for detailed compatibility analysis.

The mode select command implemented by the ACB-5580 requires two bytes more than the ACB-5500 Hard Sector format to provide for the extended function provided by the SMD drives.

The ACB-5580 supports most standard SMD drives. In particular, the following drive families have been tested:

NEC
Fujitsu
Others TBD (Contact Adaptec).

1.6 PRODUCT SPECIFICATION

1.6.1 PHYSICAL DIMENSIONS

Length: 14.0 inches
Width: 7.0 inches
Height: .8 inches

1.6.2 POWER REQUIREMENTS

Voltage (volts)	Tolerance (Units)	Current (max amps)	Ripple (volts, RMS)
+5	4.75 to 5.25	2.0	.150
-12	-13 to -7	1.0	.150

Power is applied through J9, 4-pin AMP connector. The recommended mating connector is AMP P/N 1-480424-0. J9 pins are numbered as shown in Figure 1-5.

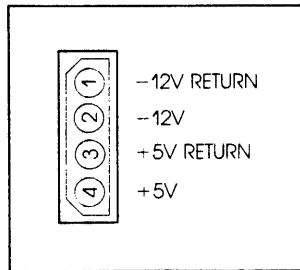

Figure 1-5. Connector J9 Pin Assignments

1.6.3 ENVIRONMENTAL REQUIREMENTS

	Operating	Storage
Temperature (F/C):	32/0 to 131/55	-40/-40 to 167/75
Humidity:	10% to 95%	10% to 95%
Altitude (ft.):	Sea Level to 10,000	Sea Level to 20,000

Exhaust air flow may be required to keep the air on both sides of the board at or below the maximum operating temperature if adequate convection ventilation is not available.

1.7 QUALITY ASSURANCE

The ACB-5580 has been processed through Adaptec's extensive quality control procedure. All of Adaptec custom ICs have been fully tested at temperature and voltage margins. All boards have been fabricated and assembled under close quality inspection. All boards have passed complete incircuit test procedures, have endured burn-in testing, and have been fully functionally tested. Adaptec should be notified immediately of any deviations from our high standard of quality.

2.0 THEORY OF OPERATION

The ACB-5580 provides a powerful mechanism for connecting up to four SMD compatible disk drives to a host computer via the Small Computer Systems Interface (SCSI). The SCSI provides a powerful general purpose device-independent connection usable by a wide range of computing systems.

The ACB-5580 provides all required formatting and data synchronizing functions for SMD compatible disk drives. The formatting function is provided by Adaptec's proprietary 10 MHz sequencer chip, the AIC-010.

The ACB-5580 provides up to 4K bytes of buffering to allow high performance data access even if the attached host system can only accept data at very low rates. Adaptec's AIC-300 buffer controller provides full dual porting for the buffer memory.

The data transfer path is fully checked, using ECC and buffer parity checking to assure data integrity. Data integrity is not compromised by the unchecked control microprocessor.

All low-speed control operations are managed by a powerful 8-bit microprocessor executing instructions from a 16K read-only control memory. The large control memory allows the implementation of several optional functions as well as a diagnostic self-tst capability.

The FORMAT command stores device dependent parameter information on the attached disk drives. When the ACB-5580 is powered up, it automatically configures all internal tables from the stored parameters so that no drive configuration commands are required from the host system.

2.1 SYSTEM CONFIGURATION

The ACB-5580 supports systems with a wide range of complexity. Figures 2-1, 2-2, and 2-3 demonstrate the wide variety of configurations supported.

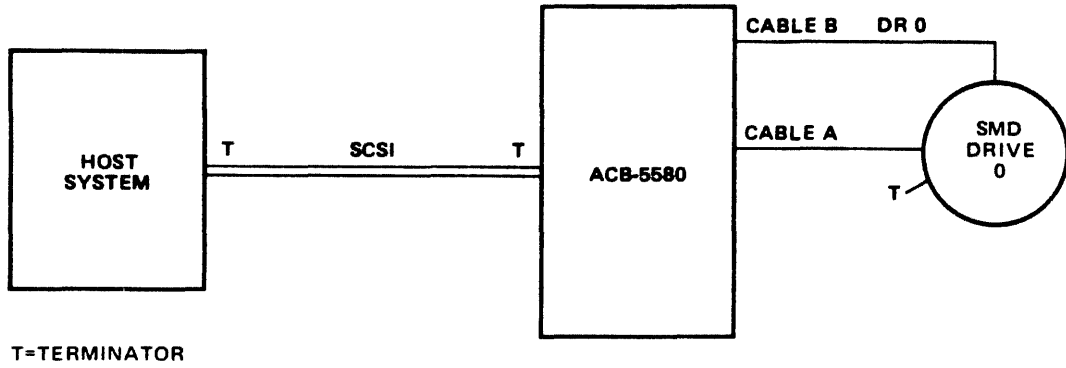

Figure 2-1. Minimum System

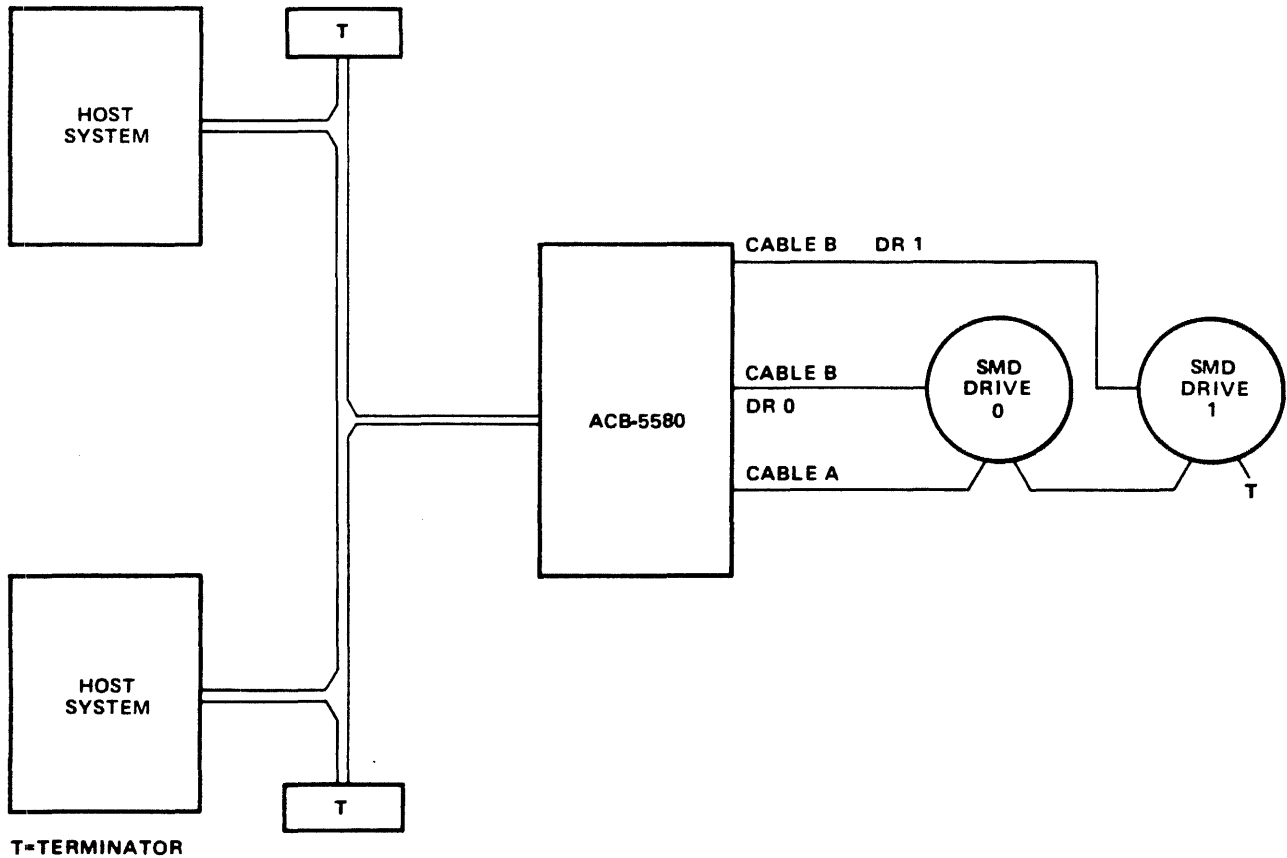
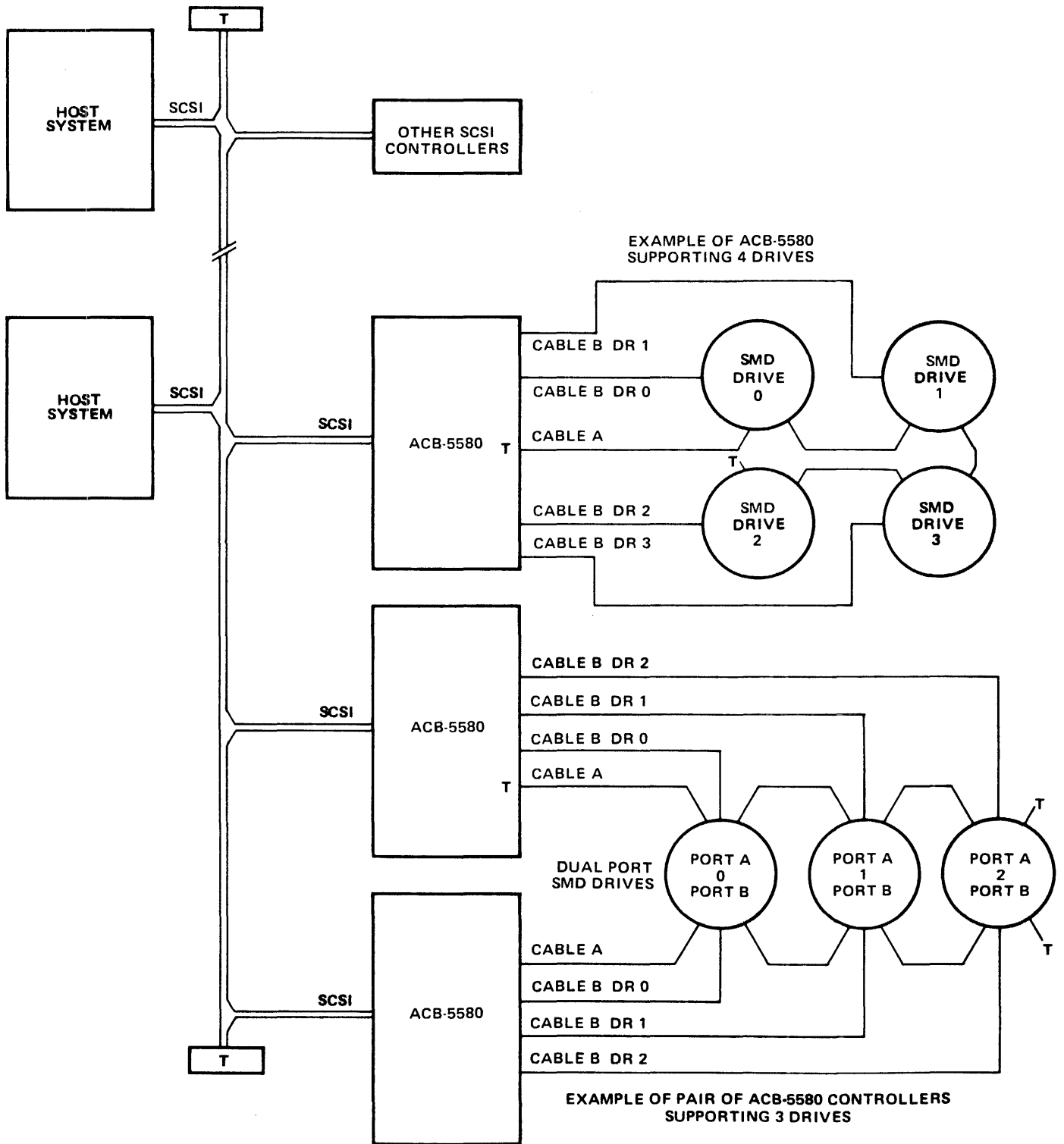

Figure 2-2. Simple Multi-Processor System



T=TERMINATOR

Figure 2-3. Complex Multi-Processor System

3.0 INSTALLATION

The ACB-5580 is a self-contained circuit board. All logical and electronic functions required for its normal operation are contained on the circuit board. The ACB-5580 is simple to install, operate, and maintain.

3.1 UNPACKING

The ACB-5580 is shipped in a protective carton with shock absorbing material and static protecting material completely surrounding the card. The carton should be examined for external damage as it is opened. The cards were physically inspected when packed. Any mechanical damage to the cards should be reported to the shipper and to Adaptec as soon as possible.

CAUTION

All circuit boards containing VLSI circuitry have some sensitivity to electro-static discharge. The ACB-5580 is no exception. Proper handling precautions, including personnel grounding and work surface grounding, should be taken to prevent circuit stress which can cause premature circuit failure.

3.2 PREPARATION OF INSTALLATION AREA

The ACB-5580 is generally designed into the host system or the peripheral disk system. Proper attention should be given to the location of ACB-5580 so that the necessary ventilation, installation clearances, and cabling paths are provided.

The power output is low enough so that convective ventilation will be sufficient if the air and surrounding surfaces are at a temperature of 55 degrees Centigrade or less. If this requirement cannot be met by the system enclosure in its worst case environment, then the system enclosure must provide for appropriate ventilation and cooling.

Care should be taken to support the card mechanically. Any appropriate combination of the 6 mounting holes provided can be used, depending on the forces to which the system will be subjected. Clearances are also provided for installation of plastic card-edge guide slots. No conductive material should come in contact with the ACB-5580 except at the mounting holes.

Installation clearances, both for the ACB-5580 and the selected power and signal cabling configuration, should be sufficient to optimize system cost, manufacturability, and maintainability.

The ACB-5580 emits a small amount of radio-frequency signals. Extremely sensitive components, such as high band-width analog sensors, should be properly shielded from the ACB-5580. Normal case construction is sufficient to shield the ACB-5580 as required by the FCC. If FCC compliance is required and the SCSI or SMD cables leave the box in which the ACB-5580 is installed, the high frequency signals generated by normal SCSI and SMD operation may require connector and cable shielding.

The ACB-5580 and all other partially shielded electronic devices are sensitive to high power high frequency electrical or magnetic sources. The ACB-5580 should be protected from such sources while it is operating. In particular, unshielded switching power supplies should be physically isolated from all electronic boards and their interconnecting cables. External sources, such as welding machines and radio transmitters, should be similarly isolated from electronic systems. Cable and connector shielding may be required in some environments.

An appropriate power source must be provided. Care should be taken to prevent ground loops and other power disturbances. Power control signal inputs are provided to allow system control of pick and hold, interface enabling, and reset.

Proper programming support must be provided to generate the required command sequences. Additional program support must be provided to manage the SCSI protocols. Any system supporting the ACB-5500 will also support the ACB-5580. Changes in the MODE SELECT parameters may be required to allow installation of the SMD drives, which are hard-sectored and typically have a larger capacity than 5 1/4" Winchester drives. The AHA-1510 and AHA-1530 will provide the required SCSI protocol services, but must receive the commands to be executed from appropriate system software. Many other SCSI systems are also available.

3.3 ACB-5580 MECHANICAL SPECIFICATIONS

See Figure 3-1.

3.4 INSTALLATION

The following steps are required for installation of the ACB-5580 into a system properly designed to accept it. These steps are separate from any other testing and installation procedures required by other portions of the system, but can often be done in conjunction with those other installation steps.

- a) Inspect ACB-5580 for obvious physical damage before installing.
- b) Install proper jumpers in J7 to establish the set of functions the ACB-5580 is allowed to perform and to define the address of the ACB-5580 on the SCSI Bus.
- c) Install ACB-5580 with appropriate mounting hardware.
- d) Make the required cable connections to the ACB-5580. The cable connections are:
 - J9 - Power cable (required)
 - J8 - SCSI cable (required)
 - J1 - SMD cable A (required)
 - J2, J3, J4, J5 - SMD cable B (radial connections as required)
 - J6 - Power control (optional, supports special functions).
- e) Install SMD drives according to the manufacturer's directions. The SMD drives must have appropriate sector counts, addresses, and options set.
- f) Complete installation of supporting hardware and software.
- g) Perform appropriate power-on test procedures.
- h) The SMD drives may then be formatted. A drive must first receive a MODE SELECT command to set the proper drive parameters in the ACB-5580. That must be immediately followed by a FORMAT command to initialize the drive.

The drives may optionally be formatted by a dedicated ACB-5580 manufacturing work station before installation. Since all parameters are stored on the drive by the formatting procedure, further formatting or parameter specification is not required after installation.

- i) Perform appropriate system test and verification procedures. Errors related to drive operation, ACB-5580 operation, SCSI operation, and certain installation errors will be indicated through the normal SCSI error presentation mechanism.

3.5 JUMPERING

The ACB-5580 has a number of options that must be selected by the installation of hardware jumpers. The jumpers are available at position J7 on the circuit board. Jumpers that may be used include .100 center shunts made by many companies, including:

Molex 7859 Series or 90059 Series
Berg
Amp.

The jumpers may also be installed by wire-wrapping.

The pins on the plug are arranged as follows:

o o	PAR
o o	Y
o o	RT
o o	3
o o	2
o o	1
o o	0
o o	SS
o o	DM
o o	DG
o o	HR
o o	A4
o o	A2
o o	A1

A jumper between adjacent pins in each row provides access to the following ACB-5580 options:

- PAR: When installed, this jumper enables detection of bus out parity failures on the SCSI. When removed, parity checking is disabled.
- Y : When installed, indicates that dual port drives are attached. No extent reserves will be allowed.
- RT : When installed, the jumper allows remote control of the SMD Channel Ready line through pin 1 of J6. When J1 is held to ground by an open collector driver, Channel Ready will be active, allowing normal drive operation. When J1 is allowed to float, Channel Ready will be inactive, disabling the SMD drive interface. When not installed, SMD Channel Ready is active whenever power is on and power on reset is not active.
- 3 : Reserved.
- 2 : Reserved.
- 1,0: Used to indicate attached device type for extended sense device error logging. See section 6.3.

- SS : When installed, the four-byte Adaptec sense information is used. When removed, SCSI extended sense information is presented. See section 6.3.
- DM : Reserved.
- DG : When installed, places the ACB-5580 in diagnostic mode. The ACB-5580 will execute a continuous self-test, as described in section 3.6. When removed, the ACB-5580 operates normally.
- HR : When installed, forces the ACB-5580 to execute a Hard Reset whenever the SCSI Reset Condition occurs. When removed, the ACB-5580 executes a Soft Reset when the SCSI Reset Condition occurs.
- A4 : SCSI Bus identifier value, value of 4 when installed.
- A2 : SCSI Bus Identifier value, value of 2 when installed.
- A1 : SCSI Bus Identifier value, value of 1 when installed.

3.6 DIAGNOSTIC OPERATION

Two major sources of diagnostic information are available. The principal one is the sense information provided by the REQUEST SENSE command when a controller detected error has occurred. Special attention should be given to the section 6.3.1., since the Bad Format on Drive indication (error code 'IC'H) is a result of an unsuccessful pretest and initialization of the drive.

A second major source of error information must be examined if no normal SCSI operations are possible. In such a case, the REQUEST SENSE command cannot be executed, and diagnostic mode must be invoked. All connections except the power connection, J9, must be removed for diagnostic self test. The diagnostic jumper, DG, must then be installed. The power connection must be temporarily removed and reinstalled. The ACB-5580 will then enter a self-test mode.

Normal operation is indicated by a steady, regular blinking of the LED about every 2 seconds. A failing board is identified by a blink of the LED, followed by a short pause, followed by from one to six regular rapid blinks, less than one second apart.

This cycle is repeated until diagnostic mode is terminated. The number of rapid blinks indicates the failing group of components, as follows:

Number of Blinks	Failed Test
1	8156 Test Failure
2	EPROM Check Sum Failure
3	DCB Ram Test Failure
4	AIC-010 Test Failure
5	AIC-300 Test Failure
6	Data Buffer Ram Test Failure.

Note that all these failures except the Control Store ROM test probably require replacement of the ACB-5580. The Control Store ROM may be replaced to repair a ROM failure.

If the diagnostic self test does not indicate any errors, it is very likely that the ACB-5580 should be able to communicate correctly across an SCSI interface. If the ACB-5580 is still unable to pass sense information across the interface, operational errors should be suspected. These may be corrected as follows:

1. Verify that the correct power is provided.
2. Verify that the correct SCSI addresses are selected.
3. Verify that correct parity is provided or that parity checking is disabled.
4. Verify that the drives are correctly attached to their corresponding cables.
5. Verify that all connectors are oriented correctly.
6. Verify that the external reset or SCSI reset condition is not asserted.
7. Verify cable continuity and integrity.
8. Verify correct SCSI and SMD cable termination.

If none of these corrective measures are successful, contact Adaptec for further information.

4.0 SCSI INTERFACE DESCRIPTION

This section describes briefly the SCSI protocol implemented by the ADAPTEC ACB-5580 controller. The SCSI protocols are described in detail in the ANSI X3T9.2 Small Computer System Interface Specification, version 14.

4.1 GENERAL DESCRIPTION OF SCSI

This system interface provides an efficient method of communication between a maximum of 8 computers and peripheral I/O devices. The eight-port daisy-chained bus defined by the SCSI specification supports the following features:

- o Single or multiple host system
- o Multiple peripheral devices and device types
- o Multiple overlap of peripheral device operations
- o Bus contention resolution through arbitration on a prioritized basis
- o Asynchronous data transfer at up to 1.5 MBytes/sec.
- o Host-to-host communication.

Communication on the bus is allowed between two bus ports at a time. A maximum of eight (8) bus ports are allowed. Each port is attached to an SCSI device (e.g., controller or host adapter).

When two devices communicate with each other on the bus, one acts as an Initiator and the other acts as a Target. The Target (typically a controller) executes the operation. A device will usually have a fixed role as an Initiator or Target, but some devices may be able to assume either role. The ACB-5580 always assumes a Target role.

An Initiator may address up to four logical units on an ACB-5580. Each logical unit is a separate SMD disk drive having the characteristics with which it was formatted. The ACB-5580 manages them as independent units, keeping all necessary progress information for each device.

The Initiator (host adapter) and Target (ACB-5580) arbitrate for the SCSI bus. The Initiator selects a Target. The Target then manages all further communications, requesting commands from the Initiator, transferring the required data, and transmitting ending status.

Data transfers on the bus are asynchronous and follow a defined REQUEST/ACKNOWLEDGE protocol. One eight-bit byte of information may be transferred with each handshake.

4.1.1 BUS SIGNALS

The SCSI bus consists of 9 control signals and 9 data signals. These are described below:

4.1.1.1 BUSY (BSY)

BSY is an "or-tied" signal which indicates that the bus is in use.

4.1.1.2 SELECT (SEL)

SEL is an "or-tied" signal used by an Initiator to select a Target or by a Target to reselect an Initiator.

4.1.1.3 CONTROL/DATA (C/D)

C/D is a Target-driven signal to indicate whether CONTROL or DATA information is on the data bus. Assertion indicates CONTROL. Outbound control information is a command while inbound control information is status.

4.1.1.4 INPUT/OUTPUT (I/O)

I/O is a Target-driven signal which controls the direction of data movement on the data bus relative to an Initiator. Assertion indicates INPUT to the Initiator.

4.1.1.5 MESSAGE (MSG)

MSG is a Target-driven signal indicating the MESSAGE phase.

4.1.1.6 REQUEST (REQ)

REQ is a Target-driven signal indicating a request for a REQ/ACK data transfer handshake.

4.1.1.7 ACKNOWLEDGE (ACK)

ACK is an Initiator-driven signal indicating acknowledgment of a REQ/ACK data transfer handshake.

4.1.1.8 ATTENTION (ATTN)

ATTN is an Initiator-driven signal indicating the ATTENTION condition. ATTN is a request from the Initiator to the Target to perform a Message Out transfer.

4.1.1.9 RESET (RST)

RST is an "or-tied" signal indicating the RESET condition. The ACB-5580 never initiates a RESET condition.

4.1.1.10 DATA BUS (DB: 7-0, PARITY)

Eight data bit signals, plus a parity bit signal, comprise the DATA BUS. DB(7) is the most significant bit and has the highest priority during arbitration. Significance and priority decrease with decreasing bit number with the least significant being DB(0).

Data parity, DB(P), is odd. The ACB-5580 always generates correct bus parity for inbound transfers. A jumper is installed to enable the ACB-5580 to check outbound parity for those systems that support parity. All initiators must support parity if the ACB-5580 parity check is enabled.

Each of the eight data signals DB(7) through DB(0) is uniquely assigned as a Target or Initiator bus address (i.e., DEVICE I.D.). The Device ID is set in an ACB-5580 by jumpers A1, A2, and A4.

4.1.2 BUS PHASES

The bus has eight distinct operational phases and cannot be in more than one phase simultaneously. Detailed phase information and timing specifications are contained in the ANSI X3T9.2 SCSI Specification.

- o BUS FREE PHASE
 - o ARBITRATION PHASE
 - o SELECTION PHASE
 - o RESELECTION PHASE
 - o COMMAND PHASE
 - o DATA PHASE
 - o STATUS PHASE
 - o MESSAGE PHASE
- \
|
/ INFORMATION TRANSFER PHASES

4.1.2.1 BUS FREE PHASE

The BUS FREE phase, indicating that the bus is available for use, is entered by the deassertion and passive release of all bus signals. Once the BUS FREE phase is detected, the active initiator must deassert and passively release all bus signals (within a BUS CLEAR DELAY) after deassertion of BSY.

Devices sense BUS FREE when SEL and BSY are not asserted (simultaneously within a DESKEW DELAY) and the RESET condition is not active.

4.1.2.2 ARBITRATION PHASE

The ARBITRATION phase allows one SCSI device to gain control of the bus. Once a device that wants to arbitrate for the bus detects the BUS FREE phase, it waits a BUS FREE DELAY and then asserts BSY with its own I.D. bit on the Data Bus. (Data parity is not guaranteed valid during ARBITRATION.)

After an ARBITRATION DELAY, the device examines the data bus. If a higher priority I.D. is on the bus or a select from another device is present, the device clears itself from arbitration by releasing the BSY and I.D. signals. If the device determines that its own I.D. is the highest priority, it leaves BSY asserted and asserts SELECT. ARBITRATION is then complete.

4.1.2.3 SELECTION PHASE

The SELECTION phase allows an Initiator to select an ACB-5580. During the SELECTION phase, the I/O signal is deasserted so that this phase can be distinguished from the RESELECTION phase. The ACB-5580 operates in both arbitrating and non-arbitrating systems. In non-arbitrating systems, there may be only one Initiator. It may raise select with the Target I.D. asserted whenever the Bus Free phase is present.

In arbitrating systems, the SELECTION phase is entered with both BSY and SEL asserted; the Initiator then waits a minimum of a Bus Clear Delay plus a Bus Settle Delay before driving the DATA bus with the Target I.D. and its own I.D. After two DESKEW DELAYS, the Initiator then releases BSY. If only one Initiator is installed, and no disconnection is supported, the Initiator need not provide its own I.D.

On detecting the condition that Select and its own I.D. are asserted, and BSY and I/O are not asserted, the selected Target examines the DATA bus for the Initiator I.D. and responds by asserting BSY.

After a minimum of two DESKEW DELAYS (following the detection of BSY from the Target), the Initiator deasserts SEL and may change the DATA signals.

The Initiator may "time out" the SELECTION phase by deasserting the I.D. bits on the bus. If, after a TIMEOUT DELAY BSY has not been asserted, one of the selection timeout procedures specified in the ANSI X379.2 SCSI specification will be followed. The ACB-5580 drives BSY within 250 microseconds of detecting SEL and its own I.D. If parity checking is enabled, Bus Out parity must be valid during the selection phase.

4.1.2.4 RESELECTION PHASE

If an Initiator supports reconnection, the ACB-5580 can release the SCSI bus for other activities while the disk devices are performing mechanical motions. The Initiator informs the ACB-5580 that it can support reconnection by transmitting the proper bits in the Identify Message Out right after the Selection phase. The ACB-5580 will then disconnect at the proper times, first presenting a Save Pointers message and a Disconnect message to the Initiator. The Save Pointers message indicates to the Initiator that it must preserve all necessary information to later continue the operation when reconnect takes place.

After successfully gaining control of the SCSI by winning an Arbitration phase, the Target has both BSY and SEL asserted. It then informs the Initiator that it desires reconnection by asserting the I/O signal. The ACB-5580 then drops BSY. The reselected Initiator then asserts BSY. When the ACB-5580 sees the Initiator's BSY, it raises BSY and drops SEL. The host causing I/O then drops BSY. This winds up in the same state as it would be for a normal selection. The ACB-5580 then informs the Initiator which device is being reconnected with an Identify Message In. The Initiator then restores all the necessary state information to continue the original operation.

4.1.2.5 INFORMATION TRANSFER PHASES

The COMMAND, DATA, STATUS and MESSAGE phases are all used to transfer data or control information through the DATA bus.

The C/D, I/O and MSG signals are used to differentiate the various INFORMATION TRANSFER phases. Note that these signals are not meaningful until REQ has been asserted. See Table 4-1.

Table 4-1. Information Transfer Phases

SIGNAL			PHASE NAME	DIRECTION OF INFORMATION XFER
MSG	C/D	I/O		
0	0	0	DATA OUT PHASE	(INIT to ACB-5580)
0	0	1	DATA IN PHASE	(ACB-5580 to INIT)
0	1	0	COMMAND PHASE	(INIT to ACB-5580)
0	1	1	STATUS PHASE	(ACB-5580 to INIT)
1	0	0	Reserved	
1	0	1	Reserved	
1	1	0	MSG OUT PHASE	(INIT to ACB-5580)
1	1	1	MSG IN PHASE	(ACB-5580 to INIT)

NOTES: 0 = SIGNAL DEASSERTION
 1 = SIGNAL ASSERTION
 INIT = INITIATOR
 ACB-5580 = TARGET

The INFORMATION TRANSFER phases use the REQ/ACK handshake to control data transfer. Each REQ/ACK allows the transfer of one byte of data. The handshake starts with the Target asserting the REQ signal. The Initiator responds by asserting the ACK signal. The Target then deasserts the REQ signal and the Initiator responds by deasserting the ACK signal.

With I/O signal asserted, data will be input to the Initiator from the ACB-5580. The ACB-5580 ensures that valid data is available on the bus (at the Initiator port) before the assertion of REQ at the Initiator port. The data remains valid until the assertion of ACK by the Initiator. The Initiator must ensure that data has been read from the bus before asserting ACK. The ACB-5580 compensates for cable skew and the skew of its own drivers. The ACB-5580 always guarantees good parity on inbound data transfers.

With the I/O signal not asserted, data will be output from the Initiator to the ACB-5580. The Initiator must ensure valid data on the bus (at the Target port) before the assertion of ACK on the bus. The Initiator should compensate for cable skew and skew of its own drivers. Valid data must remain on the bus until the ACB-5580 deasserts REQ. The ACB5580 will optionally check parity on the outbound data transfers.

During each INFORMATION TRANSFER phase, the BSY line remains asserted, the SEL line remains deasserted, and the ACB-5580 will continuously envelop the REQ/ACK handshake(s) with the C/D, I/O and MSG signals in such a manner that these control signals are valid for at least a BUS SETTLE DELAY before the REQ of the first handshake and remain valid until the deassertion of ACK at the end of the last handshake.

4.1.2.5.1 COMMAND PHASE

The COMMAND phase is used by the ACB-5580 to obtain Command Descriptor Blocks from the Initiator.

The ACB-5580 asserts the C/D signal and deasserts the I/O and MSG signals during the REQ/ACK handshake(s) of this phase.

4.1.2.5.2 DATA PHASES (DATA IN/DATA OUT)

The DATA phase includes both the DATA IN phase and DATA OUT phase.

The DATA IN phase is used by the ACB-5580 to input device data or state information to the Initiator. The ACB-5580 asserts the I/O signal and deasserts the C/D and MSG signals during the REQ/ACK handshake(s) of this phase.

The DATA OUT phase is used by the ACB-5580 to obtain write data and control parameters from the Initiator. The ACB-5580 deasserts the C/D, I/O and MSG signals during the REQ/ACK handshake(s) of this phase.

4.1.2.5.3 STATUS PHASE

The STATUS phase is used by the ACB-5580 to send status information to the Initiator.

The Target asserts C/D and I/O and it deasserts the MSG signal during the REQ/ACK handshake(s) of this phase.

4.1.2.5.4 MESSAGE PHASES (MESSAGE IN/MESSAGE OUT)

The MESSAGE phase includes both MESSAGE IN and MESSAGE OUT phases.

The MESSAGE IN phase is used by the ACB-5580 to present a message to the Initiator. The ACB-5580 asserts C/D, I/O and MSG during the REQ/ACK handshake(s) of this phase.

The MESSAGE OUT phase is used by the ACB-5580 to obtain a message from the Initiator. The ACB-5580 invokes this phase only in response to the ATTENTION condition from the Initiator. In response to the ATTENTION condition, the ACB-5580 asserts C/D and

MSG and deasserts the I/O signal during the REQ/ACK handshake(s) of this phase. The Target handshakes byte(s) in this phase until the ATTN signal goes false.

4.1.2.6 SIGNAL RESTRICTIONS BETWEEN PHASES

When the BUS is between phases, the following restrictions apply to the bus signals:

- o The BSY, SEL, REQ and ACK signals may not change.
- o The C/D, I/O, MSG and DATA signals may change.
- o The ATTN and RST signals may change as defined under the descriptions for the ATTENTION and RESET conditions.

4.1.3 BUS CONDITIONS

The bus has two asynchronous conditions: The ATTENTION condition and the RESET condition. These conditions cause certain BUS DEVICE actions and can alter the bus phase sequence.

4.1.3.1 ATTENTION CONDITION

ATTENTION allows the Initiator to signal the ACB-5580 of a waiting message. The ACB-5580 may access the message by invoking a MESSAGE OUT phase.

The Initiator creates the ATTENTION condition by asserting ATTN at any time except during the ARBITRATION and BUS FREE phase. The ACB-5580 responds when ready with the MESSAGE OUT phase. The Initiator keeps ATTN asserted if more than one byte is to be transferred.

The Initiator can only deassert the ATTN signal during the RESET condition, during a BUS FREE phase, or while the REQ signal is asserted and before the ACK signal is asserted during the last REQ/ACK handshake of a MESSAGE OUT phase.

4.1.3.2 RESET CONDITION

The RESET condition, created by the assertion of RST, is used to immediately clear all devices from the bus and to reset these devices and their associated equipment.

RESET can occur at any time and takes precedence over all other phases and conditions. Any device (whether active or not) can invoke the RESET condition. On RESET, all devices immediately (within a BUS CLEAR DELAY) deassert and passively release all bus signals except RST itself.

The RESET condition stays on for at least one RESET HOLD TIME. During the RESET condition, no bus signal except RST can be assumed valid.

Regardless of the prior bus phase, the bus resets to a BUS FREE phase following a RESET condition.

By setting jumpers on the ACB-5580 jumper header (J7), the user can select either a hard reset mode or a soft reset mode.

When the jumper at position HR is installed, a hard reset mode is established. When in hard reset mode, a RESET condition will force the ACB-5580 to clear all uncompleted commands, to release all reservations including dual port reservations, and to return all other modes, including mode select, set limits, and diagnostic states to their power on default conditions. The next time a drive is selected from the Initiator, the drive and all its mode select parameters will be re-initialized.

When the jumper is not installed at position HR, a soft reset mode is established. After clearing the SCSI bus information and waiting until the Reset Condition has ended, the ACB-5580 will attempt to complete any uncompleted commands which were fully identified. All SCSI device reservations and operating modes are preserved. The ANSI X3T9.2 SCSI specification defines the conditions under which commands are considered completely identified and completed.

4.1.4 PHASE SEQUENCING

Phases are used on the bus in a prescribed sequence. In all systems, the RESET condition can interrupt any phase and is always followed by the BUS FREE phase. (Any other phase can also be followed by the BUS FREE phase.)

The normal progression is from BUS FREE to ARBITRATION, from ARBITRATION to SELECTION or RESELECTION and from SELECTION or RESELECTION to one or more of the INFORMATION TRANSFER phases (COMMAND, DATA, STATUS or MESSAGE).

There are few architectural restrictions on the sequencing between INFORMATION TRANSFER phases although the ACB-5580 does have a clearly defined sequence of transfers which it manages.

4.1.5 TIMING

A timing chart is provided in Figure 4-2. Further timing requirements are defined in the ANSI X3T9.2 SCSI Specification. Unless otherwise indicated, the delay time measurements for each device are calculated from signal conditions existing at the device port. Delays in the bus cable need not be considered for these measurements.

o ARBITRATION DELAY: 2.2 microseconds

The minimum time that an SCSI device should wait from asserting BSY for arbitration until the data bus can be examined to see if arbitration has been won. There is no maximum time.

o BUS CLEAR DELAY: 800 nanoseconds (maximum)

The maximum time allowed for a device to stop driving all bus signals after the release of BSY when going to BUS FREE.

o BUS FREE DELAY: 800 microseconds

The minimum time allowed to an SCSI device from detection of the BUS FREE phase to its assertion of BSY and its I.D. during arbitration.

o BUS SETTLE DELAY 400 nanoseconds (minimum)

o DESKEW DELAY: 45 nanoseconds (minimum)

o RESET HOLD TIME: 25 microseconds (minimum)

The minimum time during which RST is asserted. No maximum.

o SELECT TIMEOUT DELAY: 250 milliseconds

The delay allowed for a BSY response from a TARGET before time out during SELECTION.

4.1.6 ELECTRICAL INTERFACE

All signals are low true and use open collector drivers terminated with 220 ohms to +5 volts (nominal) and 330 ohms to ground at each end of the cable.

Each signal driven by the controller has the following output characteristics:

True (Signal Assertion) = 0.0 to 0.4 VDC @ 48 mA (max/)
False (Signal Non-Assertion) = 2.5 to 5.25 VDC.

Adaptec controllers use a 7438 open collector driver to meet this specification.

Figure 4-1' shows an example of proper bus termination.

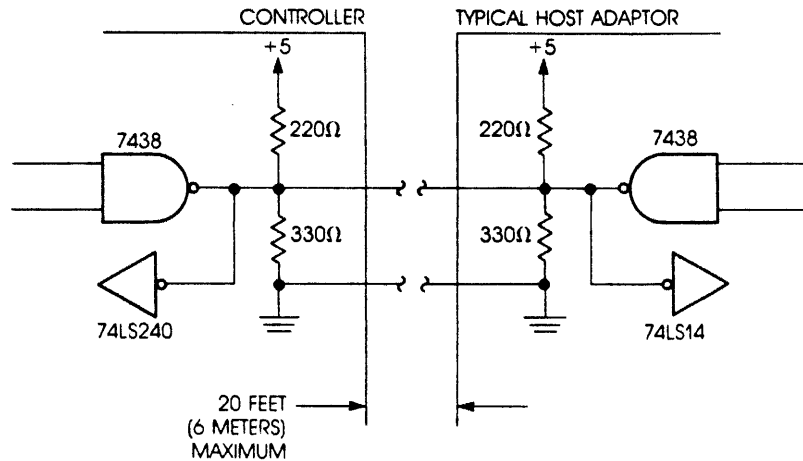

Figure 4-1. Host Adapter Bus Termination

4.1.7 CONNECTION DIAGRAM

A 50-pin latching connector is provided at position J8. Matching connectors include:

AMP
MOLEX
3M.

The SCSI single-ended non-shielded connection is used. All signals are asserted at the low level. All odd pins are grounded. A maximum cable length of 20 feet (6 meters) is allowed. Figure 4-2 shows the SCSI connection pins.

Ground	^	1	2	- Data Bit 0 (DB0)	(Input/Output)	
			4		1	.
			6		2	.
			8		3	.
			10		4	.
			12		5	.
			14		6	.
			16	- Data Bit 7 (DB7)		.
			18	- Data Bit P (DBP)	(Input/Output)	
	v		20	Ground		
Ground		23	22	Ground		
No Connection		25	24	Ground		
Ground		27	26	No connection		
	^		28	Ground		
			30	Ground		
			32	- Attention	(Input)	
			34	Ground		
			36	- Busy	(Input/Output)	
			38	- Acknowledge	(Input)	
			40	- Reset	(Input)	
			42	- Message	(Output)	
			44	- Select	(Input/Output)	
			46	- Control/Data	(Output)	
			48	- Request	(Output)	
	v	49	50	- Input/Output	(Output)	
Ground						

Figure 4-2. SCSI Bus Pin Assignments

4.2 MESSAGE SPECIFICATION

The message system allows communication between an Initiator and an ACB-5580 for purposes of physical path management. This section defines the messages supported by the ACB-5580.

4.2.1 MESSAGE SYSTEM

The ACB-5580 supports a considerable number of messages to perform such special functions as disconnect/reconnect and command linking. Certain Initiators, including the Adaptec ACB-1510 and ACB-1530, fully support those messages, but certain others do not. The Initiator indicates that it can support more than the COMMAND COMPLETE message by creating the ATTENTION condition prior to the bus state of SEL asserted and BSY deasserted in the SELECTION phase.

If the ACB-5580 sees this ATTENTION condition, it will request a message byte from Initiator by executing a MESSAGE OUT information transfer. The outgoing IDENTIFY message indicates the drive to be selected and also indicates whether the disconnect/reconnect functions are supported by the Initiator.

The first message out may also be a BUS DEVICE RESET message.

4.2.2 SCSI MESSAGE DESCRIPTIONS

Table 4-2 shows the messages supported by the ACB-5580

Table 4-2. Message Codes Supported by the ACB-5580

HEX CODE	DESCRIPTION	DIRECTION	
00	Command Complete	In	
02	Save Data Pointer	In	
03	Restore Pointers	In	
04	Disconnect	In	
05	Initiator Detected Error		Out
06	Abort		Out
07	Message Reject	In	Out
08	No Operation		Out
0A	Linked Command Complete	In	
0B	Linked Command Complete w/Flag	In	
0C	Bus Device Reset		Out
80 to FF	Identify	In	Out

4.2.2.1 SINGLE BYTE MESSAGES

Command Complete (00 HEX)

This message is sent by the ACB-5580 to indicate to the Initiator that the execution of a command or series of linked commands has terminated and that valid status has been sent to the Initiator. After sending this message, the ACB-5580 drops BSY and goes to the BUS FREE phase.

Save Date Pointer (02 HEX)

This code is sent by the ACB-5580 to direct the Initiator to save a copy of the present active command execution state, including data address pointers and other information, for the currently connected disk drive. See the SCSI specification for a definition of pointers.

Restore Pointers (03 HEX)

This code is sent from the ACB-5580 to direct the Initiator to restore the most recently saved pointers for the particular identified LUN to the active state. Pointers to the COMMAND, DATA, and STATUS locations for the LUN will be restored to the active pointers. COMMAND and STATUS pointers will be restored to their value at the beginning of the present command. The DATA pointer shall be restored to the value at the beginning of the command or at the value saved when the last SAVE DATA POINTER message was executed.

Disconnect (04 HEX)

This message is sent by the ACB-5580 to inform an Initiator that the present physical path is going to be broken (the Target will disconnect by releasing BSY), but that a later reconnect will be required in order to complete the current operation. By not sending this message or the COMMAND COMPLETE message before going to BUS FREE phase (other than as a result of reset), the Target indicates that an error condition has occurred on the current command. This message does not save the DATA POINTER.

Initiator Detected Error (05 HEX)

This message is from the Initiator to inform the ACB-5580 that an Initiator-detected retryable error has occurred since the last time the state of the DATA POINTER was saved. Commonly, this is for a data parity error. The ACB-5580 will post error status with an error code of 2D.

Abort (06 HEX)

The message is sent from the Initiator to direct the ACB-5580 to:

- o Clear any operation for the specified LUN from the selecting Initiator. Only an operation for the selecting Initiator is affected. If no logical unit has been selected by the IDENTIFY message, then only the operation in process on the bus will be cleared by the Target.
- o Cause the bus to go to the BUS FREE phase.

No status or ending message shall be sent for the operation. It is not an error to issue this message to an LUN that is not currently performing an operation for the Initiator.

Message Reject (07H)

This code is sent from the Initiator or ACB-5580 if the message received was inappropriate or not implemented. The Initiator will assert the ATTN signal prior to its release of ACK for the REQ/ACK handshake of the message that will be rejected. When the ACB-5580 sends this message, it will change to MESSAGE IN phase and send this MESSAGE prior to requesting additional message bytes.

No Operation (08 HEX)

This message is sent from an Initiator in response to the ACB-5580's request for a message when the Initiator does not currently have any other valid message to send.

Linked Command Complete (0A HEX)

This message is sent from the ACB-5580 to an Initiator to indicate that the execution of a linked command has been completed and that status has been sent. The Initiator is then allowed to set up the pointers for the initial state for the next linked command.

Linked Command Complete with Flag (0B HEX)

This message is sent from the ACB-5580 to an Initiator to indicate that the execution of a linked command (with the FLAG set) has completed and that status has been sent. The Initiator is then allowed to set up the pointers for the initial state of the next linked command. Typically the FLAG would cause an interrupt in the Initiator.

Bus Device Reset (0C HEX)

This message can be sent from an Initiator to direct the ACB-5580 to reset all current I/O operations on that BUS DEVICE. This message forces the ACB-5580 to an initial state with no operations pending for any Initiator. Upon recognizing this message, the ACB-5580 goes to the BUS FREE phase.

Identify (80 to FF)

This code is sent by either the Initiator or ACB-5580 to establish the physical path connection between the Initiator and ACB-5580 for a particular disk device (or Logical Unit).

Bit-7 is always set to identify this message.

Bit-6 is set by the Initiator to indicate it is capable of accommodating disconnection and reconnection.

Bits-5, 4, 3, and 2 are reserved and must be zero.

Bits-1, and 0 specify a logical unit number (disk drive address) address in the ACB-5580.

4.3 FUNCTIONAL DESCRIPTION OF SCSI COMMANDS

By defining a fixed block structure using a simple, logical address scheme, the I/O interface can support device independence. The same code can be used to support both the ACB-5580 SMD Disk Controller and the ACB-5500 ST506 Disk Controller. In addition, by including the logical block address as a component of the command structure, implicit operations (such as SEEK and Retry) can be performed by the basic READ and WRITE commands.

This interface, despite its simplicity, is capable of providing the high level of performance required in a multi-host/multi-task environment. Functional examples of SCSI command and data interactions are detailed below.

4.3.1 SINGLE COMMAND EXAMPLE

A typical operation on the SCSI interface is a READ of disk data.

The Initiator has an active state and a set of stored states (representing active disconnected devices). The Initiator sets up the active state for the operation requested by the host system, arbitrates for the SCSI bus, and selects the SCSI device required. The ACB-5580 then assumes control of the operation.

The ACB-5580 checks to see if ATTN is present, indicating that the Initiator is hoping to send an Identify message. The ACB-5580 obtains the Identify message and uses it to determine which logical unit (SMD drive) is being addressed. The ACB-5580 then obtains the command descriptor block, 6 or 10 bytes of command information, and determines that a Read of certain logical blocks is desired by the Initiator. The ACB-5580 performs all the disk control and data transfer operations necessary to transmit the logical blocks to the Initiator. All seeks, retries, defect skipping, and error correction are performed to recover the logical blocks as quickly as possible and with no management from the Initiator.

After the read data has been transferred to the Initiator, the ACB-5580 presents ending status and a Command Complete message to inform the Initiator that the operation was completed successfully. The bus is then freed for further operations.

4.3.2 DISCONNECT/RECONNECT EXAMPLE

In the above READ example, the drive may require a time-consuming physical seek to reach the requested data. In order to improve system throughput, the ACB-5580 disconnects from the Initiator, freeing the SCSI bus to allow other Initiator requests to be sent to other controllers or other devices on the same controller during the time that would otherwise be wasted.

A typical disconnection is performed after the Command Descriptor Block has been transferred and before data is transferred. The ACB-5580 indicates that the Initiator must store its active state information by sending a Store Pointers message, then sends a Disconnect message to indicate that the SCSI bus will be freed up, but that the operation will continue later.

When the physical motions of the device are complete, the ACB-5580 reselects the Initiator and passes an Identify message to it. The Identify message provides the necessary information for the Initiator to re-activate the stored state information. The read operation then continues as previously described.

4.3.3 LINKED COMMAND EXAMPLE

The Link function defines a relationship between commands which, when combined with the RELATIVE ADDRESS BIT, allows previous operations to modify subsequent commands. Linked operation makes high performance I/O functions possible by providing a relative addressing capability and allowing multiple command execution without invoking the host software and without requiring a new SELECTION phase.

As one example of a linked operation, the Initiator may want to restrict any Read operations to a certain set of tracks. This may be done by linking a SET LIMITS command to a READ command. After normal execution of the SET LIMITS command, the ACB-5580 presents a LINKED COMMAND COMPLETE message instead of a COMMAND COMPLETE message. The LINKED COMMAND COMPLETE indicates to the Initiator that it must now set up for the next command, a READ. The ACB-5580 requests the Command Descriptor Block, interprets the READ, and continues a normal READ command, but limited to the set of logical blocks specified by the SET LIMITS command.

The linked command structure can similarly be used by the SEARCH EQUAL command.

4.4 COMMAND STRUCTURE

4.4.1 COMMAND DESCRIPTOR BLOCK (CDB)

An I/O request to a device is made by passing a Command Description Block (CDB) to the Controller. The first byte of the CDB is the command group and operation code. The remaining bytes specify the Logical Unit Number (LUN), starting block address, control byte, and the number of blocks to transfer. Commands are categorized into two formats supported in ADAPTEC controllers:

- o Group 0: 6-Byte commands
- o Group 1: 10-Byte commands.

Tables 4-3 and 4-4 show typical group 0 and group 1 command descriptor block formats.

Table 4-3. Group 0 Commands (6-Byte Commands)

	BIT							
BYTE	7	6	5	4	3	2	1	0
00	Group Code			Opcode				
01	Logical Unit Number			(MBS)	Logical Block Address			
02	Logical Block Address							
03	Logical Block Address							(LSB)
04	Number of Blocks							
05	Reserved (0)						Flag	Link

Table 4-4. Group 1 Commands (10-Byte Extended Block Address)

BYTE	7	6	5	4	3	2	1	0
00	Group Code			Opcode				
01	Logical Unit Number			Command Specific Bits			REL	ADR
02	(MBS)			Logical Block Address				
03				Logical Block Address				
04				Logical Block Address				
05				Logical Block Address				(LSB)
06	Reserved							
07	Number of Blocks							
08	Number of Blocks							
09	Reserved (0)					Flag	Link	

4.4.2 GROUP CODE

The group code can be 0 to 7 indicating the SCSI command group. The ACB-5580 uses only 0 and 1 to indicate Group 0 (6 byte) and Group 1 (10 byte) Commands.

4.4.3 OPERATION CODE

The operation code indicates to the controller the command to be executed. The operation code allows for 32 commands (00 HEX to 1F HEX).

4.4.4 LOGICAL UNIT NUMBER

Logical unit numbers identify up to 8 devices attached to a controller. The ACB-5580 accepts logical unit numbers from 0 to 3, addressing 4 SMD disk devices per controller. The logical unit number is only examined and used by the ACB-5580 if the IDENTIFY message was not provided.

4.4.5 COMMAND SPECIFIC BITS

Byte 01, bits 01 - 04 specify options which depend upon the particular command.

4.4.6 RELATIVE ADDRESS BIT

The RELATIVE ADDRESS BIT (Bit 0 of Byte 01) of the Group 1 commands is set to indicate that the block address portion of the CDB is a two's complement displacement. This displacement is to be added to the Block Address last accessed on the unit to form the Block Address for the present command. This feature is only available when linking commands. The feature requires that a previous command in the linked group have accessed a block of data on the device.

4.4.7 LOGICAL BLOCK ADDRESS

Group 0 commands contain 21-bit starting block addresses while Group 1 supports 32-bit block addressing.

4.4.8 NUMBER OF BLOCKS

A variable number of blocks may be transferred under a single command. Group 0 commands may transfer up to 256 blocks, while Group 1 commands may transfer up to 65,535 blocks. A zero value for a Group 0 command implies a 256 block transfer. A zero value for a Group 1 command implies a zero length transfer.

4.4.9 CONTROL BYTE

The control byte is the last byte in a Class 00 or Class 01 command. The command byte is defined as follows:

Bits 7-2 Reserved; must be zero

Bit 1 FLAG--This bit indicates that an interrupt is requested for this command in a group of linked commands. This bit may only be set for LINKED commands.

Bit 0 LINK--This bit indicates the existence of a LINKED command which will be automatically executed upon successful completion of the current command.

4.5 COMPLETION STATUS BYTE

Status is always sent at the end of a command or set of linked commands. Intermediate status is sent at the completion of a linked command. Any abnormal condition encountered during command execution causes command termination and ending status.

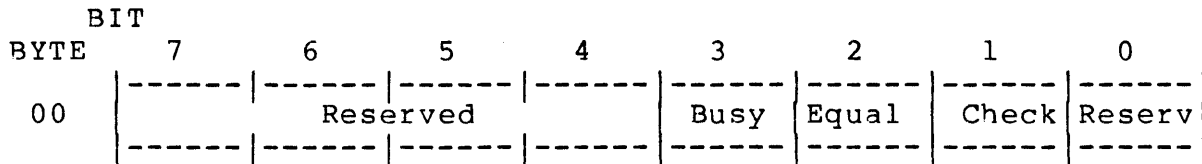

Figure 4-3. Completion Status Byte

Bits 0, 5, 6 & 7: Zero for ACB-5580.

Bit 1: Check condition. Sense is available. See REQUEST SENSE command, section 6.3.

Bit 2: Condition met. Set when any SEARCH is satisfied.

Bit 3: Busy. Device is busy or reserved. Busy status will be sent whenever the ACB-5580 is unable to accept a command from a Host. This condition occurs when a Host that does not allow reconnection requests an operation from a reserved or busy device. It also occurs if a dual port device is reserved to the other controller.

5.0 SMD INTERFACE DESCRIPTION

5.1 INTRODUCTION

The SMD Interface is an industry standard for connecting high performance magnetic disk drives to disk controllers. The SMD interface is based on the interface used by the Storage Module Drive, a high performance, high capacity drive made by Magnetic Peripherals, Inc., a subsidiary of Control Data Corporation. A large family of drives having similar characteristics is now made by MPI. Many companies, including NEC, Fujitsu, Century Data, Micropolis, Priam, and others make drives that use the same interface. Drive capacities range from under 20 to over 300 Megabytes. Some removable media drives are supported by the SMD interface. Small variations exist in the interface presented by the different drives. The drives range in data rate from about 8.5 Megabits/second to about 10.2 Megabits/second. All the drive read/write channel functions, including clock and data decoding, are done in the drive so that no electronic adjustments are required by the ACB-5580 to support the different data rates.

The drives support sophisticated functions, including rapid transmission of seek addresses and dual port access. The ACB-5580 provides support for these sophisticated functions.

5.2 INTERFACE SIGNALS

The SMD interface consists of a control cable (A Cable) multi-dropped from the ACB-5580 to all attached drives. A second cable (B Cable) is attached to each drive to provide an independent data and status connection for each attached drive. The ACB-5580 supports from one to four devices and therefore must have connectors for four B Cables. The terminators for the multi-dropped A Cable must be removed from all drives except the one most remote from the ACB-5580. The ACB-5580 A Cable terminators are not removable.

The interface cables are used as described in the MPI Flat Cable Interface Specification, previously referenced. The assignments for the bus and tag lines in the A Cable are defined in the following table:

Table 5-1. Tag/Bus Lines

Bus	Tag 1 Cylinder Address	Tag 2 Head Address	Tag 3 Control Select
0	1	1	Write Gate
1	2	2	Read Gate
2	4	4	Servo Offset Plus
3	8	8	Servo Offset Minus
4	16	-	Fault Clear
5	32	-	AM Enable
6	64	-	RTZ
7	128	-	Data Strobe Early
8	256	-	Data Strobe Late
9	512	-	Release 1

The following signals are not driven by the ACB-5580:

Unit Sel 4: Unit Select 4 is fixed at the zero value, since only drives 0 to 3 are addressable by the ACB-5580.

Unit Sel 8/Tag 5: Unit Select 8/Tag 5 is only driven to recover error information on drives supporting the Tag 5 function.

Under Tag 3, Bus Out bits 2, 3, 7 and 8 are always driven to zero on the ACB-5580. The retry algorithms implied by these lines are not known to be required by any standard SMD drive.

All the control cable operations are controlled by the ACB-5580 microprocessor except while Tag 3 is active. Timings guarantee a minimum of 0.9 microsecond deskewing between setting SMD Bus out or Unit Address and transmitting any Tag or Unit Select signal. Tag 1 and Tag 2 are active a minimum of one microsecond and maximum of five microseconds.

Tag 3 timings are clocked from the 1F VFO signal or from Read Clock, depending on the particular activity.

Index and sector pulses must be no shorter than 9 bit times.

All read timings are generated from beginning of the Index or Sector pulse. A serial bit delay from write to read of from 4 to 12 bit times is acceptable. The read timings, write timings, and track format are given in Figures 5-1 through 5-4.

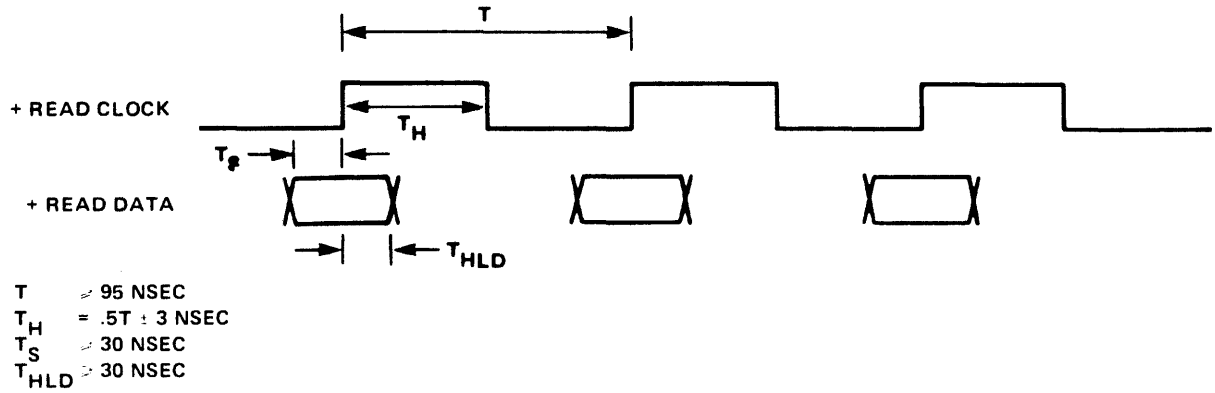

Figure 5-1. SMD Read Signal Timing Requirements

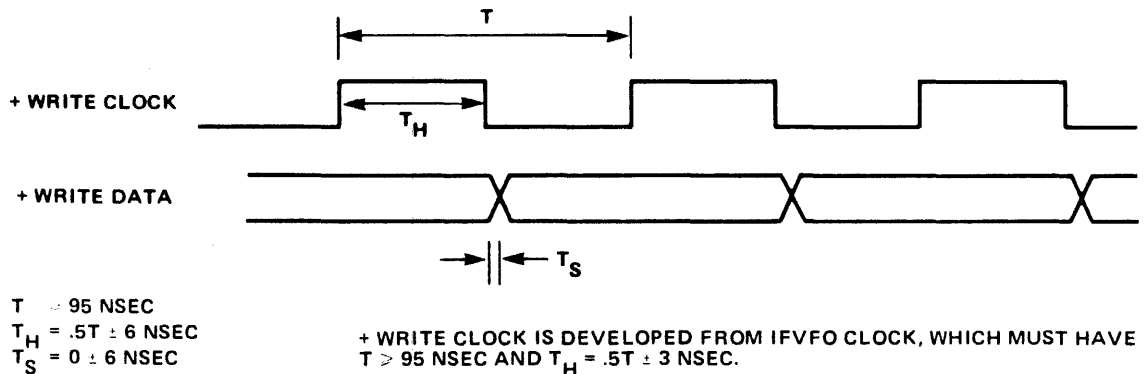

Figure 5-2. SMD Write Signal Timing Provided

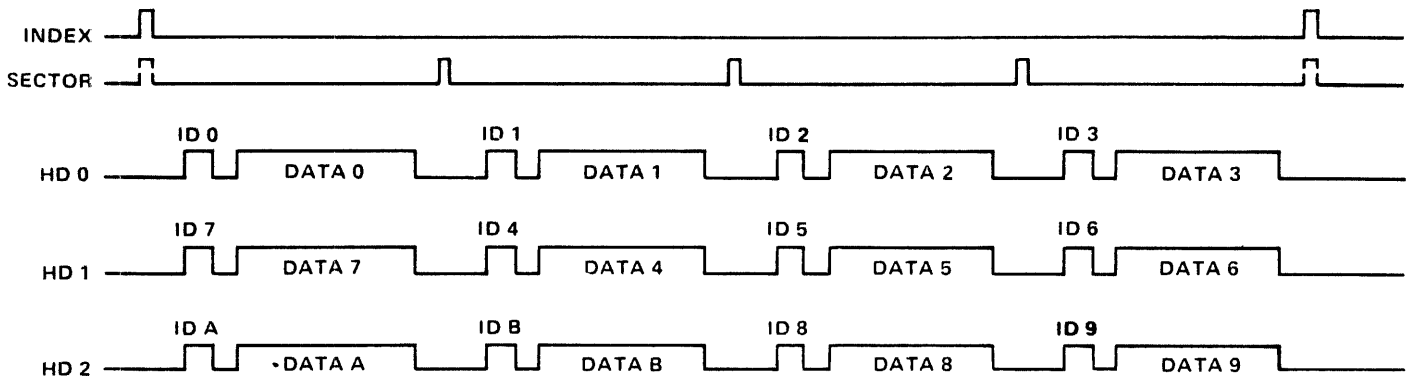
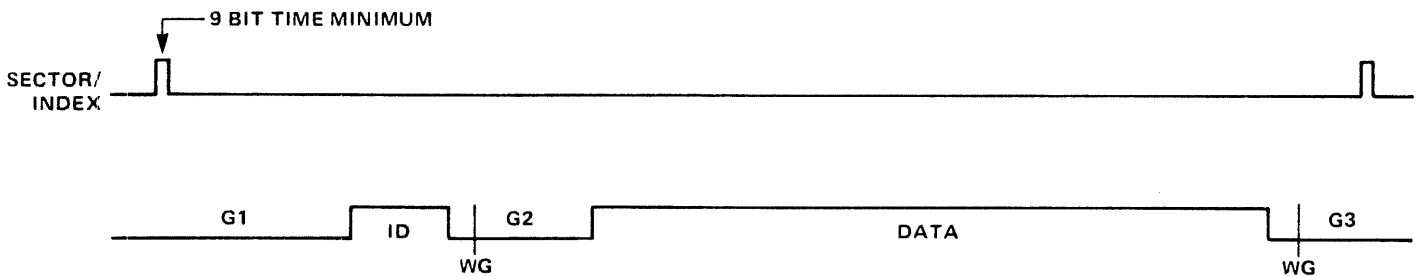

Figure 5-3. SMD Track Format
ACB-5580, Cylinder 0, 4-Sector Example
Showing Head Switch Displacement



- G1 = 25 BYTES OF '00' H, NOMINAL
- ID = 2 SYNC BYTES + 5 LOGICAL ID BYTES + 4 ECC BYTES
- G2 = 2 BYTES OF '00' H TO WRITE GLITCH (WG), BYTES OF '00' H AFTER WRITE GLITCH
- DATA = n DATA BYTES + 2 SYNC BYTES + 4 ECC BYTES
- G3 = 2 BYTES OF '00' H TO WRITE GLITCH, n BYTES OF '00' H TO NEXT SECTOR PULSE

Figure 5-4. SMD Track Format
ACB-5580, Typical 256 Data Byte Format

5.3 OPTIONAL TAGS FOR ERROR PRESENTATION

When the configuration bits 0 and 1 are set to the correct value, additional error information is available using Tags 4 and 5. The error byte recovered is placed in byte 0B Hex of the extended sense information.

5.3.1 TAG 5 ERRORS

When bits 1 and 0 of the J7 jumper are set to the values 01, all attached drives will be treated as if they support Tag 5. The information presented on SMD Bus In by the selected drive 2 microseconds after Tag 5 is raised and Tag 4 is not raised will be captured and placed in the sense information device error byte 1. The Tag 5 information will be captured whenever check status condition is detected by the ACB-5580 and a drive is selected. Drives supporting Tag 5 include the NEC and Micropolis drives.

See Table 6-2 for mapping of the SMD Bus in bits to the error byte.

5.3.2 TAG 4 ERRORS

When bits 1 and 0 of the J7 jumper are set to the values 1 and 0, all attached drives will be treated as if they support Tag 4. Bits 8 and 9 of the SMD Bus Out are set to zero. Tag 4 is then raised. The information presented on SMD Bus In by the selected drive 2 microseconds after Tag 4 is raised will be captured and placed in the sense information device error byte 1. The Tag 4 information will be captured whenever check status condition is detected by the ACB-5580 and a drive was selected. Drives supporting Tag 4 include the Fujitsu drives.

See Table 6-2 for mapping of the SMD Bus In bits to the error byte.

5.4 SMD DRIVE PREPARATION

SMD drives have a wide variety of internal switch adjustments that must be made. The following typical switch settings must be made to prepare an SMD drive for operation with the ACB-5580.

5.4.1 ACTUATOR/SPINDLE LOCK

The actuator and spindle must be unlocked prior to operation with the ACB-5580. Refer to the documentation for each drive concerning actuator locking requirements.

5.4.2 DISK ADDRESS

A set of 3 or 4 switches is generally available to establish the disk selection address. The disk must be set to address 0, 1, 2, or 3. The B Cable from each disk must be connected to the ACB-5580 B Cable connector corresponding to the disk's address.

5.4.3 SECTOR MODE

Many SMD drives support a soft sector mode as well as a hard sector mode. The disk must be set to operate in the hard sector mode.

5.4.4 AM MODE

Some SMD drives provide an alternate AM detection scheme using a DC erase area. This is normally disabled by placing the drive in hard sector mode, but other machines require it to be disabled independently. The DC-erase AM detection should be inhibited.

5.4.5 RPS MODE SELECT

Some SMD drives use microcode or hardware examination of the sector counter value to perform a rotational position sensing (RPS) function. This function should be disabled.

5.4.6 FORMAT WRITE RELEASE

A soft sector drive may provide an automatic format to index function. This function cannot be used in hard sector mode and must be disabled.

5.4 7 TAG 4/5 CONTROL

Those drives supporting Tag 4 or Tag 5 usually have a method of enabling and disabling the function. The ACB-5580 only uses Tag 4 and Tag 5 for collection of error information as previously described.

The Tag 4/5 functions must be enabled if the ACB-5580 is plugged to use the Tag 4/5 error recovery information. If pins 0 and 1 of J7 have no jumpers, the Tag 4/5 error recovery is not performed and Tag 4/5 should be disabled.

5.4.8 INTERFACE CONTROL LINES

A number of enabling states are available on drives, especially if dual port functions are supported. All interfaces connected to an ACB-5580 must be active and enabled if the drive is expected to operate.

5.4.9 SECTOR SELECTION SWITCHES

An SMD drive operated in hard sector mode has a large number of sector sizes that can be selected by setting Sector Selection Switches. Each drive has a different format for setting up those switches and a different number of sectors of a certain size which can be assigned on a single track. The sector size must be at least as large as required for the selected logical block size for that drive. The ACB-5580 sector size requirements are specified below. Note that certain drives may have a short last sector. This sector must also meet the minimum length requirements. There are no maximum length requirements. The number of sectors and sector size must be specified in the Mode Select command prior to formatting.

ACB-5580 Block Length (bytes)	Minimum Drive Sector Size (bytes)
256	320
512	576
1024	1088

5.4.10 SERVO OFFSET MODE

The ACB-5580 does not perform servo offset during data retry. The Servo Offset Mode, if present, should be inhibited.

5.4.11 MOTOR START DELAY

The ACB-5580 does not directly participate in motor power control of any attached SMD drive. Any motor start delay options available to the drive should be set according to the power and noise requirements of the installing system.

5.4.12 REMOTE/LOCAL CONTROL

The ACB-5580 allows the Pick and Hold lines on the SMD interface to be driven by an external source connected to J6, the power control connector. The lines are normally controlled by providing a ground to the Pick and Hold signals in the sequence specified by the drive document. A limit of 10 volts and 100 milliamps may be passed through the J6 connector to or from the Pick and Hold lines. The control signal lines must not have high frequency noise or ground loop noise present.

If the system chooses to use Pick and Hold through the ACB-5580 as the motor control function, the drive must be set to allow Remote power control. If the system chooses not to use Pick and Hold, the drive must be set to allow Local power control. In Local power control mode, the drive will start its power up sequencing as soon as power is applied to the drive's power connector.

5.4.13 WRITE PROTECT

The ACB-5580 checks any write protect conditions established in the drive. The Write Protect switches should be set in the proper mode for the drive. Write Protect must be off to allow writes for any formatting or write commands.

5.5 ELECTRICAL INTERFACE

The ACB-5580 provides the standard electrical interface as specified by the MPI Flat Cable Interface Specification with the following exception.

The B Cable signal lines are terminated with 82 ohm resistors instead of 56 ohm resistors to provide a better match with the cable types commonly used in the B Cables.

5.6 CONNECTION DIAGRAM

The A Cable connection chart and B Cable connection chart are provided in Tables 5-2 and 5-3.

Table 5-2. "A" Cable Pin Assignment

1	Tag 1 L	31	Tag 1 H
2	Tag 2 L	32	Tag 2 H
3	Tag 3 L	33	Tag 3 H
4	Bus 0 L	34	Bus 0 H
5	Bus 1 L	35	Bus 1 H
6	Bus 2 L	36	Bus 2 H
7	Bus 3 L	37	Bus 3 H
8	Bus 4 L	38	Bus 4 H
9	Bus 5 L	39	Bus 5 H
10	Bus 6 L	40	Bus 6 H
11	Bus 7 L	41	Bus 7 H
12	Bus 8 L	42	Bus 8 H
13	Bus 9 L	43	Bus 9 H
14	Channel Ready L	44	Channel Ready H
15	Status 3 L	45	Status 3 H
16	Status 2 IL	46	Status 2 H
17	Status 1 L	47	Status 1 H
18	Index L	48	Index H
19	Status 0 L	49	Status 0 H
20	Status 5 L	50	Status 5 H
21	Busy L	51	Busy H
22	Unit Select Tag L	52	Unit Select Tag H
23	Unit Select 1 L	53	Unit Select 1 H
24	Unit Select 2 L	54	Unit Select 2 H
25	Sector L	55	Sector H
26	Unit Select 4 L	56	Unit Select 4 H
27	Tag 5 L Unit Sel 8 L	57	Tag 5 H Unit Sel 8 H
28	Status 4 L	58	Status 4 H
29	(Pick)	59	(Hold)
30	Tag 4 L	60	Tag 4 H

Table 5-3. "B" Cable Pin Assignment

1	GND	14	1F Write Clock H
2	1F Write Clock L	15	GND
3	Read Data L	16	Read Data H
4	GND	17	1F Read Clock H
5	1F Read Clock L	18	GND
6	Write Clock L	19	Write Clock H
7	GND	20	Write Data H
8	Write Data L	21	GND
9	Unit Selected H	22	Unit Selected L
10	Seek End L	23	Seek End H
11	GND	24	Index H
12	Index L	25	GND
13	Sector L	26	Sector H

5.7 REMOTE AND POWER CONTROL INTERFACE

Connector J6 provides the connection point for various system level controls that may be required over both the ACB-5580 and various attached drives. The connector is a 6-position 5 pin polarized in-line connector using .025" square pins on .100" centers. Pin position 2 is not present to allow a polarized plug to be used.

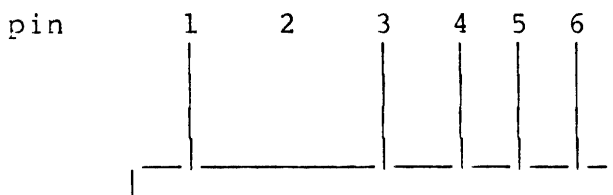

The pins are assigned as follows:

Pin 1 Channel Ready Remote

Pin 1 provides a system level mechanism for disabling the interface of all attached SMD drives. For this mechanism to be activated, the jumper pin in J7 labeled RMT must be connected. If J7 RMT is not installed, the Channel Ready Remote will have no effect.

If enabled, Channel Ready Remote may be driven by a high current TTL open collector driver (7438 or equivalent). When at the high level, Channel Ready on the SMD interface will be disabled. When held at the low level, Channel Ready will be active if no power on reset is present.

Drives addressed while Channel Ready is not active will post errors, usually selection failures.

Pin 2 Polarizing Location

Pin 3 Signal Ground

Pin 4 Hold Remote

Pin 4 provides a direct path for any required system level power control signals to the Hold signal on the SMD interface. It is a direct connection to the SMD connector J1 pin 59. Applied voltages must remain under 10 volts and applied currents must remain under 100 milliamps. Care should be taken to prevent injection of system or power supply noise in this pin.

Pin 5 Pick Remote

Pin 5 provides a direct path for any required system level power control signals to the Pick signal on the SMD interface. It is a direct connection to the SMD connector J1 pin 29. Applied voltages must remain under 10 volts and applied currents must remain under 100 milliamps. Care should be taken to prevent injection of the system or power supply noise in this pin.

Pin 6 Reset Remote

Pin 6 provides an external power on reset capability. The pin must be used with care, since system level resets may cause data integrity failures if they occur during write operations or during reserved states.

The pin should be driven by an unbiased open collector TTL driver (7438 or equivalent) or a low current relay to ground. The high or open state will allow normal operation. The grounded or closed state will force a reset. Injected noise in this pin will cause unexpected false reset conditions, so the circuit must be carefully protected. The closed state will sink less than 3 milliamps of current.

6.0 COMMAND DESCRIPTIONS

The following section describes the command set of the ACB-5580. Adaptec has followed the ANSI X3T9.2 SCSI Specification where possible. Deviations occur only to support special Adaptec functions or to clarify certain commands with a very large number of possible implementations. Each command contains a list of possible conditions and the exception Sense Error Code.

Table 6-1. Command Code Summary

<u>Command Code</u>	<u>Command Name</u>	<u>Data/Parameter</u>	<u>Source*</u>
00	Test Unit Ready	---	S
01	Rezero Unit	---	S
03	Request Sense	Sense Info In	S
04	Format Unit	Defect List Out	SA
08	Read	Data In	S
0A	Write	Data Out	S
0B	Seek	---	S
0F	Translate	Info In	A
10	Set Threshold	Info Out	A
11	Read/Reset Usage Counter	Info In	A
12	Inquiry	Info In	S
13	Write Buffer	Data Out	A
14	Read Buffer	Data In	A
15	Mode Select	Info Out	SA
16	Reserve	---	S
17	Release	---	S

Table 6-1. Command Code Summary
(Continued)

<u>Command Code</u>	<u>Command Name</u>	<u>Data/Parameter</u>	<u>Source*</u>
1A	Mode Sense	Info In	SA
1B	Start/Stop Unit	---	S
1C	Receive Diagnostic	Info In	SA
1D	Send Diagnostic	Info Out	SA
25	Read Capacity	Info In	S
28	Read (Extended)	Data In	S
2A	Write (Extended)	Data Out	S
2E	Write and Verify	Data Out	SA
2F	Verify	---	SA
31	Search Data Equal	Data Out	SA
33	Set Limits	---	S

* S = SCSI Standard Command
A = Adaptec Special Function
SA = SCSI Standard Command with Adaptec Subset.

6.1 TEST UNIT READY (00_H)

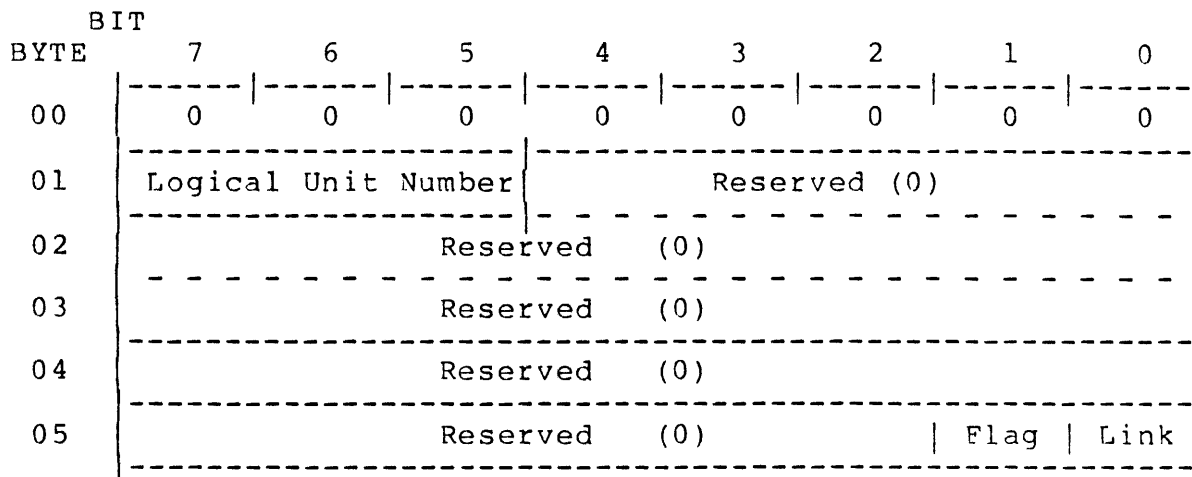

Figure 6-1. TEST UNIT READY Command

This command returns zero status if the requested unit is powered on and ready. If the drive is busy or reserved, appropriate status bits are set. If the drive is not operational, a check condition will be set in the status byte. In that case, Sense information will be preserved if a REQUEST SENSE command follows immediately.

Valid Errors:

<u>Error</u>	<u>Error Code</u>	<u>Sense Key</u>
Drive Not Ready	04 _H	2
Write Fault	03 _H	4
Selection Failure	05 _H	4
Bad Argument	24 _H	5

6.2 REZERO UNIT (01_H)

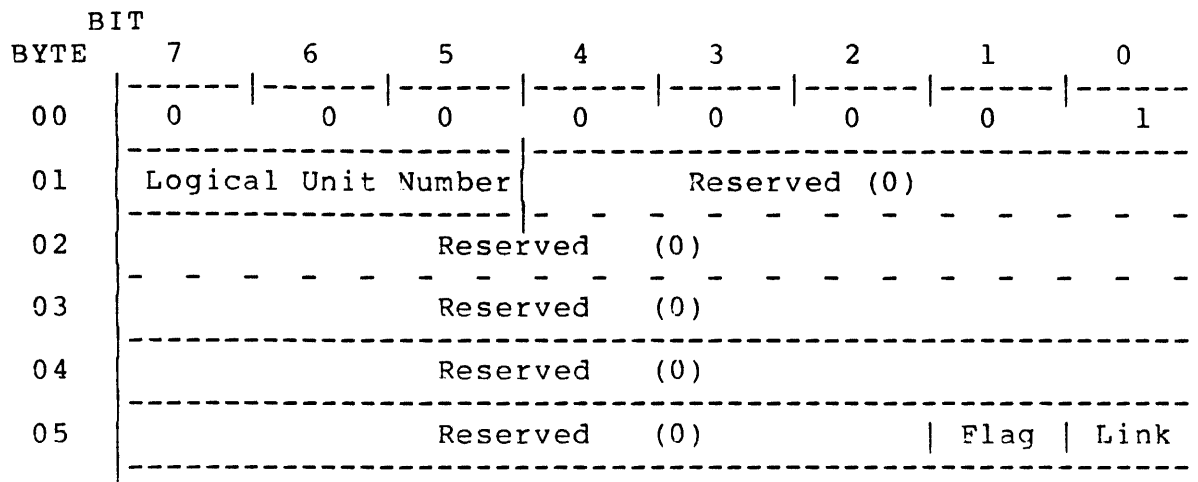

Figure 6-2. REZERO UNIT Command

This command sets the selected drive to track zero and then sends completion status. This may reset certain drive hardware failures.

Valid Errors:

<u>Error</u>	<u>Error Code</u>	<u>Sense Key</u>
No Seek Complete	02	4
Drive Not Ready	04	2
No Track 0	06	4
Selection Failure	05	4
Bad Argument	24	5

6.3 REQUEST SENSE (03_H)

BYTE	BIT							
	07	06	05	04	03	02	01	00
00	0	0	0	0	0	0	1	1
01	Logical Unit Number			Reserved (0)				
02	-			Reserved (0)				
03	-			Reserved (0)				
04	Allocation Length							
05	Reserved (0)					Flag		Link

Figure 6-3. REQUEST SENSE Command

This command returns unit sense.

The sense data will be valid for the CHECK status condition sent to the Host and will be saved by the controller until requested. Sense data will be cleared on receiving a subsequent command from the Host that received the check condition. Other hosts will receive BUSY status to commands for a LUN with non-zero sense to report. Therefore, CHECK status should always be followed by a SENSE Command.

The ACB-5580 can be set by installing the SS jumper on J7 to present the defacto standard 4 bytes of sense information. Many SMD drives have additional information which can be presented, however. When the SS jumper is not installed, SCSI standard extended sense bytes are presented. The Adaptec extended sense format contains 12 bytes.

The allocation length field indicates the maximum number of sense bytes that may be transmitted. An allocation length of zero defaults to request a 4-byte transfer. Any other length requests that number of bytes or fewer. The maximum number of bytes transmitted by the ACB-5580 is 4 for nonextended sense and 12 for extended sense.

The REQUEST SENSE command is the most important mechanism for informing the host of abnormal states discovered by the ACB-5580. Very few error conditions are presented as a result of REQUEST SENSE.

Valid Errors:

<u>Error</u>	<u>Error Code</u>	<u>Sense Key</u>
Bad argument	24	5
SCSI Bus Out Parity Check	2E	4
Adapter Parity Check	2F	4
SCSI HA/Initiator Detected Error	2D	4

Non-Extended Sense Byte Format

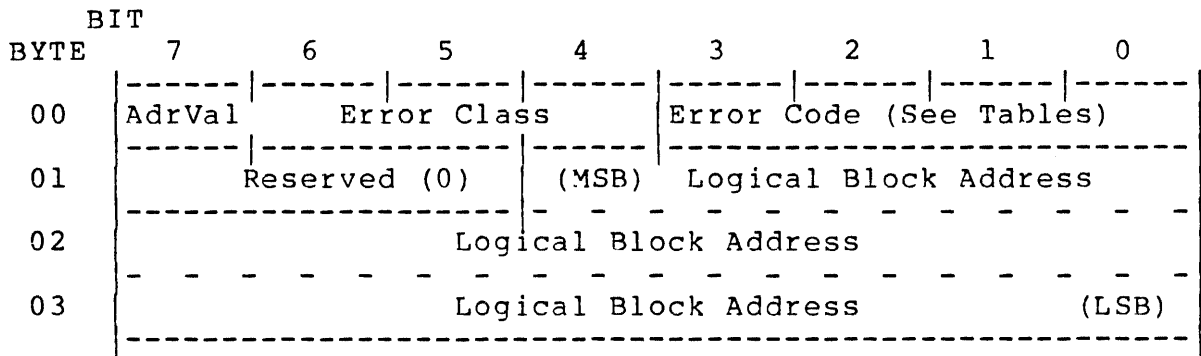

Figure 6-4. REQUEST SENSE Data

BYTE	BIT							
	7	6	5	4	3	2	1	0
00	AdrVal	1	1	1	0	0	0	0
01	Reserved (0)							
02	Reserved (0)				Sense Key			
03	Logical Block Address (MSB)							
04	Logical Block Address							
05	Logical Block Address							
06	Logical Block Address (LSB)							
07	0	0	0	0	0	1	0	0
08	0	Error Class			Error Code			
09	Device Type							
0A	Device Sense Byte 0							
0B	Device Sense Byte 1							

Figure 6-5. Extended Sense Byte Format

The AdrVal (Address Valid) bit indicates that the Information Bytes contain a valid logical block address for which the error condition was recorded.

The error class indicates the general type of error detected. Class 0 errors are related to drive state, including ready, seek complete, write fault and similar errors. Class 1 errors are related to data recovery problems. Class 2 errors are related to invalid requests from the host system. Class 7 is the class defining SCSI extended sense information.

The error code defines precisely the failure that was detected. These codes are described in Table 6-2.

The logical block address is either 21 or 32 bits long depending on the sense format option selected. It contains the address of the logical block for which the failure was detected. If the AdrVal bit is off, the logical block address is not meaningful. A few sense error codes store other information in the logical block address without turning on the AdrVal bit.

The Sense Key is the SCSI standard decode classifying sense information for operating system interpretation. The Sense Keys are described in Table 6-5. Note that each error class and code is presented in byte 08 of the extended sense information to clarify and qualify the actual failure. The sense key for each error is included in the error code table.

The device Type is set by the 1 and 0 jumpers on J7. It may have a value of 0, 1, 2, or 3, depending on the state of the jumper bits, jumper 1 being the high order bit. All drives attached to the controller are treated as the same device type.

Device Type 00_H is a standard SMD drive with no additional sense information available.

Device Type 01_H is an SMD drive using Tag 5 to recover additional sense information.

Device Type 02_H is an SMD drive using Tag 4 and bus modifier bits 8 and 9 to recover additional sense information.

Device Type 03_H is reserved. No additional sense information will be available.

Device Sense Byte 0 and 1 contain the information recovered according to the rules for each device type, according to the following table.

<u>Device Type</u>	<u>Device Sense</u> <u>Byte 0</u>	<u>Device Sense</u> <u>Byte 1</u>
00	Control byte (Tag 3)	00
01	Control byte (Tag 3)	Error Status (Tag 5)
02	Control byte (Tag 3)	Error Status (Tag 4, bits 8, 9 = 0)
03	00	00

The contents of Device Byte 0 and Byte 1 are mapped according to the following table.

Table 6-2. Mapping of SMD Bus In Lines

<u>SMD BUS IN BIT</u>	<u>SMD INTERFACE LINE</u>
(B17)	WRT PROTECTED
(B16)	AM FOUND
(B15)	UNIT READY
(B14)	ON CYLINDER
(B13)	SEEK ERROR
(B12)	FAULT
(B11)	SECTOR
(B10)	INDEX

Table 6-3. Class 00 Error Codes In Sense Byte (Drive Errors)

<u>CODE</u>	<u>ERROR</u>	<u>MEANING</u>	<u>SENSE KEY</u>
00	NO SENSE	No error occurred or error cleared before REQUEST SENSE command.	0
01	NO INDEX/SECTOR	No index or sector signal found during rd, wr, or format	4
02	NO SEEK COMPLETE	Seek complete signal missing	4
03	WRITE FAULT	Drive detected failure which disallows writes	4
04	DRIVE NOT READY	Drive not ready	2
05	SELECTION FAILURE	Incorrect Select Indication returned.	4

Table 6-4. Class 01 Error Codes In Sense Byte (Media Errors)

<u>CODE</u>	<u>ERROR</u>	<u>MEANING</u>	<u>SENSE KEY</u>
10	ID CRC ERROR	ID field could not be recovered by retry	3
11	UNCORRECTABLE DATA ERROR	Data field error could not be recovered by retry or correction	3
12	ID ADDRESS MARK NOT FOUND	Missing sector pulse	4
15	SEEK ERROR	Could not seek to track with correct ID	4
16-17	NOT ASSIGNED		
18	DATA CHECK IN NO RETRY MODE	See Send Diagnostic command	3
19	ECC ERROR DURING VERIFY	See Verify command	3
1A	NOT ASSIGNED		
1B	NOT ASSIGNED		
1C	UNFORMATTED OR BAD FORMAT ON DRIVE	Format failed, no valid format on drive; no mode select before format command. See Section 6.3.1	3
1D-1F	NOT ASSIGNED		

Table 6-5. Class 02 Error Codes (System-Related Errors)

<u>CODE</u>	<u>ERROR</u>	<u>MEANING</u>	<u>SENSE KEY</u>
20	INVALID COMMAND	Command not implemented by ACB-5580	5
21	ILLEGAL BLOCK ADDRESS	Block address outside address space	5
22	NOT ASSIGNED		
23	VOLUME OVERFLOW	Illegal block address after first block	5
24	BAD ARGUMENT	Reserved bit not zero or invalid parameter	5
25	INVALID LOGICAL UNIT NUMBER	Logical Unit greater than 3 addressed	5
26	NOT ASSIGNED		
27	WRITE PROTECT	Drive has write protect option active	7
28	CARTRIDGE CHANGED	A disk drive cartridge was installed since the last time a command was executed. A drive once found ready was found not ready, then ready again.	6
29	MEDIA ERROR	An invalid disk format was detected	3
2B	SET LIMIT VIOLATION	Read, Write, or Set Limit attempted in violation of previously linked Set Limit Command	7
2C	ERROR COUNT OVERFLOW	Posted when error count exceeds specified threshold	4
2D	SCSI HA/INITIATOR DETECTED ERROR	A message '05' _H (Initiator Detected Error) was received from the host	4
2E	SCSI BUS OUT PARITY CHECK	A parity check was detected on SCSI bus out-bound information transfer.	4
2F	ADAPTER PARITY CHECK	The ACB-5580 detected an internal hardware check.	4

6.3.1 BAD FORMAT ON DRIVE

The '1C' error code provides further information in the low order 3 bytes of address information, even though the address valid bit is not set.

Adaptec Sense Byte	Extended Sense Byte	Meaning
1	4	Progress code
2	5	Sectors read before failure occurred.
3	6	Error code detected at time error was found and progress code set.

The progress code indicates when the failure occurred, as described below:

Progress Code	Probable Failure
10	Rezero failure. Typically the drive is not ready.
11	Index/Sector Detect and First Read. The drive is incorrectly cabled, unable to read, or the ACB-5580 has an internal failure. The drive may not be formatted.
12	Drive Parameter Read Failure. The drive media has failed or drive operation is marginal. The previous format may be incomplete.
13	Wrong Block Size/Invalid Data. The drive parameters read from the disk are not valid. The disk may not have been formatted by an Adaptec controller.
14	Seek to Last Track Failed. The drive cannot seek or fails during seeks. The drive may be formatted with the wrong number of cylinders.
15	Unable to Read Last Flag Byte. The drive is failing to read on inside tracks. The format operation may have been halted before drive formatting was completed.
16	Failure to Read Defect Information. The drive is unable to read certain tracks/heads.

For all progress codes, the error codes stored in byte 3/6 will be valid, although no block address information will be available. The device error status information will be valid for extended sense formats.

Table 6-6. Table of Sense Keys for 5580

(Extended Sense Only)

<u>Sense Key</u>	<u>Description</u>
0 _H	NO SENSE. Indicates that there is no specific Sense Key information to be reported. This would be the case for a successful command or where sense information was previously recovered or reset.
1 _H	RESERVED. Not implemented by ACB-5580.
2 _H	NOT READY. Indicates that the Logical Unit addressed cannot be accessed. Operator intervention may be required to correct this condition.
3 _H	MEDIUM ERROR. Indicates that the command terminated with a non-recovered error condition which was probably caused by a flaw in the medium or an error in the recorded data.
4 _H	HARDWARE ERROR. Indicates that the Target detected a non-recoverable hardware failure (for example, controller failure, device failure, parity error, etc.) while performing the command or during a self test.
5 _H	ILLEGAL REQUEST. Indicates that there was an illegal parameter in the Command Descriptor Block or in the additional parameters supplied as data for some commands (Format Unit, Search Data, etc.).
6 _H	UNIT ATTENTION. Indicates that the removable medium may have been changed or the Target has been reset (by BUS DEVICE RESET message or "Hard" Reset Condition) since the last command was issued to the Logical Unit. This Sense Key is reported the first time that any command is issued after the condition is detected. The requested command will not be performed. The UNIT ATTENTION Sense Key will be reported to all Initiators which subsequently issue a command to the Logical Unit. This Sense Key is cleared for the next command from the same Initiator.
7 _H	DATA PROTECT. Indicates that a command which reads or writes the medium was attempted on a block that is protected from this operation. The read or write operation is not performed.
C _H	EQUAL. Indicates a Search Data command has satisfied an equal comparison.

Table 6-6. Sense Keys for ACB-5580
(Continued)

<u>Sense Key</u>	<u>Description</u>
8 _H -D _H	RESERVED. Not implemented by ACB-5580.
E _H	MISCOMPARE. Indicates that the source data did not match the data read from the medium
F _H	RESERVED. Not implemented by ACB-5580.

6.4 FORMAT UNIT (04_H)

BYTE	BIT							
	07	06	05	04	03	02	01	00
00	0	0	0	0	0	1	0	0
01	Logical Unit Number			Data	Cmplt	List Format Bits		
02	Data Pattern							
03	(MSB)			Interleave				
04				Interleave				(LSB)
05	Reserved (0)					Flag	Link	

Figure 6-6. FORMAT UNIT Command

The control unit will write from index to index all ID and DATA fields with the format specified by an immediately previous MODE SELECT (15_H) command. If no MODE SELECT (15_H) command has been executed, the previous format will be used. On unformatted disks or those whose format cannot be determined (sense byte error code 1C_H returned following a READ), a MODE SELECT (15_H) command is required prior to the format command. Data fields are completely written with 6C_H unless otherwise specified in the format command.

Byte 01 is used to indicate if a list of defect locations is appended and whether unique fill characters are to be used.

Bits 4 through 0 indicate the format of the defect list, if any. The ACB-5580 supports the following bit values:

<u>Bit</u>	<u>Defect List</u>	<u>Fill Byte</u>
4 3 2 1 0		
0 0 0 0 0	No defect list	6C _H
0 0 0 1 0	No defect list	Value in Byte 02
1 1 1 0 0	Complete defect list in bytes from index format	6C _H
1 1 1 1 0	Complete defect list in bytes from index format	Value in Byte 02

Sector interleaving may be required because performance limitations in the host may not allow it to accept large blocks of data at the full SMD disk data rate. The sector interleave number is equivalent to the number of disk revolutions required to read or write a full track of data.

The ID fields will be interleaved as specified in bytes 3 and 4 of the CDB. The ACB-5580 controller does not require interleaving because of a high speed buffer control. An interleave number of 1 results in sequential ID fields being written on the disk. Any interleave number between 1 and the number of sectors per track results in interleaved formatting. A 0 in this field will cause the default interleave factor of 1 to be used. Byte 3 must always be zero. The value in byte 4 must not exceed the number of sectors per track minus one. An error code of 24_H (Bad Argument) will be returned if either of these rules are violated.

An example of an interleave number of 3 with 32 sectors per track follows:

```

P - 00 01 02 03 04 05 06 07 08 09 10 11 12 13 14 15 16
F - 00 23 12 01 24 13 02 25 14 03 26 15 04 27 16 05 28

- 17 18 19 20 21 22 23 24 25 26 27 28 29 30 31 32 33
- 17 06 29 18 07 30 19 08 31 20 09 32 21 10 33 22 11

```

P = Physical sector count

F = Formatted sector locations (with interleave of 3)

The first logical cylinder is written one sector further from index for each subsequent head of a cylinder to allow track switching without loss of a revolution.

If data errors are noted by the controller while reading the defect list, all formatting is stopped and a Bad Argument error (24_H) is returned to the host.

Valid Errors

<u>Error</u>	<u>Error Code (hex)</u>
All Class 0 Errors	00-05
Unformatted or Bad Format	1C
Bad Argument	24
Write Protect	27
Cartridge Changed	28
SCSI Initiator Detected Error	2D
SCSI Bus Out Parity Check	2E
Adapter Parity Check	2F

6.4.1. DEFECT HANDLING

The ACB-5580 handles disk defects on a sector level. Instead of assigning alternate tracks for those tracks which contain defects at the cost of performance and capacity, the ACB-5580 deletes only the sector which contains a disk defect. All subsequent logical sectors are then shifted down by one physical position. See Figure 6-7.

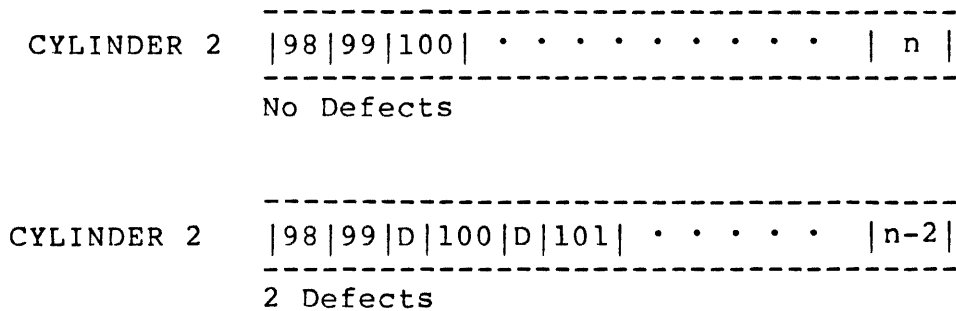

Figure 6-7. Sector Level Defect Skipping

To facilitate system applications where a consistent number of sectors are required per cylinder and to allow reformatting of single cylinders when required by field grown defects, the ACB-5580 allows a specified number of sectors per cylinder to be spared during formatting. The number of spare sectors allocated to each cylinder is variable from 0 to 255 and is specified in the FORMAT UNIT format information. For every spare sector allocated, one less sector will be available on each cylinder. To assure defects within a cylinder do not cause sectors to be shifted into the next cylinders, a number of spare sectors greater than the expected number of defects per cylinder should be chosen. Figure 6-8 shows the effect of sector sparing.

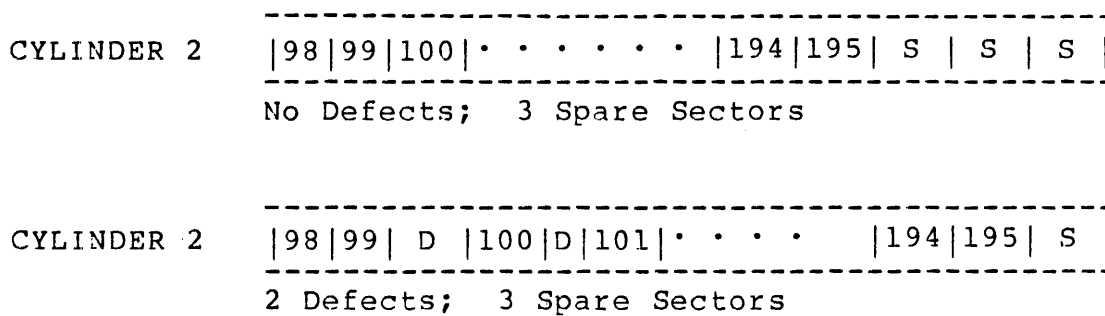

Figure 6-8. Sector Spacing within Cylinders

If the number of defects within a cylinder should exceed the number of spare sectors, the additional sectors will overflow into the next cylinder. Assuming the next cylinder has enough spare sectors to account for defects within the cylinder and the overflow sectors, no other cylinders will be affected. This cylinder will now contain all of its assigned sectors plus the overflow. Figure 6-9 describes the effects of overflow sectors.

```

-----
CYLINDER 2 | 98 | D | D |100| D | 101 | ... |192|193|194|
-----
4 Defects; 3 Spares

-----
CYLINDER 3 |(195)|196| D |197| ..... |292|293| S |
-----
1 Defect; 3 Spares; 1 (Overflow)

```

Note: In this example cylinder 2 now contains 97 sectors and Cylinder 3 contains 99, the remaining cylinders on the disk contain 98.

Figure 6-9. Sector Sparing and Overflow Sectors

In the case of formatting out a grown defect(s) within a cylinder with no available spares, all subsequent cylinders must be reformatted until an adequate number of spares are available to account for all overflowing sectors.

Two format options exist, one using the standard SCSI defect list for formatting an entire disk drive, the other using an Adaptec defect list for reformatting a single cylinder.

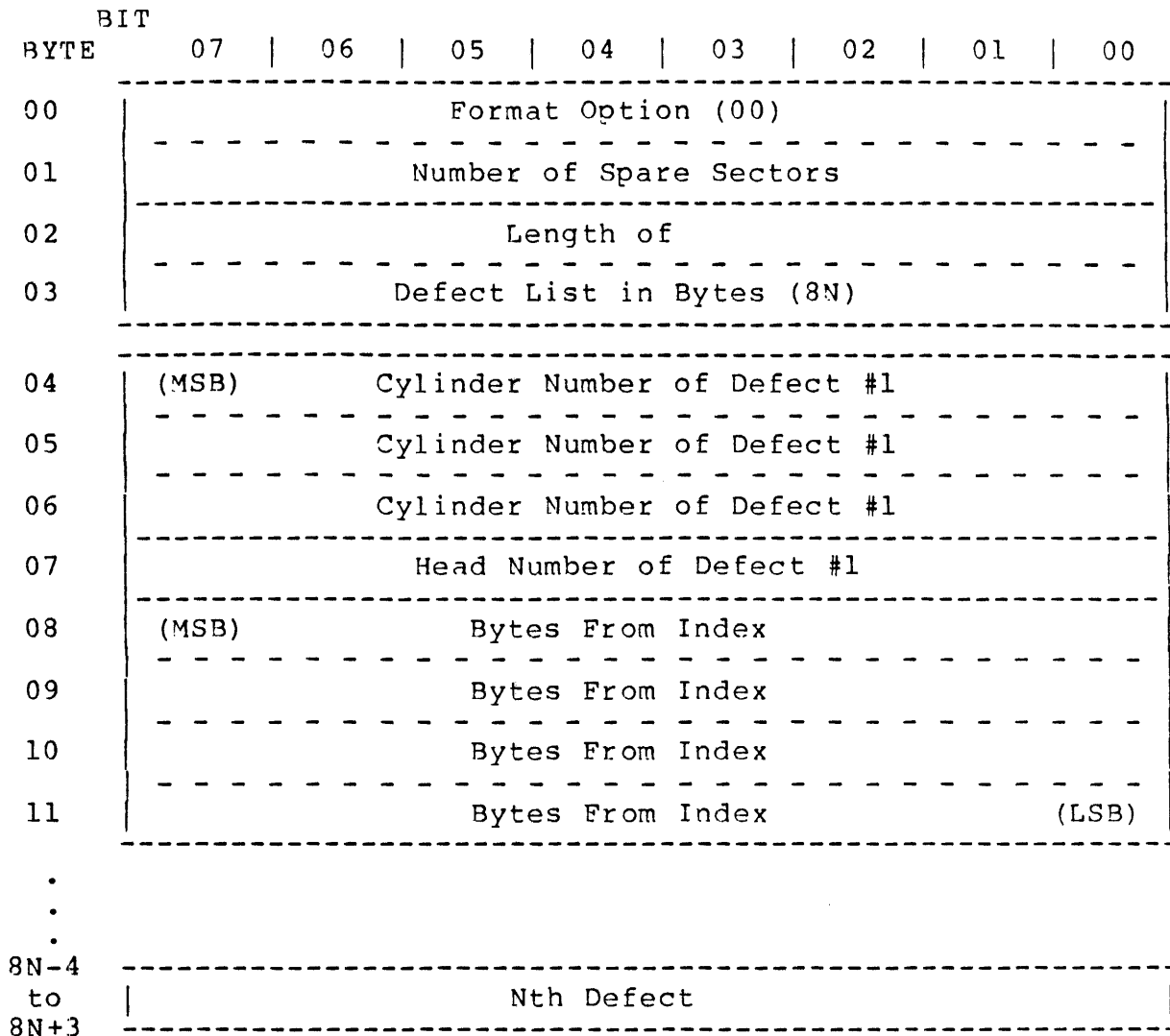

Figure 6-10. Format Unit Data Block (Drive Formatting)

Byte 00 indicates the formatting option for the drive. 00 indicates the entire unit is to be formatted; 01 indicates only the specified cylinder is to be formatted.

Byte 01 indicates the number of spare sectors to be allocated per cylinder. The number of spare sectors allocated must be the same for every cylinder for single cylinder formatting. A 00 in this byte will result in no spare sectors.

If no spare sectors are allocated, the defective sector pushdown algorithm limits the number of defects to 128. If bytes 2 and 3 specify more than 128 8-byte descriptors, a Bad Argument (24_H) error will be posted. If one or more spare sectors are allocated, a number of sectors, up the total number of spares, may be marked as defective. The number of spare sectors allocated on a cylinder must be less than the number of sectors on a single track of the cylinder.

Bytes 02 and 03 indicate the number of following data bytes containing defect descriptors and/or format information.

For entire unit formatting, bytes 04 through 11 indicate the physical location of the first defect descriptor (defect location in terms of cylinder, head and bytes from index). The defect descriptors must be listed in ascending order starting from cylinder 0, head 0.

For single cylinder formatting, bytes 04 through 11 indicate the cylinder to be formatted and the starting sector number of the cylinder. The starting sector number can be determined using the READ MAXIMUM CAPACITY (25_H) command.

BYTE	BIT							
	07	06	05	04	03	02	01	00
00	Format Option (01)							
01	Number of Spare Sectors							
02	Length of Appended							
03	Data in Byte							
04	(MSB) Cylinder Number							
05	To Be							
06	Formatted (LSB)							
07	00							
08	(MSB)							
09	Starting							
10	Sector Number							
11	(LSB)							
12	First							
:	Defect							
:	Descriptor							
19								

Figure 6-11. Format Unit Data Block
(Cylinder Level Formatting)

6.5 READ (08_H)

BYTE	7	6	5	4	3	2	1	0
00	0	0	0	0	1	0	0	0
01	Logical Unit Number (MSB)			Logical Block Address				
02	Logical Block Address							
03	Logical Block Address						(LSB)	
04	Number of Blocks							
05	Reserved (0)				Flag		Link	

Figure 6-12. READ Command

This command transfers from the ACB-5580 the specified number of blocks starting at the specified logical starting block address of the selected SMD drive.

The control unit will verify a valid seek address and proceed to seek to the specified starting logical block address. If disconnection is allowed, the ACB-5580 will disconnect during seek actuator motion and will reconnect when the device is again ready to transfer data. When the seek is complete the controller then reads the data field into the buffer, checks ECC and begins first data transfer to the Initiator.

Subsequent blocks of data are transferred into the buffer in a similar manner until the block count is decremented to zero. Cylinder switching is transparent to the user. On a data ECC error, the block is re-read up to 5 times to establish a solid error syndrome. Only then is correction attempted. Correction is done directly into the data buffer, transparent to the host.

Blocks containing uncorrectable data errors will be transferred to the host prior to an ending check status. A REQUEST sense will return an uncorrectable data error (11_H) error code.

Valid Errors:

<u>Error</u>	<u>Error Code</u>	<u>Valid Address</u>
All Class 0 Errors	00-05	
I.D. CRC Error	10	yes
Uncorrectable Data Error	11	yes
I.D. AM Not Found	12	yes
Data AM Not Found	13	yes
Record Not Found	14	yes
Seek Error	15	yes
Data Check (No Retry Mode)	18	yes
Bad Format	1C	
Illegal Block Address	21	
Volume Overflow	23	
Bad Argument	24	
Cartridge Changed	28	
Media Error	29	
Set Limit Violation	2B	
SCSI HA Detected Error	2D	
SCSI Bus Out Parity Check	2E	
Adapter Parity Check	2F	

This set of errors is collectively referred to as Read Operation Errors.

6.6 WRITE (0A_H)

BYTE	BIT							
	7	6	5	4	3	2	1	0
00	0	0	0	0	1	0	1	0
01	Logical Unit Number (MSB)				Logical Block Address			
02	Logical Block Address							
03	Logical Block Address							(LSB)
04	Number of Blocks							
05	Reserved (0)					Flag	Link	

Figure 6-13. WRITE Command

This command transfers to the selected SMD drive on the ACB-5580 the required number of blocks starting at the specified logical block address. The controller seeks to the specified logical starting block. If disconnection is allowed, the ACB-5580 will disconnect during seek actuator motion and will reconnect when the device is again ready to transfer data. When the seek is complete, the controller transfers the first block into its buffer and writes the buffered data and its associated ECC into the first logical sector.

Subsequent blocks of data are transferred until the block count is decremented to zero. Cylinder switching and defect skipping are transparent to the user.

Valid Errors:

<u>Error</u>	<u>Error Code</u>	<u>Valid Address</u>
All Class 0 Errors	00-04	
I.D. CRC Error	10	yes
I.D. AM Not Found	12	yes
Record Not Found	14	yes
Seek Error	15	yes
Bad Format	1C	
Illegal Block Address	21	
Volume Overflow	23	
Bad Argument	24	
Write Protected	27	
Cartridge Changed	28	
Media Error	29	
Set Limit Violation	2B	
SCSI HA Detected Error	2D	
SCSI Bus Out Parity Check	2E	
Adapter Parity Check	2F	

This set of errors is collectively referred to as Write Operation Errors.

6.7 SEEK (0B_H)

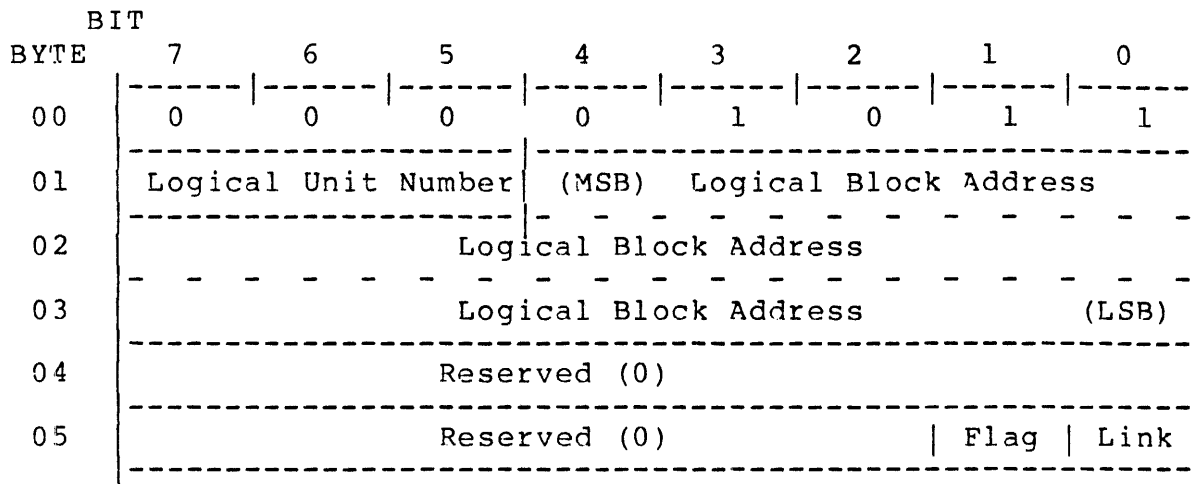

Figure 6-14. SEEK Command

This command causes the selected drive to seek to the specified starting address. The ACB-5580 returns completion status immediately after the seek pulses are issued and head motion starts, allowing it to free the bus and accept further commands prior to actual seek completion. Any command received for a unit with a seek in progress will immediately complete with a command completion status of busy (bit 3 set).

The actuator is moved to the expected track position but no ID field verification is attempted.

The ACB-5580 uses an implied seek on READ, WRITE and SEARCH commands eliminating the need for SEEK commands before each operation. No extended seek command is implemented. The seek command allows partial imitation of the disconnection function for Initiators that don't permit disconnection.

Valid Errors:

<u>Error</u>	<u>Error Code</u>
No Seek Complete	02 _H
Drive Not Ready	04 _H
Select Failure	05 _H
Bad Format	1C _H
Illegal Block Address	21 _H
Bad Argument	24 _H
Invalid Logic Number	25 _H
Initiator Detected Error	2D _H
SCSI Bus Out Parity Error	2E _H
Adapter Parity Check	2F _H

6.8 TRANSLATE (0F_H)

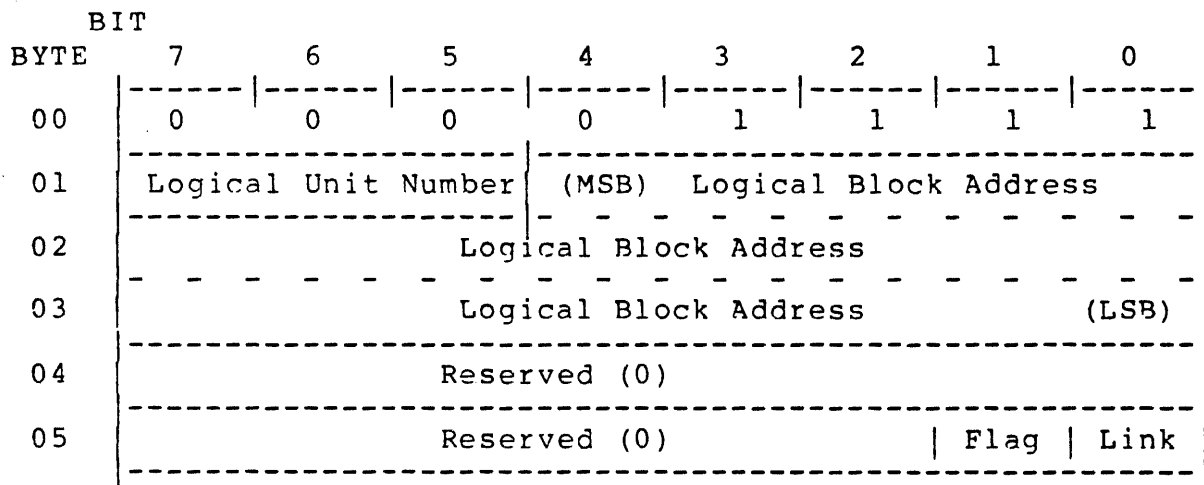

Figure 6-15. TRANSLATE Command

This command performs a logical address to physical address translation and returns the physical location of the requested block address in a cylinder, head, bytes from index format. This data can be used to build a defect list for the FORMAT command.

Eight bytes are returned in the format of defect descriptors required by FORMAT.

If there is a data error in the ID field, an error status will be returned. It is then necessary to TRANSLATE the blocks before and after the targeted block to determine the location of the target block.

BYTE	BIT	
00	(MSB)	Cylinder Number
01		Cylinder Number
02		Cylinder Number (LSB)
03		Head Number
04	(MSB)	Bytes From Index
05		Bytes From Index
06		Bytes From Index
07		Bytes From Index (LSB)

Figure 6-16. TRANSLATE Data

Valid Errors:

<u>Errors</u>	<u>Error Code</u>
All Class 0 Errors	00-05
I.D. CRC Error	10
I.D. AM Not Found	12
Record Not Found	14
Seek Error	15
Bad Format	1C
Illegal Block Address	21
Bad Argument	24
Cartridge Changed	28
SCSI HA/Initiator Detected Error	2D
SCSI Bus Out Parity Error	2E
Adapter Parity Check	2F

6.9 SET THRESHOLD (10_H)

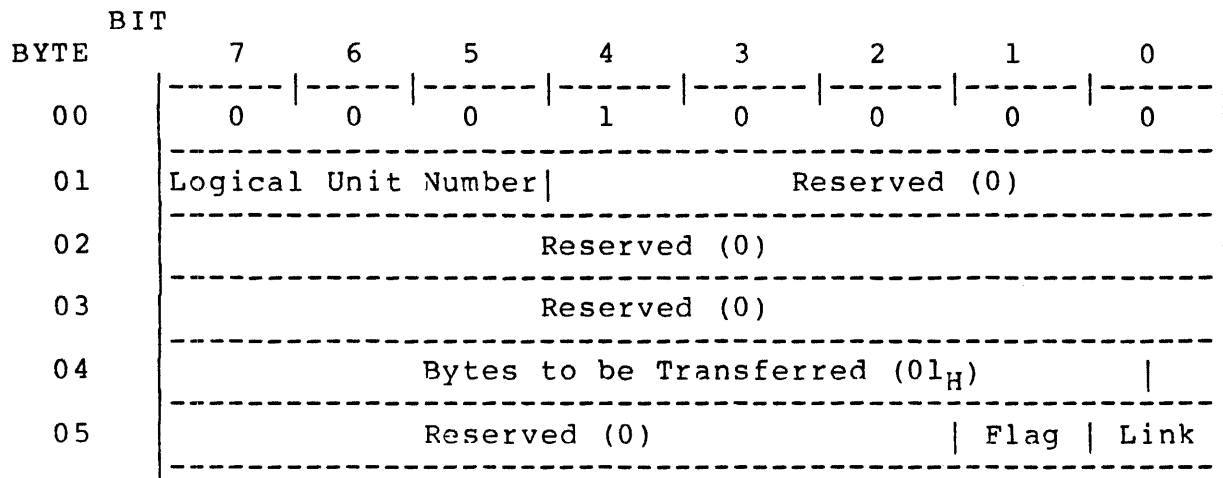
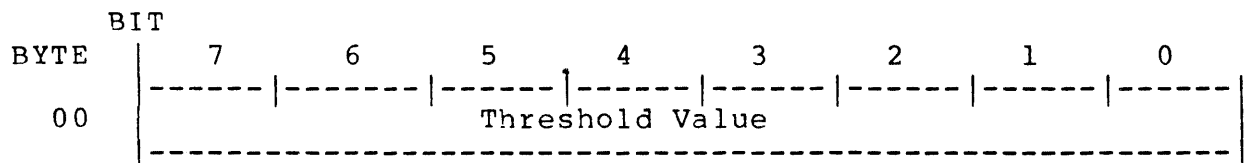

Figure 6-17. SET THRESHOLD Command

The ACB-5580 optionally provides an error logging capability for those errors that are normally retried without any notification to the host system. When set in a logging mode, the ACB-5580 counts blocks transferred, seek errors, and retried and corrected data errors. The error logging mode and the frequency of error presentation is established by the SET THRESHOLD command, while the actual error information is presented by the READ/RESET USAGE COUNTERS command. The default state is error logging not active. Power on reset establishes the default state.

One byte of parameter data will be transferred.



A threshold value of 0 specifies that no error logging will take place. A value between 1 and 255 will request that error logging takes place. When the number of errors of any single type exceeds the threshold, the command that finds that error is completed normally. All subsequent commands will be terminated immediately with Check Condition. Sense status will indicate 2C_H, Error Count Overflow. When a READ/RESET USAGE COUNTER command is executed, the usage and error counters are off loaded and normal operation continues. The same threshold value remains in effect.

Valid Errors:

<u>Error</u>	<u>Error Code</u>
Bad Argument	24 _H
Cartridge Changed	28 _H
Initiator Detected Error	2D _H
SCSI Bus Out Parity Error	2E _H
Adapter Parity Check	2F _H

6.10 READ/RESET USAGE COUNTER (11_H)

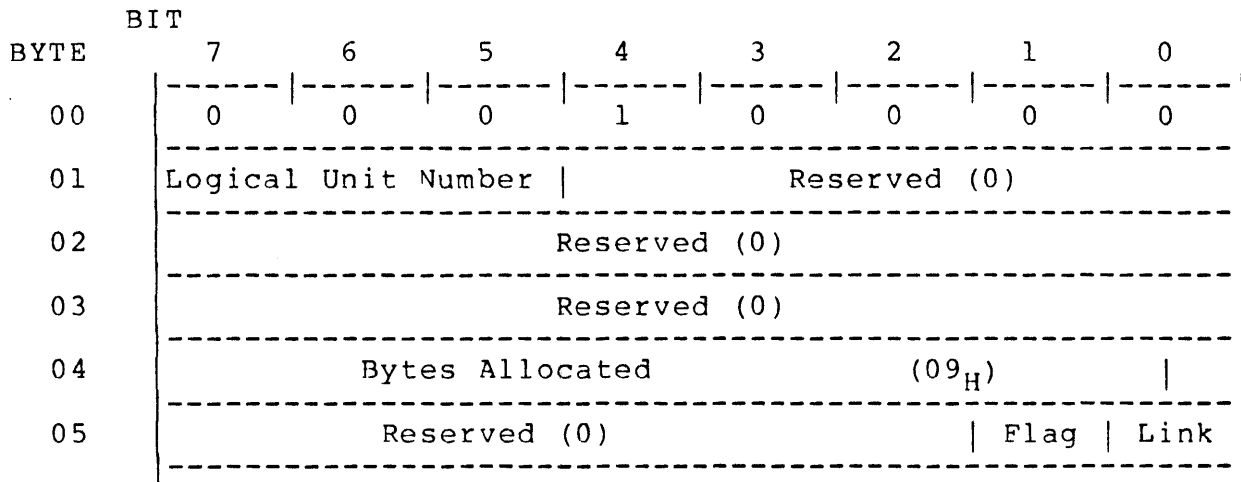

Figure 6-18. READ/RESET USAGE COUNTER Command

The READ/RESET USAGE COUNTERS command recovers the information stored by the ACB-5580 for the particular disk device. The information is valuable to observe the statistical performance of the device and to point to devices which may need service before their performance degrades system operation.

When the error logging mode is set by the appropriate SET THRESHOLD command, all seeks and sectors read are counted in three byte counters. Seek errors, correctable data errors, and uncorrectable data errors are counted in one byte counters. When one of the error counters exceeds the threshold, all subsequent commands for that device will terminate immediately with Check Condition status indicating an error code of 2C_H, Error Counter Overflow. This will continue until execution of the READ/RESET USAGE COUNTER command, which recovers the 9 bytes of counter information and resets the counters.

BYTE	BIT							
	7	6	5	4	3	2	1	0
00	(MSB)		Sectors Read Count					
01			Sectors Read Count					
02			Sectors Read Count				(LSB)	
03	(MSB)		Seek Usage Count					
04			Seek Usage Count					
05			Seek Usage Count				(LSB)	
06			Uncorrectable Data Check Count					
07			Correctable Data Check Count					
08			Seek Check Count					

Figure 6-19. Parameters Returned by READ/RESET USAGE COUNTER

The Sectors Read Count is a complete count of all logical blocks read to any host from the specified drive. This provides usage information against which error counts can be calibrated. The Seek Usage Count is a complete count of all occurrences of an initial seek by the drive. Cylinder switching is not counted. The Uncorrectable Data Check Count counts all occurrences of an uncorrectable data check on the specified device. Each Uncorrectable data check was also posted as a 11 error code.

The Correctable Data Check Count counts all occurrences of the successful recovery of a logical block that was unsuccessfully read at first. This information is available only through error logging, since these errors are recovered without notifying the host unless a diagnostic mode has been invoked.

The Seek Check Count counts all occurrences of a seek error whether or not recovery was successful. This information is available only from error logging, since seek errors are normally recovered without notifying the host.

6.11 INQUIRY (12_H)

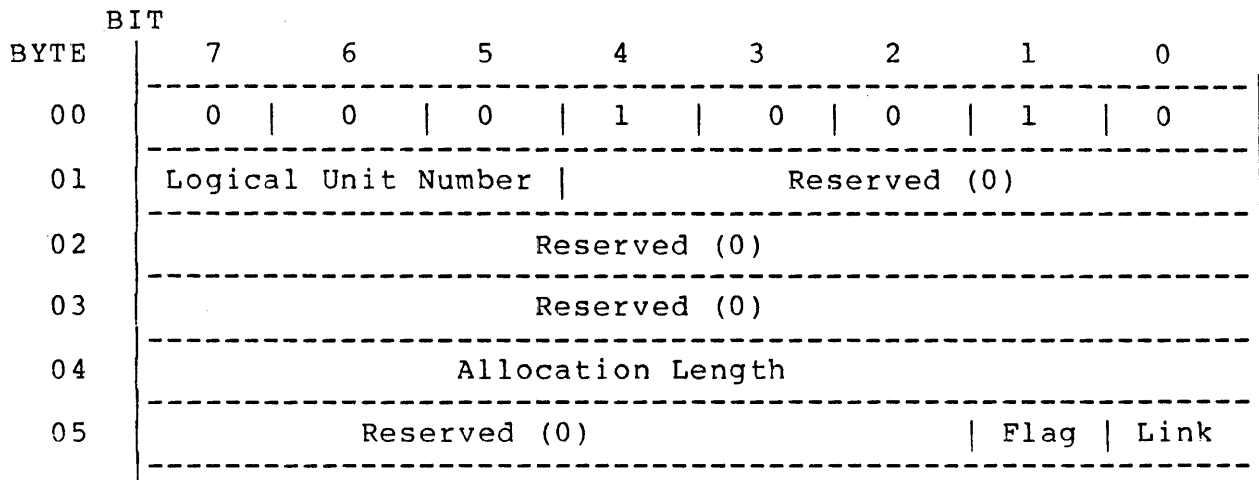

Figure 6-20. INQUIRY Command

The INQUIRY command requests parameters describing the ACB-5580 and attached devices.

The Allocation Length specifies the number of bytes that the Initiator has allocated for returning Inquiry Data. The ACB-5580 will return the Allocation Length number of bytes or 4 bytes, whichever is less. Zero is a valid Allocation Length and indicates no data may be transferred.

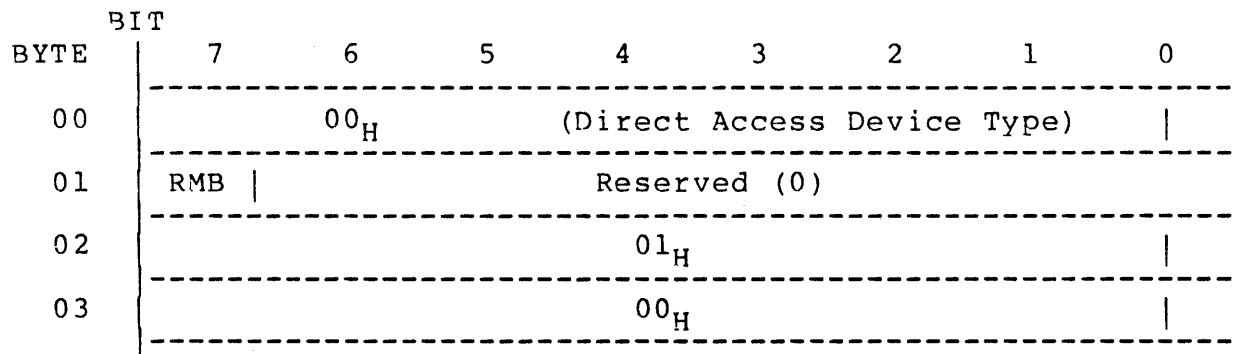

Figure 6.21. INQUIRY Command Parameter List

Byte 1 of the parameter list is zero, indicating that the attached devices are direct access disk devices with a read and write capability. The RMB bit will be zero, since no indicators exist on SMD devices to differentiate removable media and fixed

media devices. Removable media drive can be identified by the MODE SELECT and MODE SENSE commands. Byte 2 is 01_H, indicating that the ACB-5580 meets the SCSI specifications, version 14. The only significant exception is the definition of the FORMAT commands Format Cylinder Option and the FORMAT command's optional fill character. Byte 3 is 00_H, indicating that no other bytes are defined.

Valid Errors

<u>Error</u>	<u>Error Code</u>
Bad Format	1C
Bad Argument	24
Cartridge Changed	28
Initiator Detected Error	2D
SCSI Bus Out Parity Check	2E
Adapter Parity Check	2F

6.12 WRITE DATA BUFFER (13_H)

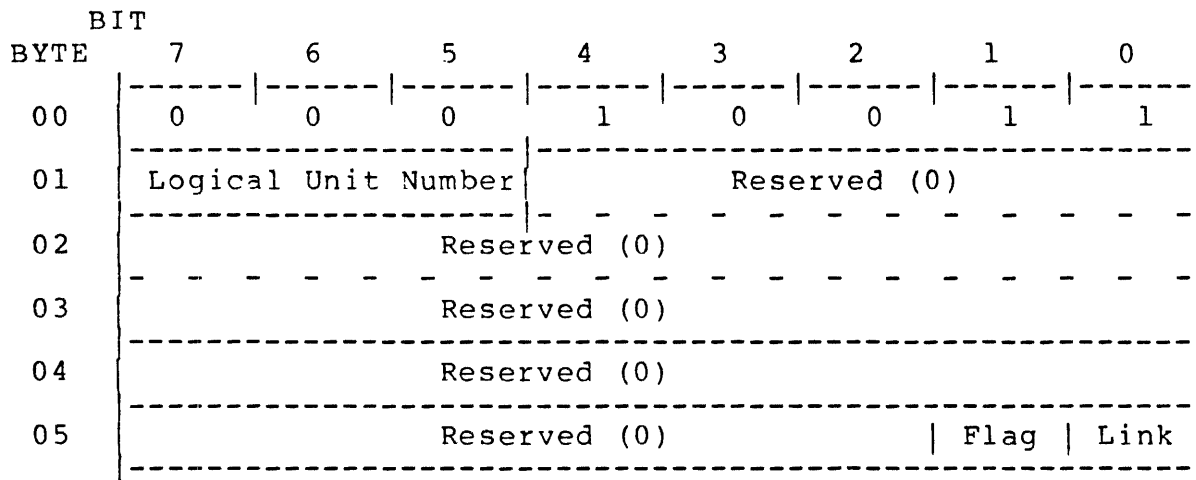

Figure 6-22. WRITE DATA BUFFER Command

This command serves buffer RAM diagnostic purposes. The controller will fill the buffer with 4K bytes of data from the host. There is no guarantee that this data will not be overwritten by other operations initiated by other Initiators.

Valid Errors:

<u>Error</u>	<u>Error Code</u>
Bad Argument	24
SCSI HA/Initiator Detected Error	2D
SCSI Bus Out Parity Check	2E
Adapter Parity Check	2F

6.13 READ DATA BUFFER (14_H)

BYTE	BIT							
	7	6	5	4	3	2	1	0
00	0	0	0	1	0	1	0	0
01	Logical Unit Number				Reserved (0)			
02	Reserved (0)							
03	Reserved (0)							
04	Reserved (0)							
05	Reserved (0)						Flag	Link

Figure 6-23. READ DATA BUFFER Command

READ DATA BUFFER will pass the host 4K of data from the buffer. It is intended for RAM diagnostic purposes. Although data remains in the buffer after normal data operations, the ordering of the data found there may vary.

Valid Errors:

<u>Error</u>	<u>Error Code</u>
Bad Argument	24
SCSI HA/Initiator Detector Error	2D
SCSI Bus Out Parity Check	2E
Adapter parity Check	2F

6.14 MODE SELECT (15_H)

BYTE	BIT							
	07	06	05	04	03	02	01	00
00	0	0	0	1	0	1	0	1
01	Logical Unit Number			Reserved				
02	-			Reserved (0)				
03	-			Reserved				
04	Number of Bytes							
05	Reserved					Flag Link		

Figure 6-24. MODE SELECT Command

This command is used by the ACB-5580 to specify formatting parameters and should always precede the FORMAT command. When a blown format error (code 1C) is detected due to the controller being unable to read the drive parameter information from a drive already formatted, the user may use this command to inform the controller about the drive information. Once initialized, most data on the drive may be recoverable. The information can then be recovered and the drive reformatted.

Byte 4 of the command specifies the number of information bytes to be passed with the command. The ACB-5580 will post an Invalid Argument error unless byte 4 is 26 bytes (1A_H).

The Mode Select parameters are architecturally divided by the SCSI document into a header (bytes 00-03), a block descriptor (bytes 04-0B), and vendor unique parameters. The following parameters are required by the ACB-5580.

BYTE	BIT							
	07	06	05	04	03	02	01	00
00					Reserved			
01	-	-	-	-	Reserved	-	-	-
02					Reserved			
03	Length of Extent Descriptor List = 08 _H							
04	Density Code							
05					Reserved			
06	-	-	-	-	Reserved	-	-	-
07	-	-	-	-	Reserved	-	-	-
08	-	-	-	-	Reserved	-	-	-
09	(MSB)				Block Size			
0A	-	-	-	-	Block Size	-	-	-
0B	-	-	-	-	Block Size	-	-	(LSB)
0C	List Format Code == 02							
0D	MSB				Cylinder Count			
0E	-	-	-	-	Cylinder Count	-	-	LSB
0F	Data Head Count							

Figure 6-25. Driver Parameter List
(Continued on next page)

(Figure 6-25 continued)

10	Reserved (0)
11	Reserved (0)
12	Reserved (0)
13	Reserved (0)
14	Reserved (0)
15	Reserved (0)
16	Drive Type Code
17	Sector Count
18	Physical Sector Length
19	Physical Sector Length

Figure 6-25. Drive Parameter List

Byte 04, the Density Code, uses the default value of 00_H, since SMD devices do not expose any density parameters to the operating system.

Bytes 09 through 0B specify the data block size. The ACB-5580 supports block sizes of 256 bytes, 512 bytes, and 1024 bytes. Note that the SMD drives usually require hardware set up to establish the correct hard sector block size. The following table indicates the minimum SMD block size to set for each block size. The correct sector length is the lowest value for which the smallest SMD sector is no smaller than the minimum value.

Block Size	Min. SMD Sector Length
256	320
512	576
1024	1088

The List Format Code must be 02_H.

The Cylinder Count is the number of data cylinders on the drive. The ACB-5580 defect skipping algorithms allows cylinders normally set aside as spares to be included in this total. The minimum is one. The maximum supported is 65535.

The Data Head Count is the number of usable data surfaces. The heads will be selected from 0 to head count minus 1. The minimum is 1; maximum is 16.

The Drive Type code is 04_H if the media is removable and 0C_H if the media is fixed. All SMD drives are treated as hard sector drives.

The sector count is the number of sectors of the specified block lengths which fit on the particular SMD drive.

The physical sector length is the number of bytes in each sector as set in the SMD drive sector switches. This value is used to correctly calculate the location of defects for the format command and translate command.

Valid Errors

<u>Error</u>	<u>Error Code</u>
Bad Argument	24
Cartridge Changed	28
SCSI/HA Initiator Detected Error	2D
SCSI Bus Out Parity Check	2E
Adapter Parity Check	2F

6.15 RESERVE (16_H)

BYTE	BIT							
	7	6	5	4	3	2	1	0
00	0	0	0	1	0	1	1	0
01	Logical Unit Number			Reserved (0)				Extent
02	Reservation Identification							
03	Extent List Length (MSB)							
04	Extent List Length (LSB)							
05	Reserved (0)						Flag	Link

Figure 6-26. RESERVE Command

This command is used to reserve logical units or extents within units for the use of an Initiator.

The Reservation function is used to prohibit certain kinds of access from some initiators so that the reserving initiator can complete multi-step transactions with the interference. The dual port function is also a form of reservation. Since no SMD drives have the dual port parameter areas required for extent level reservation, dual port drives can only perform unit reservations. Drives are also implicitly reserved to the active initiator during an active chain of linked commands.

Reserve Unit:

If the Extent bit (Bit 0 of Byte 01) is zero, and no extent within the unit is currently reserved by another Initiator, then this command shall cause the unit to be reserved for exclusive use of the Initiator until the reservation is released by a RELEASE UNIT command issued by the same Initiator or by a BUS DEVICE RESET message from any Initiator or a "Hard" RESET condition. It is permissible for an Initiator to reserve a logical unit that is currently reserved for that Initiator. The Reservation Identification (Byte 02) and the Extent List Length (Bytes 03 through 04) are ignored. If the unit or any extent within the unit is previously reserved, then the unit shall respond by a RESERVATION CONFLICT Status indication.

If any other Initiator then subsequently attempts to perform a READ or WRITE operation on the reserved unit, that command shall be rejected with RESERVATION CONFLICT Status. If a REQUEST SENSE command is executed, a No Sense error code will be presented.

Extent Reservation Option:

The Reservation Identification (Byte 02) provides a means for an Initiator to identify each Extent Reservation. This allows an Initiator in a multi-tasking environment to have multiple reservations outstanding. The Reservation Identification is used in the RELEASE command to specify which reservation is to be released.

Extents within a unit may be reserved, each with a separate Reservation Type. If the reservation cannot be granted because of conflicts with a previous reservation or because the unit is a dual port device, then a RESERVATION CONFLICT status indication is posted. Reservations are only active when all extents are free from conflict with active reservations.

If the extent bit is one, then:

- (1) The Extent List is checked for number of extents in the reservation request. The ACB-5580 supports only one extent. If the Extent List contains more than one extent, then the command shall be rejected with CHECK CONDITION Status and an error code of Bad Request (24_H).
- (2) The Extent List shall be checked for valid extent block addresses. If any address is invalid for this unit, then the command is rejected with the CHECK CONDITION Status and a Sense Key of Illegal Block Request (21).
- (3) If there already is an active unit reservation for the unit, the command shall be rejected with CHECK CONDITION Status and a Sense Key of ILLEGAL REQUEST.
- (4) If the requested reservation does not conflict with any active reservation, then the extent specified is reserved until release by a RELEASE command from this Initiator or by a BUS DEVICE RESET message from any Initiator or a "Hard" RESET condition. The occurrence of the last two conditions is indicated by a Sense Key of UNIT ATTENTION on the next operation following the condition if the extended sense option is selected.

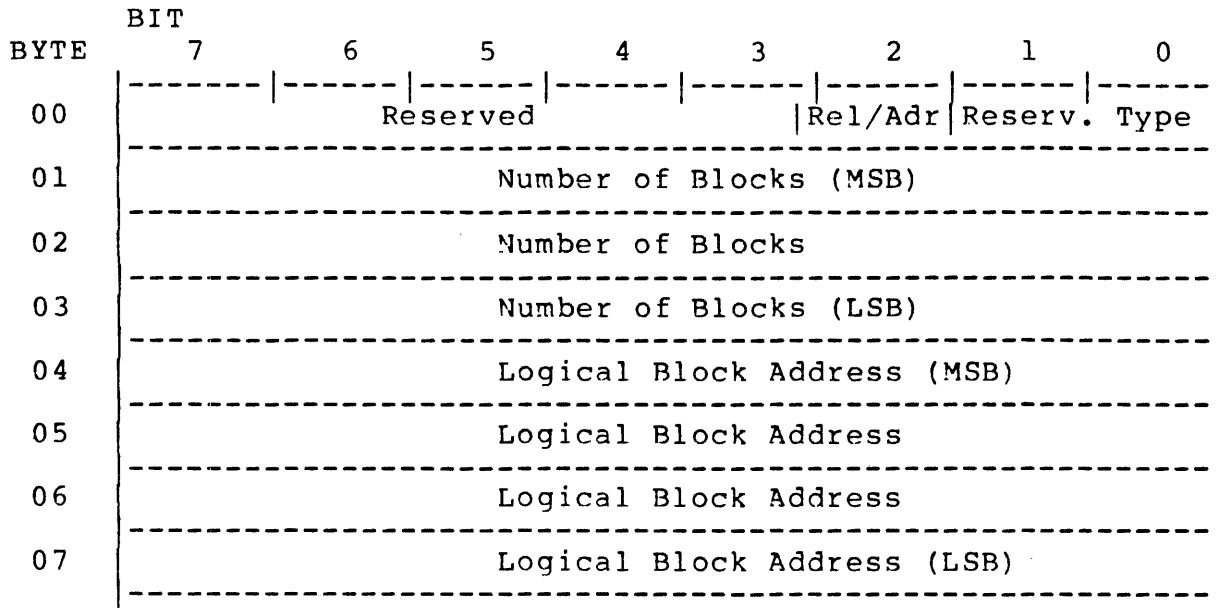

Figure 6-27. RESERVE Command
Extent Descriptor Format

The size of the Extent List is defined by the Extent List Length parameter in the CDB. The ACB-5580 requires the length to be 8 or 0. The Extent Descriptor defines an extent beginning at the specified Logical Block Address (Bytes 04 through 07) for the specified Number of Blocks (Bytes 01 through 03). If the Number of Blocks is zero, the extent shall begin at the specified Logical Block Address and continue through the last Logical Block Address on the unit.

The Reservation Type field (Bits 1 through 0 of Byte 00) determines the type of reservation to be effected for each extent. Four types of reservations are possible as follows:

Code	Reservation Type
10	Read Exclusive
01	Write Exclusive
11	Exclusive Access
00	Read Shared.

Read Exclusive--While this reservation is active, no other Initiator shall be permitted READ access to the indicated extent. This reservation shall not inhibit WRITE accesses from any Initiator or conflict with a Write Exclusive reservation; however, Read Exclusive, Exclusive Access, and Read Shared reservations which overlap this extent shall conflict with this reservation.

Write Exclusive--While this reservation is active, no other Initiator shall be permitted WRITE access to the extent. This reservation shall not inhibit READ accesses from an Initiator or conflict with a Read Exclusive reservation from any Initiator. This reservation shall conflict with Write Exclusive, Exclusive Access, and Read Shared reservations which overlap this extent.

Exclusive Access--While this reservation is active, no other Initiator shall be permitted any access to the indicated extent. All Reservation Types which overlap this extent shall conflict with this reservation.

Read Shared--While this reservation is active, no WRITE accesses shall be permitted by any Initiator to the indicated extent. This reservation shall not inhibit READ accesses from any Initiator or conflict with a Read Shared reservation. Read Exclusive, Write Exclusive, and Exclusive Access reservations which overlap with this extent shall conflict with this reservation.

If the RELATIVE ADDRESS bit (Bit 2 of Byte 00) is one, the Logical Block Address shall be treated as a two's complement displacement. This displacement shall be added to the Block Address last accessed on the unit to form the Block Address for this extent. This feature is only available when linking commands and requires that a previous command in the linked group has accessed a block of data on the unit; if not, the RESERVE Command shall be rejected with CHECK CONDITION Status and an error code of Bad Argument (24_H).

If an Initiator attempts to access (READ or WRITE) a block which has been reserved and that access is prohibited by the reservation, then the operation is not performed and terminates with RESERVATION CONFLICT Status. If any access conflict exists, none of the operation shall be performed. If any extent in a unit is reserved in any way, a FORMAT UNIT Command is rejected with RESERVATION CONFLICT Status.

Note that RESERVE commands, whether for a unit or for an extent, are not queued. Host software is responsible for queuing reserve functions, since careful management of host software is required to detect and circumvent potential deadlocks. In multi-host systems, deadlock prevention may require an auxiliary communication path or very restrictive programming conventions.

Host software is responsible for monitoring and clearing reservations generated by attached hosts that have failed with reservations outstanding. This may require an auxiliary communications path. The reservations for failing hosts may be cleared using the BUS DEVICE RESET message. Note that non-failing hosts must be aware of and provide permission for execution of a BUS DEVICE RESET since reservations on their behalf will also be destroyed.

Valid Errors:

<u>Error</u>	<u>Error Code</u>
Illegal Block Address	21
Bad Argument	24
Cartridge Changed	28
SCSI HA/Initiator Detected Error	2D
SCSI Bus Out Parity Check	2E
Adapter Parity Check	2F

6.16 RELEASE (17_H)

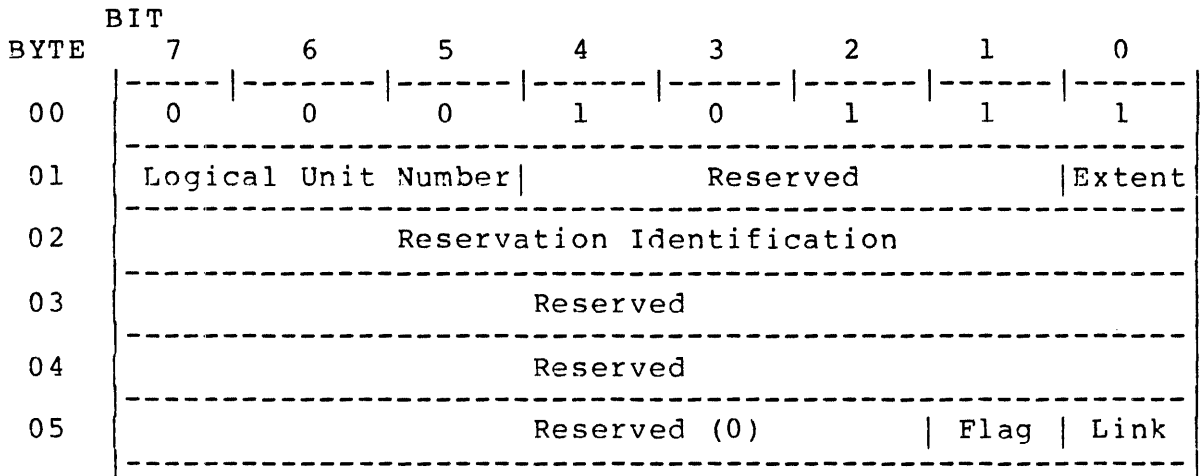

Figure 6-28. RELEASE Command

This command is used to release previously Reserved devices or previously reserved extents within units.

If the Extent bit (Bit 0 of Byte 01) is zero, this command causes the unit to terminate any active reservation from that Initiator. If the Extent bit is one, this command causes any reservation from the requesting Initiator with a matching Reservation Identification (Byte 02) to be terminated. Other reservations from the requesting Initiator shall remain in effect. It is not an error for an Initiator to attempt to release a reservation which is not currently active.

Valid Errors:

<u>Error</u>	<u>Error Code</u>
Bad Argument	24
Cartridge Changed	28
SCSI HA/Initiator Detected Error	2D
SCSI Bus Out Parity Check	2E
Adaptec Parity Check	2F

6.17 MODE SENSE (1A_H)

BYTE	BIT							
	07	06	05	04	03	02	01	00
00	0	0	0	1	1	0	1	0
01	Logical Unit Number				Reserved			
02	Reserved (0)				-			
03	Reserved				-			
04	Number of Bytes							
05	Reserved						Flag	Link

Figure 6-29. MODE SENSE Command

This command is used to interrogate the ACB-5580 device parameter table to determine the specific characteristics of any disk drive currently attached.

Byte 4 of the command specifies the number of data bytes allowed to be returned by the command. A maximum of 26 bytes or the allocated number of bytes, whichever is smaller, will be returned.

The returned information will be the four-byte Parameter List, the Extent Descriptor List and the Drive Parameter List (if requested). These lists take the exact format of the data in the MODE SELECT command, except that the first byte will be the expected data count of '1A'X.

The Mode Sense command information is only available if a previous Mode Select command was successfully executed or if the automatic initialization for the drive was successful. If the information is not available, an error status with IC (Bad Format) error code is presented.

Valid Errors:

<u>Error</u>	<u>Error Code</u>
Unformatted or Bad Format	1C
Bad Argument	24
Cartridge Changed	28
SCSI HA/Initiator Detected Error	2D
SCSI Bus Out Parity Check	2E
Adapter Parity Check	2F

6.18 START/STOP UNIT (1B_H)

BYTE	BIT							
	07	06	05	04	03	02	01	00
00	0	0	0	1	1	0	1	1
01	Logical Unit Number				Reserved (0)			
02	-				Reserved			
03	-				Reserved			
04	-				Reserved			
05	-				Reserved			
					Flag		Link	

Figure 6-30. START/STOP UNIT Command

This command performs no operation on an SMD drive.

Valid Errors

<u>Error</u>	<u>Error Code</u>
Bad Argument	24
Cartridge Changed	28
SCSI HA/Initiator Detached Error	23
SCSI But Out Parity Check	2E
Adapter Parity Check	2F

6.19 RECEIVE DIAGNOSTIC (1C_H)

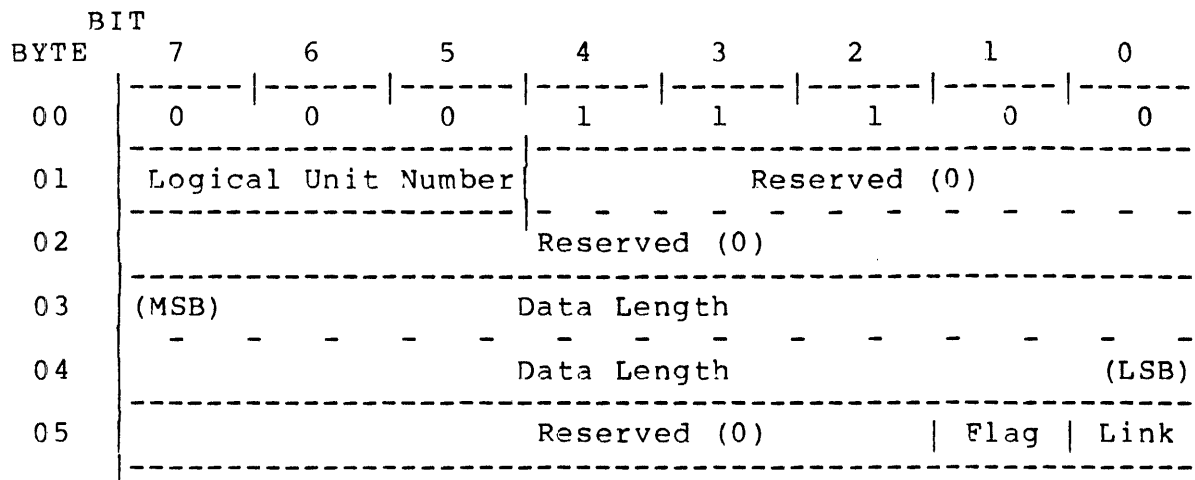

Figure 6-31. RECEIVE DIAGNOSTIC Command

This command sends analysis data to the Host after completion of a SEND DIAGNOSTIC command. Bytes 3 and 4 designate the size of the available buffer (in bytes).

RECEIVE DIAGNOSTIC is used to transfer data to the host and must immediately follow a SEND DIAGNOSTIC command which prepares the information to be transferred. Otherwise, the command will be rejected. If no information is prepared by a particular SEND DIAGNOSTIC command, the RECEIVE DIAGNOSTIC command will be rejected.

The data length specified should be 104_H or more, although, if a smaller buffer is provided, only that much data will be transferred and the command will terminate normally.

The data buffer received as a result of a dump will be formatted as shown in Figure 6-32.

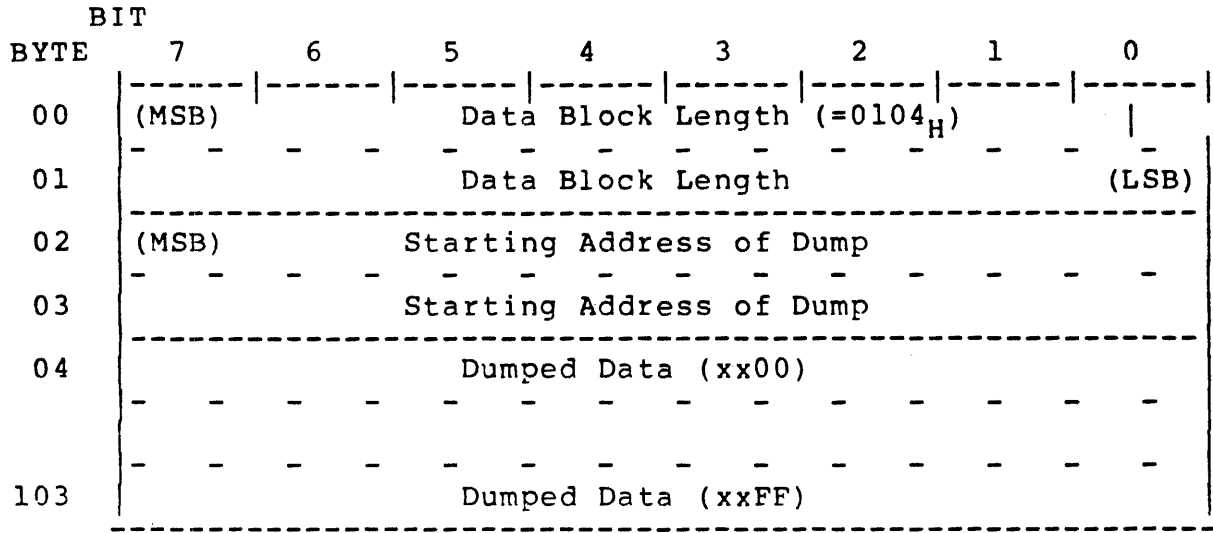

Figure 6-32. RECEIVE DIAGNOSTIC Data

Valid Errors:

<u>Error</u>	<u>Error Code</u>
Bad Argument	24
SCSI HA/Initiator Detached Error	23
SCSI Bus Out Parity Check	2E
Adapter Parity Check	2F

6.20 SEND DIAGNOSTIC (1D_H)

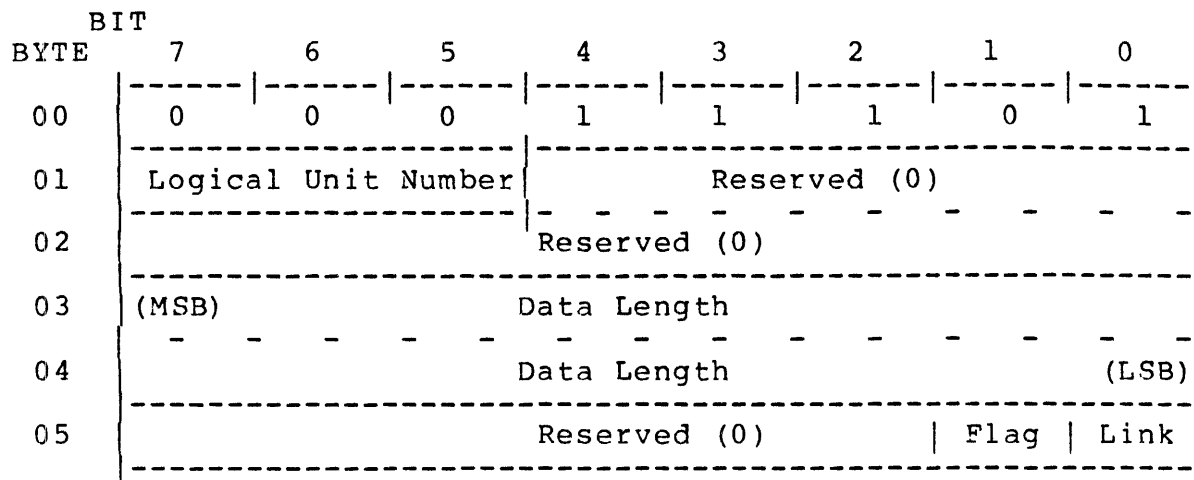

Figure 6-33. SEND DIAGNOSTIC Command

This command sends data to the Controller to specify the execution of diagnostic functions tests for Controller and peripheral units.

Bytes 3 and 4 specify the length of the data to be sent.

The data length specified in the command must be at least 4 bytes long and should be equal to the length of the data block to be passed over to the controller. If the length specified is longer than needed, the excess is ignored and not transferred.

Valid Errors:

<u>Error</u>	<u>Error Code</u>
Bad Argument	24
SCSI HA/Initiator Detached Error	2D
SCSI Bus Out Parity Check	2E
Adapter Parity Check	2F

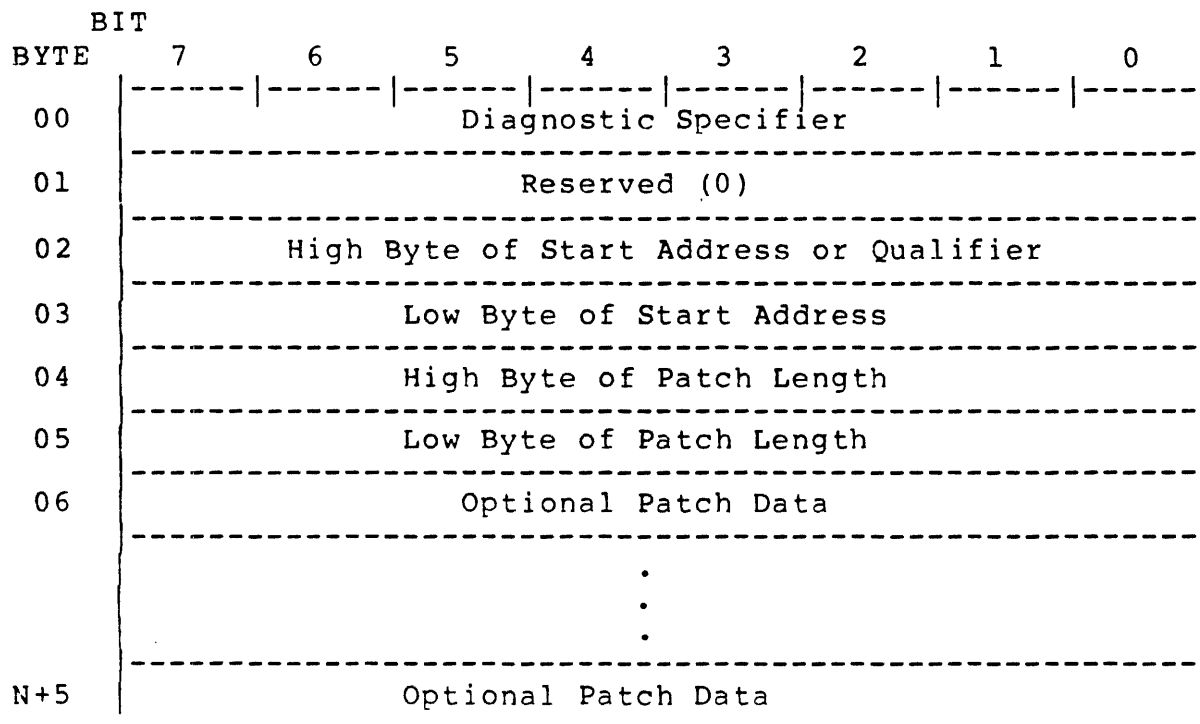

Figure 6-34. SEND DIAGNOSTIC Parameter Format

Byte 00 of the Parameter List specifies the particular diagnostic function being requested. The following options are presently available.

- 60 -- Reinitialize Drive
- 61 -- Dump Hardware Area (4000-40FF)
- 62 -- Dump RAM (8000-80FF)
- 63 -- Patch Hardware Area
- 64 -- Patch RAM
- 65 -- Set Read Error Handling Options
- 66 -- Initiate Trace

The detailed format for each of these options is described below.

6.20.1 Diagnostic 60 -- Reinitialize Drive

The selected drive runs through its initialization procedure, rezeroing, capturing the critical drive dimension parameters, determining the maximum capacity, and capturing defect skipping parameters. The parameter list is:

<u>Byte</u>	<u>Contents</u>
0	60 _H
1-5	00 _H

No RECEIVE DIAGNOSTIC information is available as a result of this diagnostic option.

6.20.2 Diagnostic 61 -- Dump Hardware Area

The area specified by the dump address is transferred by the RECEIVE DIAGNOSTIC command immediately following this SEND DIAGNOSTIC command. The parameter list is:

<u>Byte</u>	<u>Contents</u>
1	61 _H
1	00 _H
2	40 _H
3	Low Order Address of Hardware Area
4-5	Length of Transfer to be Performed.

.20.3 Diagnostic 62 -- Dump RAM Area

The area specified by the dump address is transferred by the RECEIVE DIAGNOSTIC command immediately following this SEND DIAGNOSTIC command. The parameter list is:

<u>Byte</u>	<u>Contents</u>
0	62 _H
1	00 _H
2	80 _H or E0 _H
3	Low Order Address of RAM area
4-5	Length of Transfer to be Performed.

6.20.4 Diagnostic 63 -- Patch Hardware Area

6.20.5 Diagnostic 64 -- Patch RAM Area

The commands will provide special diagnostic tools for analysis of certain very complex system interactions. No use should be made of these commands without contacting an Adaptec applications engineer, since temporary unavailability or loss of critical data may occur.

6.20.6 Diagnostic 65 -- Set Read Error Handling Options

The selected drive is set in the special error recovery mode established by the contents of byte 2. The error handling mode is set to the default value by a hard SCSI reset condition, a power on reset, and by a SEND DIAGNOSTIC command specifying the default error handling value.

<u>Byte</u>	<u>Contents</u>
0	65 _H
1	00 _H
2	Error Handling Option
3	00 _H
4	00 _H
5	00 _H

The Error Handling options are specified below:

00_H Default value.

A correctable error will be corrected and all data transfer will be completed. No check status will be presented. If the error is not correctable, the controller will transfer the uncorrected data and post an error code of 11 with the address valid bit set. The address will be the logical block address of the bad block.

01_H

If an ECC error occurs on the first read of a data field, the data transfer operation will be halted after transfer of the bad data block. A check condition will be presented. The error code will be 18 with the address valid bit set. The failing block address will be in the logical block address field of the sense information.

02_H

A correctable error will be corrected and the corrected data transferred. The operation will then stop and present check status and an error code of 18 as described in option 01_H. An uncorrectable error will be handled as in option 00_H.

6.20.7 Diagnostic 66 -- Initiate Trace

A high-level state trace facility is provided in the ACB-5580. The purpose is to provide the user with a tool to analyze complex multi-host SCSI interactions.

To enable the trace, use DIAGNOSTIC SEND Command with the following data parameters:

Byte 0 -- 66_H

Byte 1 -- Trace control options

Bit 3 = 1 -- Single device tracing

Bit 2 = 1 -- Single buffer tracing (only
EXXX Ram area will be used)

Bit 1 = 1 -- SCSI status tracing

Bit 0 = 1 -- Command tracing

Byte 2 -- Single device address

Byte 3 -- 00_H

Byte 4 -- 00_H

Byte 5 -- 00_H

The trace control options (byte 1) allow tuning of the trace contents to locate the particular system interaction of interest.

Bit 3 Single device tracing

When set, the ACB-5580 will trace all appropriate interactions on behalf of the LUN specified in byte 2. The information will be posted in RAM locations 8060-80DF for the selected device.

Bit 2 Single buffer tracing

When set, the ACB-5580 will trace all appropriate interactions for all devices in the order in which the interactions occur. The information will be posted in RAM E060 through E0DF.

Bit 1 SCSI status tracing

When set, SCSI status contents will be included in the trace of activities.

Bit 0 SCSI command tracing

When set, the SCSI command will be included in the trace of activities.

If Byte 1 is 00_H, trace is inactive. Any activation of a trace function has a small unfavorable effect on performance of the ACB-5580. The trace is automatically inactivated by a power on reset process.

Trace storage exists in RAM Locations 8060-80DF, and E060-E0DF, depending on which option is selected. To request a trace dump, the host needs to send the controller diagnostic send/receive command with the appropriate 'dump ram' instruction.

Each trace entry consists of 2 bytes as follows:

Byte 0 -- Trace Activity Indicator

Bit 7 -- Trace type status
Bit 6 -- Trace type command
Bit 7, Bit 6 = 00

Value of Meaning
Bits 5-0

01	Host Selection
02	Reconnection
03	Disconnection
04	Attention Handling
05	Command Linking
06	Command End
07	SCSI Reset
0A	Bus Device Reset

Bit 7 = 1

Bits 6-0 Contain status byte presented

Bit 7, 6 = 01

Bits 5-0 Contain CDB operation byte received

Byte 1 -- Device/Host adapter IDs

Bits 7:4 -- Binary ID of LUN
Bits 3:0 -- Binary ID of Host Adapter.

Trace storage is organized as: 2 bytes of trace pointer followed by the wrap-around trace buffer. The trace pointer refers to the next available entry area for a trace entry.

Valid Errors:

<u>Error</u>	<u>Error Code</u>
Bad Argument	24
SCSI HA/Initiator Detached Error	2D
SCSI Bus Out Parity Check	2E
Adapter parity Check	2F

6.21 READ CAPACITY (25_H)

BYTE	BIT							
	7	6	5	4	3	2	1	0
00	0	0	1	0	0	1	0	1
01	Logical Unit Number			RESERVED (0)				Rel Ad
02	(MSB)			Logical Block Address				
03				Logical Block Address				
04				Logical Block Address				
05				Logical Block Address				(LSB)
06				Reserved (0)				
07				Reserved				
08				Reserved (0)				PMI
09				Reserved				Flag Link

Figure 6-35. READ CAPACITY Command

If the Partial Media Indicator (PMI) is 0, this command will return the address of the last block on the unit. It is not necessary to specify a starting block address in this command mode. If the PMI is 1, this command will return the address of the block (after the specified starting address) at which a substantial delay in data transfer will be encountered (e.g., a cylinder boundary).

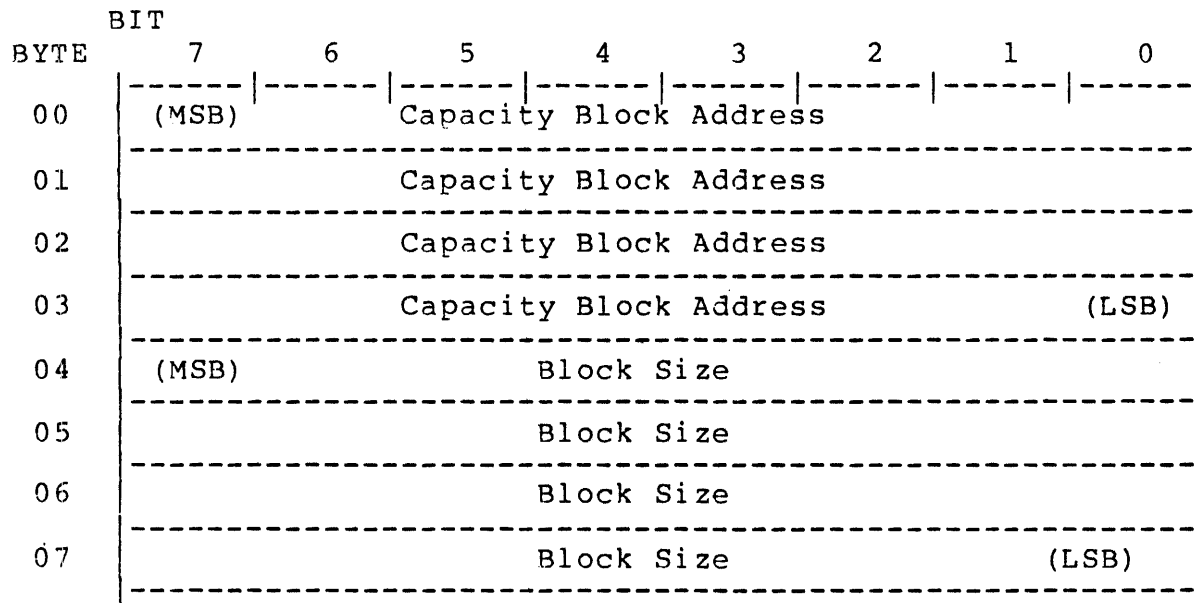

Figure 6-36. Returned Read Capacity, Parameters

The indicated capacity information is contained in the Capacity Block Address bytes. The block size for the particular format is contained in the Block Size bytes.

Valid Errors:

<u>Error</u>	<u>Error Code</u>
All Class 0 Errors	00-05
I.D. ECC Error	10
I.D. AM Not Found	12
Record Not Found	14
Seek Error	15
Bad Format	1C
Bad Argument	24
Cartridge Changed	28
SCSI HA/Initiator Detached Error	2D
SCSI Bus Out Parity Check	2E
Adapter Parity Check	2F

6.22 READ (28_H)

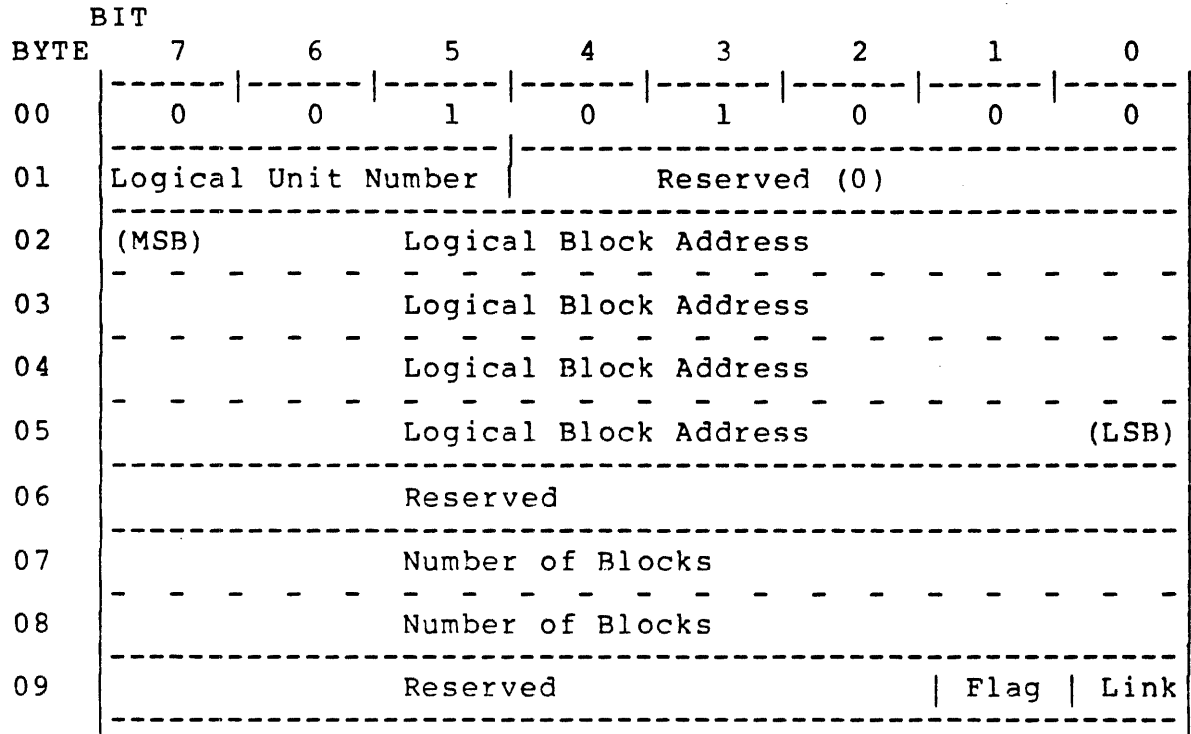

Figure 6-37. READ Command

This command is an extended address command which is otherwise identical to the Class 00 **READ** (08_H) command.

The larger Logical Block Address and Number of Blocks fields are provided for accessing very large devices.

Valid Errors:

Read Operation Errors (See Section 6.5)

6.23 WRITE (Extended) (2A)

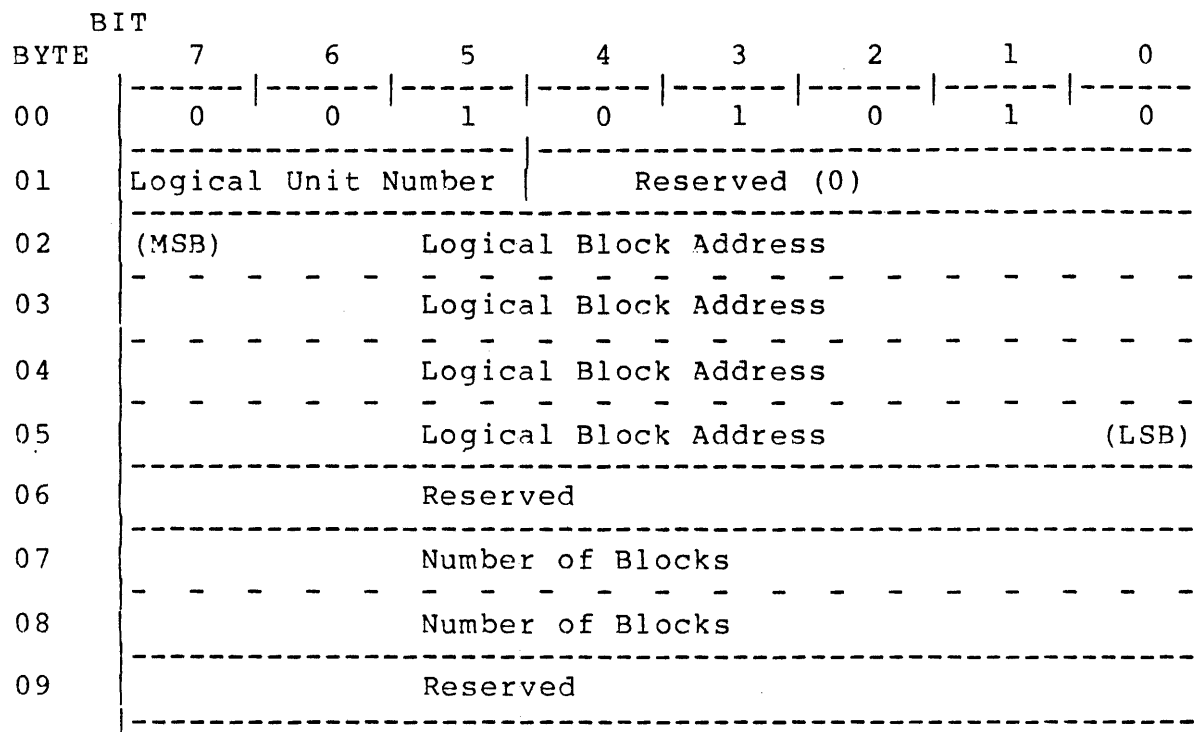

Figure 6-38. WRITE Command

This command is an extended address command otherwise identical to the Class 00 WRITE (0A_H) command. The Logical Block Address and Number of Blocks fields have been expanded for larger devices.

Valid Errors:

Write Operate Errors (See Section 6.6)

6.24 WRITE AND VERIFY (2E_H)

BYTE	BIT								
	7	6	5	4	3	2	1	0	
00	0	0	1	0	1	1	1	0	
01	Logical Unit Number				Reserved (0)				
02	(MSB)			Logical Block Address					
03	-			Logical Block Address					
04	-			Logical Block Address					
05	-			Logical Block Address					(LSB)
06	Reserved								
07	Number of Blocks								
08	Number of Blocks								
09	Reserved					Flag		Link	

Figure 6-39. WRITE and VERIFY Command

This command is similar to the traditional "read after write" function. It is an extended address command which operates like a WRITE command over the specified number of blocks and then verifies the data written on a block by block basis. The verify function transfers no data to the host and only checks the ECC to be correct.

Since no data is transferred to the host during verify, correctable data checks will be treated in the same manner as uncorrectable data checks.

Valid Error:

Read Operation Errors (See 6.5)

Write Operation Errors (See 6.6)

ECC Error During Verify 19_H

6.25 VERIFY (2F_H)

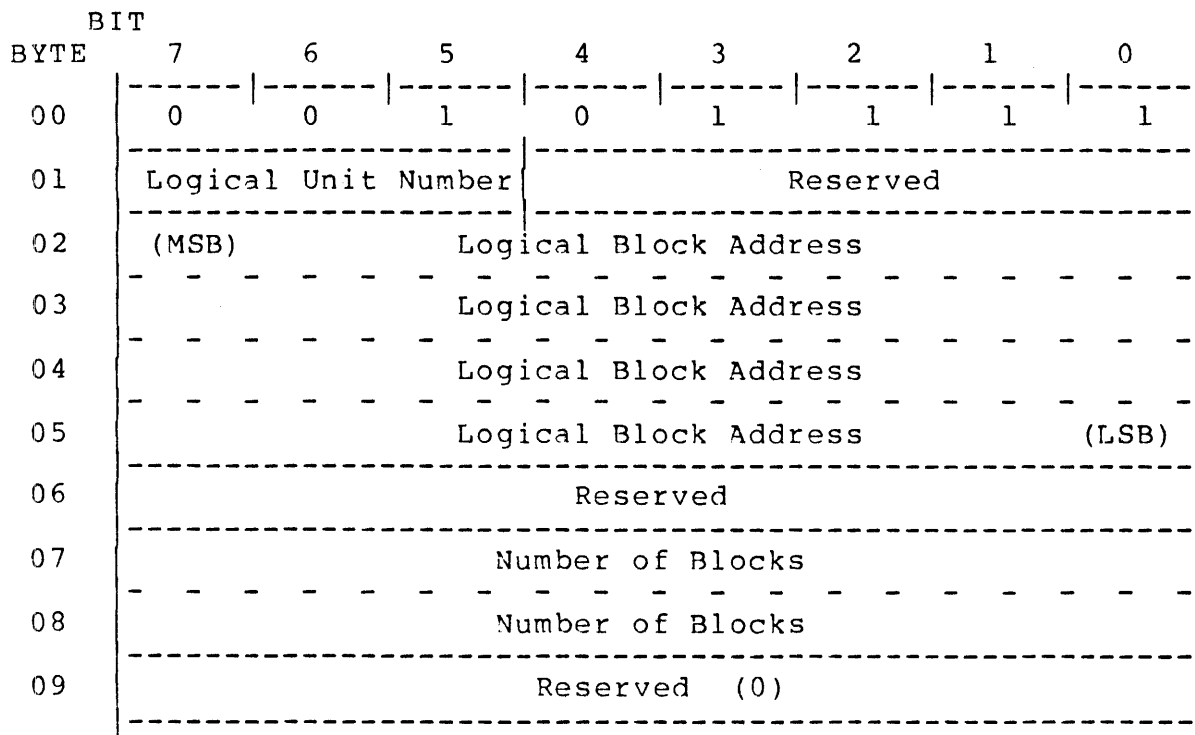

Figure 6-40. VERIFY Command

This command is similar to the previous WRITE AND VERIFY except that it verifies the ECC of an already existing set of data blocks. It is up to the Host to provide data for rewriting and correcting if an ECC error is detected.

Valid Errors:

Read Operation Errors (See Section 6.5)

ECC Error During Verify 19

6.26 SEARCH DATA EQUAL (31_H)

BYTE	BIT							
	07	06	05	04	03	02	01	00
00	0	0	1	1	0	0	0	1
01	Logical Unit Number Invert				Reserved (0)			
02	(MSB)		Logical Block Address					
03	-		Logical Block Address				-	
04	-		Logical Block Address				-	
05	-		Logical Block Address				(LSB)	
06	Reserved							
07	Number of Blocks							
08	-		Number of Blocks				-	
09	Reserved (0)						Flag	Link

Figure 6-41. SEARCH DATA EQUAL Command

This powerful extended address command provides for a search and compare on equal of any data on the disk. A starting block address and number of blocks to search are specified and a search argument is passed from the Host which includes the data to compare.

The Invert bit (Byte 01, Bit 04) inverts the sense of the search comparison operation. With Invert on, a SEARCH DATA EQUAL command would succeed on data not equal. The invert bit on the ACB-5580 allows SEARCH EQUAL inverted which succeeds on the first block not equal to the pattern.

This command allows the host to perform a high speed data verify. Unlike the VERIFY Command which only checks for ECC errors, the search data equal will compare a chosen data pattern against data contained in selected blocks "on the fly." This feature provides an excellent method of verifying disk integrity after format by searching not equal for a "6C" or other unique fill character.

If the link bit is zero, no command is linked to the SEARCH DATA EQUAL. If the search is satisfied, the command is terminated with CONDITION MET status. A REQUEST SENSE command following a successful SEARCH DATA EQUAL can be issued to determine the Logical Block Address at the matching record.

If the link bit is one, a command is linked to the SEARCH DATA EQUAL command. If the search is successful, the next command is executed. The next command may use the Relative Address Bit, in which case the logical block address is a displacement from the block at which the search was satisfied. If a linked search is not satisfied, the command is terminated with a Check Condition status. A Request Sense can then be issued.

When a search is satisfied, it will terminate with a Condition Met Status. A Request Sense Command can then be issued to determine the block address of the matching record. A Request Sense following a successful Search Data command will:

- 1) Report a Sense Key of Equal if the search was satisfied by an exact match. If the search was satisfied by an inequality, a Sense Key of No Sense is reported.
- 2) Set the Address Valid bit to one.
- 3) Report the address of the block containing the first matching record in the Information Bytes.

The Request Sense command following an unsuccessful Search Data command will:

- 1) Report a Sense Key of No Sense, provided no errors occurred.
- 2) Set the Valid bit to zero.

Valid Errors:

All Read Operation Errors (See Section 6.5)

BYTE	BIT							
	07	06	05	04	03	02	01	00
00	(MSB)				Record Size			
01					Record Size			
02					Record Size			
03					Record Size			(LSB)
04	(MSB)			First Record Offset				
05				First Record Offset				
06				First Record Offset				
07				First Record Offset				(LSB)
08	(MSB)			Number of Records				
09				Number of Records				
10				Number of Records				
11				Number of Records				(LSB)
12	(MSB)			Search Argument Length				
13				Search Argument Length				(LSB)
14	(MSB)			Search Field Displacement				
15				Search Field Displacement				
16				Search Field Displacement				
17				Search Field Displacement				(LSB)
18	(MSB)			Pattern Length				
19				Pattern Length				(LSB)
20				Data Pattern				
.								
.								
M+19				Data Pattern				

Figure 6-42. SEARCH DATA EQUAL Argument

A definition of the required data in the SEARCH argument is shown in Table 6-7.

Table 6-7. SEARCH DATA EQUAL Argument

<u>BYTES</u>	<u>PARAMETER</u>
00 TO 03	Record Size (Bytes) This must equal the blocksize or zero. Zero will be taken to mean the format blocksize.
04 to 07	First Record Offset (Bytes) For the ACB-5580 this must be zero.
08 to 11	Number of Records For ADAPTEC controllers this must be less than or equal to the number of blocks specified in the command and greater than zero. The search will terminate upon a match or when the smaller of these values is encountered.
12 to 13	Search Argument length (Bytes) The number of bytes in the following search argument. Must equal the pattern length + 6.
14 to 17	Search Field Displacement The displacement from the beginning of the record to the first byte to be compared. Must be zero.
18 to 19	Pattern Length (M Bytes) The number of bytes in the following data pattern to be compared with a like size field in each record. The pattern length must equal the blocksize.
20 to M+19	Data Pattern The block of data to be compared.

6.27 SET LIMITS (33H)

BYTE	BIT							
	7	6	5	4	3	2	1	0
00	0	0	1	1	0	0	1	1
01	Logical Unit Nbr			Reserved			Rd Inh	Wr Inh
02	Logical Block Address (MSB)							
03	Logical Block Address							
04	Logical Block Address							
05	Logical Block Address							
06	Reserved							
07	Number of Blocks (MSB)							
08	Number of Blocks (LSB)							
09	Reserved						Flag	Link

Figure 6-43. SET LIMITS Command

This command defines the addresses outside of which any following linked commands may not operate. A second SET LIMITS command may not be linked to a chain of commands in which a SET LIMITS command has already been issued. The two low-order bits of the Byte 01 define the legal operations within the limits of the specified addresses. Bit 0 indicates WRITE INHIBIT, and Bit 1 indicates READ INHIBIT.

When the Number of Blocks field (Bytes 07 to 08) is zero, the limits shall extend from the Logical Block Address (Bytes 02 to 05) to the last block on the unit.

Valid Errors:

<u>Error</u>	<u>Error Code</u>
Illegal Block Address	21
Bad Argument	24
SCSI HA/Initiator Detached Error	2D
SCSI Bus Out Parity Check	2E
Adapter Parity Check	2F



adaptec, inc.

580 Cottonwood Drive, Milpitas, California 95035 Telephone (408) 946-8600

500519-00/AB/SB/BOFORS Printed in U.S.A.