

See for yourself

VISUAL 100



WARNING

This equipment generates, uses, and can radiate radio frequency energy and if not installed and used in accordance with the instruction manual may cause interference to radio communications. As temporarily permitted by regulation it has not been tested for compliance with the limits for Class A computing devices pursuant to Subpart J of Part 15 of FCC Rules which are designed to provide reasonable protection against such interference. Operation of this equipment in a residential area is likely to cause interference in which case the user at his own expense will be required to take whatever measures may be required to correct the interference.

VISUAL 100
REFERENCE MANUAL

NOVEMBER 1982

SAFETY WARNING

Hazardous voltages 115, 220 VAC and 15 KV DC are present when the terminal is on, and may remain after power is removed. Use caution when working on internal circuits, and do not work alone.

When handling the cathode ray tube caution is required as the internal phosphor is toxic. Safety goggles and gloves must be used whenever the CRT tube is handled. Should the tube break, skin or eyes exposed to the phosphor, rinse the affected area with cold water and consult a physician.

The terminal is supplied with a cord set which includes a safety ground. Do not use this terminal with an ungrounded outlet, missing ground pin, or use any adaptor which will defeat the safety ground.

Insure that power is turned off before connecting or disconnecting the keyboard cable.

This manual is published and distributed by Visual Technology Inc. Every effort has been exercised to insure its accuracy and completeness. The contents are subject to change without notice and this manual may not reflect the latest changes. Consult the sales department for latest changes.

TABLE OF CONTENTS

	Page
1. INTRODUCTION	1
2. SPECIFICATIONS/CHARACTERISTICS	3
2.1 KEYBOARD	3
2.2 VIDEO MONITOR AND COMPOSITE VIDEO	3
2.3 P.C.B. AND COMMUNICATION INTERFACE	3
2.4 GENERAL SPECIFICATIONS	7
3. START-UP PROCEDURES	9
3.1 INSTALLATION	9
3.2 SET-UP MODES	9
3.2.1 General	9
3.2.1.1 How to Enter SET-UP Mode	10
3.2.1.2 How to Determine the Status of SET-UP FEATURES	10
3.2.1.3 How to Change SET-UP Features	11
3.2.1.4 Performing a RECALL Operation	14
3.2.1.5 Performing a SAVE Operation	14
3.2.1.6 Performing a RESET Operation	15
3.2.2 SET-UP Feature Definitions	15
3.2.2.1 Line/Local	15
3.2.2.2 Characters Per Line	15
3.2.2.3 Tabs	16
3.2.2.4 Screen Brightness	16
3.2.2.5 ANSI/VT-52	16
3.2.2.6 Smooth/Jump Scroll	16
3.2.2.7 Autorepeat	17
3.2.2.8 Screen Presentation	17
3.2.2.9 Cursor Selection	17
3.2.2.10 Margin Bell	17
3.2.2.11 Keyclick	17
3.2.2.12 Auto XON/XOFF	17
3.2.2.13 U.K./U.S. Character Set	18
3.2.2.14 Autowrap	18
3.2.2.15 New Line	18
3.2.2.16 Local Echo	18
3.2.2.17 Parity	18
3.2.2.18 Parity Select	19
3.2.2.19 Bits Per Character	19
3.2.2.20 Refresh Rate	19
3.2.2.21 Transmit Speed	19
3.2.2.22 Receive Speed	19
3.2.2.23 Answerback Message	19
4. KEYBOARD CONTROLS AND L.E.D.'S	21

TABLE OF CONTENTS – Continued

	Page
5. TERMINAL PROGRAMMING	27
5.1 GENERAL	27
5.2 CONTROL CODES	27
5.3 CONTROL SEQUENCE FUNCTIONS	27
5.3.1 Control Sequences Recognized in VT-52 Mode	27
5.3.2 Control Sequence Recognized in ANSI Mode	32
5.3.2.1 General	32
5.3.2.2 Scrolling Region Command, ESC [x;y r (Private)	33
5.3.2.3 Cursor Positioning Commands	33
5.3.2.4 Erasure Commands, ESC [Ps F	35
5.3.2.5 Character Size Commands (Private)	35
5.3.2.6 Video Attribute Commands	36
5.3.2.7 Programmable L.E.D. Commands, ESC [Ps; Ps Ps q (Private)	37
5.3.2.8 Tab Commands	37
5.3.2.9 Character Set Commands (Private)	37
5.3.2.10 Report Commands and Responses	38
5.3.2.11 Test Commands	40
5.3.2.12 Modes	40
5.3.2.13 Reset Command, ESC c	43
5.3.2.14 Alternate Keypad Mode	43
5.4 SYNCHRONIZATION	44
6. BUFFERED PRINTER INTERFACE OPTION	45
6.1 GENERAL	45
6.2 SET-UP P FEATURE DEFINITIONS	48
6.2.1 Copy Mode	48
6.2.2 Printer Controller Mode	48
6.2.3 Auto Print Mode	48
6.2.4 Underline Sequence	48
6.2.5 Printer Busy	48
6.2.6 Printer Type	49
6.2.7 LF Suppress	49
6.2.8 Cancel Sheet	49
6.2.9 Parity Select and Parity Enable	49
6.2.10 Bits per Character	50
6.2.11 Busy Polarity	50
6.2.12 Print Speed	50
6.3 PRINTER COMMANDS AND MODES	50
6.3.1 Print Line/Page Commands	50
6.3.2 Copy Mode	50
6.3.3 Printer Controller Mode	51
6.3.4 Auto Print Mode	51

TABLE OF CONTENTS – Continued

	Page
6.4 VISUAL 100 PRINTER OPTION, VERSION II	51
6.4.1 General	51
6.4.2 Version II Modes	51
6.4.2.1 Print Extent Mode	51
6.4.2.2 Form Feed Mode	52
6.4.2.3 Insert Replace Mode	52
6.5 ADDITIONAL COMMANDS	53
6.5.1 Insert Line(s), ESC [Pn L	53
6.5.2 Delete Line(s), ESC [Pn M	53
6.5.3 Delete Character(s), ESC [Pn P	53
6.6 MODIFIED COMMANDS	53
6.6.1 Identify Response	53
6.6.2 Report Terminal Parameters Response	53
7. FIRST LEVEL MAINTENANCE	57
7.2 TOP COVER	57
7.2.1 Top Cover Removal	57
7.3 PRINTED CIRCUIT BOARD REMOVAL AND INSTALLATION	58
7.4 TV MONITOR PCB REMOVAL AND INSTALLATION	59
7.5 CRT AND FLYBACK REMOVAL AND INSTALLATION	59
7.6 TV MONITOR ADJUSTMENTS	59
7.7 110/220 VOLT SELECTION	61
7.8 TROUBLESHOOTING	62
7.8.1 Self Test	62
7.8.2 Fault Isolation	62
APPENDIX I –VISUAL 100 CONTROL CODES	65
APPENDIX II –VISUAL 100 VT-52 MODE CONTROL SEQUENCES	67
APPENDIX III –VISUAL 100 ANSI MODE CONTROL SEQUENCES	69
APPENDIX IV –ASCII CODE CHART	71
APPENDIX V –TURN-AROUND CONNECTOR FOR INTERFACE TESTS	73

LIST OF FIGURES

		Page
Figure 2-1	Byte Configurations	6
Figure 3-1	SET-UP A Presentation	10
Figure 3-2	SET-UP B Presentation	11
Figure 3-3	SET-UP B Summary	12
Figure 4-1	Visual 100 Keyboard Layout	21
Figure 6-1	SET-UP P Presentation	46
Figure 6-2	SET-UP P Summary	47
Figure 7-1	Rear Panel Screw Locations	57
Figure 7-2	Top Cover Removal	58
Figure 7-3	Location of TV Monitor Adjustments	60
Figure 7-4	110/220 Volt Selection	61

LIST OF TABLES

Table 2-1	EIA RS232-C Signal Definitions and Connector Pins, and 20 MA Current Loop Pin Polarity	4
Table 2-2	Initial Settings and Functions for Internal Switches	5
Table 3-1	SET-UP Feature Change Summary	13
Table 4-1	Codes Transmitted by Cursor Positioning Keys	23
Table 4-2	Codes Transmitted by Function Keys	24
Table 4-3	Codes Transmitted in Alternate Keypad Mode	24
Table 5-1	Control Code Summary	28
Table 5-2	Graphic Character Set	30
Table 5-3	Cursor Addressing Code Chart (VT52 Mode)	31
Table 5-4	ANSI Mode Cursor Control Commands	34
Table 5-5	ANSI Mode Erase Commands	35
Table 5-6	Summary of Video Attributes and Selective Parameters	36
Table 5-7	Selective Parameters Associated with "Report Terminal Parameters" Response	39
Table 5-8	Selective Parameters Associated with Set/Reset Mode Control Sequences	41
Table 6-1	Printer Port Pin Designations	45
Table 6-2	Summary of Print Commands and Modes	55

1. INTRODUCTION

The VISUAL 100 display terminal is an attractive, full-featured unit offering plug-to-plug compatibility with the DEC VT100* display terminal. It offers complete compatibility with the DEC VT100 from both an operator and software point of view. For the operator, the detached solid-state keyboard has been customized so that all key positions and LED indicators are in identical location to that of the VT100. For the software, all codes and features, including double height/double width characters, 80/132 column screen, smooth scroll and selectable scroll area are identical.

In addition, the VISUAL 100 incorporates several features as standard which are extra cost options on the VT100 such as an advanced video package (blink, underline, high-intensity, reverse video) and current loop interface. Other enhancements include non-glare screen for crisp, easy to read characters even in the brightest environments, and a rugged all-steel case. The VISUAL 100 also has a CRT saver feature which causes the screen to dim if the terminal is inactive for a period of 8 minutes. Hitting any key on the keyboard will cause the screen to return to normal intensity. This feature greatly prolongs CRT life.

The VISUAL 100 may also be easily interfaced with a variety of serial printers through an optional buffered printer interface which allows independent print/communication baud rates and independent parity. Printer busy may be monitored using XON XOFF protocol or control line. The printer option also allows the VISUAL 100 to function as a controller between host and printer, using XON XOFF protocol.

*VT100 is a trademark of Digital Equipment Corporation.

2. SPECIFICATIONS/CHARACTERISTICS

The VISUAL 100 display terminal consists of three basic subassemblies: Keyboard, Video Monitor, and Printer Circuit Board including communication interface. The following paragraphs summarize the basic features of each subassembly. Section 2.4 lists the general specifications of the VISUAL 100.

2.1 KEYBOARD

The VISUAL 100 employs a field proven solid-state keyboard using capacitively coupled keys for high reliability and long life. The keys are arranged in a familiar "typewriter" layout as pictured in Figure 4-1.

The keyboard is fully detachable from the terminal for operator comfort and optimal space utilization. The cable leading from the keyboard is terminated with a 15-pin connector which plugs into the receptacle labeled keyboard on the rear panel.

Depressing a key on the keyboard will cause its code to be sent out on the communication interface provided the terminal is online.¹ All keys except those noted in Section 3.2.2.7 may also be defined to be "typomatic", (auto repeat) or non-typomatic. The typomatic feature allows the codes for the depressed key to be generated at a rate of 30 characters per second.

Section 4 details all keys on the keyboard and the code(s) they generate.

2.2 VIDEO MONITOR AND COMPOSITE VIDEO

The Video Monitor used in the VISUAL 100 is a high quality 12" cathode ray tube (CRT). The CRT uses a P4 white phosphor and a non-interlaced raster scanning method to produce crisp, easy to read characters of high resolution. The CRT includes a non-glare faceplate to assure easy readability even in the brightest environments. Characters are formed using 7x7 dot matrix for upper case, and 7x9 for lower case.

The format for character display may be either 24 lines of 80 characters or 24 lines of 132 characters. Characters may also be formed in double heights and double widths on a line by line basis.

Composite video output is provided via a jack on the rear panel. This feature will drive another T.V. monitor of the following specifications:

1. Video Bandwidth 12 MHz
2. Horizontal Frequency 15.6 kHz
3. Voltage Output 1.5 Volts, Peak to Peak

2.3 P.C.B. AND COMMUNICATION INTERFACE

A single, vertically mounted printed circuit board (P.C.B.) contains all necessary program memory (ROM) and display memory (RAM). The P.C.B. utilizes a convection cooled, no-fan design for high reliability and silent operation.

¹Some keys do not produce codes when depressed alone. See Section 4.

The VISUAL 100 provides as standard, both an EIA RS232-C and a 20-milliampere current loop interface. Both interfaces conform to a bit-serial, asynchronous, start-stop format and operate in a full-duplex mode.

The EIA RS232-C interface provides all control and sequencing signals for interfacing to remote equipment through a modem or for direct connection to local equipment. This interface labeled EIA, is located on the rear panel and interfaces with the communication line via a 25 pin connector. Table 2-1 lists all the EIA signal definitions and connector pins for the RS232-C interface.

The 20-milliampere current loop interface may be passive or active and allows direct connection to most equipment. Table 2-1 lists the pin polarity designations for the 20-milliampere current loop interface.

TABLE 2-1
EIA RS232-C SIGNAL DEFINITIONS AND CONNECTOR PINS,
AND 20 MA CURRENT LOOP PIN POLARITY

Pin	RS232-C Mnemonic	CCITT V24 Mnemonic	Definition
1	AA	101	Protective Ground
2	BA	103	Transmit Data to Modem
3	BB	104	Receive Data from Modem
4	CA	105	Request-to-Send
5	CB	106	Clear-to-Send
6	CC	107	Data Set Ready
7	AB	102	Signal Ground
8	CF	109	Carrier Detect
11	SCA	—	Secondary Channel Request-to-Send (202 modem)
12	SCF	122	Secondary Channel Carrier Detect
17	—	—	Current Loop Receive —
18	—	—	Current Loop Receive +
19	SCA	120	Secondary Channel Request-to-Send (RS232, V24 modem)
20	CD	108.2	Data Terminal Ready
21	—	—	Current Loop Transmit +
23*	CH	111	Speed Select, always ON (High Speed)
25	—	—	Current Loop Transmit —

*Pin 23 is used on some dual-speed modems to select speed. This VISUAL 100 always has this signal ON. If low speed operation of the dual-speed modem is desired, it is necessary to "float" pin 23 (extract pin 23 from the modem cable at one end).

The EIA RS232-C or 20-milliampere current loop interface is selected via a row of 8 miniature dip switches located at position U73 on the P.C.B. Table 2-2 summarizes the initial switch setting and the function of each miniature switch.

**TABLE 2-2
INITIAL SETTINGS AND FUNCTIONS FOR INTERNAL SWITCHES**

Switch Number	Initial Setting	OFF	ON	Comments
1	OFF	Disable Optional Character Generator ROM	Enable Optional Character Generator ROM	No Optional ROM in Standard Unit
2	OFF	EIA Interface	Current Loop Interface	
3	OFF	EIA Interface or Current Loop Active	Current Loop Interface Passive	Receive
4	OFF	Passive Current Loop Interface (Exterior Current Source)	Active Current Loop Interface (V100 Current Source)	Receive
5	OFF	EIA Interface or Current Loop Active	Current Loop Interface Passive	X-mit
6	OFF	Passive Current Loop Interface	Active Current Loop Interface	X-mit
7	OFF	Pin #19 on EIA Interface Disconnected	Pin #19 Held High	VISUAL 100 doesn't support secondary channel
8	ON	Pin #11 on EIA Interface Disconnected	Pin #11 Held High	

Examples of Typical Settings

1. Passive Current Loop Interface; Switches 2, 3, 5 ON
2. Active Current Loop Interface; Switches 2, 4, 6 ON
3. EIA RS232/CCITT V24, Switch 7 ON (all other switches OFF)
4. Bell 202 Interface, Switch 8 ON (all other switches OFF)

Other communication interface features include:

- Local copy capability for applications requiring the “echoing” of transmitted data (see Section 3.2.2.16)
- 16 data rates ranging from 50 to 19,200 baud
- Independent transmit/receive rates
- Odd, even, or no parity, generated on transmit and checked on receive
- 7 or 8 bit ASCII Code. (See Figure 2-1 for various byte configurations.)

BYTE DESCRIPTION

BYTE CONFIGURATION

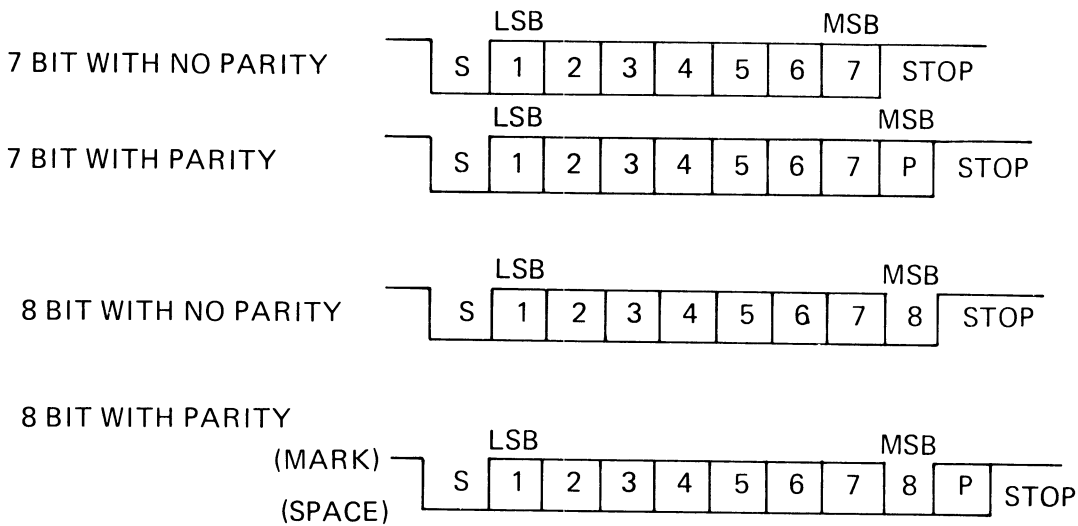

- S = START BIT, ALWAYS = 0
- LSB = LEAST SIGNIFICANT DATA BIT
- MSB = MOST SIGNIFICANT DATA BIT
(always space, with 8 bit code)
- STOP = STOP BIT(S), 2 AT 110 BAUD OR LESS,
1 AT HIGHER THAN 110 BAUD
- P = PARITY BIT, ODD OR EVEN

Figure 2-1 Byte Configurations

2.4 GENERAL SPECIFICATIONS

TERMINAL TYPE: DEC VT100 Compatible, (VT-52 and ANSI X3.64 modes), TTY Compatible Z-80 Microprocessor based.

COMMUNICATION

Code: 128 Character ASCII
Type: Serial Asynchronous
Speed: Independent xmit/receive rates; 50, 75, 110, 134.5, 150, 200, 300, 600, 1200, 1800, 2000, 2400, 3600, 4800, 9600, 19,200
Method: Character by Character (conversational)
Mode: Full duplex with or without local echo
Parity: Odd, even, none
Interface: EIA RS232-C and 20/50 M.A. current loc,
Stop Bits: 2 at 110 BPS or below, 1 at 134.5 BPS and above

SCREEN PRESENTATION

Display Unit: 12" non-glare CRT. Composite video output.
Format: 24 lines by 80 columns, or 24 lines by 132 columns
Cursor: Blinking block or blinking underline, selectable
Character Formation: 7x7 dot matrix with 2 dot lower-case extenders
Character Presentation: Single/double heights and widths, selectable on line basis
Refresh Rate: 50/60 Hz
Character Set: 95 ASCII, U.S./U.K., plus 32 character graphics
Video Attributes: Underline, reverse-video, blink, bold in any combination

DATA ENTRY: Scroll mode, selectable scroll area, smooth scroll.

AUDIBLE INDICATORS: On receipt of BEL code, keyclick for xmitted codes and error indicator, selectable bell at column 72.

EXTERNAL OPERATOR CONTROLS: Power ON/OFF

LED INDICATORS: Line/local, Keyboard locked, 4 programmable LED's

KEYBOARD: Detachable, solid-state, capacitive scan technology, selectable auto repeat.

DIAGNOSTICS: Self test

POWER: 117 x AC \pm 15% @ 1A

PHYSICAL: H x W x D; 13" x 17" x 21", weight: Keyboard 6 lbs., Terminal 37 lbs.

OPERATING RANGE: 10 to 40 degrees Celsius, -20 to 60 (storage)
Humidity 5% to 95% non-condensing

OPTIONS: Serial Buffered Printer Interface
Hewlett Packard Protocol Compatibility

3. START-UP PROCEDURES

3.1 INSTALLATION

When installing the VISUAL 100 for the first time, or when moving the terminal to a new location or new communications trunk, the following steps should be followed.

1. Unpack the terminal and place it in the desired work area.
2. Tilt the terminal portion up and read the voltage value from the serial number tag. If the voltage is correct, proceed to step 4.
3. If the voltage is incorrect, change the transformer wiring as described in Section 7.8.
4. If the interface is EIA, proceed with step 7.
5. If the interface is current loop, remove the rear panel (Section 7.2) and set the internal switches as defined in Table 2-2.
6. Install the rear panel.
7. Plug in the Keyboard cable, Interface cable, and Printer cable into the corresponding connector.
8. Power on the terminal.
9. If intensity is too low, cursor not visible, press SET-UP key once, then press and hold the ↑ key until the screen presentation is visible.
10. Proceed with SET-UP procedure as described in Section 3.2.

3.2 SET-UP MODES

3.2.1 General

The VISUAL 100 does not use exterior switches or jumpers to determine which built-in terminal features will be on or off. Instead, a nonvolatile RAM memory is used to remember which features are enabled and disabled. Terminal features are selected and stored in a special mode called SET-UP mode. When SET-UP mode is entered, the status of terminal features is displayed on the screen. You can then change the terminal features to any desired configuration. Once the desired configuration is selected, the terminal will function per the new configuration on either temporary basis (by exiting SET-UP mode) or fixed basis (by performing the SAVE operation).

SET-UP mode is divided into two parts; SET-UP A and SET-UP B.* SET-UP A shows whether an 80 or 132 column screen format is selected and also displays the location of each columnar tab stop. Each SET-UP A feature is described in detail in Section 3.2.2. SET-UP B summarizes the status of other terminal features and is described in detail in Section 3.2.3. Table 3-1 summarizes the various features that are determined in SET-UP A and SET-UP B.

*If the buffered printer option is selected, SET-UP mode is divided into 3 parts, see Section 6.

3.2.1.1 How to Enter SET-UP Mode

SET-UP A is entered by depressing the SET-UP key on the keyboard. SET-UP B may only be entered from SET-UP A and is entered by depressing the  key on the keyboard.

Subsequent depressions of the  key will alternately switch between SET-UP A and SET-UP B.

3.2.1.2 How to Determine the Status of SET-UP Features

When SET-UP A is entered, the screen will display a presentation as shown in Figure 3-1. This presentation shows the location of each tab stop, as indicated by a "T" and also shows whether an 80 column or 132 column format is enabled.

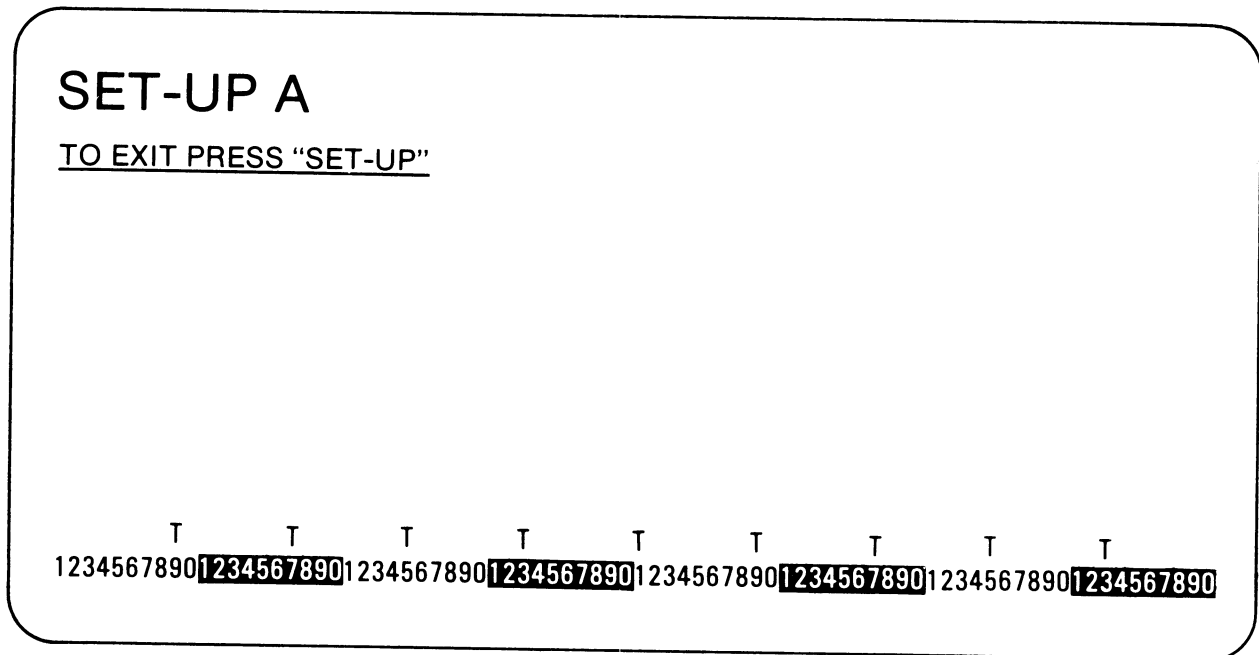

Figure 3-1 SET-UP A Presentation

When SET-UP B is entered, the screen will display a presentation as shown in Figure 3-2. This presentation shows which features are enabled per the summary in Figure 3-3.

SET-UP B

TO EXIT PRESS "SET-UP"





1 **0101** 2 **0101** 3 **0000** 4 **0010** T SPEED 9600 R SPEED 9600

Figure 3-2 SET-UP B Presentation

3.2.1.3 How to Change SET-UP Features

As noted earlier in this section, SET-UP features may be stored in non-volatile memory. The SET-UP features stored when the VISUAL 100 is shipped from the factory are shown in Figures 3-1 and 3-2.

To change any or all of the SET-UP features from the keyboard, the following procedure should be followed:

1. Enter SET-UP mode by depressing the SET-UP key.
2. Select either SET-UP A or SET-UP B by depressing the  key on the keyboard. SET-UP A must be selected to change SET-UP A features and SET-UP B must be selected to change SET-UP B features. Table 3-1 lists the features that are changeable in SET-UP A and SET-UP B.
3. Position the cursor, (via the   spacebar, tab or return keys), over the feature or tab stop to be changed. (Some features may be changed by depressing a single dedicated key and thus do not require this step.)
4. Depress the  key to change the feature under which the cursor resides or depress the particular key dedicated to changing the SET-UP feature.

Some SET-UP features may also be changed from the host computer by set/reset mode control sequences. Table 3-1 shows which SET-UP features are host changeable via modes and Section 5.3.2.12 details each mode.

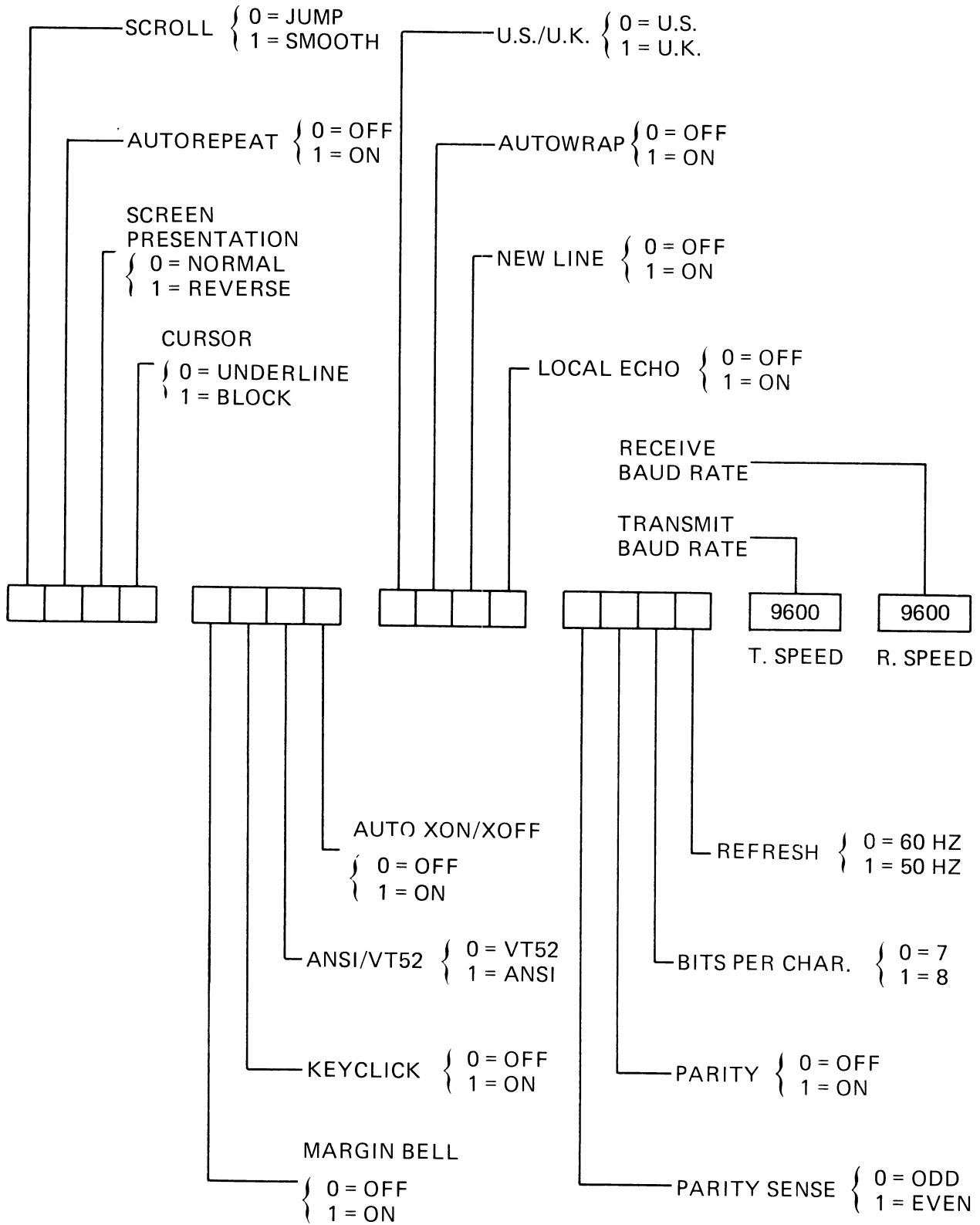











Figure 3-3 SET-UP B Summary

**TABLE 3-1
SET-UP FEATURE CHANGE SUMMARY**

SET-UP Feature	Changed in		Dedicated Key Used to Change Feature	Position Cursor then Depress  6	Changeable from Host
	SET-UP A	SET-UP B			
Line/Local	✓	✓			
Characters Per Line	✓				✓
Tabs	✓		 and 		✓
Screen Brightness	✓	✓	 or 		
ANSI/VT52 Mode		✓		✓	✓
Smooth/Jump Scroll		✓		✓	✓
Autorepeat		✓		✓	✓
Screen Presentation		✓		✓	✓
Cursor Selection		✓		✓	
Margin Bell		✓		✓	
Key Click		✓		✓	
Auto XON/XOFF		✓		✓	
U.S./U.K. Char. Set		✓		✓	✓
Autowrap		✓		✓	✓
New Line		✓		✓	✓
Local Echo		✓		✓	✓
Parity		✓		✓	
Parity Sense		✓		✓	
Bits Per Character		✓		✓	
Refresh Rate		✓		✓	
Transmit Speed		✓			
Receive Speed		✓			
Answerback		✓	Special sequence required to change feature.		

By following the steps listed in Section 3.2.1.3, SET-UP features may be changed to suit the preference of a particular operator, and to achieve terminal compatibility with the host computer.

After changing any or all of the SET-UP features, and exiting SET-UP mode, the VISUAL 100 will function per the new configuration. Please note that the new configuration of SET-UP features is selected on a temporary basis only. The SET-UP features initially displayed are still stored in the non-volatile RAM memory and are remembered by the terminal. The VISUAL 100 will recall and function per this fixed configuration when; the terminal is reset, the terminal is powered-down then powered-up, or a RECALL operation is performed. (See Section 3.2.1.4 for a discussion of the RECALL operation, see Section 3.2.1.6 for a discussion of the RESET operation.)

If, after changing SET-UP features, it is desired to store the new SET-UP configuration, a SAVE operation must be performed. (See Section 3.2.1.5 for a discussion of the SAVE operation.)

3.2.1.4 Performing a RECALL Operation

The stored SET-UP features may vary from the SET-UP features currently selected. If it is desired to return to the stored features, the RECALL operation should be performed per the following:*

1. Enter SET-UP mode
2. Depress the SHIFT and R keys simultaneously. The screen will be cleared. After a few seconds the terminal will return to SET-UP A mode.

3.2.1.5 Performing a SAVE Operation

The SAVE operation is used to store all current SET-UP features, and is performed per the following:

1. Enter SET-UP mode
2. Depress the SHIFT and S keys simultaneously. After a few seconds the terminal will return to SET-UP A mode.

After performing the SAVE operation the current SET-UP features will be stored. To select SET-UP features temporarily, *do not* use the SAVE operation, simply exit SET-UP mode after changing the features.

*Resetting or powering-down the terminal will also cause the SET-UP features to return to those stored.

3.2.1.6 Performing a RESET Operation

The RESET operation has the same effect as powering-down then powering-up the terminal and is used to run the self-test and return the SET-UP features to their fixed states. This operation will **also clear the screen** of any data. The RESET operation is performed per the following:

1. Enter SET-UP mode
2. Depress the  key on the keyboard. The terminal will reset and return to all initialized parameters and fixed SET-UP features.

3.2.2 SET-UP Feature Definitions

This section describes each SET-UP feature and the effect of each feature on the VISUAL 100.

3.2.2.1 Line/Local

On-line or local operation may be selected in either SET-UP A or SET-UP B mode by depressing the  key. On-line operation is indicated by the illumination of the ON-LINE LED. When On-line the terminal may send and receive data from the host computer.

Local operation is indicated by the illumination of the LOCAL LED. When in Local, the terminal is electrically disconnected from the host computer. Any data entered at the keyboard is looped back through the terminal receiver and displayed on the screen.

3.2.2.2 Characters Per Line

The VISUAL 100 may display a screen format of either 24 lines of 80 characters, or 24 lines of 132 characters. When changing between the 80/132 column formats, the contents of the screen are destroyed.



Characters per line may also be changed by the host, see Section 5.3.2.12.

NOTE

If double width characters are used, the number of characters per line is halved i.e., a 132 column format used in conjunction with double width characters provides for 66 double-width characters per line.

3.2.2.3 TABS



In SET-UP A mode, the location of each tab stop is indicated by a "T". All tab stops may be cleared by depressing the  key or tab stops may be cleared individually. To set or clear a stop on an individual basis, the following procedure should be followed:

1. Position the cursor under the tab stop to be set or cleared.
2. Depress the  key to set/clear the tab stop at the cursor location. Subsequent depressions of the  key will alternately set/clear the tab stop at the cursor location.

Tab stops may also be set and cleared by the host computer, see Section 5.3.2.8.

3.2.2.4 Screen Brightness

Screen brightness may be adjusted up or down, in either SET-UP A or SET-UP B mode.

Screen brightness is increased by depressing the  key, and decreased by depressing the  key.

3.2.2.5 ANSI/VT-52*

The VISUAL 100 operates according to two different programming standards – American National Standards Institute (ANSI) and VT-52. In ANSI Mode, the VISUAL 100 will generate and respond to control codes and control sequences as defined in ANSI standard X3.64, 1977. In VT-52 Mode, the VISUAL 100 is compatible with the DEC VT-52 terminal. The control sequences associated with each programming standard are discussed in Section 5.

ANSI/VT-52 Mode may also be changed by the host computer, see Section 5.3.2.12.

3.2.2.6 Smooth/Jump Scroll

Scrolling of data on the screen may take place in one of two ways; smooth scroll or jump scroll.

Jump scroll is the traditional scrolling method whereby lines of data move *one line* at a time to make room for new lines of data entered on the screen.

Smooth scroll is a scrolling method whereby lines of data move a *scan line* at a time to make room for new lines of data entered on the screen. Smooth scroll is a human engineering feature which allows scrolling lines of data to be more easily read by an operator.

Smooth/Jump scroll may also be changed from the host computer, see Section 5.3.2.12.

*VT-52 is a trademark of Digital Equipment Corporation.

NOTE

In some applications enabling smooth scroll may necessitate a baud rate limitation. To ensure that no data is lost, the Auto XON/XOFF feature should be enabled and supported by the host computer when using smooth scroll, see Section 3.2.2.12.

3.2.2.7 Autorepeat

When enabled, the autorepeat feature allows each key to generate its' code at a rate of 30 times per second, when the key is depressed for more than 0.75 seconds. All keys will be auto-repeating except for ESC, NO SCROLL, RETURN, TAB, and CTRL with any key, when autorepeat is enabled. When autorepeat is disabled, each key will generate its code once per key depression.

Autorepeat may also be selected by the host computer, see Section 5.3.2.12.

3.2.2.8 Screen Presentation

This feature allows characters to be formed by white dots on a black background or black dots on a white background.

Screen presentation may also be changed by the host computer, see Section 5.3.2.12.

3.2.2.9 Cursor Selection

The cursor marks the point where the next character will be entered on the screen and may be defined to be either a blinking block or a blinking underline.

3.2.2.10 Margin Bell

When enabled, this feature allows a warning bell to be sounded when the cursor is eight characters from the end of the current line. When disabled no warning bell will be sounded.

3.2.2.11 Keyclick

When enabled, this feature provides for an audible keyclick tone to be generated by the VISUAL 100 every time a code-generating key is depressed. When disabled, no audible tone will be sounded to indicate the generation of a code by key depression.

3.2.2.12 Auto XON/XOFF

This feature allows the VISUAL 100 to automatically generate the XOFF (DC3) and XON (DC1) synchronization codes to make sure data transmitted from the host computer is not lost. When enabled, this feature will cause the XOFF code to be transmitted when; the receive FIFO buffer is almost full, the NO SCROLL key is depressed, SET-UP mode is entered, or CTRL-S is depressed.



The XON code will be automatically transmitted to resume host transmission when; the receive FIFO buffer is almost empty, the NO SCROLL key is depressed again, SET-UP mode is exited, or CTRL-Q is depressed.

NOTE

The host computer must respond to XON/XOFF protocol for the Auto XON/XOFF feature to be effective.

3.2.2.13 U.K./U.S. Character Set

This feature determines whether the VISUAL 100 will operate with a United States or United Kingdom character set. The only difference between the two sets is one character.

When the U.S. set is enabled, the  key (shifted) and octal code 043 will cause display of the # character. When the U.K. set is enabled, the  key (shifted) and octal code 043 will cause display of the £ character.

U.S./U.K. character set is also host computer selectable, see Section 5.3.2.9.

3.2.2.14 Autowrap

This feature determines whether the cursor will automatically advance to the first position of the next line upon entering a character into the last position of the current line. When enabled, the cursor will wraparound automatically and enter the character on the first position of the new line. When disabled, the cursor will remain in the last column and any successive characters entered will overlay the last character on the line.

Autowrap may also be selected by the host computer, see Section 5.3.2.12.

3.2.2.15 New Line

When enabled, the New Line feature will cause the RETURN key to generate the CR and LF codes, and a received LF causes a new line function to be performed. When disabled, the RETURN key generates only the CR code, and a received LF causes only a line feed to be performed.

New Line may also be selected by the host computer, see Section 5.3.2.12.

3.2.2.16 Local Echo

The Local Echo feature provides for an automatic “echoing” of transmitted data back to the screen. If an echoing of transmitted data is not desired, or the host computer or modem provides an echo, this feature should be disabled.

Local Echo may also be selected by the host computer, see Section 5.3.2.12.

3.2.2.17 Parity

The Parity feature provides a check for errors in host transmitted data. When this feature is enabled, the VISUAL 100 will check received data for correct parity (odd or even) and generate parity on transmitted data. If a character is received with incorrect parity, a



will be placed on the screen in place of the error character.

3.2.2.18 Parity Select

The Parity Select feature determines whether an odd or even parity checking scheme will be utilized. If the Parity feature is disabled, the Parity Select feature will be disregarded.

3.2.2.19 Bits Per Character

This feature determines whether each transmitted character will contain 7 or 8 data bits. When enabled, this feature will cause 8 bit characters to be transmitted with bit #8 (L.S.B.) always set to space (Ø). When disabled, each transmitted character will contain 7 data bits. See Figure 2-1 for possible byte configurations.

3.2.2.20 Refresh Rate

50 and 60 H_z refresh-rate capability is built into the basic unit and is determined by this feature. When this feature is OFF, 60 H_z is selected, when ON, 50 H_z is selected.

3.2.2.21 Transmit Speed

This feature is used to select one of the 16 available transmit baud rates. When in SET-UP B mode, each depression on the  key will cause the terminal to step through and display the various transmit baud rates until the desired transmit speed is reached.

3.2.2.22 Receive Speed

This feature is used to select one of 16 available receive baud rates. When in SET-UP B mode, each depression of the  key will cause the terminal to step through and display the various receive baud rates until the desired receive speed is reached.

3.2.2.23 Answerback Message

The Answerback Message is set in a manner different from other terminal features. The Answerback Message will be automatically sent to the host computer upon request, (without affecting the screen), or whenever CTRL-BREAK is depressed. Answerback is set per the following procedure:

1. Enter SET-UP B mode.
2. Depress the SHIFT and A keys simultaneously. The terminal will display "A=" on the screen.
3. Enter the message terminator character. This character will not be part of the Answerback Message and may be any character not used in the Answerback Message.
4. Enter the Answerback Message which may be a maximum of 20 characters long, and may contain any ASCII characters including control codes. If control codes are part of the message, they will be displayed as  when entered.
5. Enter the message terminator character to end the Answerback Message.

After completing the above steps, the Answerback Message is selected on a temporary basis. The Answerback Message may be stored on a fixed basis, like any other SET-UP feature, by performing the SAVE operation.

4. KEYBOARD CONTROLS AND L.E.D.'S

This section describes the various keys and L.E.D. indicators on the VISUAL 100 keyboard and also describes the codes transmitted and effects of each key on the terminal. Please note that the effect of each key on the terminal may vary depending on the SET-UP features selected. For example, the current state of the ANSI/VT-52 feature will cause the codes transmitted by some keys to be different.

The VISUAL 100 keyboard is illustrated in Figure 4-1.

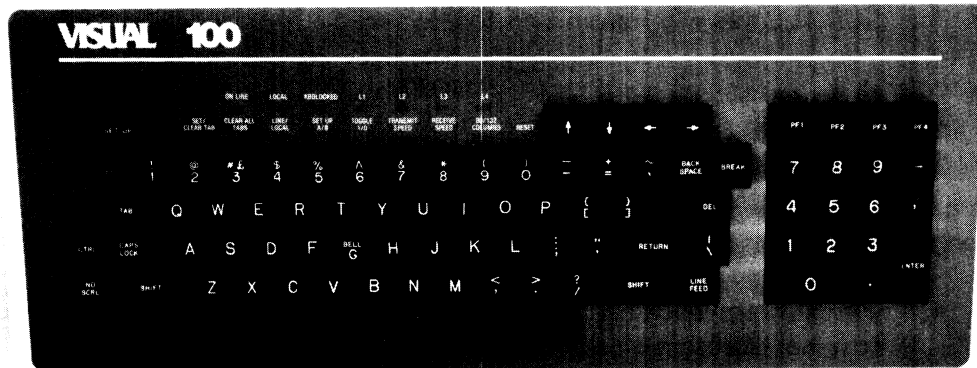

Figure 4-1 Visual 100 Keyboard Layout

NOTE

The actions taken by the various key depressions listed in this section, assume the transmitted code(s) are "echoed" back to the terminal. The transmitted codes can have no effect on the terminal unless echoed.

SET UP

This key is used to alternately enter and exit SET-UP mode. If the Auto XON/XOFF feature is enabled, this key will transmit the XOFF code (DC3) when SET-UP mode is entered, and transmit the XON code (DC1) when SET-UP mode is exited. If the Auto XON/XOFF feature is disabled, the SET-UP key will transmit no codes when entering/exiting SET-UP mode.

ESC

Depressing the ESC key will cause the terminal to transmit the ESC control code (octal 033). This code is used to initiate multi-code control sequences. Section 5.3 details all multi-code sequences and their effects on the terminal.

CTRL

The CTRL key does not produce a code by itself. It is depressed in conjunction with other keys to produce the control codes as described in Section 5.2.

SHIFT

The SHIFT key does not produce a code by itself. When depressed in conjunction with alpha-numeric keys, it causes transmission of the corresponding upper case alpha code or the code whose symbol appears on the upper part of the key. Two SHIFT keys are on the keyboard for operator convenience.

CAPS LOCK

The CAPS LOCK key does not produce a code when depressed. This key enables the transmission of only *upper case* alpha characters. The numeric and special keys are not affected by the CAPS LOCK key.

NO SCRL

The NO SCROLL key alternately transmits the XOFF (DC3) and XON (DC1) control codes, if the Auto XON/XOFF SET-UP feature is enabled. These codes are used to stop/start transmissions from the host computer, provided the host recognizes these codes. If the Auto XON/XOFF feature is disabled, the NO SCROLL key will transmit no codes.

NOTE

When the Auto XON/XOFF feature is enabled, the NO SCROLL key will be synchronized with the use of XON/XOFF codes generated by the terminal.

Example

- Host's transmission causes terminal's FIFO buffer to become almost full causing terminal to automatically transmit XOFF.
- If the operator now depresses the NO SCROLL key, no XOFF code is sent.
- Buffer empties, no XON sent.
- Operator depresses NO SCROLL, XON sent.

TAB

Depressing the TAB key causes transmission of the HT control code (octal 011), and causes the cursor to advance to the next tab stop.

BACK SPACE

Depressing the BACKSPACE key causes transmission of the BS control code (octal 010), and causes the cursor to move one position to the left.

RETURN

Depressing the RETURN key causes transmission of the CR control code (octal 015), and causes the cursor to move to the first column of the present line. If the New Line feature is enabled, the RETURN key will transmit the CR and LF control codes, and will cause the cursor to move to the first column of the next line.

LINE FEED

Depressing the LINEFEED key causes transmission of the LF control code (octal 012) and causes the cursor to move down one line.



Depressing the BREAK key causes a 250 millisecond spacing condition on the data-line. Depressing SHIFT-BREAK causes a 3.5 second spacing condition of the data-line and causes the Data Terminal Ready lead to go low for 3.5 seconds. Depressing CTRL-BREAK causes transmission of the Answerback Message.



Depressing the DELETE key causes the DEL code (octal 177) to be transmitted.



Depressing the SPACE BAR causes the SP code (octal 040) to be transmitted, and causes the character at the cursor location to be erased and the cursor advanced one position.



Depressing a cursor positioning key will cause the cursor to move one position in the direction indicated on the key. The codes transmitted by these keys will vary depending on whether ANSI or VT-52 mode is selected. Table 4-1 summarizes the codes transmitted for each key in both ANSI and VT-52 modes.

**TABLE 4-1
CODES TRANSMITTED BY CURSOR POSITIONING KEYS**

Key Depressed	Codes Transmitted		
	VT-52 Mode	ANSI Mode	ANSI Mode and Cursor Key Mode Set*
	ESC A	ESC [A	ESC O A
	ESC B	ESC [B	ESC O B
	ESC C	ESC [C	ESC O C
	ESC D	ESC [D	ESC O D

*See Section 5.3.2.12 for Cursor Key Mode definition



The four function keys labeled PF1 through PF4 send multi-code sequences that are usually interpreted by an application program. By using these keys, the number of keystrokes necessary by an operator to access commonly used functions is reduced to one.

The code sequences generated by these keys will vary depending on whether VT-52 or ANSI Mode is selected per Table 4-2.

TABLE 4-2
CODES TRANSMITTED BY FUNCTION KEYS

Key Depressed	Codes Transmitted	
	VT-52 Mode	ANSI Mode
PF1	ESC P	ESC O P
PF2	ESC Q	ESC O Q
PF3	ESC R	ESC O R
PF4	ESC S	ESC O S

Numeric Keypad:

A numeric keypad is provided as standard for applications requiring a high volume of numeric input, and is arranged in a familiar adding machine style. Depressing any numeric key will cause transmission of the corresponding numeric code. The ENTER key will function in a manner identical to the RETURN key on the main keyboard as previously described.

The keys on the numeric keypad may also be defined to send predetermined multi-code sequences when depressed by placing the VISUAL 100 in Alternate Keypad mode. When Alternate Keypad mode is entered, the code sequences transmitted by each key will vary depending on whether VT-52 or ANSI mode is selected. Table 4-3 illustrates the sequences transmitted by each key in both modes.

TABLE 4-3
CODES TRANSMITTED IN ALTERNATE KEYPAD MODE

Key Depressed	Codes Transmitted	
	VT-52 Mode	ANSI Mode
0	ESC ? p	ESC 0 p
1	ESC ? q	ESC 0 q
2	ESC ? r	ESC 0 r
3	ESC ? s	ESC 0 s
4	ESC ? t	ESC 0 t
5	ESC ? u	ESC 0 u
6	ESC ? v	ESC 0 v
7	ESC ? w	ESC 0 w
8	ESC ? x	ESC 0 x
9	ESC ? y	ESC 0 y
—	ESC ? m	ESC 0 m
,	ESC ? l	ESC 0 l
.	ESC ? n	ESC 0 n
ENTER	ESC ? M	ESC 0 M

*Keys Special
to SET-UP*

Mode: When SET-UP mode is entered, some keys on the main keyboard are used to change SET-UP features. Refer to Table 3-1 for a summary of each key and it's function in SET-UP mode.

LED

Indicators: The VISUAL 100 keyboard has seven L.E.D. indicators, four that are programmable, and three that have a predetermined meaning.

The ON LINE L.E.D. indicates the terminal is electrically connected to the host computer. The LOCAL L.E.D. indicates the terminal is not electrically connected to the host computer. The KBD LOCKED L.E.D. indicates the keyboard is locked and cannot be used to send data to the host computer.

5. TERMINAL PROGRAMMING

5.1 GENERAL

As previously noted, the VISUAL 100 operates according to two different programming standards – American National Standard Institute's (ANSI) X3.64 standard of 1977, and DEC'S VT-52. This section details the control codes and control sequence functions used to control the VISUAL 100 in both ANSI and VT-52 modes.

A reference card which summarizes all remote commands is located near the rear of the manual, and Appendices I, II, and III also summarize all remote commands.

5.2 CONTROL CODES

This section describes how the VISUAL 100 responds to received control codes. Control codes are defined as codes from columns one and two of the ASCII code chart and the DEL code (octal 177). Not all control codes have an effect on the VISUAL 100. The control codes that do have an effect on the VISUAL 100 are the same in ANSI and VT-52 modes and are listed in Table 5-1.

5.3 CONTROL SEQUENCE FUNCTIONS

This section describes how the VISUAL 100 responds to received Control Sequences. The section is broken down into two major segments – Control Sequences recognized in VT-52 mode and Control Sequences recognized in ANSI mode.

Control Sequences used to control the optional Buffered Printer Interface are not included in this section. See Section 6.

5.3.1 Control Sequences Recognized in VT-52 Mode

The VISUAL 100 will decode and respond to the following Control Sequences, when received in VT-52 mode.

Move Cursor Up, ESC A

This sequence causes the cursor to move up one line. If the cursor is positioned on the top line no action will occur.

Cursor Down, ESC B

This sequence causes the cursor to move down one line. If the cursor is positioned on the bottom line no action will occur.

Cursor Right, ESC C

This sequence causes the cursor to move right one position. If the cursor is positioned in the last column of a line no action will occur.

Cursor Left, ESC D

This sequence causes the cursor to move left one position. If the cursor is positioned in the first column of a line no action will occur.

TABLE 5-1
CONTROL CODE SUMMARY

Control Code	Octal Equivalent	Action
NUL (Control SP/Control @)	000	Ignored by terminal.
ENQ (Control E)	005	Initiates Answerback Transmission.
BEL (Control G)	007	Rings Bell.
BS (Control H)	010	Backspaces Cursor.
HT (Control I)	011	Advances cursor to next tab stop.
LF (Control J)	012	Cursor moves down one line, or down one line to the left hand margin (see Section 3.2.2.15).
VT (Control K)	013	Same as LF.
FF (Control L)	014	Same as LF.
CR (Control M)	015	Move cursor to first position of present line.
SO (Control N)	016	Enable G1 character set (see Section 5.3.2.8).
SI (Control O)	017	Enable G0 character set (see Section 5.3.2.8).
DC1 (Control Q)	021	XON code, signals terminal to start transmission.
DC3 (Control S)	023	XOFF code, signals terminal to stop transmission.
CAN (Control X)	030	Used to immediately abort an ESC sequence.
SUB (Control Z)	032	Same as CAN.
ESC (Control [)	033	Initiates escape functions.
DEL	177	Ignored by terminal.

Enter Graphics Mode, ESC F

This sequence causes the terminal to enter Graphics mode. When Graphics mode is entered, all received lower-case ASCII codes (octals 137-172) and the ASCII codes for {, |, } and ~ (octals 173-176) are displayed as graphic characters. Table 5-2 shows the graphic character associated with each ASCII code.

Exit Graphics Mode, ESC G

This sequence causes the terminal to exit Graphics mode.

Cursor Home, ESC H

This sequence causes the cursor to move to the home position (upper left-hand corner of the screen).

Reverse Line Feed, ESC I

This sequence causes the cursor to move up one line. If the cursor is positioned on the top line, the contents of the screen will scroll down one line.

Erase to End of Screen, ESC J

This sequence causes erasure of all data from the cursor position to the end of the screen.

Erase to End of Line, ESC K

This sequence causes erasure of all data from the cursor position to the end of the line.

Cursor Addressing, ESC Y

This sequence is used for positioning the cursor on an absolute basis. The next two codes following this sequence will be interpreted as the new line and column positions respectively. Table 5-3 shows the codes used for cursor addressing.

Identify, ESC Z

This sequence requests the terminal to verify that it is a VT-52 and is switched on and ready for communication. If this is the case, the terminal will respond with ESC/Z. If the terminal has the Printer Option installed, it will respond with ESC/M.

Enter Alternate Keypad Mode, ESC =

This sequence causes the terminal to enter Alternate Keypad mode. When entered, this mode causes keys on the numeric keypad to transmit special escape sequences as opposed to their regular codes. The code sequence generated by each Key is summarized in Table 4-3.

Exit Alternate Keypad Mode, ESC >

This sequence causes the terminal to exit Alternate Keypad mode.

Enter ANSI Mode ESC <

This sequence causes the terminal to enter ANSI mode.

TABLE 5-2
GRAPHIC CHARACTER SET

ASCII Code	Octal	Graphic	Desc.	ASCII Code	Octal	Graphic	Desc.
-	137		Blank	o	157	—	Bar at Scan 1
`	140	◆	Diamond	p	160	—	Bar at Scan 3
a	141	⋮	Checker Board	q	161	—	Bar at Scan 5
b	142	H _T	Horiz. Tab	r	162	—	Bar at Scan 7
c	143	F _F	Form Feed	s	163	—	Bar at Scan 9
d	144	C _R	Carriage Return	t	164	┌	T Left
e	145	L _F	Line Feed	u	165	┐	T Right
f	146	°	Degree	v	166	└	T Down
g	147	±	Plus or Minus	w	167	┘	T Up
h	150	N _L	New Line	x	170		Vert. Bar
i	151	V _T	Vert. Tab	y	171	≤	Less than or equal
j	152	└	Lower Right Corner	z	172	≥	Greater than or equal
k	153	┐	Upper Right Corner	}	173	π	Pi
l	154	┌	Upper Left Corner	:	174	≠	Not equal to
m	155	└	Lower Left Corner	}	175	£	Pound Sign
n	156	+	Intersect lines	~	176	•	Center Dot

TABLE 5-3
CURSOR ADDRESSING CODE CHART (VT52 Mode)

ASCII Char.	Oct.	Char. Pos.	Line No.	ASCII Char.	Oct.	Char. Pos.
SP	040	1	1	F	106	39
!	041	2	2	G	107	40
"	042	3	3	H	110	41
#	043	4	4	I	111	42
\$	044	5	5	J	112	43
%	045	6	6	K	113	44
&	046	7	7	L	114	45
'	047	8	8	M	115	46
(050	9	9	N	116	47
)	051	10	10	O	117	48
*	052	11	11	P	120	49
+	053	12	12	Q	121	50
,	054	13	13	R	122	51
-	055	14	14	S	123	52
.	056	15	15	T	124	53
/	057	16	16	U	125	54
0	060	17	17	V	126	55
1	061	18	18	W	127	56
2	062	19	19	X	130	57
3	063	20	20	Y	131	58
4	064	21	21	Z	132	59
5	065	22	22	[133	60
6	066	23	23	\	134	61
7	067	24	24	[135	62
8	070	25		^	136	63
9	071	26		-	137	64
:	072	27		`	140	65
;	073	28		a	141	66
<	074	29		b	142	67
=	075	30		c	143	68
>	076	31		d	144	69
?	077	32		e	145	70
@	100	33		f	146	71
A	101	34		g	147	72
B	102	35		h	150	73
C	103	36		i	151	74
D	104	37		j	152	75
E	105	38		k	153	76
				l	154	77
				m	155	78
				n	156	79
				o	157	80

5.3.2 Control Sequence Recognized in ANSI Mode

5.3.2.1 General

This section describes each control sequence recognized by the VISUAL 100 in ANSI mode. Many of the control sequences described in this section conform to the basic format, as specified by the ANSI X3.64 standard.

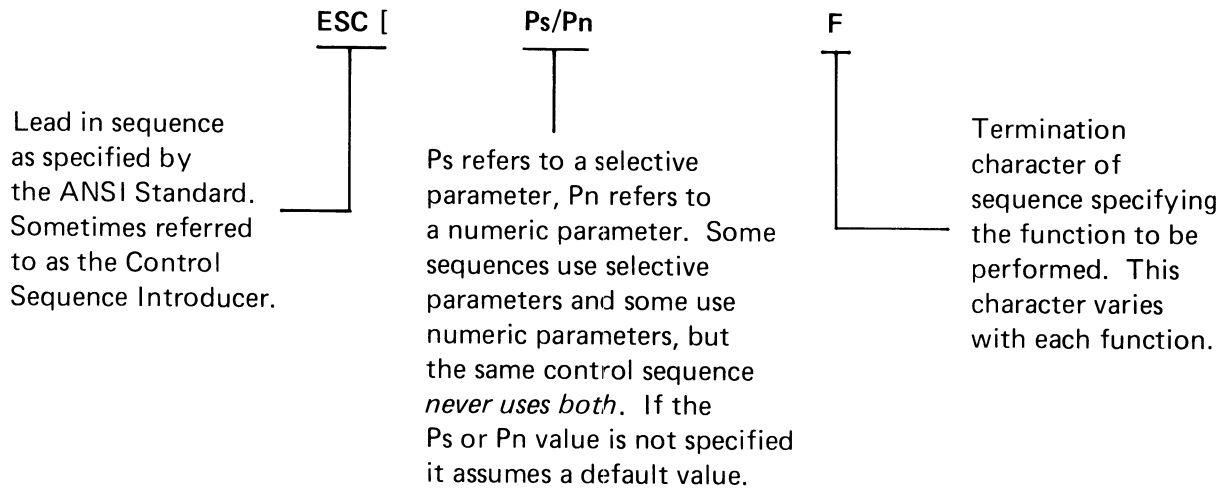

The following examples demonstrate the use of all three elements of the control sequence as specified by the ANSI X3.64 standard. Spaces are used for clarity only and are not part of the sequence.

Example 1: Control Sequence Using Numeric Parameter, Move Cursor up 6 lines

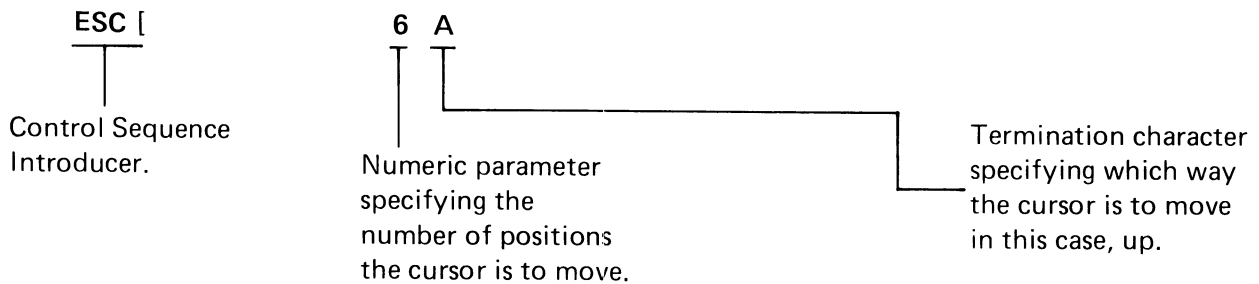

Example 2: Control Sequence Using Selective Parameter, Turn on Blink Attribute

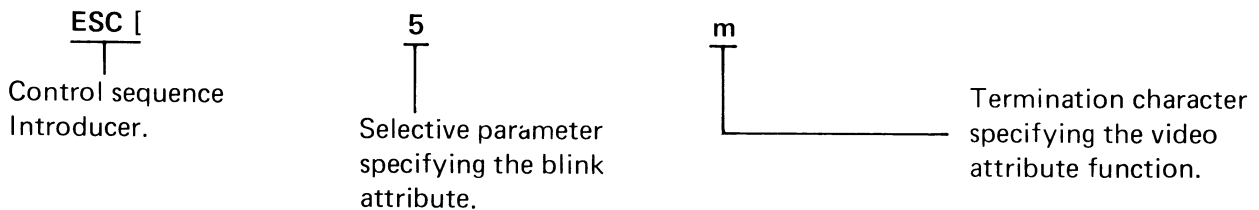

If multiple numeric or selective parameters are used in a control sequence, they must be separated with a semi-colon character.

Some of the control sequences described in this section are not specified in the ANSI X3.64 standard, but have been added to enhance the operational capabilities of the VISUAL 100 when in ANSI mode. The control sequences that are not actually specified in the X3.64 standard are noted as private control sequences.

5.3.2.2 Scrolling Region Command, ESC [x;y r(Private)

This command is used to set the top and bottom lines of the screen scrolling region. The lines on the screen are numbered 1-24. The first numeric parameter, *x*, sets the top boundary, and the second numeric parameter, *y*, sets the bottom boundary of the scrolling region. (Both numeric parameters are in decimal notation.) The default values are the entire screen, i.e., *x*=1 and *y*=24. The minimum size of the scrolling region is two lines. Once the scrolling region is defined the cursor positioning commands may move the cursor into but not out of the scrolling region.

5.3.2.3 Cursor Positioning Commands

The cursor positioning commands described in this section may cause a varying action depending on two factors: The defined scrolling region and the current state of Origin mode.

The user may define the scrolling region of the screen as described in Section 5.3.2.2. Once the scrolling region is defined, incremental cursor positioning commands (Up, Down, Right, Left) can position the cursor anywhere within the scrolling region, but cannot position the cursor outside of the scrolling region. The Absolute Cursor Positioning command remains unaffected by the screen scrolling region.

After the screen scrolling region is defined, a choice is provided for having line and column numbers on the screen dependent or independent of the defined scrolling region. For example, if line and column numbers are independent of the defined scrolling region, an received Absolute Cursor Positioning command with line and column parameters of 1, would position the cursor to the upper left-hand corner of the *screen*. If line and column numbers are dependent on the defined scrolling region, the aforementioned command would position the cursor to the upper left-hand corner of the *scrolling region*. Simply stated, the current state of Origin mode affects only the numbering of lines and columns on the screen and thus only the Absolute Cursor Positioning command.

Cursor Up, Down, Right, Left, ESC [Pn F

By using a single control sequence the cursor may be moved any number of increments up, down, right or left. The numeric parameter specifies how many increments the cursor is to move (default value is one) and the value of the termination character, *F*, determines the direction of movement as specified in Table 5-4.

TABLE 5-4
ANSI MODE CURSOR CONTROL COMMANDS

Command Name	"F" Value	Sequence
Cursor Up (Pn times)	A	ESC [Pn A
Cursor Down (Pn times)	B	ESC [Pn B
Cursor Right (Pn times)	C	ESC [Pn C
Cursor Left (Pn times)	D	ESC [Pn D

Absolute Cursor Positioning, ESC [x;y H, or ESC [x;y f

Either of the above control sequences may be used for positioning the cursor on an absolute basis. The above sequences will position the cursor to the line specified by x, and the column specified by y. Both the line and column parameters are in decimal notation and are numbered from 1-24 and 1-80 respectively. (When using 132 column format, columns are numbered 1-132). The default value for x and y is one. If an attempt is made to position the cursor past screen boundaries the cursor will move to the screen boundary.

Index, ESC D

This sequence causes the cursor to move down one position. If the cursor is positioned on the bottom line of the screen or the bottom of the screen scrolling region, the contents of the screen or scrolling region will scroll up one line.

Reverse Index, ESC M

This sequence causes the cursor to move up one position. If the cursor is positioned on the top line of the screen or the top of the screen scrolling region, the contents of the screen or scrolling region will scroll down one line.

Next Line, ESC E

This sequence causes the cursor to move to the beginning of the next line. If the cursor is positioned on the bottom line of the screen or the bottom of the screen scrolling region, the contents of the screen or scrolling region will scroll up one line.

NOTE

No action will occur if the Index/Reverse Index or Next Line commands are received while the cursor is positioned on top/bottom line of a screen that contains a scrolling region, if top/bottom line is not part of the scrolling region.

Save Cursor, ESC 7 (Private)

This sequence causes the cursor position, character set, and graphic rendition to be saved.

Restore Cursor, ESC 8 (Private)

This sequence causes restoration of the previously saved cursor position, character set, and graphic rendition.

5.3.2.4 Erasure Commands, ESC [Ps F

The same general control sequence format (ESC [Ps F) is used for all erasure commands. The termination character, "F", determines whether erasure will occur on a line or screen basis, and the selective parameter, Ps, determines the portion of the line/screen to be erased per Table 5-5. In all cases, erase functions cause no cursor movement.

**TABLE 5-5
ANSI MODE ERASE COMMANDS**

Erase Command Name	"F" Value	Ps Value	Sequence
From cursor to end of line.	K	0 or none	ESC [0 K
From beginning of line to cursor.	K	1	ESC [1 K
Entire line containing taining cursor.	K	2	ESC [2 K
From cursor to end of screen.	J	0 or none	ESC [0 J
From beginning of screen to cursor.	J	1	ESC [1 J
Entire screen.	J	2	ESC [2 J

NOTE

When erasing the screen, all lines completely erased will return to single width.

5.3.2.5 Character Size Commands (Private)

Characters may be formed on the screen (on a line by line basis) in three different sizes; single height-single width, double height-double width, or single height-double width. When using double size characters, the number of characters per line is halved.

All of the Character Size Commands are "Private", i.e., they are not specified in the ANSI X3.64 Standard.

Change Line to Single Height-Single Width, ESC #5

This command causes the line marked by the cursor to be single height-single width.

Change Line to Single Height-Double Width, ESC #6

This command causes the line marked by the cursor to be single height-double width. If the line was previously single height-single width, all characters from the middle of the line to the end of the line are lost. The cursor remains under the same character position, unless the character position is lost, in which case the cursor is moved to the right margin.

Change Line to Double Height-Double Width, ESC #3, ESC #4

These two commands are used as a pair, on adjacent lines, to form double height-double width characters. The same character must be sent to the same column of both lines to form each character. If the line was previously single height-single width, all characters from the middle of the line to the end of the line are lost. The cursor remains under the same character position, unless the character position is lost, in which case the cursor is moved to the right margin.

5.3.2.6 Video Attribute Commands

Data on the screen may be displayed in any combination of the following video attributes; High Intensity, Underline, Blink or Reverse Video.

The attributes are cumulative, i.e., received data will be displayed according to all attributes then enabled. The general control sequence format for enabling video attributes is:

ESC [Ps; Ps; Ps m.

Where Ps; Ps; Ps is the parameter string defining which video attributes to enable. If multiple video attributes are to be enabled with one control sequence, a semicolon is used to separate each selective parameter in the sequence.

Table 5-6 summarizes all video attributes and their associated selective parameters.

**TABLE 5-6
SUMMARY OF VIDEO ATTRIBUTES AND SELECTIVE PARAMETERS**

Attribute	Selective Parameter	Control Sequence
Attributes OFF	0 (default)	ESC [m
High Intensity	1	ESC [1 m
Underline	4	ESC [4 m
Blink	5	ESC [5 m
Reverse Video	7	ESC [7 m

Example:

Display on the screen the Blinking, Underlined word "NAME", then display on the screen the name "JONES" with no video attributes.

1. Turn on the Blink and Underline attributes with control sequence, ESC [4;5m or control sequences ESC [4m and ESC [5m.
2. Send the word "NAME" to the screen.
3. Turn off all attributes with the control sequence ESC [m (default value is 0).
4. Send the name "JONES" to the screen.

5.3.2.7 Programmable L.E.D. Commands, ESC [Ps; Ps Ps q (Private)

The four programmable L.E.D.'S may be turned ON/OFF by using the above control sequence, with the selective parameter(s) (Ps) listed below. When using multiple selective parameters in one sequence, they are separated by a semicolon.

Selective Parameters	Meaning
0 (Default)	Turn off all LEDS (L1-L4)
1	Turn on L1
2	Turn on L2
3	Turn on L3
4	Turn on L4

Example: Turn ON L.E.D.'S L1 and L4, ESC [1; 4 q

5.3.2.8 Tab Commands

Set Tab, ESC H

This command sets a tab stop at the current cursor location.

Clear Tab(s) , ESC [Ps g

This command is used with the appropriate selective parameter (Ps) to clear all tabs, or clear only the tab at the current cursor location per the following:

Selective Parameter	Meaning
0 (Default)	Clear tab at cursor location.
3	Clear all tabs.

5.3.2.9 Character Set Commands (Private)

The Character Set commands allow for remote selection of either the U.S. ASCII, U.K., or Graphics Character Sets. Commands are also provided for selection of Special Character Sets, however, the *standard* terminal does not incorporate the Special Character Sets.

Of the three character sets available (U.S., U.K., Graphics) the user may define any particular set as the G0 set and any particular set as the G1 set via the control sequences listed below. Once the G0 and G1 sets have been defined, they may be easily enabled via the S1 and S0 codes respectively. (Resetting the terminal will enable the G0 set.) The default state for the G0 and G1 character sets is U.S.

G0	G1	Character Set
ESC (A	ESC) A	U.K.
ESC (B	ESC) B	U.S.
ESC (Ø	ESC) Ø	Graphics
ESC (1	ESC) 1	Special
ESC (2	ESC) 2	Special

} Not used in standard Terminal.

NOTE

The Graphic set is shown in Table 5-2. The U.S./U.K. sets are described in Section 3.2.2.13.

5.3.2.10 Report Commands and Responses

The following is a list of host generated commands, and possible terminal responses:

Host Command Sequence	Terminal Response(s)	Sequence
1. What are you? ESC [c or ESC Z	VT100 with Advanced Video Option VT100 with Advanced Video and Printer Options	ESC [?1; 2 c ESC [?1; 3 c
2. What is Cursor Position? ESC [6 n	Cursor is positioned on line specified by PL, and column specified by PC. (default is 0) The line number is dependent on Origin mode.	ESC [PL; PC R
3. Is terminal O.K.? ESC [5 n	Terminal is O.K. Terminal is not O.K. (default value is 0)	ESC [0 n ESC [3 n
4. What are terminal parameters? ESC [1x or ESC [0x	Terminal will report terminal parameters per the selective parameters in Table 5-7 only <i>when requested</i> . Terminal may send unsolicited reports and will report terminal parameters per selective parameters in Table 5-7. (The terminal will never send unsolicited reports.)	ESC [s; p; n; x; r; c; fx

TABLE 5-7
SELECTIVE PARAMETERS ASSOCIATED WITH "REPORT TERMINAL
PARAMETERS" RESPONSE

Parameter	Possible Parameter Value(s)	Meaning
s	2	This message is a report. (s assumes a value of 2 in response to ESC [0x)
	3	This message is a report from the terminal, and the terminal reports on request from host <i>only</i> . (s assumes a value of 3 in response to ESC [1x).
p (Parity)	1	No Parity
	4	Odd Parity
	5	Even Parity
n (No. of bits)	1	8 bits per character
	2	7 bits per character
x (transmit speed) and r (receive speed)	0	50 baud
	8	75 baud
	16	110 baud
	24	134.5 baud
	32	150 baud
	40	200 baud
	48	300 baud
	56	600 baud
	64	1200 baud
	72	1800 baud
	80	2000 baud
	88	2400 baud
	96	3600 baud
	104	4800 baud
112	9600 baud	
120	19,200 baud	
c (Baud rate multiplier)	1	Baud rate multiplier is 6.
f	0	Reserved for future use.

5.3.2.11 Test Commands

Align Display, ESC #8 (Private)

This command causes the screen to be filled with upper-case E's, and is used for focus and alignment of the display.

Invoke Self Test, ESC [2; Ps y (Private)

This command is used to start one or more of the various self tests on the VISUAL 100. The selective parameter (Ps) indicates which test(s) is to be performed. The parameter value is arrived at by taking the weight of each test and adding them together. A parameter value of 0 causes a reset.

Test	Weight
Power-up check sum	1
Interface Test (Loop Back)	2 (Turn around plug needed)*
EIA Test	4 (Turn around plug needed)*
Repeat Tests until power-off	8

*See Appendix V for turn around plug.

5.3.2.12 Modes

This section describes the modes available when the VISUAL 100 is set for ANSI mode operation. Unlike the control sequences associated with ANSI mode commands, the control sequences associated with modes do not usually cause an action on the display but condition how the terminal will respond to commands.

Many of the modes described in this section are also selected and changeable in SET-UP mode. Thus the mode may be set or reset from the host or by the operator in SET-UP mode.

Table 3-1 details each SET-UP mode feature that is changeable from the host via set/reset mode control sequences.

Each mode has two possible states; set or reset. A single control sequence may set one or many modes, or reset one or many modes. Some of the modes described in this section are specified in the ANSI X3.64 standard, and some are private modes that have been added to enhance the operational capabilities of the terminal.

The control sequence format for setting/resetting modes will vary slightly depending on whether the mode is ANSI X3.64 specified, or private per the following.

ANSI X3.64 Format ESC [Ps; Ps . . . Ps h
for Set Mode

Private Format ESC [? Ps; Ps; . . . Ps h
for Set Mode

The only difference between the above set mode formats, is that the private format includes the question mark character(?) in the sequence. In both formats, ESC [is the control sequence introducer, (? is part of the sequences only in private modes) Ps; Ps; . . Ps is the parameter string specifying which modes are to be set, and h is the termination character specifying the Set Mode function. The control sequence formats for resetting modes are identical for to those for setting modes except for the termination character, ℓ, which specifies the reset mode function. The formats for resetting modes are:

ANSI X3.64 Format ESC [Ps; Ps; . . Ps ℓ
for Reset Mode

Private Format ESC [? Ps; Ps; . . Ps ℓ
for Reset Mode

Table 5-8 lists each mode applicable to the Set/Reset Mode control sequences and their associated selective parameters. Table 5-8 also indicates whether the mode is ANSI X3.64 specified or private.

**TABLE 5-8
SELECTIVE PARAMETERS ASSOCIATED WITH SET/RESET
MODE CONTROL SEQUENCES**

Mode	Selective Parameter (Ps)	Standard	
		ANSI X3.64	Private
New Line	20	X	
Local Echo	12	X	
ANSI/VT-52	2		X
Cursor Key	1		X
Character Per Line	3		X
Scroll	4		X
Screen Presentation	5		X
Origin	6		X
Autowrap	7		X
Autorepeat	8		X

New Line Mode, Ps = 20

Set Mode Sequence: ESC [20 h

Reset Mode Sequence: ESC [20 ℓ

When set, this mode causes the RETURN key to generate the CR and LF codes, and a received LF causes a new line function. When reset, the RETURN key generates CR and a received LF causes only line feed.

Local Echo Mode, Ps = 12

Set Mode Sequence: ESC [12 h

Reset Mode Sequence: ESC [12 ℓ

When set, this mode causes transmitted data to be echoed back to the screen within the terminal.

When reset no local echo will occur.

ANSI/VT-52 Mode, Ps = 2 (Private)

Set Mode Sequence: Not Applicable, use ESC <

Reset Mode Sequence: ESC [? 2 ℓ

When reset, this mode causes the VISUAL 100 to respond VT-52 Mode Control Sequences as defined in Section 5.3.1.

Cursor Key Mode, Ps = 1 (Private)

Set Mode Sequence: ESC [? 1 h

Reset Mode Sequence: ESC [? 1 ℓ

This mode is applicable only when the terminal is in ANSI *and* Alternate Keypad mode.

When set, this mode causes the cursor positioning keys to generate special escape sequences per Table 4-1.

When reset, the cursor position keys will transmit their normal ANSI mode sequences per Table 4-1.

Characters Per Line Mode, Ps = 3 (Private)

Set Mode Sequence: ESC [? 3 h

Reset Mode Sequence: ESC [? 3 ℓ

When set, this mode conditions the terminal for 132 column display.

When reset, the terminal will use 80 column display.

Scroll Mode, Ps = 4 (Private)

Set Mode Sequence: ESC [? 4 h

Reset Mode Sequence: ESC [? 4 ℓ

When set, this mode conditions the terminal for smooth scroll as defined in Section 3.2.2.6.

When reset, the terminal is conditioned for jump scroll as defined in Section 3.2.2.6.

Screen Presentation Mode, Ps = 5 (Private)

Set Mode Sequence: ESC [? 5 h

Reset Mode Sequence: ESC [? 5 ℓ

When set, this mode causes the screen to form characters by black dots on a white background.

When reset, the screen will form characters by white dots on a black background.

Origin Mode, Ps = 6 (Private)

Set Mode Sequence: ESC [? 6 h

Reset Mode Sequence: ESC [? 6 ℓ

When set, this mode causes line and column numbers to be dependent on the selected scrolling region.

When reset line and column numbers are independent of the selected scrolling region.

Autorepeat Mode, Ps = 8 (Private)

Set Mode Sequence: ESC [? 8 h

Reset Mode Sequence: ESC [? 8 ℓ

When set, this mode causes certain keys to be autorepeating per Section 3.2.2.7.

When reset, no keys will be autorepeating.

Autowrap Mode, Ps = 7 (Private)

Set Mode Sequence: ESC [? 7 h

Reset Mode Sequence: ESC [? 7 ℓ

When set, this mode will cause the cursor to automatically advance to the first position of the next line upon entering characters beyond the last position of the present line.

When reset, the cursor will not wraparound automatically. Any characters entered will overlay the last character on the line.

5.3.2.13 Reset Command, ESC c

This command causes the terminal to reset, and has the same effect as powering-down then powering-up the terminal.

5.3.2.14 Alternate Keypad Mode

Enter Alternate Keypad Mode, ESC =

This sequence causes the terminal to enter Alternate Keypad mode. When entered, this mode causes keys on the numeric keypad to transmit special escape sequences as opposed to their regular codes. The code sequence generated by each Key is summarized in Table 4-3.

Exit Alternate Keypad Mode, ESC >

This sequence causes the terminal to exit Alternate Keypad mode.

5.4 SYNCHRONIZATION

If the Auto XON/XOFF feature is enabled, the terminal will generate the XON/XOFF synchronization codes to assure no data transmitted from the host is lost. The terminal will generate the XOFF code (DC3) in response to the following conditions:

- Receive FIFO buffer becomes almost full.
- NO SCROLL key depressed.
- CTRL S keys depressed.
- Buffered printer interface FIFO almost full.

The terminal will generate the XON code (DC1) in response to the following conditions:

- Receive FIFO buffer becomes almost empty.
- NO SCROLL key depressed again.
- CTRL Q keys depressed.
- Buffered printer interface FIFO almost empty.

If the Auto XON/XOFF feature is not enabled, the terminal will generate the XOFF code *only* when CTRL-S is depressed, and generate the XON code *only* when CTRL-Q is depressed.

The Auto XON/XOFF feature assures no transmitted data will be lost, only if the host supports XON/XOFF and responds in a timely manner. If the host does not respond in a timely manner the FIFO buffer may be overrun causing lost data.

To determine if the buffer will overrun, the following formulas should be used.

No. of characters to overrun buffer = $32 - [3 \times (\text{receive rate} / \text{X-mit rate})]$

Time to respond to XOFF = $\frac{\text{No. of characters to overrun buffer} \times (\text{bits per character} + 2)}{\text{receive rate}}$

Example:

The VISUAL 100 is transmitting 8 bit characters at 1200 baud and receiving at 9600 baud. The terminal sends XOFF to the host to stop transmission. In this case, the time for the host to respond to XOFF is:

No. of characters to overrun buffer = $32 - [3 \times (9600 / 1200)] = 8$

Time to respond to XOFF = $8 \times (8 + 2) / 9600 = 0.008333$ seconds.

6. BUFFERED PRINTER INTERFACE OPTION

6.1 GENERAL

The buffered printer interface option allows the VISUAL 100 to be interfaced with a variety of serial printers via a 25-pin connector on the rear panel. Each connector pin is defined in Table 6-1.

The printer option incorporates the following key features:

- 128 Character FIFO Buffer.
- Independent Print/Communication Baud Rates.
- Independent Print/Communication Parity.
- 16 Print Baud Rate Selection.
- Printer Busy Monitored using XON/XOFF Protocol or Control Line.
- Printer Controller Mode.
- Auto Print Mode.
- Copy Mode.
- Print Line/Page from Keyboard or Remote.

**TABLE 6-1
PRINTER PORT PIN DESIGNATIONS**

Pin Number	Signal Name	Definition
1	AA	Protective Ground
2	BA	Receive Data (From Printer).
3	BB	Transmit Data (To Printer).
4		Printer Busy
5	CB	Clear to Send (always on).
6	CC	Data Set Ready (always on).
7	AB	Signal Ground
8	CF	Carrier Detect (always on).

When the printer option is installed, SET-UP mode is divided into 3 parts; SET-UP A, SET-UP B and SET-UP P.

When the printer option is not installed, SET-UP mode is divided into 2 parts; SET-UP A and SET-UP B. SET-UP A and B are used for determining terminal features as described in Section 3.2. SET-UP P is used for determining buffered printer interface features.

SET-UP P may only be entered from SET-UP B and is entered per the following:

1. Enter SET-UP A by depressing the SET-UP key.
2. Enter SET-UP B by depressing the

%
5

 key.
3. Enter SET-UP P by depressing the

%
5

 key again.

Subsequent depressions of the

%
5

 key will cause the terminal to step through SET-UP A, B and P.

Once the terminal enters SET-UP P mode, the screen will display a presentation like the one shown in Figure 6-1.

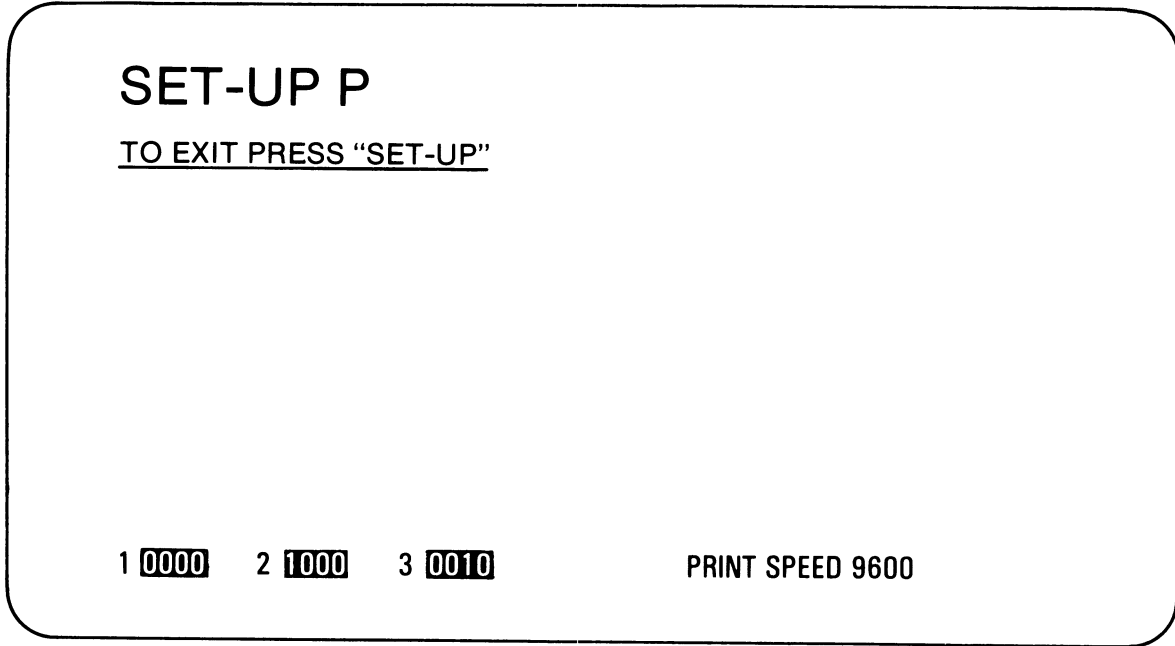

Figure 6-1 SET-UP P Presentation

This presentation shows which printer features are stored in non-volatile memory (per the summary in Figure 6-2) when the VISUAL 100 is shipped from the factory. These features may be recalled, changed and stored on a fixed basis, just like any of the SET-UP A or B features thus allowing printer features to power up to any desired configuration. Refer to Sections 3.2.1.1 through 3.2.1.6.

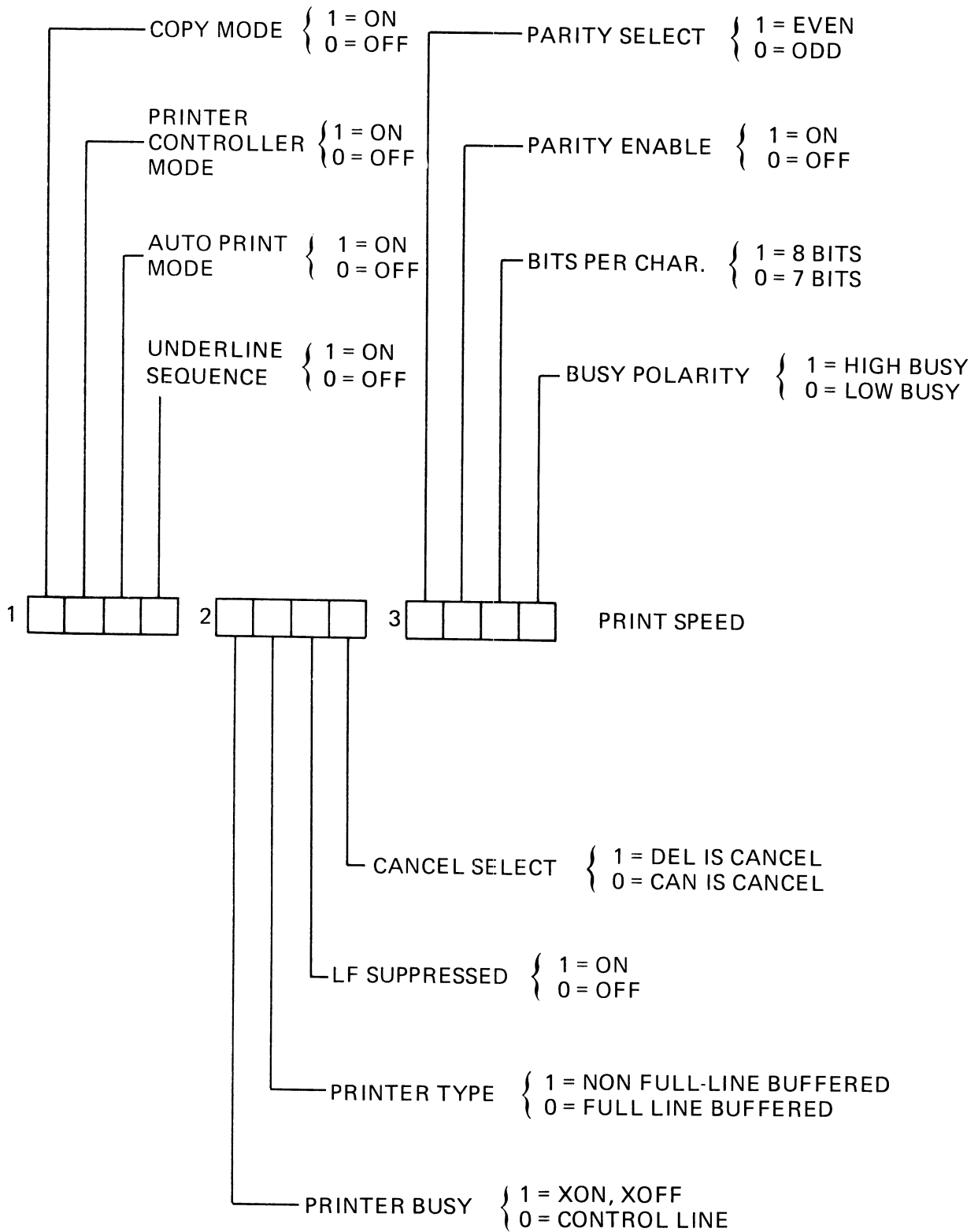

Figure 6-2 SET-UP P Summary

6.2 SET-UP P FEATURE DEFINITIONS

This section details each SET-UP P feature and their effects on the terminal and printer.

6.2.1 Copy Mode

The setting of this feature determines whether or not Copy mode is enabled. Copy mode is explained in Section 6.3.2.

NOTE

Resetting Copy mode will also reset Printer Controller mode.

6.2.2 Printer Controller Mode

The setting of this feature determines whether or not Printer Controller mode is enabled. Printer Controller mode is explained in Section 6.3.3.

NOTE

Setting Printer Controller mode will also set Copy mode. Resetting Printer Controller mode will also reset Copy mode.

6.2.3 Auto Print Mode

The setting of this feature determines whether or not Auto Print mode is enabled. Auto Print mode is explained in Section 6.3.4.

6.2.4 Underline Sequence

This feature is applicable to the Print Page Command only. When enabled, this feature causes underlined data on the screen to also be underlined on the printer. This is accomplished by sending the data character followed by the backspace character (BS) followed by the underline character to the printer for every underlined character on the screen.

When this feature is disabled only the characters on the screen will be sent to the printer when the Print Page function is initiated.

6.2.5 Printer Busy

The setting of this feature depends on how the attached printer indicates a BUSY condition to the terminal.

If the printer uses a printer busy control line to indicate a BUSY condition, this feature should be set to "0", the control line state. If the printer uses XON/XOFF to indicate a BUSY condition, this feature should be set to "1", the XON/XOFF state.

NOTE

The Auto XON/XOFF SET-UP feature must be enabled for the terminal to send XOFF/XON to the host when the printer is busy.

6.2.6 Printer Type

This feature applies to Printer Controller mode and Copy mode and determines whether or not the terminal will pass the code sequences for exiting these modes on to the attached printer.

When this feature is set to the OFF position, the ESC code sequences for exiting Printer Controller and Copy modes will be transmitted to the printer. The CANCEL SELECT feature will then append the CAN or DEL code to cancel the effect of the ESC code on the printer. This feature should be set to the OFF position for full-line buffered printers.

When this feature is set to the ON position, no codes in the sequences for exiting Printer Controller and Copy modes will be transmitted to the printer. Thus, the setting of the CANCEL SELECT feature is disregarded. This feature should be set to the ON position for FIFO buffered printers, or printers with no buffer at all.

6.2.7 LF Suppress

This feature determines whether or not LF codes received by the terminal are sent to the printer. In the ON state, no LF codes will be sent to the printer. In the OFF state, all LF codes will be sent to the printer. When this feature is set to the ON position, no codes in the sequences for exiting Printer Controller and Copy modes will be transmitted to the printer. Thus, the setting of the CANCEL SELECT feature is disregarded. This feature should be set to the ON position for FIFO buffered printers, or printers with no buffer at all.

The setting of this feature depends on how the attached printer reacts to received CR codes. Some printers perform a new line function (CR & LF) in response to the CR code. In this case, the LF Suppress feature should be enabled to prevent double line spacing on the printed data. Some printers perform only the carriage return function in response to the CR code. In this case, the LF Suppress feature should be disabled to allow LF codes to be sent to the printer.

6.2.8 Cancel Select

This feature applies to Printer Controller mode and Copy mode, (see Section 6.3.3) and determines whether the terminal will automatically append and transmit to the printer the CAN code or the DEL code immediately following the Control Sequence to exit Printer Controller mode, or exit Copy mode.

Select the CAN code if the printer interprets CAN as the "Cancel function", and select the DEL code if the printer interprets DEL as the cancel function. The cancel function causes the printer to erase its buffer.

6.2.9 Parity Select and Parity Enable

These two features determine if parity is enabled, and if it is, whether parity is odd or even.

Parity enable determines whether or not parity is enabled. Zero (0) corresponds to parity disabled and one (1) corresponds to parity enabled.

Parity select determines whether parity is odd or even. Zero (0) corresponds to odd parity and one (1) corresponds to even parity.

6.2.10 Bits per Character

This feature determines whether 7 or 8 data bits will be used for each character. If 8 bit code is elected, the most significant bit (bit#8) is always set to space (0).

6.2.11 Busy Polarity

This feature determines whether the terminal interprets the Printer Busy signal as a true high level or a true low level.

The setting of this feature depends on the printer being used. Some printers “swing” their Printer Busy lead high when busy and some printers swing their Printer Busy lead low when busy. Check your printer documentation for the correct setting of this feature.

6.2.12 Print Speed

PRINT SPEED indicates the rate that data will be transmitted to the attached printer.

The print speed is changed by depressing the

& 7

 key when in SET-UP P mode. The printer option provides for the same 16 baud rates as the communication interface (50 – 19,200 baud).

6.3 PRINTER COMMANDS AND MODES

This section describes the commands and modes used to control an attached printer. The commands and modes provided operate in identical fashion in both ANSI in VT-52 modes, however, the control sequences used for printer commands and modes will vary depending on whether VT-52 or ANSI mode is selected. In all cases, space suppression is performed on a line basis, i.e. all trailing spaces on each printed line are not transmitted to the printer. Embedded spaces on a line are always transmitted.

NOTE

Space suppression is not applicable in Printer Controller or Copy mode.

6.3.1 Print Line/Page Commands

The Print Line/Page commands may be initiated via remote command from the host or by the operator from the keyboard. When the Print Line/Page function is initiated the terminal will use the XON/XOFF synchronization codes. XOFF will be sent to the host upon initiation of a Print Line/Page function, and XON will be sent to the host on conclusion of the Print Line/Page function. Each line will be transmitted at the selected print rate and be ended with the CR/LF codes. (If LF suppress is enabled, only CR will be sent to the printer).

Table 6-2 summarizes the various ways to obtain hard copy via the Print Page/Line Commands.

6.3.2 Copy Mode

Copy mode allows a variable number of lines to be output to the printer and is available only when the terminal is in ANSI mode. When Copy mode is entered, all data received by the terminal will be sent to the screen and the printer simultaneously.

6.3.3 Printer Controller Mode

Printer Controller mode allows the host to pass all data through the terminal to the printer without affecting the terminal screen. In effect, the terminal acts as a controller for the printer by using the XON/XOFF synchronization codes to limit the transmitted data to a rate that the printer can accept.

6.3.4 Auto Print Mode

Auto Print mode allows a variable number of lines to be output to the printer in a manner consistent with the DEC VT-52 terminal. In most cases this mode will be used only when the VISUAL 100 terminal is operating in VT-52 mode. When Auto Print mode is entered, a received LF code causes the line containing the cursor to be output to the printer. Each line transmitted to the printer will be ended with the CR/LF codes or the CR code as the LF suppress feature dictates. The XON/XOFF synchronization codes will be used in Auto Print mode. See Table 6-2.

6.4 VISUAL 100 PRINTER OPTION, VERSION II

6.4.1 General

This section describes Version II of VISUAL's Serial Buffered Printer Interface Option. Version II has been developed for users who require a higher degree of compatibility with DEC's printer interface option than was offered with VISUAL's Version I Printer Option.

6.4.2 Version II Modes

There are three modes that concern the operation of the Version II Printer Option that do not appear in the Version I Option. These modes are:

6.4.2.1 Print Extent Mode

This mode affects the Print Page function only and provides a choice of printing the entire page or only the defined scrolling region whenever the Print Page function is initiated.

When reset, Print Extent mode conditions the Print Page function to print only data within the defined scrolling region. When set, Print Extent mode conditions the Print Page function to print the entire page.

Print Extent mode may be set or reset remotely via control sequence or from the keyboard in SET-UP P mode. To set/reset Print Extent mode from the keyboard the following procedure should be followed:

1. Depress the SET-UP key to enter SET-UP mode.
2. Depress the

%
5

 key twice to enter SET-UP P mode. Position the cursor over bit 1 of group 4. Depress the

^
6

 key to alternately set/reset Print

Extent mode. A one (1) corresponds to Print Extent mode set and a zero (0) to Print Extent mode reset.

To set/reset Print Extent mode remotely the following set/reset mode control sequences should be used:



Set Print Extent mode	ESC [19 h
Reset Print Extent mode	ESC [19 ℓ

6.4.2.2 Form Feed Mode

This mode affects the Print Page function only and provides a choice of automatically appending a FF control code at the end of a Print Page function or appending no code.

When reset, Form Feed mode conditions no code to be appended at the end of the Print Page function. When set, Form Feed mode conditions a FF control code to be appended at the Print Page function.

Form Feed mode may be set or reset remotely via control sequence or from the keyboard in SET-UP P mode. To set/reset Form Feed mode from the keyboard the following procedure should be followed:

1. Depress the SET-UP key to enter SET-UP mode.
2. Depress the  key twice to enter SET-UP P mode. Position the cursor over bit 2 of group 4. Depress the  key to alternately set/reset Form Feed mode. A one (1) corresponds to Form Feed mode set and a zero (0) to Form Feed mode reset.

To set/reset Form Feed mode remotely the following set/reset mode control sequences should be used:

Set Form Feed mode	ESC [18 h
Reset Form Feed mode	ESC [18 ℓ

6.4.2.3 Insert Replace Mode

This mode allows for the flexible insertion of characters. When set, Insert Replace mode causes the entry of displayable characters to be inserted at the cursor location after shifted existing data to the right to make room for the newly inserted characters. Any characters shifted past the end of the line are lost from memory. LED L3 will be ON to indicate the set state of Insert Replace mode.

When reset, normal data entry will occur and LED L3 will be OFF.

Insert Replace mode may be set or reset remotely via control sequence per the following:

Set Insert Replace mode	ESC [4 h
Reset Insert Replace mode	ESC [4 ℓ

6.5 ADDITIONAL COMMANDS

There are three commands that concern the operation of the Printer Option Version II that do not appear in the Version I Option. The commands are:

6.5.1 Insert Line(s), ESC [Pn L

This command causes Pn lines to be inserted starting at the cursor line. Pn is specified in decimal notation. The Insert Line command will push the current line and all lines below the current line down to make room for the newly inserted lines. Any lines pushed off the screen are lost from memory.

6.5.2 Delete Line(s), ESC [Pn M

This command causes Pn lines to be deleted starting at the cursor line. Pn is specified in decimal notation. The Delete Line command will delete the current line and Pn-1 lines below the current line. Lines below the deletion will move up to fill the gap created by the deletion.

6.5.3 Delete Character(s), ESC [Pn P

This command causes Pn characters to be deleted at the cursor location. Pn is specified in decimal notation. The Delete Character command will delete characters at and to the right of the cursor location with Pn-1 following characters shifting left to close the gap created by the deletion; no cursor movement will occur. The shifted character string is limited to the current line.

6.6 MODIFIED COMMANDS

There are two commands that have been modified on Version II Printer Option terminals. These commands are:

6.6.1 Identify Response

The terminal will respond with the following sequence whenever the host requests identity.

```
ESC [ ? 1 ; 11 c
```

This response is identifying the terminal as a VT100-AC (VT100 with printer option).

6.6.2 Report Terminal Parameters Response

The Report Terminal Parameters response is as follows:

```
ESC [ s ; p ; n ; x ; r ; c ; f ; m ; pp ; pn ; px ; pr x
```

The first seven parameters are as indicated in Table 5-7 of the VISUAL 100 Reference Manual. The last five parameters are additional parameters.

Parameter	Possible Parameter Values	Meaning
m (mode)	0	VT52 mode
	1	ANSI mode
pp (printer parity)	1	None
	4	Odd
	5	Even
pn (printer no. bits)	1	8 data bits
	2	7 data bits
px (printer xmit speed)		(See table 5-7)
pr (printer receive speed)		

TABLE 6-2
SUMMARY OF PRINT COMMANDS AND MODES

Function	From Keyboard	Remote		Action
		VT-52 Mode	ANSI Mode	
Print Page	SHIFT with ENTER	ESC]	ESC [i	XOFF code sent to host to suspend transmission. Contents of screen transmitted to printer with CR/LF codes or only CR after each line. XON code sent to host to resume transmission once Print Page function complete.
Print Cursor Line	Echoed Sequence	ESC V	ESC [? 1 i	XOFF code sent to host to suspend transmission. Contents of cursor line transmitted to printer with CR/LF codes or only CR after line. XON code sent to host to resume transmission once Print Line function complete.
Print Line "P"	Echoed Sequence	N.A.	ESC [? 1; Pi	XOFF code sent to host to suspend transmission. Contents of line "P" transmitted to printer with CR/LF codes or only CR after line. XON code sent to host to resume transmission once Print Line function complete. Line P is in decimal notation between the limits of 1 and 24.
Print Lines "P" to "Q"	Echoed Sequence	N.A.	ESC [? 1; P;Qi	XOFF Code sent to host to suspend transmission contents of lines "P" through "Q" transmitted to printer with CR/LF codes or only CR after each line. XON code sent to host to resume transmission once Print function complete. Line P and Q are both in decimal notation between the limits of 1 and 24.

TABLE 6-2
SUMMARY OF PRINT COMMANDS AND MODES (Cont.)

Function	From Keyboard	Remote		Action
		VT-52 Mode	ANSI Mode	
Enter Copy Mode	Echoed Sequence or change in SET-UP P	Copy mode not available in VT-52 mode.	ESC [? 7 i	Received data displayed on screen and sent to printer simultaneously. XOFF code sent to host in response to printer busy. XON code sent to host in response to printer not busy.
Exit Copy Mode	Echoed Sequence or change in SET-UP P	N.A.	ESC [? 6 i	Terminal exits Copy mode and automatically appends the CAN or DEL code as the CANCEL SELECT feature dictates. If the PRINTER TYPE feature is ON, no code will be appended.
Enter Printer Controller Mode	Echoed Sequence or change in SET-UP P	ESC W	ESC [5 i	Data sent from host passed through terminal to printer. XOFF code sent to host in response to printer busy. XON code sent to host in response to printer not busy.
Exit Printer Controller Mode	Echoed Sequence or change in SET-UP P	ESC X	ESC [4 i	Terminal exits printer Controller mode, and automatically appends the CAN or DEL code as the CANCEL SELECT feature dictates. If the PRINTER TYPE feature is ON, no code will be appended.
Enter Auto Print Mode	CONTROL with ENTER or change in SET-UP P	ESC ^	ESC [? 5 i	On receipt of LF code XOFF code sent to host. Contents of line transmitted to printer with CR/LF or only CR after-line. XON code sent to host after line is transmitted.
Exit Auto Print Mode	Control with P or change in SET-UP P.	ESC —	ESC [? 4 i	Terminal exits Auto Print mode.

7. FIRST LEVEL MAINTENANCE

7.1 GENERAL

The Visual 100 terminal has been designed with subassembly exchange as the prime mode of service. Fault isolation is provided in this section to identify the failing subassembly. Unless otherwise noted the power cord should be disconnected before disassembly of the terminal. Hazardous voltages may be present.

7.2 TOP COVER

The removal of the top cover will allow the removal of the logic printed circuit board, removal of the TV monitor printed circuit board, and access to the AC terminal block allowing rewiring from 110 volts to 220 volts.

7.2.1 Top Cover Removal

Consult Figure 7-1 to locate the three screws which attach the top cover to the base at the rear. Loosen these screws and simply rotate top cover off by lifting at the rear of unit.

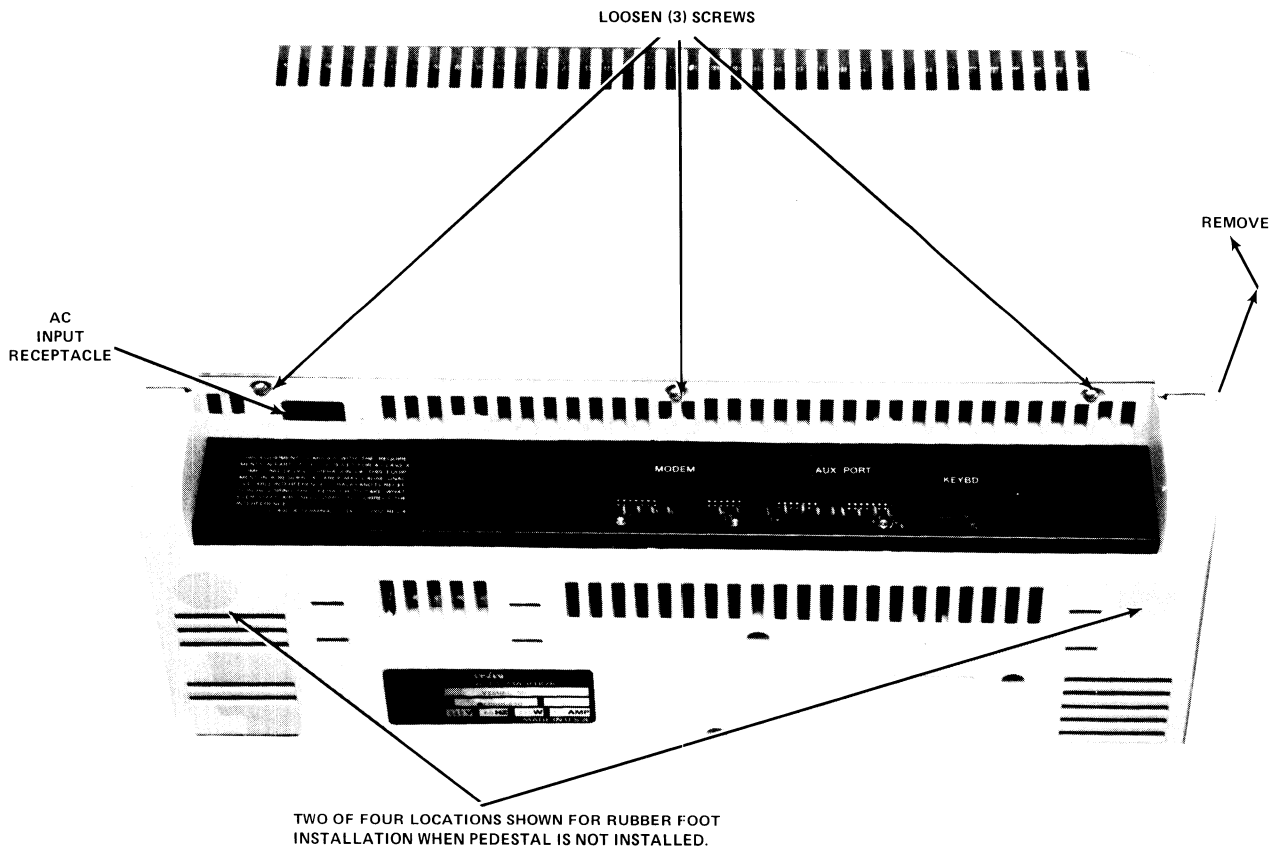

Figure 7-1. Top Cover Removal

7.3 PRINTED CIRCUIT BOARD REMOVAL AND INSTALLATION

Once the top cover has been removed, the main logic PCB may be removed by removing two screws shown in Figure 7-2, unplugging any modem cables and keyboard cable and by rotating the top of the PCB toward the rear while lifting it carefully out of the housing.

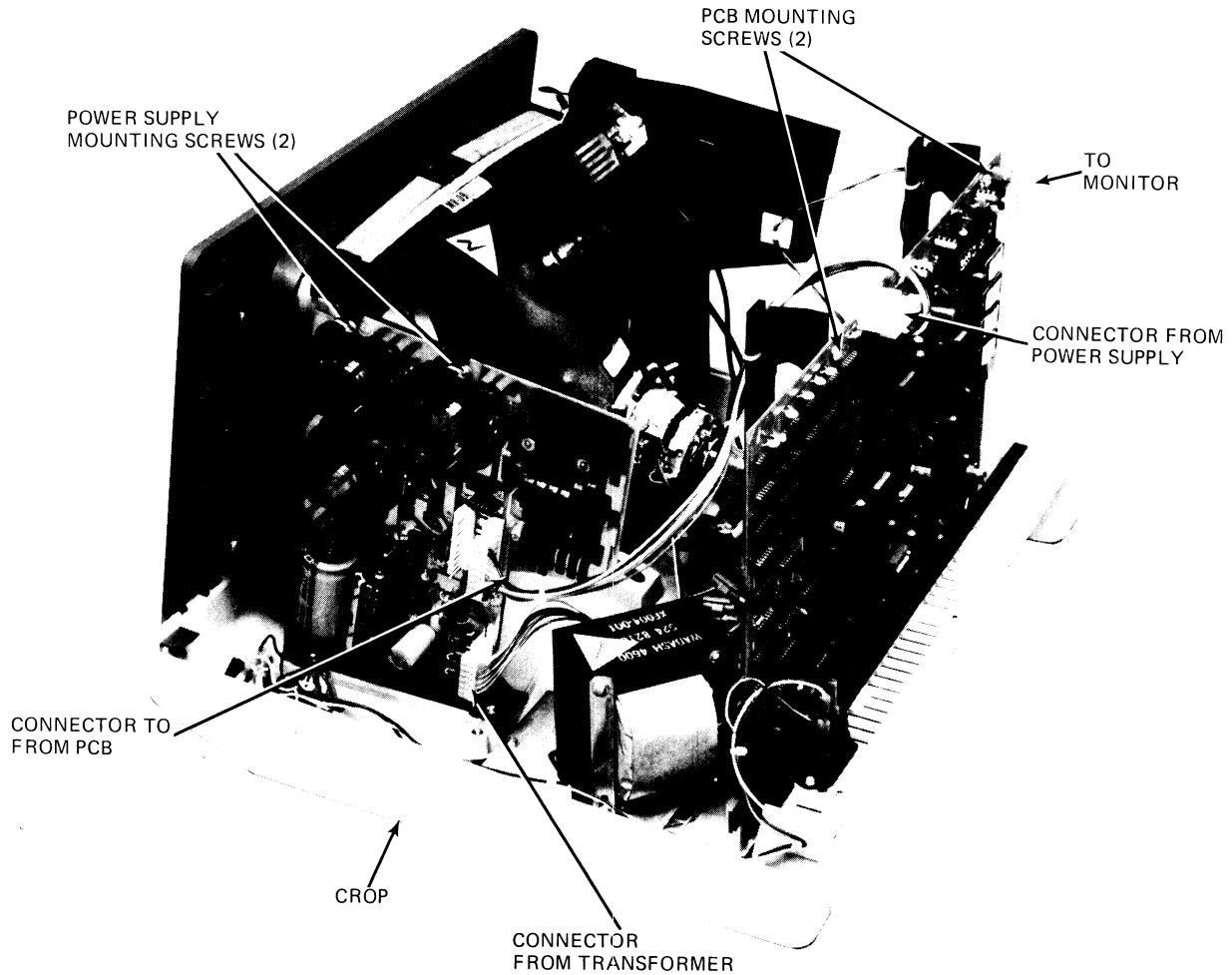

Figure 7-2. PCB Mounting

7.4 TV MONITOR PCB REMOVAL AND INSTALLATION

In order for the TV monitor PCB to be removed it is necessary to remove the rear panel and top cover, or remove the rear panel and the logic PCB. Disconnect the cable connecting the logic PCB and the TV PCB at the TV end. Disconnect the yellow and black connector and the blue and red connector connecting the TV PCB to the yoke from the TV PCB, and the flyback transformer cable from the TV PCB. Unplug the connector assembly from the end of the picture tube. Squeeze and disconnect the black wire at the top corner of the picture tube. Slightly tip the unit and squeeze and press four plastic standoffs extending through the base plate. Lower the unit onto its feet and remove the TV PCB. Remove the four plastic standoffs from the PCB by squeezing the locking tab and remove. Reinstall these four standoffs into the base plate.

Installing the TV PCB is accomplished by pressing the PCB into place on the four plastic standoffs, pressing the board until the locking tabs snap into place. Plug the CRT socket onto the CRT. Plug the flyback connector onto the board. Plug the yellow and black yoke connector onto the board adjacent to the two wire wound coils. Plug in the blue and red yoke connector into the other socket, and plug in the PCB edge connector. Connect the black wire from the CRT socket assembly onto the ground finger tab at the top front corner of the CRT. CAUTION When installing the yoke and flyback connectors observe orientation. Each of these connectors can be installed backwards. When they are installed backwards considerably more force is required.

7.5 CRT AND FLYBACK REMOVAL AND INSTALLATION

Before removing the picture tube it is necessary to discharge the tube. With an insulated handled screwdriver short out the high voltage lead to the tube. Carefully lift the top edge of the high voltage connector and insert the end of the screwdriver. Cause the screwdriver shaft to touch the sheet metal bracket and the contact of the high voltage connector simultaneously. The high voltage connector can now be removed by rocking it while pulling it up. Disconnect the yoke, ground wire, and the tube socket assembly as described in section 7.5. While holding the lower front edge of the picture tube in one hand, remove the four mounting screws, and remove the picture tube. The picture tube neck should not be subjected to any pressure or shock. Store the picture tube on its face. The flyback transformer can now be removed by unplugging it from the TV PCB and removing two mounting screws. When installing the picture tube install the lower two screws first. Insert the ground finger between the mounting bracket and the top picture tube mounting tab. Install the top two screws and connect the cables. Be sure that the black ground wire is installed!

7.6 TV MONITOR ADJUSTMENTS

Refer to Figure 7-3 for the location of the adjustments.

Enter SET-UP B and set light background screen (see Sec. 3-2).

Set full intensity by pressing and holding the ↑ key until the intensity no longer increases.

Brightness Control: Adjust it so that the raster lines are visible.

Horizontal Phasing Control: Adjust the phasing control so that the video area is centered horizontally within the raster area.

Brightness Control: Reduce the brightness until the raster just disappears.

Reduce the screen intensity using the ↓ key to a comfortable level.

Focus: Adjust the focus control for the best focus over the entire screen.

Set the terminal to local mode using the 4 key.

Enter ANSI mode.

Exit SET-UP mode by depressing the SET-UP key.

Fill the screen with E's by typing this sequence: ESC #8.

Vertical Size: Adjust so that the total height is 6.00 ± 0.25 inches (152.4 ± 6.4 mm).

Horizontal Size: Adjust so that the total width of the screen of data is 8.25 ± 0.25 inches (209.5 ± 6.4 mm).

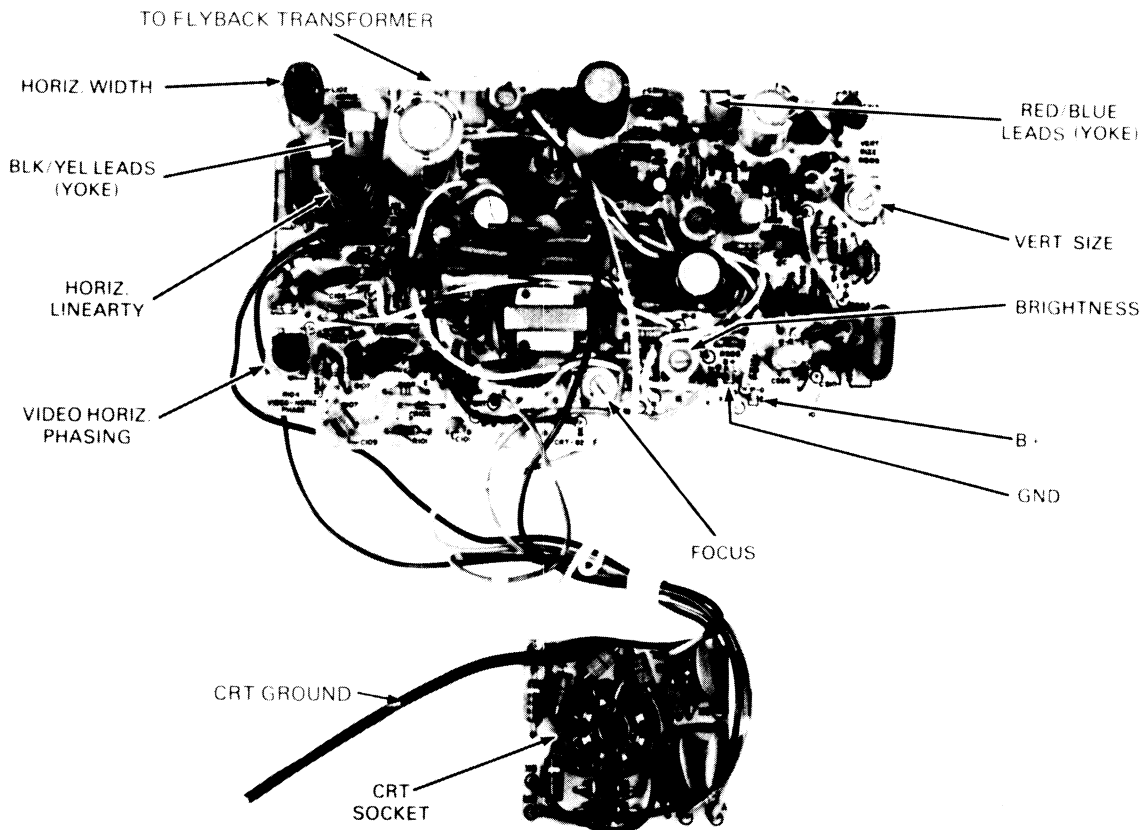

Figure 7-3 Location of TV Monitor Adjustments

7.7 110/220 VOLT SELECTION

Remove the rear panel and logic PCB. MAKE SURE THE LINE CORD IS DISCONNECTED! Refer to Figure 7-4 for new connection. 220 volt units are provided with two inputs, 220 volts nominal, and 250 volts nominal. The highest input resulting in satisfactory operation should be used.

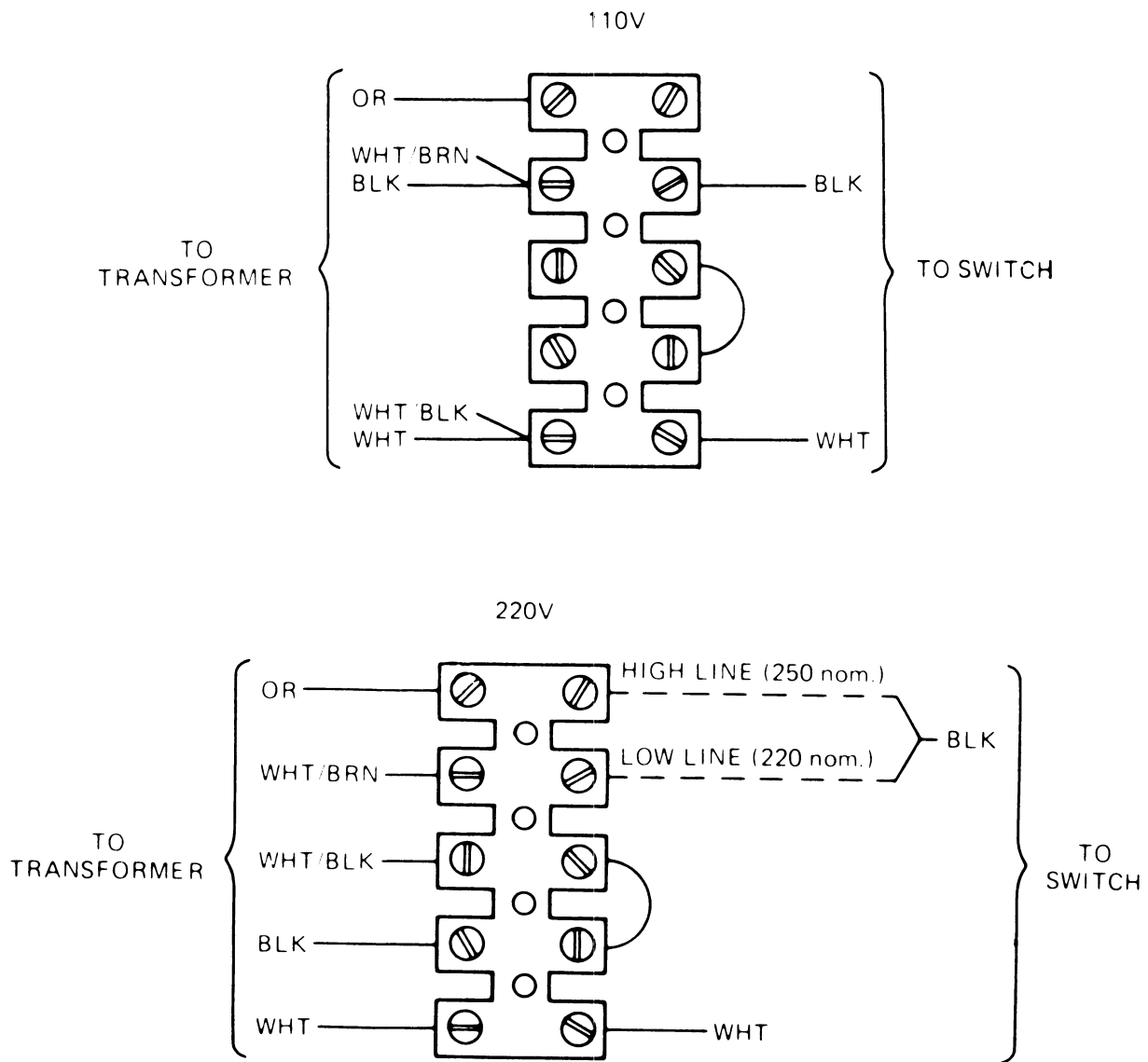

Figure 7-4 110/220 Volt Selection

7.8 TROUBLESHOOTING

7.8.1 Self Test

The Visual 100 contains a self test feature which is activated each time the terminal is turned on. When the terminal is turned on, the Local LED is illuminated, the RAM, the non-volatile RAM and the PROMs are checked. Upon successful completion, the bell is sounded once, the screen is initialized (cursor displayed), and either the Local or Line LED is illuminated depending upon which state was previously stored in the non-volatile memory.

7.8.2 Fault Isolation

Operation	Fault	Probable Cause	Remedy
Turn On	No line or Local LED	Keyboard not plugged in Line cord not plugged in Circuit Breaker tripped Defective Logic PCB	Plug in Plug in Reset Replace
Turn On	LED's other than Line or Local On or bell rings 5 times	Self test failure	Seat PROMs Replace Logic PCB
Self test complete	No Cursor	Brightness set too low TV cable disconnected	Adjust (SET-UP A, ↑ Key) Plug in
No cursor Bell sounds in local	No Cursor	Flyback disconnected CRT connector disconnected Defective TV PCB Defective Logic PCB	Plug in Plug in Replace Replace
No height	Horizontal line on TV	Yoke disconnected	Plug in yellow-black connector
No width	Vertical line on TV	Yoke disconnected	Plug in blue-red connector
Video tilted	Yoke adjustment	Yoke rotated from normal position	Adjust
Video size too small	TV monitor	Yoke moved too far back Vert. size adjustment Horiz. size adjustment	Adjust Adjust Adjust
Video jittering	Wrong Frequency	50/60 Hz. parameter incorrect	Set (SET-UP B)
Keyboard	No entry	Terminal On Line Defective keyboard Defective Logic PCB	Switch to Local Replace Replace
No data	Line or Local	Keyboard disconnected Defective keyboard Defective Logic PCB	Plug in Replace Replace

Operation	Fault	Probable Cause	Remedy
On Line	Parity errors	Wrong Data Rate Wrong Parity Wrong bits/char. Defective PCB	Set (SET-UP B) Set (SET-UP B) Set (Set-UP B) Replace
On Line or Local	Wrong Characters	Defective keyboard Defective Logic PCB	Replace Replace
On Line	EIA OK Current Loop doesn't work	Internal switches not set.	Set (see Table 2-2)
On Line	Control Function not Recognized	Defective PCB ANSI/VT52 Mode wrong	Replace Set (SET-UP B)
On Line or Local	Snapping sound	CRT ground wire not connected (Black wire)	Connect

APPENDIX I VISUAL 100 CONTROL CODES

ANSI AND VT-52 MODES	
ASCII Code	Function
NUL (Control SP/Control @)	Ignored by terminal.
ENQ (Control E)	Initiates Answerback Transmission.
BEL (Control G)	Rings Bell.
BS (Control H)	Backspaces Cursor.
HT (Control I)	Advances cursor to next tab stop.
LF (Control J)	Cursor moves down one line, or down one line to the left hand margin.
VT (Control K)	Same as LF.
FF (Control L)	Same as LF.
CR (Control M)	Move cursor to first position of present line.
SO (Control N)	Enable G1 character set.
SI (Control O)	Enable G0 character set.
DC1 (Control Q)	XON code, signals terminal to start transmission.
DC3 (Control S)	XOFF code, signals terminal to stop transmission.
CAN (Control X)	Used to immediately abort an ESC sequence.
SUB (Control Z)	Same as CAN.
ESC (Control [)	Initiates escape sequence functions.
DEL	Ignored by terminal.

APPENDIX II VISUAL 100 VT-52 MODE CONTROL SEQUENCES

Function	Sequence
Cursor Up	ESC A
Cursor Down	ESC B
Cursor Right	ESC C
Cursor Left	ESC D
Enter Graphics	ESC F
Exit Graphics	ESC G
Cursor Home	ESC H
Reverse Line Feed	ESC I
Erase to End of Page	ESC J
Erase to End of Line	ESC K
Cursor Addressing	ESC Y xy
Identify	ESC Z
Enter Alternate Keypad Mode	ESC =
Exit Alternate Keypad Mode	ESC >
Enter ANSI Mode	ESC <
Print Page	ESC J
Print Line	ESC V
Enter Printer Controller Mode	ESC W
Exit Printer Controller Mode	ESC X
Enter Auto Print Mode	ESC ^
Exit Auto Print Mode	ESC _

Note: The shade sequences are applicable only when the buffered printer interface option is installed.

APPENDIX III VISUAL 100 ANSI MODE CONTROL SEQUENCES

Function	Sequence	Function	Sequence
<u>CURSOR MOVEMENT COMMANDS</u>		<u>VIDEO ATTRIBUTE COMMANDS</u>	
Cursor Up	ESC [Pn A	Video Attributes OFF	ESC [m
Cursor Down	ESC [Pn B	High Intensity ON	ESC [1 m
Cursor Right	ESC [Pn C	Underline ON	ESC [4 m
Cursor Left	ESC [Pn D	Blink ON	ESC [5 m
Cursor Addressing	ESC [x;y f or ESC [x;y H	Reverse Video ON	ESC [7 m
Index	ESC D	<u>PROGRAMMABLE LED COMMAND</u>	
Reverse Index	ESC M	ESC [Ps q	
Next Line	ESC E	<u>TAB COMMANDS</u>	
Save Cursor	ESC 7	Set Tab	ESC H
Restore Cursor	ESC 8	Clear Tab	ESC [g
<u>SCROLLING REGION COMMAND</u>		Clear All Tabs	ESC [3 q
ESC [x;y r		<u>CHARACTER SET COMMANDS</u>	
<u>ERASE COMMANDS</u>		G0 Set is U.K.	ESC (A
From Cursor to End of Line	ESC [K	G1 Set is U.K.	ESC) A
From Beginning of Line to Cursor	ESC [1 K	G0 Set is U.S.	ESC (B
Entire Line	ESC [2 K	G1 Set is U.S.	ESC) B
From Cursor to End of Screen	ESC [J	G0 Set is Graphics	ESC (C
From Beginning of Screen to Cursor	ESC [1 J	G1 Set is Graphics	ESC) C
Entire Screen	ESC [2 J	<u>TEST COMMANDS</u>	
<u>CHARACTER SIZE COMMANDS</u>		Align Display	ESC # 8
Single-Height – Single-Width Line	ESC # 5	Invoke Self Test	ESC [2; Ps y
Single-Height – Double-Width Line	ESC # 6	(Use Combined Weight of Ps Values to Determine Test(s))	Ps = 1 = ROM/RAM Checksum
Double-Height – Double-Width Line (Top Half)	ESC # 3		Ps = 2 = Interface*
Double-Height – Double-Width Line (Bottom Half)	ESC # 4		Ps = 4 = EIA*
			Ps = 8 = Repeat Tests

*Turnaround connector required – See Appendix V.

**APPENDIX III (Cont'd)
VISUAL 100 ANSI MODE CONTROL SEQUENCES**

Function	Sequence	Function	Sequence
<u>STATUS COMMANDS AND RESPONSES</u>		<u>MODES (Cont'd)</u>	
What are you?	ESC [c or ESCZ	Set 132 Column Mode	ESC [? 3 h
Response is V100 with AV0 or V100 with AV0 and Printer Option	ESC [? 1 ; 2 c	Set 80 Column Mode	ESC [? 3 l
Is Terminal O.K.?	ESC [? 1 ; 3 c	Set Smooth Scroll Mode	ESC [? 4 h
Response is:	ESC [5 n	Reset Smooth Scroll Mode	ESC [? 4 l
Terminal is O.K.	ESC [0 n	Set Reverse Video	ESC [? 5 h
or Terminal not O.K.	ESC [3 n	Reset Reverse Video	ESC [? 5 l
What is Cursor Position?	ESC [6 n	Set Origin Mode	ESC [? 6 h
Response is:	ESC [x ; y R	Reset Origin Mode	ESC [? 6 l
What are Terminal Parameters?	ESC [1 x or ESC [0 x	Set Autorepeat Mode	ESC [? 8 h
Response is:	ESC [s ; p ; n ; x ; r ; c ; f x (See Table 5-7)	Reset Autorepeat Mode	ESC [? 8 l
<u>MODES</u>		Set Autowrap Mode	ESC [? 7 h
Set New Line Mode	ESC [20 h	Reset Autowrap Mode	ESC [? 7 l
Reset New Line Mode	ESC [20 l	Reset Terminal	ESC c
Set Local Echo Mode	ESC [12 h	Enter Alternate Keypad Mode	ESC =
Reset Local Echo Mode	ESC [12 l	Exit Alternate Keypad Mode	ESC >
Set VT-52 Mode	ESC [? 2 l	<u>PRINTER COMMANDS AND MODES</u>	
Set Cursor Key Mode	ESC [? 1 h	Print Page	ESC [I
Reset Cursor Key Mode	ESC [? 1 l	Print Cursor Line	ESC [? 1 I
		Print Line "P"	ESC [? 1 ; P I
		Print Lines "P" through "Q"	ESC [? 1 ; P ; Q I
		Enter Copy Mode	ESC [? 7 I
		Exit Copy Mode	ESC [? 6 I
		Enter Printer Controller Mode	ESC [5 I
		Exit Printer Controller Mode	ESC [4 I
		Enter Auto Print Mode	ESC [? 5 I
		Exit Auto Print Mode	ESC [? 4 I

Note: The shaded sequences are applicable only when the buffered printer interface option is installed.

*P and Q are in decimal notation within the limits on 1 to 24.

APPENDIX IV ASCII CODE CHART

					BIT 7	0	0	0	0	1	1	1	1
					BIT 6	0	0	1	1	0	0	1	1
					BIT 5	0	1	0	1	0	1	0	1
BIT 4	BIT 3	BIT 2	BIT 1	COL ROW	0	1	2	3	4	5	6	7	
0	0	0	0	0	NUL	DLE	SP	0	@	P			p
0	0	0	1	1	SOH	DC1	!	1	A	Q	a		q
0	0	1	0	2	STX	DC2	"	2	B	R	b		r
0	0	1	1	3	ETX	DC3	#	3	C	S	c		s
0	1	0	0	4	EOT	DC4	\$	4	D	T	d		t
0	1	0	1	5	ENQ	NAK	%	5	E	U	e		u
0	1	1	0	6	ACK	SYN	&	6	F	V	f		v
0	1	1	1	7	BEL	ETB	'	7	G	W	g		w
1	0	0	0	8	BS	CAN	(8	H	X	h		x
1	0	0	1	9	HT	EM)	9	I	Y	i		y
1	0	1	0	A	LF	SUB	*	:	J	Z	j		z
1	0	1	1	B	VT	ESC	+	;	K	[k		{
1	1	0	0	C	FF	FS	,	<	L	\	l		!
1	1	0	1	D	CR	GS	-	=	M]	m		}
1	1	1	0	E	SO	RS	.	>	N	^	n		~
1	1	1	1	F	SI	US	/	?	O	-	o		DEL

APPENDIX V TURN-AROUND CONNECTOR FOR INTERFACE TESTS

Turn-around Connector for Current Loop tests.

Switches 2,3,6 ON 4,5 OFF

7 17 18 25
└──┘ └──┘

Turn-around Connector for EIA tests.

Switches 1,2,3,4,5,6,7 OFF 8 ON

2 3 4 8 6 20
└──┘ └──┘ └──┘

VISUAL TECHNOLOGY INCORPORATED

540 MAIN STREET, TEWKSBURY, MA 01876, TELEPHONE (617) 851-5000, TELEX 951-539