

digital

# VT55-E, F, H, J DECgraphic Scope Users' Manual

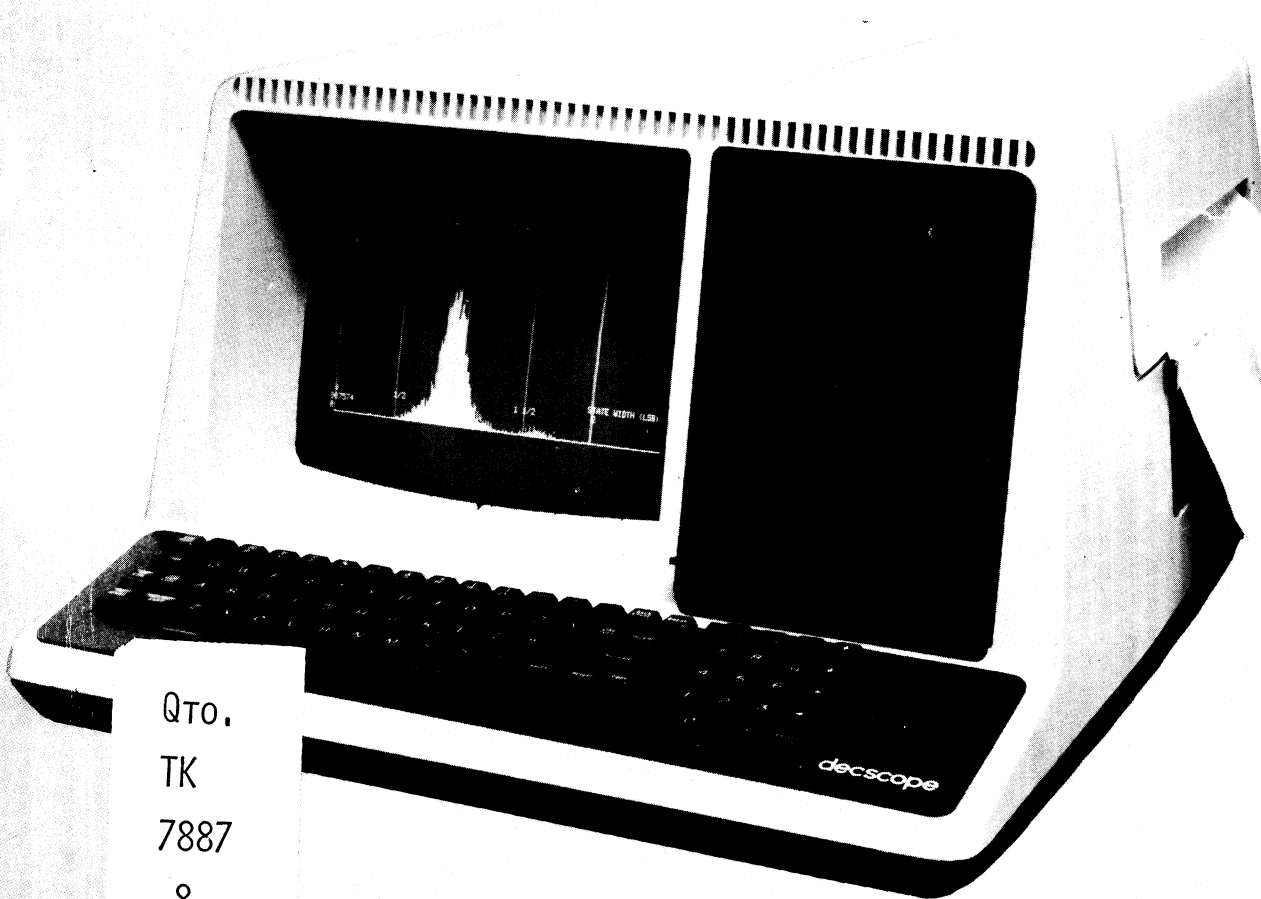

QTO.  
TK  
7887  
.8  
.T4D52  
1976  
1

digital

# VT55-E, F, H, J DECgraphic Scope Users' Manual

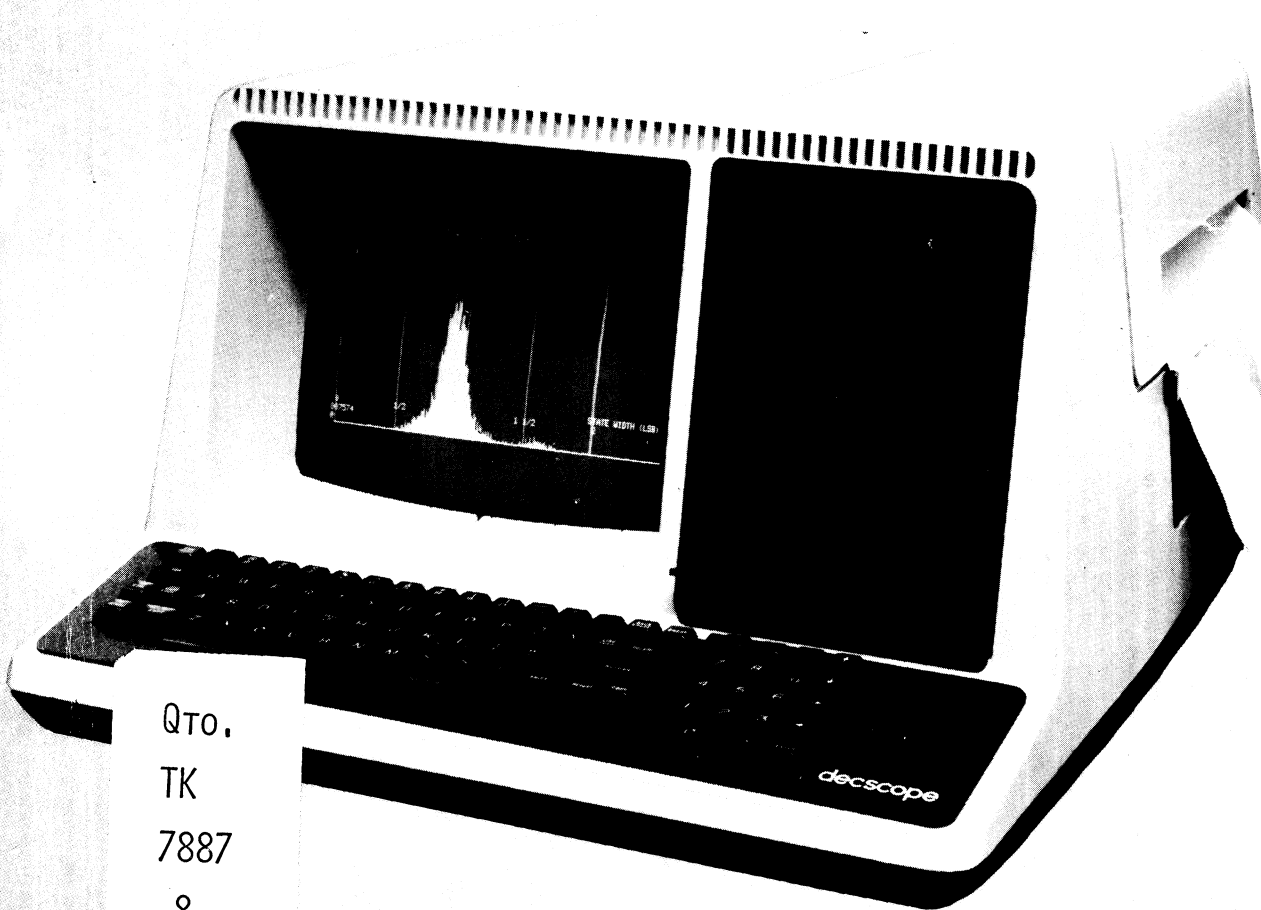

QTO.  
TK  
7887  
.8  
.T4D52  
1976  
1

# **VT55-E, F, H, J DECgraphic Scope Users' Manual**

REPRODUCED FROM THE ORIGINAL  
COPY IN THE DEC LIBRARY

Copyright © 1976 by Digital Equipment Corporation

The material in this manual is for informational purposes and is subject to change without notice.

Digital Equipment Corporation assumes no responsibility for any errors which may appear in this manual.

Printed in U.S.A.

This document was set on DIGITAL's DECset-8000 computerized typesetting system.

The following are trademarks of Digital Equipment Corporation, Maynard, Massachusetts:

DEC	DECtape	PDP
DECCOMM	DECUS	RSTS
DECsystem-10	DIGITAL	TYPESET-8
DECSYSTEM-20	MASSBUS	TYPESET-11
		UNIBUS



# CONTENTS

	Page	
<b>CHAPTER 1</b>	<b>INTRODUCTION</b>	
1.1	GENERAL DESCRIPTION . . . . .	1-1
1.2	HARDWARE DESCRIPTION . . . . .	1-3
1.2.1	VT55 Technology . . . . .	1-4
1.3	VT55 MODELS . . . . .	1-4
1.4	RELATED DOCUMENTS . . . . .	1-4
1.5	TECHNICAL CHARACTERISTICS . . . . .	1-6
1.5.1	Installation Characteristics . . . . .	1-6
1.5.2	Functional Characteristics . . . . .	1-7
1.5.3	Interface Characteristics . . . . .	1-8
1.6	VT55 OPTIONS . . . . .	1-8
<b>CHAPTER 2</b>	<b>SITE PREPARATION AND PLANNING</b>	
2.1	PURPOSE AND IMPORTANCE . . . . .	2-1
2.2	INSTALLATION SPACE . . . . .	2-1
2.3	OPERATING ENVIRONMENT . . . . .	2-2
2.3.1	Operating Temperature and Humidity . . . . .	2-2
2.3.2	Device Dissipation . . . . .	2-2
2.3.3	Electrical Noise Tolerance . . . . .	2-2
2.3.4	Vibration, Atmosphere, Altitude . . . . .	2-2
2.4	POWER REQUIREMENTS . . . . .	2-2
2.5	SIGNAL CABLES . . . . .	2-3
<b>CHAPTER 3</b>	<b>INSTALLATION</b>	
3.1	UNPACKING . . . . .	3-1
3.2	PRELIMINARY AND ACCEPTANCE TESTING . . . . .	3-1
3.3	MANUAL TESTING . . . . .	3-2
3.3.1	Miscellaneous Functions . . . . .	3-3
3.3.2	Graph Drawing Mode Functions . . . . .	3-5
3.3.3	Hold Display Mode Functions . . . . .	3-6
3.4	CONNECTING THE VT55 TO AN INTERFACE . . . . .	3-6
3.4.1	20 mA Interface Cable with Mate-N-Lok Connector . . . . .	3-7
3.4.2	20 mA Interface Cable with 283B Connector . . . . .	3-8
3.4.3	EIA Interface Cable . . . . .	3-9
3.4.4	Changing VT55 Interface Cables . . . . .	3-10
3.4.5	Setting the Baud Rate Switches . . . . .	3-10
3.4.6	Setting the Parity Switches . . . . .	3-10
3.5	SERIAL LINE SIGNAL FORMAT . . . . .	3-10
3.5.1	Word Length and Parity . . . . .	3-13
3.5.2	Baud Rate . . . . .	3-14
3.5.3	Levels . . . . .	3-14
3.5.4	Synchronization . . . . .	3-14
3.6	ADJUSTING VT55 NOMINAL LINE VOLTAGE . . . . .	3-16
3.7	CHANGING VT55 LINE FREQUENCY – NON-COPIER MODELS ONLY . . . . .	3-18

## CONTENTS (Cont)

	<b>Page</b>
<b>CHAPTER 4</b>	<b>TECHNICAL DESCRIPTION</b>
4.1	INTRODUCTION . . . . . 4-1
4.2	RASTER SCAN TECHNIQUE . . . . . 4-1
4.3	COMMUNICATING WITH THE VT55 . . . . . 4-1
4.3.1	Alphanumeric Mode . . . . . 4-2
4.3.2	Graphics Mode . . . . . 4-3
4.3.3	Graph Drawing . . . . . 4-3
4.3.4	Escape Mode and Special Terminal Commands . . . . . 4-4
4.3.5	VT55 Keyboard . . . . . 4-4
4.4	VT55 COPIER . . . . . 4-5
<b>CHAPTER 5</b>	<b>OPERATION AND PROGRAMMING</b>
5.1	INTRODUCTION . . . . . 5-1
5.2	OPERATION . . . . . 5-1
5.2.1	Powering on the VT55 . . . . . 5-1
5.2.2	VT55 Models with Internal Copier . . . . . 5-1
5.3	THE KEYBOARD . . . . . 5-4
5.3.1	Using the Keyboard . . . . . 5-4
5.3.1.1	ASCII Codes . . . . . 5-5
5.3.1.2	Shift Key . . . . . 5-5
5.3.1.3	CAPS LOCK Key . . . . . 5-5
5.3.1.4	REPEAT Key . . . . . 5-7
5.3.1.5	SCROLL and COPY Keys . . . . . 5-7
5.3.1.6	BREAK Key . . . . . 5-7
5.3.1.7	Auxiliary Keypad . . . . . 5-7
5.4	ALPHANUMERIC MODE . . . . . 5-8
5.4.1	Alphanumeric Cursor . . . . . 5-8
5.5	GRAPHIC MODE . . . . . 5-10
5.6	DISPLAY CALIBRATION SPECIFICATION . . . . . 5-11
5.6.1	Calibration of the Graph Drawing Field . . . . . 5-11
5.6.2	Alignment of Alphanumerics on the Graph Drawing Data Field . . . . . 5-12
5.6.3	Definition of Graph Marker on the Graph Drawing Data Field . . . . . 5-13
5.7	GRAPH DRAWING MODE . . . . . 5-14
5.7.1	Graph Drawing Command Characters . . . . . 5-14
5.7.2	Graph Drawing Data Characters . . . . . 5-14
5.7.3	Other Characters . . . . . 5-17
5.8	ESCAPE MODE . . . . . 5-17
5.8.1	Cursor Down . . . . . 5-17
5.8.2	Reverse Line Feed . . . . . 5-17
5.8.3	Cursor Up . . . . . 5-18
5.8.4	Cursor Right . . . . . 5-18
5.8.5	Cursor Home . . . . . 5-18
5.8.6	Direct Cursor Addressing . . . . . 5-18

## CONTENTS (Cont)

		Page
5.8.7	Erase to End of Line . . . . .	5-19
5.8.8	Erase to End of Screen . . . . .	5-19
5.8.9	Identify Terminal Type . . . . .	5-19
5.8.10	Enter Hold Screen Mode . . . . .	5-19
5.8.11	Exit Hold Screen Mode . . . . .	5-19
5.8.12	Enter Alternate Keypad Mode . . . . .	5-20
5.8.13	Exit Alternate Keypad Mode . . . . .	5-20
5.8.14	Copy Screen . . . . .	5-20
5.8.15	Enable Auto-Print Mode . . . . .	5-20
5.8.16	Disable Auto-Print Mode . . . . .	5-20
5.8.17	Enter Graphic Mode . . . . .	5-20
5.8.18	Exit Graphic Mode . . . . .	5-20
5.8.19	Enter Graph Drawing Mode . . . . .	5-20
5.8.20	Exit Graph Drawing Mode . . . . .	5-20
5.9	<b>HOLD SCREEN COMMAND</b> . . . . .	5-21
5.10	<b>CONTROL CODES</b> . . . . .	5-22
5.11	<b>GRAPHING COMMANDS AND EXAMPLES</b> . . . . .	5-22
5.11.1	NO OP . . . . .	5-24
5.11.2	Load Enable Register 0 . . . . .	5-24
5.11.3	Load Enable Register 1 . . . . .	5-25
5.11.4	Load Graph 0 . . . . .	5-25
5.11.5	Load Graph 1 . . . . .	5-26
5.11.6	Load Graph Marker Memory for Graph 0 . . . . .	5-26
5.11.7	Load Graph Marker Memory for Graph 1 . . . . .	5-27
5.11.8	Load Horizontal Line Coordinate . . . . .	5-27
5.11.9	Load Vertical Line Coordinate . . . . .	5-27
5.11.10	Load Starting X Coordinate . . . . .	5-28
5.11.11	Example Sequence . . . . .	5-29
5.11.11.1	Reset Logic . . . . .	5-29
5.11.11.2	Enter Graph Drawing Mode . . . . .	5-29
5.11.11.3	Enable Graphs . . . . .	5-29
5.11.11.4	Load Graph 0 . . . . .	5-29
5.11.11.5	Load X Coordinate . . . . .	5-29
5.11.11.6	Load Graph 1 . . . . .	5-29
5.11.11.7	Load Graph Marker Memory for Graph 0 . . . . .	5-29
5.11.11.8	Load Graph Marker Memory for Graph 1 . . . . .	5-29
5.11.11.9	Load Horizontal Line Coordinate . . . . .	5-29
5.11.11.10	Load Vertical Line Coordinate . . . . .	5-29
5.11.11.11	Controlling Display Status . . . . .	5-29

## CONTENTS (Cont)

		Page
<b>CHAPTER 6</b>	<b>MAINTENANCE</b>	
6.1	PHILOSOPHY . . . . .	6-1
6.2	CORRECTIVE MAINTENANCE . . . . .	6-1
6.2.1	Recommended Spare Parts and Tools . . . . .	6-1
6.2.2	Basic Description of Internal Signal Flow . . . . .	6-3
6.2.3	Troubleshooting Procedure . . . . .	6-4
6.2.4	Copier Replacement Procedure . . . . .	6-13
6.2.5	Video Adjustment Procedure . . . . .	6-14
6.3	PACKING OF DECscope . . . . .	6-15

## ILLUSTRATIONS

Figure No.	Title	Page
1-1	VT55 with Typical Display . . . . .	1-1
1-2	Typical VT55 Displays . . . . .	1-2
1-3	VT55/Computer Interconnection and Simplified Block Diagram . . . . .	1-3
2-1	VT55 Installation Dimensions . . . . .	2-1
2-2	VT55 Power Connectors . . . . .	2-3
3-1	20 mA Interface Cable with Mate-N-Lok Connector . . . . .	3-8
3-2	20 mA Interface Cable with 283B Connector . . . . .	3-9
3-3	EIA Interface Cable . . . . .	3-10
3-4	Location of Underside Switches and Jumpers (Bottom View) . . . . .	3-11
3-5	Transmission (or Reception) of ASCII "B" with Parity Switch Set to NONE . . . . .	3-13
3-6	20 mA Current Loop Connection . . . . .	3-14
3-7	Access to AC Power Terminal Strip . . . . .	3-17
3-8	10-Screw Terminal Strip . . . . .	3-17
3-9	Location of W1 and W2 on the M7024 Graphing Module . . . . .	3-19
4-1	Interface Modes . . . . .	4-1
4-2	VT55 Keyboard . . . . .	4-5
4-3	VT55 with Copier . . . . .	4-6
5-1	VT55 Controls . . . . .	5-2
5-2	State Diagram Showing Change Between Alphanumeric, Graphic, Graph Drawing, and Escape Modes . . . . .	5-3
5-3	VT55 Keyboard . . . . .	5-6
5-4	Graph Drawing Data Field Calibration . . . . .	5-12
5-5	X and Y Position Specification for Letter "E" . . . . .	5-12
5-6	Graph Marker for Graph Point $Y = 322_8$ . . . . .	5-13
6-1	VT55 Simplified Signal Flow Diagram . . . . .	6-3
6-2	ROM, UART, and Timing Module . . . . .	6-4
6-3	VT55 DECscope Assembly Drawing . . . . .	6-5
6-4	Removal of Copier Cover . . . . .	6-13
6-5	Location of Controls on Power Supply Monitor Module . . . . .	6-14
6-6	Alignment of Alphanumerics and Graphics . . . . .	6-15
6-7	VT55 Packing . . . . .	6-16

## TABLES

Table No.	Title	Page
1-1	Summary of VT55 Keyboard and Displayable Features . . . . .	1-3
1-2	VT55 Models . . . . .	1-5
3-1	20 mA Interface Cable Wire Color-Pin Assignments (Mate-N-Lok) . . . . .	3-7
3-2	20 mA Interface Cable (Mate-N-Lok) Part Numbers . . . . .	3-7
3-3	20 mA Interface Cable Wire Color-Pin Assignments (283B) . . . . .	3-8
3-4	20 mA Interface Cable (283B) Part Numbers . . . . .	3-8
3-5	EIA Interface Cable Wire Color-Pin Assignments . . . . .	3-9
3-6	EIA Interface Cable Part Numbers . . . . .	3-9
3-7	Baud Rate and Interface Mode Selection Switch Positions . . . . .	3-12
3-8	AC Terminal Strip Jumpers for Different Nominal Line Voltages . . . . .	3-18
5-1	Code Ensemble of ASCII Keyboard – Transmitted Codes . . . . .	5-5
5-2	Codes Transmitted to Host by VT55 . . . . .	5-8
5-3	Code Ensemble in Alphanumerics Mode – Received Codes . . . . .	5-9
5-4	Alphanumeric Cursor Control . . . . .	5-9
5-5	Display of the Codes 136–176 . . . . .	5-10
5-6	Graph Drawing Data Characters . . . . .	5-15
5-7	Character Values . . . . .	5-16
5-8	Escape Mode Characters . . . . .	5-18
5-9	Control Codes – All Modes . . . . .	5-23
6-1	Recommended Spare Parts Kit . . . . .	6-2
6-2	Recommended Tool Kit . . . . .	6-2
6-3	Capacitor Voltages . . . . .	6-11
6-4	Transformer Secondary Voltages . . . . .	6-12
6-5	CRT Base Voltages . . . . .	6-12
6-6	VT55 Shipping Package . . . . .	6-15



## CHAPTER 1 INTRODUCTION

### 1.1 GENERAL DESCRIPTION

The VT55 DECscope is a serial line-interfaced computer terminal that features alphanumeric and graphical display in a single unit with upper- and lowercase characters. When interfaced to a host computer, the VT55 can display as many as two graphs or histograms supported by programmable grid and programmable graph markers. When alphanumeric information is added to this picture, a completely defined graph is displayed. As many as 24 lines of 80-character alphanumeric information may be displayed on the VT55. Control of the VT55 is via the console keyboard and keypad, which is included with the unit. By using only the alphanumeric capability of this DECscope, with the keyboard and keypad, the VT55 may be utilized as a 24-line programmers' terminal. Some models of the VT55 include a copier unit that generates a paper copy of the screen's contents, alphanumeric and graphic, for the user's convenience. Figure 1-1 shows a VT55 with a typical graph displayed; Figure 1-2 shows a typical line graph, histogram, grid, and the superposition of the three. Table 1-1 summarizes the important keyboard and displayable VT55 features.

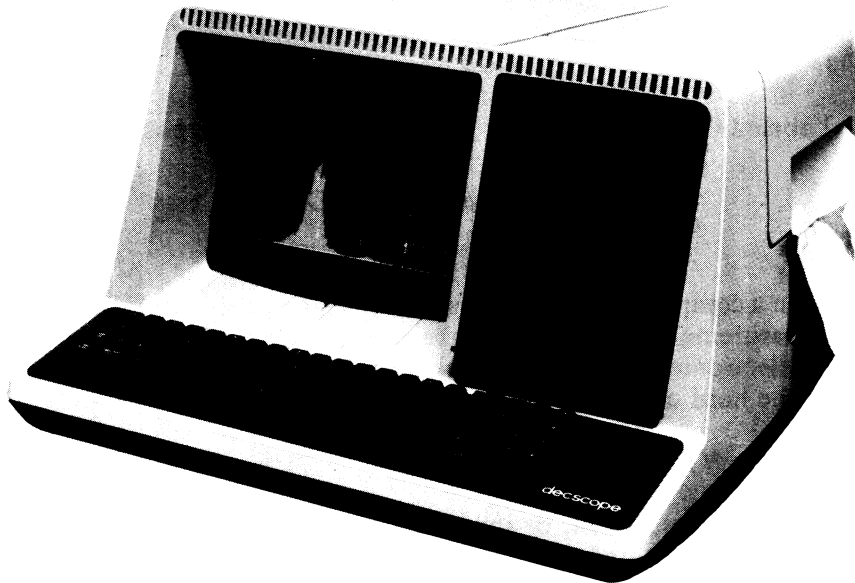

8009-4

Figure 1-1 VT55 with Typical Display

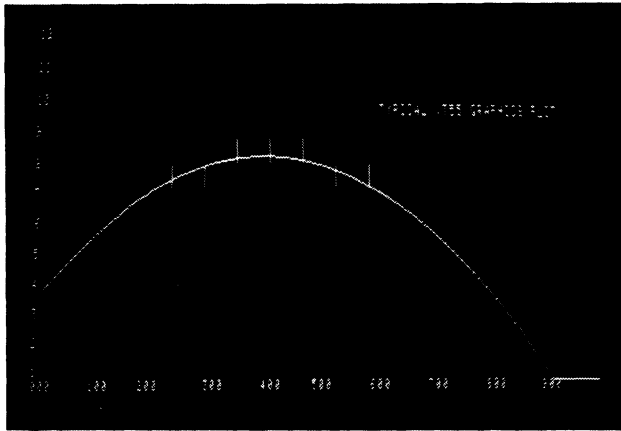

7717-2

a. Graph 0 with Graphing Markers (Line Graph)

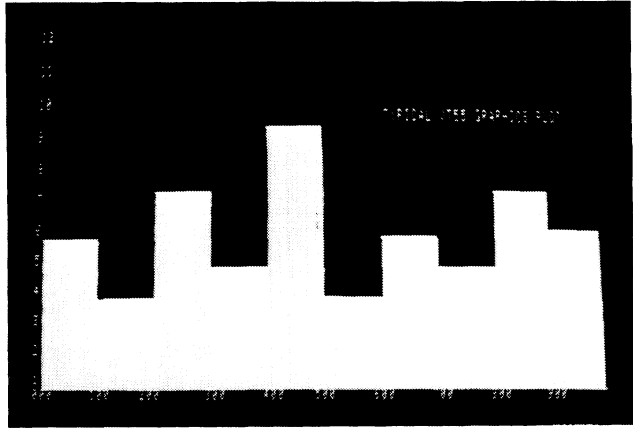

7717-1

b. Graph 1 (Histogram)

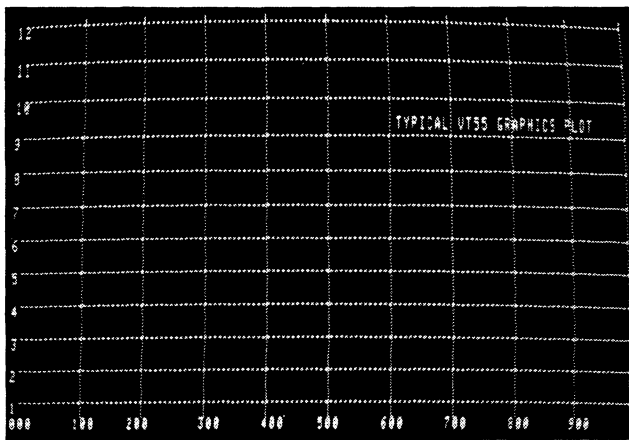

7717-4

c. Labeled Grid

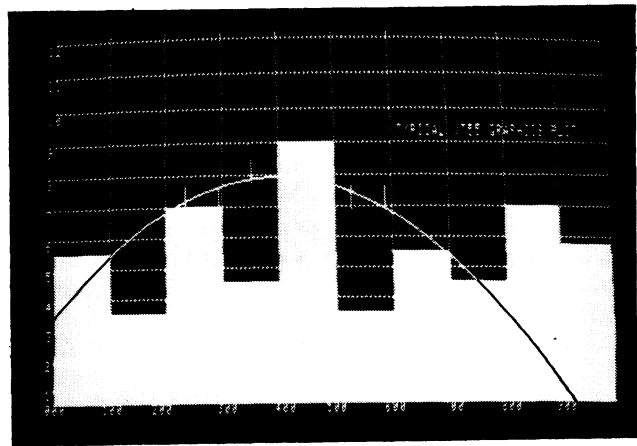

7717-3

d. Superposition of a, b, and c

Figure 1-2 Typical VT55 Displays

The VT55 is packaged in a compact, attractive, desktop mounting cabinet. Information is displayed on a 12-inch (diagonal measurement) cathode ray tube which faces the front of the unit along with the console keyboard. All electronics are housed within the VT55 cabinet. Models with copiers have the copier mechanics and the hard copy output located at the top right side of the cabinet.

Typical applications for the VT55 are:

- A business where sales, profit, or inventory is computerized, and changes due to varying parameters are being studied.
- A medical environment where transducers monitor vital body functions; data is computerized and displayed as graphical output.
- An educational environment where displayed graphs may be altered by varying the parameters of the representative equations.



**Table 1-1 Summary of VT55 Keyboard and Displayable Features\***

Item	Description
Keyboard	ANSI X 4.14 with control keys similar to office typewriters. Three key rollover and audible feedback is provided.
Keypad	Useful for direct cursor addressing and other number entry applications.
Displayable Alphanumerics	24 lines, 80 characters per line. 96-character ASCII including upper- and lowercase letters, numerals, and special characters that may be displayed on the CRT and printed on the copier output. Direct cursor addressing in the alphanumerics mode.
Displayable Graphs	<p>Two individually chosen graphs or histograms; 512 points along the horizontal axis. Each graph must be single-valued along the vertical axis. Two points cannot be programmed in the same vertical column on the same graph.</p> <p>Graph grid composed of as many as 512 vertical lines and 236 horizontal lines, all individually selectable.</p> <p>Graph markers that may be selected to straddle as many of the 512 points on each of the two graphs as desired.</p>
Display Area	<p>Approximately 203 × 127 mm (horizontal × vertical) – 8 in. × 5 in.</p> <p>7- × 7-point character font.</p>

\*Refer to Paragraph 1.5 for complete specifications.

**1.2 HARDWARE DESCRIPTION**

The VT55 is normally used in conjunction with a host computer. A serial line cable makes the connection between the terminal and the computer. To transmit information to the computer, the operator presses a key on the terminal keyboard. This transmits a code, representative of the key that was pressed, to the terminal's serial line output. The computer, at the other end of the serial line cable, responds to the key in accordance with the computer's program (Figure 1-3).

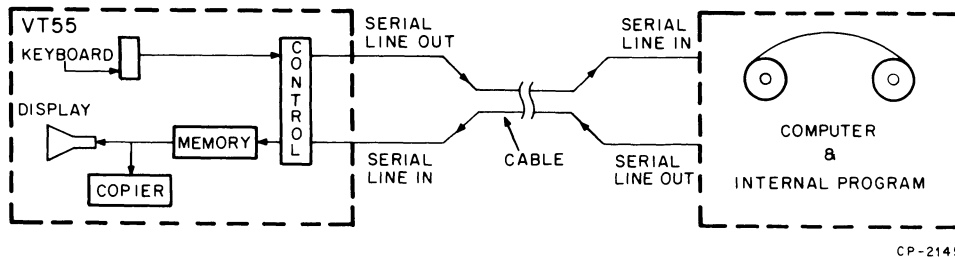

Figure 1-3 VT55/Computer Interconnection and Simplified Block Diagram

When information is transmitted from the computer's serial line output to the DECscope serial line input, it is examined by the VT55 control electronics to determine whether the information is alphanumeric data or terminal control information. If the information is alphanumeric or graph data, it will be stored in the VT55's internal memory. The contents of this memory are constantly displayed on the cathode ray tube as alphanumeric characters and graph curves and lines.

When the information received via the serial line is terminal control information such as "Erase Lines of Characters," "Switch to Graph Drawing Mode," or "Generate Hard Copy," the operation of the terminal is modified accordingly. The terminal then waits for new information. As shown in Figure 1-3, the copier is connected at the interface of the memory and display. When a Generate Hard Copy command is issued, the current displayable contents of the memory, alphanumeric and graphic, will be duplicated onto the copier's output. This copier feature is available on some models of the VT55.

### **1.2.1 VT55 Technology**

The VT55 uses a rather unique combination of technologies to deliver a product with maximum performance at a minimum price. For example, the cabinet is a modern, high-impact, injection-molded design yielding strength, good design, and light weight. The internal electronics is a microprocessor design. A specialized computer program is actually constantly running within the terminal. It is always waiting to service a request to transmit data from the keyboard to the serial line output, enter data into the internal semiconductor memories, service a copier request, etc. A separate memory is allotted to alphanumeric data, graph data, and terminal control information.

The display of the alphanumeric and graphic data is performed by the raster scan method. This is basically the same method utilized by consumer television sets to produce their displays. The method is reliable and produces bright, flicker-free information output. The generation of the raster scans and intensification information are synchronized to the microprocessor, thus eliminating the need for vertical and horizontal hold controls.

The optional copier uses a scanning technique similar to methods utilized in facsimile picture transmission systems of the 1940's. This technique, in conjunction with the use of modern recording paper, generates high-quality copy in a minimum-size package with a minimum number of moving parts.

### **1.3 VT55 MODELS**

There are 15 models of the VT55 DECscope. They are listed in Table 1-2 and differ in their line voltage/line frequency and interface requirements. Some models include the copier.

The VT55-EB, EF, HB, FB, FF, and JB models have internal jumpers that allow altering the nominal input line voltage from 230 Vac to 240 or 220 Vac. Models VT55-EC, EH, and HC allow the nominal line voltage to be increased from 100 Vac to 110 or 127 Vac.

The capability to vary the nominal input line voltage allows the unit to be tailored to the standard of the country in which the VT55 is installed. Models with 50/60 Hz capability are always shipped configured for 50 Hz operation.

Units with Mate-N-Lok connectors are primarily intended for interfacing with DIGITAL serial line communications interfaces. Units with RS232C connectors are compatible with RS232C Standard Dataphone and Modem applications. Connector 283B is a telephone-type plug compatible with DEC-system-10 applications.

### **1.4 RELATED DOCUMENTS**

VT55 models FA, FB, FE, FF, JA, and JB are equipped with the VT50 copier. A *VT50 Series Copier User's Manual* (EK-VT5C-OP-001) is shipped with these models. Refer to the copier manual when performing maintenance tasks on the copier.

**Table 1-2 VT55 Models**

<b>Model</b>	<b>Line Voltage (Vac)</b>	<b>Line Frequency (Hz)</b>	<b>Copier</b>	<b>Interface</b>
VT55-EA	115	60	No	20 mA with Mate-N-Lok connector
VT55-EB	220/240	50/60	No	20 mA with Mate-N-Lok connector
VT55-EC	100/127	50/60	No	20 mA with Mate-N-Lok connector
VT55-EE	115	60	No	EIA with RS232C connector
VT55-EF	220/240	50/60	No	EIA with RS232C connector
VT55-EH	100/127	50/60	No	EIA with RS232C connector
VT55-HA	115	60	No	20 mA with 283B connector
VT55-HB	220/240	50/60	No	20 mA with 283B connector
VT55-HC	100/127	50/60	No	20 mA with 283B connector
VT55-FA	115	60	Yes	20 mA with Mate-N-Lok connector
VT55-FB	220/240	50	Yes	20 mA with Mate-N-Lok connector
VT55-FE	115	60	Yes	EIA with RS232C connector
VT55-FF	220/240	50	Yes	EIA with RS232C connector
VT55-JA	115	60	Yes	20 mA with 283B connector
VT55-JB	220/240	50	Yes	20 mA with 283 B connector

## 1.5 TECHNICAL CHARACTERISTICS

The VT55 DECscope is designed to operate in a typical office or laboratory environment. It will operate over a wide temperature and humidity range and is insensitive to most power "brownout" conditions. The following paragraphs itemize the installation, functional, and interface characteristics of the VT55.

### 1.5.1 Installation Characteristics

#### Cabinet Dimensions

Height	360 mm (14.1 in)
Width	530 mm (20.9 in)
Depth	690 mm (27.2 in)
Minimum Table Depth	450 mm (17.7 in)

#### System Weight

With Copier	25.8 kg (57 lb)
Without Copier	22.2 kg (49 lb)

#### Temperature

Operating Environment	
With Copier	15° to 32° C (58° to 90° F)
Without Copier	10° to 40° C (50° to 104° F)
Nonoperating Environment	-40° to 66° C (-40° to 151° F)

#### Humidity (Noncondensing)

Operating Environment	
With Copier	20 to 80%
Without Copier	10 to 90%
Nonoperating Environment	0 to 95%

#### Power

Model	Nominal Line Voltage (Vac)	Voltage Range (Vac)		Maximum Line Current (Amps)	Line Freq (Hz)
		-13%	+9%		
VT55-EA, EE, HA	115	100	126	1.5	60 ± 1
VT55-EB, EF, HB*	240	209	262	0.7	50/60 ± 1
VT55-EC, EH, HC†	100	87	109	1.7	50/60 ± 1
VT55-FA, FE, JA	115	100	126	2.4	60 ± 1
VT55-FB, FF, JB*	240	209	262	1.2	50 ± 1

\* Jumper selectable for 230 or 220 Vac, -13%, +9%

† Jumper selectable for 110 or 127 Vac, -13%, +9%

#### Power Line Voltage Transients

Voltage transients must be less than 300 V peak-to-peak to ensure no data errors. Voltage transients on the power line greater than 1000 V peak-to-peak may cause damage to the terminal.

#### Safety and Ground Current Leakage

3.5 mA max

#### Fault Protection

Circuit breaker

#### Power Cord Length

2.74 m (9 ft)

## 1.5.2 Functional Characteristics

### Video Display

Size	305 mm (12 in) diagonal
Active Screen Size	203 × 127 mm (8 × 5.0 in)
Method	Raster scan, roll-free
Phosphor	P4
Linearity	±1/2 point

### Alphanumerics

Character Lines	24
Character Columns	80
Control	Blinking alpha cursor
Character Set	96-character, upper- and lowercase ASCII subset, 32 control characters, and graphic characters.
Special Features	Upward and downward scroll, bell, erase, tabulate, cursor control
Character Matrix	7 × 7

### Graphics

Resolution	512 horizontal × 236 vertical points
Graphs or Histograms	Two single-valued functions of x, each individually controlled
Grid	512 vertical lines and 236 horizontal lines, each individually controlled
Graph Markers	512/graph, total of 1024. Each graph marker is individually controlled
Special Features	Individual blanking and unblanking of all graph features, clear all graphs.

### Special Features

Hold Screen Mode	Allows interruption of data transmission for extended display viewing.
Terminal Identifier	Terminal will respond with ESC/E when receiving ESC Z.

### Keyboard

Format	ANSI X 4.14-1971 standard typewriter keyboard
Keyclick	Audible feedback on each keystroke
Error Correction	Three-key rollover to reduce errors caused by fast typing
Special Keys	Extra control keys for special and commonly used control functions include ESC, TAB, SCROLL, BACKSPACE, BREAK, LINE FEED, RETURN, COPY, REPEAT
Auxiliary Keypad	Extra control keys for transmitting 2-character escape sequences and special character codes

### User Controls

Intensity	Variable to adjust character and graph brightness
Parity	Even or no parity, switch selectable; odd parity, jumper-selectable
Power/Logic Reset	Turns line voltage on and off and resets unit to Alphanumeric mode.
Baud Rate/Interface Mode	Allows choice of baud rate, full duplex, full duplex with local copy, and local mode with rotary switches.

## Copier

Image Copied	Display on screen less the alphanumeric cursor
Time/Print	Approximately 25 seconds/copy
Copy Size	Approximately 76.2 mm (3 in) high × 177.8 mm (7 in) wide
Paper Roll Size	36.5 m (120 ft) long × 216 mm (8-1/2 in) wide
Character Format	7 × 7 dot matrix
Graph Field	512 points horizontal × 236 points vertical
User Controls	Variable character width adjustment

### 1.5.3 Interface Characteristics

Type 20 mA current loop or EIA, depending on model

#### Speed

Full Duplex	75, 110, 150, 300, 600, 1200, 2400, 4800, and 9600 baud
Full Duplex with Local Copy	110, 150, 300, 600, 1200, 2400, 4800, and 9600 baud
Full Duplex, Split Speeds	Transmission at 75, 150, 300, or 4800 baud with reception at 110, 600, 1200, 2400, 4800, or 9600 baud

#### Transmission

10-Bit Length	75, 150, 300, 600, 1200, 2400, 4800, and 9600 baud
11-Bit Length	110 baud only
Parity	Generated on transmission as odd or even parity or a mark. (No parity is switch-selectable.) Parity is not checked on reception.

#### Supplied Cable Length

20 mA models	7.6 m (25 ft)
EIA models	7.6 m (25 ft)

#### Maximum Cable Length

20 mA models	304.8 m (1000 ft)
EIA models	15.2 m (50 ft)

### 1.6 VT55 OPTIONS

There are three cable options available for the VT55. These are:

1. BN52C-7F 7.6-m (24.9-ft), current loop cable with a 283B telephone type plug
2. BN52B-7F 7.6-m (24.9-ft), 20-mA adapter cable with an 8-pin Mate-N-Lok connector
3. BN52A-7F 7.6-m (24.9-ft), EIA cable with the standard 25-pin EIA connector.

These optional cables allow the user to convert his VT55 to either a 20-mA current loop interface or an EIA interface in the event his interface requirements change after purchasing the VT55. Optional interface cables may be purchased from the nearest Digital Equipment Corporation Sales Office.

## CHAPTER 2 SITE PREPARATION AND PLANNING

### 2.1 PURPOSE AND IMPORTANCE

In order to facilitate installation of the VT55 DECscope upon receipt from the factory, the user should ensure that site installation requirements are met. As the VT55 is designed to operate in most office and laboratory environments, special alterations to the installation site will not normally be required. The paragraphs which follow detail the user's responsibility prior to installation. These concern installation, space, operating environment, power, and signal connection requirements. If any questions arise concerning site preparation, please call the local DIGITAL Field Service Representative.

### 2.2 INSTALLATION SPACE

The VT55 is a tabletop mounting device. The cabinet is 360 mm (14.1 in) high, 530 mm (20.9 in) wide, and 690 mm (27.2 in) deep. A table depth of 450 mm (17.7 in) is required for unit placement. A space of 640 mm (25 in) should be allowed in vertical height above the table to tip the unit into a position that allows access to switches and data cables. These dimensions are diagrammed in Figure 2-1.

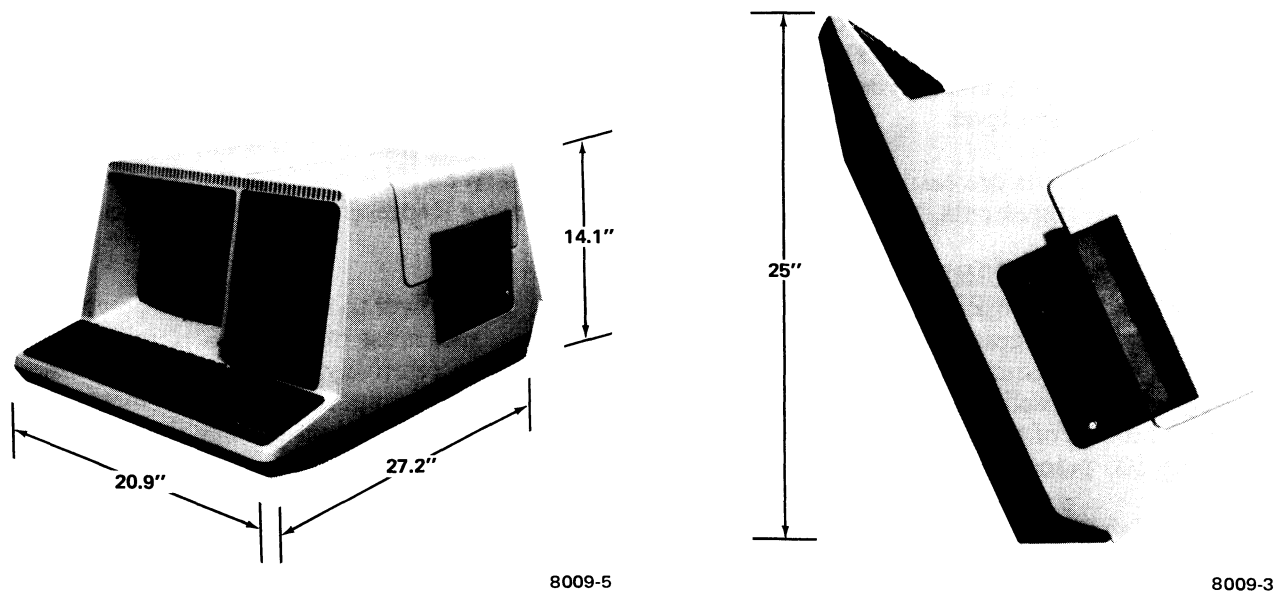

Figure 2-1 VT55 Installation Dimensions

The VT55 must be kept at least 50 mm (2 in) from the nearest obstruction in the rear. This permits adequate air flow space for internal convection cooling. VT55 models FA, FB, FE, FF, JA, and JB with internal copiers require clearance on the top and right side of the unit for access to the copier paper housing and copier paper output.

The VT55 should be positioned so that access to the keyboard and work material is comfortable. A page holder is mounted just to the right of the video screen to aid in transcribing information from paper to the VT55 keyboard.

## **2.3 OPERATING ENVIRONMENT**

### **2.3.1 Operating Temperature and Humidity**

The VT55 is designed to operate in a typical office or laboratory environment. Acceptable limits of ambient temperature are 10° to 40° C (50° to 104° F). Relative humidity must be between 10 and 90 percent with a maximum wet bulb temperature of 82° F and a minimum dew point temperature of 2° C (36° F). These parameters ensure that there is no condensation on the unit.

### **2.3.2 Device Dissipation**

Nominal device dissipation for the VT55 DECscope is approximately 500 Btu/hr. No special cooling consideration is needed for the terminal. However, in worst case use where the VT55 has a copier installed that is running 100 percent of the time with the line voltage at maximum, the thermal load could increase to 1000 Btu/hr.

### **2.3.3 Electrical Noise Tolerance**

Electromagnetic fields in the vicinity of the VT55 can cause distortion or jittering of the video display. This is caused by distortion in the travel of the cathode ray tube electron beam due to the fields. Items that generate electromagnetic fields such as power transformers, fluorescent lights, and transmitting antennas should be kept away from the VT55. An acceptable electromagnetic field intensity is less than 1 volt/meter, at any frequency, measured in the vicinity of the VT55.

### **2.3.4 Vibration, Atmosphere, Altitude**

There are no special considerations that must be made for the VT55 with regard to these parameters at most installation sites. The installation site must be free of excessive vibration and be free of excessive dust, metal particles, and corrosive fumes in the air. The product can operate in altitudes up to 2730 m (8000 ft) above sea level.

These requirements are easily met in most installation cases. When it is questionable that a given site meets these requirements, the local DIGITAL Sales or Service Representative should be consulted.

## **2.4 POWER REQUIREMENTS**

It is the user's responsibility to provide an adequate source of ac power to the VT55. The power source must deliver voltages that are suitable to operate the unit and must be capable of providing the machine with adequate current. The power lines must also be relatively free of voltage transients. Paragraph 1.5.1 defines line voltage, transients, frequency, and maximum current requirements for the various models of the VT55. Maximum current values for the copier versions assume that the copier is running 100 percent of the time.

The 240 Vac models of the VT55 may be easily modified upon arrival at the site for 220 Vac or 230 Vac nominal line voltage. The 100 Vac version may be converted for 110 Vac or 127 Vac nominal line voltages. The maximum deviations from nominal of +9% and -13% apply in these cases as well. In addition, 100 Vac and 240 Vac machines are shipped from the factory wired for 50 Hz operation. If required, non-copier units may be easily altered to operate at 60 Hz. Chapter 3 of this manual explains these procedures. VT55 units with copier operate at only 50 Hz or 60 Hz, depending on the model (Table 1-2).



VT55-EA, EB, EE, EF, HA, and HC require 185 W of power while the copier versions, VT55-FA, FB, FE, FF, JA, and JB, require 300 W maximum. The local DIGITAL Field Service Representative should be consulted if the integrity of the power source is questionable.

Each unit is shipped with a 2.75-m (9-ft) power cord. A NEMA (National Electronic Manufacturer's Association) 5-15P male plug is provided on VT55-EA, EC, EE, EH, FA, FE, HA, HC, and JA, while NEMA 6-15P is installed at the end of VT55-EB, EF, FB, FF, HB, and JB power cords. Figure 2-2 shows mating plugs and receptacles.

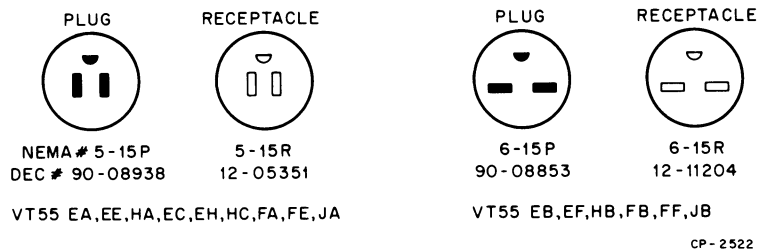

Figure 2-2 VT55 Power Connectors

When the VT55 is interfaced to a computer with switched convenience outlets, it is convenient to allow the terminal to be powered by the master console power key by utilizing these outlets.

## 2.5 SIGNAL CABLES

VT55 models EA, EB, EC, FA, FB are shipped with a 7.6-m (24.9-ft), 20-mA signal cable. The signal cable is terminated with an 8-pin, male Mate-N-Lok connector suitable for connection to most DIGITAL serial line interface options. This connector may be removed and replaced as desired.

Models EE, EF, EH, FE, FF are shipped with a 7.6-m (24.9-ft), EIA signal cable. This cable is terminated with a male 25-pin connector which is compatible with EIA Standard RS232C.

Models HA, HB, HC, JA, JB are shipped with a 7.6-m (24.9-ft), 20 mA signal cable. This cable is terminated with a telephone-type 283 plug compatible with DECsystem-10 applications.

Refer to Chapter 3 for details on part numbers and pin assignments if this information is required at site planning.

8. Test the unit by pressing keys and checking for corresponding characters on the screen. Press COPY if applicable. This ensures that the video, microprocessor, keyboard, and copier are functional in the local mode. The hard copy output received at the copier after 25 seconds should be an accurate representation of the video screen display. The blinking alphanumeric cursor will not appear on the copy. Use the pinch roller release lever to release the paper to examine the copy. The copy may be torn off on the serrated edge of the cover.
9. Connect the VT55 to the computer by following the procedure outlined in Paragraph 3.4.
10. To ensure that all of the VT55 logic functions properly at operating speeds through a remote interface, acceptance testing is to be performed with a host computer using the MAINDEC programs listed below. However, before performing the acceptance test, tilt the VT55 on its back and set S1 and S2 to the desired baud rate and full duplex mode. If the VT55 is to be used with a PDP-8 or a PDP-11 host computer, the following DIGITAL-supplied MAINDEC programs must be used:

PDP-8	PDP-11	Title
MAINDEC-08-DHVTA	MAINDEC-11-DZVTC	VT50-A, B, H Acceptance Test
MAINDEC-08-DIVTC	MAINDEC-11-DZVTD	VT55 Acceptance Test

The VT50-A, B, H Acceptance Test tests all alphanumeric functions and the copier. The VT55 graphing capability is tested by the VT55 Acceptance Test. At least one pass of each diagnostic should be run in accordance with the supplied diagnostic writeup. The writeup should be read thoroughly to ensure full understanding of what constitutes proper operation of the terminal. Please note that any terminal errors will be found by careful examination of the video screen output, not by error reporting on the console device. Users who have units with copier capability should ensure full copier operation by pressing COPY after a graphic picture is displayed when running the VT55 Acceptance Test.

If the VT55 is to be used on a processor other than a PDP-8, PDP-11, or other DIGITAL processor, adjust the baud rate and interface mode switches to the desired setting. Any piece of software known to operate the VT55 may be utilized for final test of the unit. However, it is not the responsibility of the DIGITAL Field Service Representative to ensure the integrity of user software.

If running the acceptance tests uncovers faults in the VT55, the interface, or the computer, the manual test in Paragraph 3.3 can be used to isolate the fault with the VT55 off line.

### 3.3 MANUAL TESTING

1. The VT55 must be connected to the computer interface as outlined in Paragraph 3.4 and the mode switch (S1) must be set for full duplex with local copy (half duplex) operation.
2. The computer does not require any program for the following test since the data transmitted by the VT55 is looped back to the receiver via internal VT55 connections. The interface cable must be connected to the computer interface to assert proper logic conditions at the optical couplers. Therefore, the interface must be powered up. If no computer is connected to the VT55, set the VT55 in the local mode as described in Paragraph 3.2, step 4. In this condition, the interface will be bypassed.

### 3.3.1 Miscellaneous Functions

1. Test the VT55 by pressing keys and checking for corresponding characters on the screen. All characters should be exercised in both upper- and lowercase. As characters are typed, the cursor should move to the right one character position. Each time a character is typed, the VT55 will make a clicking sound. When 80 characters have been typed on one line, the cursor should be positioned under the 80th character.
2. With 80 characters displayed on one line, and the cursor positioned under the 80th character, type an 81st character. Since no more space is available on the line, the 80th character will be replaced by the 81st character and the cursor will remain under the last character (80th) on the line.
3. While displaying 80 characters, press the BACKSPACE key. Note that the cursor moves toward the left of the display one character position for each time the BACKSPACE key is depressed.
4. Using the BACKSPACE key, position the cursor toward the middle of the display and then type additional characters. Note that the characters previously displayed are replaced with the characters just typed.
5. Press the space bar and note that the cursor moves one character position to the right and replaces a character with a space.
6. Press the RETURN key. The cursor should move to the left margin of the line it is on.
7. Press the LINE FEED key. The cursor should move down one line.
8. Type another line of characters. This line of characters should appear under the line previously typed.
9. Every eight columns (character positions) there is a tab stop. Press the TAB key and note that the cursor moves to the right until it reaches a tab stop. Press the TAB a second or third time and note that the cursor is reaching the tab stops. Also note that when the TAB key is pressed, characters are not erased from the display.
10. Use the RETURN and LINE FEED keys to position the cursor at the beginning of the next line. Press the TAB key and verify that the cursor moves eight columns to the right. Type an "X" to mark the spot where the cursor stopped. Continue to press the TAB key and then type an "X" to see where all the tab stops (eight of them) are. Notice that when the cursor reaches column 72, the TAB key will move the cursor only one column to the right. If the cursor is at the end of a line, the TAB key will not move the cursor.
11. Using the RETURN and LINE FEED keys, move the cursor to the start of the next line. Type two or three characters, then press the TAB key. The cursor should travel to the TAB stop. Type characters, press the BACKSPACE key, then press the TAB key. Note that the TAB key does not always move the cursor eight columns to the right, but only the number of columns necessary to reach the next TAB stop.

12. Press the DELETE key and note that nothing happens to the display. The VT55 ignores this key command. However, when a computer receives the DELETE command, special action may be taken.
13. Hold the SHIFT key down and, at the same time, type some characters. Note that the characters displayed are uppercase. Release the SHIFT key.
14. Press the CAPS LOCK key. Note that this key clicks and locks in the down position. Type some characters and note that they are displayed in uppercase. Press the CAPS LOCK key again and type more characters. These characters are displayed in lowercase.
15. Type all the numeral and symbol keys, except the ones with special words labeled on them. Use the SHIFT key to display the symbol which is on the top half of the key. (Note that the CAPS LOCK key will not perform the same function as the SHIFT key on keys that are not letter keys. That is, to display a "G" rather than a "g," press either the SHIFT key or the CAPS LOCK key. However, to display an "@" instead of a "2," the SHIFT key must be used.)
16. Press the CAPS LOCK key and type "ONE-TWO-THREE." Note that the CAPS LOCK key does not have to be unlocked to type the dashes.
17. Type several short lines, following each line with a RETURN and LINE FEED until the bottom line (24th line) of the display is completed. Now press LINE FEED. Since the VT55 must provide a new line, it moves the information on the display up one line to make room. Notice that the information that was displayed on the top line has gone off of the screen.
18. Type several more lines of characters. These lines are placed at the bottom of the display and displace the same number of lines from the top of the display.
19. Press the BREAK key and note that nothing happens to the display. The VT55 ignores this key command. However, when a computer receives the BREAK command, special action may be taken.
20. The red CTRL (control) key can be used with alphabetic keys to produce commands which are neither upper- nor lowercase letters; i.e., CTRL H = BACKSPACE, CTRL M = RETURN, CTRL J = LINE FEED. Hold down the CTRL key and type an H, then an M, then a J. The cursor should backspace one character position, move to the left display margin, and then move down one line.
21. Press CTRL G. The VT55 internal buzzer should sound.
22. The red ESC (SEL) key is used to give the VT55 special commands. Press ESC and then type H. Note that the cursor moves to the upper left corner of the display.
23. Press ESC and then type K. The top line of the display will be erased.
24. Press ESC and then type J. The entire display will be erased.
25. Type numerals 0 through 9 on the auxiliary keypad. Numerals 0 through 9 will be displayed. The auxiliary keypad numeral keys perform the same functions as the numeral keys on the main keyboard.
26. Press the period (.) key on the auxiliary keypad. A period (.) will be displayed. The period key on the auxiliary keypad performs the same function as the period on the main keyboard.

27. Press the ENTER key on the auxiliary keypad. The cursor should move to the left margin of the display. The ENTER key on the auxiliary keypad performs the same function as the RETURN key on the main keyboard.
28. Press the arrow keys on the auxiliary keypad one at a time. The cursor should move in the direction of the arrows on the keys, i.e., down for the down arrow, to the right for the right arrow, left for the left arrow, and up for the up arrow.
29. For VT55s with a copier, press the COPY key. The information displayed will be printed on the copier output.
30. Hold down the REPEAT key and then press and release any character key. The character will be repeated on the display as long as the REPEAT key is held down.
31. Press ESC Z. The character E will be displayed. The VT55 will always respond with the terminal identifier sequence ESC /E to ESC Z being received. ESC / is not displayed in this case; it is part of the "escape sequence" described in Chapter 5.

### **3.3.2 Graph Drawing Mode Functions**

1. Press ESC 1; the VT55 is in Graph Drawing mode. (The VT55 will no longer recognize keys pressed as letters and numbers.)
2. Press I, then 0 to clear graph drawing memory. Be sure to depress SHIFT or CAPS LOCK to obtain uppercase letters.
3. Press A, then #; graph 0 is now enabled and a horizontal line should appear near the bottom of the display.
4. Press B, then 6 and 6 again; a single dot should be displayed near the upper-left corner of the display.
5. Press 6 twice, nine more times; a 10-dot horizontal line should be in the upper-left corner of the display.
6. Press A, then ); the 10-dot horizontal line should become a solid histogram (solid intensity bar from 10-dot horizontal line to baseline).
7. Press A, then %; the solid histogram should disappear and the horizontal baseline of graph 1 should appear on the bottom of the display.
8. Press H, then 5, followed by 5; this sets the next image near the center of the display.
9. Press J, then 6, followed by 6; a single dot should appear near the top center of the display.
10. Press 6 twice, nine more times; a 10-point horizontal bar should appear near the top center of the display.
11. Press A, then 9; the 10-point horizontal line of graph 1 should become a histogram and the histogram of graph 0 should reappear.
12. Press I, then /; this enables generation of grid lines and graph markers in the following steps.
13. Press L, then 0 twice; a single, long vertical line should appear near the left side of the display.

14. Press C, then 1 twice; a 16-point vertical cursor should appear about 2.54 cm (1 inch) to the right of the long vertical line. This is a cursor 0 graph marker.
15. Press K, then 2 twice; a second 16-point vertical cursor should appear on the display. This is a cursor 1 graph marker.
16. Press D, then 0 twice; a long horizontal line should appear just above the lower graph 0 and graph 1 baselines.
17. Press A, then SPACE; all graph drawing information should be blanked from the display. Press 9 to restore.
18. At this point, press the COPY key if the VT55 has a copier installed. An exact reproduction of the display should appear at the copier paper output after 25 seconds. It is normal for the graph to disappear from the display for this short period of time.
19. Press I, then 0; this is the Graph Clear command. All graph drawings should clear off the display, leaving only the horizontal baselines of graph 0 and graph 1.
20. Press ESC, then 2; the VT55 is now restored to the Alphanumeric mode. Typing on the keyboard should again display alphanumeric characters on the display. The horizontal baselines of graph 0 and graph 1 will remain displayed on the screen.

### 3.3.3 Hold Display Mode Functions

1. Place the alphanumeric cursor on the bottom line.
2. Press ESC [ to enter Hold Display mode.
3. Press the LINE FEED key.
4. Type VT55; characters do not appear on the display.
5. Press the SCROLL key; the message "VT55" should now appear on the display.
6. Press ESC \ to exit Hold Display mode.
7. Press the LINE FEED key; check for the message to scroll up.

### 3.4 CONNECTING THE VT55 TO AN INTERFACE

Models of the VT55 are supplied with interface cables for a 20 mA current loop with a Mate-N-Lok connector, a 20 mA current loop with a 283B connector, or an EIA interface with an RS232C connector. The various VT55 models and their associated interface cables are as follows:

Model	Interface Cable
VT55-EA, EB, EC, FA, FB	20 mA with 8-pin Mate-N-Lok connector.
VT55-HA, HB, HC, JA, JB	20 mA with a 283B telephone type connector.
VT55-EE, EF, EH, FE, FF	EIA interface with RS232C connector.

All interface cables are connected to the VT55 by means of a plug-in card and are 7.6 m (24.9 ft) in length. Optional interface cables (Paragraph 1.6) may be purchased from DIGITAL to allow the VT55 user to change the interface as requirements change. After connecting the VT55 to the interface, the baud rate and mode switches must be set per the requirements of Paragraph 3.4.5 or of the user.

### 3.4.1 20 mA Interface Cable with Mate-N-Lok Connector

VT55 models EA, EB, EC, FA, and FB are supplied with the standard 20 mA interface cable terminated with an 8-pin Mate-N-Lok connector. The connector may be removed and replaced if desired to suit customer requirements. Table 3-1 and Figure 3-1 provide signal and pin information for the cable and connectors. Table 3-2 provides part numbers for users who want to order parts from DIGITAL to construct longer cables.

#### NOTE

For DL11-As and DL11-Cs that operate with 20 mA current loops, capacitors are used to filter the receive line and slow the switching time of the transmit line. To avoid excessive distortion above 150 baud, the capacitance in each of these two circuits must be reduced. This is accomplished by clipping C29 (0.47 mF) and C31 (1000 pF), both shown on drawing DL-3. Similar attention must be paid to other interfaces requiring such modifications. Refer to the specifications for these devices at installation time.

**Table 3-1 20 mA Interface Cable Wire Color-Pin Assignments (Mate-N-Lok)**

Interface Cable Wire Color	Adapter Card Pin Number	Signal Assignment	Mate-N-Lok Pin Number
White	HW1	Receive Positive	5
Black	HW2	Receive Negative	2
Green	HW3	Transmit Positive	7
Red	HW4	Transmit Negative	3

**Table 3-2 20 mA Interface Cable (Mate-N-Lok) Part Numbers**

Description*	Part Number
Cable Type, 4-wire No. 22 stranded	DEC 91-07706
Connector Type, 8-pin Mate-N-Lok (Male)	DEC 12-09340-01 or AMP 1-480460 or equivalent
Connector Male Pins, 4 required	DEC 12-09378-03 or AMP 350079-4 or equivalent
Connector Type, 8-pin Mate-N-Lok (Female)	DEC 12-09340-00 or AMP 1-480459 or equivalent
Connector Female pins, 4 required	DEC 12-09379-03 or AMP 350078-4 or equivalent
VT52 20 mA Adapter Card	DEC 5411759

\*Standard cable length is 7.6 m (24.9 ft) – BN52B-7F; maximum cable length is 304.8 m (1000 ft).

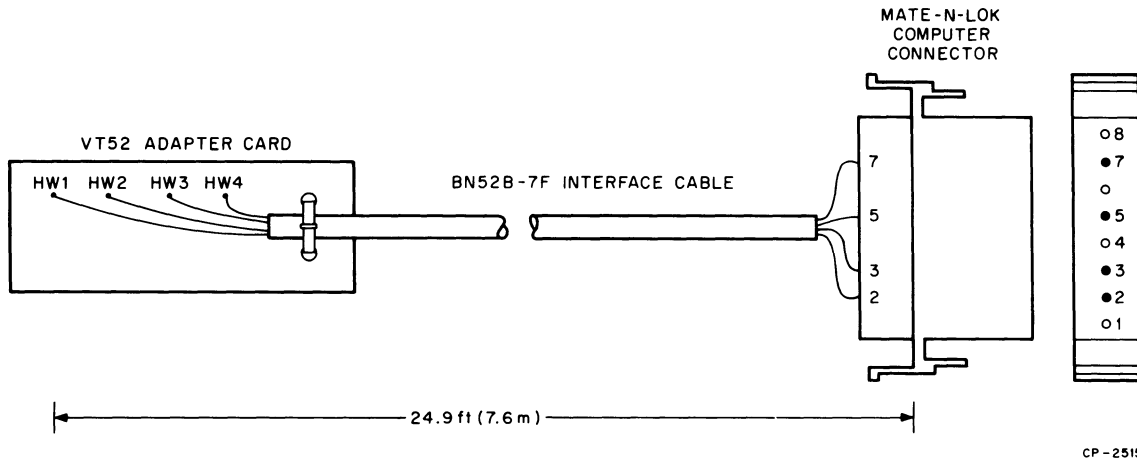

Figure 3-1 20 mA Interface Cable with Mate-N-Lok Connector

### 3.4.2 20 mA Interface Cable with 283B Connector

VT55 models HA, HB, HC, JA, and JB are supplied with a 20 mA interface cable terminated with a 4-prong, telephone-type plug which can be used for DECsystem-10 applications. The 4-prong plug can be removed and replaced with a connector more suitable for customer requirements if desired. Table 3-3 and Figure 3-2 provide signal and pin information for the cable and connectors. Table 3-4 provides part numbers for users desiring to order parts from DIGITAL to construct longer cables.

Table 3-3 20 mA Interface Cable Wire Color-Pin Assignments (283B)

Interface Cable Wire Color	Adapter Card Pin Number	Signal Assignment	283B Pin Color
White	HW1	Receive Positive	Black
Black	HW2	Receive Negative	Yellow
Green	HW3	Transmit Positive	Green
Red	HW4	Transmit Negative	Red

Table 3-4 20 mA Interface Cable (283B) Part Numbers

Description*	Part Number
Cable Type, 4-wire, No. 22 stranded	DEC 91-07706
Connector Type, 4-prong telephone (Male)	DEC 12-05857-01
Connector Type, 4-socket telephone (Female)	DEC 12-05857-02
VT52 20 mA Adapter Card	DEC 5411759

\*Standard cable length is 7.6 m (24.9 ft) - BN52C-7F; maximum cable length is 304.8 m (1000 ft)



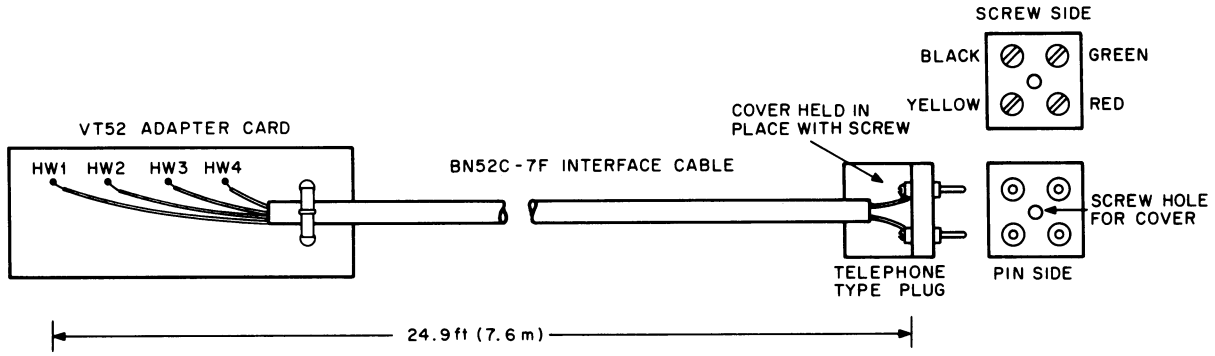

CP - 2516

Figure 3-2 20 mA Interface Cable with 283B Connector

**3.4.3 EIA Interface Cable**

VT55 models EE, EF, EH, FE, and FF are supplied with an EIA cable terminated with the standard 25-pin EIA type connector. The connector may be removed and replaced if desired to suit customer requirements. Table 3-5 and Figure 3-3 provide signal and pin information for the cable and connectors. Table 3-6 provides part numbers for users who want to order parts from DIGITAL to construct longer cables.

**Table 3-5 EIA Interface Cable Wire Color-Pin Assignments**

Interface Cable Wire Color	Adapter Card Pin Number	Signal Assignment	EIA Pin Number
Green	H1	Protective Ground	1
Blue	H2	Transmitted Data	2
Red	H3	Received Data	3
White	H4	Request to Send (Wired true = +10 V)	4
Black	H5	Signal Ground	7
Orange	H6	Data Terminal Ready (Wired true = +10 V)	20

**Table 3-6 EIA Interface Cable Part Numbers**

Description*	Part Number
Cable Type, 6-wire, No. 20 stranded	DEC 1700012
Connector Type, 25-Pin (Male)	DEC 12-10493-31
Connector Male Pins, 6 required	DEC 12-10493-39
Strain Relief, 2 required	DEC 12-10493-50
VT52 EIA Adapter Card	DEC 54-11448-1-0

\*Standard cable length is 7.6 m (24.9 ft); maximum cable length is 15.25 m (50 ft).

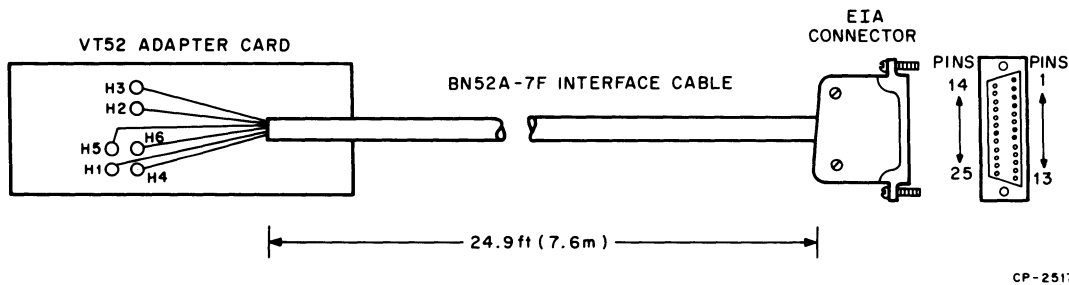

Figure 3-3 EIA Interface Cable

### 3.4.4 Changing VT55 Interface Cables

The following procedure should be followed when changing interface cables.

1. Set the VT55 on its top side and remove the base assembly from the bottom of the unit. (Refer to Chapter 6.)
2. Carefully remove the interface adapter card (EIA or either one of the two 20 mA adapter cards) from the ROM/UART module. (Refer to Figure 6-3, items 41, 42, and 43.)
3. Carefully install the new interface adapter card on the ROM/UART module. Orient the adapter card as shown in Figure 6-3. The components of the adapter card face down, in the direction of the microprocessor module on the underside of the unit. Ensure that the set of pins on the adapter card and the female socket connectors on the ROM/UART module are properly aligned before pressing the adapter card onto the ROM/UART module.
4. Route the interface cable through the hole in VT55 base and replace the base assembly.

### 3.4.5 Setting the Baud Rate Switches

When the VT55 is installed, an understanding of the baud rate and interconnection requirement of the host device is imperative. Paragraphs 4.3 and 4.4 discuss the meaning of full duplex, local mode, baud rate, EIA, parity, etc.

To set baud rate and interface mode switches S1 and S2 (Figure 3-4):

1. Tilt the unit on its back as shown in Figure 2-1.
2. With a coin or screwdriver, turn switches S1 and S2 fully counterclockwise. The switches are now in position 1-A (Figure 3-4).
3. Refer to Table 3-7 to adjust switches S1 and S2 to the desired interface mode and baud rate.

### 3.4.6 Setting the Parity Switches

Parity for the VT55 is selected by means of the PARITY NONE/EVEN switch and jumpers W5 and W6 on the underside of the unit. Figure 3-4 shows the locations of the switch and jumpers. To gain access to the parity switch and jumpers, lay the VT55 on its top side and remove the metal screen.

## 3.5 SERIAL LINE SIGNAL FORMAT

When data is transmitted from the VT55 to the host computer or received from the host computer by the VT55, an agreed-upon protocol must be utilized in order for the two units to recognize each other's transmission. This protocol is specified by EIA (Electronic Industry Association) Standard RS232-C.

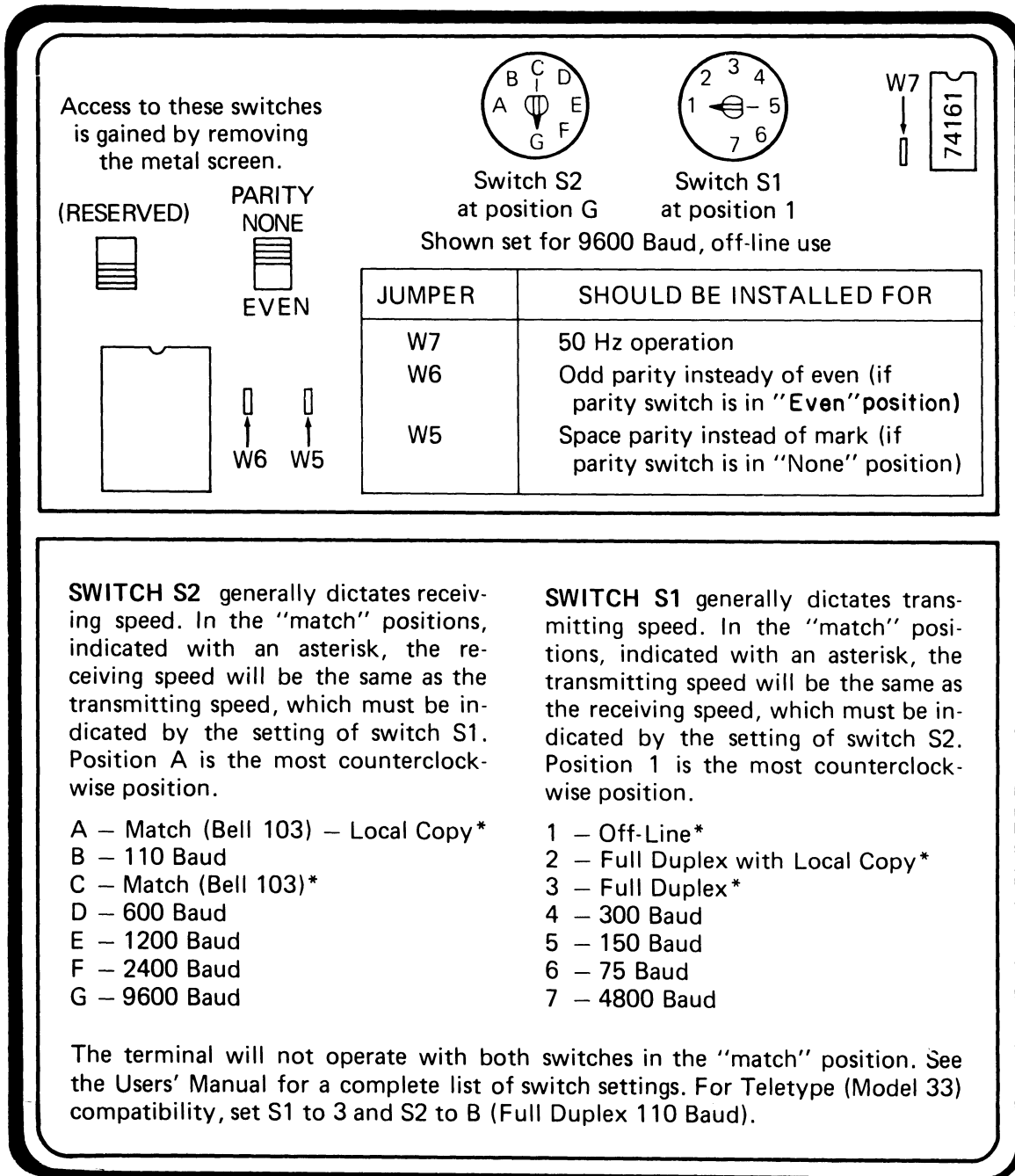

CP - 2528

Figure 3-4 Location of Underside Switches and Jumpers (Bottom View)

**Table 3-7 Baud Rate and Interface Mode Selection Switch Positions**

Environment	Desired Baud Rate		S1-S2 Switch Positions	Maximum Delay Time*
	Transmit	Receive		
Off-Line	9600	9600	1-G	These first five settings are functionally equivalent. (Since no interdevice communication occurs, the baud rate is irrelevant.) If the terminal is set for Off-Line use at 110 baud, the rate of repetition achieved with the REPEAT key will be noticeably slower.
	4800	4800	N/A	
	2400	2400	1-F	
	1200	1200	1-E	
	600	600	1-D	
	110	110	1-B	
Full Duplex With Local Copy	9600	9600	2-G	8.3 ms
	4800	4800	7-A	16.7 ms
	2400	2400	2-F	33.3 ms
	1200	1200	2-E	67 ms
	600	600	2-D	133 ms
	300	300	4-A	267 ms
	150	150	5-A	533 ms
	110	110†	2-B	800 ms
Full Duplex	9600	9600	3-G	9.4 ms
	4800	4800	7-C	18.8 ms
	2400	2400	3-F	37.5 ms
	1200	1200	3-E	75 ms
	600	600	3-D	150 ms
	300	300	4-C	300 ms
	150	150	5-C	600 ms
	110	110†	3-B	900 ms
	75	75	6-C	1200 ms
	4800	9600	7-G	7.3 ms
	4800	2400	7-F	41.7 ms
	4800	1200	7-E	88 ms
	4800	600	7-D	179 ms
	4800	110†	7-B	1100 ms
	300	9600	4-G	Negative
	300	2400	4-F	Negative
	300	1200	4-E	25 ms
	300	600	4-D	117 ms
	300	110†	4-B	1033 ms
	150	9600	5-G	Negative
150	2400	5-F	Negative	
150	1200	5-E	Negative	
150	600	5-D	50 ms	
150	110†	5-B	967 ms	

**Table 3-7 Baud Rate and Interface Mode Selection Switch Positions (Cont)**

Environment	Desired Baud Rate		S1-S2 Switch Positions	Maximum Delay Time*
	Transmit	Receive		
	75	9600	6-G	Negative
	75	4800	N/A	Negative
	75	2400	6-F	Negative
	75	1200	6-E	Negative
	75	600	6-D	Negative
	75	110†	6-B	833 ms

\*The host must receive and respond to an XOFF signal from the terminal within this interval from the time the VT55 transmitted it, to ensure that the Silo does not overflow. The indicated times include processing time as well as transmission delays both ways. "Negative" indicates that Silo overflow may occur regardless of delay and processing time. See Paragraph 3.5.4 of this manual for a complete description of the XOFF signal.

†At these settings, the terminal will supply an extra stop bit on each character it transmits, and wait for one on each character it receives. A total of 11 bits per character, rather than 10, will be used at these settings.

### 3.5.1 Word Length and Parity

Data words transmitted and received are 7-bit ASCII for Alphanumeric and Graphic modes, or 7-bit binary for Graph Drawing mode. Chapter 5 explains decoding of these seven bits. When these seven bits are interchanged between host and terminal, they are transmitted serially at the baud rate. The seven bits are contained within start and stop and parity bits to synchronize the interface when reading the seven bits of data.

At all baud rates except 110 baud, the transmitted data from the VT55 is in a 10-bit format. Data received by the VT55 is in a 10-bit format as well. With the parity switch set to NONE, a transmitted alphanumeric character "B" (ASCII 102) will appear as shown in Figure 3-5.

If the parity switch is set to EVEN, the stop bit in the ninth state is affected. This bit is no longer termed the "stop" bit but is called the "parity" bit. The parity bit is adjusted by hardware to ensure transmission of an even number of marks during any 10-bit word transmission. The fact that the receiver (the host computer) knows that an even number of marks is being transmitted allows it to detect errors that might occur due to poor communication links. In the example shown in Figure 3-5, state 9 would change from a mark to a space if the switch was set to EVEN. The even parity feature should only be used with a computer that can check incoming data for even parity. The VT55 does not check received data for parity; no error detection is done within the terminal.

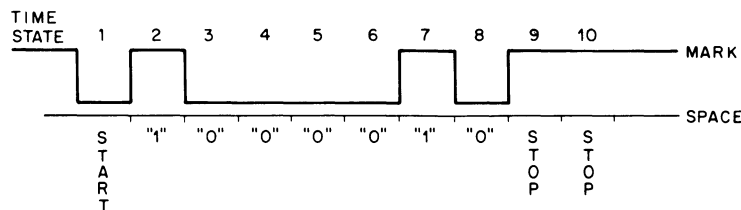

CP-2140

**Figure 3-5 Transmission (or Reception) of ASCII "B" with Parity Switch Set to NONE**

The transmitted and received word lengths are changed to 11 bits when 110 baud is chosen. This allows the VT55 to connect with 11-bit interfaces originally designed for 110 baud Teletype® applications. The effect of adding the 11th bit is the same as adding  $200_8$  to any 7-bit data word. In Figure 3-5, code  $102_8$  (B) would become code  $302_8$ . An extra mark would be inserted between time states 1 and 2, making an 11-bit word. The parity switch should be set to NONE to conform with a standard 11-bit Teletype format.

### 3.5.2 Baud Rate

The term baud means bits per second. A baud rate of 9600 means that 9600 bits are being transmitted over the serial line in 1 second. Since each word is 10 bits long, 960 words per second will be transmitted at this baud rate setting. Similarly, since 110 baud corresponds to transmitting 110 bits per second where each word is 11 bits long, 10 words per second are being transmitted. Baud rate is normally determined by the host computer and any restrictions imposed by the interconnecting transmission media.

### 3.5.3 Levels

When the VT55 is utilized with a 20 mA interface, a mark corresponds to the presence of a 20 mA current in the transmitter or receiver current loop, while a space corresponds to an absence of this current. (Refer to Figure 3-6.)

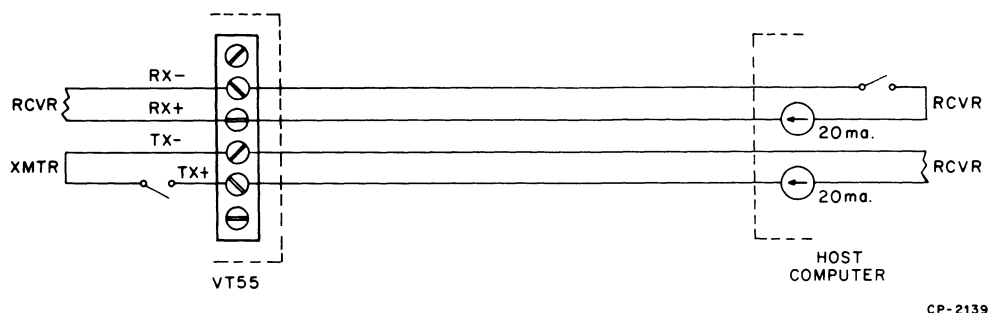

#### NOTE

The tolerance on the 20 mA current is  $\pm 10\%$ .

Figure 3-6 20 mA Current Loop Connection

With the EIA interface, these currents are replaced by voltage levels. A transmitted mark will be designated by a +10 V signal level and a space by a -10 V signal level. Received data will be interpreted as a logical 1 or mark if between +5 V and +25 V, and a space if between -5 V and -25 V. Both transmitted and received signals comply with EIA Standard RS232C.

### 3.5.4 Synchronization

Some terminals cannot process characters and commands as fast as the codes come in from the host. These terminals require the host to send several meaningless characters, called fillers, to the terminal in order to "pass the time" until the terminal is ready to process more data. The control codes 000 (NUL) and 177 (DEL) are most often used as fillers. Although no DECscope requires the host to send fillers at any time, the DECscope will ignore 000 and 177 when it receives them, so that software which uses these characters as fillers will not have to be rewritten to eliminate them.

®Teletype is a registered trademark of Teletype Corporation.

The only time the terminal fails to keep up with the data coming in from the host is when it is passing data to the electrolytic copier. In this case, rather than require the host to compute a complicated formula for how many fillers to send out and when, the terminal calculates on its own when it is getting behind, and sends a signal to the host to request it to stop transmitting. This signal is the control code XOFF (023). When the terminal has reduced its backlog, it sends another signal to the host to tell it to resume. This signal is XON (021). The terminal depends on the host to suspend its transmission when the host receives XOFF, and to resume the transmission from the point at which it left off when it receives XON.

The host's response to XOFF, however, will not be immediate, simply because it will take time for the XOFF code to travel down the wire to the host. After the terminal transmits XOFF to signify that it cannot process more data, it may receive several more codes before the host actually stops transmitting.

Therefore, the terminal places these codes in an internal buffer called the Silo, to be processed at a later time. When the terminal is ready to process more codes, it will take the codes out of the Silo in the order in which they were received, and process them before it sends XON to the host to request more data.

Effectively, there is room for 13 codes in the Silo. For most applications, this is sufficient to allow for transmission delays. It is not meant to be sufficient to let the host ignore XOFF. If the Silo fills up and the host keeps sending, the Silo "overflows." The codes in the Silo are removed and processed by the terminal in the order in which they were received, regardless of the situation at the terminal which had caused the delay.

One cause of the Silo overflowing is excessive processing time and transmission line delay. To illustrate, if the DECscope were connected to the host so that messages from the terminal reached the host 10 seconds after leaving the terminal, an XOFF sent by the terminal might not reach the host in time to halt the host's transmission.

Another cause for Silo overflow is the use of a receiving speed which is much more rapid than the transmitting speed. If the DECscope were set to receive at 9600 baud while transmitting at 300 baud,  $9600/300 = 32$  characters which could be received in the time it took the terminal to send XOFF. This problem would not exist if the transmission speed were also 9600 baud. Thus, the use of high baud rates is not by itself a cause of synchronization failure, although it does magnify the effect of long delay times.

The sufficiency of the DECscope's Silo can be calculated using the formulas:

$$(D + d + P) Y + (2Y/X) + 2$$

to yield the number of characters that the VT55 would have to buffer at worst case. If this equation produces a number 13 or less, the DECscope will fit the application since the effective length of the Silo is 13 characters. In the equation above:

D = Transmission delay from terminal to host (in seconds)

d = Transmission delay from host to terminal (in seconds)

P = Processing delay (in seconds). (P is the interval from the time the host physically receives XOFF and the time software transmits its last character before stopping in response to the XOFF.)

Y = Receiving speed of the terminal (in char/second\*)

X = Speed at which the terminal transmits (in char/second\*)

The 2s in the formula reflect the fact that the host's interface hardware and that of the DECscope (that is, the UARTs) will buffer two characters in each direction.

As an example, consider a VT55 communicating to a host at 300 baud (transmitting and receiving) over a telephone line. The telephone company specifies that the worst-case transmission delay is not greater than 50 ms. In this example, the processing delay was zero since, when the host received XOFF, it trapped to a routine which disabled output. So the last character the host transmitted to the terminal would occur before receiving XOFF. Since transmitting and receiving speeds are both 30 char/second, the equation is:

$$(0.050 + 0.050 + 0) 30 + 2 (30/30) + 2 = 7$$

A terminal with a 7-character input buffer is required. The DECscope, with its 13-character Silo, is adequate for the application.

When the DECscope is set for local copy, the effective length of the Silo is reduced to 12 characters, since the XOFF transmitted by the terminal goes into its own Silo. Note that in this situation the operator could cause the Silo to overflow by continuing to type, since the characters typed will likewise go into the Silo.

Table 3-7 lists each combination of receiving and transmitting baud rates, the time (D + d + P) by which the host must be able to respond to XOFF in order to prevent Silo overflow.

*Software must respond to XON/XOFF* if the copier is being used and there is a possibility that the host will be sending data to the terminal while the copier is running.

In Hold Screen mode, the terminal uses these same XOFF and XON signals again, not because the terminal cannot keep up with the data from the host, but simply to hold the present data on the screen until the operator gives the terminal a request for new data. *Software must respond to XON/XOFF* if Hold Screen mode is being used.

### 3.6 ADJUSTING VT55 NOMINAL LINE VOLTAGE

Adjusting the nominal operating line voltage of the VT55 requires a simple tap change of the power transformer utilized on VT55 models EB, EC, EF, EH, HB, HC, FB, FF, and JB. The procedure for altering the nominal line voltage is as follows:

1. Remove the ac power cord. You are altering the wiring on the primary side of the transformer. If the VT55 does not have a copier, then remove the copier cover (Figure 6-4) and proceed to step 6.
2. Place the VT55 on its top side and remove the base assembly.
3. Check to see that the ac power cord is removed.
4. Remove the ROM/UART module. (Refer to Paragraph 6.2.3.)
5. Remove the front panel on the right of the CRT (Figure 3-7) by applying pressure to the plastic tab which is accessible through the bottom on the VT55.

---

\*9600 baud = 960 char/second, 1200 baud = 120 char/second, etc. but 110 baud = 10 char/second.



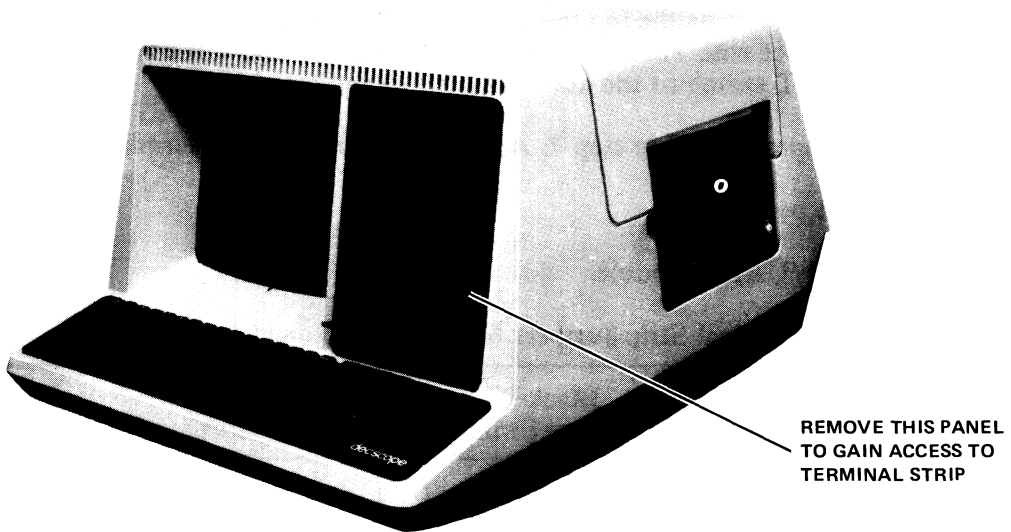

8009-5

Figure 3-7 Access to AC Power Terminal Strip

6. Locate the 10-screw terminal strip mounted behind the front panel (Figure 3-8).

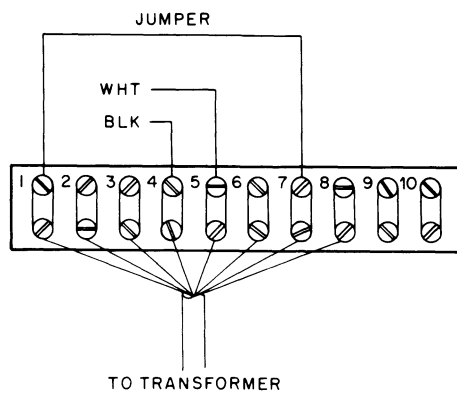

CP-2134

**NOTE**  
Terminal assignments shown wired for 240 Vac.

Figure 3-8 10-Screw Terminal Strip

7. Remove existing jumpers on the top screws of the 10-screw terminal strip. Add new jumpers to these in accordance with Table 3-8. Also move the black and white wires from the POWER/LOGIC RESET switch to the new terminals as indicated.
8. Double check jumpers added in step 7. An error will damage the terminal.
9. Replace the front panel.
10. Replace the ROM/UART module.

**Table 3-8 AC Terminal Strip Jumpers for Different Nominal Line Voltages**

VT55 Model No.	Optional Nominal Line Voltage (Vac)	Black Wire from Switch	White Wire from Switch	Add Jumpers
EB, EF, FB, FF, HB, JB	220	3	5	1-7
	230	4	5	1-6
	240	4	5	1-7
EC, EH, HC	100	2	1	2-6, 1-5
	110	3	1	3-7, 1-5
	127	4	1	4-8, 1-5

11. Replace the base assembly and write the new nominal line voltage on the base decal.
12. Set the VT55 on its base.
13. The nominal line voltage alteration is now complete. Connect the ac power cord to a suitable ac source.

### 3.7 CHANGING VT55 LINE FREQUENCY - NON-COPIER MODELS ONLY\*

VT55 DECscope models EB, EC, EF, EH, HB, and HC are shipped configured for 50 Hz power source operation. In some circumstances, 60 Hz power source operation may be required. This is easily accomplished by clipping three jumpers within the VT55. These three jumpers control whether the information display is refreshed 50 or 60 times per second. Annoying screen flicker is eliminated by refreshing the VT55 screen at the same frequency as overhead lighting fixtures and predominant electromagnetic fields in the room. The VT55 may be changed to operate from a 60 Hz power source as follows:

1. Turn the VT55 on its back and remove the VT55 base assembly. (Refer to Figure 6-3.) Ensure that the power cord is unplugged.
2. Locate the ROM/UART module in Figure 6-3. Clip jumper W7 adjacent to the baud rate switch as shown in Figure 3-4.
3. Locate jumpers W1 and W2 on the M7024 Graphing module. Locate P4 on Figure 6-3 and then use Figure 3-9 to find W1 and W2. Clip out jumpers W1 and W2 for 60 Hz operation.
4. Reassemble the VT55. The screen will now refresh at a rate of 60 times per second.

\*Units with copiers cannot be altered because copier motors are fixed at 50 Hz or 60 Hz.

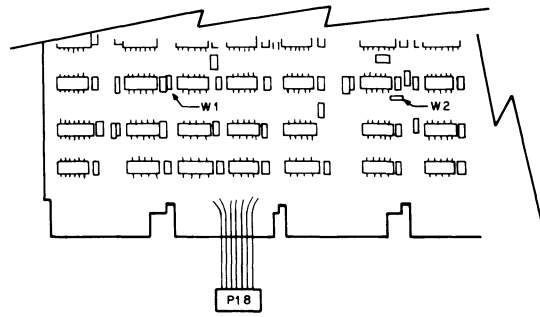

CP - 2138

Figure 3-9 Location of W1 and W2 on the M7024 Graphing Module



## CHAPTER 4 TECHNICAL DESCRIPTION

### 4.1 INTRODUCTION

This chapter presents a technical description of major features and operating modes of the VT55 DECscope. A brief discussion of the raster scan technique, communicating with the VT55, the Alphanumeric and Graph Drawing modes, the Escape mode and special terminal commands, and the copier are presented.

### 4.2 RASTER SCAN TECHNIQUE

As mentioned in Chapter 1, the display of alphanumeric and graphic data is performed by the raster scan method. Raster scan infers that the beam of the cathode ray tube is swept completely across the phosphor surface of the tube 50 or 60 times (depending on the power line frequency) in a second. Information, generated via the memory, turns the beam on and off, intensifying dots on the phosphor at the proper time to produce characters and graphics on the video screen. This is basically the same method used by consumer television sets. The method is reliable and produces flicker-free display information. No vertical or horizontal hold controls are used by the VT55. These controls are eliminated by synchronizing the raster scan and intensification information to the VT55 microprocessor.

### 4.3 COMMUNICATING WITH THE VT55

For most applications, the VT55 will be interfaced to a host computer and operated in the full duplex communication mode. Figure 1-3 shows a simplified full duplex interface. Data transmitted by the VT55 is received by the host computer. Data received by the VT55 is determined solely by the host computer. This is the typical interface that is desired in an interactive man-machine environment. However, two other terminal interface modes are available. These modes are shown in Figure 4-1. The terminal mode switch is set to the full duplex mode. When the local copy switch is closed, data received from the host computer or transmitted by the VT55 appears on the video screen.

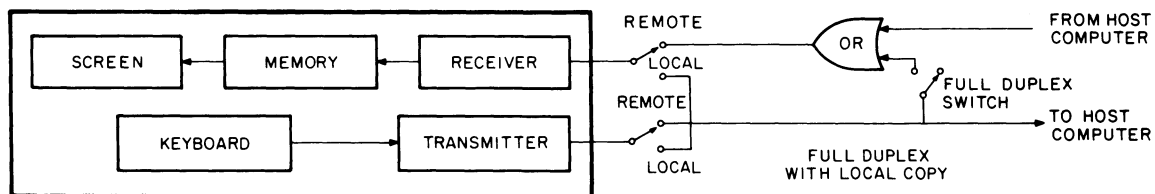

CP-2144

Figure 4-1 Interface Modes

This full duplex with local copy mode of operation is useful when the host computer does not generate an immediate echo or response to a keyboard transmission, and a visual verification of the information being sent is desired. Making this local copy connection in no way affects the way in which the host computer interfaces with the VT55. When no connection with the host computer is desired, the serial line input/serial line output may be disconnected by placing the VT55 in the local mode. Local mode is normally used for off-line hardware maintenance, training, or use of the copier. Selection of the mode of the terminal interface is made via switches under the VT55. These switches also determine the transmit and receive baud rates of the unit.

The VT55 is capable of sending and receiving at baud rates from 75 to 9600 bits per second. Data is sent in serial digital format for the 20 mA interface models. A logical 1 is represented by the presence of a 20 mA current, a logical 0 by the absence of current. The 20 mA current is referred to as a 20 mA current loop. The EIA interface models allow the use of the VT55 with RS232-C signals. EIA specifications define a logical 1 as a negative voltage and a logical 0 as a positive voltage.

When a digital word is transmitted to the host computer from the VT55 keyboard, it is transmitted as the ASCII representation of the depressed key. The VT55 will transmit the 96-character ASCII set which includes all upper- and lowercase letters plus numbers and special symbols. In addition, the set of 32 control codes may be transmitted.

When a digital word is received by the VT55, it may be interpreted in one of three ways: as alphanumeric/graphic information, as terminal control information, or as graph drawing information. When the terminal is powered on, it assumes the Alphanumeric mode and translates, in accordance with ASCII, incoming displayable information as the 96-character set mentioned above. The letter or numeral representation of the transmitted code is stored in the alphanumeric memory and is displayed on the screen. Certain codes in the 32-character control code set of ASCII, when received, affect VT55 operation. These control codes, sometimes in combination with alphanumeric characters, cause the screen to erase, the VT55 internal bell to sound, a hard copy to be generated, etc., when received. One sequence switches the VT55 to the Graph Drawing mode.

When the VT55 is in the Graph Drawing mode, the receipt of the 96-code set that represented numbers and letters in the Alphanumeric mode is now interpreted in accordance with a unique code that treats the digital information as graph instructions and data. These place the graph points, markers, and grids on the display, superimposed on any alphanumeric information. A different control code sequence reverts the VT55 back to the Alphanumeric mode.

#### **4.3.1 Alphanumeric Mode**

When the VT55 is powered on, the terminal is in the Alphanumeric mode. Data received via the serial line input is stored in the alphanumeric memory and printed as characters, numerals, and symbols on the screen if the code represents a printable character.

Received printable symbols are displayed on the video screen in a 24-horizontal line by 80-vertical column format. Each character is displayed as a  $7 \times 7$  dot matrix; the matrix size is approximately 4.0 mm  $\times$  4.0 mm. Character placement on the screen is controlled by the alphanumeric cursor. The cursor is a blinking, underlining line that indicates the screen position in which the next received character is to be placed. When receiving a new character, the cursor automatically increments to the right. The cursor may also be shifted around the screen by receipt of alphanumeric cursor control commands or the auxiliary keypad. When the VT55 receives a line feed code, the alphanumeric cursor moves down one line. Upon receipt of the alphanumeric carriage return, it moves to column one of the current line. By the use of other control sequences, the cursor may be moved up one line, back one space (backspace), right one space, homed (line one-column one), and tabulated (tab) eight spaces to the right. The alphanumeric cursor may also be used to erase alphanumeric text from the cursor position to the end of the current line or to the end of the entire screen. These features of the alphanumeric cursor greatly facilitate text handling on the VT55.

In order to plot graph data on the VT55 screen, it is necessary to take the terminal out of the Alphanumeric mode. This is accomplished by receipt of a special control sequence that causes the VT55 to treat receipt of noncontrol ASCII as graph plotting information rather than alphanumeric information. The VT55 may be returned to the Alphanumeric mode by the receipt of a second unique control sequence.

#### 4.3.2 Graphics Mode

Graphics mode performs in essentially the same way as Alphanumeric mode with regard to character font, control codes, etc. The only difference is that the subset of 32 lowercase characters is replaced by a set of 30 special characters to extend the capability of the terminal in printing equations and fractions and plotting line graphs.

#### 4.3.3 Graph Drawing

When the VT55 is in the Graph Drawing mode, incoming digital data, aside from the control codes, is treated as graph plotting information. This data represents Graph Drawing mode instructions and data points as defined in Chapter 5. The VT55 can plot two 512-point graphs, graph 0 and graph 1, each represented as a line graph or histogram. Vertical and horizontal lines that span the viewable screen area may be displayed anywhere in the viewable area of the screen. These lines can be combined to form grids to aid in labeling values on the graphs. The VT55 has graph markers as an additional graph feature. These are short vertical markers useful in defining important features on the graph. All graph features of the VT55 are individually controllable by the programmer. All data is stored in a separate graph memory. Keeping graph information separate from the alphanumeric information storage allows superposition of the alphanumeric and graph information and allows the removal of one type of information without affecting the other. For example, a label could be printed over a graph and then removed without affecting the graph.

Figure 1-2 shows the individual types of data displayable on the VT55, and how they are superimposed to form a complete representation. Each graph image on the screen is formed by storing X-Y coordinate points in memory and then point-plotting the image on the screen.

Figure 1-2a shows graph 0 as a typical line graph with the graph markers that may be plotted on the VT55. The graph may have a horizontal resolution of 512 points and a vertical resolution of 236 points. The graph must be a single-valued function of X. Two points may not be stored on a single X coordinate on a given graph. A graph marker may be individually turned on or off at any X coordinate on either graph 0 or graph 1. The graph marker will automatically be attached to the graph at the corresponding Y position.

Figure 1-2b shows a histogram display on graph 1. When a histogram is desired, the VT55 simply intensifies all points below the line graph envelope of the desired histogram; that is, if graph 0 is desired as a histogram, the VT55 intensifies all points under the outline as shown in Figure 1-2a. Of course, the histogram intensification could be removed, leaving just a line graph. Graph 1 has the same specification, with regard to resolution and graph markers, as graph 0.

Figure 1-2c shows a typical grid formed on the screen of the VT55 by combining horizontal and vertical lines. As many as 512 horizontal and 236 vertical lines may be individually displayed and cleared from the screen. With this flexibility, almost any other type of coordinate scheme, such as logarithmic, may be plotted.

Figure 1-2d shows the three previous plots superimposed. A well-defined graph drawing display has been formed. Note how graph 0 is clearly visible through the histogram of graph 1. Alphanumerics are viewable through the histogram as well. However, alphanumeric characters would not be readable if both graphs were displayed as histograms and alphanumeric characters were plotted in an overlapping area of the two graphs. Also note that column 1 and line 24 of the alphanumeric display are outside of the graph field for easy readability of coordinate labels.

The VT55 has an ensemble of nine graph commands which permit loading of individual points on the two graphs and loading and clearing of individual markers, vertical lines, and horizontal lines. The user may choose to blank this data from the screen, but hold the data in the internal graph memory for later viewing. All graph memory may be cleared with one instruction when desired.

#### **4.3.4 Escape Mode and Special Terminal Commands**

There are certain control commands which are not unique to the Alphanumeric or Graph Drawing operation. These commands are utilized to facilitate interaction with the host computer or the VT55 copier. Important to these control commands is the concept of the Escape mode sequence. When in Escape mode, the VT55 microprocessor examines the next incoming character to see if this 2-character escape sequence has any special meaning. If the 2-character escape sequence has a meaning to the VT55, the operation of the VT55 will be modified. If the sequence has no meaning, the VT55 returns to the Alphanumeric or Graph Drawing mode. Escape mode is instrumental in alphanumeric cursor control and switching from Alphanumeric to Graph Drawing mode and back again.

The codes ESC [ put the VT55 into a Hold Screen mode. Hold Screen mode is used normally in Alphanumeric mode to halt the transmission of data to the serial line input. It is sometimes desired to hold a screen full of data for examination before allowing more data to be displayed. When a 25th line of data is received, the VT55 normally scrolls the first line off the screen. When Hold Screen mode is invoked, a control signal termed XOFF is transmitted to the host computer to request the computer to stop transmission. If the computer is programmed to respond to this code, the user can examine the display at his leisure. Using the special key labeled SCROLL in conjunction with the SHIFT key, the VT55 can be made to display one or more lines of text by scrolling once, or a whole new display of text by scrolling 24 times. This is accomplished by sending an XON control character to the computer to request it to resume sending.

Hold Screen mode is terminated by receipt of the 2-character escape sequence ESC \. Escape sequences are also used to allow the VT55 to identify itself. Anytime the VT55 receives the 2-character escape sequence ESC Z, it responds by transmitting the 3-character sequence ESC / E, which identifies the terminal as a VT55, a unit with graphic capability. A VT55 or similar DIGITAL product will always respond with this unique code.

Lastly, escape sequences are utilized for the VT55 copier operation. When a VT55 with copier receives these defined 2-character escape sequences, it can be made to perform the following three things:

1. Copy all lines from the top of the screen to and including the marker line. Any graph drawing information above the alphanumeric cursor line will be copied as well.
2. Copy all lines up to but not including the alphanumeric cursor line; then copy a new line after each new line feed is received (called auto-copy mode).
3. Disable the auto-copy mode.

In addition, a special key on the VT55 keyboard labeled COPY can either copy the entire screen or invoke the auto-copy mode (with use of the SHIFT key). Auto-copy mode is designed to furnish a line printer type listing when dealing strictly with alphanumeric text. It should not be used when graph drawing data is displayed on the screen.

#### **4.3.5 VT55 Keyboard**

The VT55 keyboard is compatible with ANSI Standard X 4.14 standard typewriter keyboard. It is also the standard keyboard layout incorporated on other terminals manufactured by Digital Equipment Corporation. This keyboard layout, shown in Figure 4-2, is similar to the layout found on an office typewriter, rather than on a keypunch machine. It contains the keys that generate the 96-character set of ASCII and a control key for the generation of the 32 control codes. Unique VT55 function keys are on the keyboard as well.



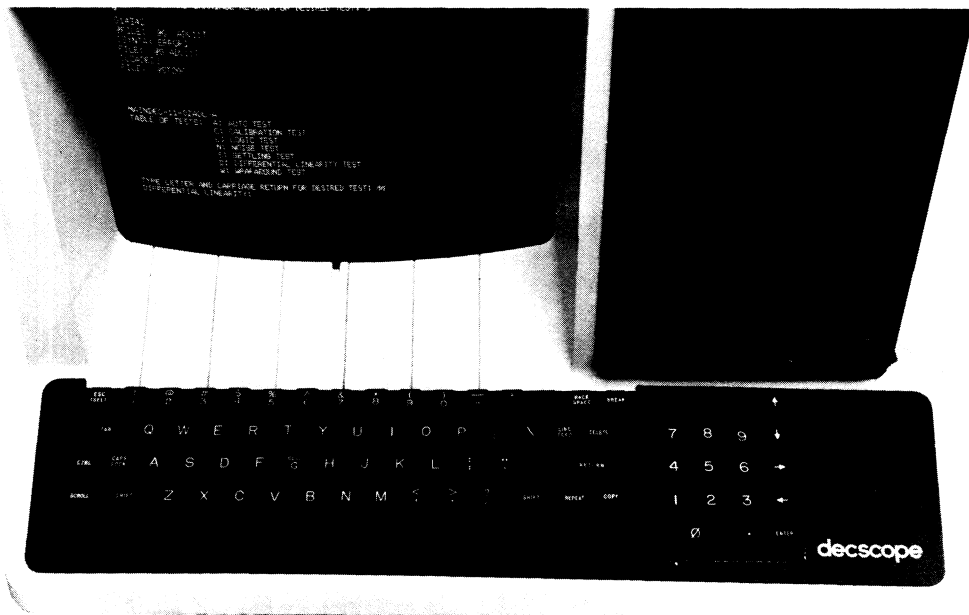

8009-2

Figure 4-2 VT55 Keyboard

The unique control keys on the keyboard are duplicates of control codes that may be generated from combinations of other keys on the keyboard. However, since these keys tend to be utilized quite often by the operator, they are furnished as separate keys. These keys include ESC, TAB, BACKSPACE, LINE FEED, RETURN, and REPEAT.

Two keys which do not transmit data via the serial line port of the VT55 are also contained on the keyboard. These keys are SCROLL and COPY. The actual functions of these keys were explained in Paragraph 4.3.3.

In addition to the above-mentioned keys, the VT55 contains a BREAK key. The break function is included to allow the interruption of incoming data when utilizing the VT55 in a half duplex system. Chapter 5 covers this subject in more detail.

The VT55 keyboard electronics has a feature called 3-key rollover. This feature allows error-free data transmission from the VT55 even if two keys are held down while a third key is depressed, as long as one of the first two keys is released before the third key is released. Three-key rollover is a feature meant to reduce missing character errors due to very fast typing.

The keyboard also produces an audible keyclick sound that gives the operator feedback telling him that the key was properly depressed. This feature may be disabled for quiet environments. Additionally, the 16-key auxiliary keypad provides for special user characters as well as marker position keys.

#### 4.4 VT55 COPIER

VT55 models FA, FB, FE, FF, JA, and JB are supplied with an internal copier. The copier allows the user to make a hard copy duplicate of the video screen. The paper copy includes the displayed graphs as well as the alphanumeric characters. The copier is contained within the VT55 cabinet and the paper output emerges from the right side of the terminal. (Refer to Figure 4-3.) Upon command, the VT55 generates a hard copy of the display on the screen. Using a scanning technique, the terminal generates the image of the display in about 25 seconds. The display image is approximately 3 inches high. As the copier uses rolled paper, many lines of text and graphs may be formatted on a standard letter-size sheet of paper. The roll is 8-1/2 inches wide by 120 feet long. Hence, approximately 480 display images may be copied onto a roll of paper.

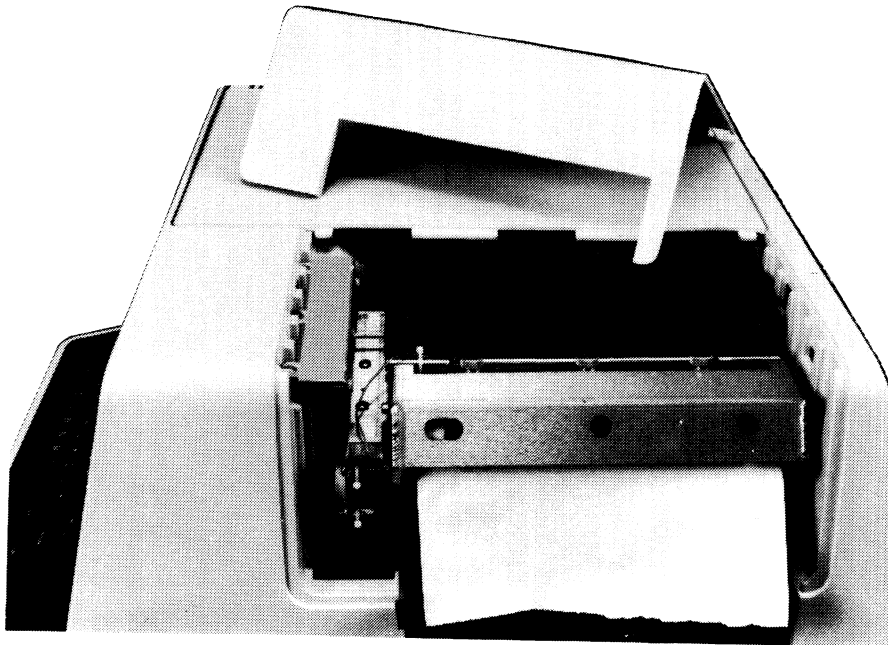

7717-5

Figure 4-3 VT55 with Copier

Each character of the screen's alphanumeric content is reproduced as a  $7 \times 7$  dot matrix on the paper. Graphs are represented in a  $512 \times 236$  point matrix as on the VT55 screen. Characters, graphs, histograms, grids, and graph markers may be copied by the copier.

Superimposed information on the screen appears as one shade on the hard copy output. The hard copy unit is capable of producing one shade of intensity while the video screen can simulate two. Therefore, it might be necessary to manually fill in lines from the hard copy output due to superposition. Superposition usually occurs when a histogram is overprinted on other data.

As mentioned previously, the VT55 copier uses a scanning technique similar to the method employed in facsimile picture transmission. The technique consists of scanning an electrode across a surface of special recording paper in exactly the same pattern as the raster scan on the VT55 screen. An electrode on the opposite face of the paper receives a voltage from the VT55 microprocessor in conjunction with the image to be recorded. The potential across the two electrodes causes a current to pass through the recording paper and actually plates metal from one of these electrodes onto the paper to form a dark point.

The VT55 copier is of simple design and thus is extremely reliable and requires little maintenance. All that is required of the user is the changing of the metal anode electrode, the removal of excess paper build-up from the cathode electrode when changing to a new roll of paper, and the moistening of the paper wet pad. There are no adjustments to be concerned with. The copier is controlled manually from the keyboard or by special control codes as mentioned in Paragraph 4.3.4.

## **CHAPTER 5**

### **OPERATION AND PROGRAMMING**

#### **5.1 INTRODUCTION**

This chapter first discusses the normal, everyday procedures involved in utilizing the VT55 with a host computer, data set, or other communications device. It is assumed that the terminal was installed in accordance with the installation procedure of Chapter 3. Any changes of the baud rate/mode switches, serial line connections, or parity switch are discussed in that chapter. In addition, an off-line procedure is included in Chapter 3 to familiarize you with some of the terminal's functions.

The second part of this chapter discusses the terminal's capabilities in Alphanumeric, Graphic, Graph Drawing, and Escape modes. An explanation of how these modes work together and concise charts containing programming data are included. The end of this chapter contains sample programs that exercise many of the functions discussed.

#### **5.2 OPERATION**

##### **5.2.1 Powering on the VT55**

1. Apply power to all components of the terminal by setting the POWER/LOGIC RESET switch to ON.
2. Wait about 1 minute. The blinking alphanumeric cursor (Figure 5-1) will appear in the top left corner of the screen; this is called the home position.
3. If the blinking cursor fails to appear after 1 minute, the intensity control may be set too low. Similar to the brightness on a standard television set, the intensity control should be adjusted to achieve maximum image clarity on the screen.
4. The terminal is now ready to operate with a host device or, if in local mode, may be exercised off line.

##### **5.2.2 VT55 Models with Internal Copier**

Operation of the VT55 is covered in the *VT Series Copier User's Manual*, EK-VT5C-OP-001. It is included with each VT55 DECscope that contains a copier.

ESC F puts the terminal in Graphic mode. ASCII codes which usually stand for the lowercase letters and some symbols will cause 1 of the VT55's 30 special symbols (Table 5-4) to be displayed on the screen.

Control codes, when received in Graphic mode, are performed and the unit remains in Graphic mode. Escape sequences put the terminal into Escape mode, and after the function is performed, the terminal reverts back to the Graphic mode. Again there are two exceptions, ESC G and ESC I. ESC G switches the terminal back to Alphanumeric mode.

ESC I, whether the terminal is in Graphic or Alphanumeric mode, switches the terminal to Graph Drawing mode. Incoming data that is normally a printable ASCII character becomes information for generating graphs on the screen. When control codes are received, they are performed and the unit remains in Graph Drawing mode. Once again, escape sequences put the terminal in Escape mode, and after the function is performed, the unit returns to Graph Drawing mode. Here again, there are exceptions. The sequence ESC 2 causes the terminal to leave Graph Drawing mode and return to whatever mode, Graphic or Alphanumeric, the terminal was in before it entered Graph Drawing mode. This is the only sequence that will bring the terminal out of Graph Drawing mode. ESC F and ESC G will not cause the terminal to leave Graph Drawing mode, but they will control the mode that the terminal will enter when ESC 2 is received. In Figure 5-2, the only difference between the two Graph Drawing modes is the mode that the terminal will go to if ESC 2 is received. Otherwise, they are identical.

Hence, the terminal can be looked at as having three permanent states – Alphanumeric mode, Graphic mode, and Graph Drawing mode. These three modes are switched by escape sequences. A temporary mode, Escape mode, is used for exercising special control functions. In addition, standard ASCII control functions, such as line feed, may be exercised at any time without disturbing the mode of the terminal.

In some cases it is possible for a program that is under development to erroneously leave the terminal in Escape, Graph Drawing, or Graphic mode when control of a monitor program on the host computer is desired. The POWER/LOGIC RESET switch will always return control to the Alphanumeric mode when this is required. The keyboard will always transmit appropriate ASCII codes when a key is pressed, but the terminal will misinterpret alphanumeric input as graphic, graph drawing, or escape code data if the terminal is not in the Alphanumeric mode.

## **5.3 THE KEYBOARD**

### **5.3.1 Using the Keyboard**

The operator uses the keyboard to transmit codes to the host. Using the keyboard is the only way the operator can transmit codes to the host. In general, transmitting codes to the host is the only function the keyboard performs.

Some keys transmit one or more codes to the host immediately when typed. Other keys, such as the SHIFT keys, do not transmit when typed. Instead, when held down, they modify the codes transmitted by other keys. The code-transmitting keys cause the terminal to make a clicking sound to verify to the operator that the keystroke has been processed by the terminal. If two code-transmitting keys are held down together, two codes will be transmitted according to the order in which the keys were typed. The terminal will not wait for the keys to be lifted, but will transmit both codes as soon as possible after the keys are first typed. If three such keys are held down simultaneously, the codes for the first two keys are transmitted immediately; the code for the third will be transmitted if and when one of the first two keys is lifted.

Table 5-1 shows the standard ASCII code that may be generated by the keys of the VT55 keyboard. Columns 0 and 1 are termed control codes. They are the set of 32 nonprintable characters normally used for terminal control. Columns 2–7 are called printable characters. They contain upper- and lowercase letters, numbers, and symbols.

Table 5-1 Code Ensemble of ASCII Keyboard – Transmitted Codes

<div style="display: flex; align-items: center;"> <div style="writing-mode: vertical-rl; transform: rotate(180deg); margin-right: 5px;">Bits</div> <div style="margin-right: 5px;"> <math>b_7</math>  <math>b_6</math>  <math>b_5</math> </div> <table border="1" style="border-collapse: collapse;"> <tr> <td style="padding: 2px;"><math>b_4</math></td> <td style="padding: 2px;"><math>b_3</math></td> <td style="padding: 2px;"><math>b_2</math></td> <td style="padding: 2px;"><math>b_1</math></td> <td style="padding: 2px;">Column →</td> </tr> <tr> <td style="padding: 2px;">↓</td> <td style="padding: 2px;">↓</td> <td style="padding: 2px;">↓</td> <td style="padding: 2px;">↓</td> <td style="padding: 2px;">Row ↓</td> </tr> </table> </div>					$b_4$	$b_3$	$b_2$	$b_1$	Column →	↓	↓	↓	↓	Row ↓	0	0	0	0	1	1	1	1
					$b_4$	$b_3$	$b_2$	$b_1$	Column →													
↓	↓	↓	↓	Row ↓																		
					0	0	1	1	0	0	1	1										
					0	1	2	3	4	5	6	7										
0					NUL	DLE	SP	0	@	P	'	p										
0 0 0 1					SOH	DC1	!	1	A	Q	a	q										
0 0 1 0					STX	DC2	"	2	B	R	b	r										
0 0 1 1					ETX	DC3	#	3	C	S	c	s										
0 1 0 0					EOT	DC4	\$	4	D	T	d	t										
0 1 0 1					ENQ	NAK	%	5	E	U	e	u										
0 1 1 0					ACK	SYN	&	6	F	V	f	v										
0 1 1 1					BEL	ETB	'	7	G	W	g	w										
1 0 0 0					BS	CAN	(	8	H	X	h	x										
1 0 0 1					HT	EM	)	9	I	Y	i	y										
1 0 1 0					LF	SUB	*	:	J	Z	j	z										
1 0 1 1					VT	ESC	+	;	K	[	k	[										
1 1 0 0					FF	FS	,	<	L	\	l	{										
1 1 0 1					CR	GS	-	=	M	]	m	}										
1 1 1 0					SO	RS	.	>	N	^	n	~										
1 1 1 1					SI	US	/	?	O	—	o	DEL										

When a key is pressed, the ASCII code is transmitted to the host device when the terminal interface is set to a full duplex mode. Any effect on the VT55 will only occur when the computer transmits a response to the VT55. When in local or full duplex with local copy mode, the terminal will be directly affected by this code. This is discussed in subsequent paragraphs.

**5.3.1.1 ASCII Codes** – Table 5-1 shows the ASCII code that each key on the keyboard generates. The binary representation of the ASCII character is found by taking the three binary bits of the column,  $b_7$   $b_6$   $b_5$ , and merging these with the  $b_4$   $b_3$   $b_2$   $b_1$  of the row to form  $b_7$   $b_6$   $b_5$   $b_4$   $b_3$   $b_2$   $b_1$ . For example, the binary representation of letter H is  $b_7$   $b_6$   $b_5$   $b_4$   $b_3$   $b_2$   $b_1 = 1001000$ . As ASCII characters are normally referred to in octal, H would correspond to  $110_8$ .

**5.3.1.2 Shift Key** – Lowercase letters, numerals, and some symbols are generated directly by pressing the corresponding key on the keyboard. Uppercase letters and symbols –  $!@\$ \% \& * () + [ : " < >$  and  $? -$  are generated by pressing SHIFT in conjunction with the correctly labeled key (Figure 5-3).

**5.3.1.3 CAPS LOCK Key** – When this key is in the pressed position, it causes the terminal to generate uppercase letters instead of lowercase letters. This is its only function. None of the other keys are affected.

However, if software must be able to distinguish between, for instance, the pressing of the 5 key on the auxiliary keypad and the pressing of the 5 key on the main keyboard, the host can give the terminal a command to place it in Alternate Keypad mode. In Alternate Keypad mode, the functions of the blank keys and the keys labeled with arrows do not change, but the numeral, decimal point, and ENTER keys all transmit unique escape sequences. Now all the keys on the auxiliary keypad are user-definable. Table 5-2 lists the codes that may be transmitted with these keys.

**Table 5-2 Codes Transmitted to Host by VT55**

Key	VT55 Not In Alternate Keypad Mode	VT55 In Alternate Keypad Mode
0	060	033 077 160 (ESC ? p)
1	061	033 077 161 (ESC ? q)
2	062	033 077 162 (ESC ? r)
3	063	033 077 163 (ESC ? s)
4	064	033 077 164 (ESC ? t)
5	065	033 077 165 (ESC ? u)
6	066	033 077 166 (ESC ? v)
7	067	033 077 167 (ESC ? w)
8	070	033 077 170 (ESC ? x)
9	071	033 077 171 (ESC ? y)
.	056	033 077 156 (ESC ? n)
ENTER	015	033 077 115 (ESC ? M)

**NOTE**

None of the keys on the auxiliary keypad are affected by depressing the SHIFT, CAPS LOCK, or CTRL keys.

**5.4 ALPHANUMERIC MODE**

When the terminal is in Alphanumeric mode, information received by the terminal is interpreted as letters, numerals, and terminal control information. The data may be generated by the host computer or the keyboard, depending on the interface mode of the machine. Where data is placed on the screen is determined by the position of the alphanumeric cursor.

**5.4.1 Alphanumeric Cursor**

The alphanumeric cursor is controlled by either control codes or escape sequences. This cursor may be moved whether the terminal is in Alphanumeric, Graph Drawing, Graphic, or Escape mode. Table 5-3 lists the codes that the VT55 responds to when it is in Alphanumeric mode. Although the function of control codes and escape sequences will be discussed in later paragraphs, as they are common to all three modes of terminal operation, it is worthwhile to mention codes BS, HT, LF, and CR now. Backspace, Horizontal Tabulate, Line Feed, and Carriage Return are utilized to move the alphanumeric cursor around the screen. The placement of this alphanumeric cursor determines where the next character will be placed on the screen. All cursor control commands are listed in Table 5-4.

Table 5-3 Code Ensemble in Alphanumerics Mode - Received Codes

<div style="display: flex; align-items: center;"> <div style="writing-mode: vertical-rl; transform: rotate(180deg); margin-right: 5px;">Bits</div> <div style="display: flex; flex-direction: column; gap: 5px;"> <div style="border-bottom: 1px solid black; width: 100px; margin-bottom: 5px;">b<sub>7</sub></div> <div style="border-bottom: 1px solid black; width: 100px; margin-bottom: 5px;">b<sub>6</sub></div> <div style="border-bottom: 1px solid black; width: 100px; margin-bottom: 5px;">b<sub>5</sub></div> <div style="display: flex; justify-content: space-around; width: 100px;"> <div style="border-bottom: 1px solid black; width: 20px; margin-bottom: 5px;">b<sub>4</sub></div> <div style="border-bottom: 1px solid black; width: 20px; margin-bottom: 5px;">b<sub>3</sub></div> <div style="border-bottom: 1px solid black; width: 20px; margin-bottom: 5px;">b<sub>2</sub></div> <div style="border-bottom: 1px solid black; width: 20px; margin-bottom: 5px;">b<sub>1</sub></div> </div> </div> </div>					0	0	0	0	1	1	1	1
					0	0	1	0	1	0	1	0
					0	1	2	3	4	5	6	7
					0	1	2	3	4	5	6	7
0	0	0	0	0			SP	0	@	P	'	p
0	0	0	1	1			!	1	A	Q	a	q
0	0	1	0	2			"	2	B	R	b	r
0	0	1	1	3			#	3	C	S	c	s
0	1	0	0	4			\$	4	D	T	d	t
0	1	0	1	5			%	5	E	U	e	u
0	1	1	0	6			&	6	F	V	f	v
0	1	1	1	7	BEL		'	7	G	W	g	w
1	0	0	0	8	BS		(	8	H	X	h	x
1	0	0	1	9	HT		)	9	I	Y	i	y
1	0	1	0	10	LF		*	:	J	Z	j	z
1	0	1	1	11		ESC	+	;	K	[	k	{
1	1	0	0	12			,	<	L	\	l	
1	1	0	1	13	CR		-	=	M	]	m	}
1	1	1	0	14			.	>	N	^	n	~
1	1	1	1	15			/	?	O	_	o	DEL

Table 5-4 Alphanumeric Cursor Control

Code (ASCII <sub>8</sub> )	Type Command	Action
Backspace (010)	Control Code	Moves cursor left one position.
Return (015)	↓	Moves cursor to left margin of current line.
Line Feed (012)		Moves cursor down one line.
Tabulate (011)		Control Code
ESC A (033, 101)	Escape Sequence	Moves cursor up one line.
ESC C (033, 103)	↓	Moves cursor right one position.
ESC H (033, 110)		Moves cursor to upper-left corner of the screen (Home Position).
ESC J (033, 112)		Erases screen from cursor to bottom of screen.
ESC K (033, 113)		Escape Sequence

## 5.5 GRAPHIC MODE

There are 30 special symbols which can be displayed on the screen of the VT55. These special symbols can be entered in the screen only by placing the terminal in Graphic mode. Normally, the codes 136-176 stand for the lowercase letters and some symbols. In Graphic mode, each code in this range will call out one of the special symbols to be placed on the screen.

Codes 040-135 are unaffected. The symbols they represent can be placed on the screen whether or not the terminal is in Graphic mode.

The VT55 uses the control codes to mark the position of the special symbols in its internal memory. Therefore, the special symbols and the lowercase letters can coexist on the screen. The special symbols will remain on the screen where they were entered even if the terminal is subsequently taken out of Graphic mode.

Table 5-5 shows all the special symbols generated in Graphic mode.

**Table 5-5 Display of the Codes 136-176**

Code Received by Terminal	Display on VT55 Screen	
	In Graphic Mode	Not in Graphic Mode
136	Reserved	^
137	Reserved	-
140	Reserved	'
141	Solid rectangle	a
142	1/	b
143	3/	c
144	5/	d
145	7/	e
146	degrees	f
147	plus or minus	g
150	right arrow	h
151	ellipsis	i
152	divide by	j
153	down arrow	k
154	bar at scan 0	l
155	bar at scan 1	m
156	bar at scan 2	n
157	bar at scan 3	o
160	bar at scan 4	p
161	bar at scan 5	q
162	bar at scan 6	r
163	bar at scan 7	s
164	subscript 0	t
165	subscript 1	u



**Table 5-5 Display of the Codes 136-176 (Cont)**

Code Received by Terminal	Display on VT55 Screen	
	In Graphic Mode	Not in Graphic Mode
166	subscript 2	v
167	subscript 3	w
170	subscript 4	x
171	subscript 5	y
172	subscript 6	z
173	subscript 7	(
174	subscript 8	
175	subscript 9	)
176	paragraph	~

**USES OF THE SPECIAL SYMBOLS**

1. The codes 154-163 cause eight horizontal lines at various scans within the character position to be displayed. These bars can be used to paint a line on the screen with more accuracy than would be possible using only minus signs and underlines.
2. The codes 142-145 (1/, 3/, 5/, and 7/) are used before the subscripts to form fractions. For example, the fractions 1/8, 1/4, 3/8, 1/2, 5/8, 3/4, and 7/8 can be formed using these four symbols and the subscripts.
3. The ellipsis (151) appears as three dots in the character position (. . .). The spacing of these three dots is such that several of these symbols placed adjacent to one another in the screen will produce a smooth line of dots.
4. The symbols produced by the codes 136-140 are reserved for possible future use.

**5.6 DISPLAY CALIBRATION SPECIFICATION**

VT55 video screen data is actually composed of a graph drawing data field with overlaid alphanumeric information. The graph drawing data field consists of 236 points along the Y axis (vertical) and 512 points along the X axis (horizontal). Superimposed on this graph drawing data field is 79 columns by 23 lines of alphanumeric information. The remaining row and column of alphanumeric data is outside the graph drawing field. This aids in clear labeling of full screen graphs.

The following paragraphs define the graph drawing data field calibration and the alignment of alphanumeric data on this field. With an understanding of this, the programmer can plot a graph and then label it.

**5.6.1 Calibration of the Graph Drawing Field**

The graph drawing data field is addressed as a 354<sub>8</sub> × 1000<sub>8</sub> matrix on the video screen as shown in Figure 5-4.

Two "data characters" are transmitted to uniquely define either an X or Y point on the graph drawing data field. The use of data characters and graphic drawing command characters is discussed in Paragraph 5.7.

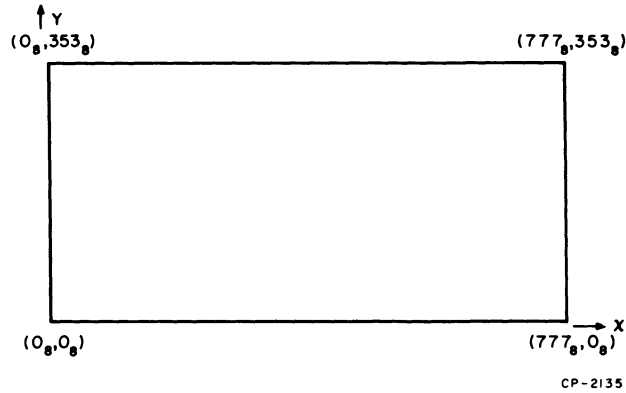

Figure 5-4 Graph Drawing Data Field Calibration

### 5.6.2 Alignment of Alphanumerics on the Graph Drawing Data Field

VT55 alphanumeric characters are point-plotted on the video display in a  $7 \times 7$  (horizontal by vertical) dot matrix. Alignment of the alphanumeric character on the graph drawing data field is specified by where the bottom dots of the  $7 \times 7$  matrix fall in the Y direction and by where the left-hand edge of this matrix is aligned in the X direction. Figure 5-5 shows this in detail for the character "E."

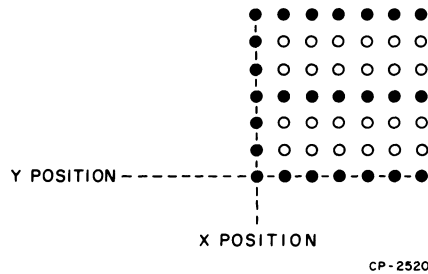

Figure 5-5 X and Y Position Specification for Letter "E"

In the Y direction, an alphanumeric character may be placed at 10-point ( $12_8$ ) increments, beginning with line  $4_8$ , on the graph drawing on the data field. A total of 23 lines of characters reside on the graph drawing data field. The 24th line is below this field at  $Y = -6_8$ . As the Y position of an alphanumeric character is usually determined by the number of "line feed" characters that the terminal receives after the alphanumeric cursor is homed, the Y position on the graph drawing field is defined by:

$$Y = 224 - 10L \quad 0 \leq L \leq 23 \quad \text{All values in decimal.}$$

where:

- Y = Y position on graph drawing data field
- L = Integer number of line feed characters from top line on screen.

In the X direction, characters are plotted on 6-1/2 dot boundaries beginning with the second column of characters. Hence, 79 columns of characters reside in the graph drawing data field while the first column is displayed to the left of this field. This first column begins at  $X = 6.5_8$ . Mathematically expressed in terms of the number of "space" characters from the left column of the screen:

$$X = 6.5S - 6.5 \quad 0 \leq S \leq 79 \quad \text{All values in decimal.}$$

where:

- X = X position on graph drawing data field
- S = Integer number of space characters from left column on the screen.

**Examples:**

Suppose that 14 line feed characters, followed by 31 space characters, followed by the letter E are transmitted to the terminal while in Alphanumeric mode. The position of "E" will be:

$$Y = 224 - 10(14) = 84$$

$$X = 6.5(31) - 6.5 = 195$$

The decimal X, Y coordinate of the E is (195, 84), which corresponds to  $(303_8, 124_8)$  in octal. Plotting a vertical graph line at  $X = 303_8$  and plotting a horizontal graph line at  $Y = 124_8$ , in Graph Drawing mode, will intersect the letter E in its lower left corner as shown in Figure 5-5.

If the example were changed so that 23 line feeds were transmitted, the new Y coordinate would be:

$$Y = 224 - 10(23) = -6$$

The letter E is now 6 dots below the line  $Y = 0$  and outside the graph drawing field.

**5.6.3 Definition of Graph Marker on the Graph Drawing Data Field**

Graph markers may be displayed on any or all of the 512 points on each of the two VT55 graphs. The marker will be displayed as a vertical  $20_8$ -point line, except between lines  $Y = 340_8$  and  $353_8$ , where it is only  $14_8$  points high.

The graph marker always starts at  $20_8$  increments (e.g.,  $0_8, 20_8, 60_8, 100_8, 340_8$ ) along the Y axis. For example, a graph marker desired over a point at  $Y = 322_8$  will begin at  $Y = 320_8$  and end at  $337_8$ . A graph marker placed on graph point  $Y = 350_8$  will be plotted from  $Y = 340_8$  to  $Y = 353_8$  (top of graph drawing data field). Figure 5-6 shows the example of a graph marker plotted over graph point  $Y = 322_8$ .

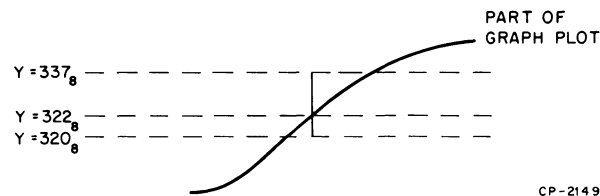

Figure 5-6 Graph Marker for Graph Point  $Y = 322_8$

## 5.7 GRAPH DRAWING MODE

This section describes the operation of the VT55 while in the Graph Drawing mode, plus the ways of entering and exiting this mode.

Basically, the VT55 uses the same character set in Graph Drawing mode as the other two modes. To enter the Graph Drawing mode, an escape sequence is necessary, specifically ESC (033<sub>8</sub>) followed by the numeral 1 (061<sub>8</sub>). To return to the previous mode, the sequence is ESC followed by the numeral 2 (033<sub>8</sub>, 062<sub>8</sub>).

### 5.7.1 Graph Drawing Command Characters

All graph drawing commands begin with a character from the normal character set. Specifically, these are @, A, B, C, D, H, I, J, K, L.

1. The @ is the "no operation" command.
2. B and J cause graphs 0 and 1 to be loaded.
3. A and I control the status of the display.
4. C and K cause markers to be loaded or erased.
5. D and L cause horizontal and vertical lines to be loaded or erased.
6. H is the command to set up an X coordinate.

These commands are followed (with the exception of the @) by either one or two characters. These characters act as data for the command characters and as a result they will vary. (The command characters are fixed.)

### 5.7.2 Graph Drawing Data Characters

The data characters all have a particular format in which the most significant bit is always 0, and the next most significant bit is always 1. This format results in the use of a subset of the total 96-character set. That subset is the group of characters with an octal representation of 0XY, where X and Y vary as follows:

The value of X ranges from 4 to 7.  
The value of Y ranges from 0 to 7.

Paragraph 5.10 details how these data characters are used in conjunction with the graph drawing command characters of Paragraph 5.7.1. Each graph drawing data character is contained within the 0XY subset and one or two 0XY characters need to be transmitted to completely define the graph drawing command character operation. When two characters define the operation, the first character is taken as the least significant part of a 10-bit data word while the second character defines the most significant part of the 10-bit data word. Table 5-6 lists the interpretation of ASCII characters that are used as the least significant part of a 10-bit data word. Table 5-7 lists the interpretation of these characters when used as the most significant part of the 10-bit word. When a least significant word and a most significant word are received by the VT55, their data values are simply added to form the 10-bit data value.

When only a single graph drawing data character is used in conjunction with a graph drawing command character, the low-order data values of Table 5-6 are applicable.

**Table 5-6 Graph Drawing Data Characters  
(When Used as Low-Order Part of Data Word)**

Character	Octal Value	Data Value*
SPACE	40	0
!	41	1
..	42	2
#	43	3
\$	44	4
%	45	5
&	46	6
' (apostrophe)	47	7
(	50	10
)	51	11
*	52	12
+	53	13
, (comma)	54	14
- (minus)	55	15
.	56	16
/	57	17
0	60	20
1	61	21
2	62	22
3	63	23
4	64	24
5	65	25
6	66	26
7	67	27
8	70	30
9	71	31
:	72	32
;	73	33
<	74	34
=	75	35
>	76	36
?	77	37

\*Used as bottom five bits of a data word.

**Table 5-7 Character Values  
(When Used as High-Order Part of Data Word)**

<b>Character</b>	<b>Octal Value</b>	<b>Data Value*</b>
SPACE	40	0
!	41	40
“	42	100
#	43	140
\$	44	200
%	45	240
&	46	300
‘ (apostrophe)	47	340
(	50	400
)	51	440
*	52	500
+	53	540
, (comma)	54	600
- (minus)	55	640
.	56	700
/	57	740
0	60	1000
1	61	1040
2	62	1100
3	63	1140
4	64	1200
5	65	1240
6	66	1300
7	67	1340
8	70	1400
9	71	1440
:	72	1500
;	73	1540
<	74	1600
=	75	1640
>	76	1700
?	77	1740

\*Used as top five bits of a data word.

When two characters must be transmitted to form a 10-bit data value, the low-order part of the data word must always be transmitted first. The high-order part of the data word must be transmitted next. The VT55 will misinterpret the use of received graph drawing data characters if they are not received in the proper order.

## Examples

The sequence & # used as data in a LOAD X COORDINATE command has the following characteristics:

1. Octal values 046 and 043 respectively.
2. Data values as follows: Since the # is to be used to form the most significant five bits of the data word, its data value (from Table 5-7) will be 140. The addition of this value to that of the & character (6 from Table 5-6) results in an address of 146 on the horizontal axis.

Reversing the situation to send the data word 146 you would take the least significant five bits (00110) and add the standard bit pattern (01) to form the total pattern 0 100 110 or 46 (the character &). The same process would hold true for the most significant five bits, 00011, with the standard pattern 01 being added. The result, 0 100 011 or 43 (the character #), would be sent to the VT55 as the second character.

Viewed this way, it can be seen that characters can be formed and sent to the VT55 by a program which need not keep track of what the actual characters were. As long as the bit pattern is correct, the proper action will result.

### 5.7.3 Other Characters

If while in Graph Drawing mode a character other than a graph drawing command or graph drawing data character is received, it is examined to see if it is either an escape character or a control code. If neither is true, then the character is ignored, and the VT55 remains in Graph Drawing mode.

## 5.8 ESCAPE MODE

Although there are three main modes of operation, Alphanumeric, Graphic, and Graph Drawing, there is an intermediate mode called Escape mode. This mode is entered at each occurrence of the ESC (escape) character. One example is the switch from Alphanumeric to Graph Drawing mode. The sequence is ESC 1 (033<sub>8</sub> followed by 061<sub>8</sub>). Upon receiving the ESC character, the VT55 enters Escape mode. In this mode, it is capable of acting upon a specific set of characters to perform functions such as homing the cursor or erasing portions of the alphanumeric display. Table 5-8 gives the characters which the VT55 can act upon while in Escape mode and the resulting action. All references to "cursor" refer to the alphanumeric cursor. The following paragraphs detail the action of each escape sequence.

### 5.8.1 Cursor Down

Cursor Down is invoked by ESC B (033 102). The cursor is moved down one character position to the same column of the line below where it was. If the cursor was on the bottom line of the screen to begin with, it stays where it was, and no scroll occurs.

### 5.8.2 Reverse Line Feed

Reverse Line Feed is invoked by ESC I (033 111). The cursor is moved up one character position to the same column of the line above the one it was on. If the cursor was on the top line to begin with, it stays where it was, but all the information on the screen moves down one line. The information that was on the bottom line of the screen is lost; a new blank line appears at the top line. This process is also called "downward scroll."

**Table 5-8 Escape Mode Characters**

Character	Octal Code	Action
A	101	Moves cursor up one line.
B	102	Moves the cursor down one line.
C	103	Moves cursor right one position.
F	106	Enter Graphic mode.
G	107	Exit Graphic mode.
H	110	Moves cursor to the home position.
I	111	Scroll screen down one line.
J	112	Erases text from cursor position to bottom of screen.
K	113	Erases text from cursor position to right margin.
Y	131	Direct cursor address command.
Z	132	VT55 transmits its identifying sequence ESC / E (033,057,105).
[	133	Enables Hold Screen mode.
\	134	Disables Hold Screen mode.
]	135	Copies all lines of text from top of screen to line containing cursor.
^	136	Enables auto-print mode.
-	137	Disables auto-print mode.
=	075	Enter Alternate Keypad mode.
>	076	Exit Alternate Keypad mode.
1	061	Enter Graph Drawing mode.
2	062	Exit Graph Drawing mode.

### 5.8.3 Cursor Up

Cursor Up is invoked by ESC A (033 101). The cursor is moved up one character position to the same column of the line above the one it was on. If the cursor was on the top line to begin with, it stays where it was, and no scroll occurs.

### 5.8.4 Cursor Right

Cursor Right is invoked by ESC C (033 103). The cursor is moved one column to the right. If the cursor was at the end of the line to begin with, it does not move. No character on the screen is erased.

### 5.8.5 Cursor Home

Cursor Home is invoked by ESC H (033 110). The cursor is moved to the home position – the character position at the upper left corner of the screen. If it was there to begin with, it stays there.

### 5.8.6 Direct Cursor Addressing

Direct Cursor Addressing is invoked by ESC Y (033 131). The next code after ESC Y that the host sends to the terminal will not be displayed but will be interpreted as specifying one of the lines on the screen. The character the terminal receives after that will not be displayed but will be interpreted as specifying one of the columns on the screen. The cursor will be moved to the character position at the specified line and column. The complete Direct Cursor Addressing command has this form:

ESC Y line # column #

and consists of four characters from the host. Control codes or other escape sequences should not be embedded in this string of four characters (doing so will produce unspecified results).



For line number, the host sends the octal code 040 to specify the top line of the screen, 041 to specify the line below the top line, and so forth. The bottom line is specified by 067. The VT55 will not move the cursor vertically if the vertical parameter is out of bounds. A Direct Cursor Addressing command with the first parameter greater than 067 can be issued to the VT55 to move the cursor arbitrarily in the horizontal direction without the flickering of the video that the full Direct Cursor Addressing command can cause.

For column number, the host sends the octal code 040 to specify the leftmost column in a line, and 157 to specify the rightmost column. If the column number specified is greater than 157 and, therefore, does not specify a column that exists on the screen, the cursor is moved to the rightmost column on a line.

#### **5.8.7 Erase to End of Line**

Erase to End of Line is invoked by ESC K (033 113). All the information at the cursor position and to the right to the end of the line is erased. (Spaces are deposited at those character positions.)

If the cursor is at the rightmost column on a line, the character at the cursor position will be the only character to be erased. If the cursor is at the leftmost column on a line, the entire line will be erased.

#### **5.8.8 Erase to End of Screen**

Erase to End of Screen is invoked by ESC J (033 112). All the information from the cursor position to the end of the screen is erased. This function does what Erase to End of Line does and, in addition, erases the information in every line below the line the cursor is on.

If the cursor is at the lower right corner of the screen, one character will be erased. If the cursor is at the home position of the screen, all the information on the screen will be erased.

#### **5.8.9 Identify Terminal Type**

Identify Terminal Type is invoked by ESC Z (033 132). When the terminal receives ESC Z, it transmits a 3-character escape sequence to the host. This escape sequence tells the host two things:

1. The terminal is switched on, connected to the host, and responding to commands.
2. The terminal is a VT55, with graph drawing capacity.

During the time it is transmitting the 3-character escape sequence, the terminal will disable the keyboard so that characters typed will not be embedded in the escape sequence. Under no circumstances will the keyboard be locked for more than half a second. Because the transmitting baud rate is set higher so that it takes less time to transmit the three characters, the time for this command will drop to under 1/15 second.

On receiving this command, the VT55 will respond with ESC / E (033, 057, 103).

#### **5.8.10 Enter Hold Screen Mode**

Enter Hold Screen Mode is invoked by ESC [ (033 133). The terminal enters Hold Screen mode as described in Paragraph 5.9. Data will not be allowed to scroll off the screen without permission from the operator via the SCROLL key. After entering Hold Screen mode, the first command that would cause a scroll to occur will not be immediately processed, and the terminal will send XOFF to the host.

Hold Screen mode remains in effect until the Exit Hold Screen Mode command disables that feature.

#### **5.8.11 Exit Hold Screen Mode**

Exit Hold Screen Mode is invoked by ESC \ (033 134). The terminal exits Hold Screen mode. Data will be allowed to scroll off the screen if it has to in order to make room for new data coming from the host.

#### **5.8.12 Enter Alternate Keypad Mode**

Enter Alternate Keypad Mode is invoked by ESC = (033 075). The terminal enters Alternate Keypad mode, in which the numeral keys, decimal point key, and ENTER key transmit unique escape sequences, allowing the software to distinguish between them and keys on the main keyboard, and to assign its own meaning to each key.

Alternate Keypad mode will not be in effect until the host issues this command and, once enabled, will remain in effect until the host uses the Exit Alternate Keypad Mode command to disable that feature.

#### **5.8.13 Exit Alternate Keypad Mode**

Exit Alternate Keypad Mode is invoked by ESC > (033 076). The terminal exits Alternate Keypad mode. Now the numeral, decimal point, and ENTER keys transmit codes that are indistinguishable from the codes transmitted by the numeral, decimal point, and RETURN keys on the main keyboard. Applications which do not need to redefine the meanings of these 12 keys will work correctly with the operator using the keypad for entry of numeric data.

#### **5.8.14 Copy Screen**

Copy Screen is invoked by ESC [ (033 135). The contents of the CRT screen will be copied. See Paragraph 5.2.2 for detailed operation of the copier.

Note that the graph drawing information will temporarily blank from the viewing screen during the operation. The alphanumeric cursor will not be copied on the hard copy output.

#### **5.8.15 Enable Auto-Print Mode**

Enable Auto-Print Mode is invoked by ESC ^ (033 126). The terminal enters Auto-Print mode, in which the copier will copy each line of print as the cursor is moved to the line below by a line feed or ESC B.

#### **5.8.16 Disable Auto-Print Mode**

Disable Auto-Print Mode is invoked by ESC - (033 137). The terminal leaves Auto-Print mode and returns to normal operation.

#### **5.8.17 Enter Graphic Mode**

Enter Graphic Mode is invoked by ESC F (033 106). When codes in the range 136–176 are received, they will be converted to the special symbols before being placed on the screen. This remains true until the terminal receives the Exit Graphic Mode command.

#### **5.8.18 Exit Graphic Mode**

Exit Graphic Mode is invoked by ESC G (033 107). The codes 136–176 resume their standard (ASCII) meanings.

See Paragraph 5.5 for additional Graphic mode information.

#### **5.8.19 Enter Graph Drawing Mode**

Enter Graph Drawing Mode is invoked by ESC 1 (033 061). The terminal will interpret standard ASCII codes as graph drawing data and commands. This remains true until the terminal receives the following command.

#### **5.8.20 Exit Graph Drawing Mode**

Exit Graph Drawing Mode is invoked by ESC 2 (033 062). The terminal will revert to the mode of operation it was in before entering Graph Drawing mode. Graph Drawing mode is explained in Paragraph 5.7.

## 5.9 HOLD SCREEN COMMAND

The Hold Screen command allows the operator to control the rate at which data enters and leaves the screen. This is important because the DECscope can operate at such fast speeds that data from the host might remain on the screen for only a few seconds before it scrolls up and off the top of the screen to make way for new data. Other terminals simply allow the data to leave the screen and be lost, regardless of whether the operator has had time to read it. The DECscope does this, too, when it is not placed in Hold Screen mode.

The DECscope has a synchronization scheme with the host, which was described in Paragraph 3.5.4. Whenever, for any reason, it cannot process data from the host, it automatically transmits the control code XOFF (023). When it is ready again, it transmits XON (021). The terminal depends on the host to suspend its transmission promptly when the host receives XOFF from the terminal, and resume the transmission where it left off upon receiving the XON. When software places the terminal in Hold Screen, the terminal refuses to perform scrolls. If the host commands it to scroll by sending the terminal a LF (012) when the cursor is on the bottom line, the terminal will place the LF in the Silo to be executed later, and send XOFF to the host. The XOFF means that the terminal is not ready for more data from the host, because the terminal assumes that the operator is not ready for more.

The operator tells the terminal that he is ready to see more data – specifically, one more line of data – by pressing the SCROLL key. When he does so, the terminal processes the LF character out of the Silo. When it does this, a scroll occurs. Then the terminal takes from the Silo any other characters that may have arrived from the host before the host responded to the XOFF and suspended its output. Each character in the Silo is displayed on the screen or, in the case of commands, executed exactly as if it had just been received – unless it is another LF causing another scroll. If the terminal encounters a LF in the Silo, it stops processing characters out of the Silo until the operator presses the SCROLL key again.

If the terminal processes all the characters in the Silo without finding a LF, it transmits XON to the host to notify it that the terminal is again ready to receive characters. It will display all the characters and execute all the commands until it is again ordered to perform a scroll. Then it will again send XOFF, store the LF in the Silo, and wait for the operator to press the SCROLL key.

If, after the terminal transmits XOFF, the host keeps transmitting to such an extent that the Silo fills up completely, then, rather than allow data to be lost, the terminal will perform the scroll it was commanded to perform despite Hold Screen and remove the characters from the Silo and interpret them, reducing the backlog. However, the terminal does not exit Hold Screen; if it encounters another command to scroll the display, either within the Silo or directly from the host, it will not scroll, and it will begin to buffer incoming characters once again.

The operator types the SCROLL key to request that another line be admitted to the screen. The terminal translates this request into “start” and “stop” commands – XON and XOFF – and sends them to the host in such a way that just enough data comes to the terminal to satisfy the operator’s request for one more line.

The operator can type the SCROLL key with the SHIFT key down to make a request for a new screenful of data. As with the unshifted SCROLL request, the terminal begins to process characters again and sends XON to the host when the characters that accumulated in the Silo have all been processed. But the shifted SCROLL request tells the terminal to allow an entire screenful of new data to enter the screen before shutting off the transmission from the host.

Therefore, by using Hold Screen, the software can control the page-by-page output to the terminal. The software need not maintain counters of how many lines have been output to the terminal since the last request. Since the terminal calculates when its own screen has been filled with new data and takes the initiative to notify the host, the software does not need to know the capacity of lines of the terminal it is outputting to. Current DIGITAL software operating systems such as RSTS-11, RSX-11, RT-11, TOPS-10, and TOPS-20 support XON/XOFF control.

### 5.10 CONTROL CODES

Of the 128 codes in the ASCII set, 32 are considered to be control codes. This means that they do not represent characters that can be displayed on the screen. Some are meant to be interpreted as commands. To generate a control code, the CTRL key must be depressed simultaneously with another key. CTRL has the effect of forcing  $b_7$  and  $b_5$  to 00. Therefore, control codes can be generated by depressing CTRL and a key listed in columns 4 or 5 to generate the codes of columns 0 and 1, respectively. For example, CTRL G would generate binary code  $b_7 b_6 b_5 b_4 b_3 b_2 b_1 = 0000111$  or  $007_8$  (BEL). Careful examination shows that CTRL ' would generate BEL as well, but since the keys of columns 2 and 3 would generate codes equivalent to columns 4 and 5, control codes are normally referred to the keys in columns 4 and 5.

The execution of control codes is possible in all four (Escape, Graph Drawing, and Alphanumeric) modes. After execution of the control code, the mode remains the same as before. (Refer to Figure 5-2 for flow diagram.)

The possible control codes and their operations are detailed in Table 5-9. Some control codes may be transmitted by typing a single key. These are designated by an asterisk.

Eventually, however, with only 32 control codes, terminals are going to run out of codes to stand for all their various functions. Therefore, one of the control codes, called ESC (escape), has been reserved for use to declare that the code that follows it, though it represents a character that could be displayed on the screen, must instead be interpreted as a command. For example, if the terminal receives the code 102, it will display a "B" on the screen. But if it receives 033, the code for ESC, and then 102, it will not display a "B" but instead will perform a special command.

Escape sequences exist to position the cursor, erase part or all of the information on the screen, place the terminal in special modes in which it behaves differently, and force the terminal to identify itself to the host.

If a control code is sent to the terminal between the ESC and the final character, the function specified by the control code is performed when the control code is received, and the function specified by the escape sequence is performed when the final character is received. If the VT55 receives ESC ESC, it will remain in Escape mode and wait to interpret the next received character as part of the escape sequence.

### 5.11 GRAPHING COMMANDS AND EXAMPLES

This paragraph describes the character sequences needed to initiate the graphing functions of the VT55. The VT55 is completely controlled by the characters sent to it over the asynchronous ASCII line, and a command can be constructed out of simple 2- and 3-character sequences. Typically, the first character in any string is fixed while subsequent characters will vary. This is because the bits in the second (and third) character are assigned specific functions. Since these functions are optionally selected by the user's program, the bit pattern and thus the character will vary.

**Table 5-9 Control Codes – All Modes**

<b>Octal Code</b>	<b>Key</b>	<b>Character</b>	<b>Terminal Action</b>
000		NUL (Null)	None
001		SOH (Start of Heading)	None
002		STX (Start of Text)	None
003		ETX (End of Text)	None
004		EOT (End of Transmission)	None
005		ENQ (Enquiry)	None
006		ACK (Acknowledge)	None
007		BEL (Bell)	Rings buzzer.
010*	BACKSPACE	BS (Backspace)	Moves cursor one space left.
011*	TAB	HT (Horizontal Tab)	Tabs eight spaces right (one space right after column 72).
012*	LINE FEED	LF (Line Feed)	Moves cursor down one line.
013		VT (Vertical Tab)	None
014		FF (Form Feed)	None
015*	RETURN	CR (Carriage Return)	Moves cursor to far left and down one line (scrolls if required).
016		SO (Shift Out)	None
017		SI (Shift In)	None
020		DLE (Data Link Escape)	None
021†		DC1 (Device Control 1)	None
022		DC2 (Device Control 2)	None
023†		DC3 (Device Control 3)	None
024		DC4 (Device Control 4)	None
025		NAK (Negative Acknowledge)	None
026		SYN (Synchronous Idle)	None
027		ETB (End of Transmission Block)	None
030		CAN (Cancel)	None
031		EM (End of Medium)	None
032		SUB (Substitute)	None
033*	ESC	ESC (Escape)	Switches the unit to escape mode.
034		FS (File Separator)	None
035		GS (Group Separator)	None
036		RS (Record Separator)	None
037		US (Unit Separator)	None

\*These codes may be entered by special keys on the keyboard.

†DC1 is also referred to as XON; DC3 is also referred to as XOFF.

In the repertoire of the VT55, there are a total of nine instructions. One of these (the NO OP instruction) is a single-character command, two are 2-character commands, and six are 3-character sequences. It should be noted that the first "command character" transmission implies that only the last characters need be sent since the first character sets up the type of operation (Load Graph 0, etc.), and the VT55 will continue to operate in this way until a new command is issued. Many data characters may now be sent to the terminal, thus increasing the plotting rates.

Prior to sending any of these character strings (Graph Drawing commands), the VT55 must be in Graph Drawing mode. This is accomplished by sending an escape character (033<sub>8</sub>) followed by the numeral 1 (061<sub>8</sub>).

### 5.11.1 NO OP

1st Character: @ (100<sub>8</sub>)  
 2nd Character: None  
 3rd Character: None

### 5.11.2 Load Enable Register 0

1st Character: A (101<sub>8</sub>)  
 2nd Character: Variable (see below)  
 3rd Character: None

#### Explanation

The second character is formed by setting bits where the bits have the following functions:

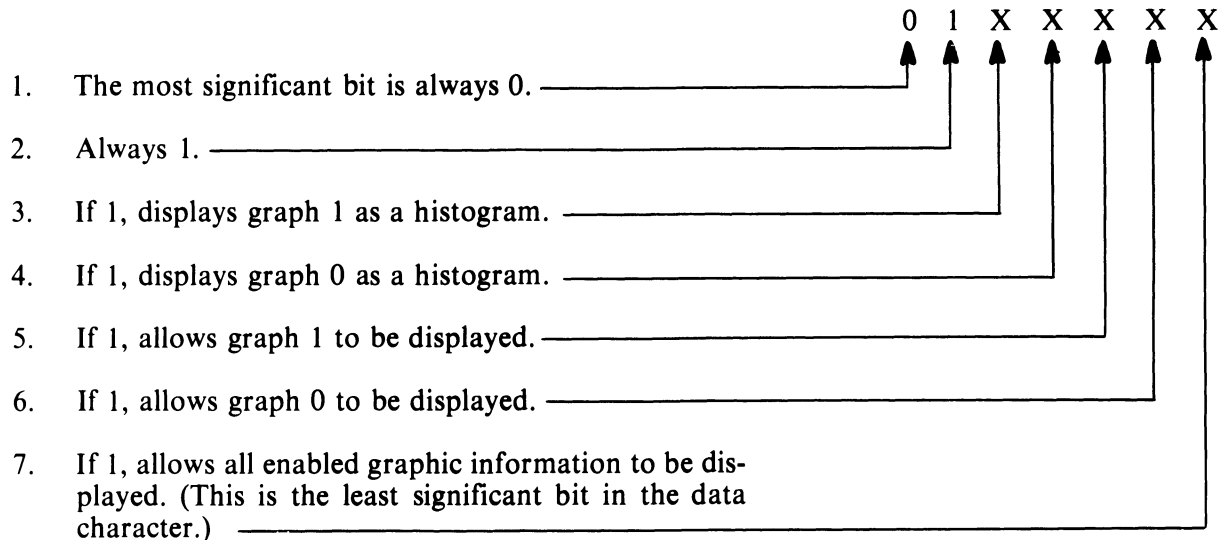

#### NOTE

**Do not enable graph 0 and histogram 0 or graph 1 and histogram 1 at the same time. This intensifies the graph envelope, which is undesirable for most applications.**

### 5.11.3 Load Enable Register 1

1st Character: I (111<sub>8</sub>)  
 2nd Character: Variable (see below)  
 3rd Character: None

#### Explanation

The second character is formed by setting bits where the bits have the following functions:

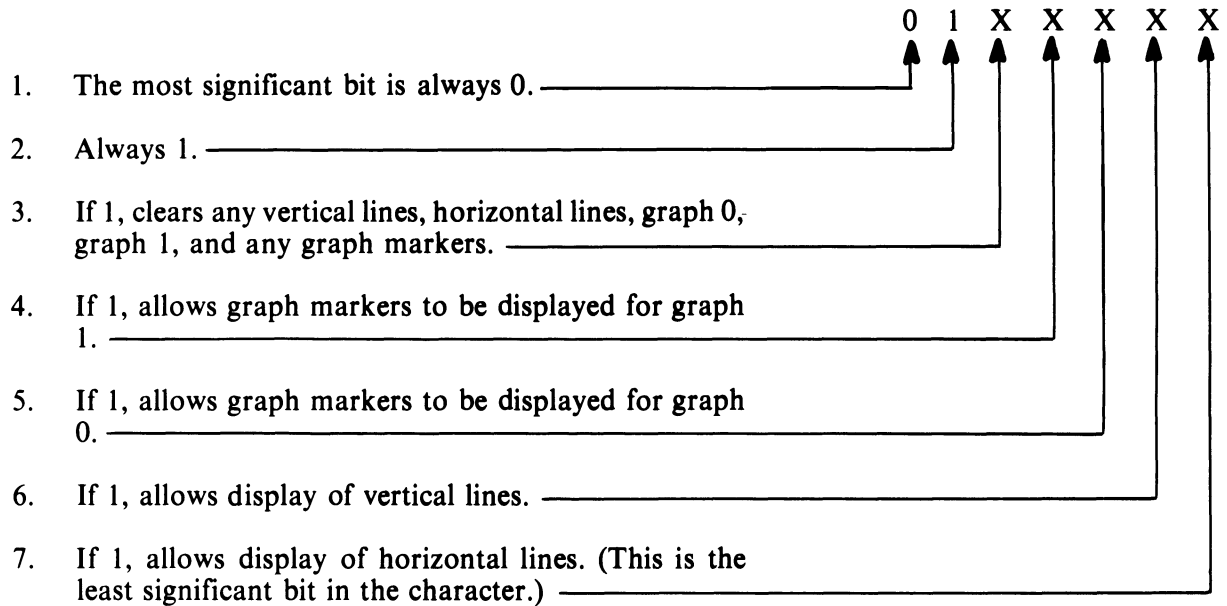

#### NOTE

It is good programming practice to initialize the graph drawing memories with the sequence I 0 (clear) when initializing a graph drawing program.

### 5.11.4 Load Graph 0

1st Character: B (102<sub>8</sub>)  
 2nd Character: Variable (see below)  
 3rd Character: Variable (see below)

#### Explanation of Second Character

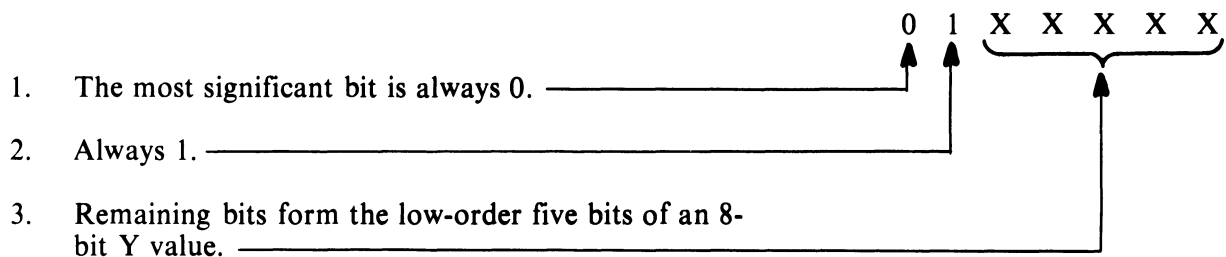

**Explanation of Third Character**

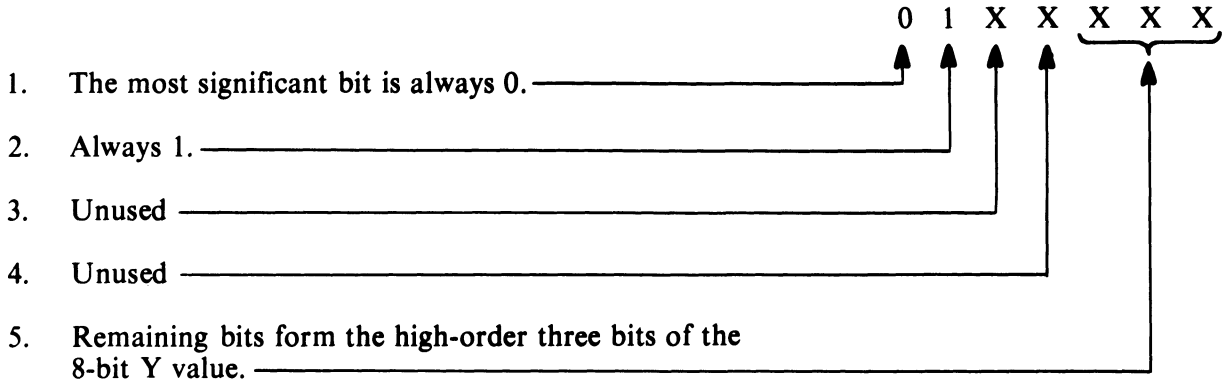

**5.11.5 Load Graph 1**

- 1st Character: J (112<sub>8</sub>)
- 2nd Character: Variable (same as in Paragraph 5.11.4).
- 3rd Character: Variable (same as in Paragraph 5.11.4).

**5.11.6 Load Graph Marker Memory for Graph 0**

- 1st Character: C (103<sub>8</sub>)
- 2nd Character: Variable (see below)
- 3rd Character: Variable (see below)

**Explanation of Second Character**

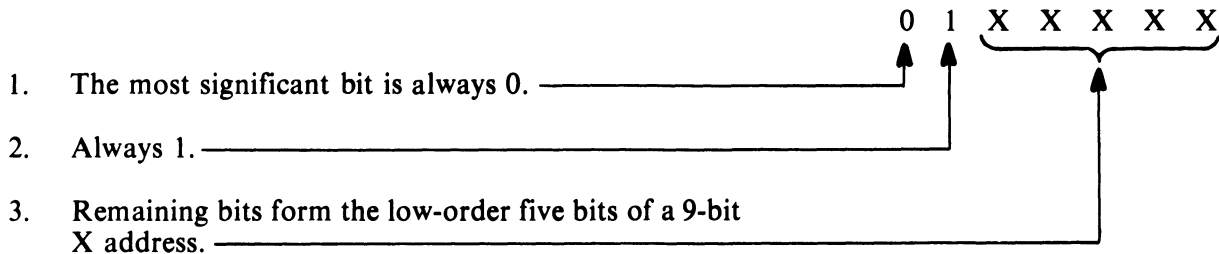

**Explanation of Third Character**

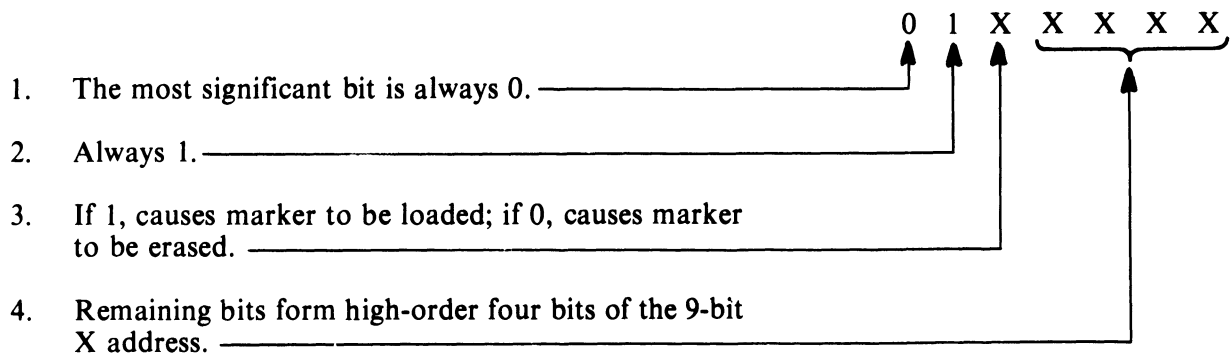

**NOTE**  
**Graph 0 or histogram 0 must be enabled for graph markers to be displayed.**



### 5.11.7 Load Graph Marker Memory for Graph 1

- 1st Character: K (113<sub>8</sub>)
- 2nd Character: Variable (same as in Paragraph 5.11.6)
- 3rd Character: Variable (same as in Paragraph 5.11.6)

#### NOTE

Graph 1 or histogram 1 must be enabled for graph markers to be displayed.

### 5.11.8 Load Horizontal Line Coordinate

- 1st Character: D (104<sub>8</sub>)
- 2nd Character: Variable (see below)
- 3rd Character: Variable (see below)

#### Explanation of Second Character

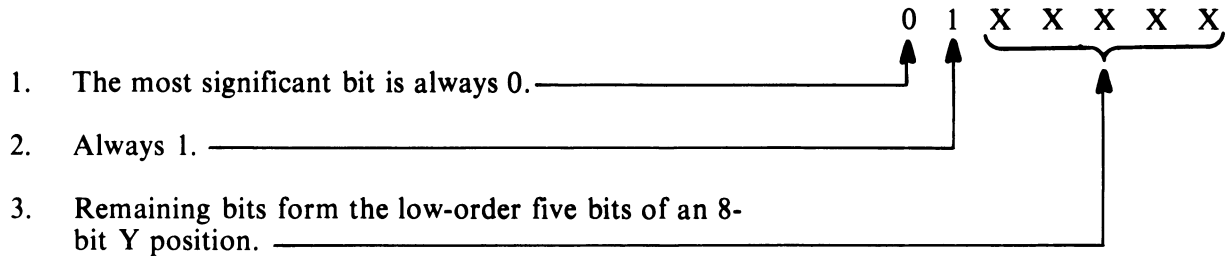

#### Explanation of Third Character

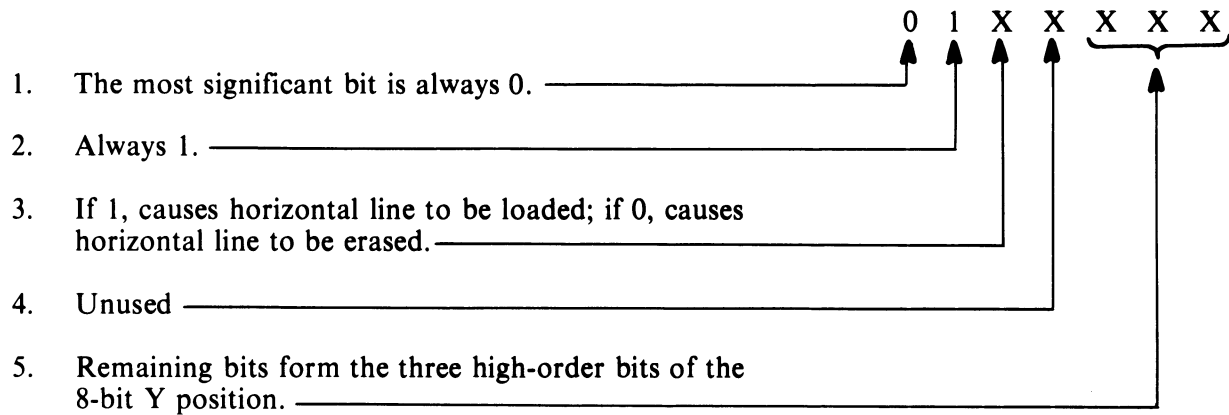

### 5.11.9 Load Vertical Line Coordinate

- 1st Character: L (114<sub>8</sub>)
- 2nd Character: Variable (see below)
- 3rd Character: Variable (see below)

**Explanation of Second Character**

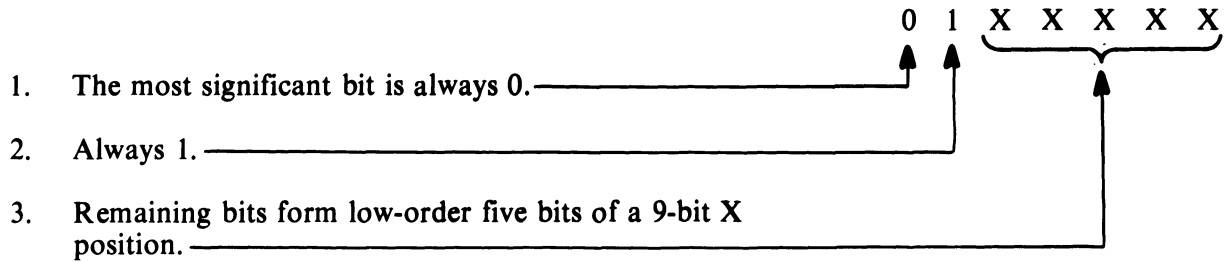

**Explanation of Third Character**

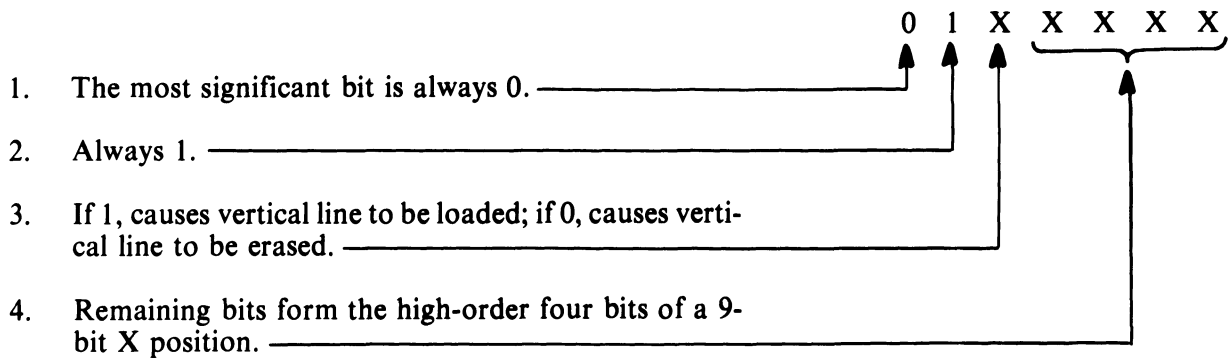

**5.11.10 Load Starting X Coordinate**

- 1st Character: H (110<sub>8</sub>)
- 2nd Character: Variable (see below)
- 3rd Character: Variable (see below)

**Explanation of Second Character**

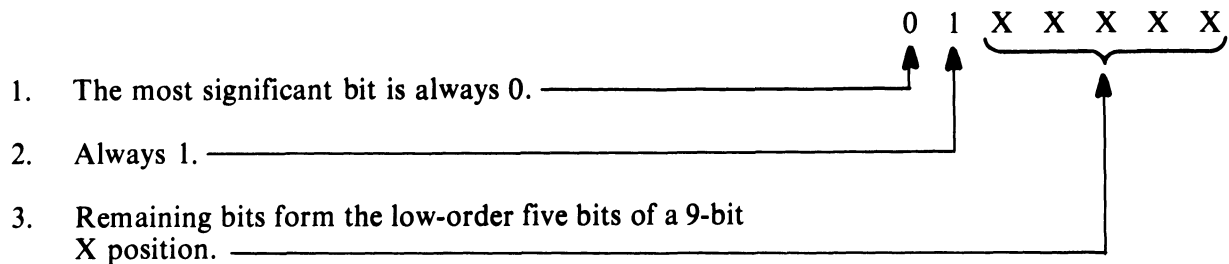

**Explanation of Third Character**

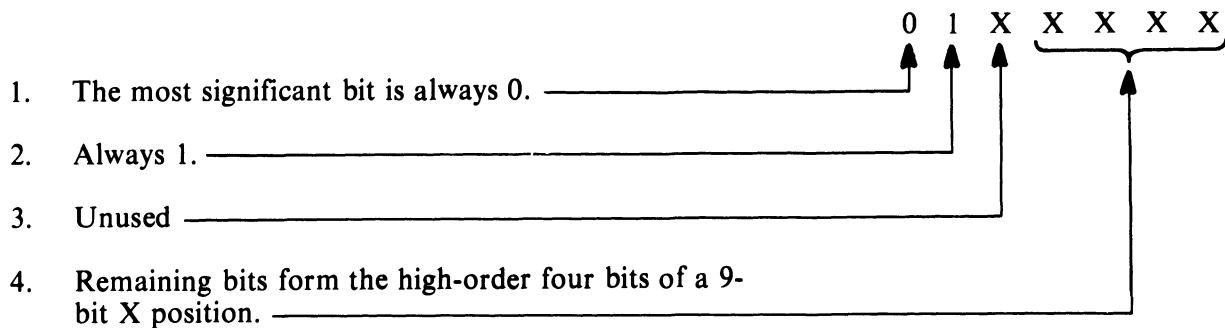

### 5.11.11 Example Sequence

This example uses all of the Graphic Drawing control commands except @ (100<sub>8</sub>) – no operation. The terminal should be in local mode or attached to a host computer that will echo data typed on the keyboard.

**5.11.11.1 Reset Logic** – Flip the POWER/LOGIC RESET switch to reset all circuits.

**5.11.11.2 Enter Graph Drawing Mode** – Type ESC 1 (033<sub>8</sub>, 061<sub>8</sub>).

**5.11.11.3 Enable Graphs** – Type A, ' (apostrophe), I, ? (101<sub>8</sub>, 047<sub>8</sub>, 111<sub>8</sub>, 077<sub>8</sub>). This enables all graphs, lines, and cursors. When the apostrophe is pressed, a horizontal line will appear at the bottom of the screen to show that the graphs are enabled. Press the SHIFT key for an uppercase character.

**5.11.11.4 Load Graph 0** – Type B, 1, 1 (102<sub>8</sub>, 061<sub>8</sub>, 061<sub>8</sub>). A single point will appear near the lower left of the screen.

Type 1 twice, eight more times. This will form a 9-point horizontal line.

Notice that B need not be pressed again as the terminal will continue loading graph 0 until it receives another command.

**5.11.11.5 Load X Coordinate** – Type H, SPACE, ( (110<sub>8</sub>, 040<sub>8</sub>, 050<sub>8</sub>). This sets the next X coordinate to 400<sub>8</sub>, or the middle of the screen.

**5.11.11.6 Load Graph 1** – Type J, 6, 6 (112<sub>8</sub>, 066<sub>8</sub>, 066<sub>8</sub>). A single point will appear near the top center of the screen.

Type 6 twice, eight more times. There will now be a 9-point horizontal line near the top center of the screen.

**5.11.11.7 Load Graph Marker Memory for Graph 0** – Type C, \$, 0 (103<sub>8</sub>, 044<sub>8</sub>, 060<sub>8</sub>). This will generate a 16-point vertical cursor that will intersect the graph 0 horizontal line.

**5.11.11.8 Load Graph Marker Memory for Graph 1** – Type K, \$, 8 (113<sub>8</sub>, 044<sub>8</sub>, 068<sub>8</sub>). This will generate a 16-point vertical cursor that will intersect the graph 1 horizontal line.

**5.11.11.9 Load Horizontal Line Coordinate** – Type D, +, 7, 2, 3 (104<sub>8</sub>, 053<sub>8</sub>, 067<sub>8</sub>, 062<sub>8</sub>, 063<sub>8</sub>). This generates horizontal lines at the top and the center of the screen.

**5.11.11.10 Load Vertical Line Coordinate** – Type L, SPACE, 0, ?, ?, SPACE, 8 (114<sub>8</sub>, 040<sub>8</sub>, 060<sub>8</sub>, 077<sub>8</sub>, 040<sub>8</sub>, 068<sub>8</sub>). This generates vertical lines at the right and left extremes of the graph drawing field, and through the center. The left line should touch the left side of graph 0, and the center line should touch the left side of graph 1.

**5.11.11.11 Controlling Display Status** – All information is now loaded. The display status can be controlled with enable registers 0 and 1.

Type A, 9 (101<sub>8</sub>, 069<sub>8</sub>). Graphs 0 and 1 will both become histograms.

Type 7 (067<sub>8</sub>). Graph 1 will show as a histogram; graph 0 will show as a graph.

Type 5 (065<sub>8</sub>). Graph 1 will show as a histogram; graph 0 will not show at all.

Type - (minus) (055<sub>8</sub>). Graph 0 will show as a histogram; graph 1 will show as a graph.

Type 0 (060<sub>8</sub>). The entire screen will go blank.

Type ' (apostrophe) (047<sub>8</sub>). Everything will reappear; graphs 0 and 1 will both show as graphs.

Type I, . (period) (111<sub>8</sub>, 056<sub>8</sub>). All horizontal lines will disappear. (This does not include the baseline which is part of the graphs.)

Type , (comma) (054<sub>8</sub>). All vertical lines will disappear.

Type ( (050<sub>8</sub>). Graph 0 graph markers will disappear.

Type SPACE (040<sub>8</sub>). Graph 1 graph markers will disappear.

Type /. All lines and graph markers will reappear.

Type ESC 2 (033<sub>8</sub>, 062<sub>8</sub>). Typing characters on the keyboard will place characters on the screen as the VT55 should now be in Alphanumeric mode. The graph drawing will remain on the screen.

## **CHAPTER 6 MAINTENANCE**

### **6.1 PHILOSOPHY**

Major assemblies used within the VT55 are designed to be repaired by subassembly replacement. This is in contrast to field replacement of defective components. There are a number of reasons for utilizing this service technique.

The first is the fact that the two microprocessor modules that form the basis for control of the VT55 perform closely interrelated functions via circuits scattered across the two boards. The interaction of these two modules is very complex. Without the use of specially designed and programmed Exclusive OR (XOR) testers, a very detailed knowledge of the microinstruction set is needed to pinpoint a problem. Three other major assemblies are the power supply/monitor module, graphing control module, and keyboard. As these modules all depend on the microprocessor for proper timing and data information, it is difficult to effectively troubleshoot them. Special testers exist to functionally test these modules when detached from the microprocessor.

For these reasons, swapping major assemblies is a far more efficient means of repairing VT55 malfunctions. All spare VT55 modules stocked in DIGITAL Field Service Offices have been tested on a special tester and then are tested under actual operating conditions within a VT55. Special module-testing VT55 units are exposed to a thermal cycle test where each subassembly is made to operate over the complete temperature range of the VT55. These precautions ensure that highest quality spare parts are stocked at DIGITAL Field Service Offices throughout the world. These same parts are available to the VT55 user who wishes to maintain his own spare parts kit for performing his own terminal service.

### **6.2 CORRECTIVE MAINTENANCE**

#### **6.2.1 Recommended Spare Parts and Tools**

This paragraph describes procedures for tracing a problem to one of the replaceable subassemblies within the VT55. When attempting to repair a VT55, it is imperative to bring a VT55 spare parts kit, plus a few simple tools for disassembly and some minor testing. Recommended spare parts and a recommended tool kit are listed in Tables 6-1 and 6-2.

The recommended spares kit can be used to repair 95 percent of machine failures. Figure 6-1 shows the relationship of these parts and the other parts that constitute the VT55.

The two functional parts that are not included in the spares kit are the transformer mounting plate assembly and the CRT assembly. Both items demonstrate a very low failure rate. The transformer mounting plate may be ordered, when required, through the local DIGITAL Field Service Office. The CRT assembly contains the 12-inch cathode ray tube. Due to the safety hazards involved in handling this part, the entire VT55 must be returned to a DIGITAL Repair Depot when a CRT repair is required. Depots have the necessary protective gloves and goggles required for this operation.

**Table 6-1 Recommended Spare Parts Kit**

<b>DEC Part No.</b>	<b>Description</b>	<b>VT55 Models</b>
5411450	Monitor, Power Supply, VT55	All models*
5411745	Data Path, Memory, Decoders	All models*
5411815	8K Character Generator	All models*
5411743-4†	ROM, UART, and Timing	All models*
5411743-2‡	ROM, UART, and Timing	All models*
23-128A9-00	512 × 4 ROM	All models*
23-129A9-00	512 × 4 ROM	All models*
23-130A9-00	512 × 4 ROM	All models*
23-131A9-00	512 × 4 ROM	All models*
M7024	VT55 Graphing Control Module	All models*
5411170-4	Keyboard VT51/VT50H	All models*
BN52A-7F	VT52 EIA Cable	EE, EF, EH, FE, FF
BN52B-7F	20 mA Adapter Assembly	EA, EB, EC, FA, FB
BN52C-7F	Current Loop to 283B Plug Assembly	HA, HB, HC, JA, JB
7010068-0	Copier Assembly 115 V/60 Hz	FA, FE, JA
7010068-2	Copier Assembly 220 V/240 V, 50Hz	FB, FF, JB

\*This includes VT55 models EA, EB, EC, EE, EF, EH, HA, HB, HC, FA, FB, FE, FF, JA, JC only.

†For DIGITAL Field Service only; VT52-variation module requires the substitution of four pluggable ROMs (128A9, 129A9, 130A9, 131A9) before it may be used in the VT55.

‡For OEM users; this module already has the four ROMs incorporated on the module.

**Table 6-2 Recommended Tool Kit**

<b>Quantity</b>	<b>Description</b>
1	Phillips head screwdriver
1	Slotted head screwdriver
1	#8 nutdriver, #10 nutdriver
1	Volt-ohmmeter or digital voltmeter
1	Wire stripper
1	Assorted pieces of insulated wire, #22 gauge
1	Jar of Thermal Joint Compound (DEC Part No. 90-08268 or equivalent)
1	Transformer, 0.075-inch slug alignment tool
	General Cement No. 9300 or equivalent

### 6.2.2 Basic Description of Internal Signal Flow

Figure 6-1 is a simplified signal flow diagram to aid in understanding the function of each sub-assembly. The microprocessor modules and the graphing module comprise the heart of the VT55. When data is received via the keyboard or serial line, it is fed into the ROM, UART, and timing module (Figure 6-2). If the data is alphanumeric or graphic, it will be stored in the data path, memory, and decoder module. If the data is meant for graph display, it is stored in the graphing module. Control of terminal operation is within the microprocessor module pair. Unique graph drawing information control is contained within the graphing module. In conjunction with timing circuits contained within all three of these modules, alphanumeric, graphic, and graph drawing video data are logically ORed into the monitor section of the power supply/monitor module. In fact, it is possible to remove the graphing module from the terminal and still retain full alphanumeric and graphic capability. The monitor controls the sweeping of the raster scan over the face of the CRT and unblanking of the beam when a point is to be intensified on the screen. The monitor also generates all the high voltages necessary for CRT operation. Timing information from the data path, memory, and decoder module is critical to properly operate the monitor. Voltage from the power supply section of the power supply/monitor module is converted into the voltages required to operate the tube. Of course, the power supply delivers power to all circuits in the VT55 logic as well.

Beam position information is deflected on the cathode ray tube by means of a yoke placed around the glass neck of the tube. The intensity for the beam is applied to the tube's cathode. Other electrodes of the tube have signals applied to them that control focus and intensity of the screen image. In addition, heater voltage and anode voltage are supplied to the CRT.

#### WARNING

The VT55 anode connection is made via a high-voltage diode on the power supply/monitor module, through high-voltage wire, to the glass envelope of the CRT. This circuit develops 11,000 V, so extreme caution must be used when dealing with it.

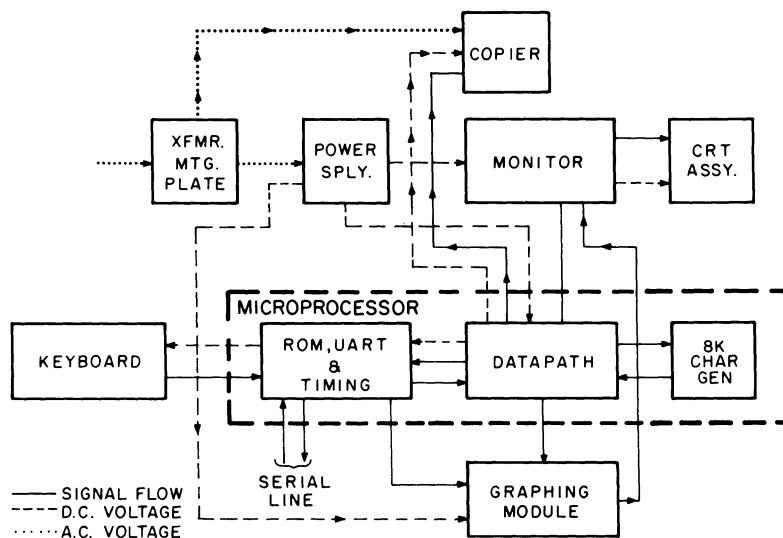
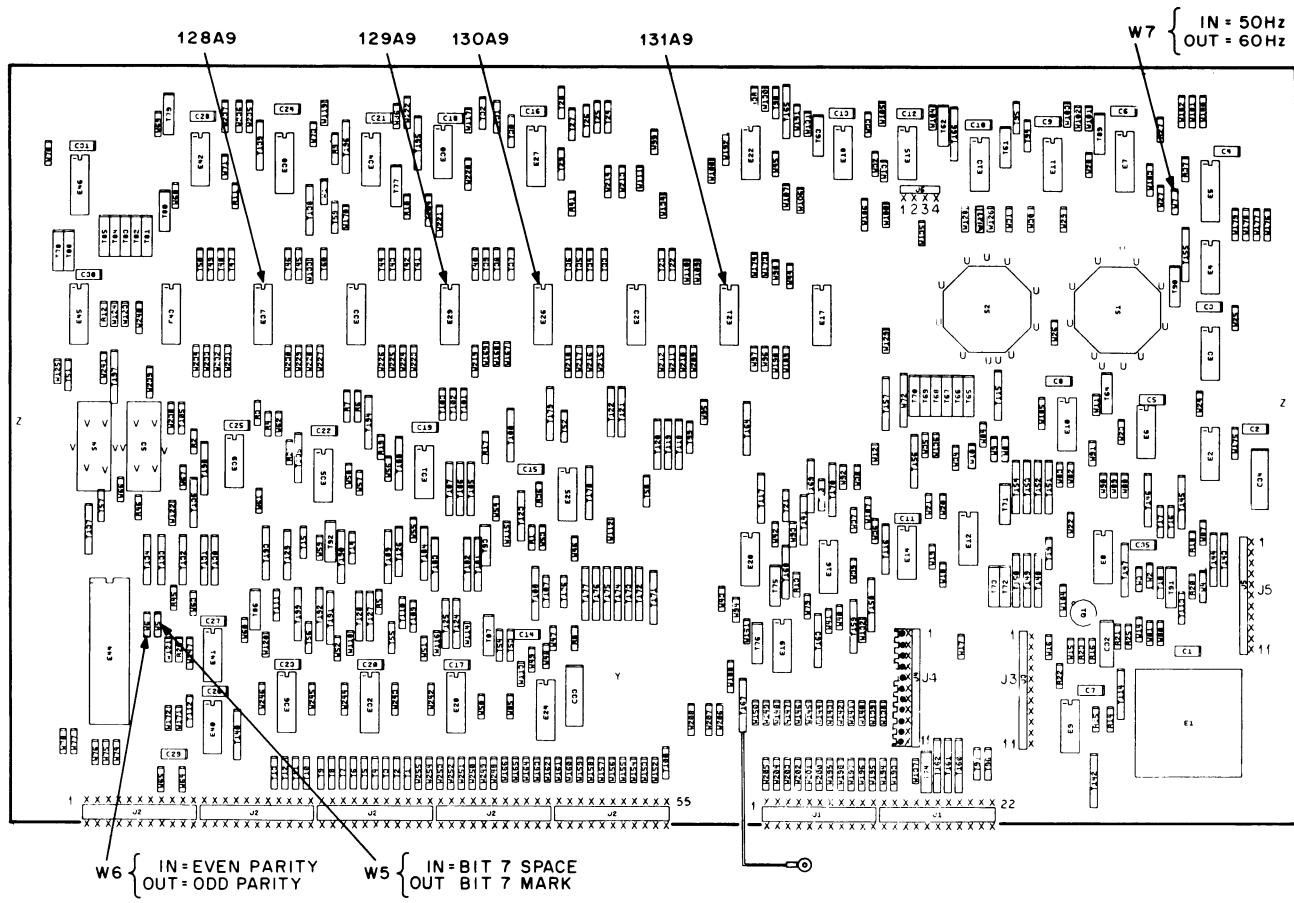

Figure 6-1 VT55 Simplified Signal Flow Diagram



**JUMPER WIRE TABLE**

	VT52	VT51	VT55
W1	OUT	IN	OUT
W2	OUT	IN	OUT
W3	IN	OUT	IN
W4	IN	OUT	IN

CP-2675

Figure 6-2 ROM, UART, and Timing Module

The purpose of the transformer mounting plate assembly is to convert the incoming ac voltage to lower ac voltages that may efficiently be used by the power supply circuit. It also contains a primary circuit breaker and the POWER/LOGIC RESET switch.

When a copier is connected on the VT55, ac wiring for the copier motor is derived from the transformer mounting plate assembly. All other signals, including dc voltages, come from the data path, memory, and decoder module.

### 6.2.3 Troubleshooting Procedure

1. If the VT55 does not function properly, check the setting of the transmission speed and interface mode switches, as well as the placement of the parity switch. Paragraph 3.4.6 discusses these settings.
2. If a problem still exists, turn power off and tip the unit on its top. Be sure to rest it on a clean, smooth surface to avoid scratching the top surface.
3. Remove the base (Figure 6-3). Locate the graphing module (item 82).



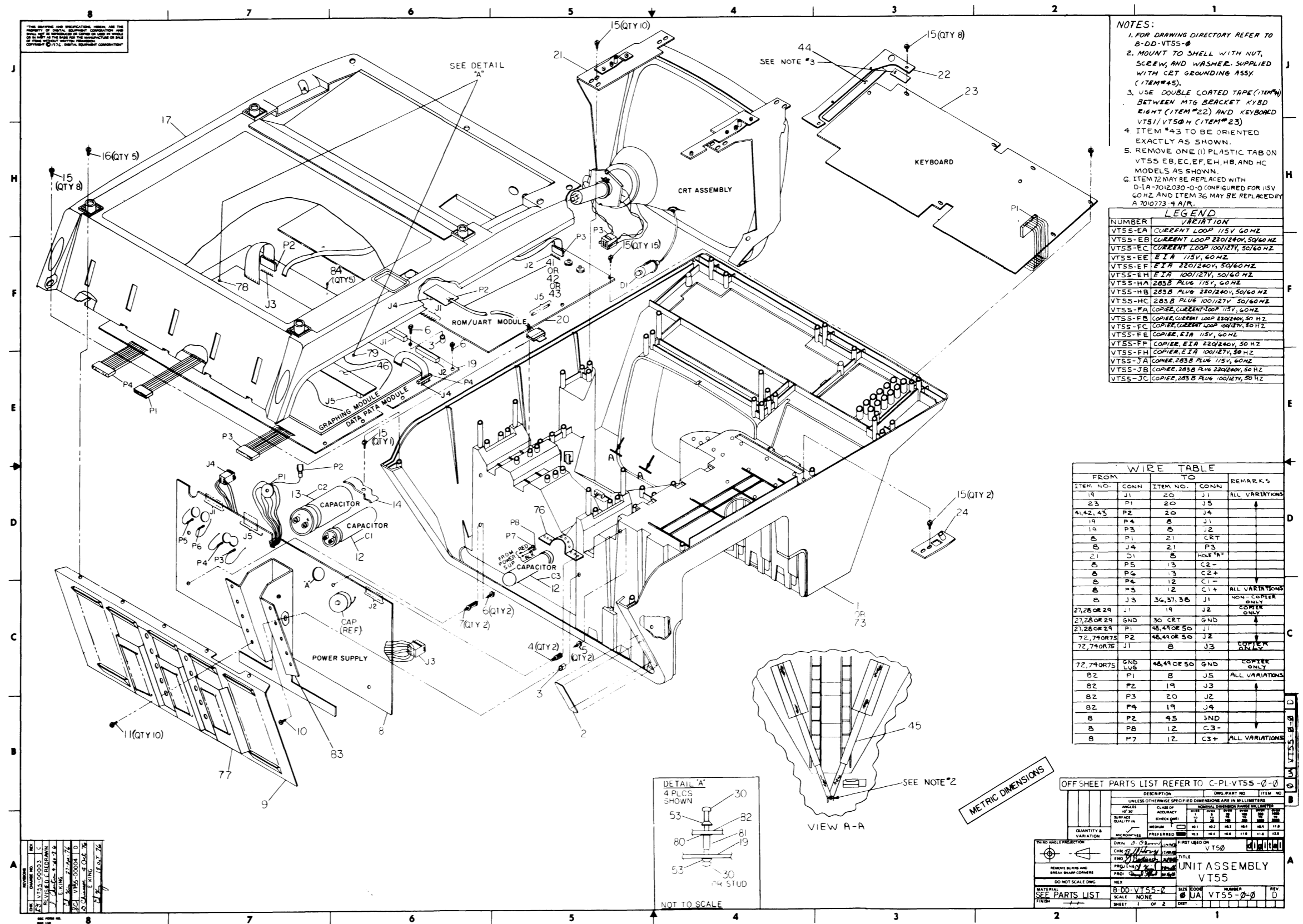

- NOTES:**
1. FOR DRAWING DIRECTORY REFER TO B-DD-VT55-0
  2. MOUNT TO SHELL WITH NUT, SCREW, AND WASHER. SUPPLIED WITH CRT GROUNDING ASSY (ITEM #45).
  3. USE DOUBLE COATED TAPE (ITEM #4) BETWEEN MTG BRACKET KEYBD RIGHT (ITEM #22) AND KEYBOARD VT511/VT504 (ITEM #23)
  4. ITEM #43 TO BE ORIENTED EXACTLY AS SHOWN.
  5. REMOVE ONE (1) PLASTIC TAB ON VT55 EB, EC, EF, EH, HB, AND HC MODELS AS SHOWN.
  6. ITEM #72 MAY BE REPLACED WITH D-1A-7012030-0-0 CONFIGURED FOR 115V 60HZ AND ITEM #36 MAY BE REPLACED BY A 7010773-9 A/R.

**LEGEND**

NUMBER	VARIATION
VT55-EA	CURRENT LOOP 115V 60HZ
VT55-EB	CURRENT LOOP 220/240V, 50/60 HZ
VT55-EC	CURRENT LOOP 100/127V, 50/60 HZ
VT55-EE	EIA 115V, 60 HZ
VT55-EF	EIA 220/240V, 50/60 HZ
VT55-EH	EIA 100/127V, 50/60 HZ
VT55-HA	283B PLUS 115V, 60 HZ
VT55-HB	283B PLUS 220/240V, 50/60 HZ
VT55-HC	283B PLUS 100/127V, 50/60 HZ
VT55-FA	COPIER, CURRENT LOOP 115V, 60 HZ
VT55-FB	COPIER, CURRENT LOOP 220/240V, 50 HZ
VT55-FC	COPIER, CURRENT LOOP 100/127V, 50 HZ
VT55-FE	COPIER, EIA 115V, 60 HZ
VT55-FF	COPIER, EIA 220/240V, 50 HZ
VT55-FH	COPIER, EIA 100/127V, 50 HZ
VT55-JA	COPIER, 283B PLUS 115V, 60 HZ
VT55-JB	COPIER, 283B PLUS 220/240V, 50 HZ
VT55-JC	COPIER, 283B PLUS 100/127V, 50 HZ

**WIRE TABLE**

FROM	TO	REMARKS
ITEM NO.	CONN	ITEM NO. CONN
19	J1	20 J1
23	P1	20 J5
41, 42, 43	P2	20 J4
19	P4	8 J1
19	P3	8 J2
8	P1	21 CRT
8	J4	21 P3
21	P1	8 HOKEY TA*
8	P5	13 C2-
8	P6	13 C2+
8	P4	12 C1-
8	P3	12 C1+
8	J3	36, 37, 38 J1
27, 28 OR 29	J1	19 J2
27, 28 OR 29	GND	30 CRT GND
27, 28 OR 29	P1	48, 49 OR 50 J1
72, 74 OR 75	P2	48, 49 OR 50 J2
72, 74 OR 75	J1	8 J3
72, 74 OR 75	GND	48, 49 OR 50 GND
82	P1	8 J5
82	P2	19 J3
82	P3	20 J2
82	P4	19 J4
8	P2	45 3ND
8	P8	12 C3-
8	P7	12 C3+ ALL VARIATIONS

REV	DESCRIPTION	DATE
1	REVISED C. E. BROWN	11/27/74
2	REVISED C. E. BROWN	11/27/74
3	REVISED C. E. BROWN	11/27/74
4	REVISED C. E. BROWN	11/27/74
5	REVISED C. E. BROWN	11/27/74
6	REVISED C. E. BROWN	11/27/74
7	REVISED C. E. BROWN	11/27/74
8	REVISED C. E. BROWN	11/27/74

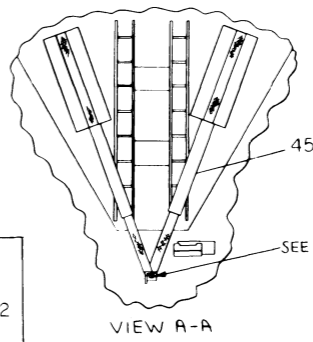
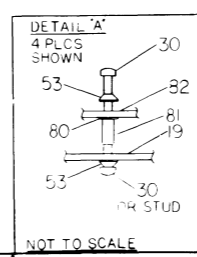

METRIC DIMENSIONS

OFF SHEET PARTS LIST REFER TO C-PL-VT55-0-0

DESCRIPTION	QTY	UNIT	REV
VT55	1	UNIT	0

UNIT ASSEMBLY  
VT55

SCALE NONE

SHEET 1 OF 2

Figure 6-3 VT55 DECscope Assembly Drawing (Sheet 1 of 4)

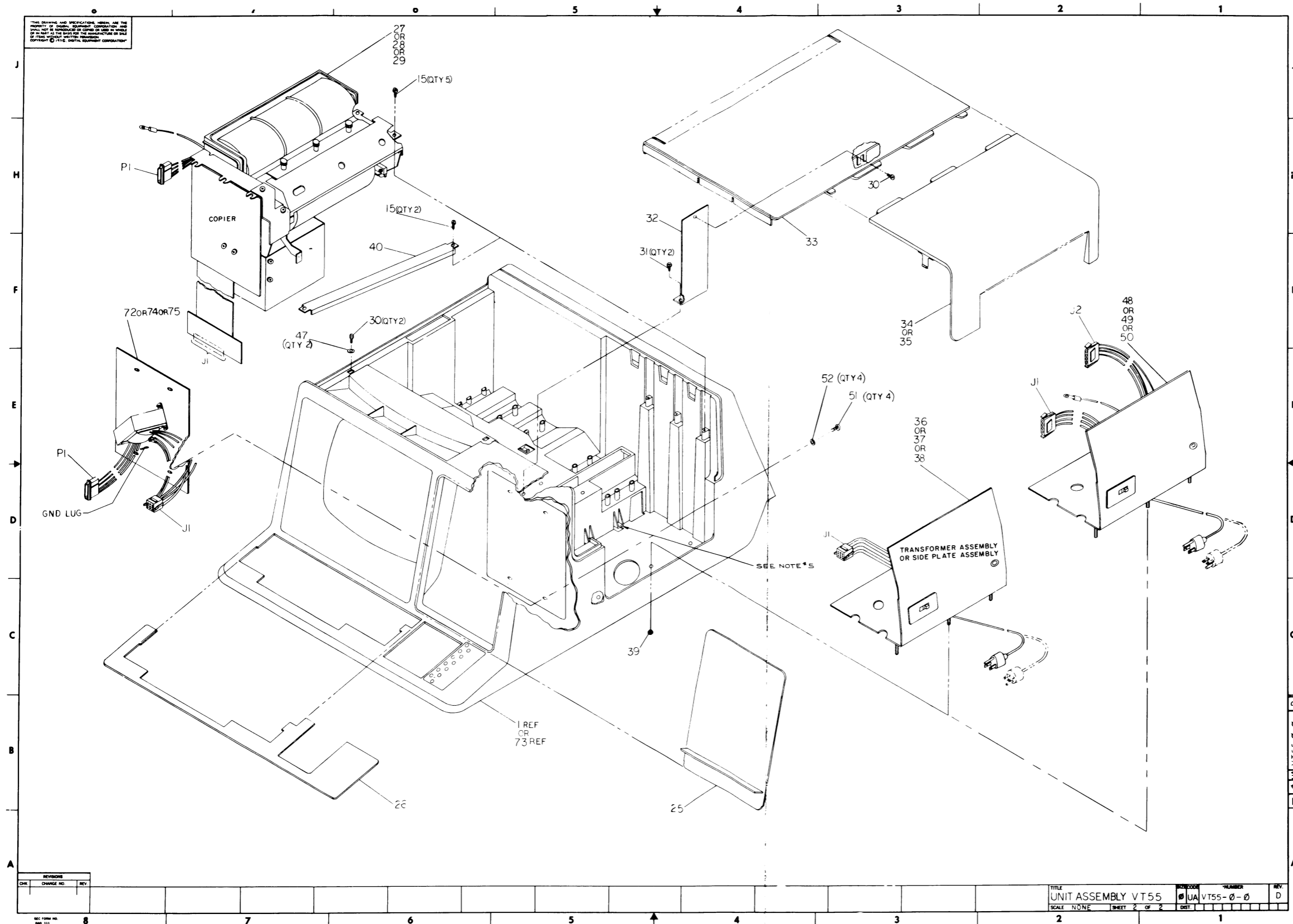

Figure 6-3 VT55 DECscope Assembly Drawing (Sheet 2 of 4)



THIS DRAWING AND SPECIFICATIONS, HEREIN ARE THE PROPERTY OF DIGITAL EQUIPMENT CORPORATION AND SHALL NOT BE REPRODUCED OR COPIED OR USED IN WHOLE OR IN PART AS THE BASIS FOR THE MANUFACTURE OR SALE OF ITEMS WITHOUT WRITTEN PERMISSION. COPYRIGHT ©1976 . DIGITAL EQUIPMENT CORPORATION			3												2												1											
ITEM NO.	PART NO.	DESCRIPTION	VT55-EA	VT55-EB	VT55-EC	VT55-EE	VT55-EF	VT55-EH	VT55-HA	VT55-HB	VT55-HC	VT55-FA	VT55-FB	VT55-FC	VT55-FE	VT55-FH	VT55-JA	VT55-JB	VT55-JC																			
44	9009344-00	DOUBLE COATED TAPE .50W	A/R	A/R	A/R	A/R	A/R	A/R	A/R	A/R	A/R	A/R	A/R	A/R	A/R	A/R	A/R	A/R	A/R																			
45	1-IA-7011197-0-0	CRT, GROUNDING ASSEMBLY	1	1	1	1	1	1	1	1	1	1	1	1	1	1	1	1	1																			
46	D-CS-5411815-0-1	8K CHAR, GENERATOR	1	1	1	1	1	1	1	1	1	1	1	1	1	1	1	1	1																			
47	9006666-00	WASHER, FLAT .500 X .187 I.D. X .032 THK	2	2	2	2	2	2	2	2	2	2	2	2	2	2	2	2	2																			
48	1-AD-7012143-0-0	SIDE PLATE ASSEMBLY (115V,60HZ)	-	-	-	-	-	-	-	-	-	1	-	-	1	-	-	1	-																			
49	1-AD-7012143-1-0	SIDE PLATE ASSEMBLY (220V/240V,50/60HZ)	-	-	-	-	-	-	-	-	-	1	-	-	1	-	-	1	-																			
50	1-AD-7012143-2-0	SIDE PLATE ASSEMBLY (100V/127V,50HZ)	-	-	-	-	-	-	-	-	-	-	1	-	-	1	-	-	1																			
51	9006073-03	SCR., PH TRUSS HD #10-32 X .50	-	-	-	-	-	-	-	-	4	4	4	4	4	4	4	4	4																			
52	9006668-00	WASHER, FLAT .625 X .200 I.D. X .032 THK	-	-	-	-	-	-	-	-	4	4	4	4	4	4	4	4	4																			
53	9009671-00	WASHER #8 METAL WITH GASKET	8	8	8	8	8	8	8	8	8	8	8	8	8	8	8	8	8																			
54	A-PL-VT55-EA-5	SHIPPING LIST (W/O COPIER)	1	-	-	-	-	-	-	-	-	-	-	-	-	-	-	-	-																			
55	A-PL-VT55-EB-5	SHIPPING LIST (W/O COPIER)	-	1	-	-	-	-	-	-	-	-	-	-	-	-	-	-	-																			
56	A-PL-VT55-EC-5	SHIPPING LIST (W/O COPIER)	-	-	1	-	-	-	-	-	-	-	-	-	-	-	-	-	-																			
57	A-PL-VT55-EE-5	SHIPPING LIST (W/O COPIER)	-	-	-	1	-	-	-	-	-	-	-	-	-	-	-	-	-																			
58	A-PL-VT55-EF-5	SHIPPING LIST (W/O COPIER)	-	-	-	-	1	-	-	-	-	-	-	-	-	-	-	-	-																			
59	A-PL-VT55-EH-5	SHIPPING LIST (W/O COPIER)	-	-	-	-	-	1	-	-	-	-	-	-	-	-	-	-	-																			
60	A-PL-VT55-HA-5	SHIPPING LIST (W/O COPIER)	-	-	-	-	-	-	1	-	-	-	-	-	-	-	-	-	-																			
61	A-PL-VT55-HB-5	SHIPPING LIST (W/O COPIER)	-	-	-	-	-	-	-	1	-	-	-	-	-	-	-	-	-																			
62	A-PL-VT55-HC-5	SHIPPING LIST (W/O COPIER)	-	-	-	-	-	-	-	-	1	-	-	-	-	-	-	-	-																			
63	A-PL-VT55-FA-5	SHIPPING LIST (W/COPIER)	-	-	-	-	-	-	-	-	-	1	-	-	-	-	-	-	-																			
64	A-PL-VT55-FB-5	SHIPPING LIST (W/COPIER)	-	-	-	-	-	-	-	-	-	-	1	-	-	-	-	-	-																			
65	A-PL-VT55-FC-5	SHIPPING LIST (W/COPIER)	-	-	-	-	-	-	-	-	-	-	-	1	-	-	-	-	-																			
66	A-PL-VT55-FE-5	SHIPPING LIST (W/COPIER)	-	-	-	-	-	-	-	-	-	-	-	-	1	-	-	-	-																			
67	A-PL-VT55-FH-5	SHIPPING LIST (W/COPIER)	-	-	-	-	-	-	-	-	-	-	-	-	-	1	-	-	-																			
68	A-PL-VT55-JA-5	SHIPPING LIST (W/COPIER)	-	-	-	-	-	-	-	-	-	-	-	-	-	-	1	-	-																			
69	A-PL-VT55-JB-5	SHIPPING LIST (W/COPIER)	-	-	-	-	-	-	-	-	-	-	-	-	-	-	-	1	-																			
70	A-PL-VT55-JC-5	SHIPPING LIST (W/COPIER)	-	-	-	-	-	-	-	-	-	-	-	-	-	-	-	-	1																			
71	A-PL-VT55-JC-5	SHIPPING LIST (W/COPIER)	-	-	-	-	-	-	-	-	-	-	-	-	-	-	-	-	1																			
72	D-IA-7012032-0-0	XFORMER PLATE ASSY (115V,60HZ)	-	-	-	-	-	-	-	-	-	1	-	-	1	-	-	1	-																			
73	2-MD-7414866-0-0	SHELL, REWORKED	-	-	-	-	-	-	-	-	-	1	1	1	1	1	1	1	1																			
74	D-IA-7012030-0-0	XFORMER PLATE ASSY (220V/240V,50/60HZ)	-	-	-	-	-	-	-	-	-	-	1	-	-	1	-	-	1																			
75	D-IA-7012030-1-0	XFORMER PLATE ASSY (100V/127V,50.60HZ)	-	-	-	-	-	-	-	-	-	-	-	1	-	-	1	-	-																			
76	1212678	PERFORATED PLASTIC STRAP 6MM X 125MM	1	1	1	1	1	1	1	1	1	1	1	1	1	1	1	1	1																			
77	D-MD-7413410-0-0	HEAT SHIELD	1	1	1	1	1	1	1	1	1	1	1	1	1	1	1	1	1																			
78	A-SP-370014-1-0	PACKAGING INSTRUCTIONS WITH COPIER	-	-	-	-	-	-	-	-	-	1	1	1	1	1	1	1	1																			
79	<del>9006047-01</del>	<del>SCREW, PAN HEAD #8-32 X 2</del>	<del>1</del>	<del>1</del>	<del>1</del>	<del>1</del>	<del>1</del>	<del>1</del>	<del>1</del>	<del>1</del>	<del>1</del>	<del>1</del>	<del>1</del>	<del>1</del>	<del>1</del>	<del>1</del>	<del>1</del>	<del>1</del>	<del>1</del>																			
80	9006713	WASHER, NYLON .437 O.D.	4	4	4	4	4	4	4	4	4	4	4	4	4	4	4	4	4																			
81	9007869	SPACER, 1"	4	4	4	4	4	4	4	4	4	4	4	4	4	4	4	4	4																			
82	E-CS-M7024-0-1	VT55 GRAPHING CONTROL MODULE	1	1	1	1	1	1	1	1	1	1	1	1	1	1	1	1	1																			
83	9008268	THERMAL COMPOUND	A/R	A/R	A/R	A/R	A/R	A/R	A/R	A/R	A/R	A/R	A/R	A/R	A/R	A/R	A/R	A/R	A/R																			
84	9006041-01	SCREW, MACHINE #8-32 X 3/4	5	5	5	5	5	5	5	5	5	5	5	5	5	5	5	5	5																			
85	<del>6-11-7410412-2-0</del>	<del>SHIELD, EMI</del>	<del>1</del>	<del>1</del>	<del>1</del>	<del>1</del>	<del>1</del>	<del>1</del>	<del>1</del>	<del>1</del>	<del>1</del>	<del>1</del>	<del>1</del>	<del>1</del>	<del>1</del>	<del>1</del>	<del>1</del>	<del>1</del>	<del>1</del>																			
			115V, 60HZ	220V/240V 50/60HZ	100V/127V 50/60HZ	115V/60HZ	220V/240V 50/60HZ	100V/127V 50/60HZ	115V, 60HZ	220V/240V 50/60HZ	100V/127V 50/60HZ	115V, 60HZ	220V/240V 50/60HZ	100V/127V 50/60HZ	115V, 60HZ	220V/240V 50/60HZ	100V/127V 50/60HZ	115V, 60HZ	220V/240V 50/60HZ																			

REV.	
CHANGE NO.	
CHK	

DRN. <i>A. J. Smith</i>	DATE <i>11/11/72</i>	FIRST USED ON VT55	<b>digital</b>
CHK'D <i>B. J. Smith</i>	DATE <i>11/11/72</i>	TITLE UNIT ASSY VT55	
ENG. <i>J. J. Smith</i>	DATE <i>11/11/72</i>	NEXT HIGHER ASSY. 0-UA-VT55-0-0	
PROD. <i>L. J. Smith</i>	DATE <i>11/11/72</i>	SCALE 1:1	REV. E
SHEET 2 OF 2		SIZE C PL	NUMBER VT55-0-0
DIST.			

DEC FORM NO. DRC 110 A

Figure 6-3 VT55 DECscope Assembly Drawing (Sheet 4 of 4)

4. Note the position of the graphing module plugs. Disconnect plugs P1, P2, P3, and P4. The graphing module is now disconnected from the VT55 circuit.
5. Turn power on and check to see if the problem is gone. The terminal should be able to display and transmit alphanumeric data.
6. Replace the graphing module if necessary.
7. Remove jumpers W1 and W2 when line frequency is 60 Hz (Figure 3-9).
8. Adjust the graphic and alphanumeric alignment by following the procedure in Paragraph 6.2.5, steps 9-12.
9. If the problem remains, disconnect the keyboard connector, P1, from the ROM, UART, and timing module (item 20).
10. Place the good, spare keyboard on a piece of cardboard on top of the ROM, UART, and timing module.
11. Connect the spare keyboard in place of the internal keyboard. Always be careful to note proper orientation of module interconnection plugs. Figure 6-3 accurately depicts routing of interconnections. A twisted or misplaced cable can cause a module failure.
12. If keyboard replacement does not solve the problem, totally remove the graphing module per Figure 6-3 by removing the four stand-offs that mount this module. Do not misplace any of the hardware associated with these stand-offs. Detail A in Figure 6-3 shows the assembly of the four stand-offs.
13. If the VT55 terminal has a copier, disconnect copier signal connections by first removing all screws that fasten the data path, memory, and decoder module and ROM, UART, and timing module to the shell. Proceed to step 20 if the machine has no copier.
14. Disconnect P1 on the keyboard, and P3 and P4 on the data path module (item 19).
15. Gently lift the module pair to expose the connector from the copier.
16. Remove J1 on the copier by gently pulling at either side of the connector or by gently prying with a screwdriver. Note the orientation before removing.
17. Replace P1 on the keyboard, and P3 and P4 on the data path module.
18. Replace a few screws to properly center the modules in the shell. Be sure to include some screws in the J1-J1 area, the interconnection of item 20 (ROM, UART, and timing module) and item 19 (data path module). A misalignment with the metal CRT bracket below may cause a short circuit.
19. If the unit functions now, the copier must be replaced. Refer to Paragraph 6.2.4 for the copier replacement procedure.
20. If the VT55 is still faulty, the microprocessor module pair should be replaced next. With the copier still detached, remove the ROM, UART, and timing module and the data path module as a pair, as before.

21. Remove the replacement modules from their packing material and place them on a flat surface. Insert the 8K character generator module into the data path module. Orientate the module so that the part designated "rear" on the module points to the rear of the machine. Insert ROMs 23-128A9, 23-129A9, 23-130A9, and 23-131A9, into the ROM, UART, and timing module as shown in Figure 6-2. Check jumpers W5, W6, and W7 for the desired configuration
22. Carefully attach J1 to J1 by pressing the two boards together. Ensure that all 77 pins are properly aligned or damage to the modules will occur. Alternating slight pressure on either side until the connectors are firmly seated is the best way to make this attachment.
23. Retest the VT55 by installing the replacement module pair into the VT55 shell.
24. Replace copier plug J1.
25. Replace P1 on the keyboard, and P3 and P4 on the data path module.
26. Replace a few screws to properly center the modules in the shell. Be sure to include some screws in the J1-J1 area between the ROM, UART, and timing module and the data path module.
27. If the machine functions now, the module pair should be left in the machine. Replace all screws that fasten these modules and add the graphing control module (per detail A on Figure 6-3).
28. Remove jumper W7 on the ROM, UART, and timing module if the machine is to be run on a 60 Hz power line. Leave this jumper installed if this is a 50 Hz machine. W7 adjusts the screen frame rate to that of the line frequency to eliminate annoying flicker. The location of W7 is shown in Figure 6-2.
29. The shell may now be reassembled. Detach the original ROM, UART, and timing module from the data path module and return these to the Field Service Repair Depot. Use the packing material that came with the new board set. Detachment is facilitated by gently prying with a screwdriver on alternate sides of the J1-J1 interconnection.
30. If the new microprocessor module pair did not correct the defect, the power supply/monitor module must be replaced next. Remove the new microprocessor module set, detach as above, and put them back into their packing material.
31. Remove the heat sink and heat shield, items 9 and 77 in Figure 6-3. These are the pieces of metal that form the back of the machine.
32. Remove the high-voltage diode cap from diode D1 on the power supply/monitor module (item 8).

**WARNING**

**High voltage may be present on the D1 terminal; therefore, handle only insulated material when discharging.**

33. Connect a #22 insulated wire from the exposed terminal of D1 to the bare area of metal on the large power transistor heat spreader that is mounted on the power supply/monitor module. This will discharge any high voltage that might appear on D1 due to a charged CRT. After 15 seconds remove the wire. Avoid getting white thermal compound on clothing when working on the power supply/monitor module.
34. Remove the connectors J4, P1, P2, and J3 from the power supply/monitor module as shown in Figure 6-3.
35. Detach the six connectors (P3, P4, P5, P6, P7, and P8) from the three electrolytic capacitors (C1, C2, and C3). Note the wire table indicating these connections in Figure 6-3.
36. The module may now be replaced by removing one screw from the heat spreader bracket (item 10).
37. Release the board by gently pinching the four plastic studs that hold it to the frame, one at a time.
38. Reassemble the VT55 with the new power supply/monitor module and retest.

**WARNING**

**Do not attempt to replace high-voltage diode D1. Use the diode already in the shell. Replacement of D1 or the CRT assembly must be performed at a DIGITAL Field Service Depot due to the hazards of high voltage and glass tube implosion. The new diode D1 should be placed in the module carton with returned module.**

39. If the terminal is now functional, refer to Paragraph 6.2.5 for the video adjustment procedure.
40. If the unit still does not function, the transformer mounting plate assembly, C1, C2, C3, and the CRT assembly may be at fault.
41. Remove the microprocessor module set and measure the dc voltage across C1, C2, and C3 with a voltmeter. Then measure the ac voltage. Voltages should be within 20 percent of the values given in Table 6-3. The reading is taken with the negative meter lead on the negative capacitor terminal.

**Table 6-3 Capacitor Voltages  
(All Logic Modules Disconnected)**

Capacitor	DC Voltage (V)	Vdc Plus AC Ripple (Vrms)
C1	26	28
C2	13	14
C3	25	27

42. If the capacitors test satisfactorily, test the secondary voltages of the transformer by measuring voltage at J1. Remove J1 from J3 on the power supply module to make this measurement (Table 6-4).
43. If the unit is still not functional, only the CRT assembly can be at fault at this point. Although the CRT assembly must be replaced at a Field Service Depot, voltages being supplied to the CRT neck socket may be verified with Table 6-5 if desired. Measure at the power supply end of the CRT cable with respect to ground on the heat spreader bracket.

High voltage applied to the anode of the CRT may be verified by listening for a faint, high-pitched, high-voltage power supply noise, characteristic of a functional high-voltage circuit.

If these procedures do not repair the VT55, reassemble the entire unit. Repack the unit as described in Paragraph 6.3 and return it to a DIGITAL Field Service Depot Repair Facility.

**Table 6-4 Transformer Secondary Voltages  
(Items 36, 37, 38, 72, 74, or 75 on Figure 6-3)**

Colors	J1 Terminals	Voltage (Vac rms $\pm$ 20%)
VIO-VIO/BLK	J1-4 to J1-6	13
VIO-VIO/BLK	J1-5 to J1-6	13
BLU-BLU/BLK	J1-7 to J1-9	27
BLU-BLU/BLK	J1-8 to J1-9	27

**Table 6-5 CRT Base Voltages**

Color	Pin No.	Voltage (Vdc $\pm$ 20%)	Description
Green	1	0 $\rightarrow$ -80 (Intensity Potentiometer)	Grid 1 (Intensity)
Yellow	2	40 V (with negative logic pulses for video data generation)	Cathode
Brown	3	-12	Heater - a visible glow should be apparent in neck of tube.
Black	4	Ground	
	5		Not used
Red	6	+360	Screen Grid
Blue	7	-80 $\rightarrow$ +450 (Focus Potentiometer)	Focus



#### 6.2.4 Copier Replacement Procedure

1. Remove the ac power cord. The copier is installed in an area where dangerous voltages are present when the power cord is installed.
2. Remove the copier cover (item 35 in Figure 6-3). It may be easily released by locating one of the two spring clips which hold it to the shell and pressing with a screwdriver or similar tool (Figure 6-4).

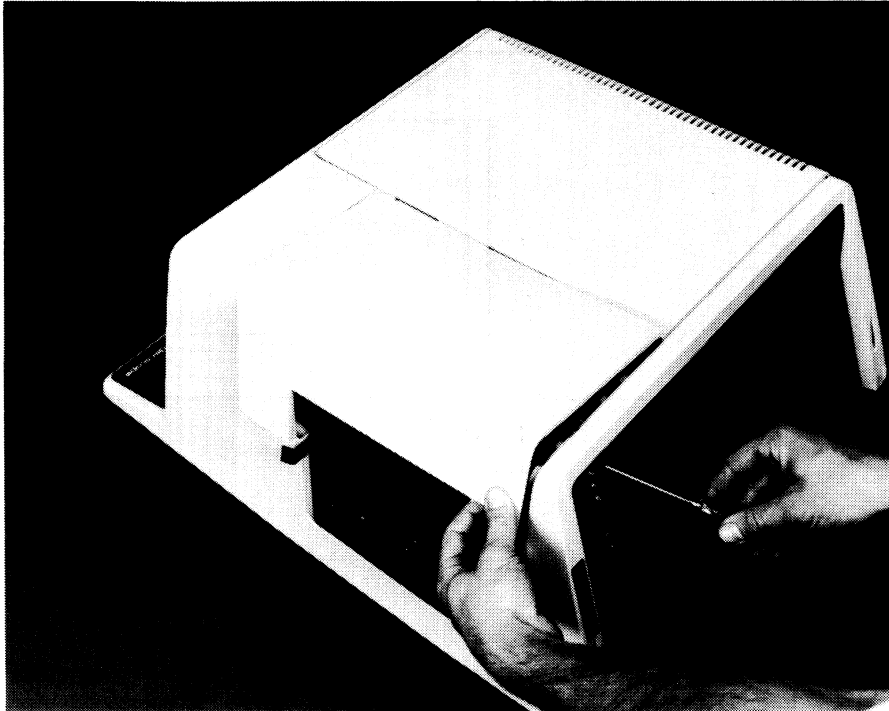

7717-11

Figure 6-4 Removal of Copier Cover

3. Remove the copier from the shell. Figure 6-3 shows the five screws that hold the copier to the shell. Gently lay the copier on a table or shell to facilitate detaching connecting cables.
4. Detach the Mate-N-Lok connector that connects the copier to the ac line voltage and transformer secondary. It has four wires – red, red/yellow, black, and white.
5. Gently remove copier signal connector J1. A slight rocking motion may be used to accomplish this. Avoid breaking or bending the connector pins. Holding the data path module from the bottom will keep the mating socket steady while J1 is being retracted. Note positioning of J1 before removing.

6. Remove the green copier ground wire from the ground lug on the inside of the transformer mounting plate assembly. A nutdriver should be utilized to remove the fastening nut.
7. Install the new copier by reversing the above steps. Pack the defective copier in the supplied packing material and return to a DIGITAL Field Service Depot for repair.

### 6.2.5 Video Adjustment Procedure

With the heat shield and heat sink removed from the power supply/monitor module, the image on the VT55 may be checked for accurate alignment. Normally, slight adjustment of the monitor will be required to make the display meet specifications. Refer to Figure 6-5 when making these adjustments.

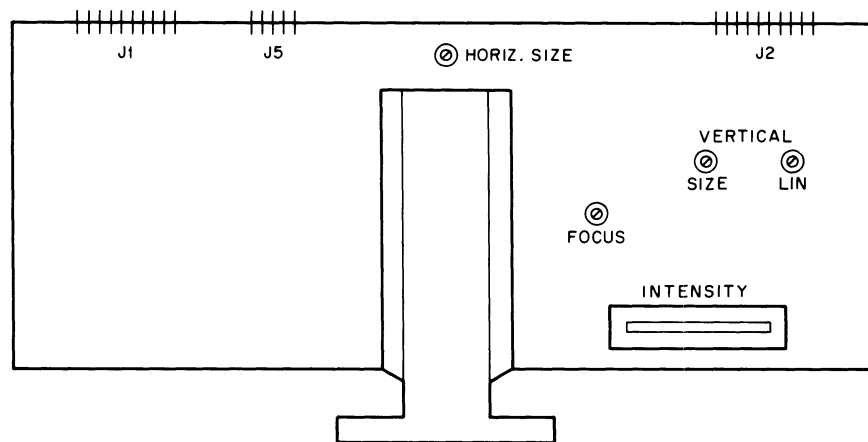

CP-2521

Figure 6-5 Location of Controls on Power Supply Monitor Module

1. With the terminal in local mode, type the following sequence of characters on the keyboard: ESC, 1, A, ?, I, ?, L, SPACE, 0, ?, ?, D, +, 7, ESC, and 2. A rectangle should appear on the screen. This part of the procedure is for adjusting the box to 203 × 127 mm (8.0 × 5 inches) in size to within ±6.5 mm (1/4 inches).
2. If the rectangle is not parallel with the four edges of the plastic frame around the glass face of the tube, the yoke must be adjusted. The yoke is accessed through a hole under the two top covers on the VT55. Remove the blank cover and copier cover, items 35 and 36 in Figure 6-3.
3. Loosen the yoke clamp screw and ensure that the yoke is as far forward on the CRT neck as possible. Turn the yoke to make the box parallel with the four sides of the VT55's front.
4. Center the pattern on the screen by adjusting the tabs on the yoke.
5. Adjust the horizontal size control for the 203-mm (8.0-inch) dimension of the box.
6. Adjust the vertical size control for the 127-mm (5-inch) dimension of the box. Flip the POWER/LOGIC RESET switch once to clear the screen.

7. Type some characters on the top line, bottom line, and in the center of the VT55 screen. Adjust the vertical linearity control so that character heights are nearly equal on all three lines.
8. When this procedure is complete, all box adjustments, including centering of the box, must be  $\pm 6.5$  mm (1/4 inch). All characters must look equal in size, on all 24 lines of text, when viewed from a normal operator's position in front of the terminal.
9. Type two vertical columns of the letter H in the first two columns of the video screen. Type one vertical column of the letter H in column 80.
10. Replace the rectangular box on the screen as in step 1 of this procedure.
11. Ensure that the left side of the rectangular box passes through the left side of the second column of the letter H. The right side of the rectangular box should pass through the right side of the column of Hs in column 80 (Figure 6-6).
12. If the alignment of the alphanumeric and graphic data is not as shown in Figure 6-6, turn the potentiometer on the M7024 graphing module until the display agrees with Figure 6-6.

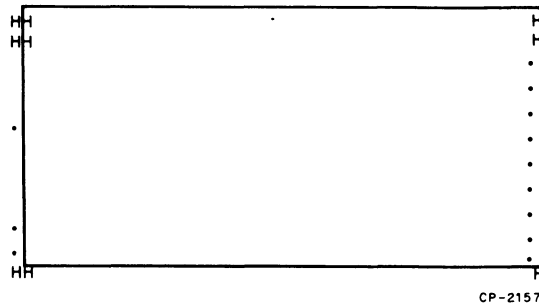

Figure 6-6 Alignment of Alphanumerics and Graphics

### 6.3 PACKING OF DECscope

The VT55 shipping package is described in Table 6-6 and packing instructions follow.

Table 6-6 VT55 Shipping Package

Quantity	Part No.	Description
1	9905698	Regular slotted carton
1 (set)	9905699	Foam pieces (1 set equals 6 pieces)
1	9905639	Laminated buildup
14 ft	9905729	Carton sealing tape
2 ft	9009634	Tape (Scotch, Y-8921)
1	9905935	3/8 square wood
1	9905937	Taped tube
2	9007032	Tie wrap 6-3/4 long
1	9905936	Convolutud polyurethane foam pad
1	9905938	Paper tube

1. Refer to Figure 6-7. Set up the regular slotted carton (9905698). Tape with one strip of carton sealing tape (9905729) across the middle and one strip across each end.

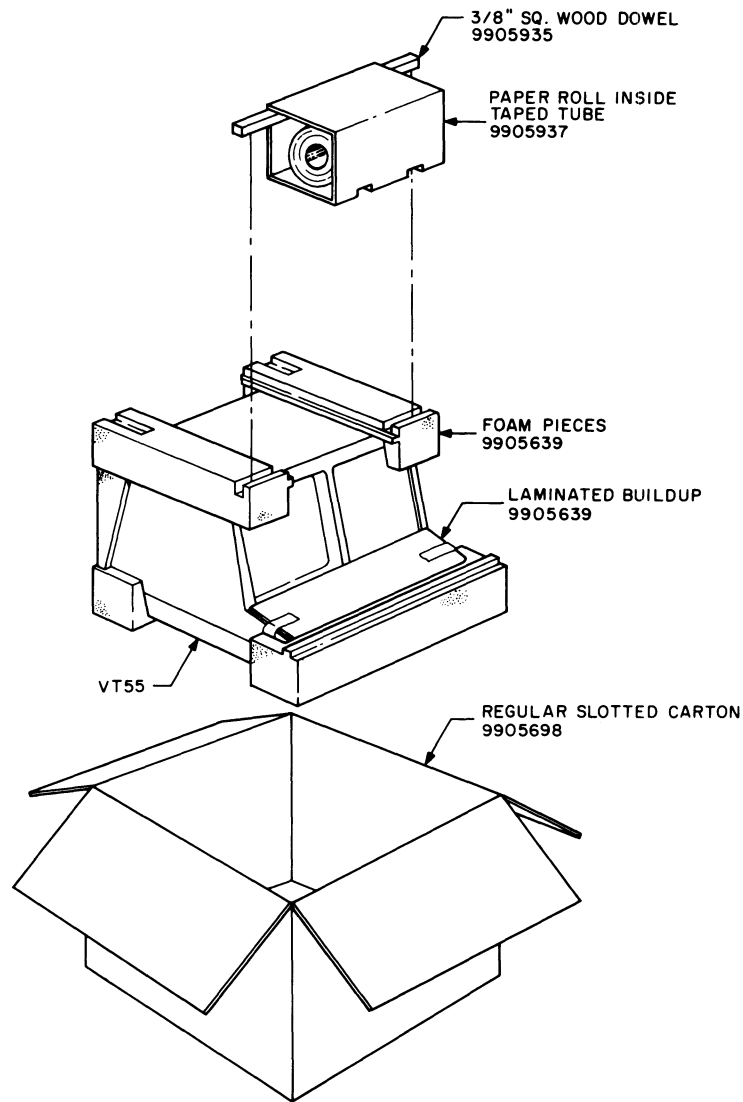

CP-2529

Figure 6-7 VT55 Packing

2. Place the laminated buildup (9905639) on top of the keyboard. Place one strip of tape (9009634) on each end of the buildup. Pull the tape down and secure it to the base of the VT55.
3. Remove the terminal cover to expose the copier.
4. Tie the anode holder to the copier chassis using two tie wraps (9007032)

5. Pick up the anode holder, place the grey convoluted foam pad (9905936) between the rollers, replace the anode holder, and tuck the foam snugly into each end.
6. Replace the terminal cover.
7. Place the VT55 terminal into the front and rear foam pieces (9905699). Place the assembly into the regular slotted carton (9905698).
8. Place the right and left rear vertical foam pieces (9905699) into position on the VT55 terminal.
9. Place the top right and top left foam pieces (9905699) into position on the VT55.
10. Place the power cord into the void beside the VT55 terminal.
11. Place the user's manual on top of the VT55 terminal.
12. Slide a square wooden rod into the slots in the top foam pieces. Tape the rod into the slots using two strips of tape (9009634) on each foam piece.
13. Close and seal the regular slotted carton using one strip of carton sealing tape (9905729) across the top and one strip across each end panel.

UNIVERSITY OF CALIFORNIA LIBRARY

# Reader's Comments

VT55-E, F, H, J DECgraphic SCOPE  
USERS' MANUAL  
EK-VT55E-TM-001

Your comments and suggestions will help us in our continuous effort to improve the quality and usefulness of our publications.

What is your general reaction to this manual? In your judgment is it complete, accurate, well organized, well written, etc.? Is it easy to use? \_\_\_\_\_  
\_\_\_\_\_  
\_\_\_\_\_

What features are most useful? \_\_\_\_\_  
\_\_\_\_\_  
\_\_\_\_\_

What faults do you find with the manual? \_\_\_\_\_  
\_\_\_\_\_  
\_\_\_\_\_

Does this manual satisfy the need you think it was intended to satisfy? \_\_\_\_\_

Does it satisfy *your* needs? \_\_\_\_\_ Why? \_\_\_\_\_  
\_\_\_\_\_  
\_\_\_\_\_

Would you please indicate any factual errors you have found. \_\_\_\_\_  
\_\_\_\_\_  
\_\_\_\_\_

Please describe your position. \_\_\_\_\_

Name \_\_\_\_\_ Organization \_\_\_\_\_

Street \_\_\_\_\_ Department \_\_\_\_\_

City \_\_\_\_\_ State \_\_\_\_\_ Zip or Country \_\_\_\_\_

-----  
**Fold Here**  
-----

-----  
**Do Not Tear - Fold Here and Staple**  
-----

**FIRST CLASS  
PERMIT NO. 33  
MAYNARD, MASS.**

**BUSINESS REPLY MAIL  
NO POSTAGE STAMP NECESSARY IF MAILED IN THE UNITED STATES**

**Postage will be paid by:**

**Digital Equipment Corporation  
Technical Documentation Department  
Maynard, Massachusetts 01754**

