

# GIGI

VK100

Terminal Installation  
and Owner's Manual

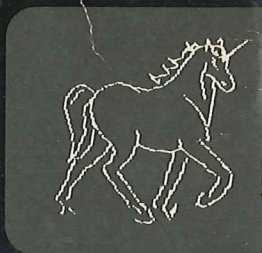
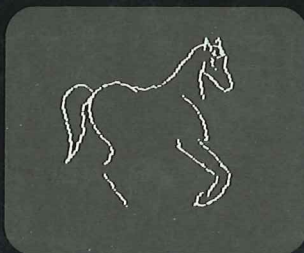
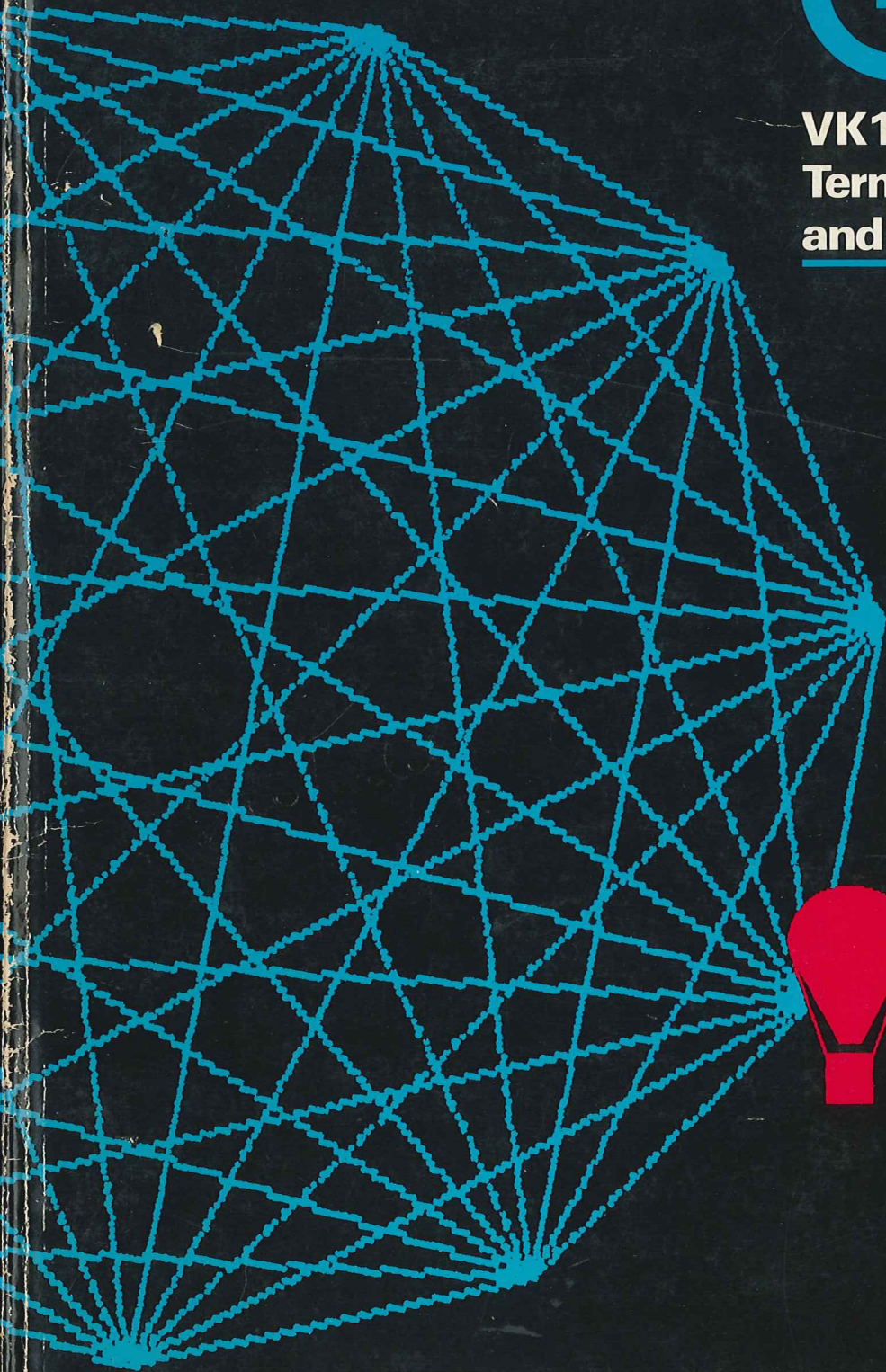

digital

DIGITAL EQUIPMENT CORPORATION

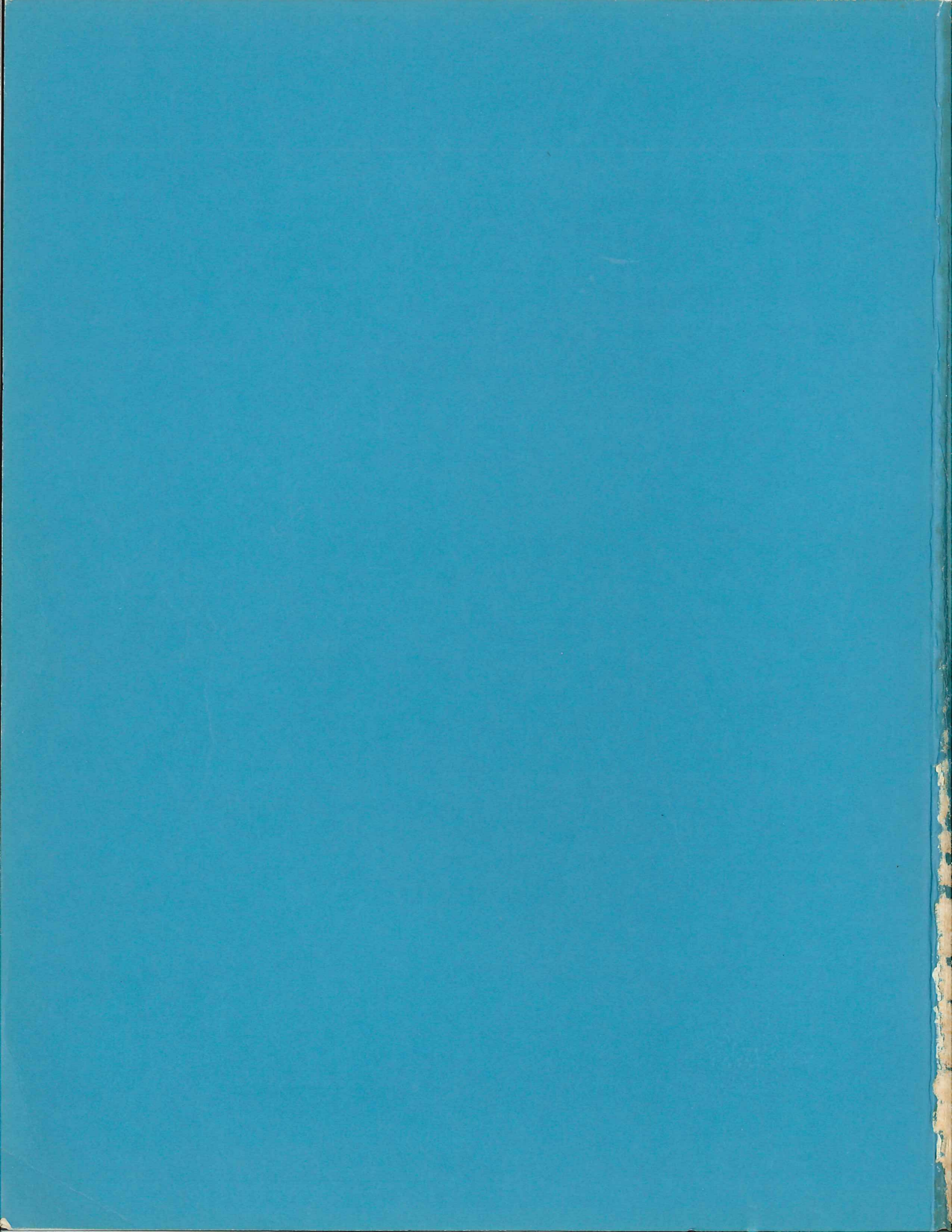

# **GIGI TERMINAL INSTALLATION AND OWNER'S MANUAL**

**EK-VK100-IN-001**

1st Edition, January 1981

This document includes material from Microsoft Basic-80. Copyright © 1979 by Microsoft. All rights reserved.

®Barco Model GD33 monitor is a registered trademark of the Barco Corporation.

Copyright © 1981 by Digital Equipment Corporation

The material in this manual is for informational purposes only and is subject to change without notice.

Digital Equipment Corporation assumes no responsibility for any errors which may appear in this manual.

Printed in U.S.A.

The following are trademarks of Digital Equipment Corporation:

DEC	DECnet	IAS
DECUS	DECsystem-10	MASSBUS
DIGITAL	DECSYSTEM-20	PDT
Digital Logo	DECwriter	RSTS
PDP	DIBOL	RSX
UNIBUS	EduSystem	VMS
VAX	OMNIBUS	VT
OS/8		

# CONTENTS

---

## HOW TO USE THIS MANUAL

---

### CHAPTER 1 INTRODUCTION

---

Gigi as a Text Terminal .....	1
Gigi as a Graphics Terminal .....	2
Gigi as a Basic Terminal .....	3

---

### CHAPTER 2 INSTALLATION

---

Site Considerations .....	5
Unpacking and Inspection .....	6
Repacking .....	7
Installation .....	7
Connecting to the Barco Model GD33 Monitor .....	12
Connecting to a Typical Black and White Monitor .....	14
Connecting to the LA34VA Graphics Printer .....	14
Connecting Directly to the LA34VA Graphics Printer .....	15
Adding a Terminal to a Multiterminal String .....	16
Removing a Terminal from a Multiterminal String .....	18

---

### CHAPTER 3 GENERAL OPERATING INFORMATION

---

Introduction .....	19
Terminal Controls .....	19
Keyboard Controls .....	19
Standard Keys .....	20
Special Function Keys .....	20
SET-UP Mode Keys .....	23
Locator Mode Keys .....	24
Visual and Audible Indicators .....	25
Visual Indicators .....	25
Audible Indicators .....	27

---

### CHAPTER 4 TERMINAL SET-UP

---

Introduction .....	29
SET-UP Mode Description .....	29
SET-UP Parameter Summary .....	30
Determining What a SET-UP Parameter Does .....	34
Changing a SET-UP Parameter (Operator) .....	36
SET-UP Parameter Descriptions .....	36
Transmit Speed (TS) .....	36
Receive Speed (RS) .....	37
Line/Local (LL) .....	37
BASIC (BA) .....	37
Parity Enable (PE) .....	37
XON/XOFF (XO) .....	38
Scroll Mode (SM) .....	38
Reverse Video (RV) .....	39

CONTENTS

Horizontal Margins (HM) .....	39
Vertical Margins (VM) .....	39
Expansion Mode (EM).....	40
Horizontal Position (HP).....	40
Overstrike (OS) .....	40
Visual Cursor (VC).....	40
Text Display (TD).....	41
Graphics Display (GD) .....	41
Graphics Prefix (GP).....	41
Single Character (SC).....	42
Local Echo (LE) .....	42
New Line (NL) .....	42
Auto Hardcopy (AH) .....	42
Auto Wraparound (AW).....	42
Key Repeat (KR).....	43
Keyclick (KC).....	43
Margin Bell (MB) .....	43
Terminal Mode (TM).....	43
Keypad Mode (KM).....	43
Cursor Key Mode (CK) .....	43
Programmed Keypad Mode (PK) .....	44
Tablet Locator Mode (TL) .....	44
United Kingdom Character Set (UK) .....	44
Communications Interface (CI) .....	44
Hardcopy Speed (HS) .....	44
Power Frequency (PF).....	45
Interlace (IL) .....	45
Self-Test (ST) .....	45
Changing a SET-UP Parameter (Host Computer).....	45

---

**CHAPTER 5    WHAT TO DO IN THE EVENT OF A PROBLEM**

---

Introduction .....	47
Internal Hardware Self-Tests .....	47
Power-Up Self-Test.....	47
Diagnostic Tests.....	48
Error Codes .....	50
Common Problems.....	53

---

**CHAPTER 6    HOW TO GET YOUR TERMINAL REPAIRED**

---

Introduction .....	55
Product Warranty .....	55
Warranty Repairs.....	55
DIGITAL Maintenance Service Repairs .....	56
On-Site Service Agreements.....	57
DIGITAL Servicenters.....	57

CONTENTS

---

<b>CHAPTER 7</b>	<b>PROGRAMMING SUMMARY</b>	
	Introduction .....	59
	Keyboard Codes.....	59
	Standard Key Codes.....	59
	Cursor Control Key Codes .....	59
	Auxiliary Keypad Codes.....	59
	Control Characters .....	60
	Character Sets .....	62
	Control Functions .....	63
	ANSI Mode Definitions .....	64
	ANSI Control Functions Summary .....	66
	VT52 Control Function Summary .....	70
	ReGIS Summary .....	70
	BASIC Summary.....	75
<b>CHAPTER 8</b>	<b>HARDWARE INTERFACES</b>	
	Communications Interface.....	77
	Baud Rate .....	77
	Character Format .....	77
	EIA Interface .....	77
	20 mA Current Loop Interface.....	79
	Buffer Overflow Prevention.....	79
	Display Interface .....	82
	Composite Video Port (MONO).....	82
	Color Monitor Port (RED, GREEN, BLUE).....	82
	Composite Sync Waveform Timing .....	83
	Monitor Selection.....	83
	Hardcopy Interface .....	84
	Physical Interface .....	84
	Electrical Interface.....	85
	Hardcopy Device Sharing .....	85
<b>CHAPTER 9</b>	<b>ACCESSORIES AND SUPPLIES</b>	
	Features.....	87
	Related Documentation.....	88
	How to Order Accessories and Supplies .....	91
	Toll-Free Telephone Orders.....	91
	Direct Mail Orders.....	91
<b>APPENDIX A</b>	<b>GIGI TERMINAL SPECIFICATIONS</b>	

---

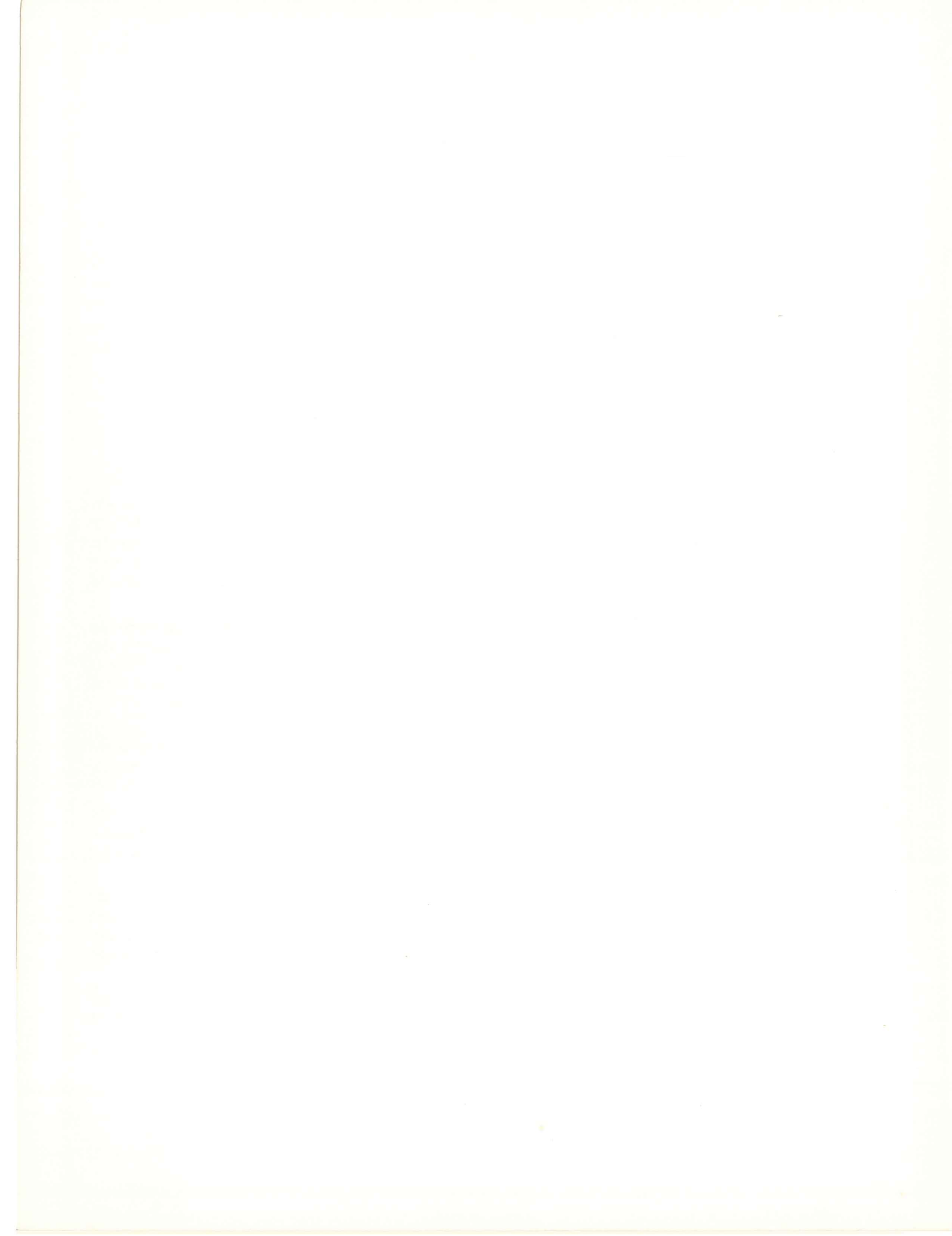



# HOW TO USE THIS MANUAL

This manual has four very specific goals. These goals are:

1. Introduce the GIGI terminal and its many features and operating modes
2. Provide a simple, easy-to-follow procedure to install and check out the GIGI terminal
3. Provide the information needed to operate the GIGI terminal and set the terminal up to work with a host computer
4. Provide easy-to-follow instructions to ensure that the GIGI terminal is operating correctly and to have the terminal quickly repaired at an authorized DIGITAL Servicenter if a failure occurs.

Chapter 1 introduces you to the GIGI terminal and its basic operating modes. This information provides a general understanding of how the terminal operates within the GIGI system.

Chapter 2 provides all the information needed to successfully install and check out the GIGI terminal. This includes instructions on how to connect the terminal to the Barco Model GD33 monitor and the LA34VA graphics printer.

Chapter 3 provides an overview of all of the terminal controls and indicators.

Chapter 4 provides GIGI terminal SET-UP information. The information is divided into two areas – terminal SET-UP procedure and SET-UP parameters. The terminal SET-UP procedure consists of simple, easy-to-follow steps. The SET-UP parameter descriptions discuss how each feature affects the terminal. Before reading this chapter, you should understand the basic terminal operating modes outlined in Chapter 1.

Chapter 5 provides a complete description of all the tests available to the GIGI terminal user, with instructions to perform each test. This chapter also contains a simple troubleshooting chart. The chart lists common problems and the corrective actions to take for each symptom. Consulting this chart before having the terminal serviced may save a needless repair call.

Chapter 6 provides the information needed to have your GIGI terminal repaired by DIGITAL. If you find a problem in the terminal, follow the procedures outlined in this chapter to have the terminal repaired. The chapter also includes basic warranty information.

Chapter 7 provides a technical summary of the terminal programming information. This information serves as a summary only. If you need detailed information on any of the sequences, refer to the appropriate software document.

Chapter 8 provides technical hardware descriptions of the GIGI terminal's interface ports. It describes the signals, timing considerations, and characteristics for each interface connector. The chapter also discusses buffer synchronization, and how to prevent a terminal buffer overflow and the subsequent loss of data.

Chapter 9 provides lists the available accessories and supplies. It also lists the available GIGI system manuals and provides a brief overview of each manual. The chapter includes instructions for ordering any accessory, supply, or manual.



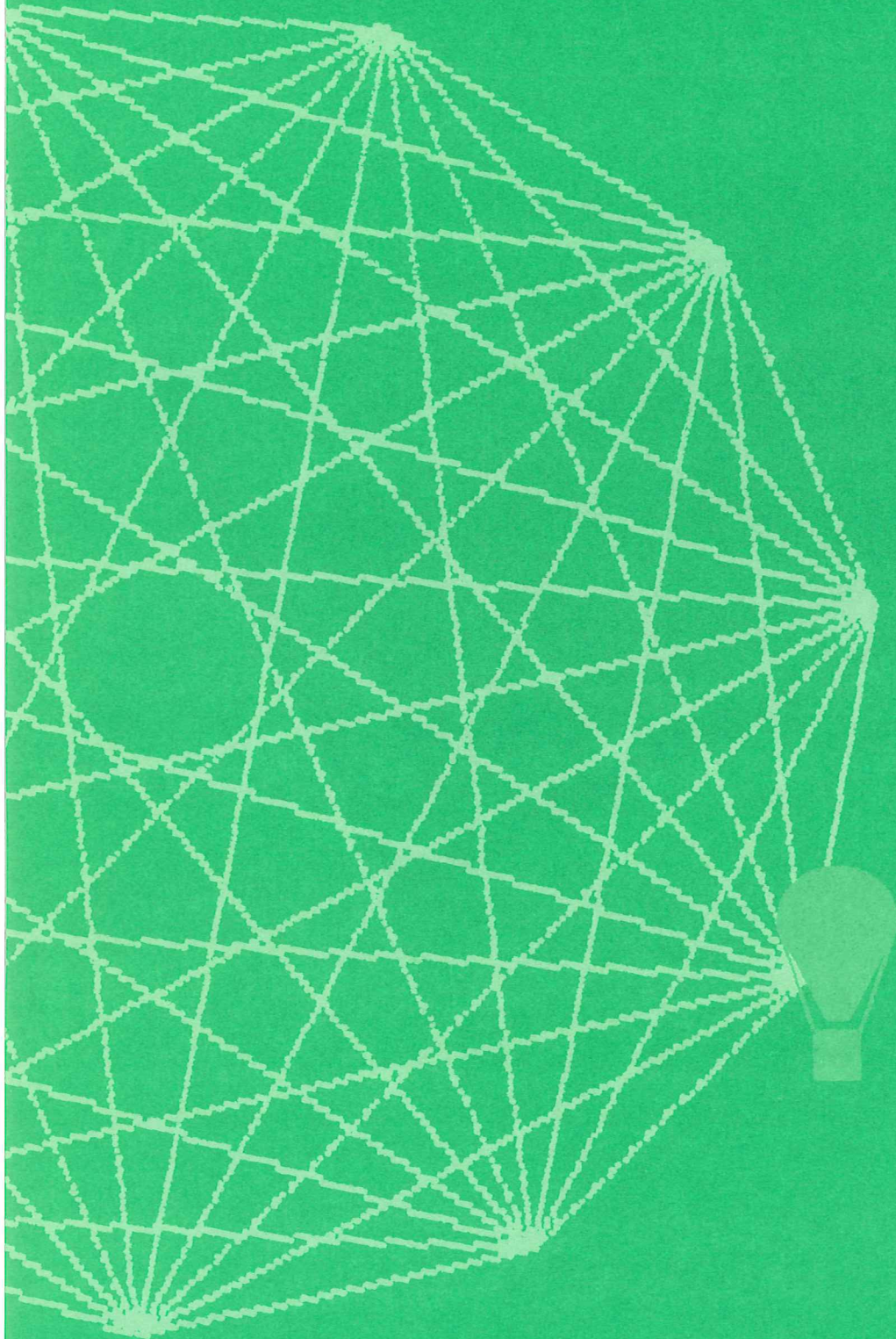



FIGURE 1-1 GIGI Terminal

# 1

## INTRODUCTION

The GIGI terminal (Figure 1-1) is an easy-to-operate computer terminal consisting of a typewriter-like keyboard enclosed in a lightweight plastic case. This terminal quickly and easily connects to optional color or black and white monitors, and the optional DIGITAL LA34VA graphics printer. In addition, the terminal connects to either a 20 mA current loop or EIA communications line to communicate with the host computer.

The GIGI terminal can operate as three different terminals: a *text terminal*, a *graphics terminal*, and a *BASIC terminal*. This chapter introduces you to the GIGI terminal and the basic ideas behind these three operating modes.

### GIGI AS A TEXT TERMINAL

The GIGI terminal's basic mode of operation is as a text terminal. In this mode the terminal acts as a translator between you (the operator) and the host computer. When you type a message or command on the keyboard, the terminal sends it immediately to the host computer in a language the computer understands. The host computer receives the message or command and executes it. Then the host computer sends an acknowledgement to the terminal, indicating the message or command was received and executed. The terminal receives the acknowledgement and displays it on the monitor screen in a language that you can understand. Figure 1-2 shows a simple diagram of the GIGI terminal operating in text mode.

When you first turn on or reset the GIGI terminal, it always enters text mode.

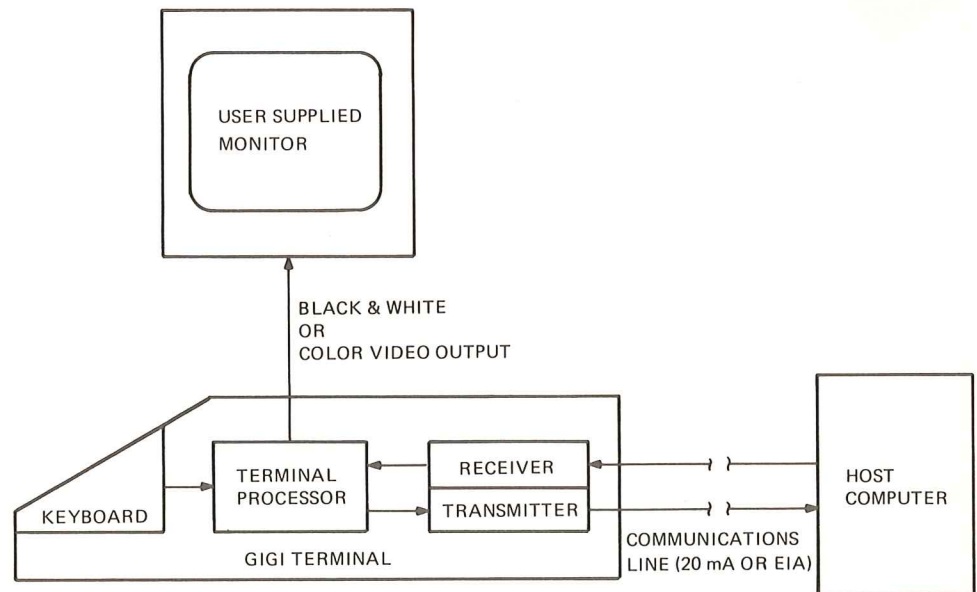

FIGURE 1-2 Text Mode Operation

MA-6768

**GIGI AS A GRAPHICS TERMINAL**

The GIGI terminal's primary mode of operation is as a graphics terminal. The name GIGI derives from this capability as a *General Imaging Generator and Interpreter*.

Generally the terminal is placed in graphics mode by the host computer. In this mode the terminal interprets all data received from the host computer or the terminal keyboard as graphics commands and data. The interpreter and image generator translates the commands and data into the images displayed on the monitor screen. Figure 1-3 shows a simple diagram of the GIGI terminal operating in graphics mode.

The commands to the interpreter come from a new graphics command set called *ReGIS (Remote Graphics Instruction Set)*. The ReGIS command set consists of a few simple instructions and options which allow you to quickly and easily draw an image on the monitor screen.

Within the graphics mode of operation is a mode called the *locator mode*. This mode helps you locate a point on the screen and report that point to the host computer. The GIGI terminal enters locator mode through the keyboard or a command from the host computer. When the terminal enters locator mode, a large cross-hair cursor appears on the screen. The point where the two lines cross is the point reported to the host computer.

You can return the terminal to the text mode of operation at any time. When the terminal is in text mode, it interprets all graphics data and commands as text only and not as graphics.

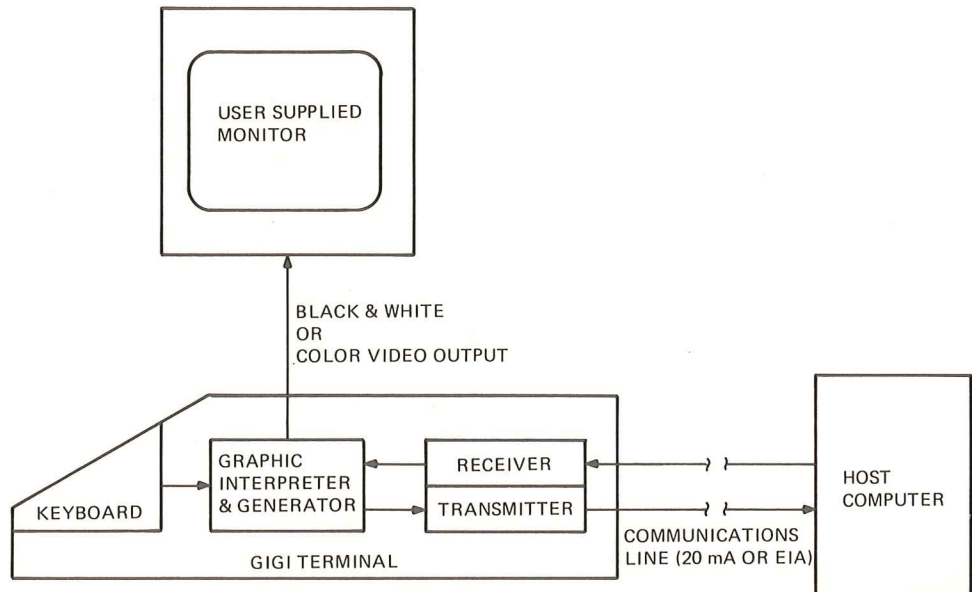

FIGURE 1-3 Graphics Mode Operation

**GIGI AS A BASIC TERMINAL**

The GIGI terminal contains a BASIC language interpreter in addition to its text and graphics capabilities. The GIGI BASIC interpreter allows the terminal to run BASIC language programs. The terminal enters BASIC mode through the SET-UP mode (described in Chapter 4) or a command from the host computer.

The BASIC program comes from one of two places, the keyboard or the host computer. You select the source of the program with a SET-UP parameter. If the keyboard is the program source, the operator types the BASIC program directly into the terminal memory. When the program runs, the output normally goes to the monitor screen. If the host computer is the program source, the program loads into the terminal memory from the host computer. When the program runs, the output normally returns to the host computer. Figure 1-4 shows a simple diagram of the GIGI terminal operating in both cases.

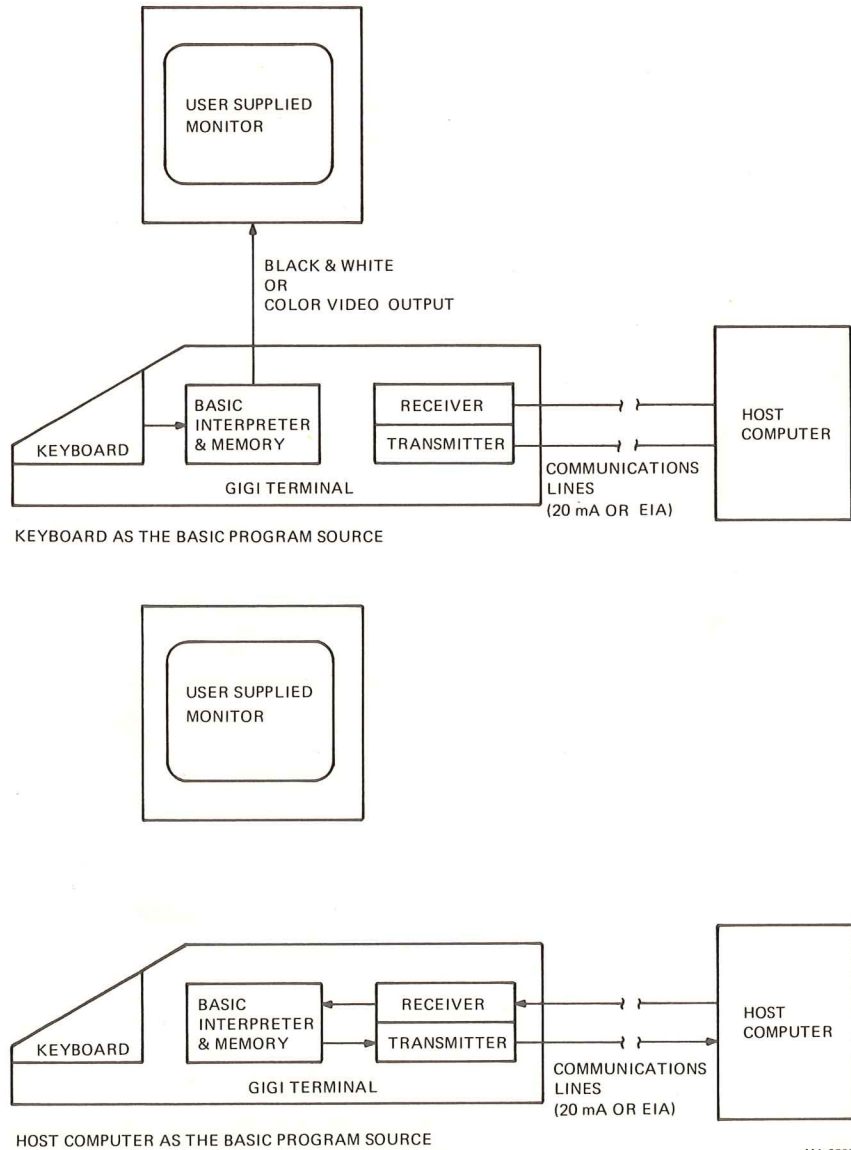
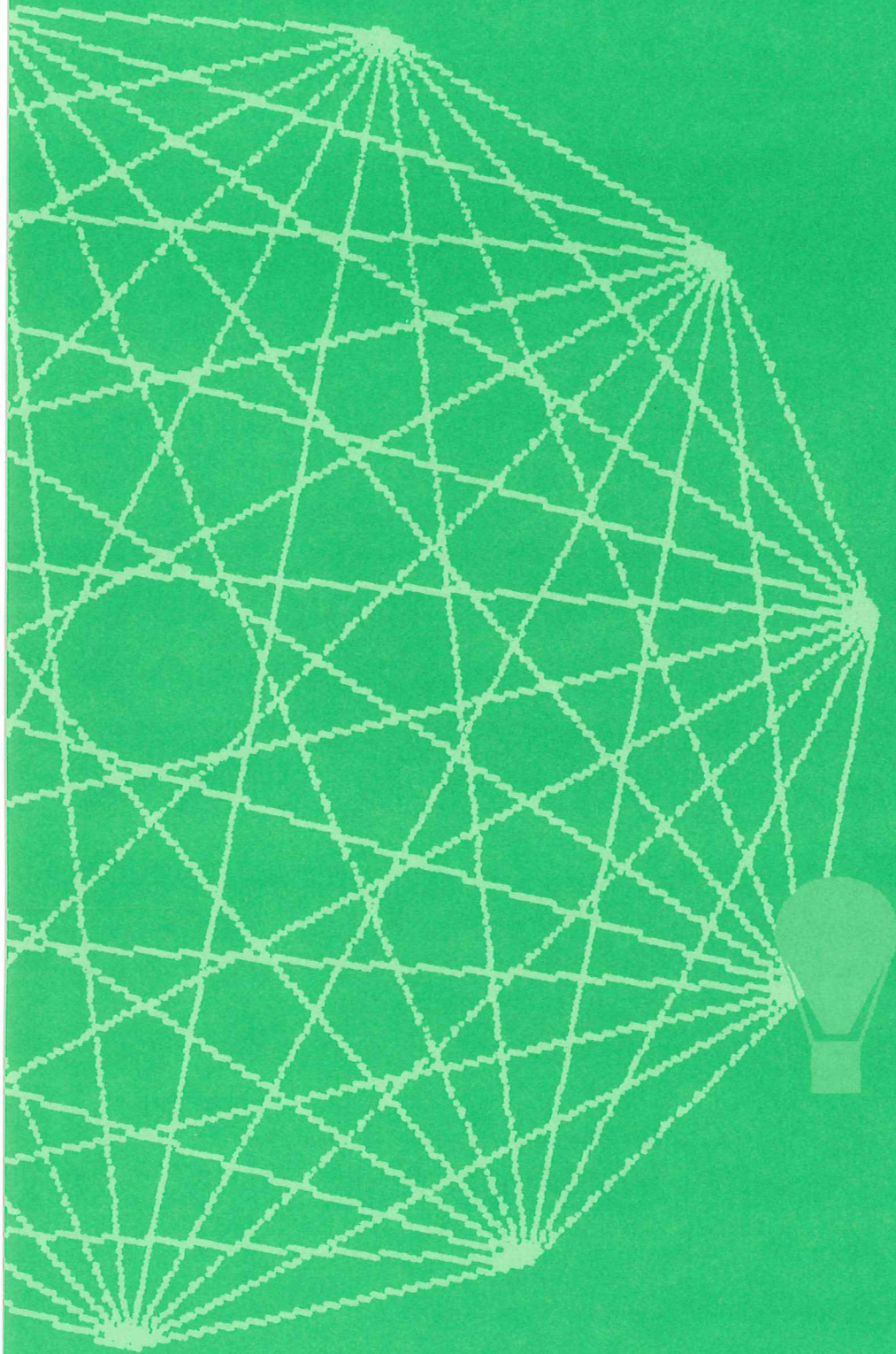

FIGURE 1-4 BASIC Mode Operation

## INTRODUCTION

When the terminal enters the BASIC mode, the BASIC indicator above the keyboard lights. You can return the terminal to text mode at any time, either through the keyboard or the SET-UP mode. When the terminal is in text mode, it interprets all data as text only and not as BASIC language commands.







# 2

## INSTALLATION

### SITE CONSIDERATIONS

The GIGI terminal is a lightweight, single-piece unit that fits on a desk or tabletop. Figure 2-1 shows the dimensions of the terminal.

The GIGI terminal usually connects to a user-supplied monitor (display) device. The monitor always operates with the terminal and should be located close to the terminal. Therefore, you must consider the monitor's size and weight when planning the terminal's location.

The GIGI terminal places few limits on the operating environment. Avoid areas that experience extremes in temperature and humidity or are subject to high levels of industrial contaminants. Appendix A describes the guaranteed operating conditions and terminal specifications.

A small air circulation fan in the GIGI terminal cools the terminal's electronic components. For the fan to work properly, all ventilation slots must be unobstructed. For this reason you should keep an area of about six inches around the terminal clear. Do not place papers or similar materials on top of or under the terminal.

The terminal controls and cable connections are on the rear of the terminal. When installing the terminal, allow an adequate area to access the rear of the terminal.

**Note:** When installing the terminal, keep all power and signal cables free from obstructions, sharp bends, and stress.

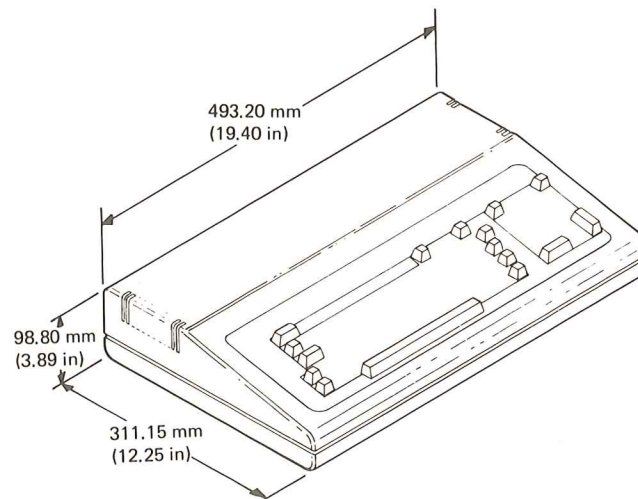

FIGURE 2-1 GIGI Terminal Dimensions

MA-6726

## UNPACKING AND INSPECTION

The GIGI terminal is packed in a reinforced shipping carton. The carton contains the following items.

- GIGI terminal
- GIGI terminal power cord
- GIGI terminal video cable
- GIGI Terminal Installation and Owner's Manual
- GIGI/ReGIS Handbook
- GIGI BASIC Manual
- GIGI Terminal SET-UP Reference Card
- GIGI Programming Reference Card
- GIGI Installation Card

Figure 2-2 shows the packaging used with the GIGI terminal. Use the following procedure to unpack the terminal from the shipping carton.

1. Carefully cut the shipping tape and open the shipping carton by pulling out the front flap and lifting the top.
2. Remove the power cord, video cable, and documentation from the packing material.

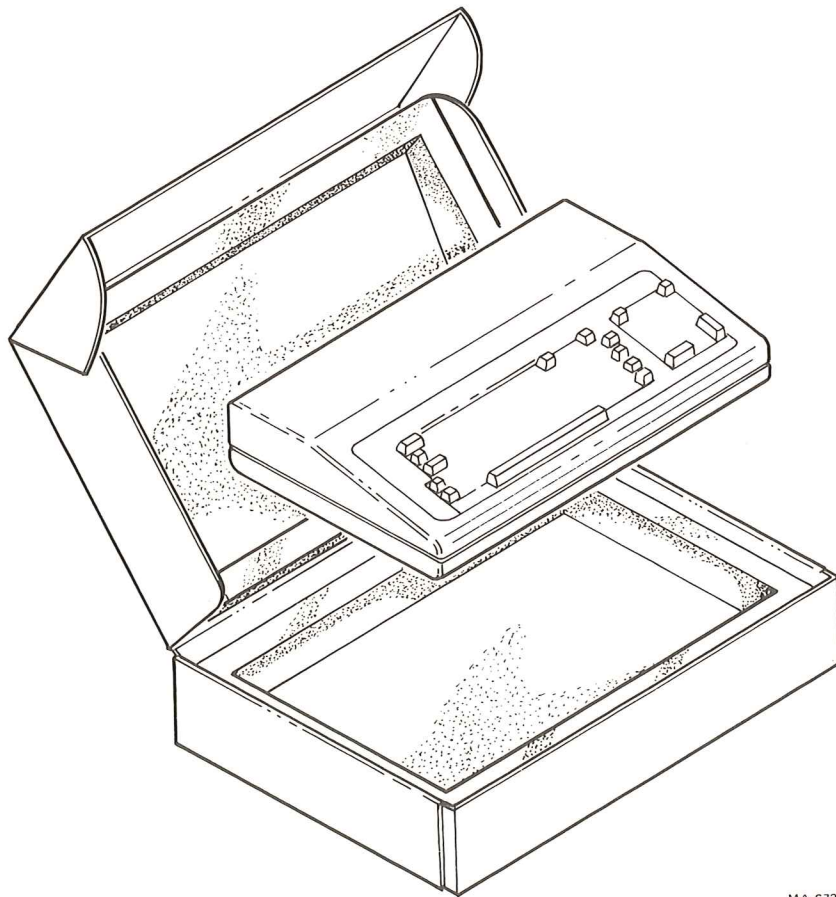

FIGURE 2-2 GIGI Terminal Shipping Container

## INSTALLATION

3. Lift out the top piece of packing material and remove the terminal from the shipping carton. Save the packing material and shipping carton. They are needed to ship the terminal back to the DIGITAL Servicenter if the terminal ever fails.
4. Visually inspect the terminal for physical damage. If the terminal is damaged, notify your local DIGITAL Sales Office.
5. Install the terminal as described in the Installation section of this chapter.

## REPACKING

Use the following procedure when repacking the GIGI terminal for shipment. Figure 2-3 shows all of the switch and cable locations.

1. Turn the ac power switch off.
2. Disconnect all cables from the rear of the terminal.
3. Locate the original packing material. If the original materials are not available, you can order them from DIGITAL. Chapter 9 provides the information needed to order the packing materials.
4. Repack the terminal in the shipping carton (Figure 2-2). Include the power cord and video cable in the shipping carton.
5. Seal the shipping carton with reinforced tape.

FIGURE 2-3 GIGI Terminal Switch and Cable Locations

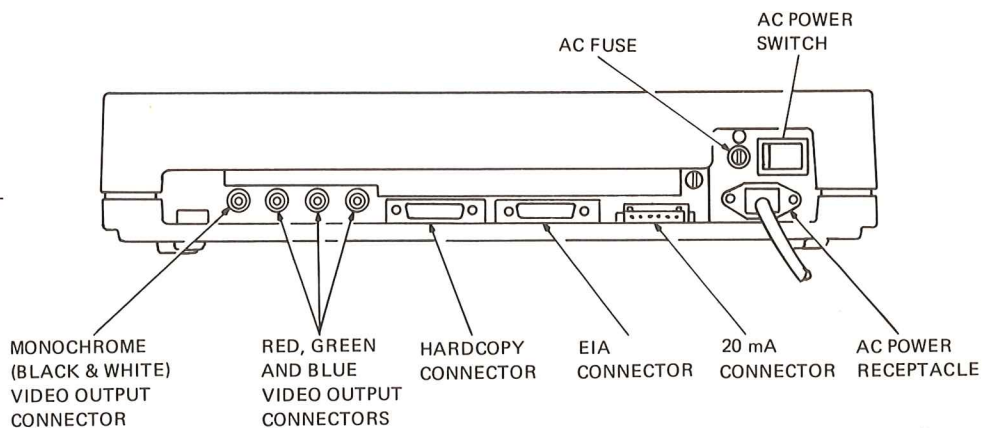

MA-6717

## INSTALLATION

The GIGI terminal is very easy to install. The only tool required is a flat blade type screwdriver. Use the following procedure to install the terminal.

1. Remove the terminal from the shipping carton or optional carrying case and place in the desired work area.
2. Locate the access opening on the rear of the terminal (Figure 2-4). The eight-position default SET-UP switch pack will be visible in the opening.

## INSTALLATION

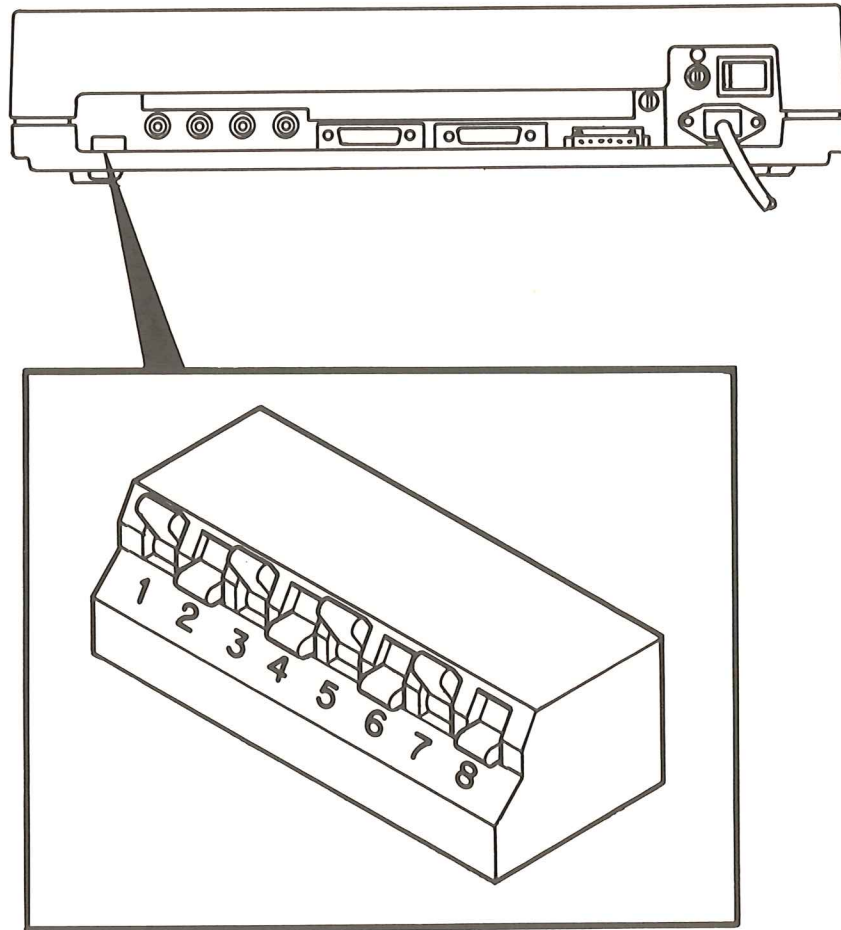

FIGURE 2-4 Default SET-UP  
Switch Pack Location

MA-6718

3. Note the switch positions and determine if the switch settings are correct for your host computer system. Figure 2-5 shows all the switch settings and what they mean to the host computer. Chapter 4 provides more detailed information on the SET-UP parameters.
4. If the default SET-UP switch pack settings are incorrect for your host computer, carefully change the switch settings with a pencil or a similar object. Once you set the switches, verify the new settings. If the settings are wrong, the terminal may not be able to communicate with the host computer.
5. Remove the user-supplied monitor from its shipping carton and place in the desired work area. Perform the installation instructions packed with the monitor.
6. Connect the GIGI terminal to the user-supplied monitor. (The next section of this chapter provides specific instructions for connecting to the Barco Model GD33 monitor.)
7. Connect the communications cable to the appropriate communications connector. If you select EIA communications, connect the ground wire to the terminal communications connector. Figure 2-6 shows the cable connector with the ground wire connected.
8. Connect the GIGI terminal to the optional LA34VA graphics printer. There are two methods for this. The Connecting to the LA34VA Graphics Printer section of this chapter provides detailed instructions.

## INSTALLATION

FIGURE 2-5 Default SET-UP  
Switch Pack Setting (Sheet 1 of 3)

### SET-UP FEATURE DEFAULT SETTINGS FOR POWER FREQUENCY (PF) (SWITCH 1)

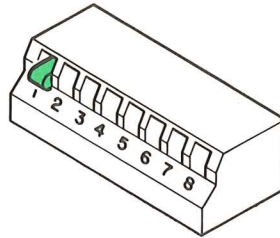

POWER FREQUENCY FEATURE  
DEFAULT SET FOR 60 Hz  
(PF0)

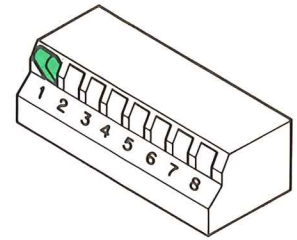

POWER FREQUENCY FEATURE  
DEFAULT SET FOR 50 Hz  
(PF1)

---

### SET-UP FEATURE DEFAULT SETTINGS FOR COMMUNICATIONS INTERFACE (CI) (SWITCH 2)

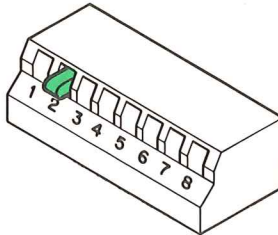

COMMUNICATIONS INTERFACE  
FEATURE DEFAULT SET FOR  
EIA (CI0)

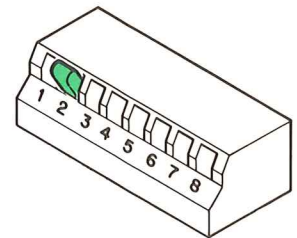

COMMUNICATIONS INTERFACE  
FEATURE DEFAULT SET FOR  
20mA (CI1)

---

### SET-UP FEATURE DEFAULT SETTINGS FOR UK CHARACTER SET (UK) (SWITCH 3)

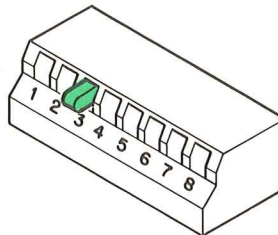

UK CHARACTER SET FEATURE  
DEFAULT SET FOR US (UK0)

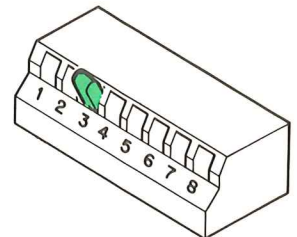

UK CHARACTER SET FEATURE  
DEFAULT SET FOR UK (UK1)

MA-6720

## INSTALLATION

FIGURE 2-5 Default SET-UP  
Switch Pack Setting (Sheet 2 of 3)

SET-UP FEATURE DEFAULT SETTINGS FOR PARITY ENABLE (PE)  
(SWITCHES 4 & 5)

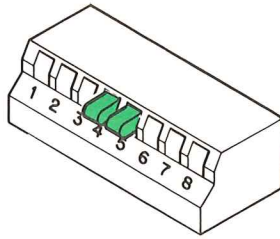

PARITY ENABLE FEATURE  
DEFAULT SET FOR OFF (PE0)

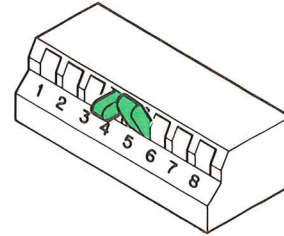

PARITY ENABLE FEATURE  
DEFAULT SET FOR EVEN (PE1)

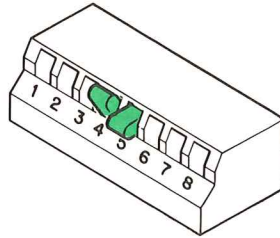

PARITY ENABLE FEATURE  
DEFAULT SET FOR ODD (PE2)

---

SET-UP FEATURE DEFAULT SETTINGS FOR BOTH TRANSMIT AND RECEIVE  
SPEEDS (TS AND RS)  
(SWITCHES 6, 7, & 8)

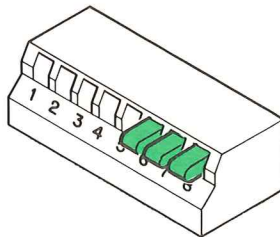

TRANSMIT AND RECEIVE SPEED  
FEATURES DEFAULT SET FOR  
110 (RS0 AND TS0)

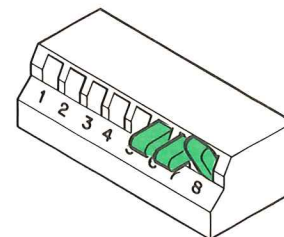

TRANSMIT AND RECEIVE SPEED  
FEATURES DEFAULT SET FOR  
300 (RS1 AND TS1)

MA-6721



INSTALLATION

FIGURE 2-5 Default SET-UP  
Switch Pack Setting (Sheet 3 of 3)

SET-UP FEATURE DEFAULT SETTINGS FOR BOTH TRANSMIT AND RECEIVE SPEEDS (TS AND RS) CONT. (SWITCHES 6, 7, & 8)

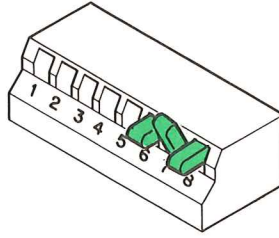

TRANSMIT AND RECEIVE SPEED FEATURES DEFAULT SET FOR 600 (RS2 AND TS2)

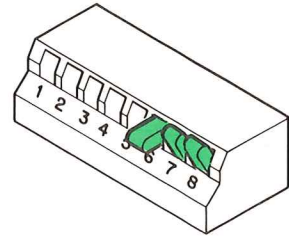

TRANSMIT AND RECEIVE SPEED FEATURES DEFAULT SET FOR 1200 (RS3 AND TS3)

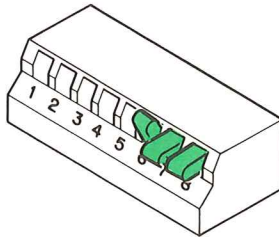

TRANSMIT AND RECEIVE SPEED FEATURES DEFAULT SET FOR 2400 (RS4 AND TS4)

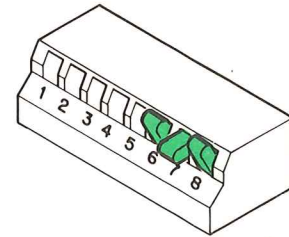

TRANSMIT AND RECEIVE SPEED FEATURES DEFAULT SET FOR 4800 (RS5 AND TS5)

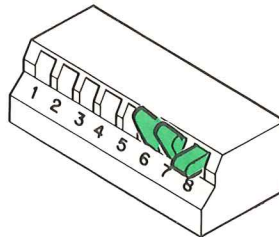

TRANSMIT AND RECEIVE SPEED FEATURES DEFAULT SET FOR 9600 (RS6 AND TS6)

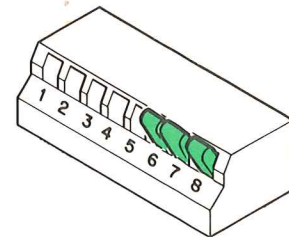

TRANSMIT AND RECEIVE SPEED FEATURES DEFAULT SET FOR 19,200 (RS7 AND TS7)

MA-6722

FIGURE 2-6 EIA  
Communications Cable Connector

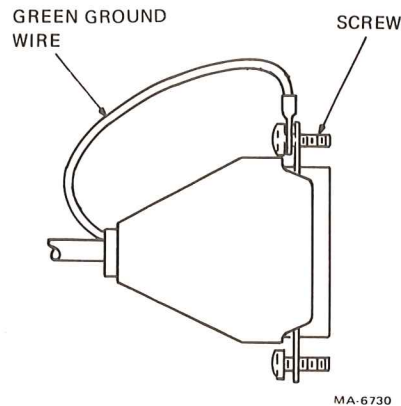

9. Connect the power cord to the power cord receptacle on the rear of the terminal. Plug the other end of the power cord into a nearby wall outlet.
10. Turn the monitor power switch on. Allow the monitor one or two minutes to warm up before you perform the next step.
11. Turn the terminal power switch on. The terminal will automatically perform the power-up self-test. Once the power-up self test is successfully completed, the ON LINE indicator above the keyboard lights and the cursor appears in the upper left corner of the monitor screen. If any other indications are present, the terminal self-test may have found a fault in the terminal. Chapter 5 outlines the procedures to follow if this occurs.

**Note:** On some monitors you may not see the cursor immediately because of a monitor condition called overscan. To eliminate the monitor overscan, set the HP, HM or VM SET-UP parameters. Chapter 4 describes these parameters.

12. Select the terminal SET-UP parameters. Chapter 4 describes the SET-UP parameters and how to select them.
13. Once you select the SET-UP parameters, record their settings and keep them with the terminal for future reference.
14. Fill out the GIGI Installation Card and return it to DIGITAL. Postage on the card is prepaid if mailed within the US.

### CONNECTING TO THE BARCO MODEL GD33 MONITOR

This section provides specific instructions for connecting the GIGI terminal to the Barco Model GD33 monitor. This monitor is *not* supplied by DIGITAL. The monitor must be purchased separately from your local Barco distributor. Monitor operating instructions are packaged with the monitor.

1. Locate the GIGI video cable. It is a single cable with three connectors on each end.
2. Connect the color-keyed red, green, and blue cable connectors to the RED, GREEN, and BLUE output connectors on the rear of the GIGI terminal.

INSTALLATION

3. Connect the color-keyed red, green, and blue cable connectors to the RED, GREEN, and BLUE input connectors on the rear of the Barco Model GD33 monitor (Figure 2-7).
4. Locate the white switches on the rear of the monitor above the input connectors. Slide the white switches to the 75 position. This switches in a 75-ohm cable impedance and provides the best possible monitor display.
5. Locate the G/X switch on the rear of the monitor. Slide the G/X switch to the G position. This sets the monitor synchronization for green signal sync.
6. Connect the monitor power cord.

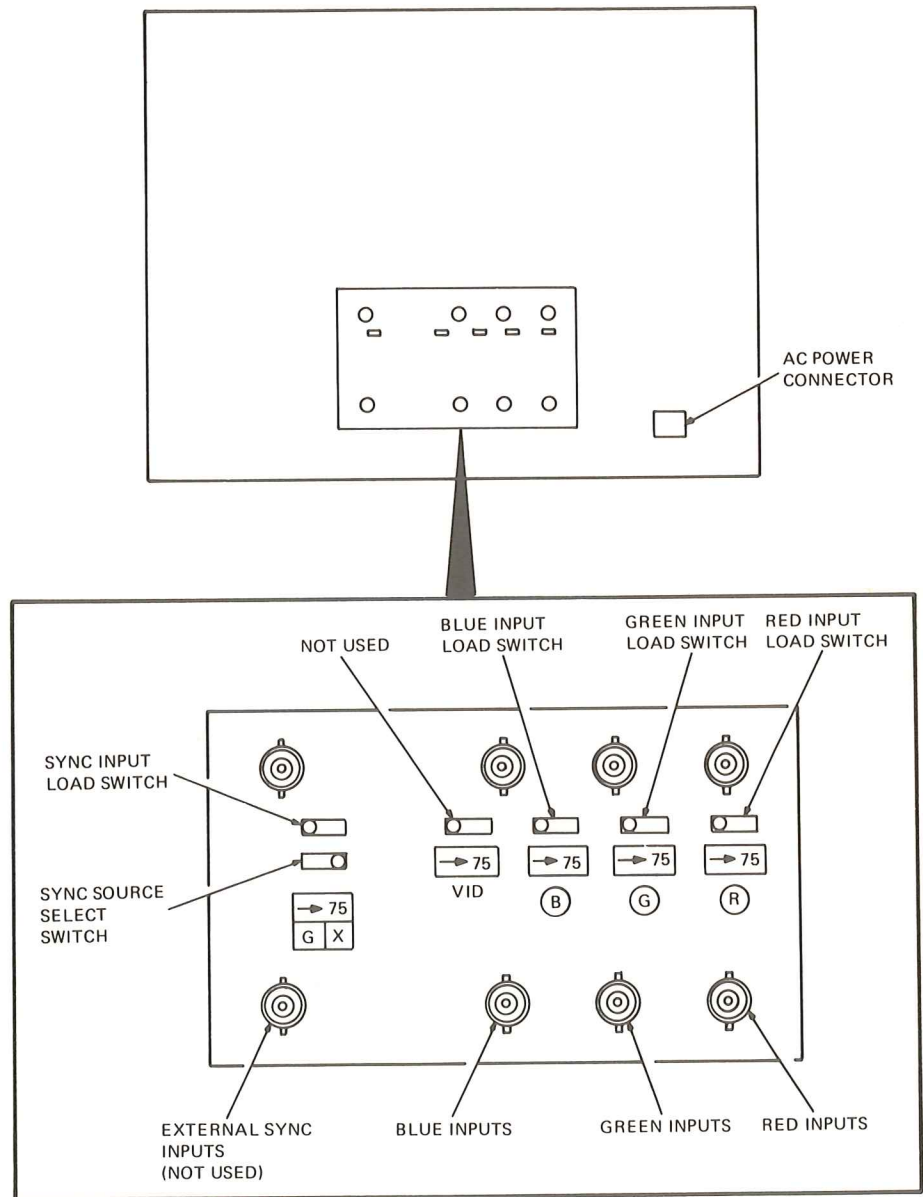

FIGURE 2-7 Barco Model GD33 Monitor Connections

MA6770

## CONNECTING TO A TYPICAL BLACK AND WHITE MONITOR

---

The GIGI terminal can connect to a black and white (monochrome) monitor. DIGITAL does not supply a black and white monitor. Any black and white monitor must be obtained from local suppliers.

Use the following general instructions to perform the interconnection. Specific operating instructions for the monitor are packaged with the monitor.

1. Locate the GIGI video cable. It is a single cable with three connectors on each end.
2. Connect one of the three cable connectors to the MONO output connector on the rear of the GIGI terminal. Note the cable connector color key (red, green, or blue).
3. Locate the video input connector on the black and white monitor. This connector should be a BNC-type connector. If not, put a BNC adaptor on the connector.
4. Connect the video cable to the video input connector on the monitor. Be sure to use the same color-keyed cable connector that you used on the terminal end of the cable.

## CONNECTING TO THE LA34VA GRAPHICS PRINTER

---

You can connect the GIGI terminal to the LA34VA graphics printer in one of two ways.

1. Connect the terminal directly to the printer.
2. Add the terminal to the end of a multiterminal string.

When you connect the terminal directly to the printer, the printer is dedicated to that terminal. This means the printer is always available to the terminal.

In a multiterminal string, two or more GIGI terminals connect to one printer. Each terminal contains a hardcopy protocol. This protocol prevents problems when more than one terminal tries to use the printer. When you request to use the printer by pressing the **SHIFT** and **PFI/HARDCOPY** keys together the terminal looks to see if the printer is busy. If the printer is not busy the terminal immediately sends its data to the printer.

If the printer is currently printing the terminal generates a print request and waits until the printer is available. The print request tells all other GIGI terminals that a terminal is waiting to use the printer. When the printer completes the copy the waiting terminal then sends its data to the printer.

When more than one terminal is waiting to use the printer an internal sequence system takes effect. The sequence system determines which terminal uses the printer next. The sequence system continues in effect until all of the waiting terminals have used the printer.

When you use a multiterminal string, all terminals in the string must be powered on. If any terminal in the string is turned off, that terminal and all terminals after it in the string cannot use the printer. Figure 2-8 shows this point. Terminal 3 is turned off, so terminal 4 cannot use the printer. Any terminal that is turned off in a multiterminal string should be disconnected from the string. A later section of this chapter provides a disconnection procedure.

## INSTALLATION

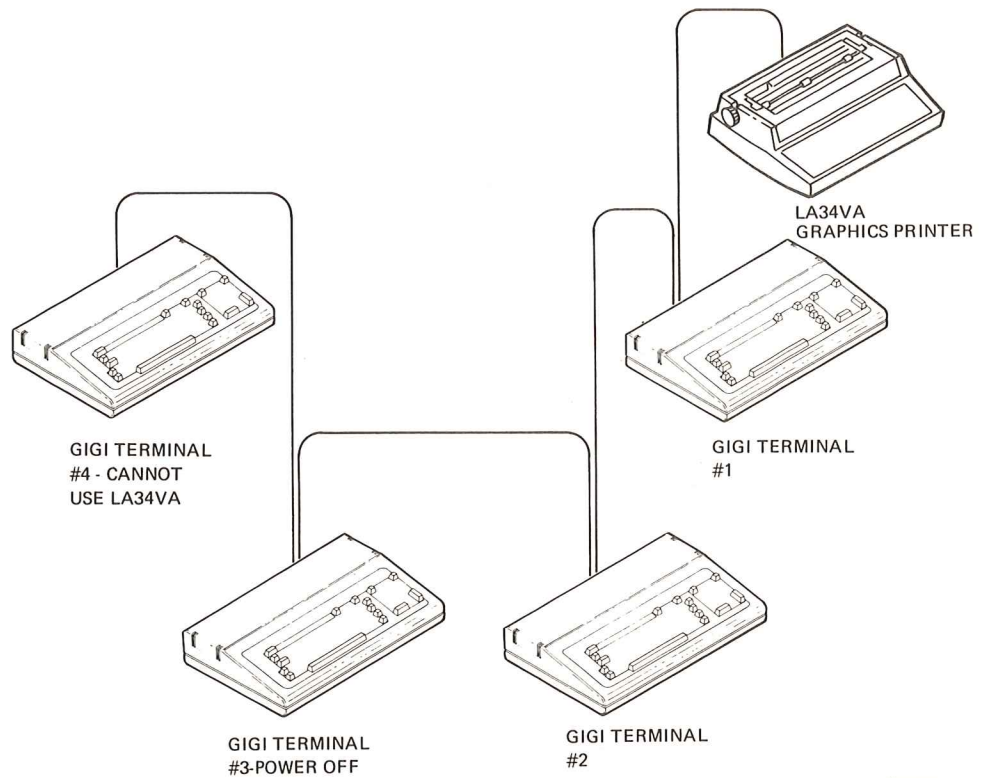

FIGURE 2-8 Multiterminal String with Terminal Turned Off

MA-6725

The following paragraphs provide the two procedures for connecting the GIGI terminal to the LA34VA graphics printer.

### Connecting Directly to the LA34VA Graphics Printer

Use this procedure if you have only one GIGI terminal to connect to the LA34VA graphics printer. Maximum cable length is 50 feet. Figure 2-9 shows a simple block diagram of this configuration.

FIGURE 2-9 Single GIGI Terminal to LA34VA Graphics Printer Connection

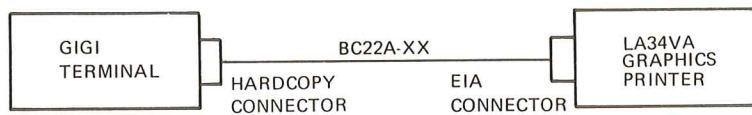

MA-6719

To perform the procedure you need a flat blade type screwdriver, a BC22A-xx interface cable, and one 8-32  $\times$  5/8 inch screw.

1. Locate and connect the BC22A cable to the HARDCOPY connector on the rear of the GIGI terminal. The connector is keyed by its shape and can only plug in one way. Connect the ground wire to the HARDCOPY connector. Figure 2-6 shows the cable connector with the ground wire connected.
2. Plug the other cable connector into the the EIA connector on the rear of the LA34VA graphics printer. This connector is keyed by its shape and can only plug in one way (Figure 2-10).

FIGURE 2-10 LA34VA Graphics Printer (Rear View)

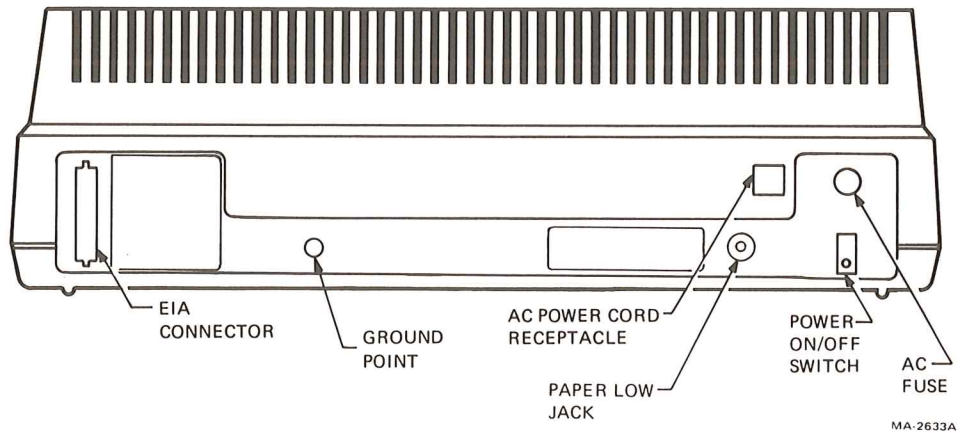

3. Push the 8-32 × 5/8 inch screw through the ring terminal on the end of the ground wire coming out of the cable connector. Locate the grounding screw hole on the LA34VA graphics printer, about 3 inches to the right of the EIA connector. Attach the cable ground wire to the LA34VA graphics printer grounding point.
4. Perform the installation and SET-UP procedures outlined in the *DECwriter IV Graphics Printer User Guide* (EK-L34RO-UG). Select the following LA34VA data communication features.
 

Baud rate	9600
Parity	Space
XON/XOFF	On
No modem	—

The data communication switches are described in the Communications chapter of the *DECwriter IV Graphics Printer User Guide*.
5. Apply power to both terminals.
6. To verify the LA34VA graphics printer connection, place the screen alignment video pattern on the monitor screen. Do this by pressing the following keys in order: **SET-UP**, **S**, **T**, **4**, and **SET-UP** again.
7. Print the screen alignment video pattern on the LA34VA graphics printer. Do this by pressing the **SHIFT** and **PF1/HARDCOPY** keys together.

### Adding a Terminal to a Multiterminal String

Use this procedure if one or more GIGI terminals are connected to the LA34VA graphics printer. Figure 2-11 shows a simple diagram of this configuration.

## INSTALLATION

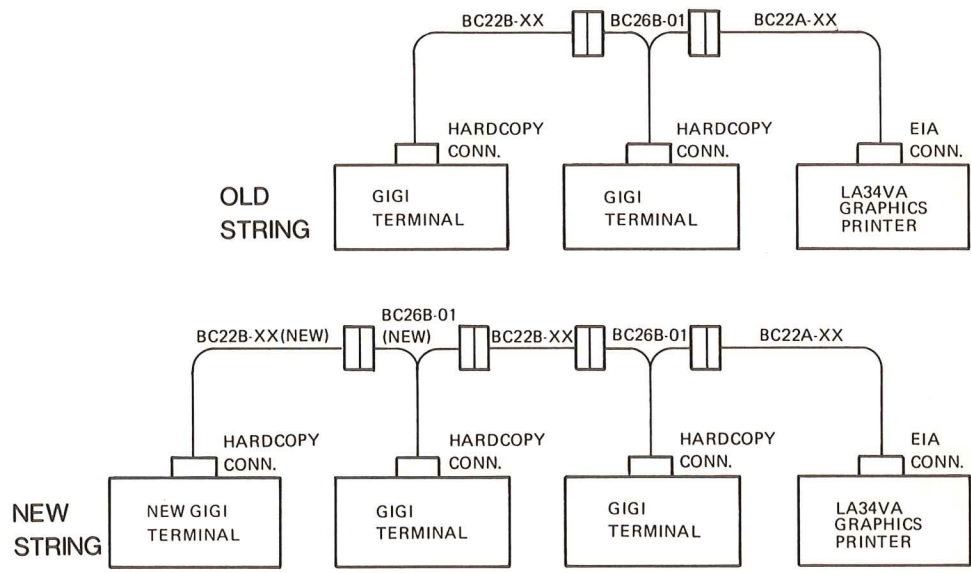

FIGURE 2-11 Adding a Terminal to a Multiterminal String

MA-6729

To perform the procedure you need a flat blade type screwdriver, a BC22B-xx interface cable, and a BC26B-01 Y-type cable.

1. Locate the last GIGI terminal in the string attached to the LA34VA graphic printer. Disconnect the cable connected to the HARDCOPY connector on the rear of this terminal.
2. Locate and connect the BC26B-01 Y-type cable to the HARDCOPY connector on the last GIGI terminal. The connector is keyed by its shape and can only plug in one way. Connect the ground wire to the HARDCOPY connector. Figure 2-6 shows the cable connector with the ground wire connected.
3. Connect the cable you disconnected from the terminal in step 2 to the female connector of the BC26B-01 Y type cable.
4. Locate the new BC22B cable. Plug one BC22B cable connector into the male BC26B-01 cable connector. The connector is keyed by its shape and can only plug in one way. Connect the ground wire between the two connectors. Figure 2-6 shows the cable with the ground wire connected.
5. Plug the other BC22B cable connector into the HARDCOPY connector on the GIGI terminal being added to the string. The connector is keyed by its shape and can only plug in one way. Connect the ground wire to the HARDCOPY connector. Figure 2-6 shows the cable connector with the ground wire connected.
6. Apply power to both terminals.
7. To verify the LA34VA graphics printer connection, place the screen alignment video pattern on the monitor screen. Do this by pressing the following keys in order: **SET-UP**, **S**, **T**, **4**, and **SET-UP** again.
8. Print the screen alignment video pattern on the LA34VA graphics printer. Do this by pressing the **SHIFT** and **PF1/HARDCOPY** keys together.

### Removing a Terminal from a Multiterminal String

Use this procedure if two or more GIGI terminals are connected to the LA34VA graphics printer. Figure 2-12 shows a simple diagram of the procedure.

1. Locate the GIGI terminal you want to disconnect.
2. Locate the BC26B-01 Y-type cable connected to the HARDCOPY connector on the rear of this terminal. Disconnect the two cables connected to the BC26B-01 Y-type cable.
3. Connect the two cables that you just removed from the BC26B-01 Y-type cable. Be sure to connect the cable ground wires between the two connectors. Figure 2-6 shows the cable connectors with the ground wire connected.

The terminal is now disconnected from the multiterminal string.

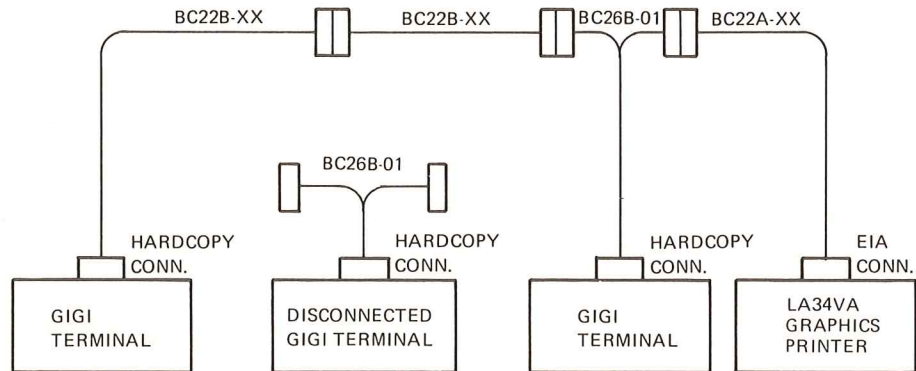
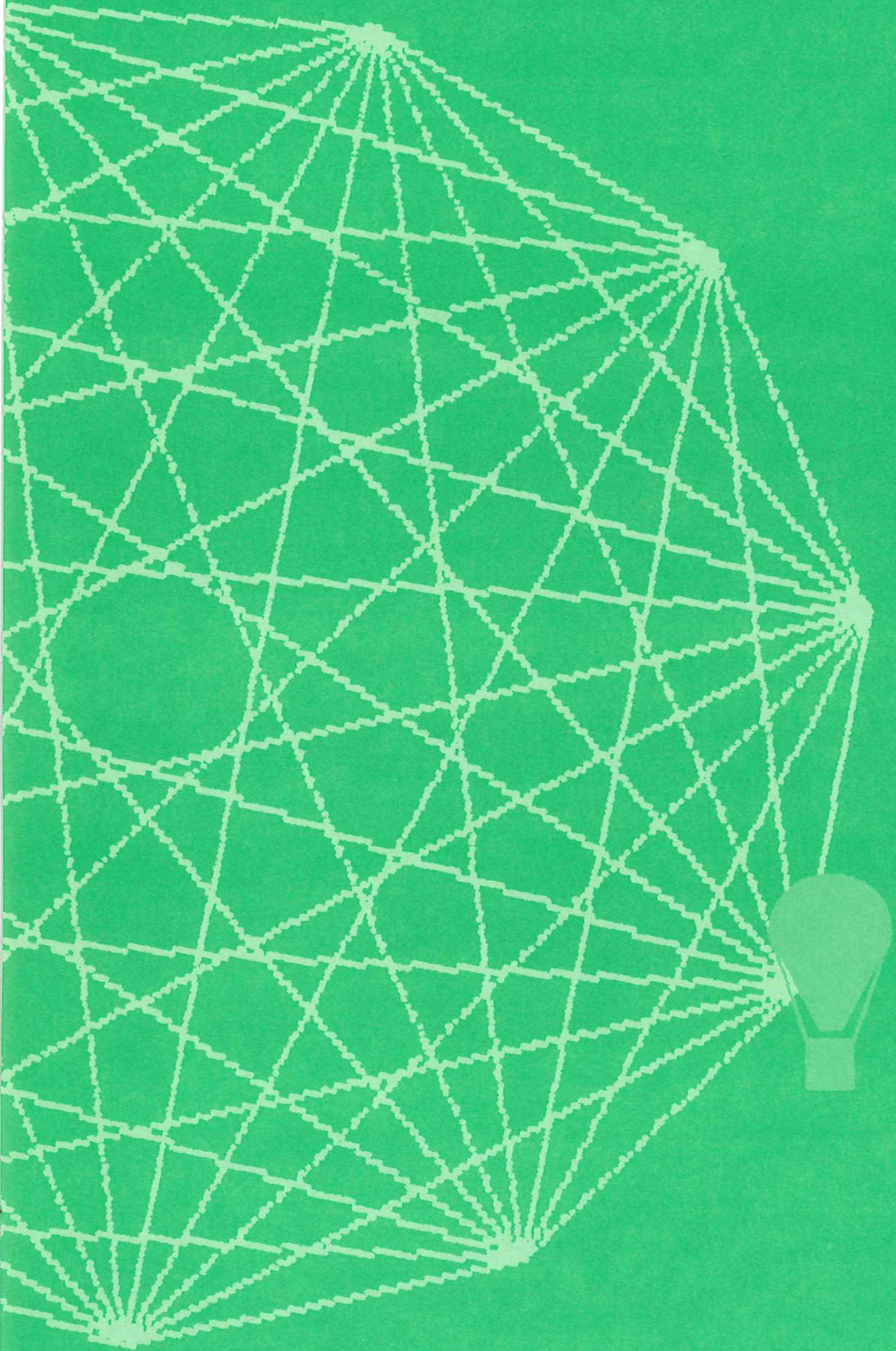

FIGURE 2-12 Removing a Terminal from a Multiterminal String

MA-6716



**General  
Operating Information**



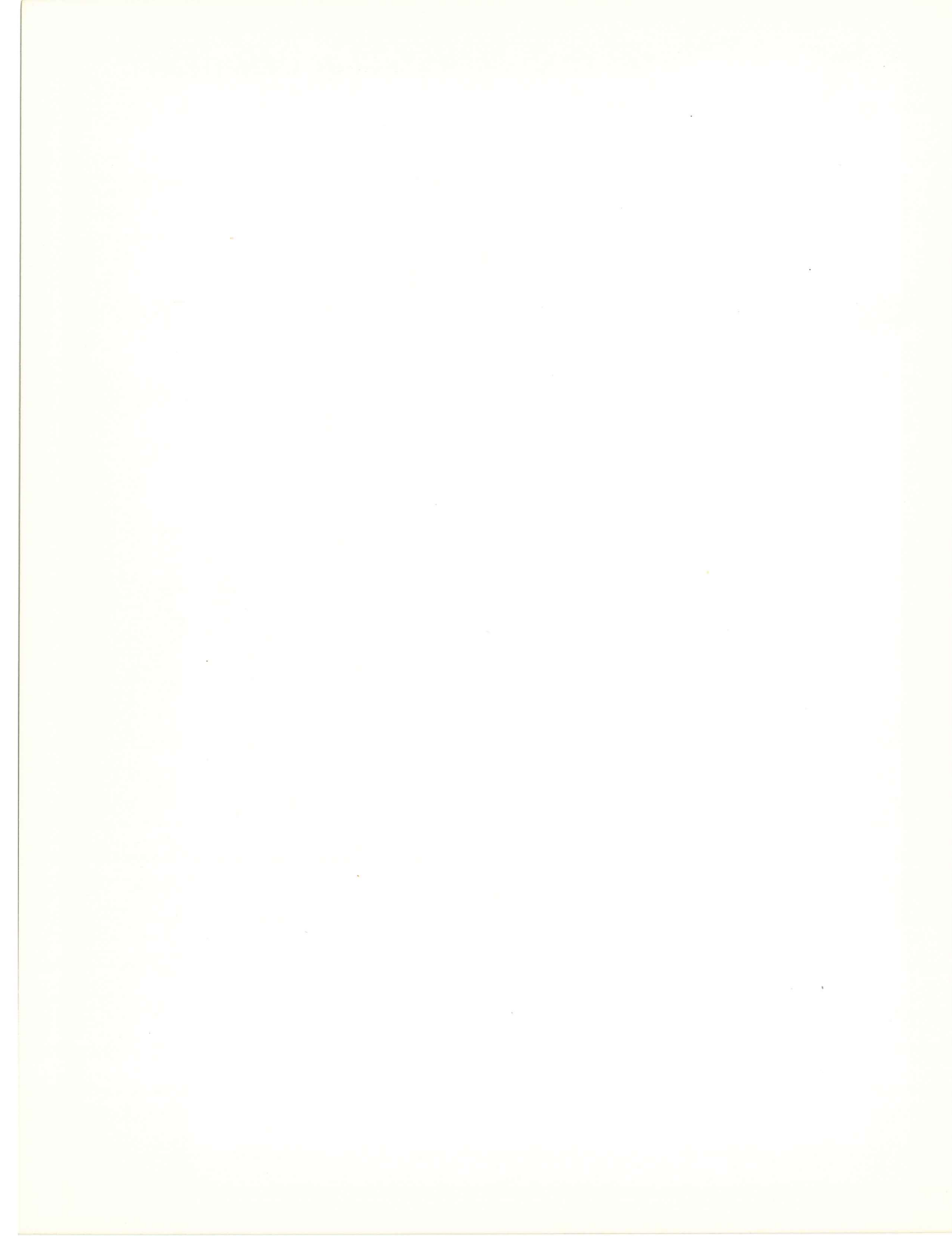

# 3

## GENERAL OPERATING INFORMATION

### INTRODUCTION

The GIGI terminal has a wide variety of controls and indicators. The operator uses these controls and indicators to monitor and direct the terminal's operation. The controls and indicators are grouped as follows.

- Terminal controls
- Keyboard controls
- Visual indicators
- Audible indicators

### TERMINAL CONTROLS

The GIGI terminal contains only one control, the power switch (Figure 3-1). The power switch turns power to the terminal on and off.

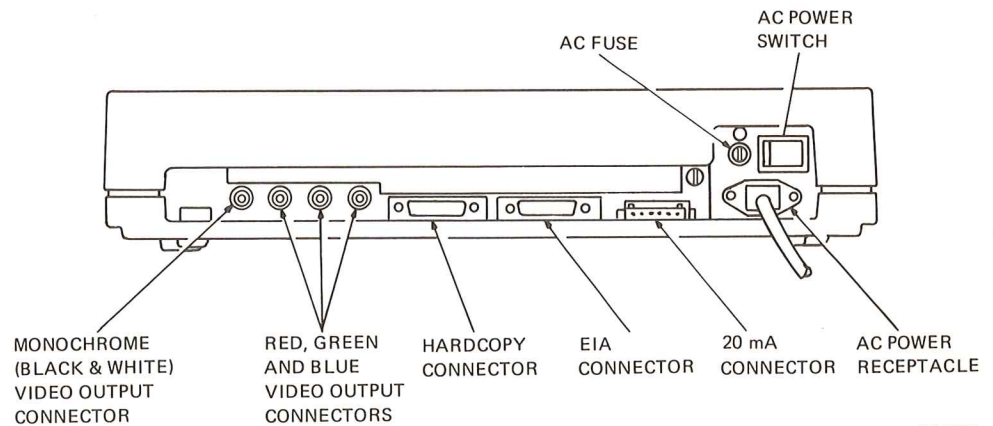

FIGURE 3-1 Terminal Controls

MA-6717

### KEYBOARD CONTROLS

The GIGI terminal has two keypads. The main keypad has a key arrangement and sculpturing styled like a standard office typewriter. The auxiliary or numeric keypad allows you to enter numeric data in a calculator-like fashion.

The GIGI terminal keyboard controls are grouped by functionality as follows.

- Standard keys
- Special function keys
- SET-UP mode keys
- Special mode keys



FIGURE 3-2 Standard Keys

### Standard Keys

Figure 3-2 identifies the GIGI terminal keyboard keys that usually operate like standard typewriter and calculator keys. These keys generate ASCII codes which the terminal transmits to the host computer. The minus, comma, period, and numeric keys of the auxiliary keypad normally generate the same codes as the corresponding unshifted keys of the main keypad. The **SHIFT** key on the main keypad does not affect the codes generated by the keys on the auxiliary keypad.

The auxiliary keypad has two alternate modes of operation: keypad application mode and programmed keypad mode. The terminal can enter either mode through the SET-UP parameters or a command from the host computer. In both modes the auxiliary keypad generates special but different sequences that have a special meaning to the host computer. Chapter 4 provides more information about the two modes, and Chapter 7 provides information concerning the specific codes generated by the keys.

#### CAPS LOCK

This key enables the uppercase function of alphabetic keys only. All numeric and special symbol keys remain in lowercase.

#### SHIFT

This key enables the uppercase function of all keys. If a key does not have an uppercase function, the **SHIFT** key has no effect.

### Special Function Keys

Figure 3-3 identifies the special function keys on the GIGI terminal keyboard. The special function keys transmit codes to the host computer which may have a special meaning to the application program. Consult your local operating procedures for the specific function performed by these keys. The following paragraphs provide a general description.

## GENERAL OPERATING INFORMATION

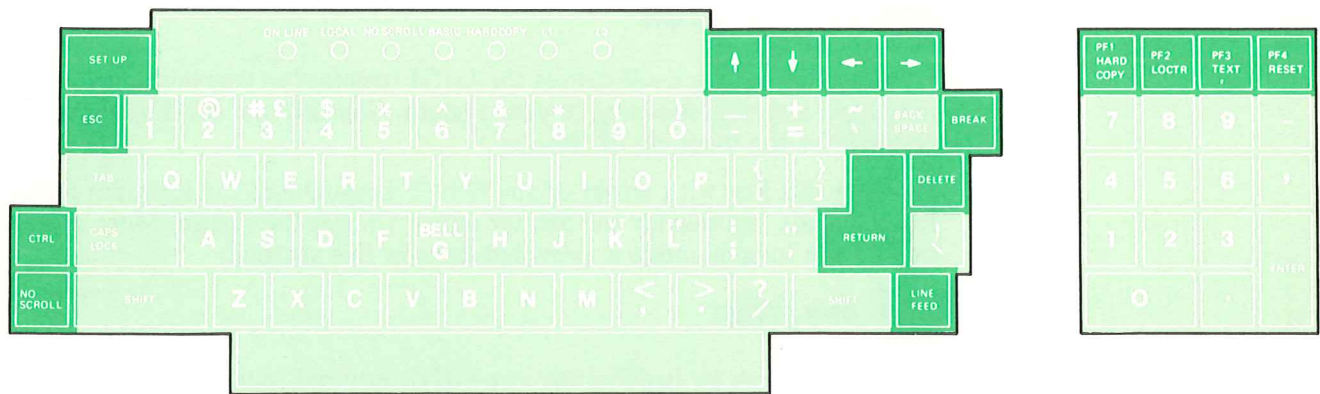

MA 6727

FIGURE 3-3 Special Function Keys

### **SET-UP**

Pressing this key causes the GIGI terminal to enter SET-UP mode. In SET-UP mode you can change the terminal parameters such as scrolling.

### **ARROWS**

Each of these keys causes the GIGI terminal to transmit a code to the host computer. Usually the terminal interprets these keys as commands to move the cursor in the direction of the arrow. Consult your local operating procedures for the exact function of these keys in your system.

### **BREAK**

This key transmits a break signal. Pressing **BREAK** with either of the **SHIFT** keys transmits the long break signal.

### **PF1/HARDCOPY**

Pressing this key by itself causes the GIGI terminal to transmit a code which may have a special meaning to your system. Consult your local operating procedures for the meaning of this key.

Pressing this key with either of the **SHIFT** keys causes the optional printer to copy the current contents of the monitor screen. During the copying process the screen is frozen. Once the printer finishes the copy, the screen resumes normal operation. If a printer is not connected to the terminal, pressing this key freezes the screen for a short time just as if a printer was copying the screen.

Pressing the **SHIFT** and **PF1/HARDCOPY** keys a second time stops the printing of the screen contents. When this occurs the terminal returns to the previous operating mode.

PF2  
LOCTR**PF2/LOCATOR**

Pressing this key by itself causes the GIGI terminal to transmit a code which may have a special meaning to your system. Consult your local operating procedures for the meaning of this key.

Pressing this key with either of the **SHIFT** keys causes the terminal to enter locator mode and display the locator cursor (+) on the screen. More information on the locator mode is provided later in this section.

PF3  
TEXT**PF3/TEXT**

Pressing this key by itself causes the GIGI terminal to transmit a code which may have a special meaning to your system. Consult your local operating procedures for the meaning of this key.

Pressing this key with either of the **SHIFT** keys causes the terminal to enter text mode and disable graphics mode. When it enters text mode, the terminal cancels any special graphics display parameters that were selected. If the terminal was already in text mode, pressing this key resets any special text features.

PF4  
RESET**PF4/RESET**

Pressing this key by itself causes the GIGI terminal to transmit a code which may have a special meaning to your system. Consult your local operating procedures for the meaning of this key.

Pressing this key with either of the **SHIFT** keys resets the terminal. This action is almost the same as turning the power switch off and on. All of the contents of memory are lost except the SET-UP parameter settings, soft character sets, BASIC program, graphics mode macrographs, and any special key definitions. This reset function does *not* change the SET-UP parameter settings.

DELETE

**DELETE**

This key causes the GIGI terminal to transmit a delete character code to the host system. The deleted character may or may not be erased from the screen.

RETURN

**RETURN**

This key transmits either a carriage return (CR) code or a carriage return (CR) and line feed (LF) code. You select the desired function through a SET-UP parameter.

LINE  
FEED**LINE FEED**

This key transmits a line feed (LF) code.

NO  
SCROLL**NO SCROLL**

This key is controlled by the XO SET-UP parameter. If the XO parameter is on, pressing this the first time key stops data transmission from the host computer to the GIGI terminal. This also lights the NO SCROLL indicator

above the keyboard, to show that the terminal is not sending or receiving data. Pressing the key a second time resumes transmission from where it stopped. This also turns off the NO SCROLL indicator. If the XO parameter is off, this key is inactive and has no effect on the terminal.

**CTRL CONTROL**

Pressing this key in combination with another key causes the GIGI terminal to transmit a control code which may have a special meaning to your system.

**ESC ESCAPE**

This key transmits an escape code which normally has a special meaning to your system. In many applications it tells your system to treat the next keys pressed as a command.

**SET-UP Mode Keys**

Figure 3-4 identifies the keys you can use in SET-UP mode. Chapter 4 provides a detailed description of the SET-UP mode.



MA 6727

FIGURE 3-4 SET-UP Mode Keys

**↑ SPACE BAR OR UP ARROW**

Either key steps to the next higher setting for a SET-UP parameter. When the highest value is reached, the setting returns to 0 and starts the cycle over again. Each key performs the same function.

**↓ DOWN ARROW**

This key steps to the next lower setting for a SET-UP parameter. When 0 is reached the setting returns to the highest value and starts the cycle over again.

**→ RETURN OR RIGHT ARROW**

Either key steps the terminal to the next SET-UP parameter. When the last parameter appears on the screen, the terminal automatically returns to the first SET-UP parameter. Each key performs the same function.

**← LEFT ARROW**

This key steps the terminal backwards to the previous SET-UP parameter. When the first parameter appears on the screen, the terminal automatically returns to the last SET-UP parameter.

**Alphabetic Keys**

These keys enter the two-letter code for each SET-UP parameter. This allows you to display any SET-UP parameter without stepping through all the parameters. If you type an incorrect code, the terminal sounds the bell tone and displays the last correct parameter.

**Numeric Keys**

These keys enter the numeric parameter setting of a SET-UP parameter. This allows you to set a parameter without stepping through all the parameter settings. If you type an incorrect setting, the terminal sounds the bell tone and displays the last correct parameter setting.

**PF4/RESET**

Pressing this key with either of the **SHIFT** keys resets the terminal to the power-up state. All the contents of memory, including the SET-UP parameter settings, are lost. Pressing these keys in SET-UP mode is the same as turning the terminal power switch off and on.

When you press this key by itself, the terminal sounds the bell tone.

**Locator Mode Keys**

Figure 3-5 identifies the keys that have a special meaning to the terminal in locator mode. The following paragraphs briefly describe the function of the locator keys in locator mode. If you press any keys other than those described, the terminal exits locator mode, sends the code of the key pressed, and then sends the screen location of the locator cursor. If the terminal enters locator mode through the host computer, the terminal sends a carriage return (CR) code followed immediately by the key code.

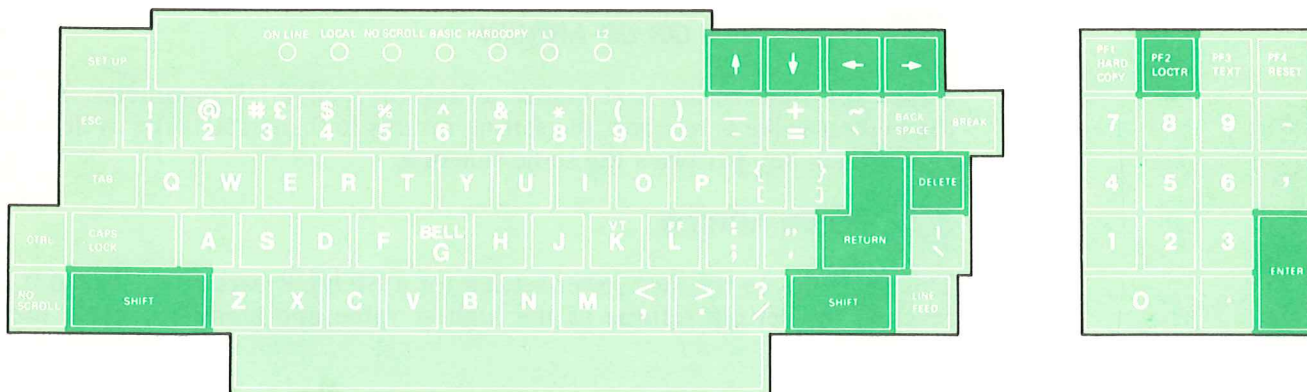

MA 6727

FIGURE 3-5 Locator Mode Keys



**PF2/LOCATOR**

Pressing this key with either of the **SHIFT** keys causes the terminal to enter locator mode and display the locator cursor (+) on the screen.

**ARROWS**

These keys move the locator cursor (+) around the screen. Each time you press the key, the locator cursor moves one dot in the direction shown by the arrow on the key. Pressing **SHIFT** with one of the arrow keys moves the locator cursor (+) ten dots in the direction shown by the arrow on the key.

**ENTER or RETURN**

Either of these keys end the locator mode of operation. The terminal sends the screen position of the locator cursor to the host computer.

**DELETE**

This key ends the locator mode of operation; however, the terminal does *not* send the screen position of the locator cursor to the host computer. If the terminal enters locator mode through the host computer, the terminal sends a carriage return (CR) code.

**VISUAL AND AUDIBLE INDICATORS**

The GIGI terminal has two types of indicator - visual indicators above the keyboard, and audible alarms.

**Visual Indicators**

Figure 3-6 shows the location of the keyboard indicators. The following paragraphs describe the function of each indicator.

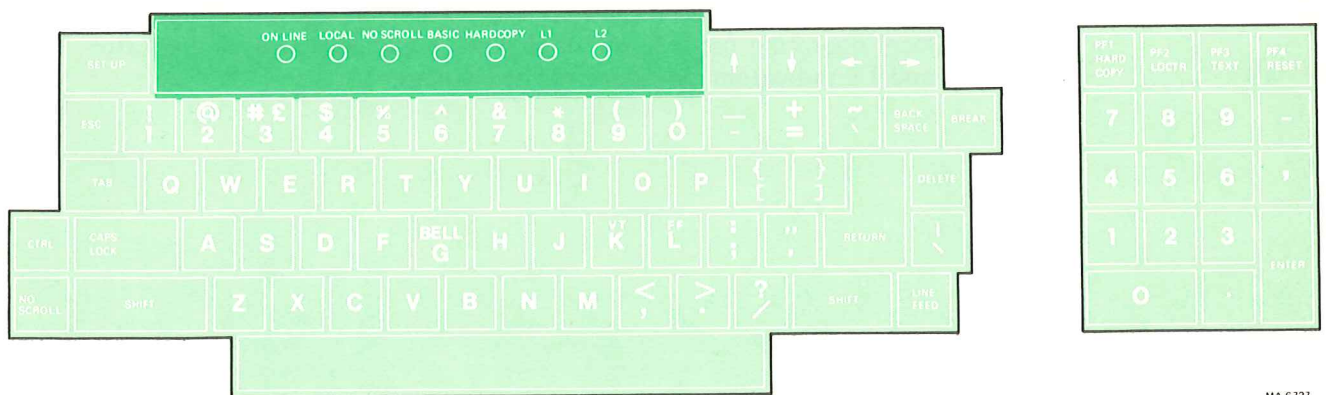

MA 6727

FIGURE 3-6 Keyboard Indicators

### **ON LINE**

This indicator lights to show that the GIGI terminal is on-line and ready to transmit or receive messages from the host computer. The ON LINE indicator can also show self-test errors.

### **LOCAL**

This indicator lights to show that the terminal is off-line and cannot communicate with the host computer. In local mode the keyboard remains active and all typed characters appear on the screen. The LOCAL indicator also shows self-test errors.

### **NO SCROLL**

This indicator lights to show that the **NO SCROLL** key was pressed and the terminal is no longer receiving or sending data to the host computer. The codes for any keys pressed while the NO SCROLL indicator is on are stored in the terminal and sent after the indicator turns off. To continue sending or receiving data, you must press **NO SCROLL** a second time. The NO SCROLL indicator is inactive if the XO SET-UP parameter is off (XO0).

### **BASIC**

This indicator lights to show that the terminal is in the BASIC program mode. In this mode the terminal interprets all data entered on the keyboard or received from the host computer as BASIC language commands. The BASIC indicator also shows self-test errors.

### **HARDCOPY**

This indicator lights to show that the optional hardcopy printer is copying the screen. When the operation is complete, the terminal turns the indicator off. The HARDCOPY indicator also shows self-test errors.

### **L1 and L2**

These indicators are turned on and off by the host computer. Consult your local operating procedures for the exact meaning of each indicator. The L1 and L2 indicators also show self-test errors.

## Audible Indicators

---

The GIGI terminal has two audible alarms – a short tone (click) and a long tone (beep).

### Short Tone (click)

The terminal sounds the short tone whenever you press a key, with the following exceptions.

1. **SHIFT** and **CTRL** keys do not generate a keyclick, because these keys do not transmit codes but only modify the codes transmitted by other keys.
2. No key generates a keyclick if the keyclick parameter is turned off in SET-UP mode

### Long Tone (beep)

The terminal sounds the long tone when one of the following conditions occurs.

1. The terminal enters SET-UP mode.
2. The terminal receives a bell code from the computer.
3. The cursor is eight characters away from the right margin, and the margin bell parameter is enabled.
4. The operator enters an incorrect parameter code or parameter setting in SET-UP mode.

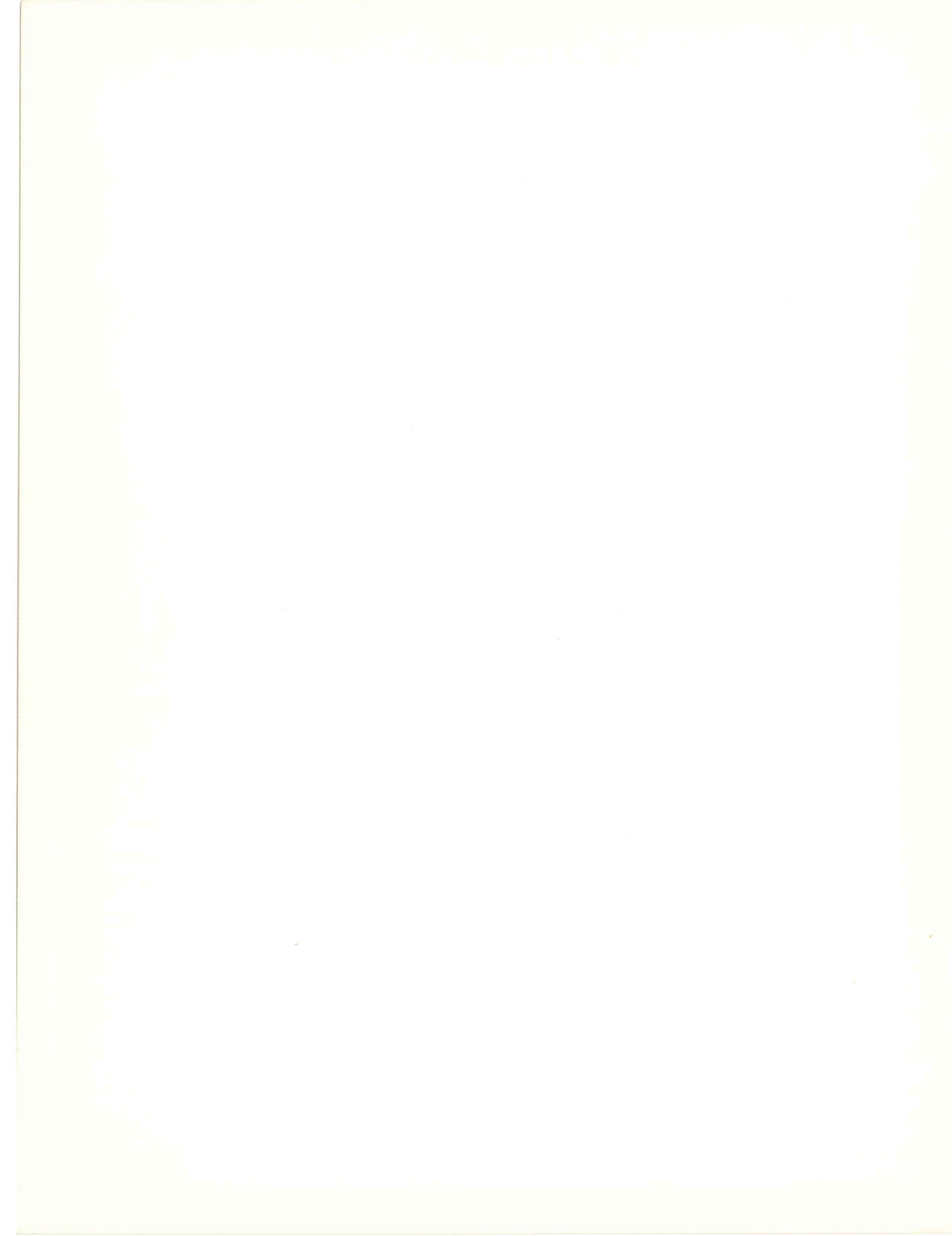

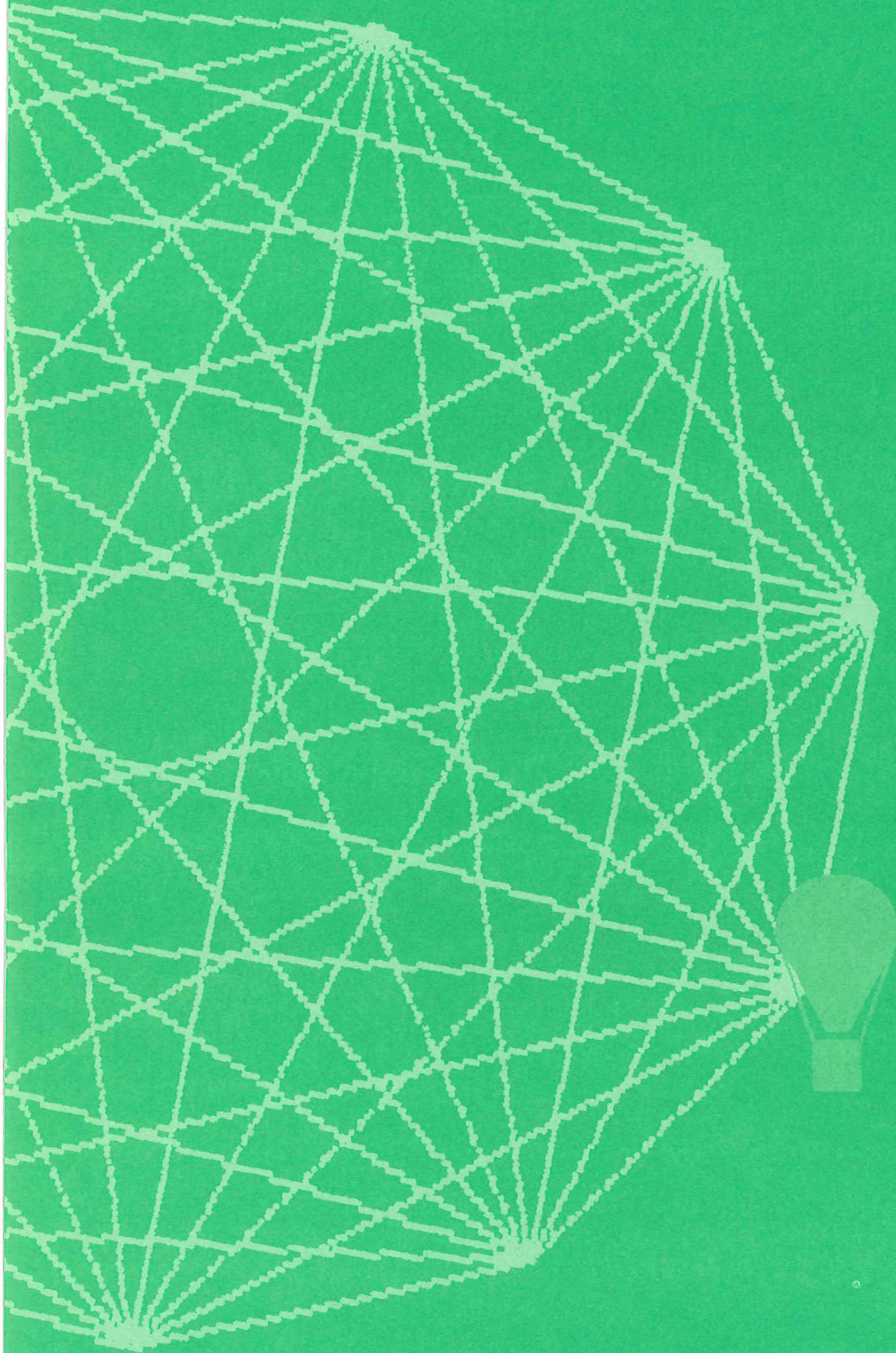

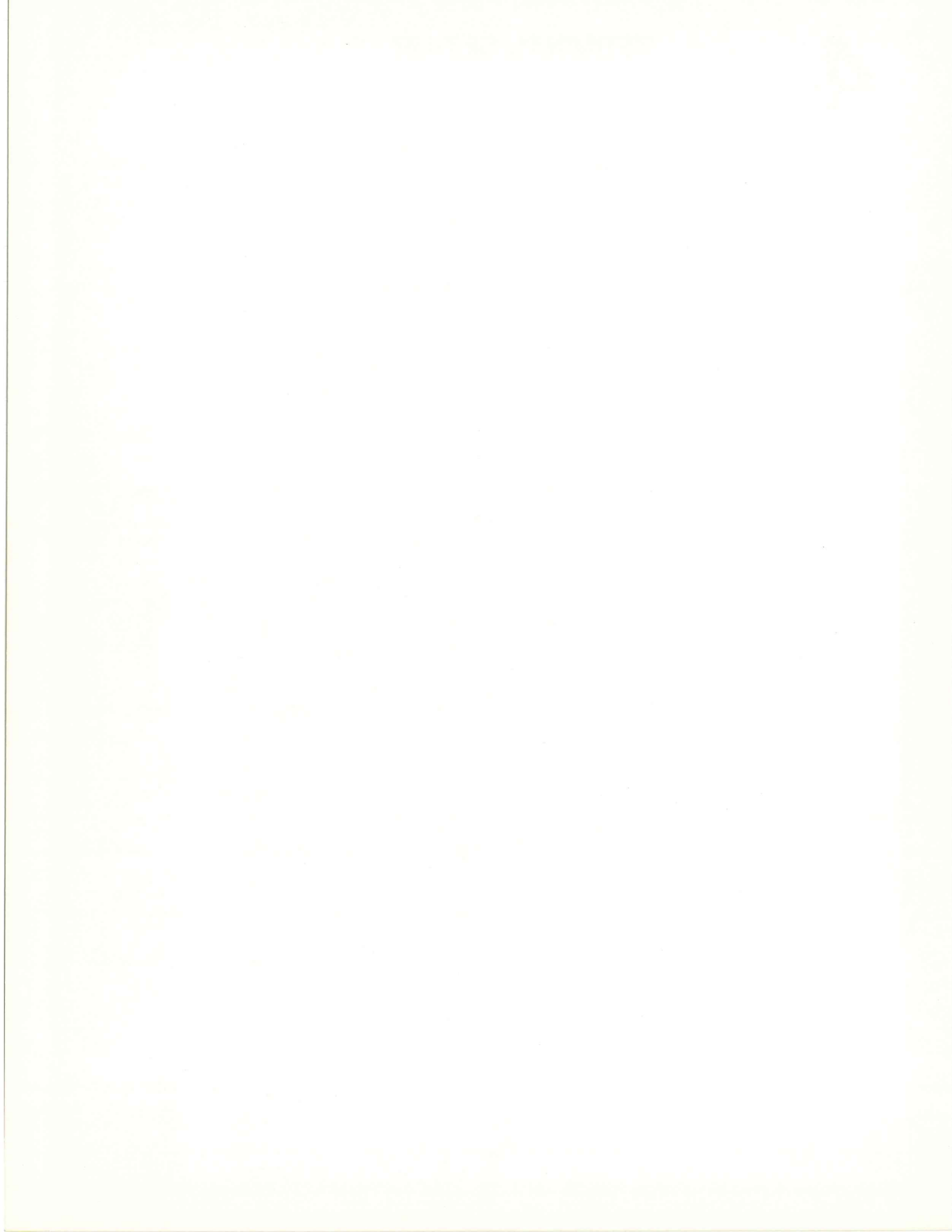

# 4

## TERMINAL SET-UP

### INTRODUCTION

---

The GIGI terminal contains many features. Some of these features help the operator in the daily use of the terminal. Other features allow the terminal to talk to many different types of computers and computer programs. To change these features to the required settings, the terminal contains a special mode of operation called SET-UP mode.

This chapter provides all the information you need to operate the GIGI terminal with your computer. The chapter includes the following sections.

- SET-UP mode description
- SET-UP parameter summary
- Determining what a SET-UP parameter does
- Changing a SET-UP parameter (operator)
- SET-UP parameter descriptions
- Changing a SET-UP parameter (host computer)

### SET-UP MODE DESCRIPTION

---

When you enter SET-UP mode, the terminal displays the status of each parameter stored in the terminal memory individually on the monitor screen. Once the parameter code appears, you can change the parameter setting. After you change the parameter setting, the terminal operates according to the new setting. The effect is the same as turning a switch on or off.

You enter SET-UP mode by pressing **SET-UP**. When you press **SET-UP** the following events occur.

1. The monitor screen scrolls down six character lines.
2. The long tone sounds.
3. The monitor enters the expanded mode.
4. A message similar to the following appears at the top center of the screen.

```
SET-UP TS4 2400
```

The word SET-UP indicates the terminal is in SET-UP mode.

The next two characters are the SET-UP parameter code. This code represents the SET-UP parameter you can now change. In this case the code is TS and stands for Transmit Speed.

Immediately following the SET-UP parameter code is its current setting (4 in this case). This parameter setting code changes when the parameter setting changes.

The last four characters in the message are an abbreviation of the current parameter setting. The abbreviation in this case is 2400, to show that the terminal transmit speed is set for 2400 baud (bits per second). The parameter setting abbreviation varies from setting to setting.

## TERMINAL SET-UP

The parameter settings entered in SET-UP mode are not permanent. Every time you turn terminal power off, the parameter settings return to a condition known as default. The default conditions reside in two different physical locations in the terminal the default SET-UP switch pack and the read only memory (ROM).

The default SET-UP switch pack controls the following parameters.

- Transmit (TS) and receive (RS) speed together
- Parity (PE)
- Default character (UK) sets
- Communications interface (CI)
- Power frequency (PF)

You can change the default values for these SET-UP parameters while installing the terminal. Chapter 2 provides the procedures to follow. This chapter discusses the specific function and possible settings for each SET-UP parameter.

All other default SET-UP parameter settings are controlled by the read only memory (ROM) in the GIGI terminal. These default parameter settings are permanent. Thus, if you want a parameter setting different from the default setting, you must change the setting each time terminal power is turned on.

### SET-UP Parameter Summary

---

The GIGI terminal contains all the SET-UP parameters listed in Table 4-1. The first column in the table lists the SET-UP parameters in the order they appear on the monitor screen. The second column lists the parameter codes, and the third column lists the possible setting codes for each parameter. The next column lists the exact message that appears on the screen, and the last column briefly describes what the parameter does for that setting.

This table serves only as a brief summary of the SET-UP parameters and how they affect the GIGI terminal. See the SET-UP Parameter Descriptions section of this chapter for a more complete description of each parameter and how it affects the terminal.



TERMINAL SET-UP

**Table 4-1 SET-UP Parameter Summary**

SET-UP Parameter	Para Code	Set Code	Displayed Message	Function
Transmit Speed	TS	0	TS0 110* †	Set transmit speed to 110 baud.
	TS	1	TS1 300	Set transmit speed to 300 baud.
	TS	2	TS2 600	Set transmit speed to 600 baud.
	TS	3	TS3 1200	Set transmit speed to 1,200 baud.
	TS	4	TS4 2400	Set transmit speed to 2,400 baud.
	TS	5	TS5 4800	Set transmit speed to 4,800 baud.
	TS	6	TS6 9600	Set transmit speed to 9,600 baud.
	TS	7	TS7 19.2	Set transmit speed to 19,200 baud.
Receive Speed	RS	0	RS0 110* †	Set receive speed to 110 baud.
	RS	1	RS1 300	Set receive speed to 300 baud.
	RS	2	RS2 600	Set receive speed to 600 baud.
	RS	3	RS3 1200	Set receive speed to 1,200 baud.
	RS	4	RS4 2400	Set receive speed to 2,400 baud.
	RS	5	RS5 4800	Set receive speed to 4,800 baud.
	RS	6	RS6 9600	Set receive speed to 9,600 baud.
	RS	7	RS7 19.2	Set receive speed to 19,200 baud.
Local/ Line	LL	0	LL0 Locl	Local mode.
	LL	1	LL1 OnLn*	On-line mode.
BASIC	BA	0	BA0 Off*	BASIC disabled.
	BA	1	BA1 Locl	BASIC enabled in local mode.
	BA	2	BA2 Host	BASIC enabled in host mode.
Parity Enable	PE	0	PE0 Off* †	Parity off, bit 8 set to SPACE.
	PE	1	PE1 Even	Even parity on, bit 8 set to even parity and checked.
	PE	2	PE2 Odd	Odd parity on, bit 8 set to odd parity and checked.
XON/XOFF	XO	0	XO0 Off	XON/XOFF not sent automatically.
	XO	1	XO1 On*	XON/XOFF sent automatically.
Scroll	SM	0	SM0 Off	No scrolling.
	SM	1	SM1 Jump	Jump scroll.
	SM	2	SM2 Smth*	Smooth scroll.
	SM	3	SM3 Wrap	Wrap scroll.
Reverse Video	RV	0	RV0 Off*	Normal video.
	RV	1	RV1 On	Reverse video.
Horizontal Margins	HM	0	HM0*	No horizontal margins.
	HM	1-9	HM(1-9)	Horizontal margins one to nine characters from left and right.
Vertical	VM	0	VM0*	No vertical margins.

\* Indicates the default value of the parameter.

† This default value is determined by the settings of the default SET-UP switch pack. Chapter 2 contains the procedure to change these settings.

**Table 4-1 SET-UP Parameter Summary (Cont.)**

SET-UP Parameter	Para Code	Set Code	Displayed Message	Function
Margins	VM	1-9	VM(1-9)	Vertical margins one to nine characters from top and bottom.
Expansion Mode	EM	0	EM0 Norm*	Normal display.
	EM	1	EM1 Expn	Expanded mode (double-width text characters).
Horizontal Position	HP	0-9	HP(0-9)	Horizontal display position.
	HP	5	HP5*	Normal horizontal display position.
Overstrike	OS	0	OS0 Off*	Normal text replacement.
	OS	1	OS1 On	Overlay text writing.
Visual Cursor	VC	0	VC0 Off	Disable visual cursor.
	VC	1	VC1 Text	Enable text visual cursor.
	VC	2	VC2 Grph	Enable graphics visual cursor.
	VC	3	VC3 Both*	Enable both cursors.
Text Display	TD	0	TD0 Norm*	Normal processing of text display.
	TD	1	TD1 Text	Display all characters as text (transparency mode); all characters are displayed as text and not processed, except LF which is displayed as next line.
	TD	2	TD2 Ctrl	Process all characters normally, display all unrecognized characters as text.
Graphics Display	GD	0	GD0 Norm*	Normal processing of graphics.
	GD	1	GD1 Text	Display graphics commands as text.
	GD	2	GD2 Top	Display last line of ReGIS at top of screen.
	GD	3	GD3 Bot	Display last line of ReGIS at bottom of screen.
Graphics Prefix	GP	0	GP0 Off*	Disable graphics prefix mode.
	GP	1	GP1 = "!"	Enable graphics prefix mode; character shown in quotes is prefix character.
Single Character	SC	0	SC0 Off*	Normal communications operation.
	SC	1	SC1 On	Single character operation.
Local Echo	LE	0	LE0 Off*	No local echo.
	LE	1	LE1 On	Local echo every key stroke.
New Line	NL	0	NL0 Off*	New line mode disabled.
	NL	1	NL1 On	New line mode enabled.
Auto Hardcopy	AH	0	AH0 Off*	Disable auto hardcopy mode.
	AH	1	AH1 On	Enable auto hardcopy mode.
Auto Wraparound	AW	0	AW0 Off	Disable auto wraparound.
	AW	1	AW1 On*	Enable auto wraparound.
Key Repeat	KR	0	KR0 Off	Disable key repeat parameter.
	KR	1	KR1 On*	Enable key repeat parameter.

\* Indicates the default value of the parameter.

TERMINAL SET-UP

**Table 4-1 SET-UP Parameter Summary (Cont.)**

SET-UP Parameter	Para Code	Set Code	Displayed Message	Function
Keyclick	KC	0	KC0 Off	Disable keyclick.
	KC	1	KC1 On*	Enable keyclick.
Margin Bell	MB	0	MB0 Off	Disable right margin bell.
	MB	1	MB1 On*	Enable right margin bell.
Terminal Mode	TM	0	TM0 VT52	VT52 mode.
	TM	1	TM1 ANSI*	ANSI mode.
Keypad Mode	KP	0	KP0 Norm*	Numeric keypad mode.
	KP	1	KP1 Appl	Application keypad mode.
Cursor Key Mode	CK	0	CK0 Norm*	Cursor key mode.
	CK	1	CK1 Appl	Cursor key application mode.
Programmed	PK	0	PK0 Off*	Programmed keypad disabled.
Keypad Mode	PK	1	PK1 On	Programmed keypad enabled.
Tablet	TL	0	TL0 Off*	Only four cursor keys control locator mode.
Locator Mode	TL	1	TL1 On	Tablet or cursor keys control locator mode.
UK Character Set	UK	0	UK0 U.S.* †	US character set.
	UK	1	UK1 U.K.	UK character set.
Comm. Interface	CI	0	CI0 EIA* †	EIA comm. interface selected.
	CI	1	CI1 20 mA	20 mA comm. interface selected.
Hardcopy Speed	HS	0	HS0 110	Set hardcopy speed to 110 baud.
	HS	1	HS1 300	Set hardcopy speed to 300 baud.
	HS	2	HS2 600	Set hardcopy speed to 600 baud.
	HS	3	HS3 1200	Set hardcopy speed to 1,200 baud.
	HS	4	HS4 2400	Set hardcopy speed to 2,400 baud.
	HS	5	HS5 4800	Set hardcopy speed to 4,800 baud.
	HS	6	HS6 9600*	Set hardcopy speed to 9,600 baud.
Power Frequency	PF	0	PF0 60 Hz* †	60 Hz power frequency.
	PF	1	PF1 50 Hz	50 Hz power frequency.
Interlace	IL	0	IL0 Off*	Interlace turned off.
	IL	1	IL1 On	Interlace turned on.
Self-Test	ST	1	ST1 PwUp	Select power-up self-test.
	ST	2	ST2 ExCm	Select external comm. test.
	ST	3	ST3 HcCm	Select hardcopy comm. test.
	ST	4	ST4 Dspl	Select display pattern test.
	ST	5	ST5 CBar	Select color bar test pattern.
	ST	9	ST9 Rept	Repeat selected test(s) until failure.
	ST	0	ST0 Clr	Clear all selected test(s).

\* Indicates the default value of the parameter.

† This default value is determined by the settings of the default SET-UP switch pack. Chapter 2 contains the procedure to change these settings.

### Determining What a SET-UP Parameter Does

---

The SET-UP parameters are basically a series of options in the GIGI terminal that allow you to tailor the terminal to its operating environment. Each time you turn the terminal on, you must set the SET-UP parameters according to the requirements of the physical location and the host computer. Table 4-2 lists each parameter in the order it appears on the monitor and places it in one of the following general groups.

- Installation
- Computer compatibility
- Monitor compatibility
- Operator preference

The installation parameters concern the initial installation of the terminal. If the physical location of the installation changes, verify the settings for these SET-UP parameters.

The computer compatibility parameters must be set correctly so the GIGI terminal can communicate with the host computer. An error in these settings may cause the terminal to send or receive incorrect data from the computer; or an error may prevent the terminal from communicating with the computer. You must obtain the settings for these parameters from the host computer programmer, operator, or system manager, since there are many combinations of settings designed to work with particular computers and computer programs. These parameter settings normally change only when you need to communicate with a different computer or a unique software package.

The monitor compatibility parameters allow the GIGI terminal to work with a wide range of monitors. These parameters allow you to tailor the video output of the terminal to the monitor and obtain the best possible screen display.

The operator preference parameters allow the operator to tailor the GIGI terminal to fit individual preference. These parameters do not affect operations between the terminal and the computer.

TERMINAL SET-UP

**Table 4-2 SET-UP Parameter Categories**

SET-UP Parameter*	Install	Host	Monitor	Oper
Transmit Speed (TS)	-	x	-	-
Receive Speed (RS)	-	x	-	-
Line/Local (LL)	-	x	-	-
BASIC	-	x	-	-
Parity Enable (PE)	-	x	-	-
XON/XOFF (XO)	-	x	-	-
Scroll Mode (SM)	-	x	-	-
Reverse Video (RV)	-	-	-	x
Horizontal Margins (HM)	-	-	x	-
Vertical Margins (VM)	-	-	x	-
Expansion Mode (EM)	-	x	-	-
Horizontal Position (HP)	-	-	x	-
Overstrike (OS)	-	-	x	-
Visual Cursor (VC)	-	-	-	x
Text Display (TD)	-	x	-	-
Graphics Display (GD)	-	x	-	-
Graphics Prefix (GP)	-	x	-	-
Single Character (SC)	-	x	-	-
Local Echo (LE)	-	x	-	-
New Line (NL)	-	x	-	-
Auto Hardcopy (AH)	-	x	-	-
Auto Wraparound (AW)	-	x	-	-
Key Repeat (KR)	-	-	-	x
Keyclick (KC)	-	-	-	x
Margin Bell (MB)	-	-	-	x
Terminal Mode (TM)	-	x	-	-
Numeric Keypad Mode (KP)	-	x	-	-
Cursor Key Mode (CK)	-	x	-	-
Programmed Keypad Mode (PK)	-	-	-	x
Tablet Locator Mode (TL)	-	x	-	-
UK Character Set (UK)	x	-	-	-
Comm. Interface (CI)	x	-	-	-
Hardcopy Speed (HS)	x	-	-	-
Power Frequency (PF)	x	-	-	-
Interlace (IL)	-	-	x	-
Self-Test (ST)	x	-	-	-

\* The SET-UP parameter code used to change the SET-UP parameter is shown in parentheses.

## Changing a SET-UP Parameter (Operator)

---

Changing any or all of the SET-UP parameters is a simple operation you can usually perform by following this general procedure.

1. Enter SET-UP mode by pressing **SET-UP**.
2. Select the SET-UP parameter you want to change. Use one of the four following methods.
  - a. Type the two-character SET-UP parameter code on the keyboard.
  - b. Press **RETURN** until the SET-UP parameter code appears on the screen. Each time you press this key, you advance one code.
  - c. Press the **→** key until the SET-UP parameter code appears on the screen. Each time you press this key, you advance one code.
  - d. Press the **←** key until the SET-UP parameter appears on the screen. Each time you press this key, you go back one code.
3. Change the parameter setting. Use one of the four following methods.
  - a. Type the single-digit parameter setting. This changes the parameter setting to the typed-in value without stepping through all the possible parameter settings.
  - b. Press the **SPACE BAR**. Each time you press the **SPACE BAR** the parameter setting advances to the next possible value.
  - c. Press the **↑** key. Each time you press the **↑** key, the parameter setting advances to the next possible value.
  - d. Press the **↓** key. Each time you press the **↓** key, the parameter setting goes back to the previous setting.

To change more than one SET-UP parameter, just repeat steps 2 and 3 as often as needed. Pressing either the **RETURN** or **→** key advances the terminal to the next parameter and displays the new parameter and its current setting. Pressing the **←** key steps the terminal back to the previous parameter and displays that parameter and its setting. The terminal always returns to the first parameter (TS) after stepping through all the parameters.

If you press any keys other than **SPACE**, **RETURN**, **←**, **→**, **↑**, **↓**, a parameter code letter, or a parameter value, the terminal bell sounds and the last correct parameter or parameter setting appears on the screen.

When all the SET-UP parameters are set, exit the SET-UP mode by pressing **SET-UP** once. The screen then scrolls back to its original position and the normal viewing area appears again.

## SET-UP PARAMETER DESCRIPTIONS

---

This section describes each SET-UP parameter in detail and explains how each parameter affects the terminal. The SET-UP parameters are listed in the order they appear on the screen.

**Note:** Unless otherwise stated, entering SET-UP mode and changing parameters does not result in the loss of data on the screen.

### Transmit Speed (TS)

---

You must set transmit speed to match the computer receive speed. The GIGI terminal can transmit at any one of the following preselected speeds: 110, 300, 600, 1,200, 2,400, 4,800, 9,600, and 19,200 baud.

## TERMINAL SET-UP

Transmit speed is independent of receive speed; the terminal can transmit data at one speed and receive data at a different speed.

You select the default value of both this parameter and the receive speed (RS) parameter with the same default SET-UP switch pack settings.

**Note:** Setting this parameter to 110 baud (TS0) selects two stop bits; all other settings select one stop bit.

### Receive Speed (RS)

---

You must set receive speed to match the computer transmit speed. The GIGI terminal can receive at any one of the following preselected speeds: 110, 300, 600, 1,200, 2,400, 4,800, 9,600 and 19,200 baud.

Receive speed is independent of transmit speed; the terminal can receive data at one speed and transmit data at a different speed.

You select the default value of both this parameter and the transmit speed (TS) parameter with the same default SET-UP switch pack settings.

### Line/Local (LL)

---

The line/local parameter allows you to easily enter the terminal into either an on-line or a local (off-line) mode. When the terminal is on-line (the ON-LINE indicator lights), all characters typed on the keyboard are sent directly to the computer and messages from the computer appear on the screen. In local mode (the LOCAL indicator lights), the terminal is effectively disconnected from the computer; messages are not sent to or received from the computer. Characters typed on the keyboard are echoed directly to the screen.

**Note:** When the terminal is on-line (LL1), the data terminal ready (DTR) signal on the EIA communications line is asserted. When the terminal enters local mode (LL0), DTR is deasserted and the LOCAL indicator lights.

### BASIC (BA)

---

The BASIC mode parameter allows you to select the BASIC programming capability of the GIGI terminal. If the BASIC mode is off (BA0), the terminal operates normally. The line/local parameter (LL) determines if the terminal is on-line or local to the host computer.

When you select BASIC local (BA1), the standard BASIC programming capability of the terminal turns on and the terminal keyboard acts as the input device to BASIC. In this mode you enter a BASIC program into the terminal by typing it on the keyboard. The BASIC indicator lights when you set the parameter to BA1.

When you select BASIC host (BA2), the BASIC programming capability of the terminal turns on and the host computer acts as the input device to BASIC. In this mode the host computer normally loads a BASIC program in the GIGI terminal through the communications line. The BASIC indicator lights when you set the parameter to BA2.

### Parity Enable (PE)

---

The parity enable parameter defines the type of parity bit that the GIGI terminal generates for transmitted characters and checks for received charac-

ters. All characters contain eight bits – seven data bits and one parity bit. You can select the parity bit from one of the three following options.

1. Space parity, which ignores the parity bit for all received characters (PE0)
2. Even parity, with even parity checking for all received characters (PE1)
3. Odd parity, with odd parity checking for all received characters (PE2)

You select the default value of this parameter with the default SET-UP switch pack settings. Chapter 2 provides information on how to set these switches.

### XON/XOFF (XO)

The GIGI terminal can automatically generate the synchronizing codes XON (DC1) and XOFF (DC3). The synchronizing codes prevent data loss when the host computer sends characters to the terminal faster than the terminal can process them. The XOFF control code stops data transmission from the host computer to the terminal; the XON code signals the host computer to resume transmission.

When the parameter is on, and the receive buffer contains 100 unprocessed characters, the GIGI terminal automatically generates the XOFF code. The receive buffer fills to that point when one of the following events occur.

1. You press **NO SCROLL**.
2. You enter the SET-UP mode.
3. The terminal receives characters faster than it can process them.

The buffer empties only after you press **NO SCROLL** again or take the terminal out of SET-UP mode. The terminal then takes characters out of the buffer and processes them one at a time. When 50 characters remain in the buffer, the terminal transmits the XON code to resume transmission from the computer to the terminal.

If the XON/XOFF parameter is off, **NO SCROLL** is disabled.

If the host computer software does not support the XON/XOFF codes, data sent during buffer-full conditions may be lost.

**Note:** The GIGI terminal always stops transmission when it receives an XOFF (DC3) code and resumes transmission when it receives an XON (DC1) code, regardless of the auto XON/XOFF parameter setting.

### Scroll Mode (SM)

Scrolling describes the movement of existing lines on the monitor screen to make room for new lines on the screen. The scroll mode function has four possible settings: scroll off, jump scroll, smooth scroll, or wrap scroll.

In scroll off mode (SM0), the text cursor always remains on the top or bottom line of the display. The display does not move up or down. The terminal adds new lines to the screen by writing over the top or bottom line.

In jump scroll mode (SM1), the text cursor immediately moves to the next line. In this mode the existing lines on the screen move up or down to make room for new lines. The new lines appear on the screen as fast as the computer sends them to the terminal. At the higher baud rates, the data is very difficult to read due to the rapid movement of the lines.



**Note:** Jump scroll mode allows the terminal to add a maximum of thirty lines per second at the top or bottom of the screen. The XON/XOFF parameter must be enabled and supported by the host computer to ensure that data is not lost when jump scroll mode is enabled.

In smooth scroll mode (SM2), the terminal receives new lines of data at a limited speed. The movement of lines occurs at the smooth, steady rate of eight lines per second, allowing you to read the data as it appears on the screen.

**Note:** Smooth scroll mode allows the terminal to add a maximum of eight lines per second at the top or bottom of the screen. The XON/XOFF parameter must be enabled and supported by the host computer to ensure that data is not lost when smooth scroll mode is enabled.

In wrap scroll mode (SM3), the terminal adds new lines to the screen by writing over the old lines. When you reach the end of the screen, (bottom or top) the cursor automatically moves to the beginning of the screen, and the terminal writes new lines over the old lines on the screen. Existing data on the screen does not move.

### Reverse Video (RV)

---

The reverse video parameter allows you to select the background of the screen. In normal screen mode (RV0), the screen contains light (or colored) characters on a dark background. In reverse screen mode (RV1), the screen contains dark characters on a light (or colored) background.

### Horizontal Margins (HM)

---

This parameter allows you to tailor the video output of the GIGI terminal to your monitor. If the monitor cannot display 84 characters per line, you can insert margins on both sides of the screen. The width of each margin is in characters.

If the horizontal margin parameter is set for HM0, the monitor can display 84 characters on a line (42 characters if the expansion mode parameter is set for EM1). If the parameter is set for a one-character margin (HM1), both the left and right margins are one character wide. This setting allows only 82 characters per line (40 characters in EM1).

The maximum margin width is nine characters for both the left and right margins. This setting provides space for 66 characters per line (24 characters in EM1).

### Vertical Margins (VM)

---

This parameter allows you to tailor the video output of the GIGI terminal to your monitor. If the monitor cannot display 24 lines of data, you can insert vertical margins at the top and bottom of the screen. The height of each margin is in lines.

If the vertical margin parameter is set for VM0, the terminal sends 24 lines of data to the monitor before scrolling the screen. If the parameter is set for VM1, both the top and bottom margins are set for one line. This setting allows the terminal to send 22 lines of data to the monitor before scrolling the screen.

The maximum margin height is nine lines for both the top and bottom margins. This setting allows the terminal to send six lines of data to the monitor before scrolling the screen.

### Expansion Mode (EM)

---

This parameter allows you to expand characters on the screen to twice their normal width. In normal mode (EM0), characters are seven dots wide and are spaced two dots apart. In expanded mode (EM1), characters are 14 dots wide and are spaced 4 dots apart.

The EM1 setting allows a maximum of 42 characters per line.

### Horizontal Position (HP)

---

This parameter allows you to tailor the video output of the GIGI terminal to your monitor. The horizontal position parameter lets you center the entire display on the screen. The normal setting for this parameter is HP5. If the display is left of center, increase the value of the parameter setting. This moves the entire display to the right. If the display is right of center, decrease the parameter setting value. This moves the entire display to the left.

### Overstrike (OS)

---

This parameter allows you to create special graphics on the screen by typing over characters. If the overstrike parameter is off (OS0), typing over a character replaces the old character with the new character. If the parameter is on (OS1), typing over a character places the new character over the old character without destroying the old character. For example, this parameter allows you to create the “not equal to” sign ( $\neq$ ) by pressing the = key, **BACKSPACE** key, and / key.

### Visual Cursor (VC)

---

This parameter allows you to change the visual cursor displayed. The cursor is the visual indicator that shows the “active position”, where the next character will appear on the screen. The text cursor is a solid block character (■); it only appears when the terminal is in text mode. The graphics cursor is a diamond cross hair (⋄) at the current drawing position; it only appears when the terminal is in graphics mode. Only one cursor appears on the screen at any one time.

The visual cursor parameter has four settings.

In VC0, neither the text cursor nor the graphics cursor appears on the screen.

In VC1, the text cursor appears in text mode, and no cursor appears in graphics mode.

In VC2, no cursor appears in text mode, but the graphics cursor appears in graphics mode.

In VC3, both the text and graphics cursors appear in their respective modes.

### Text Display (TD)

---

This parameter controls how characters sent to the display are processed by the terminal.

In TD0, normal processing of both text and ReGIS graphics occurs.

In TD1, all characters appear as graphics text, including all control and escape sequences. No normal processing of these characters occurs, except for line feed (LF) which causes a next-line function. The XON/XOFF codes are still interpreted for synchronization, but also appear as graphics text. Control codes appear as the proposed ANSI standard two-character mnemonics.

In TD2, normal processing occurs; those control codes which are not normally processed appear as graphics text. Unrecognized escape and control sequences do *not* appear.

### Graphics Display (GD)

---

This parameter controls how characters sent to the terminal's ReGIS interpreter are processed.

In GD0, normal ReGIS processing occurs.

In GD1, ReGIS commands appear as text, and no graphics display occurs. When you enter ReGIS mode while in GD1, the message "GON" appears on the screen, and "GOFF" appears when the ReGIS string is done.

In GD2 and GD3, normal processing of ReGIS graphics commands occurs. The last line of the ReGIS commands appears as text on the top display line (GD2) or bottom display line (GD3). This line appears only when there are no more ReGIS commands to process, or when you freeze the display by pressing **NO SCROLL**.

### Graphics Prefix (GP)

---

This parameter allows the terminal to enter graphics mode by receiving a single unique character from the host computer. When the graphics prefix character parameter is off (GP0), no graphics prefix character operations can occur. When the parameter is on (GP1), the line feed (LF) character followed by the graphics prefix character enters the terminal into graphics mode. The terminal interprets any characters received after the prefix character as graphics data. The next LF character received returns the terminal to normal text mode. If the graphics prefix character follows the second LF character, the terminal remains in graphics mode for the next line. The terminal does not perform a line feed function when it receives the second LF character.

Use the following procedure to set the graphics prefix character.

1. Enter SET-UP mode and place the graphics prefix character parameter on the screen. If the parameter has not been set, the default character (!) appears as the prefix character.
2. Press the = key.
3. Press the key for the prefix character. The prefix character may be any one of 95 graphic text characters (space thru  $\mu$ ).

The graphics prefix character is now set in the terminal.

### Single Character (SC)

---

When this parameter is on (SC1), the terminal sends a carriage return (CR) character after each code or set of codes generated by a single keystroke. The CR character is also sent after a terminal report.

### Local Echo (LE)

---

When this parameter is on (LE1), every character sent to the host computer is automatically echoed on the screen. The host computer does not have to transmit the character back to the terminal.

If double characters appear on the screen, turn the local echo parameter off, since the host computer is echoing characters back to the terminal.

### New Line (NL)

---

This parameter enables the **RETURN** key on the terminal to function like the **RETURN** key on an electric typewriter. When the new line parameter is on (NL1), pressing **RETURN** generates the carriage return (CR) and line feed (LF) codes. When the terminal receives a LF code, it interprets the code as a carriage return and line feed.

When the parameter is off (NL0), pressing **RETURN** generates only the CR code; a LF code causes the terminal to perform a line feed only.

If double line feeds occur consistently, turn this parameter off since the computer is performing this function.

### Auto Hardcopy (AH)

---

This parameter allows you to make a continuous hardcopy record of all text that appears on the screen. When the auto hardcopy parameter is on (AH1), the printer copies the screen:

1. Just before the screen is cleared
2. Each time an entire display of new lines scrolls onto the screen.

### Auto Wraparound (AW)

---

This parameter determines where the next character will appear on the screen once you reach the end of the current line. When the auto wraparound parameter is off (AW0), all characters received after you reach the end of the line appear in the last character position of that line. For example, take an 84-character line. With the parameter off, the eighty-fifth text character received appears at the end of the current line and replaces the character already located there. This continues until the terminal receives a carriage return character.

When the parameter is on (AW1), the eighty-fifth text character received appears in the first character position on the next line.

### Key Repeat (KR)

---

This parameter allows a key to automatically repeat when you hold the key down for more than 0.5 seconds. The repeat rate speeds up to about 30 characters per second when you hold the key down for more than 1.5 seconds. The key repeat parameter affects all but the following keyboard keys.

**BREAK**  
**ESC**  
**NO SCROLL**  
**SET-UP**  
**RETURN**  
**CTRL** and any other key  
**PF 1** to **PF 4** and **SHIFT**

### Keyclick (KC)

---

The keyclick is a tone generated every time you press a key. The keyclick may be turned on or off to suit the operator's needs. However, research and experience have shown that an operator is more accurate when there is an audible feedback from the keyboard.

The keyclick volume is not adjustable.

### Margin Bell (MB)

---

This parameter acts like the bell in a typewriter. When the margin bell parameter is on (MB1), the GIGI terminal sounds a tone to alert the operator that the cursor is nine characters from the end of the current line.

### Terminal Mode (TM)

---

The GIGI terminal follows two different programming standards – American National Standards Institute (ANSI) and VT52. In ANSI mode (TM1), the GIGI terminal generates and responds to coded sequences per ANSI standards X3.41-1974 and X3.64-1977. In VT52 mode (TM0), the GIGI terminal is compatible with previous DIGITAL software used on the VT52 video terminal. Chapter 7 summarizes both ANSI and VT52 modes.

### Keypad Mode (KP)

---

In normal (numeric) mode (KP0), the auxiliary keypad keys transmit the ASCII codes for the characters engraved on the keycaps, (0 to 9, etc.). The **ENTER** key acts like the **RETURN** key on the main keyboard. In application mode (KP1), these keys transmit unique escape sequences. Chapter 7 provides the exact escape sequences.

### Cursor Key Mode (CK)

---

In normal (cursor) mode (CK0), the four cursor keys send the ANSI cursor movement escape sequences. In application mode (CK1), the cursor keys transmit unique escape sequences. Chapter 7 provides the exact escape sequences. In VT52 mode (TM0), this parameter has no effect; the four cursor keys send the codes listed in Table 7-1.

### Programmed Keypad Mode (PK)

---

You can program the GIGI terminal to send special sequences for any or all of the auxiliary keypad keys. When the programmable keypad parameter is on (PK1), keys that are programmed to send special code sequences send those sequences. Keys not programmed are not affected. If the parameter is off (PK0), all cursor and auxiliary keypad keys transmit their normal sequences as selected by the TM, KP, and CK parameters.

### Tablet Locator Mode (TL)

---

This parameter defines how you move the locator mode cross-hair cursor. When the parameter is off (TL0), you move the cross-hair cursor by pressing one of the four arrow keys on the keyboard. The cross-hair cursor moves in the direction of the arrow on the key.

When this parameter is on (TL1), an optional tablet pen or cursor positions the cross-hair cursor.

### United Kingdom Character Set (UK)

---

The GIGI terminal contains two different character sets – the United States ASCII character set and the UK (United Kingdom) character set. The difference between the two sets is one character, the # or £ sign. When this parameter is on (UK1), the UK pound sign £ appears instead of the # sign.

Setting this parameter does not immediately change the character that appears on the screen. You must reset the terminal to obtain the desired character set.

The default SET-UP switch pack settings determine the default value of this parameter. Chapter 2 provides information on how to set these switches.

### Communications Interface (CI)

---

This parameter selects the communications interface (EIA or 20 mA current loop) used to connect the terminal to the host computer. A parameter setting of CI0 selects EIA communications. CI1 selects the 20 mA communications. You must set this parameter correctly for the GIGI terminal to communicate with the host computer.

The default SET-UP switch pack settings determine the default value of this parameter. Chapter 2 provides information on how to set these switches.

### Hardcopy Speed (HS)

---

You must set the hardcopy speed to match the hardcopy printer's transmit and receive speed. The GIGI terminal can transmit data to the hardcopy printer at any one of the following preselected speeds: 110, 300, 600, 1,200, 2,400, 4,800, 9,600 and 19,200 baud.

### Power Frequency (PF)

---

This parameter matches the terminal's video output signals to the monitor characteristics affected by the power line frequency. During the terminal installation, you must set this parameter for the power line frequency, 50 or 60 Hertz. In the US, the correct setting is 60 Hertz (PF0).

The default SET-UP switch pack settings determine the default value of this parameter. Chapter 2 provides information on how to set these switches.

### Interlace (IL)

---

Interlace describes a method of displaying characters on the screen. When the interlace parameter is on, every other scan line (row of horizontal dots) appears on the screen. After a complete scan of the screen, the terminal returns to start and scans the lines that were skipped. When the parameter is off, every scan line appears on the screen in order.

Using the interlace parameter with a monitor that does not need an interlaced video input causes the screen to flicker. When you use the Barco Model GD33 monitor with the GIGI terminal, turn the interlace parameter off (IL0).

### Self-Test (ST)

---

This parameter selects the internal test programs the terminal performs. The following programs are available.

- Clear all selected test(s) (0)
- Power-up test (1)
- External communications test (2)
- Hardcopy communications test (3)
- Display pattern test (4)
- Color bar test pattern (5)
- Repeat the selected test(s) until failure (9)

The self-test parameter allows you to select more than one test program. To do this just type the number of each test program you want to run. The terminal performs the test(s) when you exit SET-UP mode by pressing **SET-UP**.

### Changing a SET-UP Parameter (Host Computer)

---

The host computer can change all GIGI terminal SET-UP parameters. The host computer has this capability because the SET-UP parameters directly affect how the terminal acts with specific programs. The host computer changes the SET-UP parameters by sending escape sequences to the terminal. The terminal then changes the SET-UP parameters and acts according to the new settings.

The Device Control Strings (DCS) section in Chapter 7 describes the specific escape sequences and message formats that change the terminal SET-UP parameters.

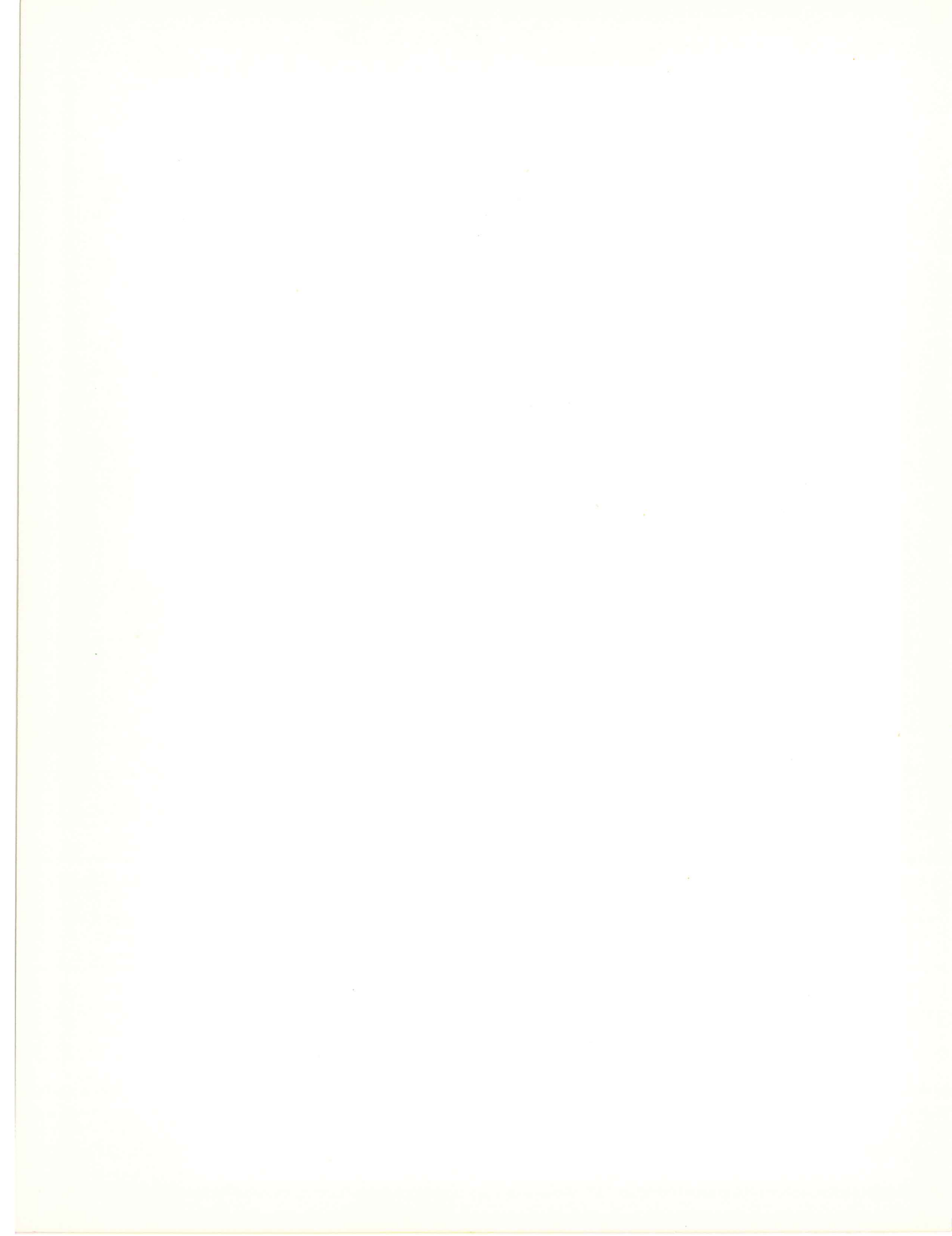



# What to Do In the Event of a Problem

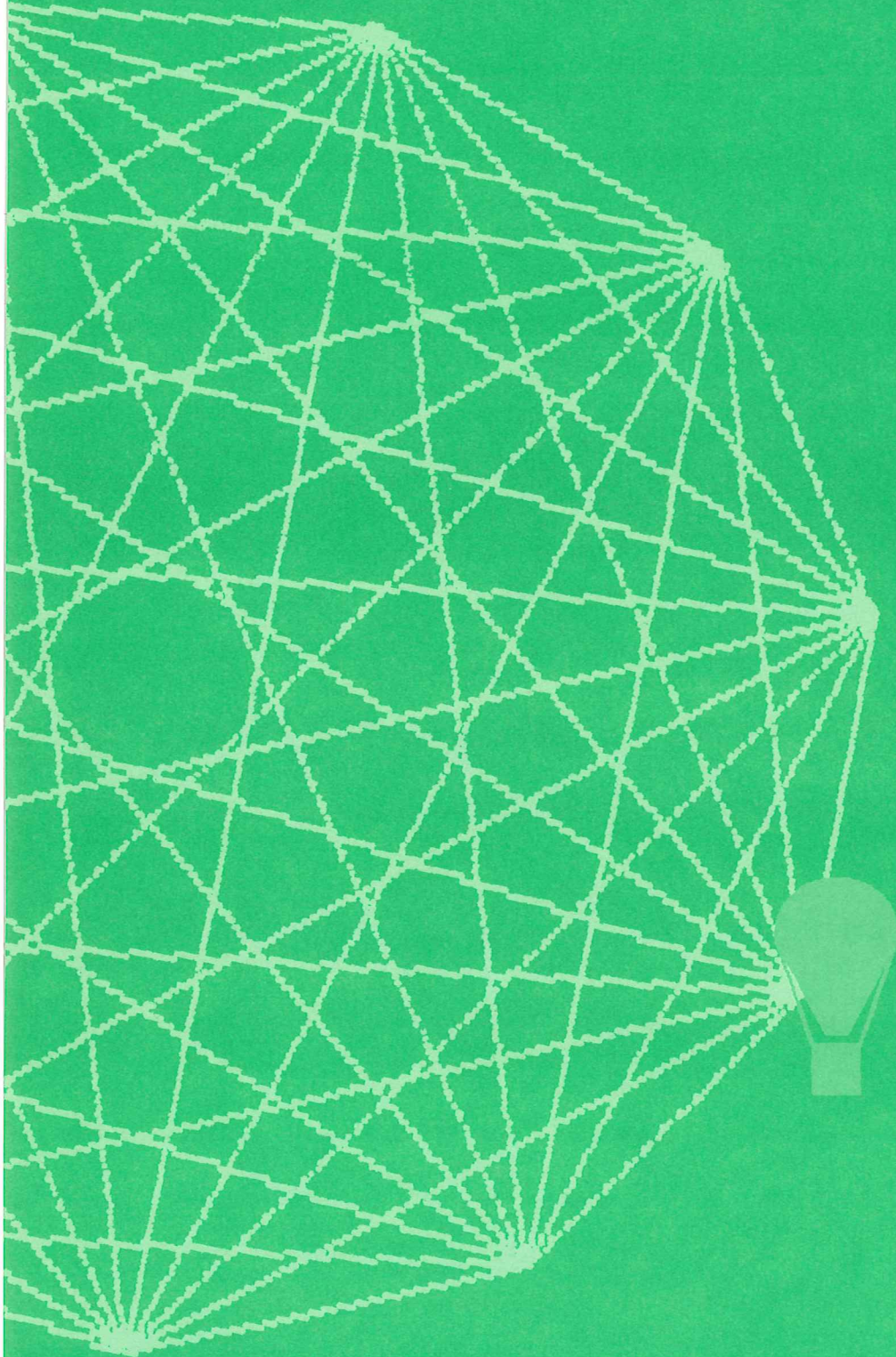

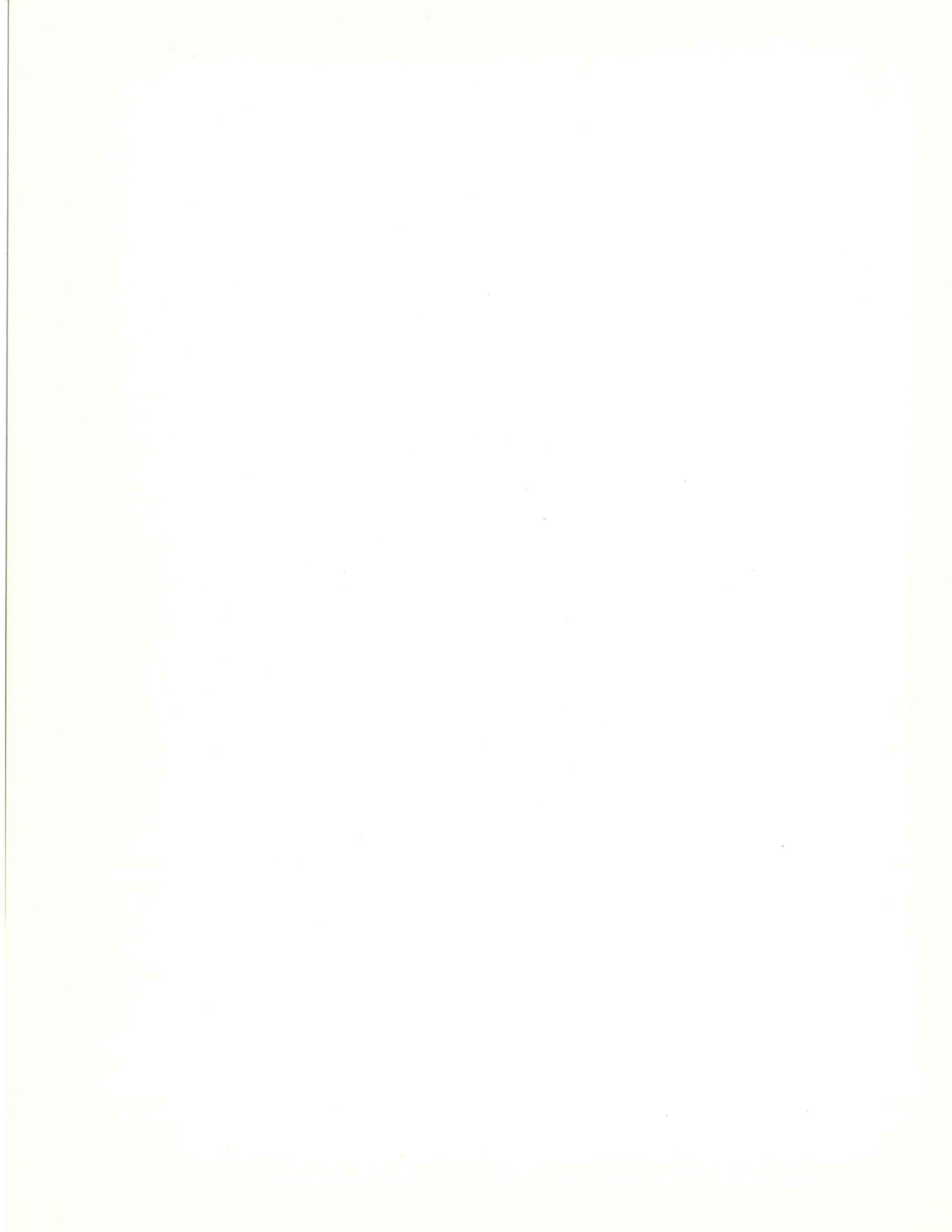

# 5

## WHAT TO DO IN THE EVENT OF A PROBLEM

### INTRODUCTION

---

The GIGI terminal can perform many functions. Some of these functions are controlled by the terminal hardware, while others are controlled by the software. Many times you cannot tell the difference between a hardware or software failure if a function does not perform as expected. To help you isolate the problem, every GIGI terminal contains a complete set of hardware self-test programs.

The hardware self-tests check all the major terminal functions. If a problem is found, the self-test program indicates that a problem exists and what the problem is. The first part of this chapter outlines the steps you should follow to test the GIGI terminal. This section also gives you all the test results and their meanings.

The second part of this chapter contains a simple troubleshooting chart. The troubleshooting chart lists some common problems that may occur along with the steps you can take to correct them. Many times you can avoid a costly service call simply by referring to this chart and performing the actions recommended.

### INTERNAL HARDWARE SELF-TESTS

---

A self-test mode is built into the GIGI terminal. The self-test mode has two different series of tests, power-up tests and diagnostic tests. The power-up tests automatically check the condition of the terminal every time you turn on terminal power. The diagnostic tests check the terminal outputs, and require the loopback connectors.

#### Power-Up Self-Test

---

The power-up self-test checks the following terminal circuits.

- Microprocessor
- Visual and audible indicators
- Read only memory (ROM)
- Random access memory (RAM)
- CRT controller
- CRT timing
- Vector timing
- Video bit map
- Vector generator
- Keyboard
- Communications (internal)

You can start the power-up self-test in four different ways.

1. Turn the terminal power switch on.
2. Reset the terminal by pressing the **SHIFT** and auxiliary keypad **PF 1** keys together in SET-UP mode.
3. Select the SET-UP self-test feature (ST1).
4. Receive a command from the host computer.

The power-up self-test takes about 15 seconds to run. While the test is running, various random patterns appear on the monitor screen. This is a normal indication. Once the test is complete, the cursor appears in the upper left corner of the screen and *only* the ON LINE indicator is turned on. If the self-test finds an error, the error appears on either the keyboard indicators or the screen. See the Error Codes section of this chapter for a list of the error codes and their meanings.

### Diagnostic Tests

---

The GIGI terminal contains the following five diagnostic tests.

1. External communications test
2. Hardcopy communications test
3. Display test
4. Color bar test
5. Screen alignment pattern

The following paragraphs discuss these tests individually.

#### External Communications Test

This test is an extension of the internal communications test contained in the power-up test. In the external communications test, the transmit and receive lines connect through a loopback connector. Then a predefined set of characters is transmitted. The terminal receives the characters and compares them to the characters transmitted. If the characters do not match, an error is indicated. This test runs for all communications speeds.

The external communications test requires a loopback connector. Chapter 9 provides information on how to obtain loopback connectors needed for this test.

Use the following procedure to start the external communications test.

1. Turn the terminal power off.
2. Disconnect the communications cable from the rear of the terminal.
3. Install the correct loopback connector on the terminal communications output connector. Loopback connector part number 12-15336-00 is for EIA communications; part number 70-15503-00 is for 20 mA current loop communications.
4. Turn the terminal power on.
5. Enter SET-UP mode.
6. Verify the communications interface SET-UP feature (CI0 is EIA and CI1 is 20 mA.)
7. Set the self-test SET-UP feature for selection 2 (ST2).
8. Exit SET-UP mode by pressing **SET-UP**. This starts the test.

Any error found by the test appears on the monitor screen. See the Error Codes section of this chapter for a list of the error codes and their meanings.

#### Hardcopy Communications Test

This test is similar to the external communications test. In the hardcopy communications test, the transmit and receive hardcopy output lines connect through a special loopback connector. Then a predefined set of characters is transmitted. The terminal receives the characters and compares them to the characters transmitted. If the characters do not match, an error is indicated.

This test requires a loopback connector. Chapter 9 provides information on how to obtain loopback connectors needed for this test.

Use the following procedure to start the hardcopy communications test.

1. Turn the terminal power off.
2. Disconnect the hardcopy printer cable from the rear of the terminal.
3. Install the EIA loopback connector on the terminal hardcopy connector. The loopback connector is part number 12-15336-00.
4. Turn the terminal power on.
5. Enter SET-UP mode.
6. Set the self-test SET-UP feature for selection 3 (ST3).
7. Exit SET-UP mode by pressing **SET-UP**. This starts the test.

Any error found by the test appears on the monitor screen. See the Error Codes section of this chapter for a list of the error codes and their meanings.

### Display Test

This test displays a full screen of blue, red, green, white, black, and a crosshatch pattern. Each display screen lasts for approximately 0.5 seconds, and the crosshatch pattern remains on the screen at the end of the test. On a black and white monitor the test displays full screens of increasing intensity.

Use the following procedure to start the display test.

1. Enter SET-UP mode.
2. Set the self-test SET-UP feature for selection 4 (ST4).
3. Exit SET-UP mode by pressing **SET-UP**. This starts the test.

An error in this test occurs if one of the display screens does not appear. If this happens the monitor attached to the GIGI terminal may have failed. Proceed with the color bar test.

To clear the screen, reset the terminal.

### Color Bar Test

This test displays a color bar/gray scale pattern on the monitor screen for approximately 0.5 seconds. The color bar/gray scale pattern consists of eight equally spaced vertical bars. On a color monitor the bars appear from left to right in the following order.

black blue red magenta green cyan yellow white

On a black and white (monochrome) monitor the bars appear as different shades of gray. The bars start with a black bar on the left side of the screen and increase in intensity to a white bar on the right side.

Use the following procedure to start the color bar test.

1. Enter SET-UP mode.
2. Set the self-test SET-UP feature for selection 5 (ST5).
3. Exit SET-UP mode by pressing **SET-UP**. This starts the test.

An error in this test occurs if the color bar/gray scale pattern does not appear on the screen or a portion of the pattern is missing. Either error condition may indicate that the attached monitor has failed, the video cable is not connected properly, or the GIGI terminal contains an error. If you suspect the terminal has failed, connect it to a different monitor and perform both the display and color bar/gray scale tests. If the same symptoms are present the second time, the terminal has probably failed.

To clear the screen, reset the terminal.

### Screen Alignment Pattern

This test fills the monitor screen with a crosshatch pattern. The crosshatch pattern allows a service technician to adjust the monitor connected to the GIGI terminal.

Use the following procedure to play the screen alignment pattern on the screen.

1. Enter SET-UP mode.
2. Set the self-test SET-UP feature for selection 4 (ST4).
3. Exit SET-UP mode by pressing **SET-UP**. This starts the display test. At the end of the display test, the screen alignment pattern remains on the screen.

To clear the screen, reset the terminal.

### Error Codes

---

There are two major types of errors – fatal and nonfatal.

Fatal errors cause the terminal to immediately stop all operations. No intelligible information appears on the monitor screen. The monitor most likely contains a random pattern. The only error indication (in addition to the random pattern) is an error code displayed on the keyboard LED indicators.

The fatal error code displayed on the keyboard LEDs consists of two different messages – an error code and a data code. The error code lights the LOCAL indicator and displays a code in the BASIC, HARDCOPY, L1, and L2 indicators. The data code lights the ON LINE indicator and displays a code in the BASIC, HARDCOPY, L1, and L2 indicators. The GIGI terminal alternates between each message about every 0.25 seconds.

Table 5-1 shows the possible fatal error codes.

Nonfatal errors do not halt the terminal processor. Instead, the terminal displays an error code on the keyboard LEDs and in the center of the screen. If a nonfatal error occurs, you can still use the terminal. In this case the terminal remains in the online or local mode with the appropriate indicator lit. The error is indicated by any of the BASIC, HARDCOPY, L1, or L2 indicators blinking. An example of this is a keyboard error. If the self-test detects a keyboard error, the L2 indicator blinks and the message KB ERR appears on the screen.

Table 5-2 lists all of the nonfatal error codes the terminal can display and what they mean to the terminal.

WHAT TO DO IN THE EVENT OF A PROBLEM

**Table 5-1 Fatal Error Codes**

ON LINE	LOCAL	LED Error Code		HARD-COPY	L1	L2	Error Code Meaning
		NO SCROLL	BASIC				
-	X	0	0	0	0	0	Microprocessor error
X	-	0	X	X	X	X	Data code
-	X	0	0	0	0	X	ROM error
X	-	0	0	?	?	?	Data code
-	X	0	0	0	X	0	RAM error
X	-	0	0	?	?	?	Data code
-	X	0	0	0	X	X	CRT controller error
X	-	0	X	X	X	X	Data code
-	X	0	0	X	0	0	CRT controller time-out
X	-	0	X	X	X	X	Data code
-	X	0	0	X	0	X	Vector time-out error
X	-	0	X	X	X	X	Data code

X = On, 0 = Off, ? = Variable Condition

**Table 5-2 Nonfatal Error Codes**

LED Error Code		HARD-COPY	L1	L2	Screen Code	Error Code Meaning
NO SCROLL	BASIC					
0	0	0	0	B	KB Err	Keyboard error
0	0	0	B	0	IC Err	Internal communications control signal error
0	0	0	B	0	ID Err	Internal communications data loopback error
0	0	0	B	0	IT Err	Internal communications time-out error
0	0	0	B	0	EC Err	External communications control signal error
0	0	0	B	0	ED Err	External communications data loopback error
0	0	0	B	0	ET Err	External communications time-out error
0	0	0	0	0	EM Err	External communications modem signal error
0	0	0	B	0	HC Err	Hardcopy communications control signal error
0	0	0	B	0	HD Err	Hardcopy communications data loopback error
0	0	0	B	0	HT Err	Hardcopy communications time-out error
0	0	0	B	B	KC Err	Keyboard and internal communications control signal error
0	0	0	B	B	KD Err	Keyboard and internal communications data loopback error
0	0	0	B	B	KT Err	Keyboard and internal communications time-out error
0	0	B	0	0	none	Vector generator error

X = On, 0 = Off, B = Blinking

WHAT TO DO IN THE EVENT OF A PROBLEM

**Table 5-2 Nonfatal Error Codes (Cont.)**

LED Error Code						
NO	BASIC	HARD-COPY	L1	L2	Screen Code	Error Code Meaning
0	0	B	0	B	KB Err	Vector generator and keyboard error
0	0	B	B	0	IC Err	Vector generator and internal communications control signal error
0	0	B	B	0	ID Err	Vector generator and internal communications data loopback error
0	0	B	B	0	IT Err	Vector generator and internal communications time-out error
0	0	B	B	B	KC Err	Vector generator, keyboard, and communications control signal error
0	0	B	B	B	KD Err	Vector generator, keyboard, and internal communications data loopback error
0	0	B	B	B	KT Err	Vector generator, keyboard, and internal communications time-out error
0	B	0	0	0	none	Video RAM error
0	B	0	0	B	KB Err	Video RAM and keyboard error
0	B	0	B	0	IC Err	Video RAM and internal communications control signal error
0	B	0	B	0	ID Err	Video RAM and internal communications data loopback error
0	B	0	B	0	IT Err	Video RAM and internal communications time-out error
0	B	0	B	B	KC Err	Video RAM, keyboard, and internal communications control signal error
0	B	0	B	B	KD Err	Video RAM, keyboard, and internal communications data loopback error
0	B	0	B	B	KT Err	Video RAM, keyboard, and internal communications time-out error
0	B	B	0	0	none	Video RAM and vector generator error
0	B	B	0	B	KB Err	Video RAM, vector generator, and keyboard error
0	B	B	B	0	IC Err	Video RAM, vector generator, and internal communications control signal error
0	B	B	B	0	ID Err	Video RAM, vector generator, and internal communications data loopback error
0	B	B	B	0	IT Err	Video RAM, vector generator and internal communications time-out error
0	B	B	B	B	KC Err	Video RAM, vector generator, keyboard, and communications control signal error
0	B	B	B	B	KD Err	Video RAM, vector generator, keyboard, and internal communications data loopback error
0	B	B	B	B	KT Err	Video RAM, vector generator, keyboard, and internal communications time-out error

X = On, 0 = Off, B = Blinking



**COMMON PROBLEMS**

This section outlines some common problems you may encounter with the GIGI terminal. If you suspect a problem in the terminal, you should initiate the power-up self-test procedure. This test helps you determine if the problem lies in your terminal or in some other part of the computer system.

Table 5-3 describes many items you can check prior to making a service call. The first column lists problem symptoms; the second column lists a series of possible causes for each symptom, and some easy-to-do steps that may correct the problem.

**Table 5-3 Problem Checklist**

Symptom	Possible Cause/Corrective Action
GIGI terminal does not turn on when the power switch is turned on	AC power cord is not plugged into wall outlet. Plug in cord. AC power cord is not plugged into terminal. Plug in cord. Power is not coming from the wall outlet. Check outlet with a known good electrical device (such as a lamp). If no power, call your electrician. AC line fuse blown. Turn power switch off and have the fuse replaced. (See Figure 3-1 for location.)
No keyboard response Garbled or error characters	Perform the self-test operation. Incorrect SET-UP feature selection. Correct the SET-UP features. Suggested SET-UP features which may be in error: Parity (PE) Receive speed (RS) Transmit speed (TS) ANSI/VT52 mode (TM) AUTO XON/XOFF (XO)
Characters not displayed on the monitor	Perform the self-test operation. The monitor is not turned on. Turn the power on. The monitor brightness is too low. Increase the brightness setting. The monitor is not connected to the GIGI terminal. Connect the monitor.
Wrong color displayed on a color monitor	Perform the self-test operation. The cables between the GIGI terminal and the monitor are not connected correctly. Reconnect the cables. One of the cables between the GIGI terminal and the monitor is broken. Replace the cable.
Printer does not copy screen	Perform the self-test operation. The printer is out of paper or not ready. Check the printer. The printer is not connected to the GIGI terminal correctly. Reconnect the printer. Perform the self-test operation.

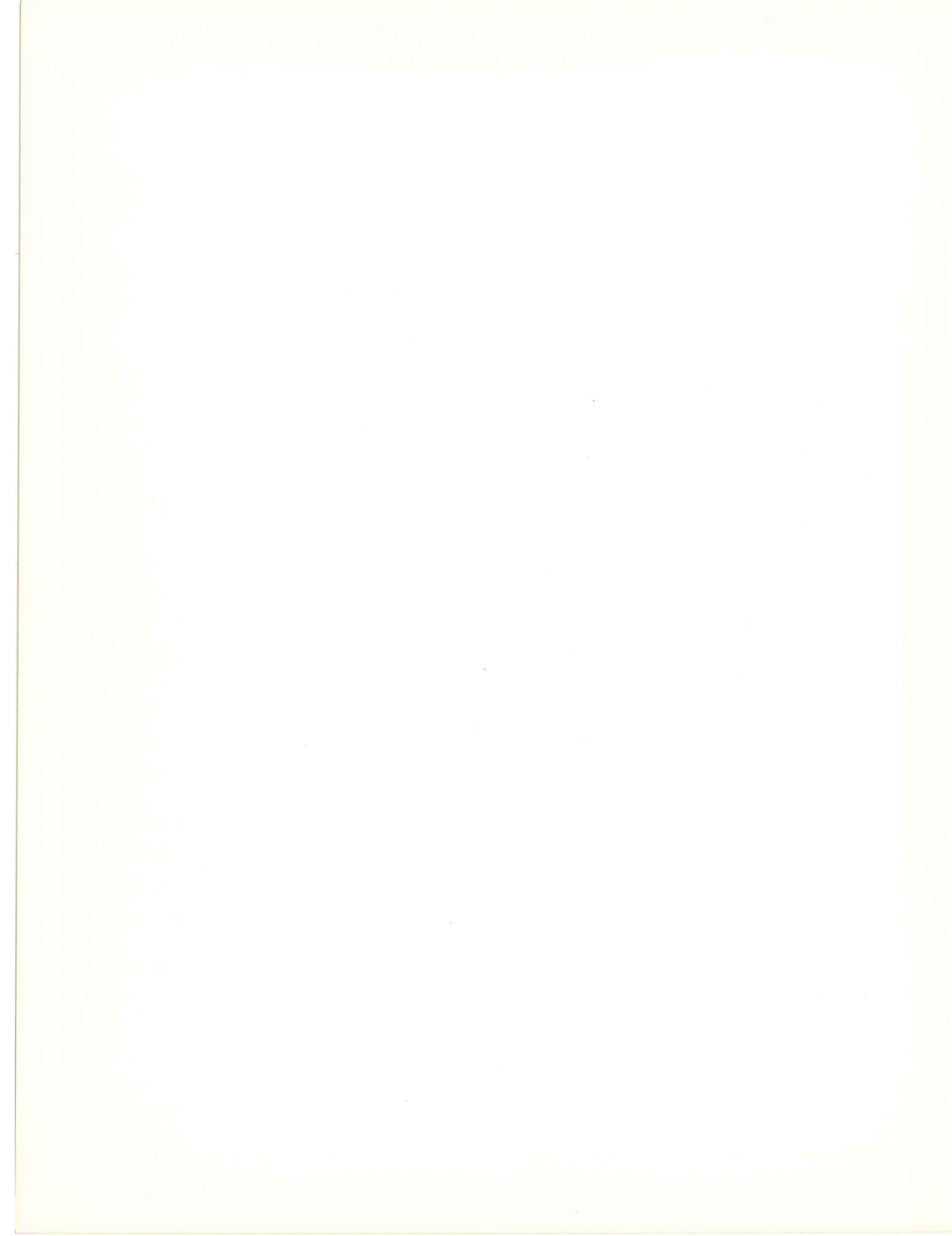

# How to Get Your Terminal Repaired

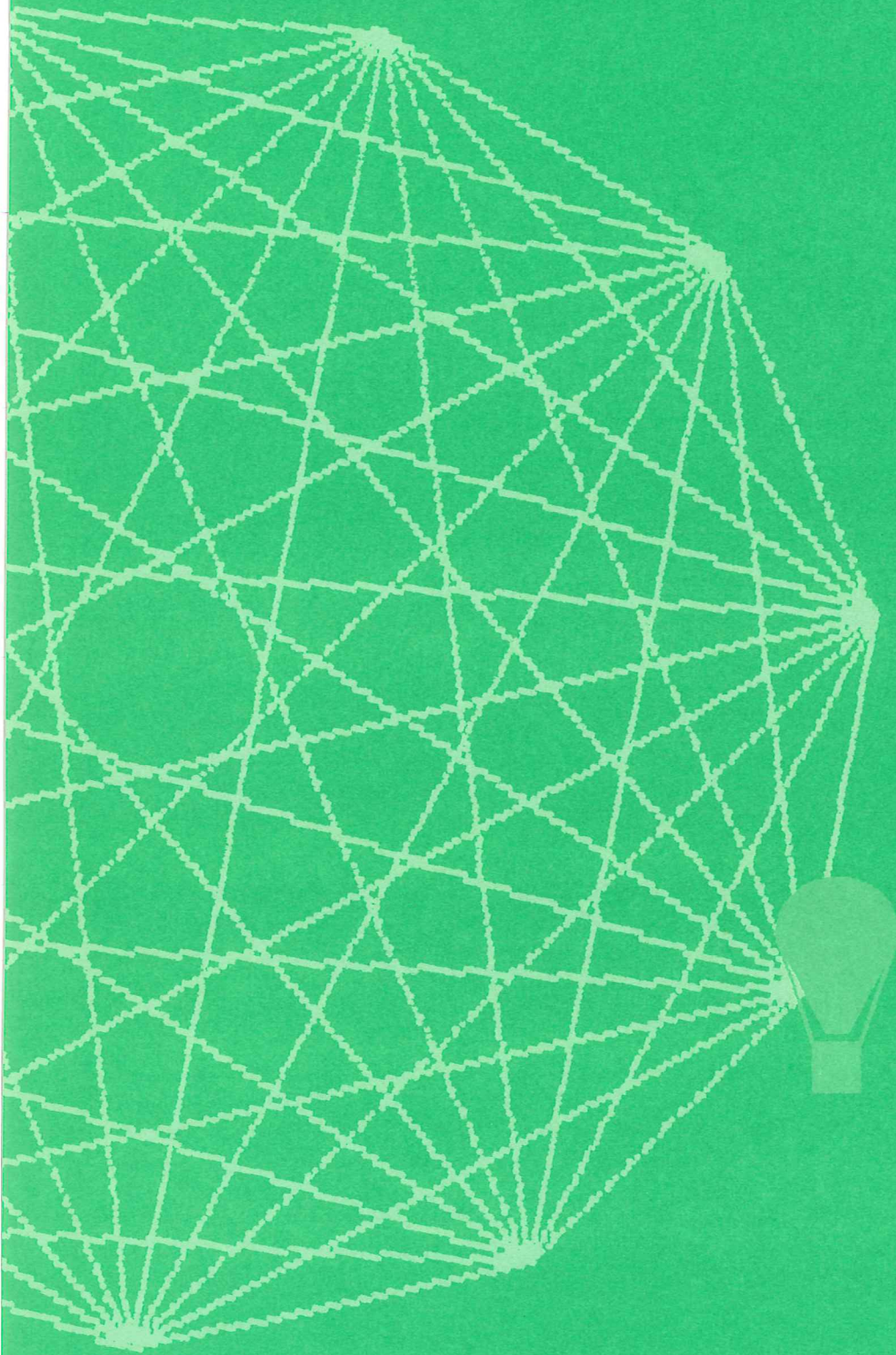

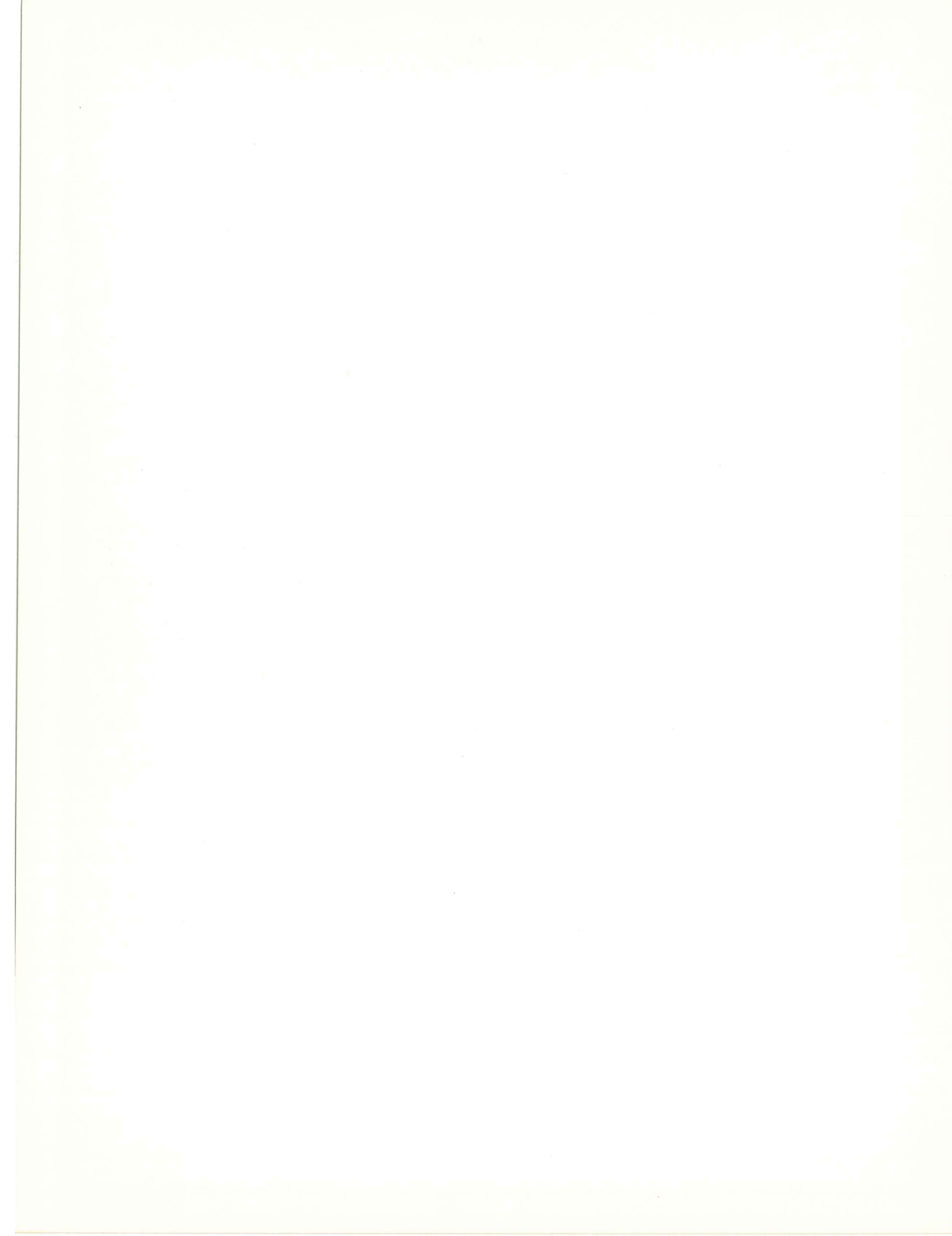

# 6

## HOW TO GET YOUR TERMINAL REPAIRED

### INTRODUCTION

---

This chapter provides all of the information you, the customer, need to have your GIGI terminal repaired should it fail. This includes basic warranty information, how to obtain warranty repairs, how to obtain service under the Return to DIGITAL Servicenter Maintenance Agreement, and a complete list of DIGITAL Servicenters.

### PRODUCT WARRANTY

---

The GIGI terminal is under warranty against any defects in workmanship or material for a period of ninety (90) days. The warranty period is for the 90 days following the arrival of the GIGI terminal at your site or for the 120 days following the terminal shipment from DIGITAL, whichever comes first.

### WARRANTY REPAIRS

---

You must perform the following procedure to have the terminal repaired under warranty.

1. Verify that the terminal has failed by performing the extensive self-tests outlined in Chapter 5. If you are still not sure that the terminal has failed after running the tests, swap the GIGI terminal with another one. If the symptoms remain, then the terminal is probably good and the failure is in some other part of the system.
2. If you determine from step 1 that the GIGI terminal is defective, call your nearest authorized DIGITAL Servicenter to obtain a return authorization (RA) number. (A complete list of DIGITAL Servicenters appears at the end of this chapter.) When you call for the RA number, have the following information readily available.
  - a. Terminal model number (VK100 AA or VK100 AB) and terminal serial number. This information is on the rear of the terminal.
  - b. A description of the problem. Include all the error codes displayed when the internal tests were run.
  - c. Any warranty verification requested.
  - d. The number of units being returned.

When the DIGITAL Servicenter gives you the RA number, they will tell you the best way to ship the terminal.

Note the RA number. If you have any questions concerning the terminal while it is being repaired, the RA number will help to speed the process.

3. Pack the terminal in an authorized shipping container. Follow the repacking instructions in Chapter 2. The shipping container should have the following items.
  - GIGI terminal
  - Terminal power cord
  - Video cable
  - Written description of the problem
  - Complete return address, including the name of a contact person to whom the terminal can be returned

Mark the RA number on the outside of the shipping container and on all paperwork sent with the terminal.

The only authorized shipping container for the GIGI terminal is the one in which the terminal was originally shipped. If you cannot locate an original shipping container, you can purchase one from the DIGITAL Servicenter.

If you return the GIGI terminal to DIGITAL in any container other than an authorized shipping container, DIGITAL will replace the shipping container and bill you for its cost.

4. Return the GIGI terminal to the designated DIGITAL Servicenter, transportation prepaid. The transportation charges for the return of the repaired unit are paid by DIGITAL, and the unit is shipped in the same mode used by the customer.

If DIGITAL determines that the equipment returned to it for warranty repair is not defective as herein defined, you will be invoiced by DIGITAL for all costs of handling and transportation.

All units repaired are under warranty for a period of thirty (30) days after the date of return shipment or for the remaining warranty period, whichever is longer.

The warranty is void if one of the following conditions occur.

1. The terminal is misused in any way.
2. The terminal is modified in any way.

## DIGITAL MAINTENANCE SERVICE REPAIRS

The primary maintenance service offered by DIGITAL for the GIGI terminal is the Return to DIGITAL Servicenter Maintenance Agreement. If your GIGI is covered under an agreement, please use the following procedure. If not, contact your DIGITAL account salesperson or your local DIGITAL Field Service office.

To have the terminal repaired under the Return to DIGITAL Servicenter Maintenance Agreement, you must perform this procedure.

1. Verify that the terminal has failed by performing the extensive self-tests outlined in Chapter 5. If you are still not sure that the terminal has failed after running the tests, swap the GIGI terminal with another one. If the symptoms remain, then the terminal is probably good and the failure is in some other part of the system.
2. If you determine from step 1 that the GIGI terminal is defective, call your nearest DIGITAL Servicenter to obtain a return authorization (RA) number. (A complete list of DIGITAL Servicenters appears at the end of this chapter.) When you call for the RA number, have the following information readily available.
  - a. Terminal model number (VK100 AA or VK100 AB) and terminal serial number. This information is on the rear of the terminal.
  - b. A description of the problem. Include all the error codes displayed when the internal tests were run.

When the DIGITAL Servicenter gives you the RA number, they will tell you the best way to ship the terminal.

Note the RA number. If you have any questions concerning the terminal while it is being repaired, the RA number will help to speed the process.

3. Pack the terminal in an authorized shipping container. Follow the repacking instructions in Chapter 2. The shipping container should have the following items.

- GIGI terminal
- Terminal power cord
- Video cable
- Written description of the problem
- Complete return address, including the name of a contact person to whom the terminal can be returned

Mark the RA number on the outside of the shipping container and on all paperwork sent with the terminal.

The only authorized shipping container for the GIGI terminal is the one in which the terminal was originally shipped. If you cannot locate an original shipping container, you can purchase one from the DIGITAL Servicenter.

If you return the GIGI terminal to DIGITAL in any container other than an authorized shipping container, DIGITAL will replace the shipping container and bill you for its cost.

4. Return the GIGI terminal to the designated DIGITAL Servicenter, transportation prepaid. The transportation charges for the return of the repaired unit are paid by DIGITAL, and the unit is shipped in the same mode used by the customer.

### On-Site Service Agreements

---

DIGITAL on-site contract service may also be available for the GIGI terminal. For more information on the customer services available, contact your DIGITAL account salesperson or your local DIGITAL Field Service office.

### DIGITAL Servicenters

---

DIGITAL Servicenters are located around the world. The following list provides the address and telephone number(s) for each Servicenter.

#### United States

Digital Equipment Corporation  
Servicenter  
1207 East Remington Road  
Schaumburg, Illinois 60195  
Telephone: (312) 640-2202  
(312) 640-2217

Digital Equipment Corporation  
Servicenter  
U.S. Route 1, CN-2  
Princeton, New Jersey 08540  
Telephone: (609) 452-2940

Digital Equipment Corporation  
Servicenter  
3390 Harbor Boulevard  
Costa Mesa, California 92626  
Telephone: (714) 979-2460

**England**

Digital Equipment Co., Ltd.  
Servicenter  
V7 Building, ABL Site  
Gasworks Road  
G-B Reading, Berkshire RG1 3EF  
England  
Telephone: 583555

**Belgium**

Digital Equipment N.V.S.A.  
Servicenter  
Rue De La Fusee 60  
B-1140 Brussels  
Belgium  
Telephone: 733-96-50

**Holland**

Digital Equipment B.V.  
Servicenter  
Colorado Dreef 26-28  
P.O. Box 9064  
NL-3563 VA Utrecht  
Holland  
Telephone: 611814

**Australia**

Digital Equipment Australia Pty., Ltd.  
Servicenter  
10-12 West Street  
Pymble, New South Wales 2073  
Australia  
Telephone: 4393598

**New Zealand**

Digital Equipment New Zealand Ltd.  
Servicenter  
Greenlane, Auckland 5  
New Zealand  
Telephone: 591-289

**Canada**

Digital Equipment of Canada Ltd.  
Servicenter  
100 Herzberg Road  
Kanata, Ontario, Canada  
K2K 2A6  
Telephone: (613) 592-5111 ext.2530



# Programming Summary

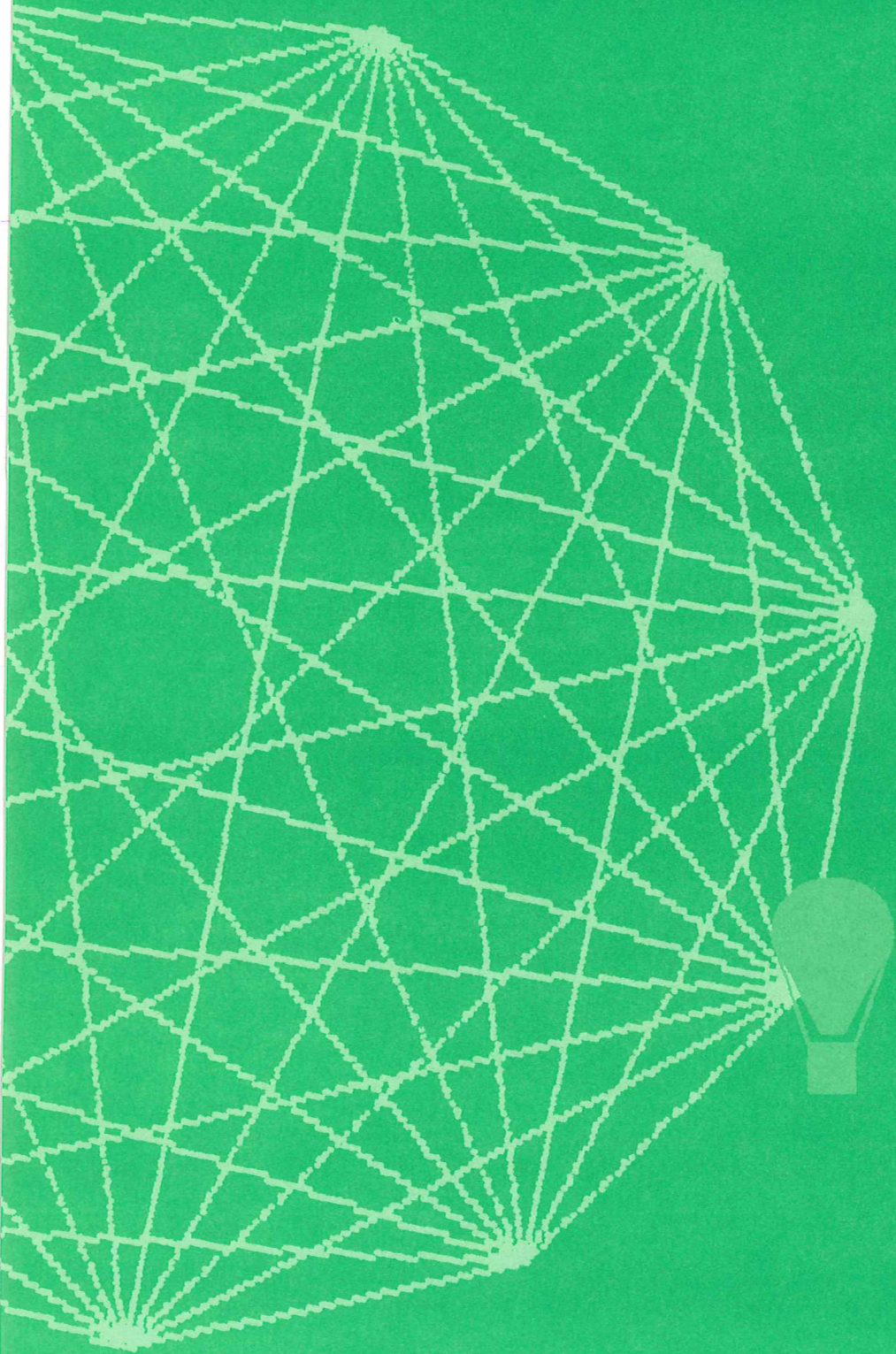

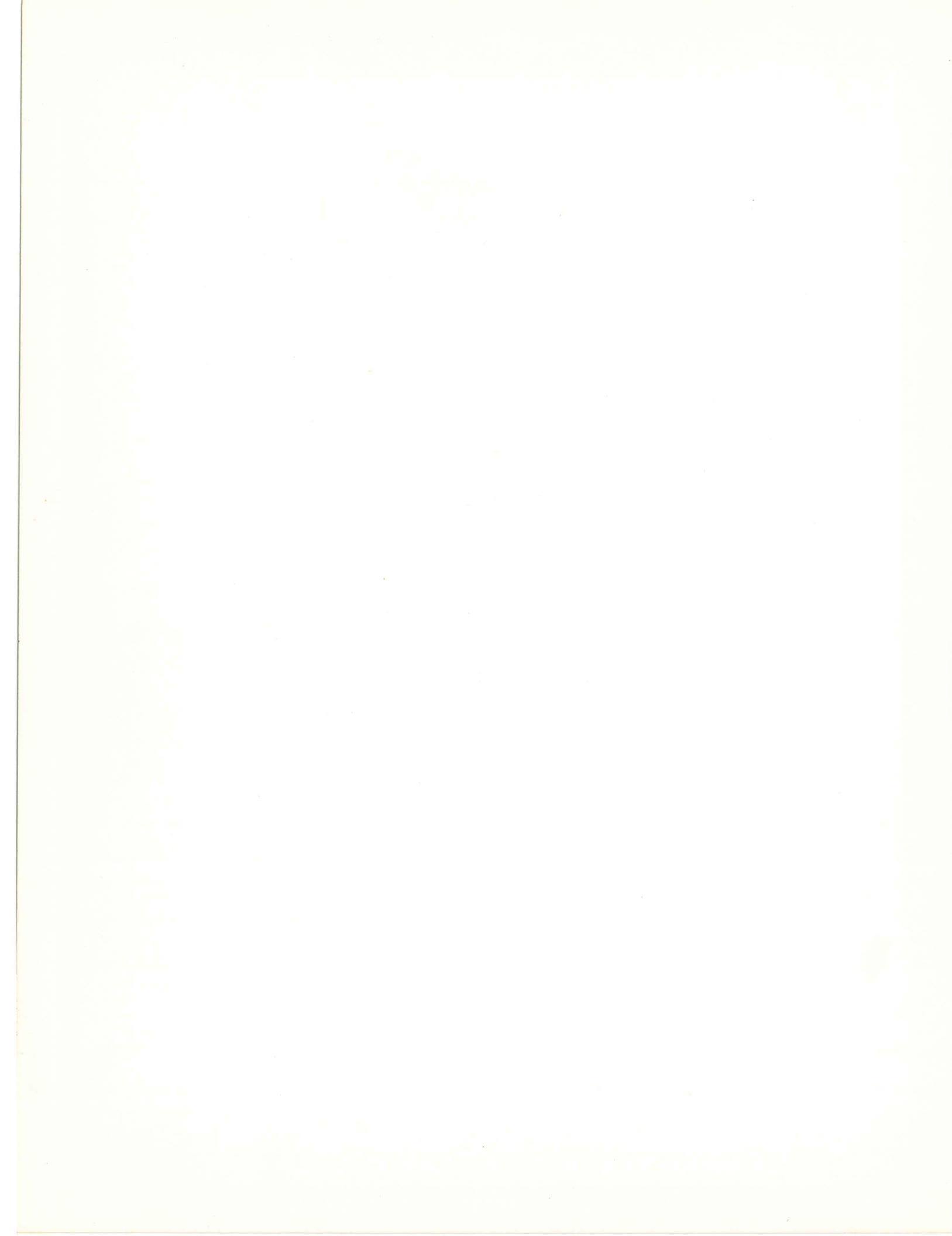

# 7

## PROGRAMMING SUMMARY

### INTRODUCTION

This chapter summarizes the programming characteristics of the GIGI terminal. The summary covers the following topics.

- Codes generated by the keyboard
- Character sets
- Terminal actions to control sequences in both the ANSI and VT52 modes
- ReGIS command structure
- BASIC command structure

### KEYBOARD CODES

The following paragraphs describe the codes generated by the GIGI terminal keyboard.

#### Standard Key Codes

The GIGI terminal keyboard resembles a standard office typewriter. In addition to the standard typewriter keys, the terminal has keys to generate control functions and cursor control commands. Figure 7-1 shows the GIGI terminal keyboard layout and the ASCII codes generated by each key.

FIGURE 7-1 Keyboard-Generated ASCII Codes

Octal Codes Generated by Keyboard (Shifted Codes Shown Above Legends: Unshifted Codes Shown Below Legends)															
033 ESC 033	041 1 ! 061	100 2 @ 062	043 3 # 063	044 4 \$ 064	045 5 % 065	136 6 ^ 066	046 7 & 067	052 8 * 070	050 9 ( ) 071	051 0 ) 060	137 - = 055	153 = + 075	176 \ ~ 140	010 BACK SPACE 010	
011 TAB 011	121 Q 161	127 W 167	105 E 145	122 R 162	124 T 164	131 Y 171	125 U 165	111 I 151	117 O 157	120 P 160	173     133	175     135		177 DELETE 177	
		101 A 141	123 S 163	104 D 144	106 F 146	107 G 147	110 H 150	112 J 152	113 K 153	114 L 154	072 : ; 073	042 " " 047	015 RETURN 015	174 \   134	
		132 Z 172	130 X 170	103 C 143	126 V 166	102 B 142	116 N 156	115 M 155	074 . < 054	076 > . 056	077 / ? 057		012 LINE FEED 012		

MA3386

#### Cursor Control Key Codes

The GIGI terminal's main keyboard contains four cursor control keys. Table 7-1 lists all the possible codes generated by these keys. You select the ANSI/VT52 mode with the terminal mode (TM) SET-UP feature, and the cursor key application mode with the set mode (SM) and reset mode (RM) control functions.

#### Auxiliary Keypad Codes

The GIGI terminal contains an auxiliary or numeric keypad to the right of the main keyboard. Table 7-2 shows all the possible codes generated by the numeric keys. Table 7-3 shows all the possible codes generated by the program function (PF) keys. You select the ANSI/VT52 mode with the terminal mode (TM) SET-UP feature, and the keypad applications mode with the set mode (SM) and reset mode (RM) control functions.

**Table 7-1 Cursor Control Key Codes**

Cursor Key (Arrow)	VT52 Mode	ANSI Mode/Cursor Key Mode Reset	ANSI Mode/Cursor Key Mode Set (Application)
Up	ESC A	ESC [ A	ESC O A
Down	ESC B	ESC [ B	ESC O B
Right	ESC C	ESC [ C	ESC O C
Left	ESC D	ESC [ D	ESC O D

**Table 7-2 Auxiliary Keypad Numeric Key Codes**

Key	Keypad Numeric Mode	Keypad Application Mode	
		ANSI	VT52
0	0	ESC O p	ESC ? p
1	1	ESC O q	ESC ? q
2	2	ESC O r	ESC ? r
3	3	ESC O s	ESC ? s
4	4	ESC O t	ESC ? t
5	5	ESC O u	ESC ? u
6	6	ESC O v	ESC ? v
7	7	ESC O w	ESC ? w
8	8	ESC O x	ESC ? x
9	9	ESC O y	ESC ? y
—	—	ESC O m	ESC ? m
,	,	ESC O l	ESC ? l
.	.	ESC O n	ESC ? n
ENTER	Same as RETURN	ESC O M	ESC ? M

**Table 7-3 Auxiliary Keypad PF Key Codes**

Key	Keypad Numeric Mode/ Keypad Application Mode	
	ANSI	VT52
PF1/HARDCOPY	ESC O P	ESC ? P
PF2/LOCTR	ESC O Q	ESC ? Q
PF3/TEXT	ESC O R	ESC ? R
PF4/RESET	ESC O S	ESC ? S

### Control Characters

The GIGI terminal generates and supports certain control characters. Figure 7-2 shows the control characters generated by the terminal keyboard. Table 7-4 lists the control characters supported by the GIGI terminal, and the action the terminal takes when it receives each control character. The terminal ignores control characters that it does not support.

PROGRAMMING SUMMARY

FIGURE 7-2 Keyboard-Generated Control Codes

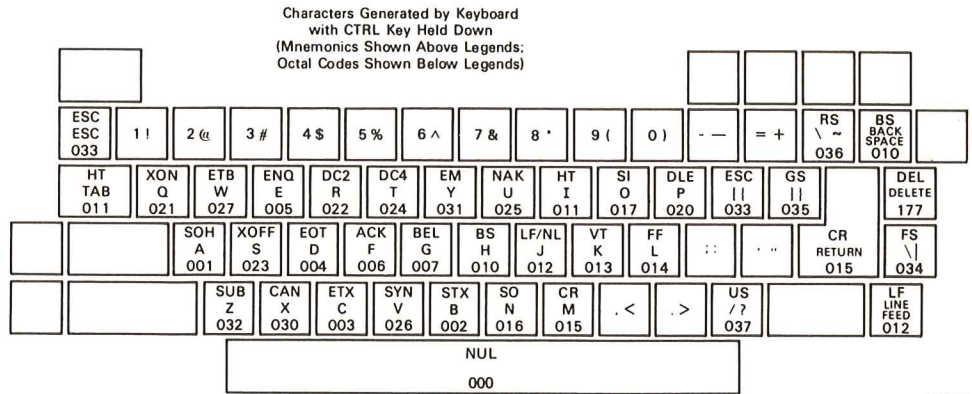

MA3387

Table 7-4 Terminal-Supported Control Character Functions

Control Code	Octal Code	Terminal Action
BEL	007	Ring the terminal bell.
BS	010	Backspace the cursor by one position; if at left margin, then no operation.
HT	011	Horizontal tab; move the cursor to next fixed tab position (fixed at eight character intervals). The cursor will not move if right margin is reached.
LF	012	Line feed; move cursor to next line down. If at bottom margin, the cursor position remains unchanged. If new line mode is enabled, perform carriage return function.
FF	014	Form feed; clear screen and move cursor to home position (upper left corner).
CR	015	Carriage return; move cursor to left margin.
SO	016	Shift out; invoke G1 character set.
SI	017	Shift in; invoke G0 character set.
DC1(XON)	021	Allows terminal to resume transmitting.
DC3(XOFF)	023	Causes terminal to stop transmitting all characters except XOFF and XON.
CAN	030	If sent during an escape sequence, the sequence is immediately terminated and not executed. Causes the error character ( ) to be displayed.
SUB	032	Same effect as CAN.
ESC	033	Subsequent character(s) are interpreted as part of an escape sequence.

## CHARACTER SETS

The GIGI terminal can contain up to five character sets.

1. United Kingdom (UK)
2. United States (USASCII)
3. Soft character set 1
4. Soft character set 2
5. Soft character set 3

The soft character sets 1 through 3 are the same character sets referenced in the ReGIS mode of operation. You can select the contents of these character sets to meet your specific requirements. The character sets are loaded by using the ReGIS L command. (See the ReGIS command summary contained in this chapter.)

Using multiple character sets in the GIGI terminal is a simple, two-step operation. You must define the active character sets and select one of those sets for use.

From these five character sets you should select one or two active character sets. This is done with the select character set (SCS) control sequence. The SCS control sequence defines the active character sets as G0 and G1. Table 7-5 summarizes the SCS control sequences. It lists the exact sequence needed to define any character set as G0 or G1.

**Table 7-5 Select Character Set Sequences**

Character Set	G0	G1
UK	ESC ( A	ESC ) A
US ASCII	ESC ( B	ESC ) B
Soft Set 1	ESC ( 0	ESC ) 0
Soft Set 2	ESC ( 1	ESC ) 1
Soft Set 3	ESC ( 2	ESC ) 2

The shift in (SI) and shift out (SO) control characters select the actual character set used. When the terminal receives the shift in (SI, 017g) control character, the character set defined as G0 by the SCS control sequence becomes the active character set. The shift out (SO, 016g) control character activates the character set defined as G1 by the SCS control sequence. The following examples show how the multiple character sets are used.

**Example 1.** You want to use the United States character set and soft character set 3 in the terminal. To select these two character sets as the active character sets, the host computer sends the following control sequences to the terminal.

ESC ( B To define the United States character set as G0  
 ESC ) 2 To define soft character set 3 as G1

The shift in and shift out control characters then control the selection of the active character sets. Shift in (SI, 017g) selects the US character set and shift out (SO, 016g) selects soft character set 3.

**Example 2.** You want to use soft character set 1 and the United States character set in the terminal. To define these two character sets as the active character sets, the host computer sends the following control sequences to the terminal.

ESC ( 0 To define soft character set 1 as G0

ESC ) B To define the United States character set as G1

The shift in and shift out control characters then control the selection of the active character set. Shift in (SI, 017<sub>8</sub>) selects soft character set 1, and shift out (SO, 016<sub>8</sub>) selects the US character set.

As the two examples show, you can define any character set as G0 and any other character set as G1. In those cases where you use only one character set, you can define it as both G0 and G1.

At either power-up or master reset, the terminal defines the default character set as both G0 and G1. The default SET-UP switch pack selects the specific default character set. See Chapter 2 for information on changing the default character set.

## CONTROL FUNCTIONS

The GIGI terminal is an upward and downward software compatible terminal. Previous DIGITAL terminals have DIGITAL private standards for control sequences. The American National Standards Institute (ANSI) has since standardized control sequences in terminals. The GIGI terminal is compatible with both the previous DIGITAL standards and current ANSI standards.

**Note:** The ANSI standards allow the manufacturer flexibility in implementing each function. This manual describes how the GIGI terminal responds to the implemented ANSI control functions.

Customers may use existing DIGITAL software designed around the VT52, or new GIGI terminal software designed to meet ANSI standards. The GIGI terminal has a "VT52 compatible" mode in which the GIGI terminal responds to control sequences like a VT52. In this mode, you cannot use many GIGI terminal features.

Throughout this chapter references are made to "VT52 mode" or "ANSI mode". These two terms indicate the GIGI terminal's software compatibility. All new software should be designed around the GIGI terminal's ANSI mode. The VT52 mode is included only to provide continuity for existing operating systems support.

The following paragraphs briefly summarize the control sequences implemented by the GIGI terminal. See the reference documents listed in Chapter 9 for more information.

The following ANSI standards were used in implementing the GIGI terminal.

X3.16-1976	Character Structure and Character Parity Sense
X3.4-1977	USA Standard Code for Information Interchange (ASCII)
X3.41-1974	Code Extension Techniques for Use with ASCII
X3.64-1977	Addition Controls for Use with ASCII

The GIGI terminal implements a subset of these standards.

In the list of control functions in this chapter, the characters are shown using the ASCII character set. The case (upper or lower) of the characters sent is significant and must be sent exactly as documented. These characters are spaced apart for clarity only. The SPACE character (040<sub>8</sub>) never appears in any of the GIGI terminal's recognizable control or escape sequences. The ESCAPE character (033<sub>8</sub>) is defined as **ESC**. All graphics characters shown in color are integral to the control or escape sequence. Characters printed in black indicate variable parameters (Ps and Pn) or a possible sequence of parameters (...). Where a variable parameter is indicated, the possible values appear immediately after the sequence.

### ANSI Mode Definitions

---

The following list defines the basic elements of the ANSI mode control sequences.

#### Control Sequence Introducer (CSI)

This escape sequence provides supplementary controls and is itself a prefix affecting the interpretation of a limited number of contiguous characters. In the GIGI terminal the CSI is ESC [.

#### Parameter

- (1) A string of zero or more digits which represent a single value. Leading zeros are ignored. The decimal digits have a range of 0 (060<sub>8</sub>) to 9 (071<sub>8</sub>).
- (2) The value so represented.

#### Numeric Parameter (Pn)

A parameter that represents a decimal number, expressed as a string of ASCII digits.

#### Selective Parameter (Ps)

A string of characters that selects a subfunction from a specified list of subfunctions. In general, a control sequence with more than one selective parameter causes the same effect as several control sequences, each with one selective parameter. For example, CSI Psa; Psb; Psc F is identical to CSI Psa F CSI Psb F CSI Psc F.

#### Parameter String

A string of characters separated by a semicolon (073<sub>8</sub>).

#### Default

A function-dependent value that the system assumes when no explicit value, or a value of 0, is specified.

#### Final Character

A character whose bit combination terminates an escape or control sequence.



PROGRAMMING SUMMARY

**Example 1.** Control sequence prints the display image.

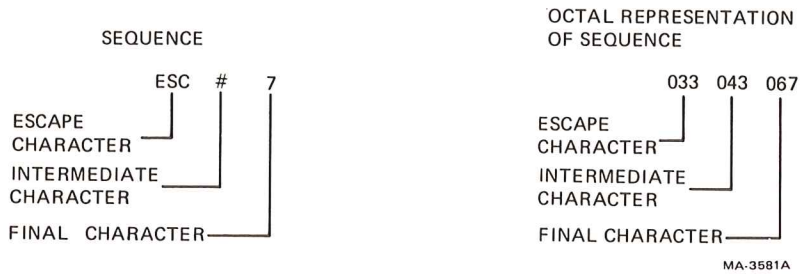

**Example 2.** Control sequence turns off all character attributes and then turns on the underscore and blink attributes (SGR).

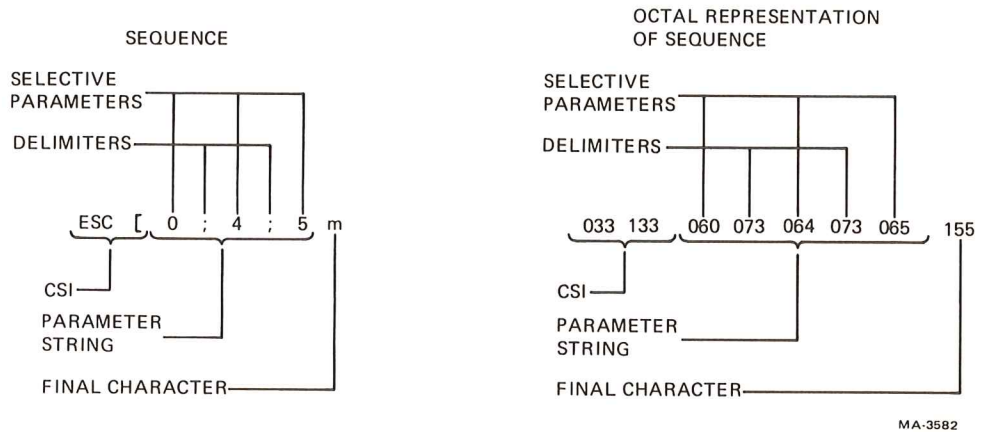

The following alternate sequences accomplish the same function.

Sequence	Octal Representation of Sequence
<b>ESC [ ; 4 ; 5 m</b>	033 133 073 064 073 065 155
<b>ESC [ m</b>	033 133 155
<b>ESC [ 4 m</b>	033 133 064 155
<b>ESC [ 5 m</b>	033 133 065 155
<b>ESC [ 0 ; 0 4 ; 0 0 5 m</b>	033 133 060 073 060 064 073 060 060 065 155

## ANSI Control Functions Summary

The following escape and control sequences are transmitted from the host computer to the GIGI terminal unless otherwise noted. The control sequences are listed according to the generic function they perform.

### Cursor Movement Commands

Sequence	Function
<b>ESC [ Pn A *</b>	Cursor up
<b>ESC [ Pn B *</b>	Cursor down
<b>ESC [ Pn C *</b>	Cursor forward (right)
<b>ESC [ Pn D *</b>	Cursor backward (left)
<b>ESC [ Pl ; Pc H †</b>	Direct cursor addressing
<b>ESC [ Pl ; Pc f</b>	
<b>ESC D</b>	Index
<b>ESC E</b>	New line
<b>ESC M</b>	Reverse index
<b>ESC 7</b>	Save cursor and attributes
<b>ESC 8</b>	Restore cursor and attributes

\* Pn is a decimal number expressed as a string of ASCII digits. Multiple parameters are separated by the semicolon character (073g). If a parameter is omitted or specified as 0, the default parameter value is used. For the cursor movement commands, the default parameter value is 1.

† Pl equals the line number; Pc equals the column number.

### Character Attributes

#### **ESC [ Ps ; Ps; Ps ;...; Ps m**

Ps is a selective parameter. Multiple parameters are separated by the semicolon character (073g). The parameters execute in order and have the following functions.

Parameter	Function
0 or none	Exit graphic mode and select writing color (same as <b>SHIFT/PF3</b> )
2	Half bright (or green)
4	Underscore on
5	Blink on
7	Reverse video on
30	Black
31	Red
32	Green
33	Yellow
34	Blue
35	Magenta
36	Cyan
37	White

} writing colors

Parameter	Function	
40	Black	} screen colors
41	Red	
42	Green	
43	Yellow	
44	Blue	
45	Magenta	
46	Cyan	
47	White	

Any other parameter values are ignored.

### Erasing Commands

Sequence	Function
<b>ESC [ K</b> or <b>ESC [ 0 K</b>	From cursor to end of line
<b>ESC [ 1 K</b>	From beginning of line to cursor
<b>ESC [ 2 K</b>	Entire line containing cursor
<b>ESC [ J</b> or <b>ESC [ 0 J</b>	From cursor to end of screen
<b>ESC [ 1 J</b>	From beginning of screen to cursor
<b>ESC [ 2 J</b>	Entire screen

### Programmable LEDs

**ESC [ Ps ; Ps ;...Ps q**

Ps is a selective parameter. Multiple parameters are separated by the semi-colon character (073g). The parameters execute in order and have the following functions.

Parameter	Function
0 or none	all LEDs off
1	LED 1 on
2	LED 2 on

### Select Character Sets

Character Set	Sequence	
	<b>G0</b>	<b>G1</b>
UK	<b>ESC ( A</b>	<b>ESC ) A</b>
US ASCII	<b>ESC ( B</b>	<b>ESC ) B</b>
Soft set 1	<b>ESC ( 0</b>	<b>ESC ) 0</b>
Soft set 2	<b>ESC ( 1</b>	<b>ESC ) 1</b>
Soft set 3	<b>ESC ( 2</b>	<b>ESC ) 2</b>

### Enter Graphics Mode

Sequence	Function
<b>ESC Pp</b>	Enter and remain in graphics mode until next escape sequence
<b>Line Feed (LF)</b>	Enter and remain in graphics mode until next line feed character if gp1 is selected

## Modes

SET-UP parameters are affected by these modes.

SET-UP		To Set		To Reset	
Para	Mode Name	Mode	Sequence	Mode	Sequence
NL	Line Feed/ New Line	New Line	ESC [ 20 h	Line Feed	ESC [ 20 l*
CK	Cursor Key	Appl	ESC [ ? 1 h	Cursor	ESC [ ? 1 l*
TM	ANSI/VT52	ANSI	n/a	VT52	ESC [ ? 2 l*
SM	Scrolling	Smooth	ESC [ ? 4 h	JUMP	ESC [ ? 4 l*
RV	Screen	Reverse	ESC [ ? 5 h	Normal	ESC [ ? 5 l*
AW	Auto Wrap-around	On	ESC [ ? 7 h	Off	ESC [ ? 7 l*
AR	Auto Repeat	On	ESC [ ? 8 h	Off	ESC [ ? 8 l*
OS	Overstrike	On	ESC [ ? 20 h	Off	ESC [ ? 20 l*
BA	Local BASIC	Local	ESC [ ? 21 h	BASIC Off	ESC [ ? 21 l*
BA	Host BASIC	Host	ESC [ ? 22 h	BASIC Off	ESC [ ? 22 l*
PK	Programmed Keypad	Programmed	ESC [ ? 23 h	Normal	ESC [ ? 23 l*
AH	Auto Hardcopy	On	ESC [ ? 24 h	Off	ESC [ ? 24 l*
KP	Keypad	Appl	ESC =	Numeric	ESC >

\* The last character of the sequence is a lowercase l (154g).

## Reports

There are three types of reports with the following escape and control sequences.

### Cursor Position Report

Invoked by: ESC [ 6 n  
Response is: ESC [ Pl ; Pc R

Pl equals the line number; Pc equals the column number.

### Status Report

Invoked by: ESC [ 5 n  
Response is: ESC [ 0 n (terminal ok)

### What Are You

Invoked by: ESC [ c or ESC [ 0 c  
Response is: ESC [ ? 5 ; 0 c or  
ESC [ ? 5 c  
(Meaning: I am GIGI terminal.)

Alternately invoked by ESC Z (not recommended). Response is the same.

### Reset

Invoked by: **ESC c**

Reset executes the reset routine. The SET-UP parameters, BASIC program, and soft character sets are not destroyed. This is the same as pressing **SHIFT** and **PF4**.

### Print Commands

Print display image: **ESC # 7** (same as pressing **SHIFT** and **PF1**.)

Print partial image: **ESC [ Pn ; Pn !q**

Pn is a numeric parameter; these parameters specify start and stop line numbers inclusive.

### Confidence Tests

Generate crosshatch pattern on display: **ESC # 8**

Perform self-tests: **ESC [ 3 ; Pn ; Pn ;...y**

Pn selects the test to be performed as follows.

Pn	Test Selected
1	All power-up tests
2	External communications test
3	Hardcopy communications test
4	Display pattern test
5	Color bar test
9	Repeat selected tests until failure

### Device Control Strings

Sequence	String
<b>ESC P p</b> (host to terminal)	ReGIS data to follow
<b>ESC P r</b> (host to terminal)	SET-UP data to follow
<b>ESC P</b> key ID code <b>s</b>	Auxiliary keypad data to follow (host to terminal)
<b>ESC P q</b> (terminal to printer)	Hardcopy data to follow*
<b>ESC \</b>	String terminator

\* This string is generated by the GIGI terminal and sent to the LA34VA graphics printer. The GIGI terminal does not process the string.

All device control strings must be terminated with a string terminator. For example:

**ESC P r** ... SET-UP data ... **ESC \**

## VT52 Control Functions Summary

Sequence	Function
ESC A	Cursor up
ESC B	Cursor down
ESC C	Cursor right
ESC D	Cursor left
ESC F	Select soft character set 1
ESC G	Select ASCII character set
ESC H	Cursor to home
ESC I	Reverse line feed
ESC J	Erase to end of screen
ESC K	Erase to end of line
ESC Ylc*	Direct cursor address
ESC Z†	Identify
ESC =	Enter alternate keypad mode
ESC >	Exit alternate keypad mode
ESC <	Enter ANSI mode
ESC ]	Dump hardcopy
ESC Pp	Enter graphics mode (ReGIS)
ESC \	Exit graphics mode

\* l equals line number, c equals column number. Line and column numbers for direct cursor address are single character codes whose values equal the desired number plus 378. Line and column numbers start at 1

† Response to ESC Z is ESC / Z. This is not recommended; use What Are You report in ANSI mode.

## ReGIS SUMMARY

The following summary of ReGIS commands serves as a quick reference guide. Refer to the software documentation for more information on any command or command argument. Chapter 9 provides a complete list of all the software documentation available along with ordering information.

### ReGIS Commands (graphics mode only)

Command	Function
S creen d	Screen scroll offset, quantified to [12,8].
[x,y]	Move this address to upper left corner.
[dx,dy]	Scroll screen by this amount.
(W )	Writing controls.
(E rase)	Clear data and set foreground color.
(A ddressing [x1,y1][x2,y2])	Compatibility with other ReGIS devices.
(A ddressing)	Restore native addressing.
(N egate 1)	Reverse video.

PROGRAMMING SUMMARY

Command	Function
(N egate 0)	Restore video to normal mode.
(T ime nnn)	In 60ths (PF0) or 50ths (PF1) of a second.
(H ardcopy [,Y1][,Y2])	Print hardcopy between Y coordinates.
(I ntensity	Screen background intensity/color.
0 to 7)	Dark to bright.
(D))	dark
(B lue))	
(R ed))	Red + blue.
(M agenta))	
(G reen))	Green + blue.
(C yan))	Red + green.
(Y ellow))	Red + green + blue.
(W hite))	
(H ue	
0 to 360))	Angle on color wheel.
(L ightness	
0 to 100))	Percentage.
(S aturation	
0 to 100))	Percentage.
W rite (I ntensity	Writing intensity/color null; change colors.
_____	
0 to 7)	Dark to bright.
(D))	dark
(B lue))	
(R ed))	Red + blue.
(M agenta))	
(G reen))	Green + blue.
(C yan))	Red + green.
(Y ellow))	Red + green + blue.
(W hite))	
(H ue	
0 to 100))	Angle on color wheel.
(L ightness	
0 to 100))	Percentage.
(S aturation	
0 to 100))	Percentage.
(A lternate	
1)	Flashing on.
0)	Flashing off.
(S hade from [,Y])	Set shading axis.
(S hade with "c")	Set shading character.
(S hade	
1)	Shade on, line pattern shading.
0)	Shade off.

PROGRAMMING SUMMARY

<b>Command</b>		<b>Function</b>
	(M multiplier nnn)	Pixels per offset vector.
	(N egate 1)	Negative writing (invert pattern bits).
	0)	Positive writing.
	(C omplement)	Exclusive OR pattern with bit map.
	(oV erlay)	Logical OR pattern with bit map.
	(E rase)	Write "negate" setting.
	(R eplace)	Replace, ignore bit map data.
	(P attern bbbbbb)	Binary bit pattern, fills to 8 places.
	(Md))	Multiply each bit pattern.
	1)	Solid line.
	p)	Digits 2-9 specify standard patterns.
<b>P</b> osition	[X,Y] [dx,dy] d	Absolute position. Relative position, d is offset vector, 0-7.
	(W )	Temporary write controls.
	(B egin)	Begin position sequence - save position (up to 7 levels).
	(E nd)	End and restore starting position.
<b>V</b> ector	[ ] [X,Y] [dx,dy] d	Write point at current cursor position. Absolute position. Relative position, d is offset vector, 0-7.
	(W...)	Temporary write controls.
	(B egin)	Begin closed polygon sequence.
	(E nd)	Draw to starting position.
<b>C</b> urve	[X,Y] [dx,dy] d	Absolute coordinates Relative coordinates Offset vectors, 0-7.



PROGRAMMING SUMMARY

Command	Function
(B egin)	Begin closed curve.
(S tart)	Start open curve.
(E nd)	End curve.
(W... )	Temporary writing controls.
<b>C</b> ircle	
[X,Y]	Absolute coordinates.
[dx,dy]	Relative coordinates, offset vectors, 0-7.
d	Position is on the circumference.
(C ircumference)	d = degrees resolution, signed.
(A ngle d)	Temporary writing controls.
(W... )	
<b>T</b> ext	
'string'	Display 'string' (includes BS, CR, LF, TAB).
"string"	Display "string" (includes BS, CR, LF, TAB).
d	Offset text line by 1/2 character, d = 0-7.
[dx,dy]	Set spacing between characters.
(A lphabet 0 to 3)	Select character set 0 to 3.
(B egin)	Begin temporary text attributes (saves 1 level).
(D irection d)	d = 45 degrees resolution, signed.
(E nd)	Restore permanent text attributes.
(H eight 0 to 16)	Height times base character size (affects S[r,c]).
(I talic + degrees)	Right slant, no. of degrees.
- degrees)	Left slant, no. of degrees.
0)	No slant.
(M ultiplier [r,c])	No. of times to repeat bits in character. ([1,2] used for standard size.)

PROGRAMMING SUMMARY

<b>Command</b>	<b>Function</b>
(S ize [r,c])	Dimensions of character area. [9,20] is standard size.)
(S ize 0 to 16)	Select one of 17 predefined character sizes.
(W... )	Temporary writing controls.
L oad (A lphabet 1 to 3)	Select character set 1 to 3.
'name')	1 to 10 character name for character set; see R(L).
"c" <10 hex pairs >	Load specific letter with pattern.
'c' <10 hex pairs >	Load specific letter with pattern.
@ letter	Invoke macrograph "letter".
:l etter ... @;	Load macrograph "letter".
	Clear all macrographs.
R eport (L oaded)	Currently loaded character set name.
(M acrographs (letter ,... ))	Report contents of macrograph "letter".
(=)	Report macrograph space usage.
(P osition )	Current position.
(I nteractive ))	Enter locator mode.
[+dx,+dy]))	Arrow increments.
(M acrographs (letter))	Report contents of macrograph 1.
(=)	Report macrograph space usage.
;	Resynchronization character.

## PROGRAMMING SUMMARY

Offset vectors are:      3    2    1  
                             4    \*    0  
                             5    6    7

To initialize ReGIS:      ;s (i 0 n 0 a) W (v i 7a 0 s 0 m 1 n 0 p 1 m 2) T (i  
                                 0 a 0 d 0 s 1) P[0,0]

## BASIC SUMMARY

The following summary of the BASIC commands serves as a quick reference guide. Refer to the software documentation for more information on any command or command argument. Chapter 9 provides a complete list of all the software documentation available along with ordering information.

### Commands/Statements

AUTO	CLEAR	CONT	CTRLC
CTRLO	DATA	DEF FN	DELETE
DIM	ECHO	EDIT	END
ERASE	ERL	ERR	ERROR
FOR...NEXT	GOSUB...RETURN	GOTO	HOST
IF...THEN[...ELSE]	IF...GOTO	INPUT	LET
LINPUT	LIST	MID	NEW
NEXT	NO ECHO	OLD	ON ERROR GO TO
ON...GOSUB	ON...GOTO	OPTION BASE	OUT
PRINT	RANDOMIZE	RCTRLC	RCTRL
READ	REM	RESTORE	RESUME
RUN	SAVE	STOP	SWAP
TRON/TROFF	WAIT	WHILE...WEND	WIDTH

### Functions

ABS	ASC	ATN	CHR\$
COS	EXP	FRE	GOFF\$
GON\$	HEX\$	INKEY\$	INP
INSTR	INT	LEFT\$	LEN
LOG	MID\$	OCT\$	POS
RIGHT\$	RND	SGN	SIN
SPACE\$	SPC	SQR	STR\$
STRING\$	TAB	TAN	

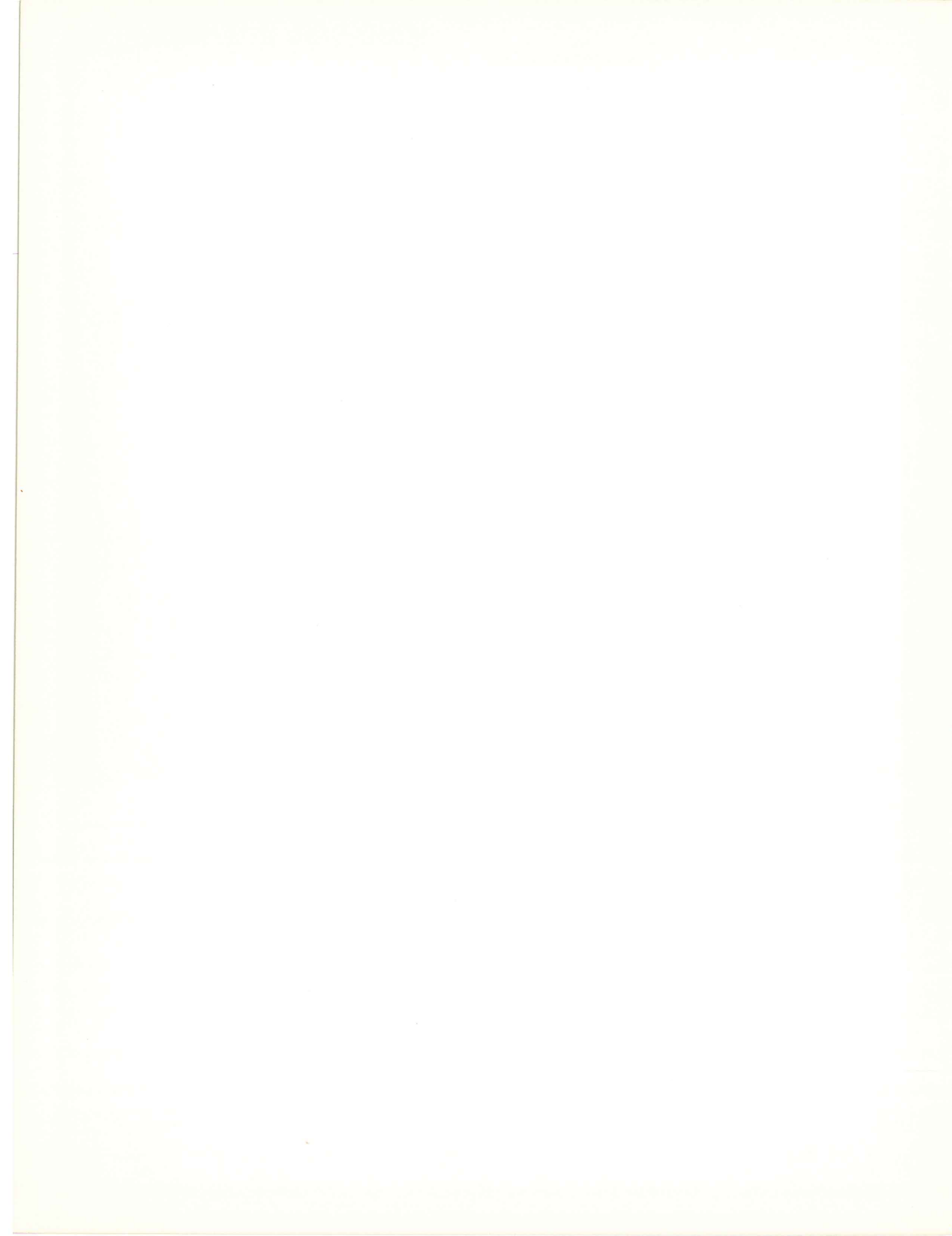

# Hardware Interfaces

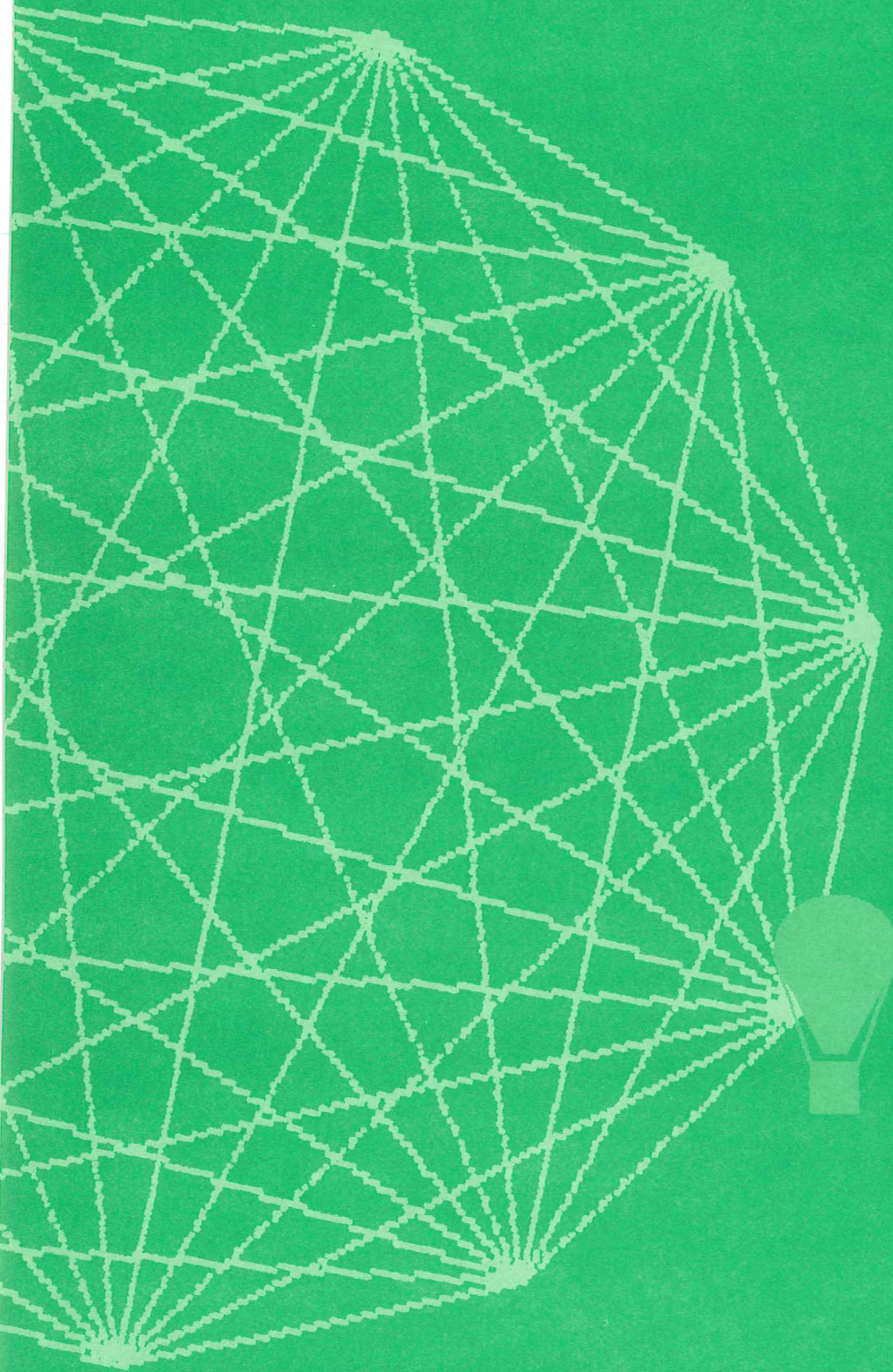

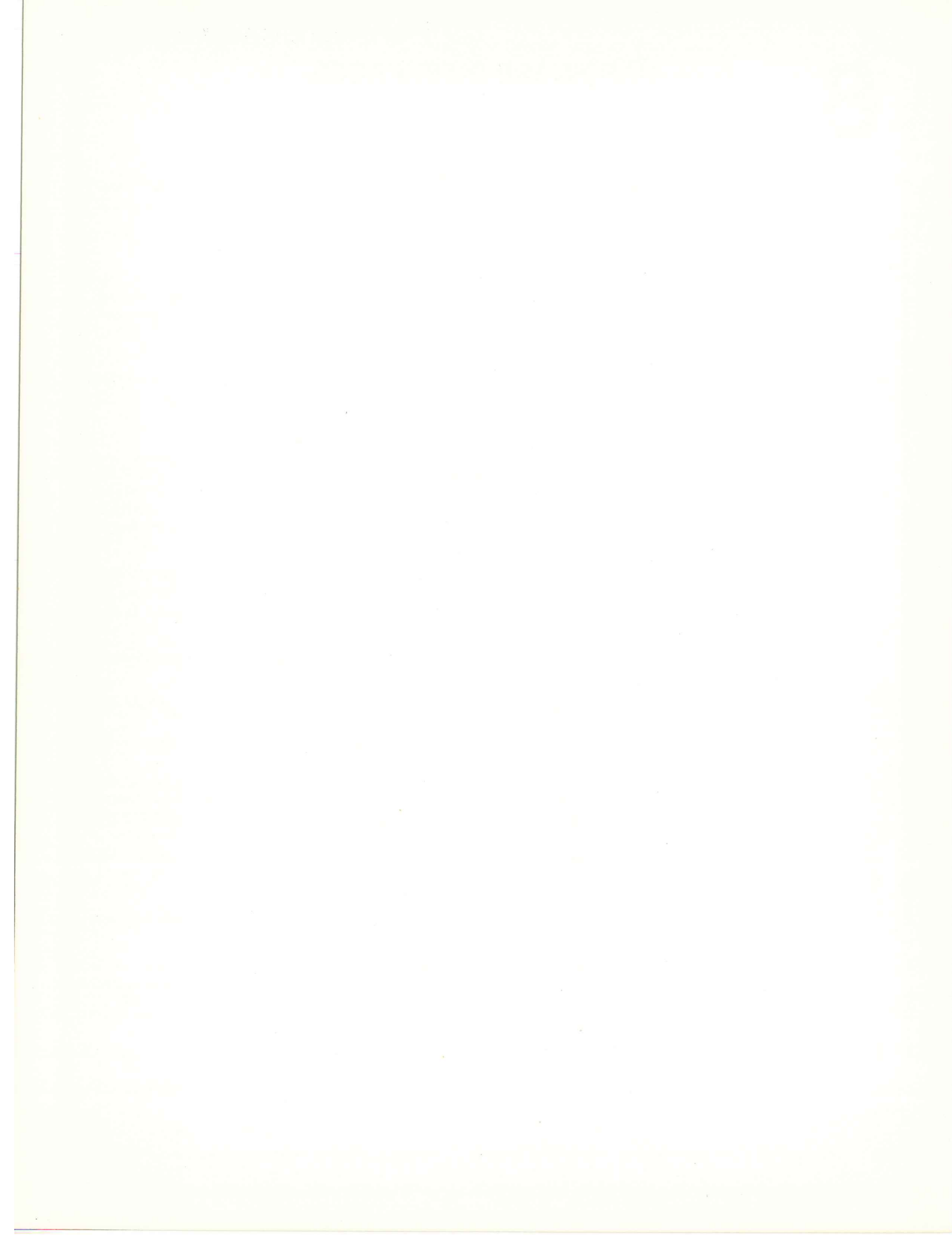

# 8

## HARDWARE INTERFACES

### COMMUNICATIONS INTERFACE

---

The terminal operates on full-duplex, asynchronous communications lines. The physical interfaces are implemented using a 25-pin EIA connector and a 20 mA loop connector.

#### Baud Rate

---

You can program the transmit and receive baud rates through the keyboard by using the SET-UP commands. Specifically, you can set both receive and transmit baud rates independently to: 110, 300, 600, 1,200, 2,400, 4,800, 9,600, or 19,200 baud.

The terminal (set up for jump scroll) supports text writing speeds up to 300 baud without using the XON/XOFF characters for synchronization.

#### Character Format

---

The format of the asynchronous character is bit serial, consisting of a start bit (always SPACE), seven data bits (MARK equals binary 1, SPACE equals binary 0) an optional parity bit, and one or two stop bits (always MARK). The data bits are ASCII coded, and the least significant bit is transmitted or received first.

You can program the parity bit for odd or even parity. If parity is disabled, the eighth bit is set to SPACE and no parity checking occurs on input. If parity is enabled and parity errors are detected, the error character is displayed.

All baud rates have one stop bit per transmitted character, except 110 baud which has two stop bits per character.

The communication data format outlined here is programmed using SET-UP commands.

#### EIA Interface

---

The basic GIGI terminal operates on full-duplex, asynchronous communication lines. The terminal interfaces to the line with a 25-pin connector mounted on the back of the terminal. This connector meets the requirements of EIA Std RS-232-C. Table 8-1 summarizes the EIA connector signals. The following paragraphs explain how the basic GIGI terminal uses each signal.

##### **Protective Ground - Pin 1**

This conductor connects to the terminal system ground via a jumper. The conductor cannot be used for reference potential purposes.

##### **Transmitted Data (from GIGI terminal) - Pin 2**

The GIGI terminal transmits serially encoded characters and break signals on this circuit. The circuit is held in the mark state when the terminal is not transmitting characters or break signals.

##### **Received Data (to GIGI terminal) - Pin 3**

The GIGI terminal receives serially encoded characters generated by the user's equipment on this circuit. The terminal is always ready to accept and interpret data after power-up, except in local mode.

**Table 8-1 EIA Connector Signals**

Pin	Description	EIA/CCITT Circuit
1	Protective ground	AA / 101
2	Transmitted data	BA / 103
3	Received data	BB / 104
4	Request to send	CA / 105
5	(not used)	-
6	Data set ready	CC / 107
7	Signal ground*	AB / 102
8	(not used)	-
9	(not used)	-
10	(not used)	-
11	(not used)	-
12	(not used)	-
13	(not used)	-
14	(not used)	-
15	(not used)	-
16	(not used)	-
17	(not used)	-
18	(not used)	-
19	(not used)	-
20	Data terminal ready	CD / 108.2
21	(not used)	-
22	(not used)	-
23	(not used)	-
24	(not used)	-
25	(not used)	-

\* Common return

**Request To Send (from GIGI terminal) - Pin 4**

This signal is always asserted (SPACE state) when the terminal is powered up and in the on-line mode.

**Clear To Send (from GIGI terminal) - Pin 5**

A circuit exists for this signal, but the signal is ignored at all times.

**Data Set Ready (to GIGI terminal) - Pin 6**

A receiver exists for this signal, but the signal is ignored at all times.

**Signal Ground - Pin 7**

This conductor establishes the common ground reference potential for all voltages on the interface. It connects to the GIGI terminal system ground.

**Data Terminal Ready (from GIGI terminal) - Pin 20**

The data terminal ready (DTR) signal is always asserted, except under the following conditions.

1. When the terminal is not powered up
2. When the terminal is in local mode
3. During the 3.5 second interval following the pressing of **SHIFT** and **BREAK**.



**Note:** This use of data terminal ready (DTR) signal disconnects local and remote data sets when you press SHIFT and BREAK. It also prevents automatic answering when the terminal is in local mode or powered off. This use of DTR also causes the line to disconnect when the GIGI terminal switches from on-line to local mode.

### Electrical Characteristics

---

The electrical characteristics of the EIA interface are as follows.

#### GIGI Terminal Output Voltages

On all signals “from GIGI terminal”, the mark or unasserted state is  $-6\text{ V}$  to  $-12\text{ V}$ ; the space or asserted state is  $+6\text{ V}$  to  $+12\text{ V}$ .

#### GIGI Terminal Input Voltages

On signals “to GIGI terminal”,  $-25\text{ V}$  to  $+0.75\text{ V}$  or an open circuit is interpreted as a mark or unasserted state; and  $+25\text{ V}$  to  $+2.25\text{ V}$  is interpreted as a space or asserted state. Voltages greater than  $\pm 25\text{ V}$  are not allowed. These levels are compatible with EIA Std RS-232-C and CCITT Recommendation V.28.

### 20 mA Current Loop Interface

---

The GIGI terminal current loop interface is a passive configuration, that is, current must be supplied to the GIGI terminal. The transmitter and receiver are both passive and optically isolated; the transmitter goes to the mark state when power is turned off.

#### Electrical Characteristics

The electrical characteristics of the 20 mA current loop interface are as follows.

Transmitter	Min	Max
Open circuit voltage	5 V	50 V
Voltage drop marking	0 V	4 V
Spacing current	–	2 mA
Marking current	20 mA	50 mA
<b>Receiver</b>		
Voltage drop marking	–	2.3 V
Spacing current	–	3 mA
Marking current	15 mA	50 mA

### Buffer Overflow Prevention

---

The GIGI terminal can operate at transmission speeds up to 19,200 baud. However, the terminal may not be able to keep up with incoming data. The terminal stores incoming characters in a 253-character buffer and processes them on a first-in, first-out basis. When the contents of the buffer reaches 100 characters, the terminal transmits XOFF (023g or DC3). On this signal the host computer should suspend transmission to the terminal. If the host stops transmitting, the terminal eventually depletes the buffer. When 50 characters remain in the buffer, the terminal transmits XON (021g or DC1) to signal the host that it may resume transmission. If the host fails to respond promptly to

an XOFF signal from the terminal the buffer continues to fill. When the buffer exceeds its 253-character capacity, a buffer overflow occurs. When the buffer overflows, the GIGI terminal ignores any incoming characters.

The only indication of a buffer overflow is the loss of data on the monitor screen. The terminal does not display special characters on the screen to indicate a buffer overflow. Use the following formula to determine if the buffer will overflow.

$$\text{Response time} = 153 \times 10 / \text{rec speed} - 3 \times (\text{trans bits} / \text{trans speed})$$

where:

Rec speed = GIGI terminal receive speed in bits/second (baud).

Trans bits = 10, except at 110 baud where it is 11.

Trans speed = GIGI terminal transmit speed in bits/second (baud).

**Note:** The response time is less than 0 only when the receive speed is 19,200 baud and the transmit speed is 110 baud. You should never use this combination.

**Example 1.** The GIGI terminal is transmitting at 1200 baud and receiving at 1200 baud. The terminal sends an XOFF signal which the host must respond to within 1.25 seconds to avoid the buffer overflow.

$$\text{Response time} = 153 \times (10/1200) - 3 \times (10/1200) = 1.25 \text{ seconds}$$

**Example 2.** The GIGI terminal is transmitting at 300 baud and receiving at 1200 baud. The terminal sends an XOFF signal which the host must respond to within 1.175 seconds to avoid a buffer overflow.

$$\text{Response time} = 153 \times (10/1200) - 3 \times (10/300) = 1.175 \text{ seconds}$$

The XON/XOFF synchronization scheme has an advantage over requiring the host to insert delays or filler characters in its data stream. Requiring a minimum of software support, XON/XOFF ensures that every character or command sent to the GIGI terminal is processed in correct order. This scheme frees interface programs from all timing considerations and produces more reliable operation.

Software that does not support XON/XOFF signals from the GIGI terminal can still use the terminal in text or interactive mode. To do so you must limit the terminal receive speed to 300 baud in jump scroll mode, or 4800 baud in wrap scroll or scroll off modes. You can set the receive higher only if you know the average line length of the data. Table 8-2 shows the maximum speeds (baud rates) for each scroll mode selection at different line lengths.

**Table 8-2 Terminal Receive Speed Limits (No XON/XOFF Support)**

Scroll Mode	Average Line Length in Characters								
	0	10	20	30	40	50	60	70	80
Smooth	0	600	1200	1200	1200	1200	2400	2400	2400
Jump	300	1200	2400	2400	2400	2400	2400	2400	2400
Wrap/Off	4800	4800	4800	4800	4800	4800	4800	4800	4800

Speeds are expressed as baud rates.

If you cannot use XON/XOFF, you can use fill characters after certain characters or character strings are sent to the GIGI terminal. Table 8-3 shows the number of fill characters required for these functions. You can use either the NUL (000<sub>8</sub>) or the DEL (177<sub>8</sub>) as fill characters.

**Table 8-3 Fill Character Requirements**

Character or Sequence Received	Receive Speed							
	110	300	600	1200	2400	4800	9600	19200
TAB	-	-	-	-	-	-	1	2
Text	-	-	-	-	-	-	1	3
ED (char)	-	-	-	-	-	-	3	9
CAN	-	-	-	-	-	1	2	4
EL	-	-	-	-	2	6	15	32
FF	-	2	4	9	19	39	79	159
DECALN	-	3	9	21	45	93	189	381
ED (full)	1	9	20	42	86	175	353	709

XON/XOFF support is required whenever you use the terminal in the following modes.

Auto Hardcopy (AH1)  
 Graphics mode  
 BASIC mode (BA1 or BA2)

If the host computer does not support XON/XOFF buffer synchronization, data will probably be lost. Fill characters and pauses after transmission are not sufficient due to the varying sequence execution times.

Two terminal functions, reset and self-test, reinitialize the terminal and erase the buffer. This means characters received after the commands to perform these two functions are lost without being processed.

To compensate for this, the host computer may act in one of the two following ways.

1. Immediately after sending the terminal the commands to perform either the reset or self-test function, the host may act as if it had received XOFF from the terminal. Thus the host will not send additional characters until it receives XON. The terminal transmits XON only after it completes the specified operation and the XON/XOFF feature is enabled.
2. When the first method cannot be implemented, the host may use a delay of no less than 10 seconds to allow the terminal time to complete the invoked function. This method, however, does not guarantee against the loss of data when an invoked function detects an error; and while this delay is currently adequate, future options may require a change in the delay period.

The GIGI terminal always recognizes received XOFF and XON signals. Receipt of XOFF inhibits the GIGI terminal from transmitting any codes except XOFF and XON. Up to 253 keystrokes are stored in a keyboard buffer (some keys transmit two or three codes, e.g., cursor controls). If the keyboard buffer overflows, keyclicks stop. Transmission resumes upon receipt of XON.

Entering and exiting SET-UP clears all stored keyboard characters and the keyboard locked condition.

## DISPLAY INTERFACE

---

The display interface provides the circuitry needed to drive one black and white monitor and one red, green, and blue (RGB) color monitor at the same time. Four separate BNC connectors are located on the rear of the terminal; they are labeled as follows.

MONO  
RED  
GREEN  
BLUE

These connectors provide the signals needed to drive both black and white and color monitors.

### Composite Video Port (MONO)

---

This interface connector drives an external black and white monitor. The output conforms to EIA RS-330 and has the following nominal characteristics.

Output impedance	75 ohms, dc coupled
Sync level	0.0 V to 0.1 V
Black level	0.3 V $\pm$ 10% when terminated with 75 ohms
White level	1.0 V $\pm$ 10% when terminated with 75 ohms

### Color Monitor Port (RED, GREEN, BLUE)

---

These interface connectors drive an external RGB color monitor. The RED, GREEN, and BLUE outputs have the following nominal characteristics.

Output impedance	75 ohms, dc coupled
Red and blue signal outputs	
Signal level	1.0 V $\pm$ 10%
Green signal outputs	
Signal level	1.0 V $\pm$ 10%
Sync level	0.0 V to 0.1 V
Black level	0.3 V $\pm$ 10%

### Composite Sync Waveform Timing

The composite sync waveform conforms to EIA RS-330 and has the following nominal characteristics.

Horizontal period	63.131 $\mu$ s (15.840 KHz)
Horizontal sync width	4.735 $\mu$ s
Front porch	0.789 to 7.891 $\mu$ s. The exact timing depends upon the HP SET-UP feature setting. When set to HP5 the front porch is 3.945 $\mu$ s.
Back porch	7.891 $\mu$ s minus front porch time
Active video time	50.505 $\mu$ s
Frame rate	
Noninterlaced (ILO)	60.00 Hz (PF0) or 49.97 Hz (PF1)
Interlaced (IL1)	29.94 Hz (PF0) or 24.95 Hz (PF1)
Vertical sync width	189.394 $\mu$ s
Serration during vertical sync	none
Vertical blank	1.262 ms minimum (PF0) 4.609 ms minimum (PF1)
Horizontal scans per frame	264 (PF0 and ILO) 317 (PF1 and ILO) 529 (PF0 and IL1) 635 (PF1 and IL1)

### Monitor Selection

The display interfaces to drive a number of commercially standard monitors. Monitors connected to the GIGI terminal should have the following capabilities.

Video bandwidth	8 MHz minimum
Horizontal flyback time	12 $\mu$ s maximum
Vertical flyback time	1.0 ms maximum (525-line monitor) 4.3 ms maximum (625-line monitor)
Line rate	15.840 KHz
Frame rate	60 Hz or 50 Hz
Aspect ratio	adjustable to 1:1.6
DC restoration	

## HARDWARE INTERFACES

To present the best possible display, the GIGI terminal contains a number of SET-UP selectable features to tailor the video output of the terminal to the monitor. These features are as follows.

<b>Feature</b>	<b>Function</b>
PF0	For 60 Hz, 525-line monitors
PF1	For 50 Hz, 625-line monitors
HP0 to HP9	For horizontal centering
HM0 to HM9	To horizontally limit the text display area for monitors with overscan
VM0 to VM9	To vertically limit the text display area for monitors with overscan
EM1	For 40 characters per line display text on low resolution monitors
ILO	For a noninterlaced display to reduce flicker
IL1	For an interlaced display on a monitor with a slow phosphor, or for taking monitor screen photographs

## HARDCOPY INTERFACE

The terminal has a serial interface port for interfacing to a LA34VA graphics printer; this allows dumping of bit map information to obtain a hardcopy. A series-chaining scheme allows more than one GIGI terminal to share a single graphics printer.

### Physical Interface

The interface to an external hardcopy device uses a standard 25-pin female EIA connector. Table 8-4 lists the pin assignments.

**Table 8-4 Hardcopy Interface Pin Assignments**

<b>Pin</b>	<b>Signal Name</b>
1	Protective Ground
2	Downstream Transmitted Data (DTXD)
3	Downstream Received Data (DRXD)
4	Downstream Request To Send (DRTS)
5	Downstream Clear to Send (DCTS)
7	Signal Ground
13	Upstream Clear To Send (UCTS)
14	Upstream Transmitted Data (DTXD)
16	Upstream Received Data (DRXD)
19	Upstream Request To Send (URTS)

## Electrical Interface

---

The electrical characteristics of the hardcopy interface are as follows.

### **GIGI Terminal Output Voltages**

On signals generated by the GIGI terminal, the mark or unasserted state is  $-6\text{ V}$  to  $-12\text{ V}$ ; the space or asserted state is  $+6\text{ V}$  to  $+12\text{ V}$ . These levels are compatible with EIA Std RS-232-C and CCITT Recommendation V.28.

### **GIGI Terminal Input Voltages**

On signals received by the GIGI terminal,  $-25\text{ V}$  to  $+0.75\text{ V}$  or an open circuit is interpreted as a mark or unasserted state, and  $+25\text{ V}$  to  $+2.25\text{ V}$  is interpreted as a space or asserted state. Voltages greater than  $\pm 25\text{ V}$  are not allowed. These levels are compatible with EIA Std RS-232-C and CCITT Recommendation V.28.

## Hardcopy Device Sharing

---

The GIGI terminal contains the necessary logic for series-chaining to another GIGI terminal to time share a single hardcopy device. For every series-chained GIGI terminal, a Y-cable (BC26B-01) and a modem cable (BC22B-x) are needed. Chapter 2 provides instructions on how to connect the terminal in a series chain.

There is no limitation on the number of GIGI terminals chained to the hardcopy device as long as the maximum cable length between adjacent terminals is 50 ft. The 50 ft maximum cable length conforms to RS-232-C/CCITT V.28 interface specifications. In practice the number of GIGI terminals served by a single printer should be limited to 5 terminals because of response time.

When a GIGI terminal is powered off, all upstream terminals (those farther away from the hardcopy device) are broken off the chain. The cabling system allows downstream terminals to bypass the Y-cable on the powered-off terminal and remain in the chain. As a general practice you should disconnect all powered-off terminals from the chain. This eliminates the possibility of inducing noise pulses in the chain, which may cause an erroneous printout.

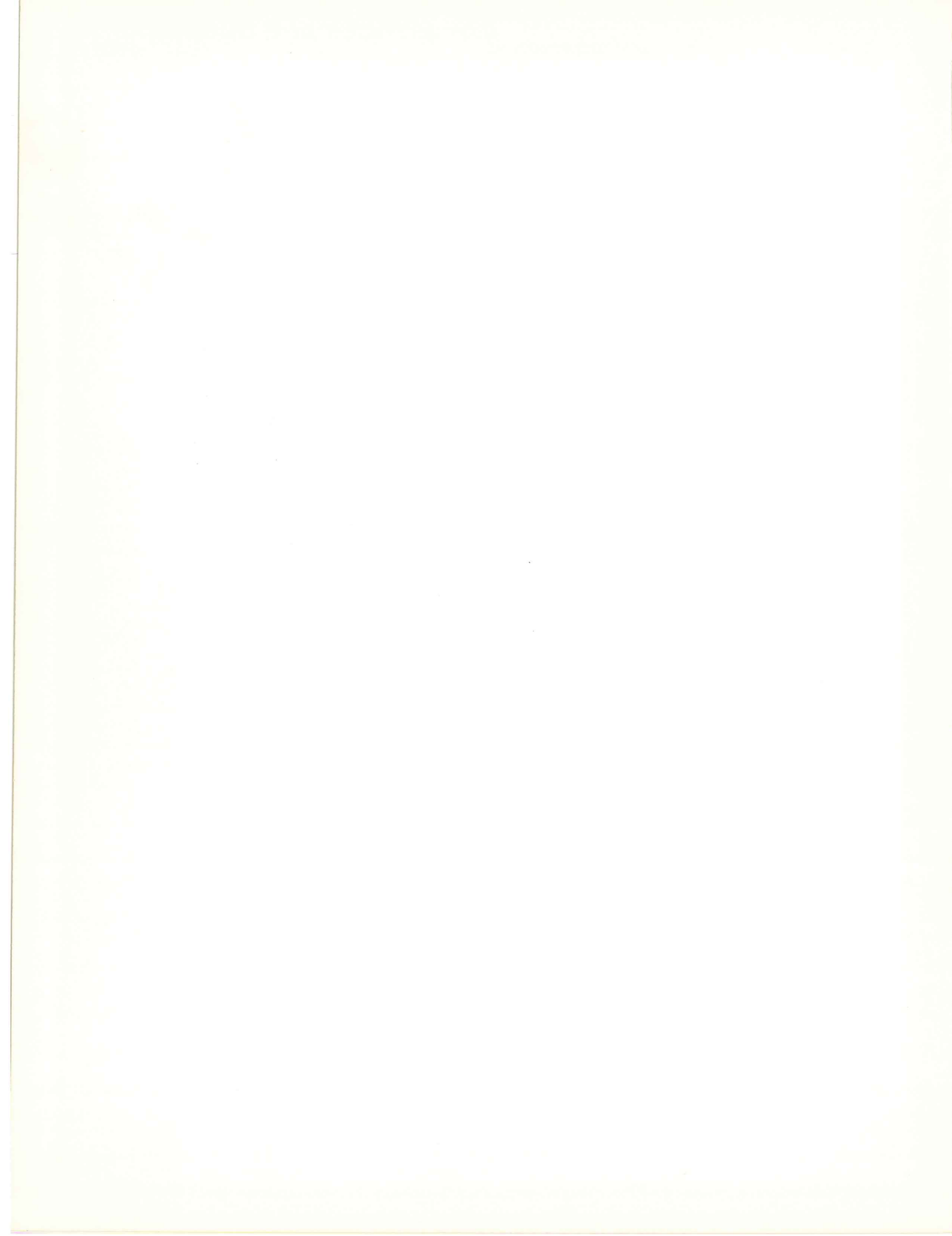



# Accessories and Supplies

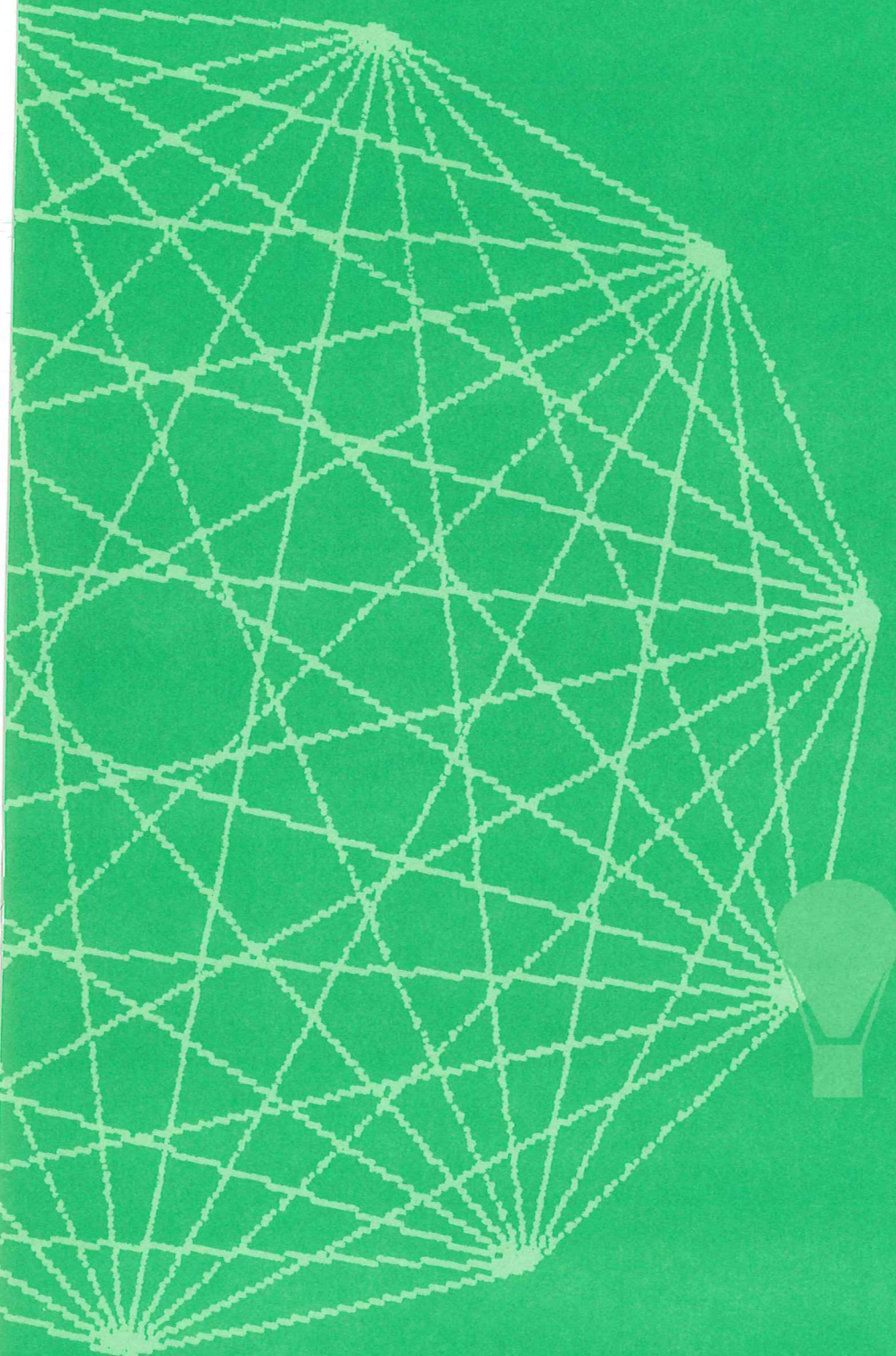

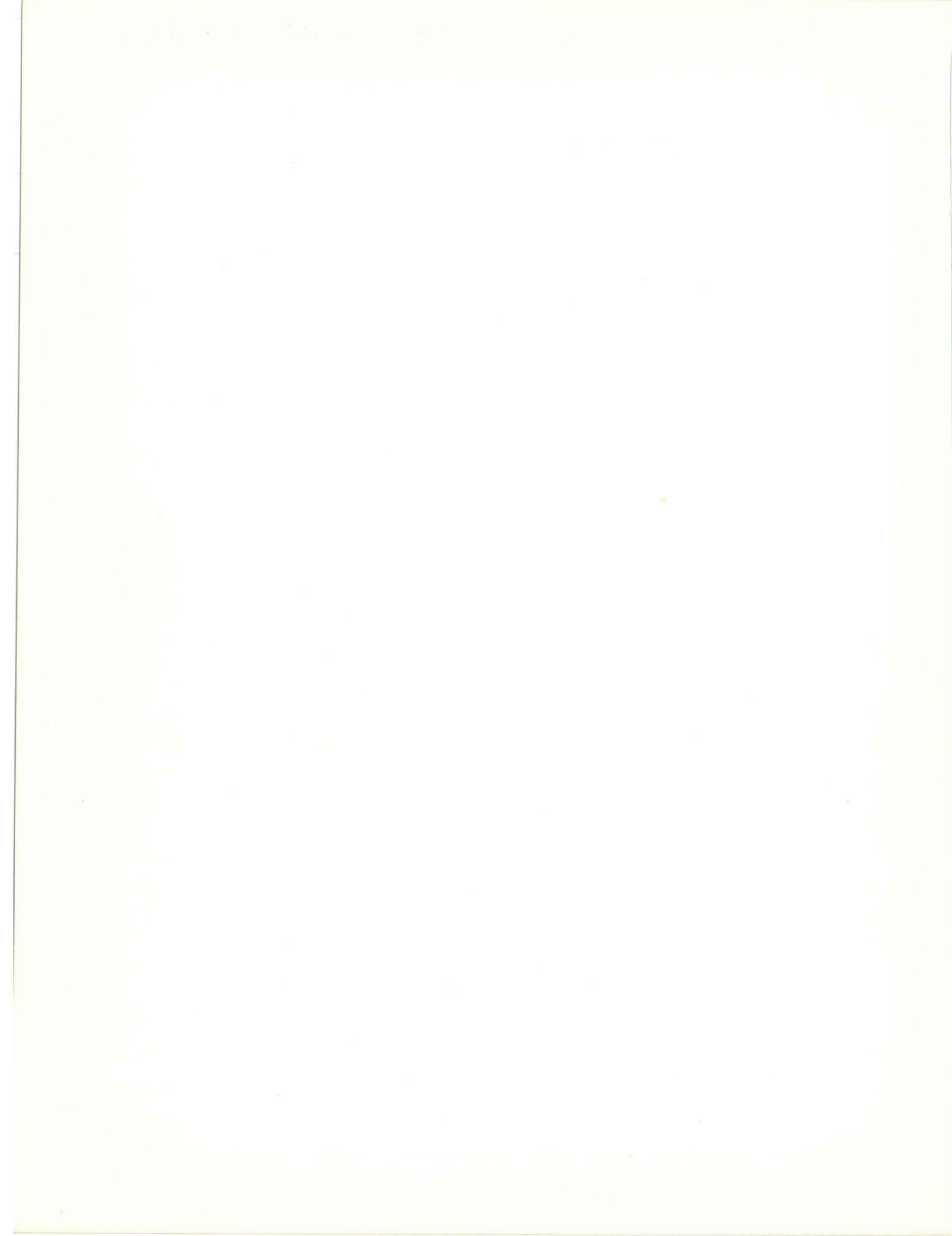

# 9

## ACCESSORIES AND SUPPLIES

### FEATURES

DIGITAL offers the following accessories and supplies to complement your GIGI terminal.

- GIGI Carrying Cases (VK10K-CA)

These cases are specially designed to hold the GIGI terminal and all associated cables. They are constructed of high-density, charcoal brown, textured plastic and include two chrome-plated latches with locks.

- GIGI Keyboard Overlays

Two types of overlays are available for use with the GIGI terminal. These overlays are easy-to-install, plastic key covers used to represent the GIGI terminal's special function keys or user-defined character sets.

Preprinted keypad overlays cover GIGI's auxiliary keypad and are used with the following software packages.

CAI Primer (VK10K-AA)

Graphics Editor (VK10K-AB)

RITE Text Editor (VK10K-AC)

Character Set Editor (VK10K-AD)

Keyboard overlays cover the GIGI terminal's entire keyboard, including the auxiliary keypad, and include the following.

Preprinted APL character set overlays (VK10K-BB)

Blank, full keyboard overlays for user-defined character sets (VK10K-BA)

- GIGI Cables and Connectors

BC26M-05	RGB cable with BNC connectors for user-supplied monitor
BC26B-01	Y-cable for daisy chaining the LA34VA graphics printer to multiple GIGI terminals
P/N 7015503-00	20 mA loopback connector
P/N 1215336-00	EIA loopback connector
BC22B-25	EIA extension to second GIGI terminal from Y-cable (BC26B-01)
BC05F-15 or BC05F-50,A0	20 mA cable with Mate-N-Lok connectors for connecting GIGI terminal (with 20 mA option) directly, to a line unit
BC22A-10 or BC22A-25	EIA null modem; connects GIGI terminal directly to a line unit (6 conductor cable)
BC22B-10 or BC22B-25	EIA extension to modem (14 conductor cable)

In the future, additional options will be available which will further enhance the basic GIGI terminal. Contact the nearest DIGITAL Sales Office for further information.

### RELATED DOCUMENTATION

You can purchase the following GIGI manuals (Table 9-1) from DIGITAL's Accessory and Supplies Group. For specific ordering information, see the end of this chapter.

**Table 9-1 Related DIGITAL Documentation**

<b>Title</b>	<b>Document No.</b>	<b>Contents</b>
GIGI Terminal Installation and Owner's Manual	EK-VK100-IN	This manual describes the GIGI terminal. It provides information on how to install the terminal and connect the optional peripheral devices, how to perform the terminal SET-UP, how to determine if the terminal is operating properly, and how to return the terminal for repair if a failure is found. It also provides full specifications for all terminal outputs. One copy of this manual is shipped with each GIGI terminal.
GIGI Programming Reference Card	EK-0GIGI-RC	This pocket size reference card summarizes the programmable features of the GIGI terminal. It includes a summary of both the ReGIS and BASIC command sets. A copy is shipped with each GIGI terminal.
GIGI Terminal SET-UP Reference Card	EK-VK100-RC	This pocket size reference card summarizes the GIGI terminal SET-UP parameters. The card also contains the default SET-UP switch pack settings. A copy is shipped with each terminal.
VK100 Pocket Service Guide	EK-VK100-PS	This manual is a module-level repair manual. It provides troubleshooting information, testing information, and removal and replacement information for the GIGI terminal.
VK100 Technical Manual	EK-VK100-TM	This manual provides a detailed block-diagram-level discussion of the GIGI terminal. It also provides information on troubleshooting the terminal. The manual does not contain a set of schematic drawings. These drawings are a part of the VK100 print set, which must be ordered separately.
VK100 Illustrated Parts Breakdown (IPB)	EK-VK100-IP	This manual provides a detailed parts breakdown of the terminal. It does not provide part numbers for printed circuit board components. That information is contained in the VK100 print set, which must be ordered separately.

**Table 9-1 Related DIGITAL Documentation (Cont.)**

<b>Title</b>	<b>Document No.</b>	<b>Contents</b>
VK100 Print Set	MP-00893-00	This document provides a complete set of electrical and mechanical schematic diagrams for the VK100 (GIGI) terminal.
GIGI/ReGIS Handbook	AA-K336A-TK	This book provides user information to program the GIGI terminal, including system-dependent information. It provides comprehensive descriptions of ReGIS commands, organized alphabetically for easy reference. Extensive examples of the GIGI graphics capabilities are used throughout. A copy of this book is shipped with each GIGI terminal.
GIGI BASIC Manual	AA-K335A-TK	This is a BASIC language manual for the GIGI terminal. It provides comprehensive descriptions of the GIGI BASIC commands and functions, organized alphabetically for easy reference. A copy of this manual is shipped with each GIGI terminal.
GIGI Graphics Editor Manual	AA-J942A-TK	This manual describes the Graphics Editor software package. It describes in detail the use of the Graphics Editor package within the entire GIGI package. The manual also includes descriptions of each Graphics Editor command. A copy of this manual is shipped with the GIGI Graphics Editor software package.
GIGI Data Plotting Package Manual	AA-J956A-TK	This manual describes the GIGI Data Plotting software package. It describes the functional modes and the steps needed to create a table, define and display plots from that table, and perform statistical analysis. It also describes each of the plot commands and file structures for the table data and statistical results. A copy of this manual is shipped with the GIGI Data Plotting software package.
GIGI Slide Projector Manual	AA-J943A-TK	This manual describes the GIGI Slide Projector software package. It describes the file formats and the use of the automatic and manual modes. It also describes each command and provides syntax and usage information. A copy of this manual is shipped with the GIGI Slide Projector software package.
GIGI Character Set Editor User Guide	AA-K337A-TK	This manual describes the GIGI Character Set Editor. It describes each command and provides syntax and usage information. A copy of this manual is shipped with the GIGI Character Set Editor software package.

**Table 9-1 Related DIGITAL Documentation (Cont.)**

<b>Title</b>	<b>Document No.</b>	<b>Contents</b>
GIGI RITE Manual	AA-J944A-TK	This manual describes the GIGI RITE software package. It describes the RITE, its editing and graphics capabilities, and the use of picture files. It also describes the keypad commands. A copy of this manual is shipped with the GIGI RITE software package.
GIGI/ReGIS CAI Primers Student Guide	SDC AA-K329A-TE	This manual is used in conjunction with any of the GIGI/ReGIS CAI Primers. It provides an overall introduction to the primers, including their objectives and recommended course of study. It also tells you how to start the course.
VAX/VMS GIGI/ReGIS CAI Primers	SDC BE-K391A-BC (TU58) SDC AS-K327A-BE (Floppy)	This computer-assisted instruction (CAI) course runs on VAX/VMS. It helps new GIGI users to begin using the terminal and ReGIS.
VAX/VMS GIGI/ReGIS CAI Primers Course Administrator Guide	SDC AA-K328A-TE	This manual provides an overview of the course administrator's role and describes how to install and maintain the CAI software on VAX/VMS.
RSTS/E GIGI/ReGIS CAI Primers	SDC BC-K346A-BC (RL02) SDC AP-K392A-BC (Magtape 9 track 800 bits / in) SDC BB-393-BC (Magtape 9-track 1600 bits / in)	This computer-assisted instruction (CAI) course runs on RSTS/E. It helps new GIGI users to begin using the terminal and ReGIS.
RSTS/E GIGI/ReGIS CAI Primers Course Administrator Guide	SDC AA-K347A-TC	This manual provides an overview of the course administrator's role and describes how to install and maintain the CAI software on RSTS/EAI software on RSTS/E.

## HOW TO ORDER ACCESSORIES and SUPPLIES

---

You can order accessories and supplies (including documentation) either by mail or phone.

### Toll-Free Telephone Orders

---

Call DIGITAL Direct Catalog Sales from 8:30 a.m. to 5:00 p.m. at one of the following numbers.

Continental United States  
1-800-258-1710

New Hampshire, Alaska, and Hawaii  
1-603-884-6660

Canada  
1-800-267-6146

Northern California  
1-408-984-0200

Chicago  
1-312-640-5612

Outside North America  
Contact your local A & SG business representative or local DIGITAL sales office.

The following information applies to all telephone orders.

Minimum order is \$35 unless charged to Master Card, Visa, or American Express.

Maximum order is \$5,000.

Phone orders are accepted at current list price only.

Phone orders are accepted per DIGITAL standard terms and conditions only.

### Direct Mail Orders

---

Mail all purchase orders directly to one of the following addresses.

#### **For US Customers**

Digital Equipment Corporation  
ATT: A&SG  
P.O. Box CS2008  
Nashua, New Hampshire 03061

#### **For International Customers**

Digital Equipment Corporation  
A&SG Business Manager  
c/o Digital's local subsidiary

The following information applies to all direct mail orders.

Minimum order is \$35 unless paid by check, money order, or credit card (Visa, Master Card, or American Express accepted).

No maximum order value.

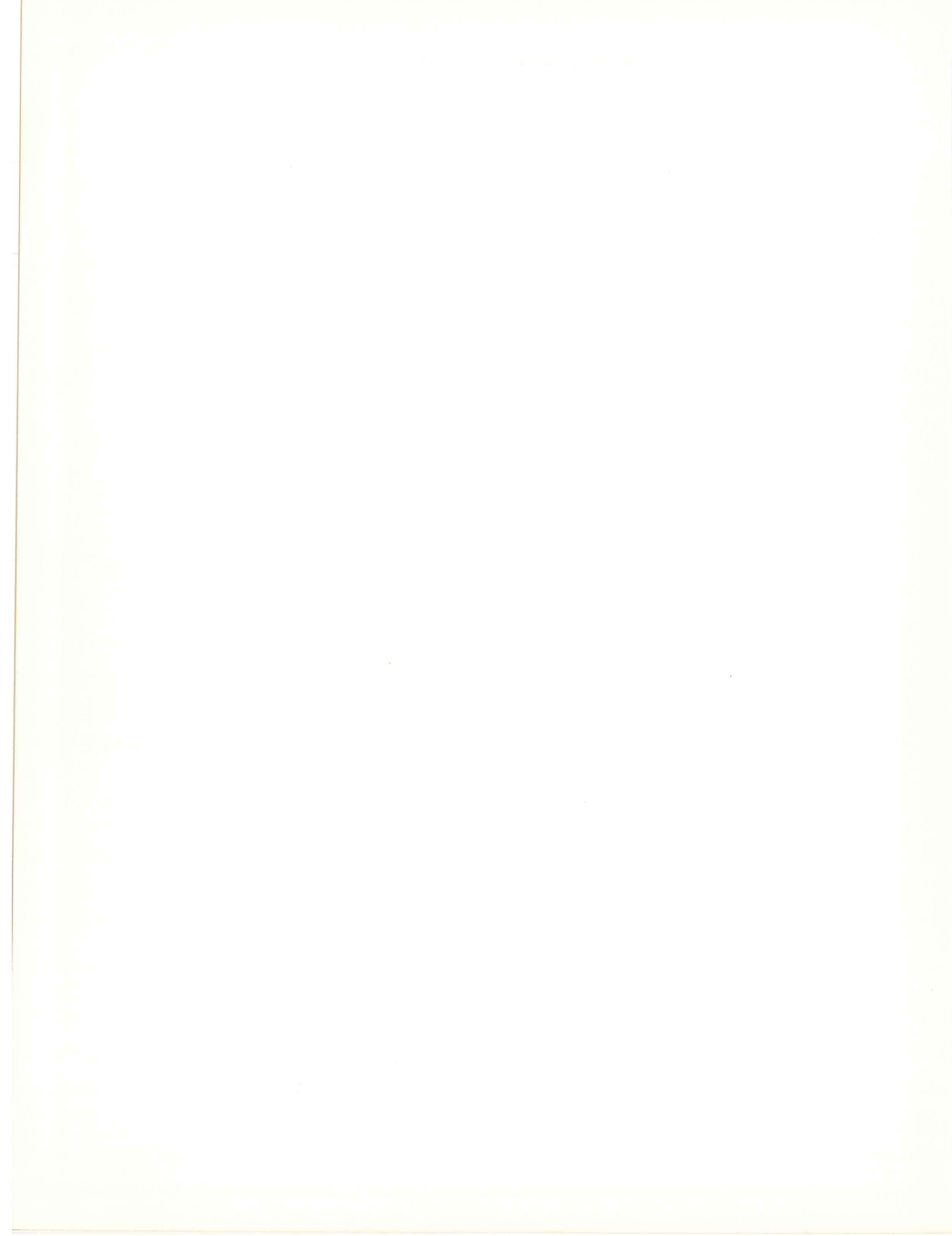



# APPENDIX A

## GIGI TERMINAL SPECIFICATIONS

### Dimensions

Height	9.88 cm (3.89 in)
Width	49.30 cm (19.40 in)
Depth	31.10 cm (12.25 in)

### Weight

Shipping weight	5.7 kg (12.5 lbs)
-----------------	-------------------

### Environment

Operating	
Temperature	10° to 40° C (50° to 104° F)
Relative humidity	10% to 90%
Max wet bulb	28° C (82° F)
Min dew point	2° C (36° F)
Altitude	2.4 km (8,000 ft)
Nonoperating	
Temperature	-40° to 66° C (-40° to 151° F)
Relative humidity	5% to 95%
Altitude	9.1 km (30,000 ft)

### Power

Line voltage	90-128 V RMS single phase, 2 wire with ground wire 180-256 Vrms single phase, 2 wire with ground wire (internally selectable)
Line frequency	46 Hz to 61 Hz
Current	1.3 Arms max at 115 Vrms 0.7 Arms max at 230 V
Input power	120 VA apparent, 60 W max
Current limiting	2 A/250 V normal blow fuse
Power cord	2.0 m (6.5 ft), 3 prong

### Product Safety

UL: Listing per UL 478  
CSA: Certification per CSA  
C22.2. No. 154  
IEC 435 and VDE 0804  
compliance

### Program Memory

13K bytes available to the user  
and down-line loadable:  
7.8K for BASIC programs  
2+K for ReGIS macrographs and  
keypad key definitions  
three soft character sets each  
95 × 10 × 8 bytes

**Display Outputs**

Text mode	24 lines $\times$ 84 characters max or 24 lines $\times$ 42 double-width characters
Character	8 $\times$ 10 dot matrix with descenders
Character set	95-character displayable ASCII subset (upper and lowercase, numeric and punctuation)
Text cursor type	Blinking block character; can be disabled in SET-UP
Graphics mode	768 pixels horizontal 240 pixels vertical
Graphic cursor type	Diamond shape with cross hair in the center; can be disabled in SET-UP
Locator cursor type	Large cross hair
Graphic pattern memories	Permanent UK/US ASCII character set: 128 characters, 8 $\times$ 10 dot matrix  Three user programmable and down-line loadable soft alphabet character sets: 95 characters each, 8 $\times$ 10 dot matrix
Visual attributes	Four bits per segment of 12 horizontal pixels Eight levels of grey for black and white monitors Eight colors for color monitor: black, blue, red, magenta, green, cyan, yellow, and white Blink
Video outputs	Output to drive one black and white (composite video) and one color (RGB) monitor (with composite green video) simultaneously  Adjustable horizontal and vertical margins to accomodate monitor overscan  Adjustable horizontal centering 50/60 Hz refresh, noninterlaced or interlaced

## APPENDIX

### Keyboard

General	83-key unit
Key layout	65-key arrangement and sculpturing similar to standard typewriter keyboard, with an 18-key auxiliary keypad
Auxiliary keyboard	18-key numeric pad with period, comma, minus, ENTER, and four function keys
Visual indicators	Seven LEDs: five LEDs dedicated to ON-LINE, LOCAL, NO SCROLL, BASIC and HARD COPY; two LEDs user-programmable
Audible signals	Keyclick: sound simulates typewriter Bell: sounds upon receipt of BEL code, or sounds nine characters from right margin (keyboard selectable)

### Communication

Type	EIA RS-232-C/CCITT V 24 or 20 mA passive current loop (keyboard selectable)
Speeds	Full duplex: 110 (two stop bits), 300, 600, 1,200, 2,400, 4,800, 9,600 and 19,200 baud; transmit and receive speeds are independent of each other
Code	ASCII
Character format	Asynchronous serial
Character size	Eight bits including parity bit
Parity	Even, odd, or none (keyboard selectable)
Synchronization	Keyboard selectable via automatic generation of XON/XOFF control codes
Modes	Normal line, single character, local echo (keyboard selectable)

### Hardcopy Interface

Drives an LA34VA graphics printer with daisy-chaining capability  
Auto hardcopy

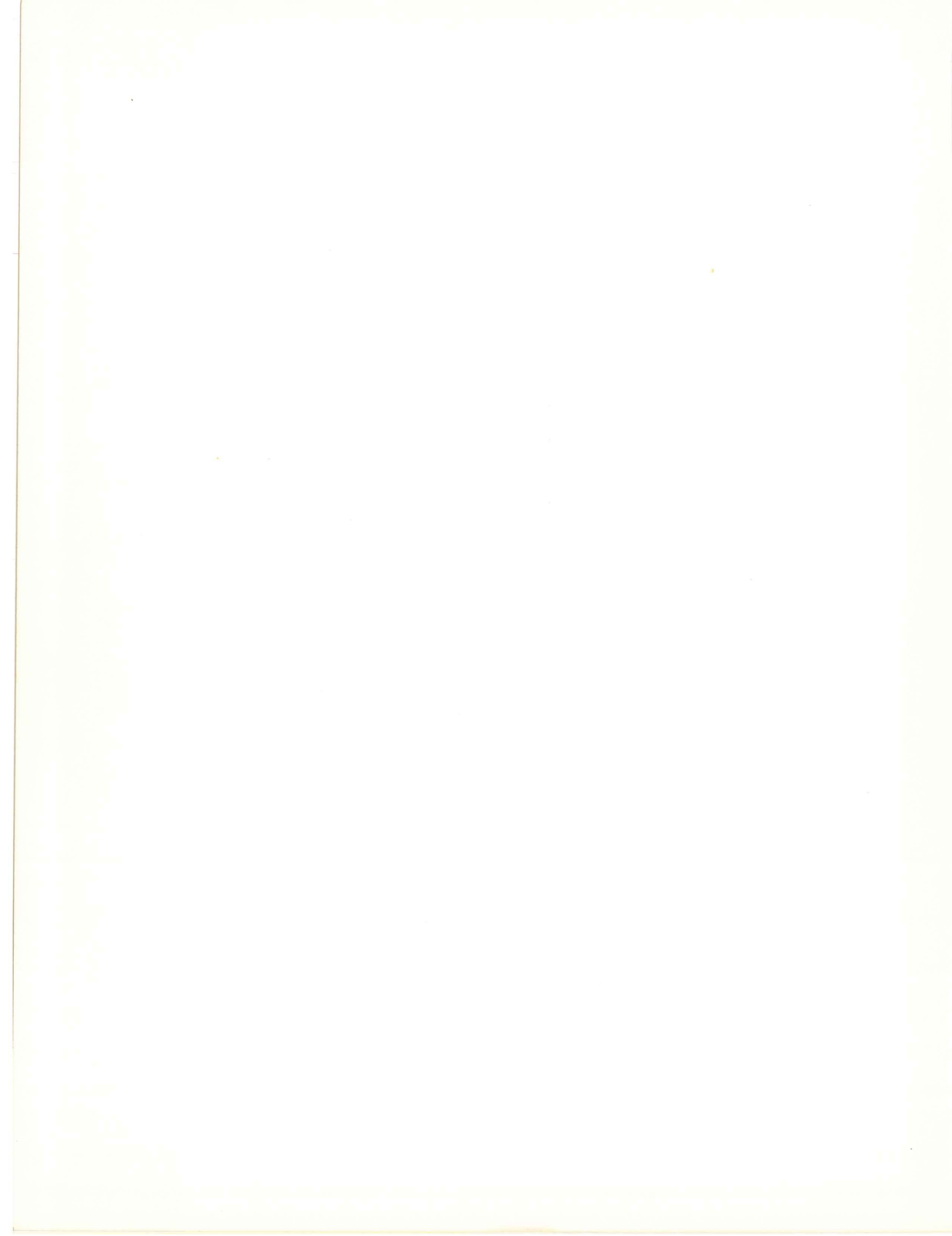

## A

Accessories and supplies ordering .....	91
Arrow keys .....	21, 23-25, 36, 59
Audible indicators .....	27
Auto hardcopy (AH).....	32, 35, 42, 68
Auto wraparound (AW).....	32, 35, 42, 68
Auxiliary keypad codes .....	59

## B

BASIC (BA).....	31, 37, 68
BASIC commands.....	75
BASIC functions.....	75
BASIC indicator .....	26
BASIC mode .....	3
Black and white video port output.....	82
BREAK key.....	21
Buffer overflow prevention .....	79

## C

C command (ReGIS).....	72, 73
Cables .....	87
CAPS LOCK key.....	20
Carrying cases .....	87
Character attributes (ANSI).....	66
Character format – communications.....	77
Character sets.....	62, 67
Color bar test.....	49, 69
Color video port output .....	82
Communications interface (CI).....	30, 33, 44, 77
Composite video port output.....	82
Confidence tests (ANSI) .....	69
Connections	
Barco GD33 monitor .....	12
Typical black and white monitor .....	14
LA34VA graphics printer .....	14
Communications cables.....	8
Control characters.....	60
Control functions.....	63
CONTROL key.....	23
Control Sequence Introducer (ANSI).....	64
Cursor key mode (CK).....	33, 35, 43, 68
Cursor movement commands (ANSI) .....	66

## D

Default (ANSI).....	64
Default SET-UP switch pack location .....	7
Default SET-UP switch pack settings.....	8
DELETE key.....	22
Device control strings (DCS) (ANSI).....	45, 69
Display test.....	49, 69
Down arrow key.....	21, 23, 25, 36, 59

## E

EIA interface signal definitions.....	78
EIA interface signal electrical characteristics .....	79
Erasing commands (ANSI) .....	67
Error codes.....	50
ESCAPE key.....	23
External communications test .....	48, 69
Expansion mode (EM) .....	31, 35, 40, 84

## F

Fatal errors .....	51
Fill characters.....	81
Final character (ANSI) .....	64

## G

GIGI installation card.....	6, 12
Graphics cursor .....	40
Graphics display (GD).....	32, 35, 41
Graphics mode.....	2
Graphics mode commands (ANSI).....	67
Graphics prefix (GP) .....	32, 35, 41
Graphics prefix character .....	41

## H

Hardcopy communications test .....	48
Hardcopy device sharing.....	85
Hardcopy interface outputs .....	85
Hardcopy speed (HS) .....	33, 35, 44
Horizontal margin (HM) .....	31, 35, 39, 84
Horizontal position (HP) .....	32, 35, 40, 84

## I

Installation	
GIGI terminal .....	7
Barco GD33 monitor .....	12
Typical black and white monitor .....	14
LA34VA graphics printer .....	14
Interlace (IL).....	33, 35, 45, 84

## K

Key repeat (KR).....	32, 35, 43, 68
Keyboard overlays.....	87
Keyclick (KC) .....	32, 35, 43
Keypad mode (KP) .....	33, 35, 43, 68
Keypad overlays .....	87

## L

L command (ReGIS) .....	74
Left arrow key .....	21, 24, 25, 36, 59
LINEFEED key.....	22
Line/local (LL) .....	31, 35, 37

## L (Cont.)

Local echo (LE).....	32, 35, 42
LOCAL indicator.....	26
Locator cursor.....	2, 40
Locator mode.....	2, 24
Loopback connectors	
When to use.....	48, 49
How to order.....	87, 91
Long tone.....	27
L1 and L2 indicator.....	26

## M

Margin bell (MB).....	32, 35, 43
Modes (ANSI).....	68
Monitor selection.....	83
Mono video port output.....	82
Multiterminal printer string	
Adding a terminal.....	16
Removing a terminal.....	18

## N

New line (NL).....	32, 35, 42, 68
Nonfatal errors.....	50
NO SCROLL indicator.....	26
NO SCROLL key.....	22, 38
Numeric parameter (ANSI).....	64

## O

Offset vectors.....	75
ON-LINE indicator.....	26
Overstrike (OS).....	32, 35, 40

## P

P command (ReGIS).....	72
Parameter (ANSI).....	64
Parameter string (ANSI).....	64
Parity enable (PE).....	31, 35, 37, 53
PF1/HARDCOPY key.....	21, 60
PF2/LOCATOR key.....	22, 25, 60
PF3/TEXT key.....	22, 60
PF4/RESET key.....	22, 24, 60
Power frequency (PF).....	33, 35, 45, 84
Power-up self-test.....	12, 47
Print commands (ANSI).....	69
Product warranty.....	55
Programmable LEDs (ANSI).....	67
Programmed keypad mode (PK).....	33, 35, 44, 68

## R

R command (ReGIS).....	74
Receive speed (RS).....	31, 35, 37, 53
ReGIS.....	2
ReGIS commands	
S.....	70
W.....	71
P.....	72
V.....	72
C.....	72, 73
T.....	73
L.....	74
@.....	74
R.....	74
;.....	74
Offset vectors.....	75
ReGIS initialize command.....	75
Related documentation.....	88
Repair services.....	55
Reports (ANSI).....	68
Reset (ANSI).....	69
Reset (hard).....	69
Reset (soft).....	22
Return authorization numbers.....	55, 56
RETURN key.....	22, 23, 25, 42
Reverse video (RV).....	31, 35, 39, 68
Right arrow key.....	21, 23, 25, 36, 59

## S

S command (ReGIS).....	70
Screen alignment pattern.....	50, 69
Scroll mode (SM).....	31, 35, 38, 68
SCS control sequence.....	62, 67
Selective parameter (ANSI).....	64
Self-test (ST).....	33, 35, 45
Self-test error codes.....	50
Servicenters.....	57
SET-UP key.....	21
SET-UP mode keys.....	23
SET-UP parameters.....	30
SET-UP parameter code.....	29
SET-UP parameter default settings.....	30
SET-UP parameter – how to change.....	36
SET-UP parameter settings.....	31
Shift in (SI).....	62
SHIFT key.....	20
Shift out (SO).....	62
Short tone.....	27
Single character (SC).....	32, 35, 42
Soft character sets.....	62
Special function keys.....	20
Standard keys.....	20
Standard key codes.....	59
String terminator.....	69
Synchronization (buffer).....	81
Synchronization character (ReGIS).....	74

## T

T command (ReGIS) .....	73
Tablet locator mode (TL) .....	33, 35, 44
Terminal controls .....	19
Terminal mode (ANSI) .....	63
Terminal mode (TM) .....	33, 35, 43, 68
Terminal mode (VT52) .....	53
Terminal model number .....	55, 56
Terminal repair .....	55
Terminal serial number .....	55, 56
Text cursor .....	40
Text display (TD) .....	32, 35, 41
Text mode .....	1
Transmit speed (TS) .....	31, 35, 36, 53

## U

UK character set (UK) .....	33, 35, 44
Unpacking .....	6
Up arrow key .....	21, 23, 25, 36, 59

## V

Vertical margin (VM) .....	31, 35, 39, 84
Visual cursor (VC) .....	32, 35, 40
VT52 control functions .....	70

## W

W command (ReGIS) .....	71
Warranty repairs .....	55

## X

XON/XOFF (XO) .....	31, 35, 38
---------------------	------------

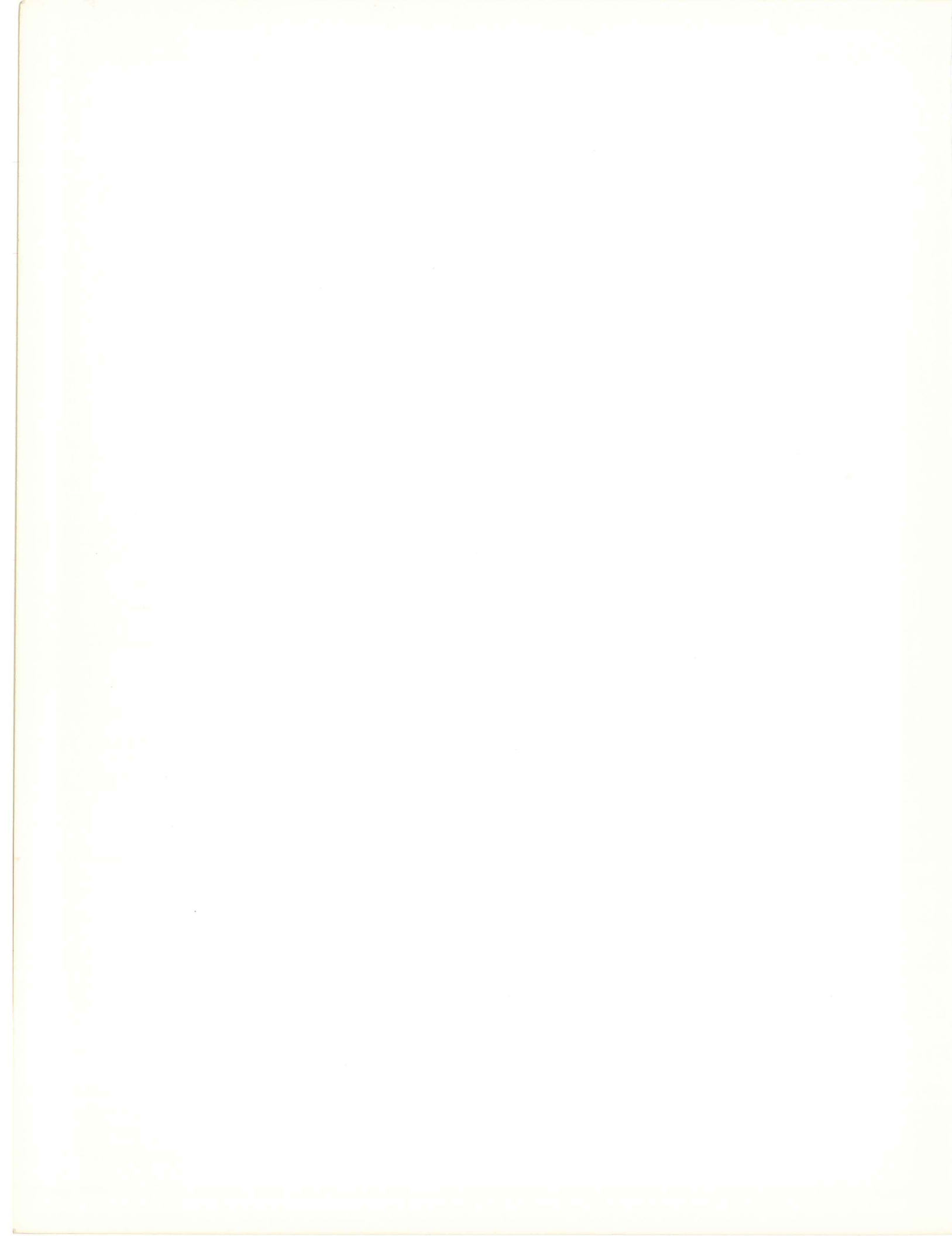



Your comments and suggestions will help us in our continuous effort to improve the quality and usefulness of our publications.

What is your general reaction to this manual? In your judgement is it complete, accurate, well organized, well written, etc? Is it easy to use? \_\_\_\_\_  
\_\_\_\_\_  
\_\_\_\_\_

What features are most useful? \_\_\_\_\_  
\_\_\_\_\_  
\_\_\_\_\_

What faults or errors have you found in the manual? \_\_\_\_\_  
\_\_\_\_\_  
\_\_\_\_\_

Does this manual satisfy the need you think it was intended to satisfy? \_\_\_\_\_

Does it satisfy *your* needs? \_\_\_\_\_ Why? \_\_\_\_\_  
\_\_\_\_\_  
\_\_\_\_\_

Please send me the current copy of the *Technical Documentation Catalog*, which contains information on the remainder of DIGITAL's technical documentation.

Name \_\_\_\_\_ Street \_\_\_\_\_  
Title \_\_\_\_\_ City \_\_\_\_\_  
Company \_\_\_\_\_ State/Country \_\_\_\_\_  
Department \_\_\_\_\_ Zip \_\_\_\_\_

Additional copies of this document are available from:

Digital Equipment Corporation  
Accessories and Supplies Group  
Cotton Road  
Nashua, NH 03060

Attention *Documentation Products*  
Telephone 1-800-258-1710

Order No.     EK-VK100-IN-001

-----  
Fold Here-----

-----  
Do Not Tear - Fold Here and Staple-----

**digital**



No Postage  
Necessary  
if Mailed in the  
United States

**BUSINESS REPLY MAIL**

FIRST CLASS PERMIT NO. 33 MAYNARD, MA.

POSTAGE WILL BE PAID BY ADDRESSEE

**Digital Equipment Corporation  
Educational Services Development and Publishing  
129 Parker Street, PK3-1/T12  
Maynard, MA 01754**

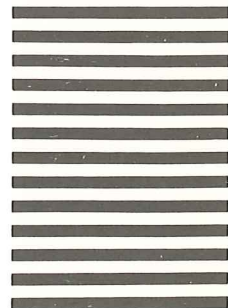



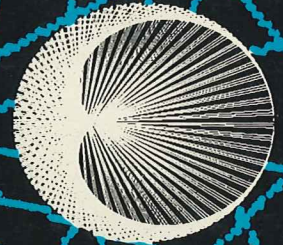
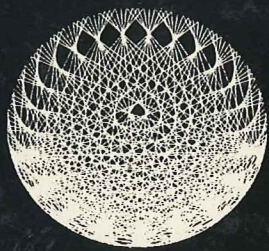

fly to the sky on GI - GI \_\_\_\_\_ and shout to

