

# **DSV11-S Communications Option User Guide**

Order Number EK-DSV11-UG-001

**digital equipment corporation  
maynard, massachusetts**

---

First Printing, April 1988

The information in this document is subject to change without notice and should not be construed as a commitment by Digital Equipment Corporation.

Digital Equipment Corporation assumes no responsibility for any errors that may appear in this document.

The software, if any, described in this document is furnished under a license and may be used or copied only in accordance with the terms of such license. No responsibility is assumed for the use or reliability of software or equipment that is not supplied by Digital Equipment Corporation or its affiliated companies.

---

Copyright ©1988 by Digital Equipment Corporation.

All Rights Reserved.  
Printed in U.S.A.

---

The following are trademarks of Digital Equipment Corporation:

BASEWAY	MicroPDP-11	RSX
BI Bus	Micro/RSTS	RT
DEC	Micro/RSX	ThinWire
DECmate	MicroVAX II	ULTRIX-32
DECnet	PDP	UNIBUS
DECUS	P/OS	VAX
DECwriter	MicroVAX 3500	VAXcluster
DELNI	MicroVAX 3600	VAXELN
DELQA	Professional	VAXstation II
DEQNA	Q-bus	VAXstation II/GPX
DESTA	Q22-bus	VMS
DIBOL	Rainbow	VT
MASSBUS	RSTS	Work Processor

**digital**

---

**FCC NOTICE:** The equipment described in this manual generates, uses, and may emit radio frequency energy. The equipment has been type tested and found to comply with the limits for a Class A computing device pursuant to Subpart J of Part 15 of FCC Rules, which are designed to provide reasonable protection against such radio frequency interference when operated in a commercial environment. Operation of this equipment in a residential area may cause interference, in which case the user at his own expense may be required to take measures to correct the interference.

---

# Contents

---

<b>Preface</b>	v
<b>1 Introduction</b>	
1.1 Features of the DSV11 . . . . .	1
1.2 Typical DSV11 Configuration . . . . .	3
<b>2 Connecting the DSV11-S</b>	
2.1 Introduction . . . . .	4
2.2 How to Attach the Adapter and Extension Cables . . . . .	6
<b>3 Testing the Installation</b>	
3.1 Preparation . . . . .	11
3.2 Test Procedure . . . . .	11
3.3 If a Test Fails . . . . .	13
<b>A Cables and Accessories</b>	
A.1 Adapter Cables . . . . .	14
A.2 Extension Cables . . . . .	15
A.3 Loopback Test Connectors . . . . .	16
<b>B General Specifications</b>	
B.1 Environmental Conditions . . . . .	17
B.2 Electrical Requirements . . . . .	18

**C Adapter Cable Pin Signals**

C.1	Introduction . . . . .	19
C.2	RS-423 Adapter Cable: 37-Way Pins . . . . .	20
C.3	RS-422 Adapter Cable: 37-Way Pins . . . . .	22
C.4	V.35 Adapter Cable: 34-Way Pins . . . . .	24
C.5	V.24 Adapter Cable: 25-Way Pins . . . . .	26
C.6	V.24/RS-232-C Adapter Connector: 25-Way Pins . . . . .	28

**Figures**

1-1	Typical DSV11 Configuration . . . . .	3
C-1	37-Way D-Type Connector (Male) . . . . .	20
C-2	37-Way D-Type Connector (Male) . . . . .	22
C-3	34-Way Square Connector (Male) . . . . .	24
C-4	25-Way D-Type Connector (Male) . . . . .	26
C-5	25-Way D-Type Connector (Male and Female) . . . . .	28

**Tables**

1-1	DSV11 Maximum Line Speeds . . . . .	2
2-1	Data Rate/Cable Length Relationships . . . . .	5
B-1	DSV11-S Environmental Limits . . . . .	17
B-2	DSV11-S Electrical Requirements . . . . .	18
C-1	RS-423 Pins and Signals . . . . .	21
C-2	RS-422 Pins and Signals . . . . .	23
C-3	V.35 Pins and Signals . . . . .	25
C-4	V.24 Pins and Signals . . . . .	27
C-5	V.24 to RS-232-C Pins and Signals . . . . .	29

## Preface

---

### Introduction

This guide tells you how to attach the cables to connect your DSV11-S to a modem, modem eliminator, or similar device. For simplicity, this guide uses the term modem to refer to all such devices.

Before following the procedures in this guide, your DSV11-S board must already be installed. In the case of a DSV11-SA, the board is installed in the factory. In the case of a DSV11-SF, the board is installed by DIGITAL field service personnel or by qualified self-maintenance customers following the instructions in the *DSV11-SF Communications Option Installation Guide*.

### Intended Audience

This guide is for anyone installing external cables to connect the DSV11-S to a modem.

### Associated Documents

- *DSV11-SF Communications Option Installation Guide (EK-DSV11-IN)*  
Tells you how to install the DSV11-S board in a BA200 series enclosure.
- *DSV11 Communications Option Technical Description (EK-DSV11-TD)*  
Provides a full description of the DSV11 device, detailing all DSV11 features and facilities.

## Structure of this Guide

The guide is divided into three chapters and three appendixes:

- Chapter 1* — Introduces and describes the DSV11.
- Chapter 2* — Describes how to connect the DSV11-S to a modem.
- Chapter 3* — Provides tests to check the cable installation.
- Appendix A* — Lists DSV11 cables and accessories.
- Appendix B* — Provides the general specifications of the DSV11.
- Appendix C* — Illustrates and describes the adapter cable pin signals.

## Introduction

---

This chapter introduces you to the major features of the DSV11 and shows a typical DSV11 configuration.

### 1.1 Features of the DSV11

The DSV11 is a two-channel, high-speed, synchronous communications option for use on MicroVAX II and BA200 series Q-bus backplanes. There are two variants of the DSV11:

- DSV11-M for MicroVAX enclosures
- DSV11-S for BA200 series enclosures

The major features of the DSV11 are described in the remainder of this section.

#### NOTE

The DSV11-S will not operate unless you install the appropriate device driver kit on your system:

- For version V4.7 of VMS, install the VAX DSV11 Device Driver kit
- For versions of VMS later than V4.7, install the VAX WAN Device Drivers kit

The DSV11 supports the following synchronous communications protocols:

- DDCMP
- HDLC/SDLC
- BISYNC

The maximum line speed available depends upon the protocol selected and the number of lines you wish to use. Note that you can run a different protocol on each of the lines. Table 1-1 shows the

maximum line speeds available. For the specific line speeds supported by your system, refer to your networking software documentation.

**Table 1-1 DSV11 Maximum Line Speeds**

Protocol	1 Line (bits/s)	2 Lines (bits/s)
DDCMP	256K	64K
HDLC/SDLC	256K	64K
BISYNC	19.2K	9.6K

**NOTE**

Maximum line speeds can be limited by the length of cable between the DSV11 and the modem. Chapter 2 provides details.

To connect your system to the outside world, the DSV11 allows you to use any of the following synchronous interfaces:

- RS-423
- RS-422
- RS-232/V.24
- V.35

The DSV11 also offers these features:

- DMA data transfer
- Full and half duplex operation
- Full modem control
- NRZ and NRZI data encoding

If you want to know more about the DSV11, the *DSV11 Communications Option Technical Description (EK-DSV11-TD)* contains detailed information on DSV11 features and facilities. The *DSV11 Communications Option Technical Description* is available from DIGITAL as a separately orderable item.



## 1.2 Typical DSV11 Configuration

Figure 1-1 illustrates a typical DSV11 configuration, showing the general layout of hardware and cables in the link between your system and the outside world.

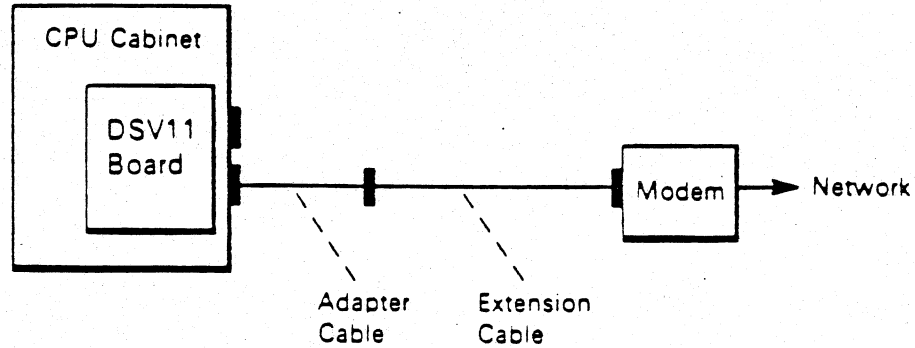
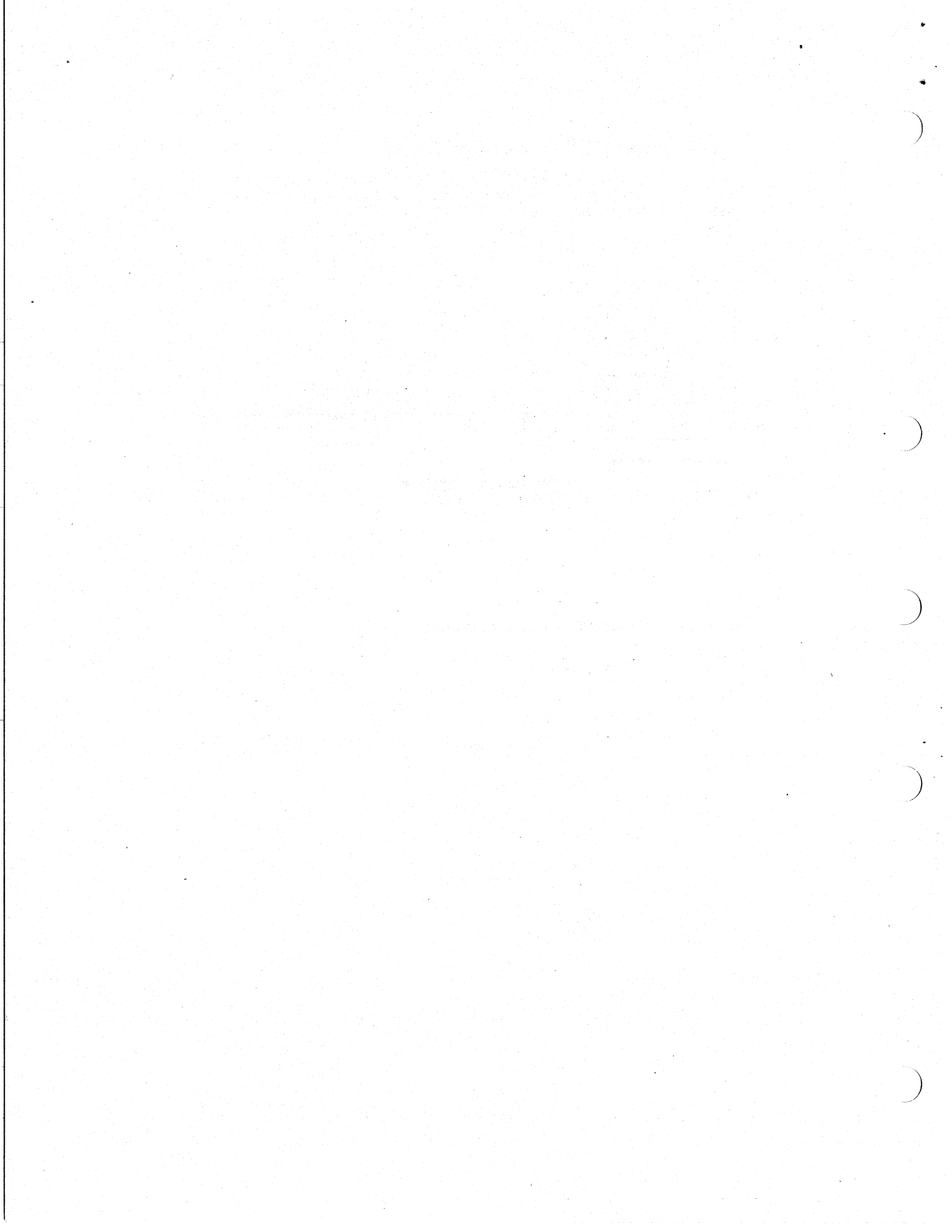

Figure 1-1 Typical DSV11 Configuration



# 2

## Connecting the DSV11-S

---

This chapter describes how to connect the DSV11-S to a modem. This involves attaching the adapter and extension cables.

### 2.1 Introduction

The DSV11-S board includes two 50-way connectors that remain prominent after the board is installed. You use these connectors to attach the cables connecting your DSV11-S to a modem (how to do this is shown in Section 2.2).

The 50-way connectors can provide signals for any of the DSV11-S supported interfaces. To make the 50-way output suitable for a specific interface, you have to use an interface-specific adapter cable. From the range of signals provided by the 50-way connector, the adapter cable selects only those required by the interface protocol. For example, you must use a V.35 adapter cable to be able to send data using the V.35 interface.

At one end, an adapter cable has a 50-way plug which attaches to the DSV11-S. At the modem end, the adapter cable has the interface standard connector. So, for example, at the modem end of the V.24 adapter cable is the standard V.24 25-way connector. Section A.1 lists the adapter cables and their type numbers and Appendix C illustrates and lists the signals associated with the modem end of each adapter cable.

Adapter cables are only 0.6 m (24 inches) long. You need an additional length of cable to complete the connection to a modem. Extension cables are used to connect the modem end of the adapter cable to the modem itself. Section A.2 lists the extension cables and their type numbers.

When you plan the length of cable between the DSV11-S and the modem, please note that the maximum data throughput you can achieve reduces with distance. Table 2-1 lists maximum cable lengths for a number of data rates using the DSV11-S supported interfaces.

Use this table to check that your cable run is not too long for the data rate you require.

**NOTE**

The CCITT V.35 recommendation specifies a maximum line speed of 48K bits/s. However, with the DSV11-S you can use the V.35 interface at higher speeds, as shown in Table 2-1.

**Table 2-1 Data Rate/Cable Length Relationships**

Line Protocol	Data Rate (bits/s)	Maximum Cable Length
V.24/RS-232-C	Up to 20K	15 m (50 ft)
RS-423	Below 1K	1200 m (3900 ft)
	20K	400 m (1300 ft)
	48K	160 m (500 ft)
	64K	130 m (400 ft)
	100K	85 m (270 ft)
RS-422	Below 90K	1200 m (3900 ft)
	128K	800 m (2600 ft)
	256K	400 m (1300 ft)
V.35	256K	60 m (200 ft)

Section 2.2 describes the steps involved in attaching the adapter and extension cables to connect your DSV11-S to the modem.

## 2.2 How to Attach the Adapter and Extension Cables

Step 1: Connect the Adapter Cable to the 50-Way Connector

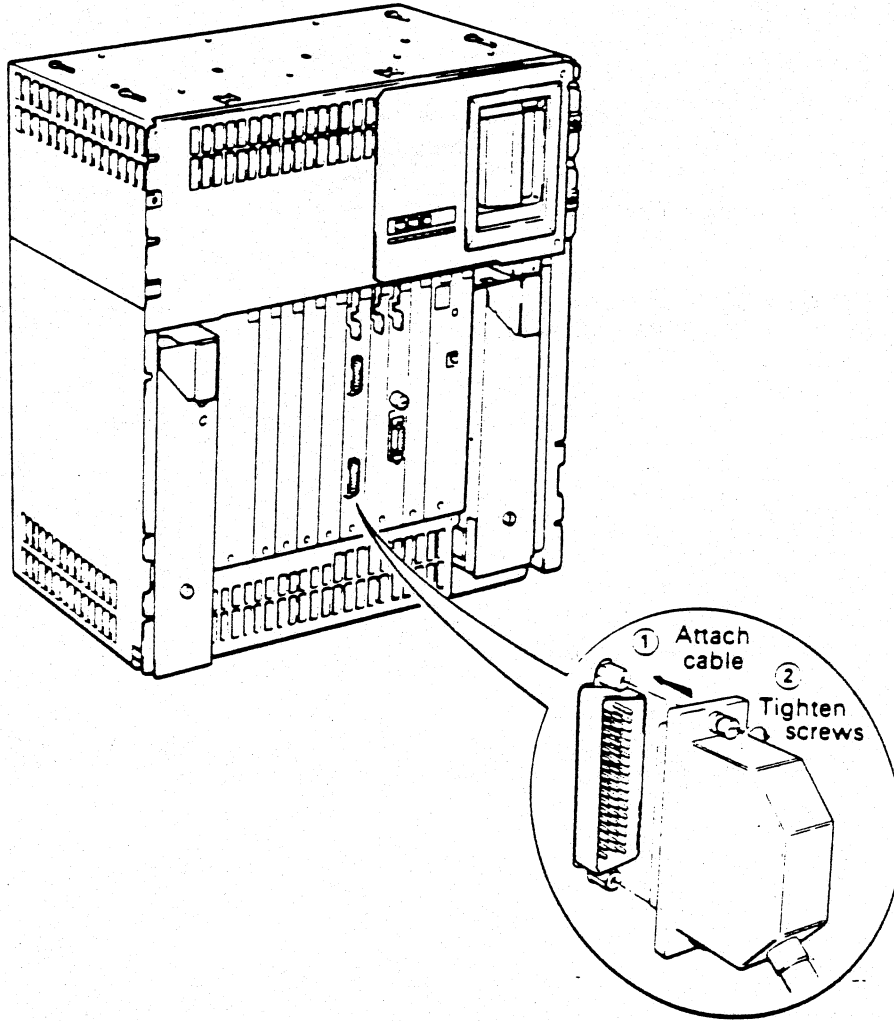

RE6213

**Step 2: Connect the Adapter Cable to the Extension Cable**

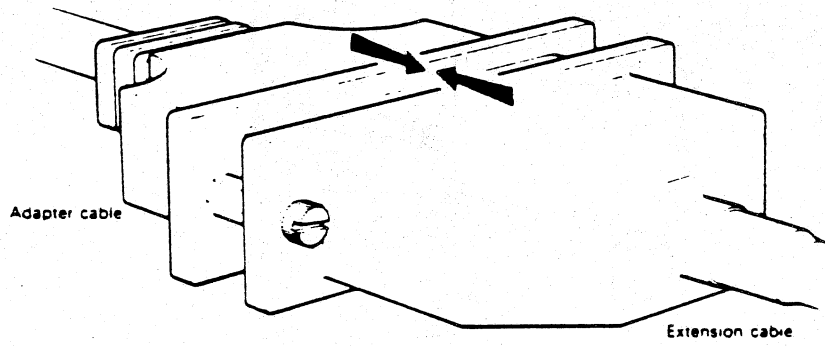

8 Connecting the DSV11-S

Step 3: Connect the Extension Cable to the Modem

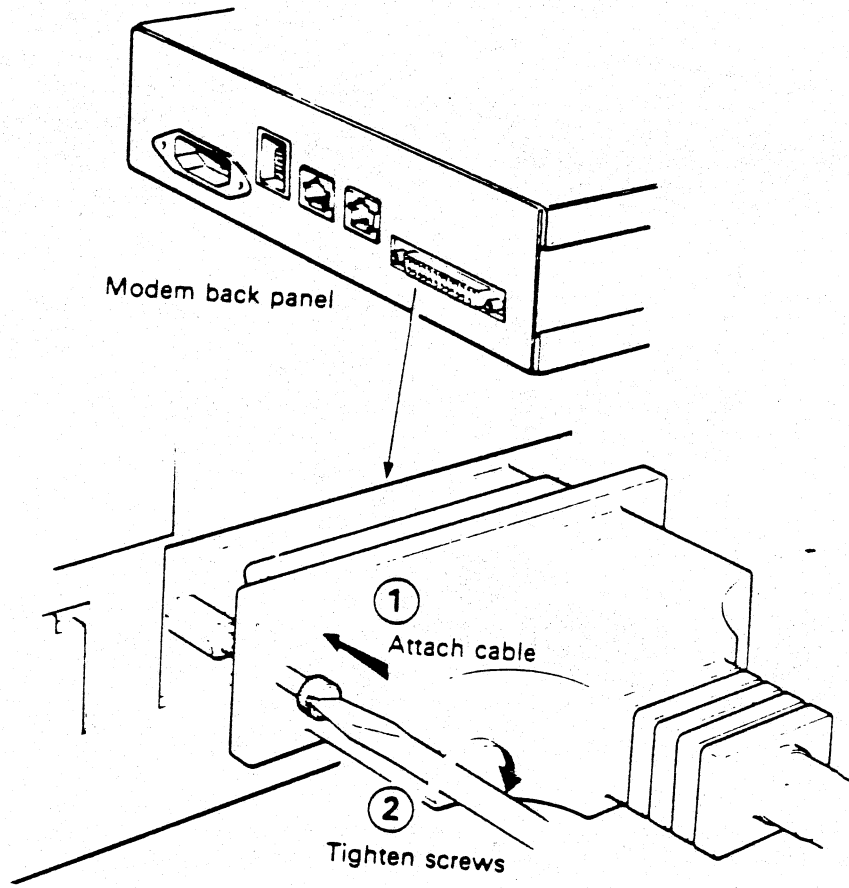

**Step 4: Check All Connections Are Complete**

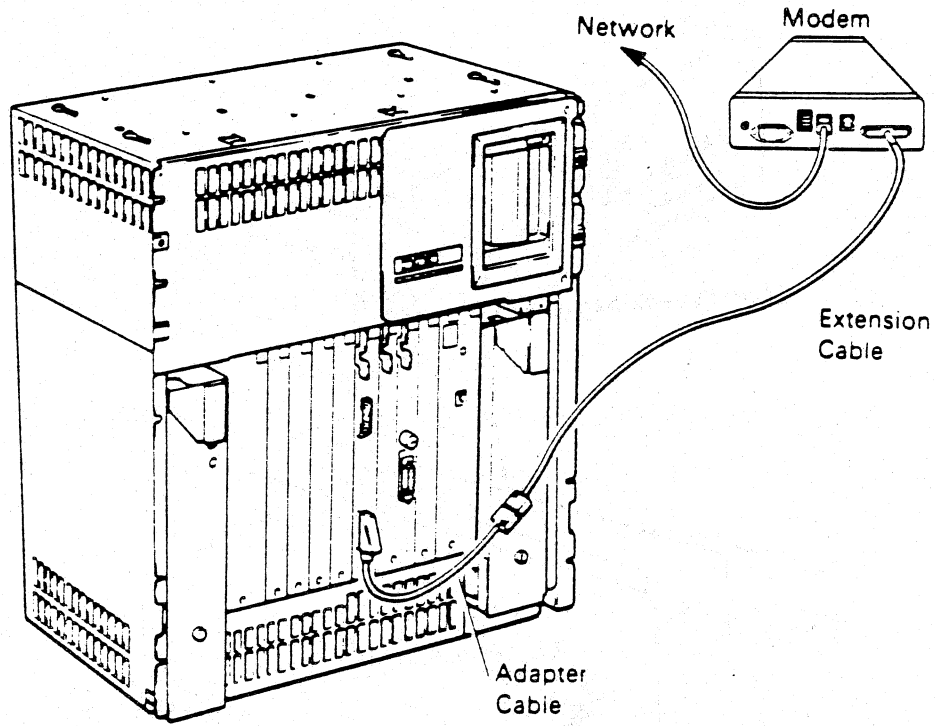



**Step 5: Test the Installation**

Now that your DSV11-S is connected to the modem, please follow the instructions in Chapter 3. Chapter 3 tells you how to use the Network Control Program (NCP) to check that the cables are connected correctly and that your DSV11-S system is operational.

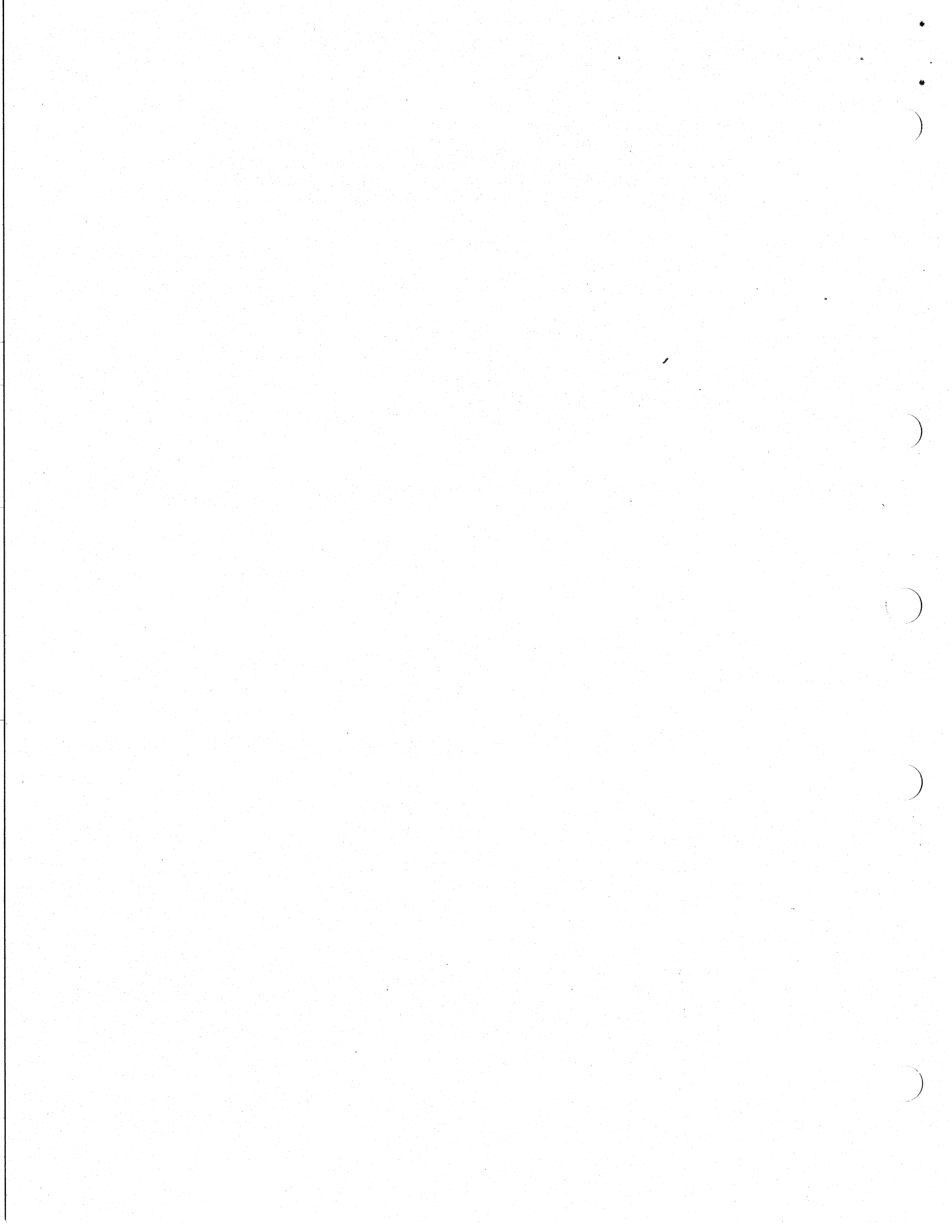

# 3

## Testing the Installation

---

This chapter describes basic checks to ensure that the cables between the DSV11-S and the modem have been attached correctly.

### 3.1 Preparation

Before running these tests:

1. Install either the DSV11 Device Driver kit (for VMS V4.7) or the VMS WAN Device Drivers kit (for versions of VMS later than V4.7) on your system.
2. Install, configure, and start the networking software (for example, VAX P.S.I.) on your system.
3. Log in to the SYSTEM account.

If you are going to use either a DECnet or an X.25 network, also start NCP by entering the following command:

```
S RUN SYSSYSTEM:NCP
NCP>
```

### 3.2 Test Procedure

This section details three basic tests to check that the cabling between your DSV11-S and the modem is sound. Use the test appropriate to the communications protocol your network uses:

- DDCMP (Test 1)
- HDLC/SDLC (Test 2)
- BISYNC (Test 3)

Tests 1 and 2 use NCP to perform loopback tests on a DECnet circuit or on an X.25 line. Test 3 asks you to perform one of your usual tasks using the remote application. Successful completion of a test indicates that the basic cabling between the DSV11-S and the modem

is sound. The installation is then complete and your DSV11-S is ready for use.

**NOTE**

The procedures described in this chapter do not exhaustively test the operation of the cables and the modem. To test fully the operation of the cables (including the modem signal and clock circuits) you must use the MDM Service Mode diagnostic, which has to be purchased separately. Details of MDM Service Mode can be found in the DSV11 COMMUNICATIONS OPTION TECHNICAL DESCRIPTION. If you have a DIGITAL maintenance contract for your system, DIGITAL Field Service personnel will test any cables supplied by DIGITAL.

**Test 1: LOOP CIRCUIT**

Run a DECnet circuit loopback test by following these steps:

1. Enter these NCP commands:

```
NCP> SET LINE DSV-c-n STATE ON
NCP> SET CIRCUIT DSV-c-n STATE ON
NCP> LOOP CIRCUIT DSV-c-n COUNT 10
```

where  $c$  is the DSV11-S controller number and  $n$  is the number of one of the circuits running over your DSV11-S.

This test loops back 10 messages, each made up of mixed binary digits.

2. Check the NCP message that is returned. This message indicates whether the test completed successfully or not. If the test fails, see Section 3.3.

**Test 2: LOOP LINE**

Run an X.25 line loopback test by following these steps:

1. Switch your modem into local loop mode or attach a loopback connector to the modem end of the extension cable.

2. Enter these NCP commands:

```
NCP> SET LINE DSV-c-n STATE OFF  
NCP> SET LINE DSV-c-n STATE SERVICE CONTROLLER NORMAL  
NCP> LOOP LINE DSV-c-n COUNT 10
```

where *c* is the DSV11-S controller number and *n* is the line number.

This test loops back 10 messages, each made up of mixed binary digits.

3. Check the NCP message that is returned. This message indicates whether the test completed successfully or not. If the test fails, see Section 3.3.

**Test 3: Perform One of Your Usual Tasks**

Test a system running the BISYNC protocol by trying to perform one of your usual tasks using the remote application. For example, try to execute a single command. If this command does not execute normally, see Section 3.3.

### 3.3 If a Test Fails

To check that the failure is not temporary, please try running the test several times.

If the test still fails, check all of the cable connections between your DSV11-S and the modem. If the connections seem good, check that your DSV11-S board is operational (see the *DSV11-SF Communications Option Installation Guide* for details).

If the board is operational, and the test still fails, refer to the problem solving information supplied with your networking software.

If the problem persists, please contact your local DIGITAL office.

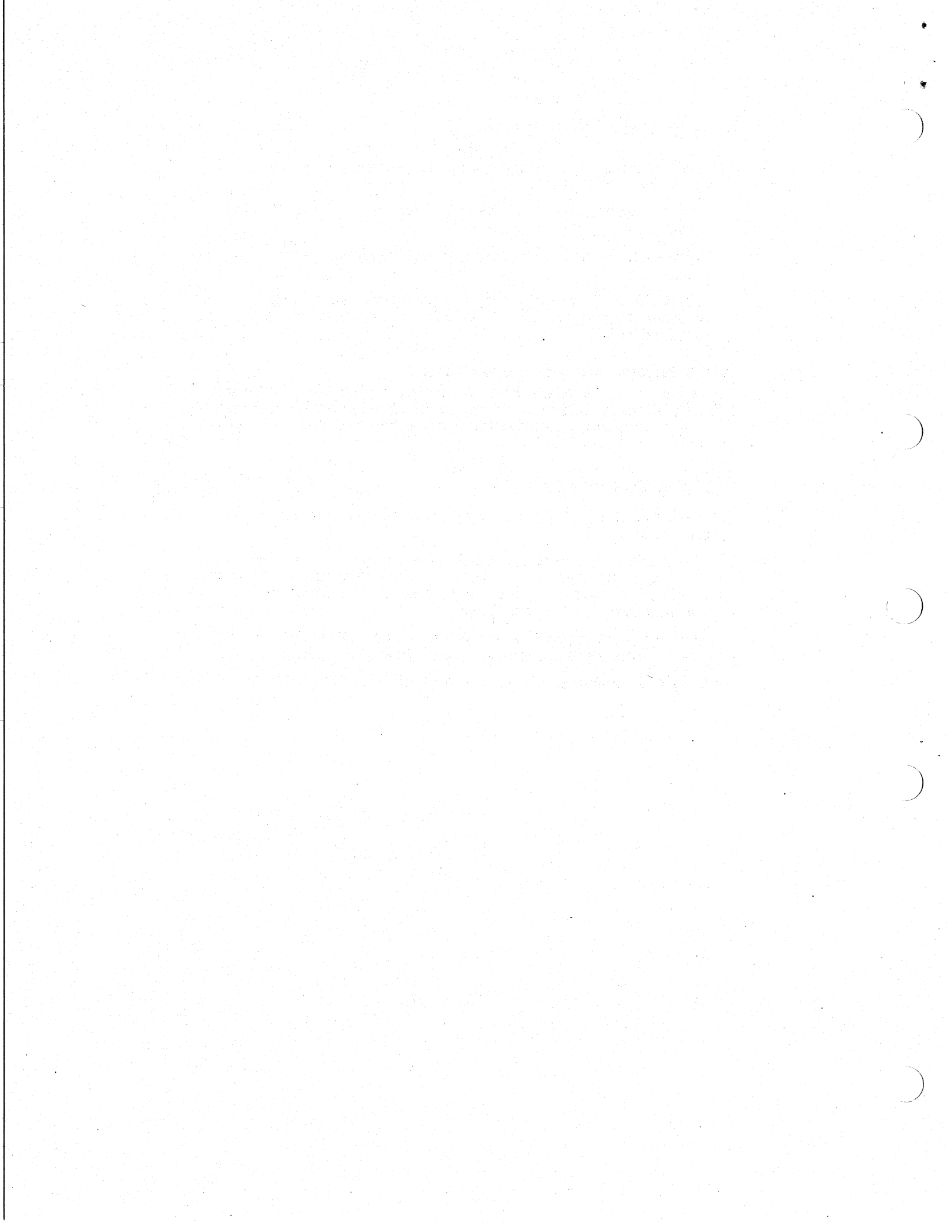

# A

## Cables and Accessories

---

This appendix contains tables listing the cables and loopback connectors used with the DSV11.

### A.1 Adapter Cables

---

Type	Description
BC19B-02	DSV11 to RS-422
BS19D-02	DSV11 to V.24 including the 12-27591-00 V.24 to RS-232-C adapter
BC19E-02	DSV11 to RS-423
BC19F-02	DSV11 to V.35

---

## A.2 Extension Cables

Type	Description
BC55D-XX	RS-422
BC22F-YY	V.24
BC55D-XX	RS-423
BC19L-XX	V.35

XX represents one of:

25	7.6 m (25 ft) long
50	15.2 m (50 ft) long
75	22.9 m (75 ft) long
A0	30.5 m (100 ft) long

YY represents one of:

10	3.1 m (10 ft) long
25	7.6 m (25 ft) long
35	10.7 m (35 ft) long
50	15.2 m (50 ft) long



### A.3 Loopback Test Connectors

Type	Description
H3199	Universal 50-way
H3248	Synchronous line loopback (RS-232-C)
H3198	Synchronous line loopback (RS-423)
H3198	Synchronous line loopback (RS-422)
H3250	Synchronous line loopback (V.35)

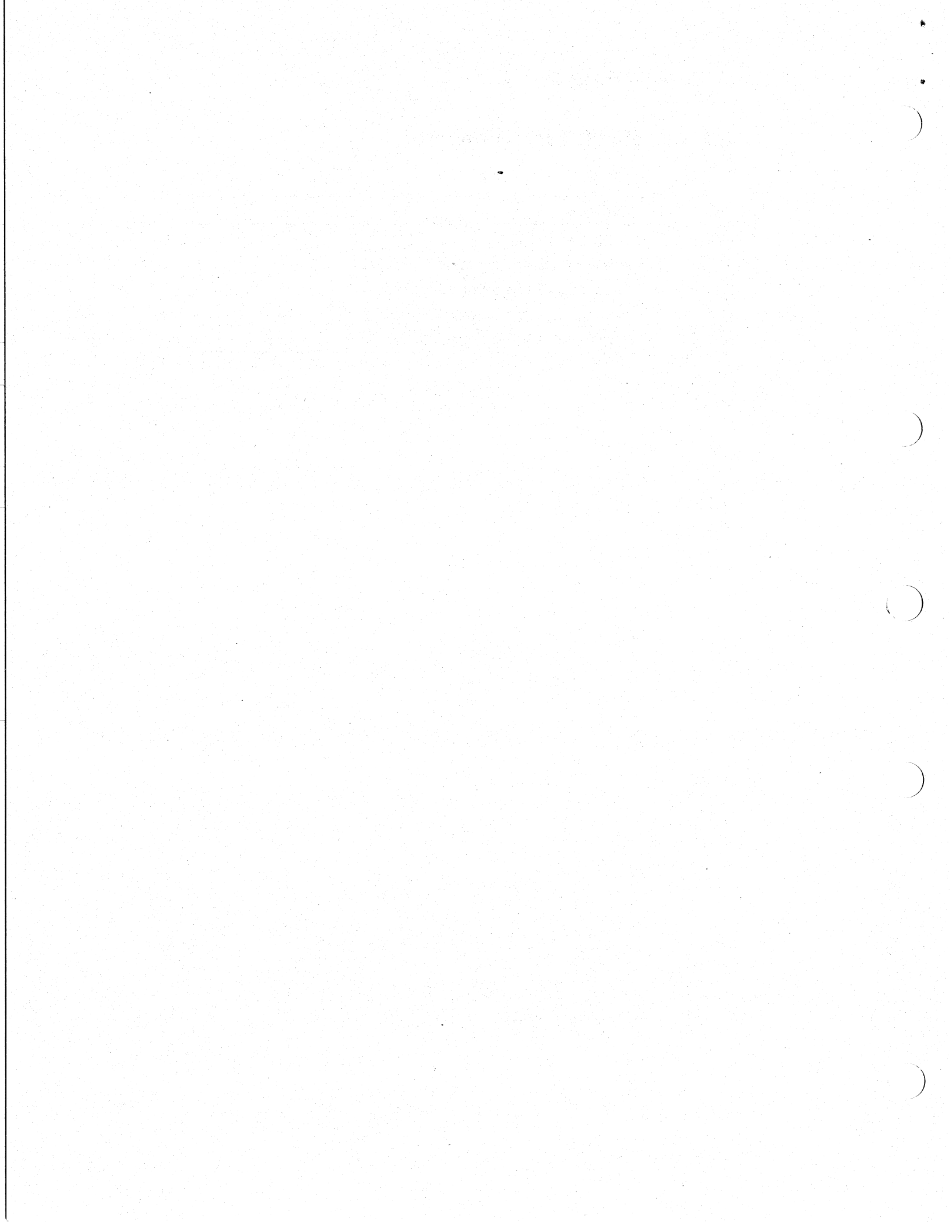

# B

## General Specifications

---

This appendix contains tables listing the environmental and electrical characteristics of the DSV11-S.

### B.1 Environmental Conditions

Only use or store the DSV11-S in an environment which corresponds to the limits defined in Table B-1.

**Table B-1 DSV11-S Environmental Limits**

Environment	Minimum	Maximum
Storage Temperature	-40°C (-40°F)	66°C (151°F)
Operating Temperature	5°C (41°F)	60°C (140°F)
Relative Humidity (Non-Condensing)	10%	95%

**NOTE**

DIGITAL normally defines the operating temperature range for a system as 5°C to 50°C (41°F to 122°F); the 10°C difference quoted above allows for the temperature gradient inside the system box.

## B.2 Electrical Requirements

**Table B-2 DSV11-S Electrical Requirements**

DC Voltage	Variance	Current	Power Consumption
+5 V	+ or -5%	6.5 A	32.5 W (maximum)
+12 V	+ or -5%	0.875 A	10.5 W (maximum)

Electrical loadings on the Q-bus are:

- AC load: 3.9
- DC load: 1.0

# C

## Adapter Cable Pin Signals

---

This appendix illustrates and lists the signals associated with the modem end of the adapter cables.

### C.1 Introduction

Each section in this appendix describes one adapter cable. The modem end pin-out is illustrated and a following table lists the pin numbers and their associated signals. These are the pin-outs described:

- RS-423 (Section C.2)
- RS-422 (Section C.3)
- V.35 (Section C.4)
- V.24 (Section C.5)
- V.24 to RS-232-C adapter connector (Section C.6)

#### NOTE

Throughout the tables, (A) or (B) after a signal name refers to wire A or B of a twisted pair.

## C.2 RS-423 Adapter Cable: 37-Way Pins

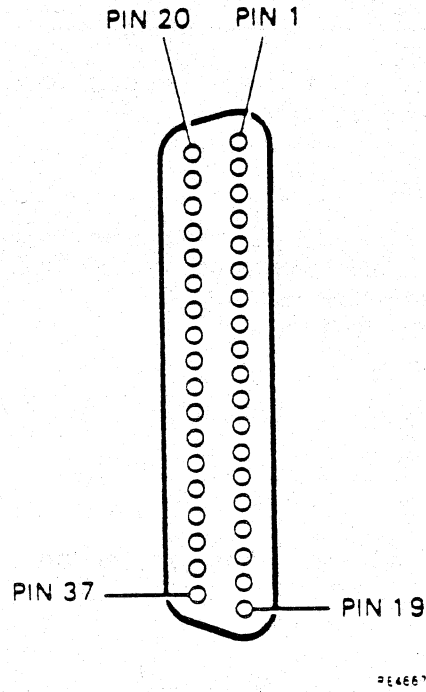

Figure C-1 37-Way D-Type Connector (Male)

**Table C-1 RS-423 Pins and Signals**

Pin	Signal Name	Pin	Signal Name
4	TX DATA	18	TEST INDICATE
5	TX CLOCK (A)	19	DTE GROUND
6	RX DATA (A)	20	DCE GROUND
7	RTS	22	DTE GROUND
8	RX CLOCK (A)	23	TX CLOCK (B)
9	CTS (A)	24	RX DATA (B)
10	LOCAL LOOP	25	DTE GROUND
11	DSR (A)	26	RX CLOCK (B)
12	DTR	27	CTS (B)
13	DCD (A)	29	DSR (B)
14	REMOTE LOOP	30	DTE GROUND
15	RI	31	DCD (B)
16	SPEED	35	DTE GROUND
17	CLOCK	37	DTE GROUND

### C.3 RS-422 Adapter Cable: 37-Way Pins

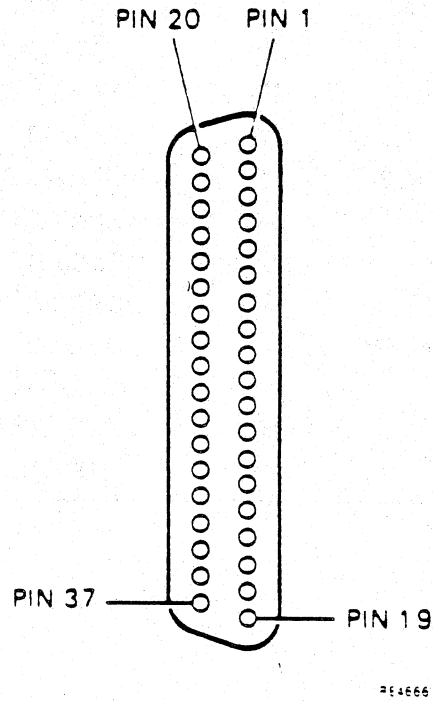

Figure C-2 37-Way D-Type Connector (Male)



**Table C-2 RS-422 Pins and Signals**

Pin	Signal Name	Pin	Signal Name
4	TX DATA (A)	18	TEST INDICATE
5	TX CLOCK (A)	19	DTE GROUND
6	RX DATA (A)	20	DCE GROUND
7	RTS (A)	22	TX DATA (B)
8	RX CLOCK (A)	23	TX CLOCK (B)
9	CTS (A)	24	RX DATA (B)
10	LOCAL LOOP	25	RTS (B)
11	DSR (A)	26	RX CLOCK (B)
12	DTR (A)	27	CTS (B)
13	DCD (A)	29	DSR (B)
14	REMOTE LOOP	30	DTR (B)
15	RI	31	DCD (B)
16	SPEED	35	CLOCK (B)
17	CLOCK (A)	37	DTE GROUND

### C.4 V.35 Adapter Cable: 34-Way Pins

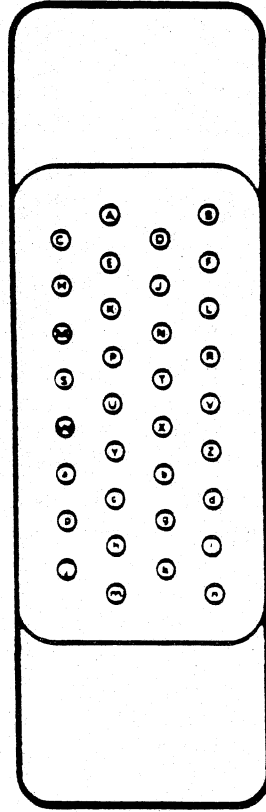

FE4665

Figure C-3 34-Way Square Connector (Male)

**Table C-3 V.35 Pins and Signals**

Pin	Signal Name	Pin	Signal Name
a	TX CLOCK (B)	R	RX DATA (A)
B	DTE GROUND	S	TX DATA (B)
C	RTS	T	RX DATA (B)
D	CTS	U	CLOCK (A)
E	DSR (A)	V	RX CLOCK (A)
F	DCD/I (A)	W	CLOCK (B)
H	DTR	X	RX CLOCK (B)
J	RI	Y	TX CLOCK (A)
P	TX DATA (A)		

### C.5 V.24 Adapter Cable: 25-Way Pins

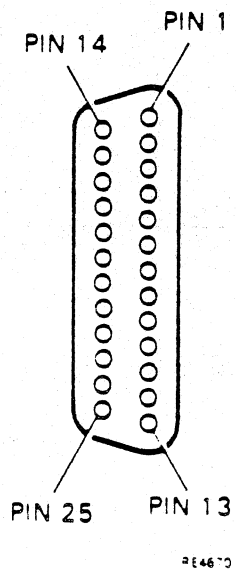
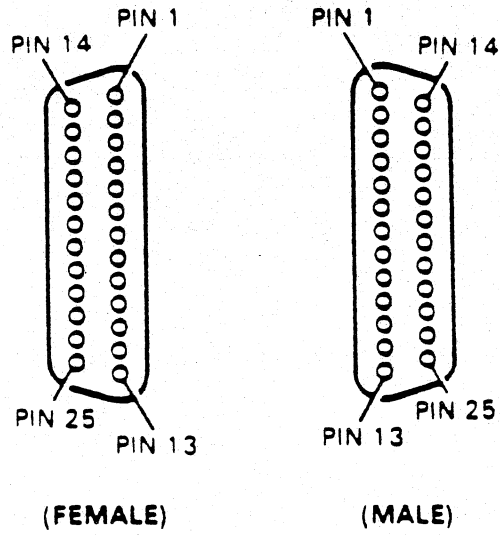

Figure C-4 25-Way D-Type Connector (Male)

**Table C-4 V.24 Pins and Signals**

Pin	Signal Name	Pin	Signal Name
2	TX DATA	17	RX CLOCK
3	RX DATA	18	LOCAL LOOP
4	RTS	20	DTR
5	CTS	21	REMOTE LOOP
6	DSR	22	RI
7	DTE GROUND	23	SPEED SELECT
8	DCD	24	CLOCK
15	TX CLOCK	25	TEST INDICATE

### C.6 V.24/RS-232-C Adapter Connector: 25-Way Pins



2E4664

Figure C-5 25-Way D-Type Connector (Male and Female)

**Table C-5 V.24 to RS-232-C Pins and Signals**

Pin Number (Male)	Signal Name	Pin Number (Female)
2	TX DATA	2
3	RX DATA	3
4	RTS	4
5	CTS	5
6	DSR	6
7	GROUND	7
8	DCD	8
15	TX CLOCK	15
17	RX CLOCK	17
20	DTR	20
22	RI	22
24	CLOCK	24
25	TEST INDICATE	25

Pins 18, 21, and 23 are not connected.

