

1978

DSV11-SF Communications Option
Installation Guide

Order Number EK-DSV11-IN-001

digital equipment corporation
maynard, massachusetts

First Edition, May 1988

The information in this document is subject to change without notice and should not be construed as a commitment by Digital Equipment Corporation.

Digital Equipment Corporation assumes no responsibility for any errors that may appear in this document.

The software, if any, described in this document is furnished under a license and may be used or copied only in accordance with the terms of such license. No responsibility is assumed for the use or reliability of software or equipment that is not supplied by Digital Equipment Corporation or its affiliated companies.

Copyright ©1988 by Digital Equipment Corporation.

All Rights Reserved.
Printed in U.S.A.

The following are trademarks of Digital Equipment Corporation:

BASEWAY	MicroPDP-11	RSX
BI Bus	Micro/RSTS	RT
DDCMP	Micro/RSX	ThinWire
DEC	MicroVAX	ULTRIX-32
DECmate	MicroVAX 3500	UNIBUS
DECnet	MicroVAX 3600	VAX
DECUS	PDP	VAXcluster
DECwriter	P/OS	VAXELN
DELNI	Professional	VAXstation II
DELQA	Q-bus	VAXstation II/GPX
DEQNA	Q22-bus	VMS
DESTA	Rainbow	VT
DIBOL	RSTS	Work Processor
MASSBUS		

digital™

FCC NOTICE: The equipment described in this manual generates, uses, and may emit radio frequency energy. The equipment has been type tested and found to comply with the limits for a Class A computing device pursuant to Subpart J of Part 15 of FCC Rules, which are designed to provide reasonable protection against such radio frequency interference when operated in a commercial environment. Operation of this equipment in a residential area may cause interference, in which case the user at his own expense may be required to take measures to correct the interference.

Contents

About This Manual	v
1 Description	
1.1 BA200 Series System Enclosure	1
1.2 DSV11-SF Module	3
2 Installation	
2.1 Unpacking the Option Kit	5
2.2 Inspecting the EMI and EOS Clips	7
2.3 Software Backup	8
2.4 Checking the System Configuration	8
2.4.1 Guidelines for Module Placement	11
2.5 Finding CSR Addresses and Interrupt Vectors	13
2.6 Configuring the DSV11-SF Module	15
2.7 Operating System Shutdown	17
2.8 Testing the Existing System	17
2.9 Relocating Modules	18
2.9.1 Modules with Blank Covers	18
2.9.2 Modules with Handies	20
2.10 Installing the DSV11-SF Module	22
2.11 Verifying the Ground Connections	22
3 Testing the New Configuration	
3.1 System Verification	26

Figures

1-1	BA200 Series Enclosures	2
1-2	DSV11-SF Module	3
2-1	DSV11-SF Option Kit Contents	6
2-2	EMI and EOS Clips	7
2-3	BA200 Series Configuration Worksheets	9
2-4	Bus Grant Continuity Path	11
2-5	DSV11-SF Module Layout	16
2-6	CSR Address Switch Setting Guide	17
2-7	Removing the Blank Covers	19
2-8	Unlocking the Release Levers	21
2-9	Inserting the Module	23
2-10	Ground Connections	24
2-11	Attaching the Gap Filler Assembly	25

Tables

1-1	DSV11-SF Maximum Line Speeds	4
2-1	DSV11-SF Option Kit Checklist	6
2-2	Power and Bus Load Data	10
2-3	Devices Supported by SYSGEN	14

About This Manual

This installation guide provides step-by-step instructions to install the DSV11-SF option kit in a BA200 series microsystem enclosure. The kit is designed for use in BA200 series enclosures only.

The DSV11-SF is a two-channel, high-speed synchronous communications option for BA200 series enclosures in MicroVAX systems.

Intended Audience

This document is intended only for Digital Field Service personnel or for qualified self-maintenance customers who have purchased a microsystems maintenance kit.

MicroVAX Systems Maintenance Kit part number ZNABX-GZ, C5

For the Self-Maintenance Customer

If you are not qualified to perform the installation of the DSV11-SF option kit, call Digital Field Service to schedule an installation.

It is your responsibility to perform a software backup before Digital Field Service personnel arrive at the site. This step is important to ensure that data is not lost during any installation process.

IMPORTANT

If you install the DSV11-SF option kit yourself, make sure you are wearing an antistatic wrist strap connected to a grounded antistatic work surface before you handle the modules. The system modules can be damaged by static discharge.

Also make sure the bus grant continuity path is intact after the installation. There cannot be any empty backplane slots between modules.

To install the DSV11-SF option kit, carefully follow the installation procedure in Chapter 2. If you have problems performing the installation, call Digital Field Service for assistance.

For Field Service

Make sure you take precautions against static when unpacking and installing the module. Use the groundstrap and antistatic mat found in the Static-Dissipative Field Service Kit (part number 29-26246). The antistatic kit is part of the Field Service tool kit, not the option kit.

To install the DSV11-SF option kit, carefully follow the installation procedure in Chapter 2. See the *DSV11-S Communications Option User Guide* for information on connecting the DSV11-SF to a modem.

Submit a LARS Form After the Installation: For information on completing this form, contact your unit manager.

Conventions

The following conventions are used in this guide:

- Warning** Provides information to prevent personal injury.
- Important** Provides information to prevent damage to equipment or software.
- Note** Provides general information about the current topic.
- PN** Indicates a part number.

Related Documents

The *DSV11-S Communications Option User Guide* (EK-DSV11-UG) is included in the DSV11-SF option kit.

You can order the following documents from Digital:

Document	Order Number
DSV11 Communications Option Technical Description	EK-DSV11-TD
MicroVAX Systems Maintenance Guide*	EK-O01AA-MG
MicroVAX 3500 and MicroVAX 3600 Systems Maintenance Update*	EK-159AA-UD
MDM User's Guide	AA-FM7AB-DN

*Included in the MicroVAX Systems Maintenance Kit (ZNABX-GZ, C5).

Digital personnel may order these documents from:

Digital Equipment Corporation
444 Whitney Street
Northboro, MA 01532

Attn: Publishing and Circulation Services (NR03/W3)
Order Processing Section

Customers in the United States may order documents from:

Digital Equipment Corporation
Peripherals and Supplies Group
P. O. Box CS2008
Nashua, NH 03061

Outside the United States, customers should contact their local Digital sales office.

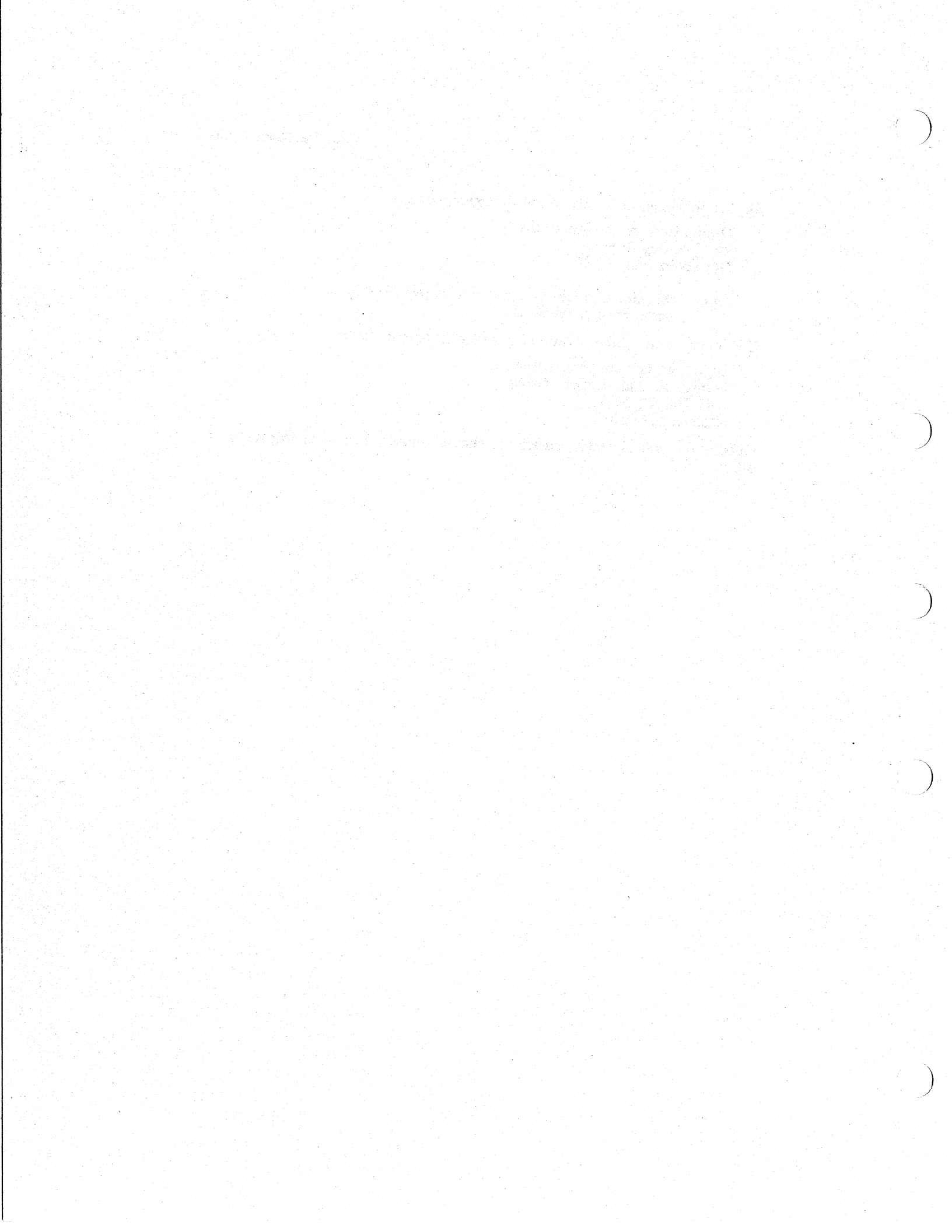

Description

This chapter describes the BA200 series enclosure and the DSV11-SF module.

1.1 BA200 Series System Enclosure

The BA200 series enclosure has a 6- or 12-slot Q22-bus backplane. Figure 1-1 shows the 12-slot BA213 and the 6-slot BA214 enclosure chassis. The BA213 has one or two modular power supplies, and the BA214 has one power supply.

The backplane implements the Q22-bus on the AB rows of each slot. The CD interconnect is implemented on the CD rows of each slot. Fixed disk drives face the rear of the enclosure, providing easy access to the drive signal and power cables. A TK tape drive faces the front of the enclosure.

The major difference between the BA200 series enclosure and other microsystem enclosures is the way you connect external devices to the system. Modules in the BA200 series enclosure connect directly to external devices through I/O connectors on the module handles. Other enclosures require an insert panel and internal cabling between the option module and the device.

There are two main differences between the modules used in the BA200 series enclosure and the modules used in the other microsystem enclosures.

- Option modules with external I/O connectors have attached bulkhead handles. These handles replace the insert panels and internal cabling found in the BA23 and BA123 enclosures.
- Non-I/O modules (such as memory modules) have blank bulkhead covers.

2 Description

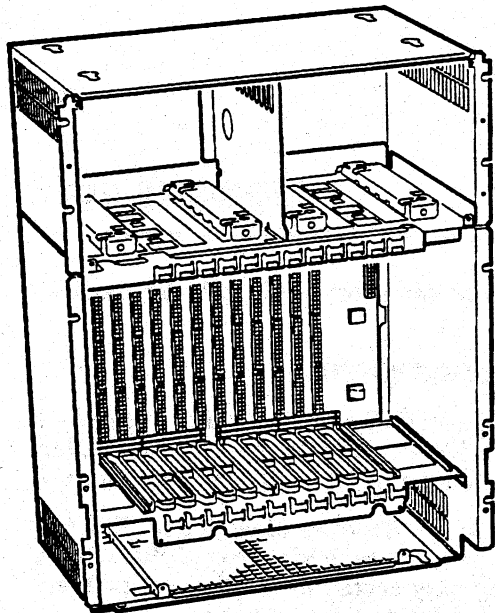

BA213 ENCLOSURE

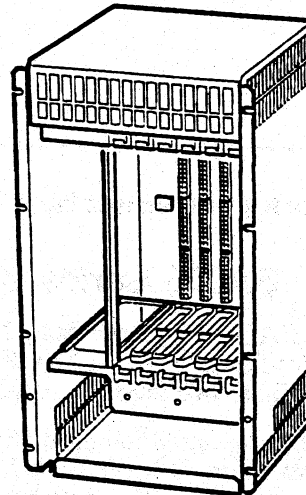

BA214 ENCLOSURE

MA-X0008-88

Figure 1-1 BA200 Series Enclosures

In addition, BA200 series enclosures use a special I/O connecting cover that fits over the CPU module. The H3600-SA cover has a two-piece ribbon cable that plugs into the console SLU and power-up configuration connectors on the CPU.

The module handles and blank covers form an electrical seal that complies with regulations for electromagnetic interference (EMI) for (1) keeping radio frequency interference generated by the system in the enclosure, and (2) preventing external radio frequencies from entering the enclosure. The module handles and blank covers also help guarantee proper airflow.

For more information: See the *MicroVAX Systems Maintenance Guide* to learn more about BA200 series enclosures.

1.2 DSV11-SF Module

The DSV11-SF module (Figure 1-2) is a two-channel, high-speed synchronous communications option for BA200 series enclosures in MicroVAX systems. It is a quad-height module. The DSV11-SF will not operate unless you install the appropriate device driver kit.

- For VMS version 4.7, install the VAX DSV11 Device Driver Kit.
- For versions of VMS later than 4.7, install the VAX Wide Area Networks (WAN) Device Driver Kit.

For more information on the device driver kits, contact your local Digital sales office.

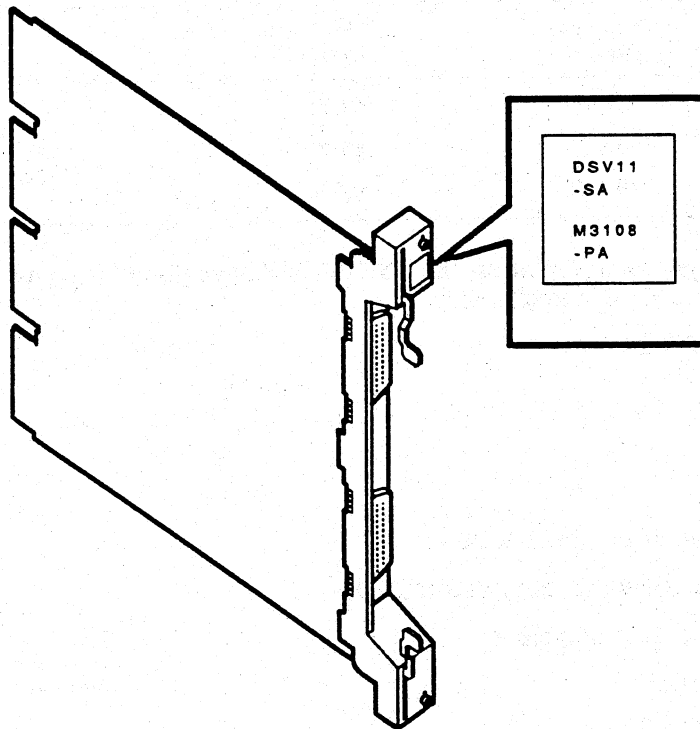

MA-X0000-88

Figure 1-2 DSV11-SF Module

4 Description

The DSV11-SF supports the following synchronous communications protocols:

- DDCMP (Digital data communications message protocol)
- HDLC/SDLC (high-level data-link control/synchronous data-link control)
- BISYNC (binary synchronous protocol)

The maximum line speed available depends on the protocol selected and the number of lines you want to use. You can run a different protocol on each line. Table 1-1 shows the maximum line speeds available. For the specific line speeds supported by your system, see your networking software documentation.

Table 1-1 DSV11-SF Maximum Line Speeds

Protocol	One Line (Bits/s)	Two Lines (Bits/s)
DDCMP	256 K	64 K
HDLC/SDLC	256 K	64 K
BISYNC	19.2 K	9.6 K

To connect your system to a modem, the DSV11-SF allows you to use any of the following synchronous interfaces:

- RS-232/CCITT V.24
- RS-422
- RS-423
- CCITT V.35

The DSV11-SF also offers these features.

- Direct memory access (DMA) data transfer
- Full- and half-duplex operation
- Full modem control
- NRZ and NRZI data encoding

For more information: See the *DSVII Communications Option Technical Description* to learn more about DSV11-SF features.

2

Installation

This chapter provides step-by-step procedures for unpacking, inspecting, and installing the DSV11-SF option kit in a BA200 series enclosure. This chapter also discusses system and module configurations.

WARNING

The following installation instructions provide specific directions for the safe installation of the module kit. To protect yourself from possible shock or energy hazards, do not try to access or disassemble parts of the equipment other than those specified. Refer other servicing to qualified personnel.

2.1 Unpacking the Option Kit

Unpack the shipment and check the contents as follows. If any item is missing or damaged:

- contact the customer's sales representative.
- contact the customer's delivery agent.
- 1. Look for external damage on the shipping container, such as dents, holes, or crushed corners.
- 2. Do not dispose of the packing material until you have installed the module and tested the system successfully.

IMPORTANT

Use the Static-Dissipative Field Service Kit (PN 29-26246) for the next step. If you have another antistatic kit, follow the instructions with the kit.

3. Put on your antistatic wrist strap. Attach the alligator clip to the metal chassis of the BA200 series enclosure. Place the antistatic mat on your work surface. The ground cord has a snap that connects to the mat.
4. Use Table 2-1 to identify the contents of the DSV11-SF option kit. The checklist numbers correspond to the numbered items in Figure 2-1.

6 Installation

5. Remove the DSV11-SF module from the antistatic bag.
6. Inspect the module for shipping damage. Carefully check for cracks, breaks, and loose components.

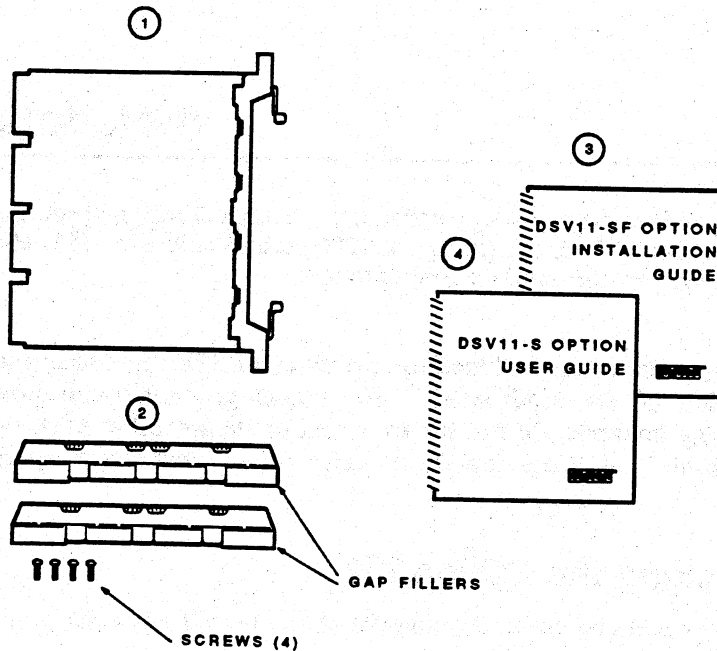

Figure 2-1 DSV11-SF Option Kit Contents

Table 2-1 DSV11-SF Option Kit Checklist

Part Description	Part Number
1 DSV11-SF module	M3108-PA
2 Two gap filler assemblies, consisting of two gap fillers and four flathead screws	70-24505-01
3 Installation guide	EK-DSV11-IN
4 User guide	EK-DSV11-UG

2.2 Inspecting the EMI and EOS Clips

To comply with regulations on electromagnetic interference (EMI), the bulkhead handles, blank covers, and gap fillers have transient protection EMI and electrical overstress (EOS) clips. These clips are grounded through the module handle.

1. Check the EMI and EOS clips on the DSV11-SF for residue or corrosion (Figure 2-2). Also check the EMI clips on the two gap fillers. Remove any residue or corrosion with alcohol.

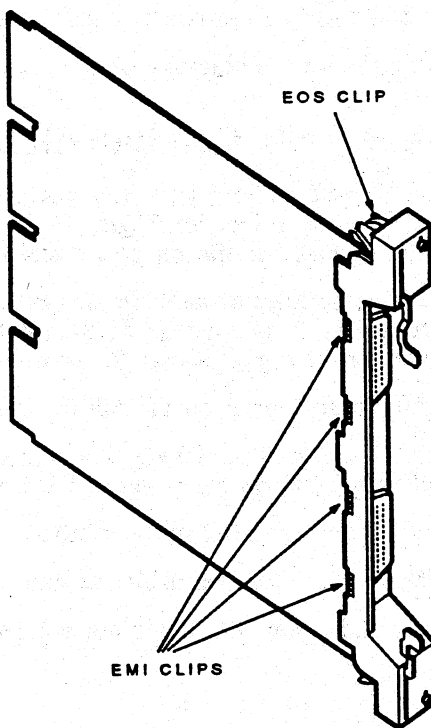

MA-X0011-88

Figure 2-2 EMI and EOS Clips

8 Installation

2. Make sure the EMI and EOS clips are arched. When you press them slightly, they should return to their original shape.
3. If any clip is missing or broken, replace it.

EMI clip	PN 12-26340-01
EOS clip	PN 12-26922-01
4. Place the DSV11-SF module on the antistatic mat.

2.3 Software Backup

It is the customer's responsibility to perform a software backup. Make sure the customer backs up the software before you continue.

2.4 Checking the System Configuration

Before you install the DSV11-SF option, you must complete a configuration worksheet for your BA200 series enclosure (Figure 2-3). This step ensures that you do not exceed the system's limits for power and bus loads.

You need to gain access to the modules installed in the system backplane before you configure the system. Refer to the system documentation for procedures to help you remove any covers and gain access to the modules.

To check the system configuration, perform the following steps:

1. On the worksheet, list all the devices already installed in the system. Each module has an identifying label on the cover or handle.
2. List all the devices you plan to install in the system.
3. Fill in the information for each device, using the data listed in Table 2-2.
4. Add up the columns. Make sure the totals are within the limits for the enclosure.

12 SLOT ENCLOSURE

RIGHT-HALF POWER SUPPLY					BUS LOADS	
SLOT (ABCD)	MODULE	CURRENT		POWER (WATTS)	AC	DC
		5 V	12 V			
1						
2						
3						
4						
5						
6						
MASS STORAGE					0.0	0.0
>>> TAPE 1					0.0	0.0
>>> DISK 1						
TOTAL: RIGHT-HALF POWER SUPPLY					--	--
MUST NOT EXCEED		33.0	7.0	230.0	--	--
LEFT-HALF POWER SUPPLY					BUS LOADS	
SLOT (ABCD)	MODULE	CURRENT		POWER (WATTS)	AC	DC
		5 V	12 V			
7						
8						
9						
10						
11						
12						
MASS STORAGE					0.0	0.0
DISK					0.0	0.0
DISK					0.0	0.0
TOTAL: LEFT-HALF POWER SUPPLY						
MUST NOT EXCEED		33.0	7.0	230.0		
TOTAL BUS LOADS					35.0	20.0
MUST NOT EXCEED						

6 SLOT ENCLOSURE

POWER SUPPLY					BUS LOADS	
SLOT (ABCD)	MODULE	CURRENT		POWER (WATTS)	AC	DC
		5 V	12 V			
1						
2						
3						
4						
5						
6						
TOTAL: POWER SUPPLY						
MUST NOT EXCEED		33.0	7.0	230.0	--	--
TOTAL: BUS LOADS					35.0	20.0
MUST NOT EXCEED						

NOTE: POWER SUPPLIES MAY DIFFER. CHECK YOUR POWER SUPPLY SPECIFICATIONS TO CONFIRM THE MAXIMUM WATTAGE.

MA-X0012-88

Figure 2-3 BA200 Series Configuration Worksheets

Table 2-2 Power and Bus Load Data

Option	Module	Current (Amps) (Max)		Power (Max)	Bus Loads	
		+5 V	+12 V	Watts	AC	DC
AAV11-SA	A1009-PA	1.8	0.0	9.0	2.1	0.5
ADV11-SA	A1008-PA	3.2	0.0	16.0	2.3	0.5
AXV11-SA	A026-PA	2.0	0.0	10.0	1.2	0.3
CXA16-M	M3118-YA	1.6	200 mA	10.4	3.0	0.5
CXB16-M	M3118-YB	2.0	0.0	10.0	3.0	0.5
CXY08-M	M3119-YA	1.8	300 mA	12.6	3.2	0.5
DELQA-SA	M7516-PA	2.7	0.5	19.5	2.2	0.5
DEQNA-SA	M7504	3.5	0.50	23.5	2.2	0.5
DFA01	M3121-PA	1.97	0.40	14.7	3.0	1.0
DPV11-SA	M8020-PA	1.2	0.30	9.6	1.0	1.0
DRQ3B-SA	M7658-PA	4.5	0.0	22.5	2.0	1.0
DRV1J-SA	M8043-PA	1.8	0.0	9.0	2.0	1.0
DRV1W-SA	M7651-PA	1.8	0.0	9.0	2.0	1.0
DSV11-SA	M3108-PA	5.43	0.69	38.0	3.9	1.0
DZQ11-SA	M3106-PA	1.0	0.36	9.3	1.4	0.5
IBQ01-SA	M3125-PA	5.0	0.0	25.0	4.6	1.0
IEQ11-SA	M8634-PA	3.5	0.0	17.5	2.0	1.0
KA630-AA	M7606	6.2	0.14	32.7	2.7	1.0
KA650-AA/BA	M7620-A/B	6.0	0.14	33.6	2.7	1.0
KDA50-Q	M7164	6.93	0.0	34.65	3.0	0.5
KDA50-Q	M7165	6.57	0.03	33.21	-	-
KLESI-SA	M7740-PA	3.0	0.0	15.0	2.3	1.0
KMV1A-SA	M7500-PA	2.6	0.2	15.4	3.0	1.0
KWV11-SA	M4002-PA	2.2	13 mA	11.156	1.0	0.3
LPV11-SA	M8086-PA	1.6	0.0	8.0	1.8	0.5
MRV11-D	M7942	1.6*	0.0	8.0	3.0	0.5
M9060-YA		5.3	0.0	26.5	0.0	0.0
MS630-AA	M7607	1.0	0.0	5.0	-	-
MS630-BA	M7608	1.3	0.0	6.5	-	-
MS630-CA	M609	2.1	0.0	10.5	-	-
MS650-AA	M7621-A	2.7	0.0	13.5	-	-
RA70		3.3	2.9	69.4	-	-

*Value is for the unpopulated module only.

Table 2-2 (Cont.) Power and Bus Load Data

Option	Module	Current (Amps) (Max)		Power (Max)	Bus Loads	
		+5 V	+12 V	Watts	AC	DC
RD53		0.9	2.5	34.5	-	-
RD54		1.3	1.34	23.7	-	-
TK50E-EA		1.35	2.4	35.6	-	-
TK70E-EA		1.3	2.4	35.3	-	-
TQK50	M7546	2.9	0.0	14.5	2.8	0.5
TQK70-SA	M7559	3.5	0.0	17.5	4.3	0.5
TSV05-SA	M7196	6.5	0.0	32.5	3.0	1.0

2.4.1 Guidelines for Module Placement

Bus Continuity

Bus grant signals pass through each installed module, using the A connectors of each slot. Figure 2-4 shows the path of the bus grant signals. To ensure the continuity of this path, use bus grant continuity cards (M9047) in empty backplane slots.

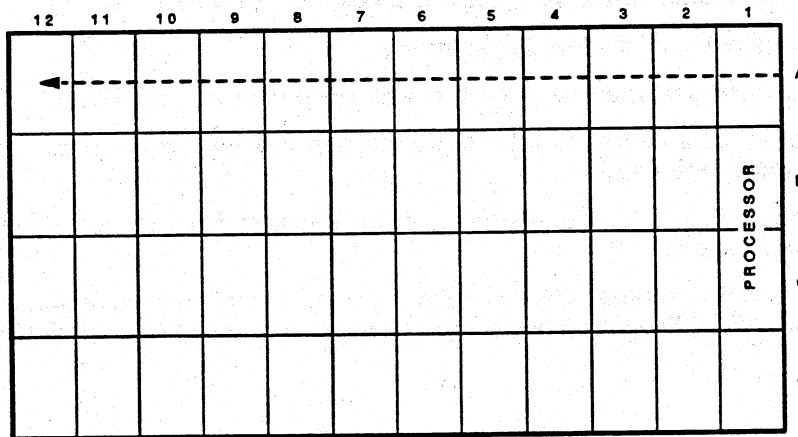

MA-X0013-88

Figure 2-4 Bus Grant Continuity Path

12 Installation

Power Supplies

The BA200 series enclosure contains one or two 230 watt power supplies.

- A 6-slot enclosure has one power supply, to the left of the backplane.
- A 12-slot enclosure has two power supplies.
 - The power supply to the right of the backplane powers slots 1 through 6.
 - The power supply to the left of the backplane powers slots 7 through 12.

Each power supply in the enclosure must have a minimum 5 amp load on the 5 volt output to maintain regulation. If a power supply does not meet the minimum load requirement, you *must* install an M9060-YA load module in one of the open backplane slots powered by that power supply. Otherwise, the power supply enters an error mode and shuts down the system.

If a power supply meets the minimum load requirement, you should remove an existing load module. See Section 2.9 for procedures on installing or removing a load module.

Module Order

The order of modules in the backplane depends on four factors.

- The relative use of devices in the system
- The expected performance of each device relative to other devices
- The ability of a device to tolerate delays between bus requests and bus grants (delay tolerance)
- The tendency of a device to prevent devices farther from the CPU from accessing the bus

Use the following recommended module order as a guideline for installing modules in a BA200 series enclosures. Start in the left column and read down.

KA620/KA630/KA650	CXA16
MS630/MS650	CXF32
AAV11	LPV11
ADV11	VCB02
AXV11	DRV1W
KWV11	IEQ11
DRV1J	ADQ32
TSV05	DRQ3B
DMV11	IBQ01
DEQNA/DELQA/DESQLA	KLESI
DPV11	TQK50
DSV11	TQK70
KMV1A	RQDX3
DZQ11	KDA50
DFA01	KFQSA
CXY08	M9060
CXB16	

2.5 Finding CSR Addresses and Interrupt Vectors

When you add a DSV11-SF module to the backplane, you need to configure the new module and reconfigure the modules already installed. Use the following procedures to find the new CSR addresses and interrupt vectors for the modules.

For modules in a MicroVAX system, you can (1) use the CONFIG program, or (2) manually calculate CSR addresses and interrupt vectors. To calculate values manually, see Chapter 5 of the *MicroVAX Systems Maintenance Guide*.

The CONFIG program is in the MicroVMS or VMS SYSGEN utility. When you type in a list of the devices in the system, CONFIG automatically provides CSR address and interrupt vector information. Table 2-3 lists the devices supported by this utility.

If you have a non-Digital device, see the device documentation for configuration information.

Table 2-3 Devices Supported by SYSGEN

Device	Enter at DEVICE> Prompt
CXA16	DHV11
CXY08	DHV11
DELQA	QNA
DEQNA	QNA
DPV11	DPV11
DRV1W	DR11W
DSV11	DSV11
DZQ11	DZ11
IEQ11	IEQ11
RQDX3	UDA
TQK50/TQK70	TU81
TSV05	TS11

To use the SYSGEN utility, follow these steps:

1. With VMS or MicroVMS running, log in to the system account.
2. Type the following command at the system command prompt:

```
MCR SYSGEN
```

3. Press **Return**. The utility responds with the prompt

```
SYSGEN>
```

4. At the prompt, type

```
CONFIGURE
```

5. Press **Return**. The utility responds with the prompt

```
DEVICE>
```

6. Enter the abbreviation for each system device (Table 2-3). Include those devices already installed and those you intend to install.

Enter one abbreviation per line, then press **Return**. The DEVICE> prompt prompts you for another entry. If you are installing more than one unit of a particular device, enter a space and the number of devices after the abbreviation. For example, `dhv11 2` indicates two DHV11 modules.

7. After you have entered all devices, type **Ctrl Z**. The program displays the following information for each device you entered:
 - CSR address and vector
 - the name assigned to the device by the operating system
 - the operating system support status (yes or no)

The program uses an asterisk (*) to indicate a floating address or vector. If there is more than one unit of a particular device, the first address refers to the first device to be installed.
8. To exit from the SYSGEN utility, type **EXIT** at the SYSGEN prompt and press **Return**.
9. Log out of the system account.

2.6 Configuring the DSV11-SF Module

You select the CSR address for the DSV11-SF by using switchpack 1 (E32) on the module (Figure 2-5). The CSR address is floating. The factory setting for the DSV11-SF is 17760640₈. If the system has other options with floating addresses, you may need to change the factory setting. To calculate the CSR address for the DSV11-SF, see Section 2.5. Use Figure 2-6 as a guide in setting the switches.

The interrupt vector is also floating. It is set by the software and cannot be changed by switches.

Switches 5 and 6 on switchpack 2 (E89) provide bus grant continuity and DMA continuity (Figure 2-5). These switches must be off (open) when the DSV11-SF is installed in a BA200 series enclosure. Switches 1 to 4 are always on (closed).

NOTE

Switchpacks differ in physical appearance. Use Figures 2-5 and 2-6 only for guidance as to whether a switch is on (closed) or off (open).

16 Installation

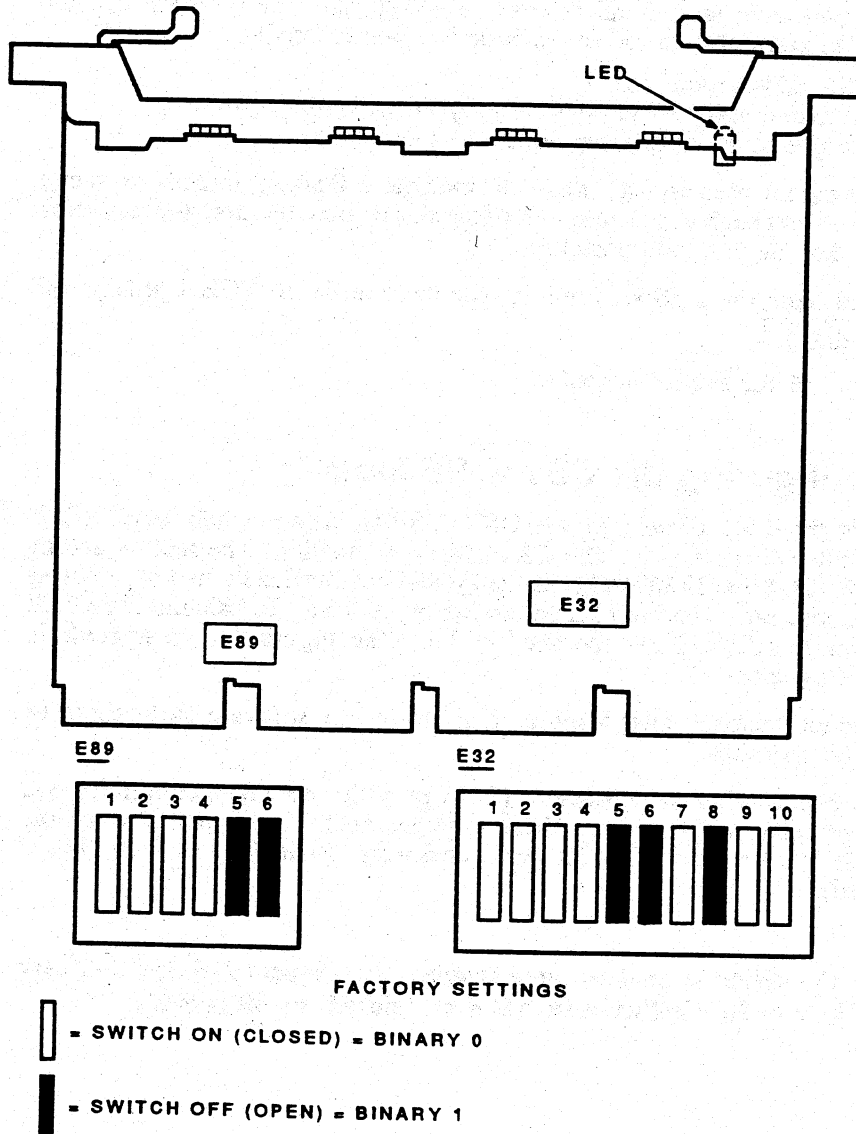

Figure 2-5 DSV11-SF Module Layout

MA-X0014-88

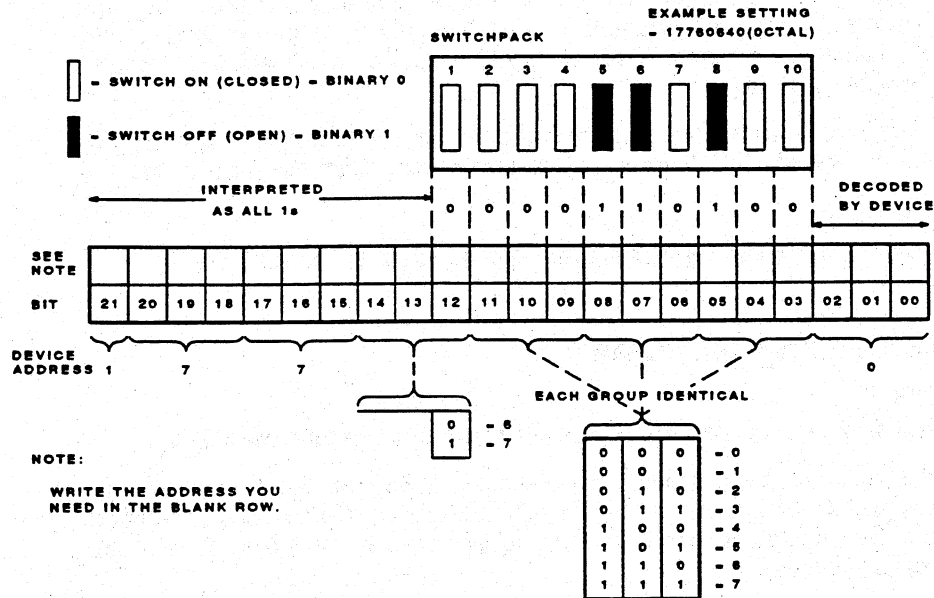

Figure 2-6 CSR Address Switch Setting Guide

2.7 Operating System Shutdown

It is the customer's responsibility to shut down the operating system software.

Make sure the customer shuts down the operating system software before you continue. Have the customer leave the system power on.

2.8 Testing the Existing System

You need to gain access to the system controls before you can test the existing system. Refer to the system documentation for procedures to help you gain access to the system controls. Test the existing MicroVAX system as follows:

1. Insert the MicroVAX diagnostic monitor (MDM) diagnostic tape cartridge into the system's tape drive.
2. Boot the tape drive.

3. Test the existing system to make sure it is running properly. See the *MicroVAX Systems Maintenance Guide* for information on testing and troubleshooting. Chapter 3 of this guide also has information on testing and troubleshooting.
4. After the test runs successfully, remove the tape cartridge and turn the power switch off (0). Unplug the ac power cord from the wall outlet.

IMPORTANT

Always remove the tape cartridge before turning power off.

2.9 Relocating Modules

IMPORTANT

Only qualified service personnel should remove or install modules.

Check the recommended module order listed in Section 2.4.1 to determine which slot you should install the DSV11-SF module in. If you need to relocate modules in the backplane, use the following procedures and keep the modules in their original order.

2.9.1 Modules with Blank Covers

Use the following procedure to remove and install modules with blank covers:

IMPORTANT

Make sure you are wearing a grounded antistatic wrist strap when you remove or install modules. Place modules only on a grounded antistatic mat.

1. Release the two 1/4-turn captive screws that hold the blank cover to the card cage (Figure 2-7).
2. Pull the blank cover away from the card cage.
3. Note the orientation of any internal cables connected to the module. Some connectors are not keyed. Carefully label and disconnect the internal cables.
4. Unlock the module's release levers by simultaneously pulling up on the top lever and pulling down on the bottom lever (Figure 2-8). For a module with a plastic handle, pull out on the plastic handle.
5. Carefully pull the module out of the card cage. Be careful not to disturb any switchpacks on the module.

6. Confirm the module's CSR address and interrupt vector (Section 2.5). If necessary, change the module's jumper or switch settings.
7. Install the module in its new location by reversing the steps in this procedure. Do not fasten the 1/4-turn screws yet.

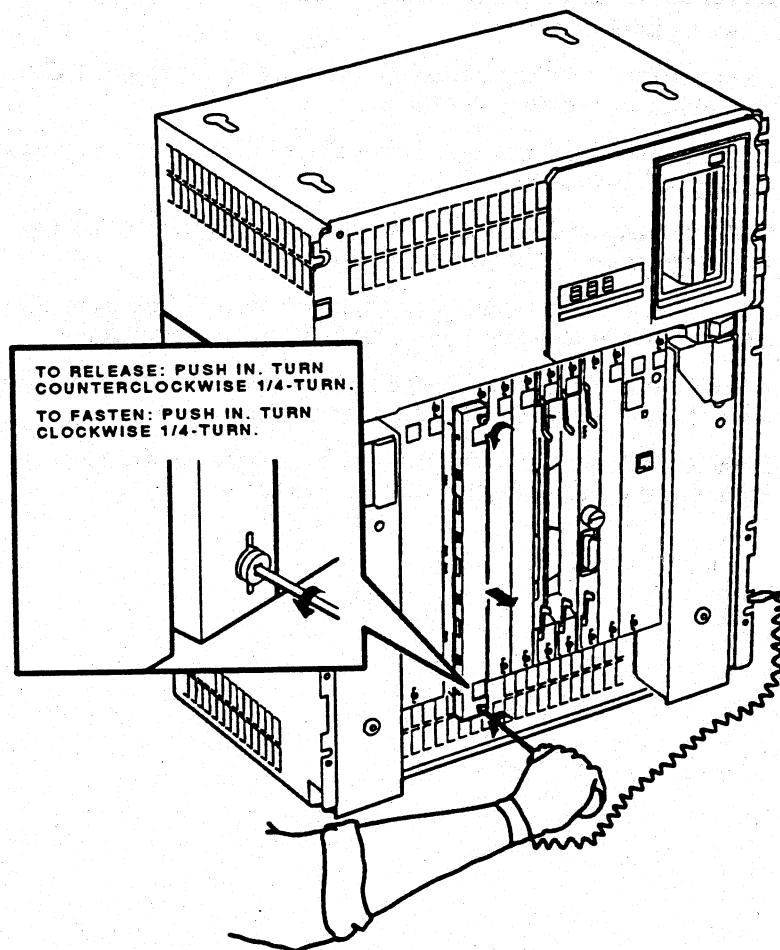

NOTE:

THIS ILLUSTRATION SHOWS HOW TO RELEASE CAPTIVE SCREWS ON ALL BLANK COVERS AND BULKHEAD HANDLES.

MA-X0015-00

Figure 2-7 Removing the Blank Covers

2.9.2 Modules with Handles

Use the following procedure to remove and install modules with handles:

IMPORTANT

Make sure you are wearing a grounded antistatic wrist strap when you remove or install modules.

1. Note the orientation of external cables connected to the module. *Carefully* label the cables, then disconnect them.
2. Release the two 1/4-turn captive screws that hold the module's handle to the card cage (Figure 2-7).
3. Unlock the release levers by simultaneously pulling up on the top lever and pulling down on the bottom lever (Figure 2-8).
4. Pull out on the module's handle and remove the module from the card cage. Be careful not to disturb any switchpacks on the module.
5. Confirm the module's CSR address and interrupt vector (Section 2.5). If necessary, change the module's jumper or switch settings.
6. Install the module in its new location by reversing the steps in this procedure. Do not fasten the 1/4-turn screws yet.

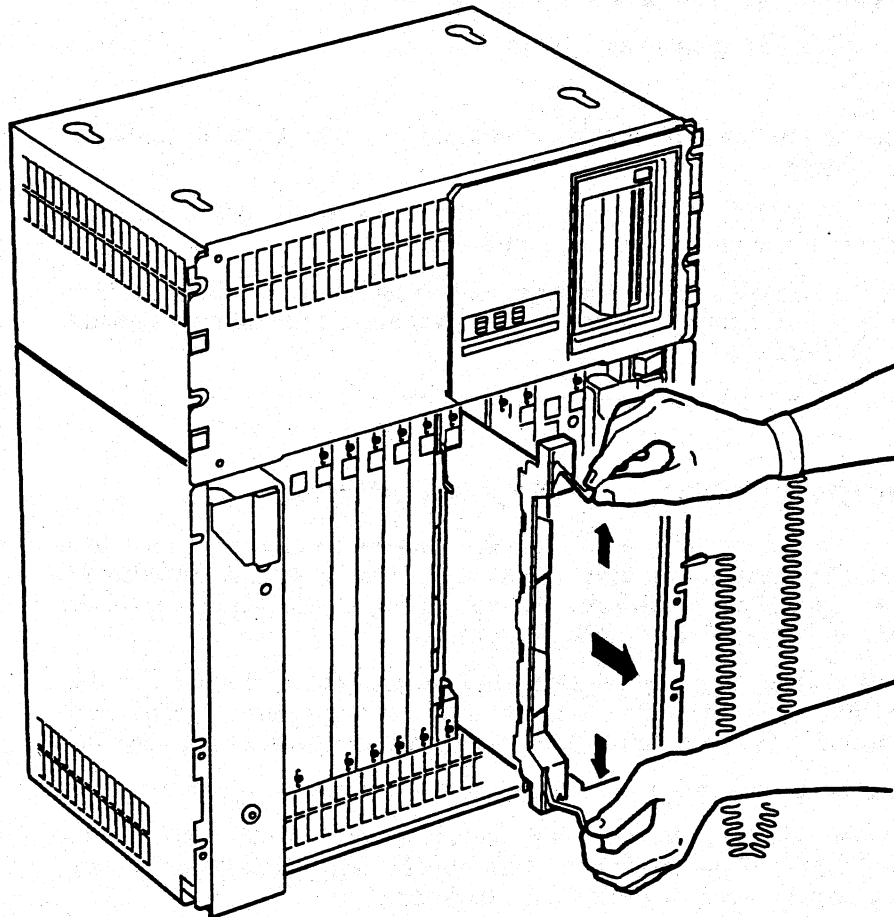

NOTE:

**THIS ILLUSTRATION SHOWS HOW TO UNLOCK
RELEASE LEVERS AND REMOVE ALL MODULES
WITH ATTACHED HANDLES.**

MA-X0016-88

Figure 2-8 Unlocking the Release Levers

2.10 Installing the DSV11-SF Module

Install the DSV11-SF module as follows:

IMPORTANT

Be careful not to snag the module's components on the card guides or adjacent modules.

1. Insert the DSV11-SF module into the appropriate slot, using the recommended module order listed in Section 2.4.1.
2. Grasp the module's top and bottom release levers. Lock the module in place by simultaneously pushing the top lever down and pulling the bottom lever up (Figure 2-9).
3. Do not fasten the 1/4-turn captive screws yet.

2.11 Verifying the Ground Connections

When you install a module with a blank cover or flush handle next to a recessed-handle module, you *must* install a gap filler assembly between the modules to meet EMI regulations. Without the gap filler, circuitry on the blank-cover or flush-handle module is exposed.

Two gap filler assemblies (PN 70-24505-01) are provided with the option kit. Each gap filler assembly includes one gap filler and two screws. Use as many of the assemblies as you need for your configuration. You may not need any.

Check that the ground connections are correctly in place as follows:

1. Check the backplane to see if any recessed-handle module is next to a module with a blank cover or a flush handle. There should not be any open spaces between modules in the backplane.
 - a. If there are no open spaces, you do not need the gap filler assemblies. Fasten the 1/4-turn captive screws on all handles and covers in the backplane.
 - b. If there are open spaces, make sure a gap filler assembly is installed on the side of the blank cover or flush handle that is next to the recessed-handle module (Figure 2-10).

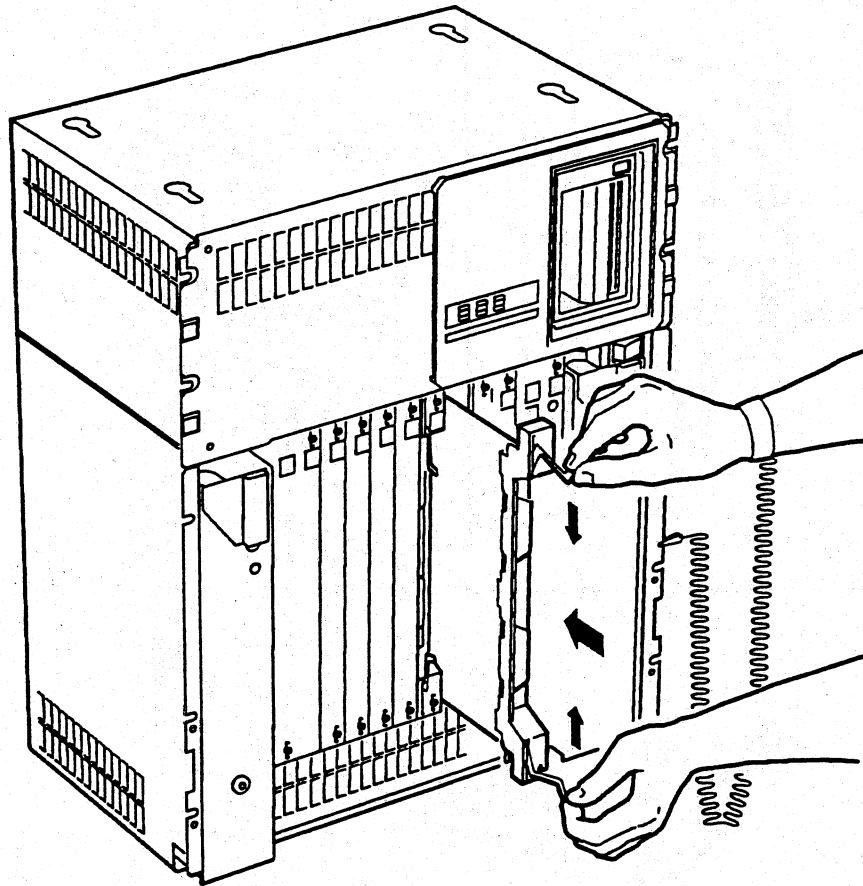

NOTE:

THIS ILLUSTRATION SHOWS HOW TO LOCK RELEASE LEVERS AND INSERT ALL MODULES WITH ATTACHED HANDLES.

MA-X0017-00

Figure 2-9 Inserting the Module

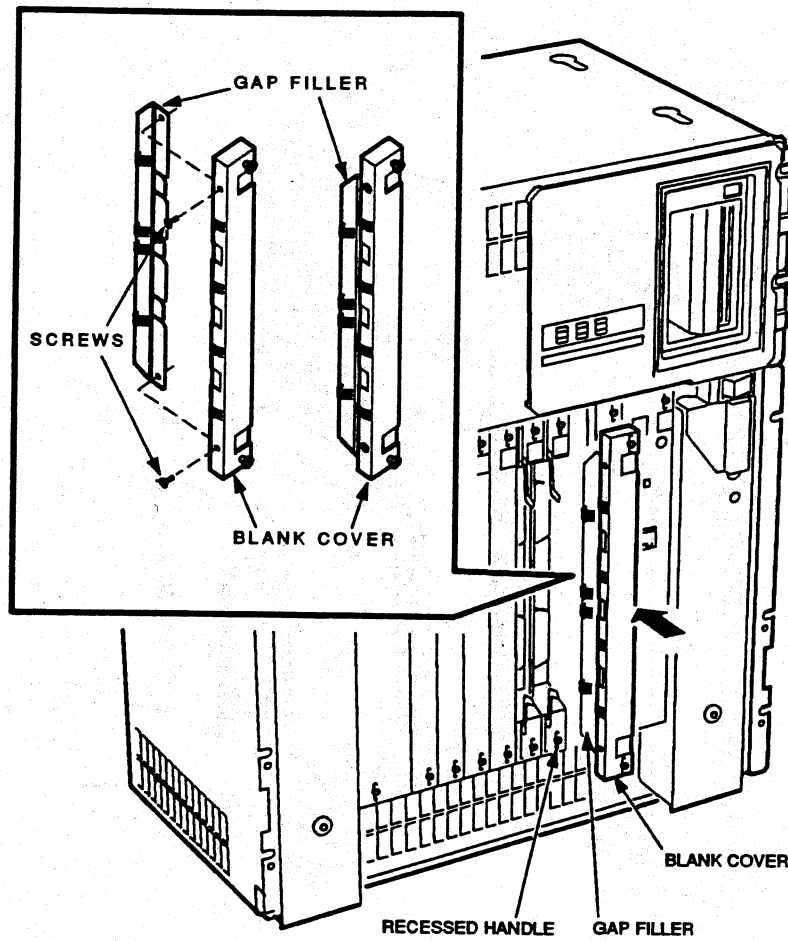

NOTE:

THE GAP FILLER IS MOUNTED ONTO THE BLANK COVER TO CLOSE THE OPEN SPACE BETWEEN THE RECESSED MODULE AND THE BLANK COVER.

MA-X0018-88

Figure 2-10 Ground Connections

2. Install the gap filler assembly, if needed, as follows:

- a. Fit the gap filler (PN 70-24505-01) onto the side of the blank cover or flush-handle module that is next to the recessed-handle module. Make sure the gap filler's tabs fit into the tab indentations on the blank cover or flush handle (Figure 2-11). Use the two screws that come with the assembly to attach the gap filler at the top and bottom.
- b. If you have a blank cover, place the blank cover with the gap filler over the card cage slot.
If you have a flush-handle module, insert the module into the card slot.
- c. Make sure there is correct ground (no open spaces) between the two modules.
- d. Fasten the 1/4-turn captive screws on all handles and covers in the backplane.

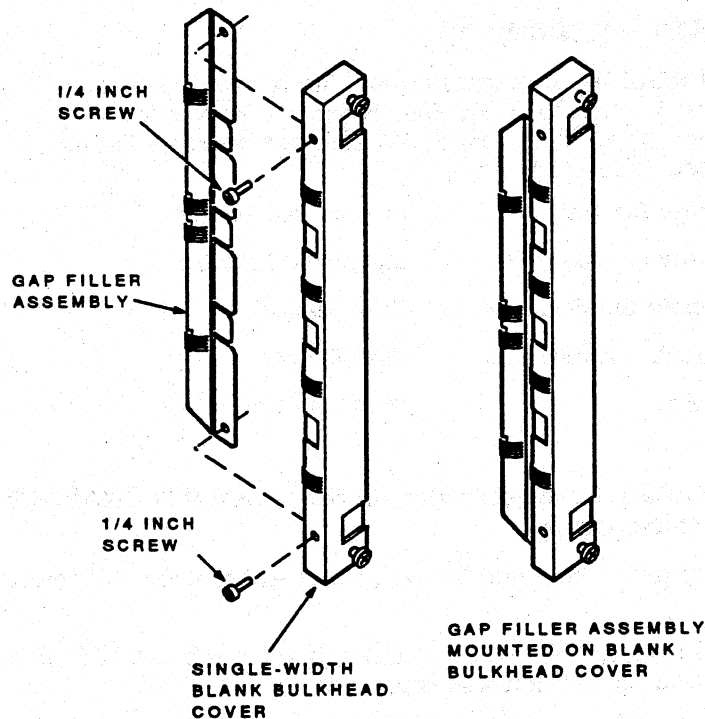

MA-X0019-88

Figure 2-11 Attaching the Gap Filler Assembly

3

Testing the New Configuration

This chapter describes the tests and procedures you should use to make sure the DSV11-SF and the MicroVAX system are operating correctly. See the *DSV11-S Communications Option User Guide* for information on connecting the module to a modem. The *DSV11 Communications Option Technical Description* has detailed information about the MicroVAX diagnostic monitor.

3.1 System Verification

Use the CPU ROM-based diagnostics and the MicroVAX diagnostic monitor (MDM) to test a MicroVAX system. Release 124 (version 2.3) or later of MDM supports the DSV11. The MDM software provides the following five groups of menu-driven tests:

Verify mode functional tests	user or Field Service
Verify mode exerciser tests	user or Field Service
Service mode functional tests	Field Service
Service mode exerciser tests	Field Service
Utility tests	Field Service

NOTE

For BA214 enclosures, use the Ethernet Server Kit (PN ZNA07-CM, -CP, or -C5) to test the system.

1. Plug the ac power cord into the wall outlet and turn the power switch on (1).
2. After 10 seconds, check that the module's green self-test LED is on. This indicates that the self-test was successful.
3. If the green self-test LED did not turn on, make sure the module is correctly inserted. If the LED still does not turn on, go to the *MicroVAX Systems Maintenance Guide* for troubleshooting information.
4. Insert the MDM tape cartridge into the system's tape drive.

5. Boot the tape drive.
6. Type 2 at the main menu to display a list of devices in the system.
Check the list to make sure the new module is included. If not, repeat the installation sequence and make sure you have set the module switches correctly.
7. Type 1 at the main menu, to run the basic system test.
This test should complete without error. If an error occurs, see Chapter 6 of the *MicroVAX Systems Maintenance Guide* for troubleshooting procedures.
8. Remove the tape cartridge from the tape drive.
9. Turn the power switch off (O).
10. Go to the *DSV11-S Communications Option User Guide* for information on connecting the DSV11-SF to a modem.

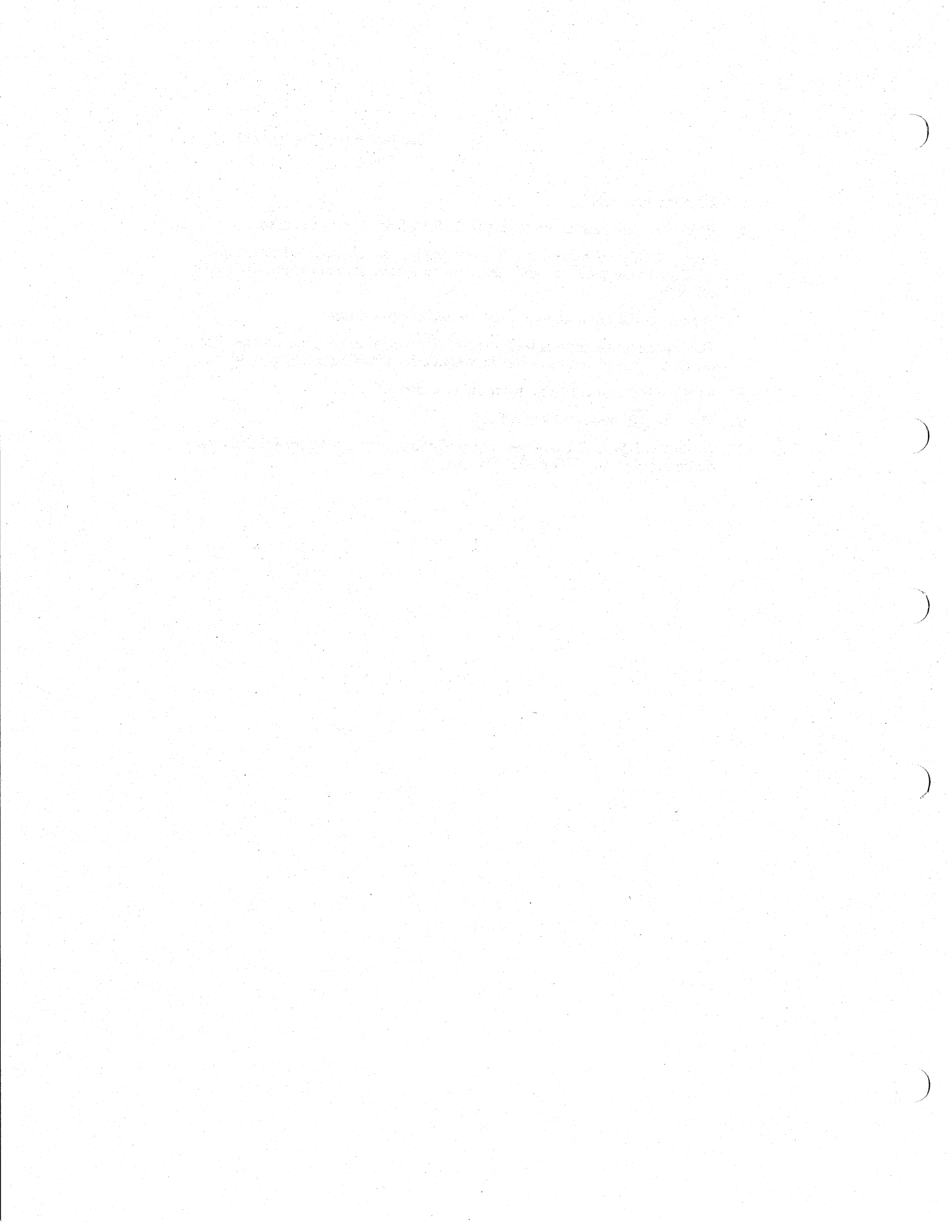

READER'S COMMENTS

Your comments and suggestions will help us in our efforts to improve the quality of our publications.

1. How did you use this manual? (Circle your response.)

- (a) Installation (c) Maintenance (e) Training
(b) Operation/use (d) Programming (f) Other (Please specify.) _____

2. Did the manual meet your needs? Yes No Why? _____

3. Please rate the manual on the following categories. (Circle your response.)

	Excellent	Good	Fair	Poor	Unacceptable
Accuracy	5	4	3	2	1
Clarity	5	4	3	2	1
Completeness	5	4	3	2	1
Table of Contents, Index	5	4	3	2	1
Illustrations, examples	5	4	3	2	1
Overall ease of use	5	4	3	2	1

4. What things did you like *most* about this manual? _____

5. What things did you like *least* about this manual? _____

6. Please list and describe any errors you found in the manual.

Page	Description/Location of Error
_____	_____
_____	_____
_____	_____
_____	_____

Name _____ Job Title _____
 Street _____ Company _____
 City _____ Department _____
 State/Country _____ Telephone Number _____
 Postal (ZIP) Code _____ Date _____

THANK YOU FOR YOUR COMMENTS AND SUGGESTIONS.

Please do not use this form to order manuals. Contact your representative at Digital Equipment Corporation or (in the USA) call our DECdirect™ department at this toll-free number: 800-258-1710.

FOLD HERE AND TAPE. DO NOT STAPLE.

digitalTM



No Postage
Necessary
if Mailed in the
United States

BUSINESS REPLY MAIL
FIRST CLASS PERMIT NO. 33 MAYNARD, MA

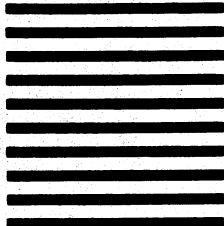

POSTAGE WILL BE PAID BY ADDRESSEE

DIGITAL EQUIPMENT CORPORATION
Educational Services/Quality Assurance
12 Crosby Drive BUO/E08
Bedford, MA 01730-1493
USA



FOLD HERE AND TAPE. DO NOT STAPLE.

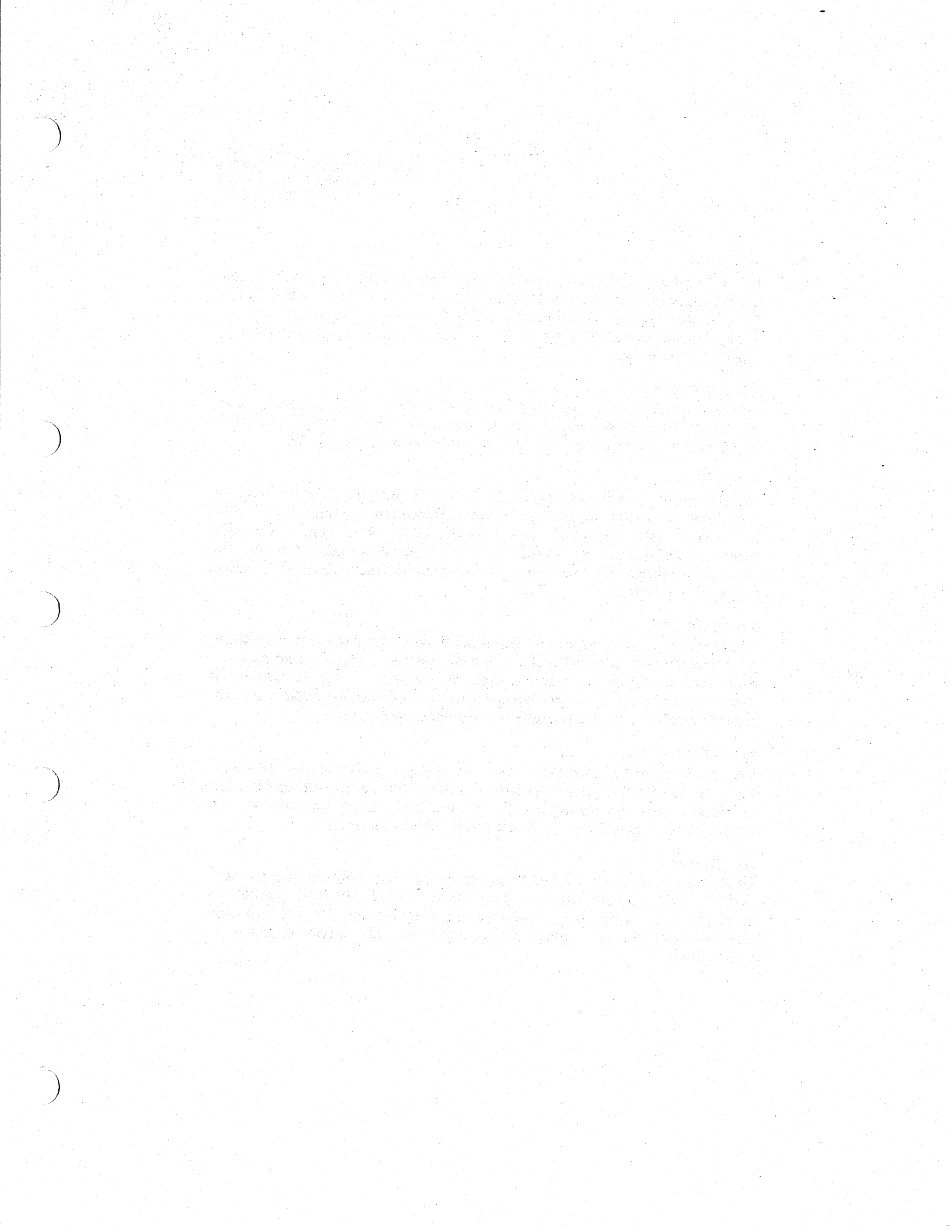

WARNING

The following installation instructions provide specific directions for the safe installation of the module kit. For your protection from possible shock or energy hazards, do not attempt to access or disassemble parts of the equipment other than those specified. Refer other servicing to qualified personnel.

ATTENTION

Suivre les instructions pour installer le module en toute sécurité. Afin d'éviter tout risque d'électrocution, ne manipuler que les pièces indiquées. Pour toute autre opération, faire appel à du personnel qualifié.

VORSICHT

Um das Modul richtig und gefahrlos zu installieren, gehen Sie unbedingt nach den folgenden Anweisungen vor: Hantieren Sie auf keinen Fall an anderen als den angegebenen Teilen, oder versuchen Sie nicht, diese zu entfernen. Es könnte sonst Berührungsspannung auftreten. Wartungsarbeiten dürfen ausschließlich von geschultem Fachpersonal ausgeführt werden.

PRECAUCIÓN

Las siguientes instrucciones de instalación ofrecen directrices específicas para una segura instalación del juego de módulos. Para evitar posibles descargas eléctricas o cualquier tipo de riesgo, no intente acceder o desarmar ninguna parte del equipo que no sean las especificadas. En caso de cualquier duda, consulte a personal cualificado.

WAARSCHUWING

Volg onderstaande instructies voor het veilig installeren van de kaart. Om risico's of elektrische schokken te voorkomen, alleen werkzaamheden verrichten aan de gespecificeerde onderdelen. Laat onderhouds- en reparatiewerkzaamheden over aan gekwalificeerd personeel.

ATTENZIONE

Le seguenti istruzioni per l'installazione forniscono informazioni per una corretta installazione del modulo. Onde evitare possibili pericoli di scariche di corrente, non tentare di accedere o smontare parti diverse da quelle indicate. Consultare, per qualsiasi ulteriore necessità, personale qualificato.

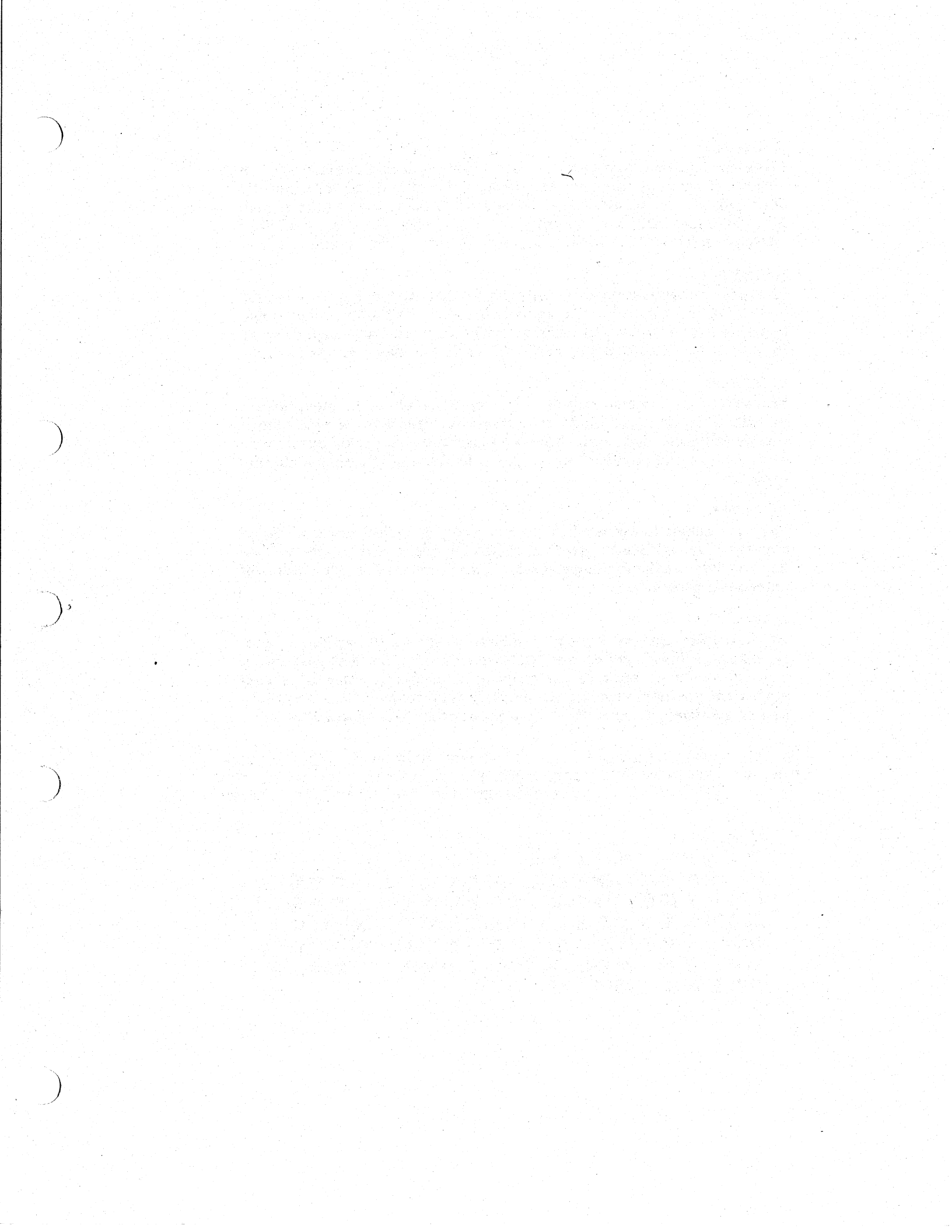

ADVARSEL

Følgende installasjonsveiledning viser nøyaktig fremgangsmåte for en korrekt og trygg installasjon av modulen. For å unngå elektrisk støt eller andre personskader, er det viktig at man ikke berører eller prøver å ta fra hverandre deler av utstyret. Utfør bare det som er anvist i håndboken. Overlat all annen reparasjon og service til kvalifisert fagfolk.

VARNING

Følgende installationsanvisning inneholder exakt vägledning för en säker installation av modulen. För att undvika elektriska stötar eller annan fara, bör man inte försöka komma åt eller montera isär andra delar av utrustningen, än de angivna. För övrig service, kontakta en fackman.

VAROITUS

Seuraavat asennusohjeet varmistavat moduulikitin turvallisen asennuksen. Jotta vaaratilanteilta vältytään, ei pidä koskea muihin laitteiston osiin kuin ohjeissa on mainittu eikä pyrkiä purkamaan niitä. Muut ylläpitotoimet on jätettävä koulutetun ylläpitohenkilöstön huoleksi.

ADVARSEL

Følgende installationsprocedure giver vejledning i sikker installation af modulet. Forsøg ikke at berøre eller adskille andre dele af udstyret, da der kan være risiko for højspænding. Yderligere service bør udføres af autoriseret personale.

AVISO

As instruções que se seguem explicam a forma de proceder, com segurança, à instalação de um "kit" de módulo. Não tente, de forma alguma, aceder ou abrir as partes do equipamento que não se refiram aqui, para que não corra o risco de choques eléctricos. Qualquer outro tipo de serviços que necessite, exija a presença de pessoal qualificado.

אזהרה: הוראות ההתקנה המובאות להלן נועדו להביא להתקנה בטוחה. כדי למנוע סכנת התחשמלות, אין לטפל בחלקי ציוד שלא מצוינים באופן מפורש. בכל טיפול אחר העזר באנשי מקצוע.

注意:

モジュール・キットを安全にインストールするために、必ず本書の指示に従ってください。ここで示されている箇所以外の部分に手を触れたり、部品等を取り外したりするとたいへん危険です。電圧等によるショックやけがのもととなりますから絶対におやめください。他の部分についての修理、変更は、当社技術部にご相談ください。