

DS310 INSTALLATION AND ACCEPTANCE

(INTRODUCTION)

I.	INSTALLATION	1-1
	A. UNPACKING	
	B. CABLING	
	C. SWITCH SETTINGS	1-2
	D. INITIALIZING	1-8
II.	ACCEPTANCE	2-1
III.	DIAGNOSTICS	3-1
	A. DEC/X8	
	B. LOW-LEVEL DIAGNOSTICS	
IV.	DOCUMENTATION LIST	4-1
	A. PRINTS	
	B. MAINDEC LISTINGS	
V.	SPARES KITS-BREAKDOWN	5-1
	A. PDP8/A	
	B. RX01	5-2
	C. VT50H	
VI.	TROUBLE-SHOOTING	6-1
	A. NO CHARACTERS	
	B. "Ø" ONLY	
	C. "Ø1" ONLY	
	D. "Ø12" ONLY	6-2
	E. "Ø123" BUT NO BOOT	
VII.	SITE PREPARATION NOTES	7-1

INTRODUCTION

This document is designed to aid the Field Service technician in installing, accepting, maintaining, and troubleshooting the DS310.

The DS310 is a 12-Bit, Turnkey System in a desk. The basic system is a PDP8/A with 8K of core, and option 1 and 2 boards. An RX01 dual floppy disk drive is the mass storage device, and the VT50H, with direct cursor addressing, is used for a terminal. Many DS310's have the optional LA36RO (receive only) for hard copy capabilities. A second RX01 which fits in the desk is also optional.

DEVICE CODES

VT50H (option 1 bd)	03-04
LA36RO (KL8-J)	66
RX01 (RX8/E)	75
RX01 (RX8/E) (second drive)	76

The 8/A used in the DS310 does not have a front panel. However, the 8/A spares kit does contain one, for troubleshooting capabilities. Also, an 8/M front panel can be used (Ref. PDP8/A-TT-1).

I. INSTALLATION

A. UNPACKING

Before unpacking the DS310, move all the crates into the area reserved for the system. Remove the cardboard top and one wooden end bracket from the desk unit; carefully slide the unit off the shipping pallet, unpack the VT50H and place it on top of the desk. Unpack the LA36RO (if you have one). Mount casters and rollers. Remove head restraint on LA36RO.

B. CABLING

After you have uncrated the DS310, the VT50H, and the printer (if you have one), they must be cabled together.

The VT50H cables feed through a hole in the top of the desk. Remove the back of the desk. If you have a printer, you will find two labeled MATE-N-LOK connectors. Plug each device into the appropriate connector. Check the option 1 board (M8316) to make sure the VT50H cable is securely plugged in. Also check the cable for the boot panel on the Option 1 bd. (See figure 1). Also check the KL8-J (M8655) to be sure the LA36 cable is seated. Plug the VT50H and LA36 power AC cables into the 861 power control in the desk.

NOTE

If you have a printer other than the LA36RO, AC power for it must come from a separate circuit. Don't plug any other printer into the 861.

Check the RX01/RX8/E cables for security at the RX8/E (M8357) and also inside the RX01. You must remove a holding bracket at the back of the desk in order to slide the RX01 out. The small cables inside the RX01 should all be plugged in securely. If any are unplugged, they are keyed so that the right plug only goes on to the right jack.

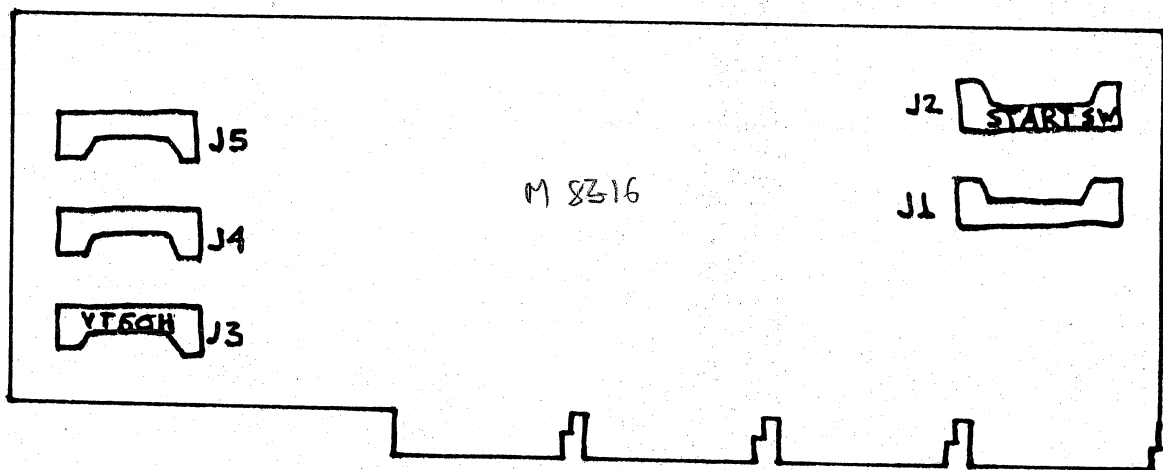
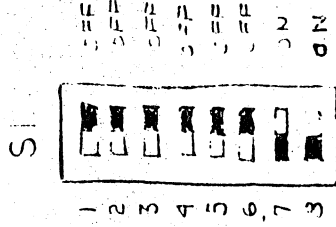

FIG. 1 - OPTION 1 CABLING

DS310 SWITCH ASSEMBLY

M8315 <COMPONENT SIDE >

KK2-A CPU MODULE



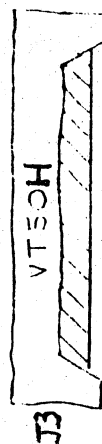
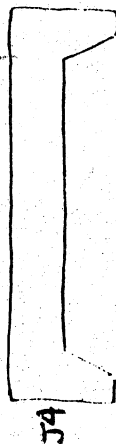
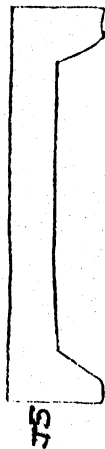
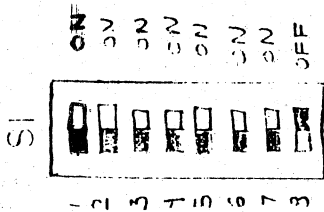
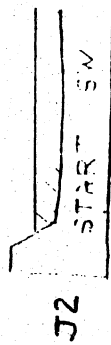

DS310 SWITCH ASSIGNMENTS

M8316 <COMPONENT SIDE>

SKC3-AA I/O SECTION BOARD

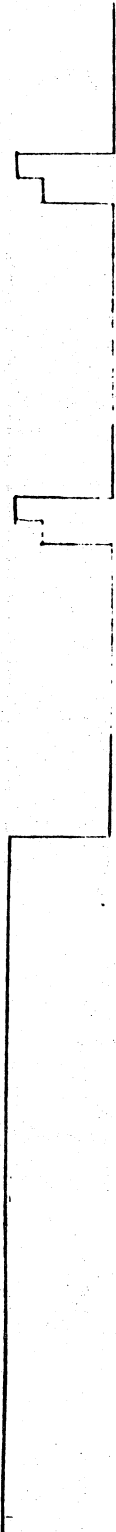

ON = 0
OFF = 1

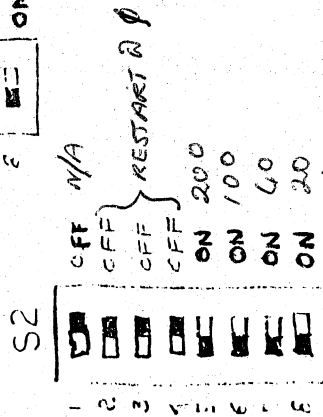
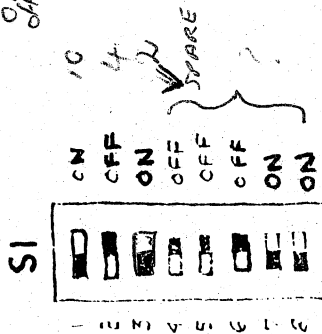

DS310 SWITCH ASSIGNMENTS
M8317 <COMPONENT SIDE>

KMC-75 EXTENDER OPTION BOARD

4

ROM START ADDRESS = 004



DS310 SWITCH ASSIGNMENTS

118357 <COMPONENT SIDE>

RX3E FLOPPY INTERFACE

<DEVICE CODE = 75 >

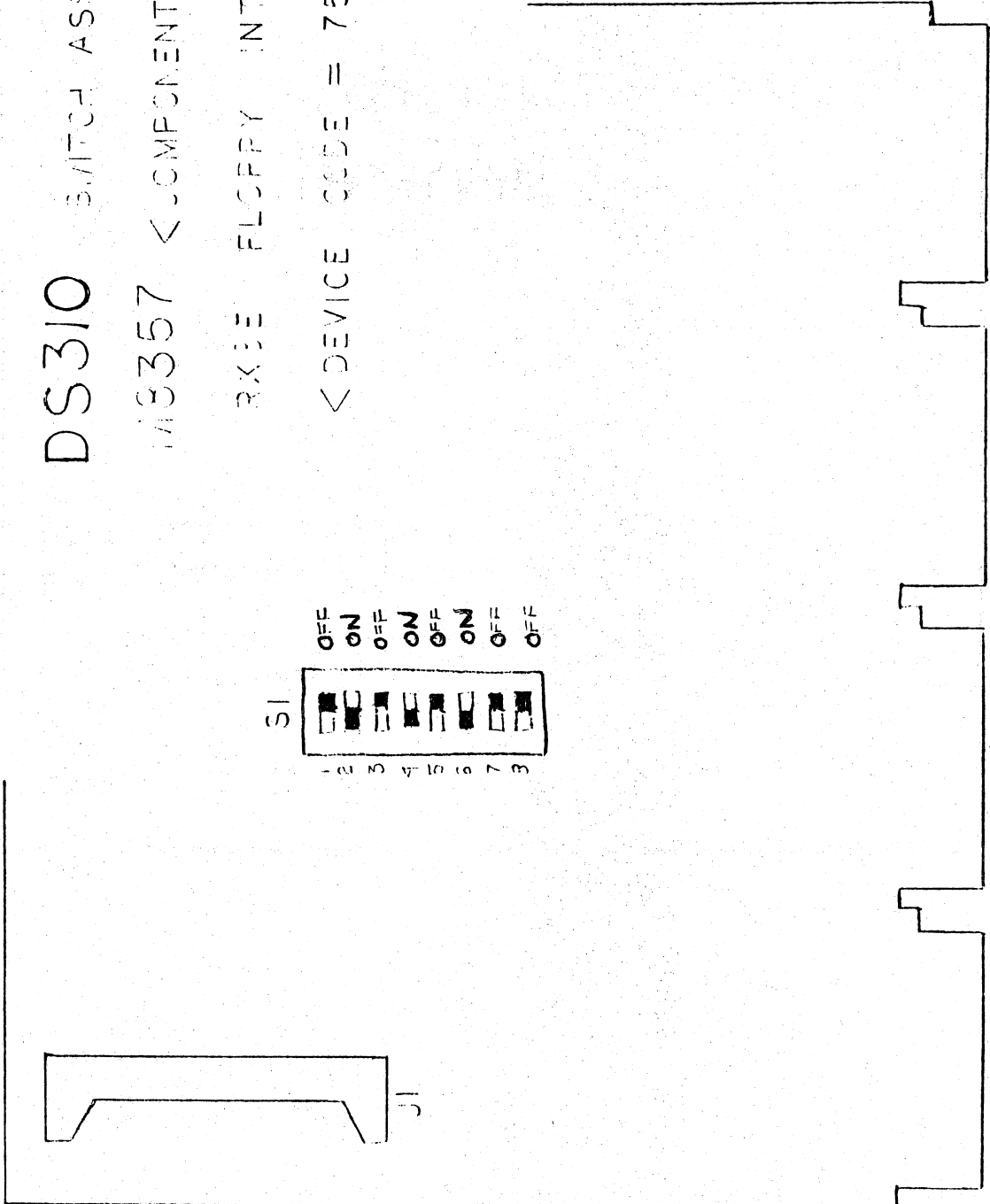
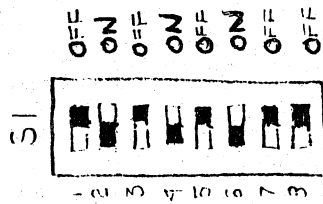

MODULE SWITCH	CONTACT NO.							
	1	2	3	4	5	6	7	8

M8315

S1 OFF OFF OFF OFF OFF OFF ON ON] CPU MODULE

M8316

S1 ON ON ON ON ON ON ON OFF] OPTION #1

M8317

S1 ON OFF ON OFF OFF OFF ON ON]
 S2 OFF OFF OFF OFF ON ON ON ON] OPTION #2

M8357

S1 OFF ON OFF ON OFF ON OFF OFF]
 OFF OFF ON ON ON OFF OFF OFF] RX8E (75)
 (76)

M8655

S1 OFF OFF ON ON OFF ON ON OFF KL8J
 S2 OFF ON ON ON OFF ON OFF ON

DS310 SWITCH SUMMARY

1	ME315	CPU MODULE	
2	ME316	I/O OPTION BOARD	(VT50)
3	ME317	EXTENDED OPTION BOARD	
4	*MM8-AA	FIRST MEMORY MODULE	
5	*MM8-AA	SECOND MEMORY MODULE	
6	**		
7	**		
8			
9			
10			
11			
12	MB357	RxB INTERFACE	(RX01)

*8K = FIELDS 0-1 MM8-AA
 16K = FIELDS 0-3 MM8-AB
 *8K = FIELDS 2-3 MM8-AA
 16K = FIELDS 4-7 MM8-AB

** Additional Memory Module could be inserted in slots 8-9

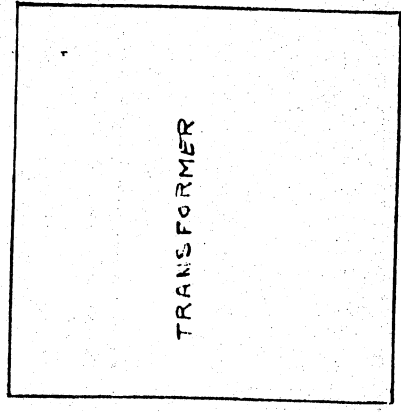
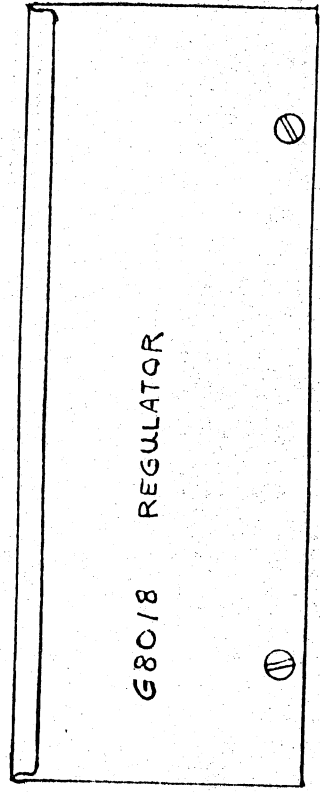

D. INITIALIZING

After you have checked all the cables and switch settings, and have inspected the system for damage, apply power to the 861 power control.

Now press the power button on the front of the desk. All system components should receive power; look for a cursor on the VT50H.

Before inserting any disketts, press the start button on the desk front. You should hear the RX01 clicking, and the numbers "0123" should appear on the VT50H screen. If not, turn to section VI, Troubleshooting.

If "0123" does appear, insert the COS software diskette into drive 0. Press any character on the VT50H keyboard; the RX01 should click and

```
"COS MONITOR V5.05"  
DATE?
```

should appear on the screen. If it does, turn to section II, Acceptance.

If the COS monitor message does not appear, turn to Section VI-E.

II COS - 310 FIELD SERVICE ACCEPTANCE PROCEDURE

I. INITIALIZING THE SYSTEM

Insert the COS 310 software diskette in RX0 and press the START switch.

0 1 2 3 should appear on the scope.

Press the 'S' key.

After a few seconds, the following should appear on the screen:

COS Monitor 5.05 (or current version)

DATE?

Now enter the date in the following format:

• DA MM-DD-YY <CR>

The monitor will now re-display its version message:

COS 300 MONITOR 5.05

II. SYSTEM SOFTWARE BACKUP

Insert a new scratch diskette in RX1 and copy the Systems diskette with the following command sequence:

R RXU <CR>

The program will identify itself as:

DISKETTE UTILITY V5.04

OPTION -

Now enter 'C' (for copy and verify) and <CR>

INPUT -

Enter 0 and <CR>

OUTPUT -

Enter 1 and <CR>

This will take about 3 minutes. Then remove the diskette from RX0 and store in a safe place. This is the system backup. Insert the diskette from RX1 into RX0, press START and enter the date as before.

R, DIRECT
**LPT: <RXA0> = 2*

III. INSTALLING THE SYSTEM SOFTWARE OPTIONS

To install the correct system handlers type:

```
R SYSGEN/C
```

The program will respond with:

Do you want to change the system device? (answer NO and <CR>).

Now provide the appropriate answers to all other questions.

IV. RUNNING THE DIBOL TEST PROGRAMS

A. Compile and save the test programs as follows:

```
Save R COMP, terminal test TRMTST/N <CR>  
SA TRMTST <CR>  
SAVE R COMP, line printer test LPTEST/N <CR>  
SA LPTEST <CR>
```

If a printer is present, put it on-line and compile the disk exerciser with a listing as shown:

```
R COMP, disk exerciser FLOPXX <CR>  
(R COMP, FLOPXX/N if no printer is available)  
Wait for the listing to complete then type:
```

```
SA FLOPXX <CR>
```

✓ B. Run the terminal (VT50) test by typing:

```
R TRMTST <CR>
```

Type CTRL/C to terminate the test. Run this test for about 5 minutes.

✓ C. If a printer is available run the printer test as follows:

```
R line printer LPTEST <CR>
```

Type CTRL/C to terminate. Run this test for about 5 minutes.

D. Running the disk test.

Set up the "logical units" table by typing the following data:

```
R SYSGEN/T terminal <CR>  
RX0, 7 <CR>  
RX1, 41 <CR>
```

- D. RX2, 41 } Enter this even if RX2, RX3 do not
RX3, 41 } exist.
CTRL/Z

If a printer exists, the new table can be displayed by typing:

R SYSGEN/L ^{line printer} <CR>

and the following data should be printed:

LOGICAL UNIT #	DEVICE NAME	LENGTH (SEGMENTS)	SYSGEN V5.05
01	RX0	0007	
02	RX1	0041	
03	RX2	0041	
04	RX3	0041	
05	- UNDEFINED -		
.	.		
15	- UNDEFINED -		

Now run the test by typing:

R FLOPXX <CR>

The program will respond with:

*** DIBOL DISK EXERCISER ***

ENTER DISK #
(enter 0-3 and <CR>)

ENTER # OF PASSES
(type a number between 1 and 999 and <CR>. Each pass takes about 45 min. Max. depending on how the next question is answered).

RECORDS TO SKIP?
(enter a number between 0 and 600 and <CR>. This is used in the oscillating read/write subtest to determine which records to access. The larger the number entered, the shorter the run time).

NOTE: DO NOT REMOVE THE SOFTWARE DISKETTE FROM RX0. INSERT A SCRATCH DISKETTE IN ANY OTHER DRIVE TO BE TESTED.

OUTPUT ERRORS TO PRINTER, Y OR N?

Enter Y or N.

If old data is present in the disk area used by the program, then the following monitor message may appear:

REPLACE XXXXXX #NN?

D. Answer YES and <CR>

As each pass is completed, the program will type:

PASS X OF Y

When all passes have been completed then the program will type:

*** EXERCISER COMPLETED ***

Error Messages:

All hardware detectable errors will be trapped by the monitor and displayed as:

I/O ERROR ON RX#; RETRY?

(Answer Y to retry N, to abort the program)

If the wrong records are being accessed, (positioner problem) then the program will type the following error message:

DISK ACCESS ERROR

RECORD # READ _____ RECORD # EXPECTED _____
for each error encountered.

NOTE: If drive 0 is being tested, the program will terminate much sooner due to the reduced data space available. For all other drives the entire diskette surface is tested.

Run this test for one pass on drive 0 and about 15 minutes each for all other drives.

To re-run this program type:

R FLOPXX <CR>

There is no need to re-enter the logical Units Table.

Software Note:

The COS310 Monitor will only display the message I/O ERROR on RX#, RETRY? after 10 consecutive errors on the same operation.

The utility program RXU will report every error encountered and as a result some number of errors should be expected when running RXU. Data Compare errors, however, should be considered a hard error since this indicates the copied version does not match the original.

III. DIAGNOSTICS

A. DEC/X8

There are two DEC/X8 configurations on the diagnostic diskette. They are pre-initialized, and to run them you boot the diagnostic diskette and type "R DECXA" or "R DECXC". This will put you in the DECX monitor, responding with

"!"
"C"

Type "AR" to run all jobs, RJnn to run a particular job, or "S" to get a status report. COMMANDS UNDER ! MODE.
DEC/X8 for the DS310 is run the same way as DEC/X8 for any 8/E system. Type "R" or "E" to start, "C" to stop.

DECXA is a minimum configuration X8; while DECXC is a customized configuration.

B. LOW-LEVEL DIAGNOSTICS

The diagnostics for the DS310 have been modified to run without a front panel. This means that halts have been removed, and the "switch register" is loaded from the VT50H.

The "R" (run) command is used to call the diagnostics, ex. "R DJKKB". Each diagnostic is called by its maindec name.

After a diagnostic loads, it requests a switch register setting, "SR = 0000". Most diagnostics for the DS310 require only one SR setting. Later in this section you will find individual SR options for each diagnostic.

At the end of a pass, one to five minutes, the diagnostic will print "maindec name PASS XXXX", with XXXX representing the number of passes.

Error messages are in this form:

"maindec name FAILED - PC :AAAA AC:BBBB MQ:CCCC FL:DDDD

AAAA = program counter at failure time

BBBB = accumulator

CCCC = MQ Register

DDDD = LINK -Bit 0
 GREATER THAN FLAG -Bit 1
 INT REQUEST LINE -Bit 2
 INT INHIBIT -Bit 3

B. LOW-LEVEL DIAGNOSTICS (cont.)

DDDD = INT ENABLE	-Bit 4
USER FLAG	-Bit 5
INSTRUCTION FIELD	-Bit 6,7 and 8
DATA FIELD	-Bit 9,10 and 11

This is to aid you in determining the type of error from the MainDec listings.

There are several control characters which can be used on the DS310 diagnostics.

- ^C - RETURN TO MONITOR
- ^D - SET UP S.R. AND CONTINUE
- ^E - CONTINUE FROM "WAITING"
- * ^L - OUTPUT ERRORS TO LINE PRINTER
- (^Q - CONTINUE OUTPUT TO VT50H (used with S)
- ^S - STOP OUTPUT TO VT50H
- ^R - RESTART DIAGNOSTIC

*This option is not available on floppy diagnostic, DIRXA and DIRXB.

The following SR settings are common to many DS310 processor tests.

SR0 = 1	INHIBIT ERROR "WAITING"
SR1 = 1	LOOP ON ERROR
SR2 = 1	LOOP IN TEST
SR3 = 1	"HALT" AT END OF PASS (WAITING)

Following are the SR settings for each individual MainDec.

DJKKB - 8/A CPU TEST

The SR settings for this test are only the common ones listed above. However, when you start the test, you will get an error message immediately. Look for the PC = 221, the AC = 7777 and the link = 1. Press ^E to continue.

DJEXC - 4-32K PROCESSOR EXERCISER

SR0 = 1	INHIBIT ERROR "WAITING"
SR1 = 1	LOOP ON TEST
SR2 = 1	INHIBIT RELOCATION
SR3 = 1	"WAITING" AT END OF PASS

DJCLA - OPTION 1 AND 2 TEST

SR0-4 STANDARD
SR7-11 MEMORY SIZE
0 = 1K, 7 = 8K, 17 = 16K, 27 = 24K, 37 = 32K

DHKMA - EXTENDED MEMORY CHECKBOARD

SR0 = 1 - "WAITING" AFTER ERROR
SR1 = 1 - INHIBIT ERROR TYPEOUT
SR2 = 1 - RING BELL ON ERROR
SR3 = 1 - INHIBIT RELOCATION
SR4 = 1 - CHANGE FIELD LIMITS
SR5 = 1 - "WAITING" AT END OF THIS TEST
SR6-8 - LOWER FIELD LIMIT
SR9-11 - UPPER FIELD LIMIT

DHKMC - EXTENDED MEMORY ADDRESS TEST

SWITCHES ARE THE SAME AS DHKMA (EXTENDED MEMORY CHECKERBOARD).

DIRXA - RX01 DIAGNOSTIC

There are two SR settings in this diagnostic.

The program first prints-

"Select parameters (including device code)"

SR0 and 1 - 00 = both drives if ready
 01 = drive 1 only
 10 = drive 0 only
 11 = both 0 and 1

SR2 = 1 - RX8-RX01 cable is unplugged (RX8/E testing)
SR3-5 - 5 for device code 75 (drives 0 and 1)
 6 for device code 76 (drives 2 and 3)
SR7-11 - test selection (zeroes for all tests)

The second SR setting follows

SR0 = 1 - "WAITING" AFTER ERROR
SR1 = 1 - "WAITING" AT END OF PASS
SR2 = 1 - LONG ERROR PRINTOUT (data comparison)
SR3 = 1 - INHIBIT ERROR PRINTOUTS
SR4 = 1 - LOOP ON ERROR
SR5 = 1 - LOOP ON TEST
SR6 = 1 - INHIBIT "INIT" AT ERROR
SR11 = 1 - DISABLE BELL ON ERROR

ERROR MESSAGES FOR DIRXA

Error messages for DIRXA and DIRXB are the same. For a detailed explanation, see pages following.

* DIRXB - RX01 Reliability

There are 4 SR settings necessary to start this test.

1st SR - DEVICE CODE
 0750 for drives 0 and 1
 0760 for drives 2 and 3

or 2nd SR setting - Drives to be tested

SR0 and 1 - 00 - TEST ALL READY DRIVES
 10 - TEST DRIVE 0
 01 - TEST DRIVE 1
 11 - TEST 0 and 1

3rd SR settings - parameters

SR 0,1,2 PATTERN
 0 = RANDOM
SR 3,4,5 TEST SELECTION
 0 = ALL
SR 6,7,8 ACTUATOR SEQUENCE
 0 = RANDOM
SR 9 = 1 8-BIT MODE (normal)
 = 0 12-BIT MODE
SR 10 = 1 DELETED DATA (normally 0)
SR 11 = 1 BASE 8 TRACK AND SECTOR #
 = 0 BASE 10 AND TRACK SECTOR #
4th SR setting RUN PARAMETERS

SR0 = 1 - "WAITING" ON ERROR
SR1 = 1 - "WAITING" AT END OF PASS
SR2 = 1 - LONG ERRIR PRINTOUT
SR3 = 1 - INHIBIT ERROR PRINTOUT
SR4 = 1 - INHIBIT ERROR RECOVERY ATTEMPTS
SR5 = 1 - INHIBIT BELL ON ERROR
SR6 = 1 - INHIBIT INIT ON ERROR

DILAB - LA36 DIAGNOSTIC

SR0 = 1 - CONTINUE ON ERROR
SR1 = 1 - HALT AT END OF TEST
SR2 = 1 - LOOP ON TEST
SR3 = 1 - RUN TEST ONCE AND HALT
SR4 = 1 - KBD CONTROL
SR6-11 - TEST SELECTION

NORMALLY ENTER 0200. THE DIAGNOSTIC WILL LOOP THROUGH TESTS 00-12. HALT WITH ^C.

ERROR DETECTION FOR DIRXA AND DIRXB

WRITE ERROR

A write error is a read error if the data being read is of unknown quality (the data being read is being read for the first time after its writing).

READ (CRC) ERROR - (TRANSFER REGISTER STATUS BIT 11 = 1)

A read error is a read error where the quality of the data being read is known (the data being read had been read successfully some time previously).

CRC AND DATA ERROR
NO CRC BUT DATA ERROR
CRC BUT NO DATA ERROR

These data errors are detected when the program is verifying the data that "should have been read" with the data that "actually was read" by comparing the "bad" column to the "good" column.

WORD#	GOOD	BAD
1	(TRACK IDENTIFICATION BITS 5-11)	
2	(SECTOR IDENTIFICATION BITS 8-11)	
WORDS 3 THRU 62 (IF 12-BIT MODE), OR BYTES 3 THRU 126 (IF 8-BIT MODE) CONTAIN THE OPERATORS PPP SELECTION.		
63	(OR BYTE 127) - THE SUM OF ALL WORDS 1 THRU 62 OR BYTES 1 THRU 127.	
64	(OR BYTE 128) - THE NEGATIVE OF 2 TIMES THE VALUE OF WORD # 63 OR BYTE # 127.	

SUMCHECK ERROR

The program detects a "SUM-CHECK" error by summing all the actual (bad) data column and comparing that sum to \emptyset .

The reason for the first 2 words/bytes containing track/sector identification codes is to detect addressing errors.

The reason for the last 2 words/bytes containing checksum information is to distinguish between what might resemble an addressing error (if the program detected an error when comparing the first 2 words/bytes) and a CRC error.

SEEK ERROR - (NO ALLOCATED TRANSFER REGISTER STATUS BIT)

A seek error has been defined as "not a CRC", and "not a parity" error.

PARITY ERROR - (TRANSFER REGISTER STATUS BIT 10 = 1)

A parity error is an error which results from an incorrect transfer of the command word from the RXB interface to the RX01 microprocessor control.

The following chart represents an overview of which errors may be detected in which test:

Errors:

TEST:	WRITE	READ	DATA	SEEK	PARITY
0	X	X	X		
1	X	X		A	A
2	X	X	X		
3		X	X	L	L
4		X			
5	X	X	X	L	L
6	X	X	X		
7		X	X		

DEFINITIVE ERROR CODES

The RX01 microcontroller has defined error codes and meanings which are available to the program by issuing command #7 to "read the B-code".

A definitive error code represents (where) within a micro-function the error was detected.

The following are the definitive error codes and meanings:

0	-	NO ERROR
10	-	DRIVE 0 FAILED TO SEE HOME FROM INITIALIZE
20	-	DRIVE 1 FAILED TO SEE HOME FROM INITIALIZE
30	-	HOME FOUND WHEN STEPPING OUT 10 TRACKS FROM INIT
40	-	TRIED TO ACCESS A TRACK GREATER THAN 77 (DECIMAL)
50	-	HOME WAS FOUND BEFORE DESIRED TRACK
60	-	SELF DIAGNOSTIC ERROR
70	-	DESIRED SECTOR NOT FOUND AFTER SAMPLING 52 HEADERS
100	-	WRITE PROTECT ERROR
110	-	MORE THAN 40US AND NO SEP CLOCK DETECTED
120	-	A PREAMBLE COULD NOT BE FOUND
130	-	PREAMBLE FOUND BUT NO ID MARK FOUND IN TIME
140	-	CRC ERROR ON SUPPOSEDLY GOOD HEADER
150	-	GOOD HEADER (NO CRC ERROR) BUT TRACK COMPARE ERROR
160	-	IDAM NOT FOUND IN TIME
170	-	DATA AM NOT FOUND IN TIME
200	-	DATA CRC ERROR
210	-	ALL PARITY ERRORS

UNEXPECTED OR MISSING ERROR CONDITIONS
MISSING DD MARK

This error may occur when the program expected a deleted data mark but none occurred.

UNEXPECTED DD MARK

This error may occur when the program had not expected a deleted data mark but one occurred.

MISSING ERROR FLAG

This error may occur when the contents of the transfer register at done time are not \emptyset , and the error flag is cleared.

UNEXPECTED RX \emptyset 1 IRQ

This error may occur when the program has not yet enabled the RXB interrupt enable flip-flop but an interrupt occurred.

DEVICE TEST HUNG

This error may occur when the program expects but failed to receive a program interrupt request from the RX \emptyset 1 subsystem within an allotted period of time (approximately 4 seconds).

UNKNOWN IRQ

This error may occur when the program has failed to identify the device issuing a program interrupt request.

ERROR REPORTING

All errors detected will be reported if AC SW 3 = \emptyset . The following information is printed for all errors detected. The header line is only printed for the first error detected within each test pass.

CMND	XDR	CODE	RSTA	START	TARGET	TEST	PASS
CMND	-	COMMAND TO THE RX \emptyset 1 MICROCONTROLLER					
XDR	-	CONTENTS OF THE TRANSFER REGISTER AT ERROR/DONE					
CODE	-	DEFINITIVE ERROR CODE (VIA COMMAND #7)					
RSTA	-	STATUS (VIA COMMAND #5)					
START	-	STARTING TRACK/SECTOR ACTUATOR POSITION					
TARGET	-	TARGET TRACK/SECTOR ACTUATOR POSITION					
TEST	-	TEST PARAMETERS SELECTED					
PASS	-	PASS # AT ERROR (TO 16777215 DECIMAL)					

EXAMPLES

KEY INITIALIZE ERROR

CMND	XDR	CODE	RSTA	START	TARGET	TEST(X)	PASS
KEY	Ø1ØØ	Ø12Ø	Ø2ØØ	KEY	(HOME)	KEY	

Starting the program had produced a console (key) initialize, and the RXØ1 control was unable to find the (home) position on drive Ø.

CMND	-	CONSOLE (KEY) INITIALIZE
XDR	-	DELETED DATA MARK HAPPENED TO BE PRESENT
CODE	-	A PREAMBLE COULD NOT BE FOUND
RSTA	-	DISKETTE DRIVE IS READY
START	-	ACTUATOR POSITION UNKNOWN
TARGET	-	(HOME) TRACK 1, SECTOR 1

SEEK ERROR

CMND	XDR	CODE	RSTA	START	TARGET	TEST(X)	PASS
ØØ14	Ø1ØØ	Ø12Ø	Ø3ØØ	(HOME)	1 1		
INIT	Ø	Ø12Ø	Ø2ØØ	(HOME)	(HOME)		

A seek error occurred while trying to "write deleted data" (CMND #14) onto track 1 sector 1.

CMND	-	WRITE DELETED DATA
XDR	-	DELETED DATA MARK
CODE	-	A PREAMBLE COULD NOT BE FOUND
RSTA	-	DRIVE READY + DELETED DATA
START	-	HOME POSITION
TARGET	-	TRACK 1, SECTOR 1

Then the program issued an initialize at an attempt to recover from the "seek error".

CMND	-	MEANS IOT 67X7 WAS ISSUED (INIT)
XDR	-	Ø
CODE	-	A PREAMBLE COULD NOT BE FOUND
RSTA	-	DRIVE READY
START	-	HOME POSITION
TARGET	-	HOME POSITION

WRITE-CRC AND DATA ERROR

CMND	XDR	CODE	RSTA	START	TARGET	TEST(X)	PASS
ØØ26	ØØØ1	32ØØ	Ø2Ø1	1ØØ,3Ø	1ØØ,1		
WRITE-CRC AND DATA ERROR							
WORD	GOOD	BAD					
4	5435	5473					
5	6617	5437					
6	63Ø3	46Ø6					
SUMCHECK IS 1253							
TOTAL BAD=60							

While reading sector 7 of track 100 the program detected a CRC error.

The program expands the standard error format to include data comparison information if the test is a data comparison test.

If AC switch 2 =1 then a (long) data comparison printout would have occurred of (all) the words/bytes in error.

The word "write" within the expansion means that the data of sector 7 had never been read before, therefore the program assumed it was written incorrectly.

READ-CRC AND DATA ERROR

CMND	XDR	CODE	RSTA	START	TARGET	TEST(X)	PASS
0026	0001	0200	0201	100,30	100,1		
READ-CRC AND DATA ERROR							
WORD	GOOD	BAD					
4	5435	5477					
5	6617	5437					
6	6303	5406					
SUM-CHECK IN 1257							
TOTAL BAD=60							

While seeking sector 1 of track 100 the program detected a CRC error.

The program expands the standard error format to include data comparison information if the test is a data comparison test.

If AC switch 2 = 1 then a (long) data comparison error printout would have occurred of (all) the words/bytes in error.

The word "read" within the expansion means that the data of sector 7 had been read some time previously. Therefore the program assumes that the data was written correctly but read incorrectly.

WRITE-CRC BUT NO DATA ERROR

CMND	XDR	CODE	RSTA	START	TARGET	TEST(X)	PASS
0026	0001	0200	0201	100,30	100,1		
WRITE - CRC BUT NO DATA ERROR							

A CRC error was detected after reading sector 1 of track 100.

The word "write" within the data expansion means that the data of sector 1 track 100 had never been read before therefore the program assumed it was written incorrectly, and because the program did not detect a data comparison error, it assumed that the 2 CRC characters were written incorrectly.

ERROR RECOVERY

The program will attempt to retry all erroring functions 10 times. A recoverable error (soft) is one which disappears within 10 program retrys. An unrecoverable error (hard) is one which remains after 10 program retrys.

The program will issue IQT 67X7 (INIT) for all errors but definitive error codes 140, 200, and 210.

- 140 - CRC ERROR ON SUPPOSEDLY GOOD HEADER
- 200 - DATA CRC ERROR
- 210 - PARITY ERROR

These errors are (not) seek type actuator related errors. If a hard write error is detected the program aborts further testing this pass of that track/sector but continues testing tracks, on the remaining.

A sympathetic hard read error may occur (pattern dependent) if the hard write error had occurred within a test which would eventually read that sector and a sympathetic hard data comparison error may occur if that test was to verify the data to a known pattern.

FATAL ERROR RECOVERY

If the program detects any of the succeeding fatal error conditions, the programs recovery will be that of an automatic restart.

The program will automatically dump all statistical information accumulated issue an (INIT) and effectively restart itself from restart address 201.

- (A) HARD PARITY ERROR
- (B) A SELECTED DRIVE BECOMING NOT READY
- (C) NO EXPECTED RX01 INTERRUPT REQUEST
- (D) MISSING ERROR FLAG
- (E) LOG OVERFLOW
- (F) DEVICE TEST HUNG

IV. DOCUMENTATION LIST

A. PRINTS

Prints for the DS310 are available as a set from micrographics, called MPCL8. Also available are:

8A500
RX01 - M7726, M7727, M8357, 54-11398, H771
LA36
KL8J
DP8E
KG8E

B. MAINDEC LISTINGS

Maindec listings for the CL8 diagnostic package are available from SDC as ZF-008-RZ. These include:

DIRXBB - Floppy reliability
DJEXCA - 4-32K processor exerciser
DHVTCB - VT50 diagnostic
DJKKBA - 8/A CPU test
DHCMA - card reader test
DHKGA - KG8E test
DIRXAB - floppy diagnostic
DHDPA - DP8E test
DHKMCA - extended memory address
DJCLAA - Option 1 + 2 test
DILPAC - LP02 diagnostic
DILPEB - LP05 diagnostic
DHLSAC - LS01 test
DHKMAB - extended memory checkerboard
DILABC - LA36 test

V. SPARES KITS

PDP 8A CORE SPARES KIT

QTY	PART #	DESCRIPTION
2	BC08R-01	CABLE
1	BC08R-10	CABLE
1	G8018	REGULATOR
1	M8315	PROCESSOR BD.
1	M8316	OPT. 1 BD.
1	M8317	OPT. 2 BD.
1	MM8-AA	8K MEMORY
1	MM8-AB	16 K MEMORY
1	70-10644	
1	70-10705	MODULE CARRIER
1	70-10866	DISK ARRAY
1	29-22018	MODULE CASE
5	90-07207	FUSE
5	90-07219	FUSE
5	90-08387	FUSE
5	90-09697	FUSE
5	90-09698	FUSE
5	90-09699	FUSE

RX8/RX11 SERVICE KIT (60Hz)

QTY	PART #	DESCRIPTION
1	M7726	FLOPPY CONTROLLER
1	M7727	R/W MODULE
1	M7846	RX11 INTERFACE
1	M8357	RX8E INTERFACE
1	W130	KM11 DRIVER
1	W131	KM11 LIGHTS
1	30-12304	FLOPPY DRIVE
1	70-10718	H771 REGULATOR
1	22-00007	CLEANING PADDLE
1	29-21888	CASE
1	36-12408	DISKETTE

VT50H SPARES KIT

1	54-10886-01	MONITOR/POWER BD.
1	54-10902-03	MICROPROCESSOR
1	54-10906-01	MICROPROCESSOR
1	54-11170-03	KEYBOARD

VI. TROUBLESHOOTING

You are in this section because "0123" did not appear on the screen when you pressed start. These characters are printed as part of the ROM bootstrap program, and each one is significant.

- 0 - VT50H check passed
- 1 - 8/A test passed
- 2 - Memory test passed
- 3 - Floppy test passed

The bootstrap ROM, on the option 2 board, actually contains a mini-diagnostic, and if all four characters don't print, one of the tests failed. This section is broken down according to what did or didn't print.

A. Nothing printed at all.

*If the RX01 didn't click, try the boot switch on the 8/A bootstrap panel (inside the desk back cover). If it still doesn't click, you are not generating the initialize signal. Check the cable from the boot panel to the Option 1 board (M8316). *check power supply*

*If the RX01 did click, but no characters appeared, check the VT50H off-line. Look on the bottom of the VT50H for directions. Now check the baud rate on the VT50H, and recheck the baud rate on the M8316. Also recheck the switches on the M8317. Check the cable between the M8316 and the VT50H. Check the power supply voltages for the 8/A (see fig.2). If these things all check out, you probably have either a bad M8316, M8317, or ROM chips on the M8317.

B. Only "0" printed.

MAKE sure the M8315 (Processor) is securely seated. You have a problem either here or with the ROMs on the M8317. Check the processor voltages (Fig.2).

C. Only "01" printed

You have a problem either with memory or the M8317 ROMs. Check processor voltages (Fig.2).

POWER SUPPLY VOLTAGES - PDP8A - FIGURE 2.

VALUE	PIN	ADJUSTMENT
+5V	AA2, BA2, CA2	G8018 - +5VADJ.
+20V	EA2	G8018 - +20VADJ.
+15V	DA2	NONE
-15V	DB2	NONE
-5V	EM2	NONE

MEASURE VOLTAGES IN OMNIBUS SLOT CLOSEST TO THE G8018

IV. TROUBLESHOOTING

D. Only "012" printed

You have a problem with the floppies. Did the RX01 click when you pressed start? If not, check the cabling to the RX01. If they did, recheck the RX8/E device code. Also check the precessor voltages. See figure 2.

E. "0123" appeared, but the system didn't boot when you hit a character.

If that character was not echoed, you have a VT50H or M8316 problem. Check the baud rates on the VT50H and the M8316. Check the VT50H off-line (see bottom of unit for directions). Check the cable between the VT50H and the M8316.

If the character was displayed, but the system didn't boot, press the start button again. After "0123" appears, again strike any character. If the diskette still does not boot, but the drives click, remove the COS diskette and reboot with the diagnostic floppy. The diagnostic diskette should display a "." If it does, you probably have a bad COS diskette. Turn to Section III, and run DEC/X8.

If the diagnostic diskette doesn't boot, remove it from drive 0 and put it in drive 1. Now try to boot again. If it comes up, you have a problem in drive 0. If not, you have a problem either with the RX01 controller, the RX8/E interface, or the Option 2 board (M8317). Recheck the switch settings on the RX8/E and the M8317.

VII SITE PREPARATION GUIDE - DS310

The DEC DATA SYSTEM 310 is a stand-alone disk-based business system. It consists of a PDP-8A processor, a VT50 DECscope, and an RX01 floppy disk drive, all contained in a single desk unit. An optional line printer stands separate from the system.

SPACE REQUIREMENTS: The basic system is in a desk 48" x 30". This requires an area 4.5 ft. by 6 ft. to allow operator room. The optional line printer should be placed immediately to the right or left of the desk, requiring another three feet in width. This is a total area of 7.5 ft. by 6 ft.

ENVIRONMENTAL REQUIREMENTS: Room temperature can be 59° to 90°F; 65° to 75° is recommended. Humidity can range from 20% to 80%; 40% to 60% is recommended. The basic system generates 1700 BTU per hour; with LA36R0, 2700 BTU per hour; with LP05, 3500 BTU per hour.

POWER REQUIREMENTS: The DS310 plugs into a standard grounded wall plug. North American requirements are 115V, 60 Hz, single phase at 15A (NEMA5-15P connector). International requirements are 230V, 50 Hz, single phase at 15A (NEMA 6-15P connector). One plug is required for each system. The basic system uses 12A; with any printer besides the LA36R0 must have a separate power source.

"THIS DRAWING AND SPECIFICATIONS, HEREIN, ARE THE PROPERTY OF DIGITAL EQUIPMENT CORPORATION AND SHALL NOT BE REPRODUCED OR COPIED OR USED IN WHOLE OR IN PART AS THE BASIS FOR THE MANUFACTURE OR SALE OF ITEMS WITHOUT WRITTEN PERMISSION. COPYRIGHT © , DIGITAL EQUIPMENT CORPORATION"

TABLE OF CONTENTS

REVISIONS			SHEET NO.
CHK	CHANGE NO.	REV.	
			1. TABLE OF CONTENTS
			2. SECTION 1. DS31Ø SYSTEMS
			3. SECTION 2. OPTIONAL EQUIPMENT
			4. SECTION 3. CPU BACKPLANE SLOT ASSIGNMENTS
			5. SECTION 4. POWER SWITCH SETTINGS
			6. SECTION 5. MODULE CONFIGURATIONS
			8. SECTION 6. RX8 DRIVE UNIT DECALS
			SECTION 7. AC POWER CABLING

4
3
2
1

4
3
2
1

B
AR

B
AR

ENG.		FIRST USED ON	DS31Ø		digital
CHK.		TITLE	DATASYSTEM 31Ø CONFIGURATIONS		
MKT.					
PROD.					
FIELD S.					
NEXT HIGHER ASSY.					
SCALE	NONE	SIZE	CODE	NUMBER	REV.
SHEET	1 OF 8	B	AR	DS31Ø-Ø-Ø	
		DIST.			

A

B

"THIS DRAWING AND SPECIFICATIONS, HEREIN, ARE THE PROPERTY OF DIGITAL EQUIPMENT CORPORATION AND SHALL NOT BE REPRODUCED OR COPIED OR USED IN WHOLE OR IN PART AS THE BASIS FOR THE MANUFACTURE OR SALE OF ITEMS WITHOUT WRITTEN PERMISSION. COPYRIGHT © DIGITAL EQUIPMENT CORPORATION"

ARRANGEMENT GUIDELINES

- DS310 SYSTEMS:** THE TERM DS310 REFERS TO A SERIES OF SMALL, DESK-SIZED COMPUTER SYSTEMS BASED ON PDP-8 HARDWARE. EACH SYSTEM INCLUDES THE COS310 OPERATING SYSTEM WHICH USES THE DIBOL PROGRAMMING LANGUAGE.

THE BASIC HARDWARE BUILDING BLOCK OF A DS310 SYSTEM IS CALLED THE CLB AND IT CONSISTS OF AN 8/A CPU, AN RX8 DUAL-DRIVE FLOPPY DISK AND A VT50-H DECSCOPE, ALL MOUNTED IN AN H982-W DESK AS ILLUSTRATED BELOW:

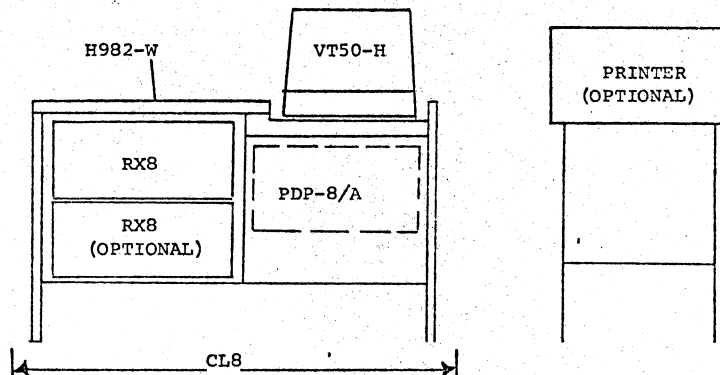

OPTIONAL EQUIPMENT AVAILABLE FOR THE DS310 INCLUDES EXTRA MEMORY, A CHOICE OF PRINTERS, AN ADDITIONAL RX8 DUAL-DRIVE UNIT AND A 2780 COMMUNICATIONS SUBSYSTEM.

THE TWO LETTER SUFFIX APPENDED TO EACH OPTION NUMBER DENOTES THE TYPE OF MEMORY, SOFTWARE, CUSTOMER AND INPUT POWER AS FOLLOWS:

DS310 - XX	
A = 16KB, SOFTWARE SUPPORT	A = END USER, 115V/60HZ
B = 16KB, LICENSE ONLY	B = END USER, 230V/50HZ
C = 32KB, SOFTWARE SUPPORT	C = OEM, 115V/60HZ
D = 32KB, LICENSE ONLY	D = OEM, 230V/50HZ

REFER TO THE CURRENT EDITION OF THE DIGITAL MASTER PRICE LIST TO DETERMINE WHICH OPTIONS ARE AVAILABLE FOR SALE. NOTE THAT NEW OPTIONS MAY BE ADDED OR OLD OPTIONS DELETED AS DETERMINED BY THE BUSINESS PRODUCT GROUP.

REVISIONS			TITLE	SIZE	CODE	NUMBER	REV.
CHK	CHANGE NO.	REV.					
			DATASYSTEM 310 CONFIGURATIONS	B	AR	DS310-0-0	
SCALE			SHEET 2 OF 8	DIST.			
NONE							

"THIS DRAWING AND SPECIFICATIONS, HEREIN, ARE THE PROPERTY OF DIGITAL EQUIPMENT CORPORATION AND SHALL NOT BE REPRODUCED OR COPIED OR USED IN WHOLE OR IN PART AS THE BASIS FOR THE MANUFACTURE OR SALE OF ITEMS WITHOUT WRITTEN PERMISSION. COPYRIGHT © , DIGITAL EQUIPMENT CORPORATION"

ARRANGEMENT GUIDELINES

2. OPTIONAL EQUIPMENT: THE BASIC DS31Ø OCCUPIES SIX OF THE TWELVE AVAILABLE MODULE SLOTS IN THE CPU BACKPLANE. OPTIONAL EQUIPMENT MAY BE SELECTED FROM THE LIST BELOW UP TO A MAXIMUM OF SIX ADDITIONAL MODULE SLOTS. THE DS31Ø MAY NOT BE EXPANDED BEYOND THE CPU BACKPLANE.

OPTIONAL EQUIPMENT

TYPE	UNIT	REMARKS	BACKPLANE SLOTS
MEMORY	MM8-AA	ONE ADDITIONAL MEMORY MODULE MAY BE ADDED TO THE BASIC SYSTEM. MAXIMUM MEMORY = 64K BYTES (TWO MM8-AB). SECOND MEMORY IS INSTALLED IN SLOTS 6&7.	2
	OR MM8-AB		
FLOPPY DISK	DS3RX-B	ONE ADDITIONAL FLOPPY DISK MAY BE INSTALLED IN THE LOWER HALF OF THE DESK PEDESTAL.	1
PRINTER	DS3D5	THE DS3D5 IS AN LA36 MODIFIED AS A PRINTER ONLY UNIT.	1
	OR LS8-F	CENTRONICS PRINTER	1
	OR LE8-V	DATA PRODUCTS PRINTER (LPØ5)	1
278Ø COMM.	DP8-E AND KGB-EA	SYNCHRONOUS COMMUNICATIONS LINE AND HARDWARE CRC UNIT. REQUIRES QF311-AY SOFTWARE.	3

REVISIONS		
CHK	CHANGE NO.	REV.

TITLE DATASYSTEM 31Ø CONFIGURATIONS		SIZE B AR	CODE	NUMBER DS31Ø-Ø-Ø	REV.
SCALE NONE	SHEET 3 OF 8	DIST.			

EM-01125-16-11575 (325)

DRB 122

A

B

"THIS DRAWING AND SPECIFICATIONS, HEREIN, ARE THE PROPERTY OF DIGITAL EQUIPMENT CORPORATION AND SHALL NOT BE REPRODUCED OR COPIED OR USED IN WHOLE OR IN PART AS THE BASIS FOR THE MANUFACTURE OR SALE OF ITEMS WITHOUT WRITTEN PERMISSION. COPYRIGHT © DIGITAL EQUIPMENT CORPORATION"

ARRANGEMENT GUIDELINES

3. CPU BACKPLANE SLOT ASSIGNMENTS:

SLOT	UNIT	REMARKS
1	8A CPU M8315	CENTRAL PROCESSOR.
2	KMB-AB M8317	OPTION 2: BOOTSTRAP, CLOCK
3	DKC8-AA M8316	OPTION 1: VT5 β -H INTERFACE, INITIALIZER CABLE.
4	MM8-AA (16KB) OR	CORE MEMORY
5	MM8-AB (32KB)	
6		<div style="text-align: center;"> \updownarrow OPTIONAL EQUIPMENT </div>
7		
8		
9		
10		
11		
12	RX8 M8357	FLOPPY DISK INTERFACE (DEVICE CODE 75)

MODULE INSTALLATION RULES:

1. INSTALL BASIC DS31 β MODULES IN SLOTS 1-5 AND 12 AS SHOWN ABOVE.
2. IF A SECOND MEMORY MODULE IS ORDERED, INSTALL IN SLOTS 6 AND 7.
3. MODULES FOR OTHER OPTIONAL EQUIPMENT ARE INSTALLED STARTING AT SLOT 11 AND COUNTING UPWARDS DEPENDING ON CUSTOMER ORDER. THE EXACT CONFIGURATION BUILT BY THE FACTORY IS SHOWN ON A DECAL ATTACHED TO THE PROCESSOR.

REVISIONS			TITLE		SIZE	CODE	NUMBER	REV.
CHK	CHANGE NO.	REV.	DATASYSTEM 31 β CONFIGURATIONS		B	AR	DS31 β - β - β	
			SCALE	NONE	SHEET 4 OF 8		DIST.	

"THIS DRAWING AND SPECIFICATIONS, HEREIN, ARE THE PROPERTY OF DIGITAL EQUIPMENT CORPORATION AND SHALL NOT BE REPRODUCED OR COPIED OR USED IN WHOLE OR IN PART AS THE BASIS FOR THE MANUFACTURE OR SALE OF ITEMS WITHOUT WRITTEN PERMISSION. COPYRIGHT © , DIGITAL EQUIPMENT CORPORATION"

ARRANGEMENT GUIDELINES

4. POWER SWITCH SETTINGS: FOR NORMAL OPERATIONS, THE SWITCHES ON THE DS31 β COMPONENT UNITS SHOULD BE SET AS FOLLOWS:

861 POWER DISTRIBUTION PANEL

REMOTE/OFF/LOCAL	SET TO	REMOTE	(LEFT)
CIRCUIT BREAKER	SET TO	ON	(UP)

PDP-8/A CENTRAL PROCESSOR

BOOT	SET TO	OFF	(DOWN)
PANEL LOCK	SET TO	OFF	(DOWN)
ON/OFF	SET TO	ON	(UP)

VT5 β -H TERMINAL

ON/OFF	SET TO	ON	(REAR)
--------	--------	----	--------

LA36 RO PRINTER

ON/OFF	SET TO	ON	(UP)
--------	--------	----	------

A
B
AR

A
B
AR

2

2

1

1

REVISIONS		
CHK	CHANGE NO.	REV.

TITLE		SIZE	CODE	NUMBER		REV.
DATASYSTEM 31 β CONFIGURATIONS		B	AR	DS31 β - β - β		
SCALE	SHEET 5 OF 8		DIST.			
NONE						

EN-01120-16-N575-(325)

DRB 122

A

B

A

B

"THIS DRAWING AND SPECIFICATIONS, HEREIN, ARE THE PROPERTY OF DIGITAL EQUIPMENT CORPORATION AND SHALL NOT BE REPRODUCED OR COPIED OR USED IN WHOLE OR IN PART AS THE BASIS FOR THE MANUFACTURE OR SALE OF ITEMS WITHOUT WRITTEN PERMISSION. COPYRIGHT © , DIGITAL EQUIPMENT CORPORATION"

ARRANGEMENT

GUIDELINES

5. MODULE CONFIGURATIONS: WHEN USED IN A DS31Ø SYSTEM, SWITCHES INTERNAL TO THE ELECTRONICS MODULES ARE SET ACCORDING TO THE DIAGRAMS BELOW. NOTE THAT THE FOLLOWING CONVENTION IS USED IN THESE DIAGRAMS:

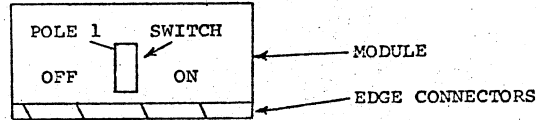

M3315 8/A CPU MODULE

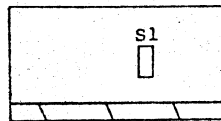

POLE	1	2	3	4	5	6	7	8
S1	OFF	OFF	OFF	OFF	OFF	OFF	ON	ON

M3317 KMB-A OPTION #2 MODULE

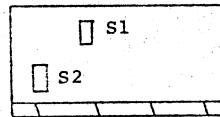

POLE	1	2	3	4	5	6	7	8
S1	ON	OFF	ON	OFF	OFF	OFF	ON	ON
S2	OFF	OFF	OFF	OFF	ON	ON	ON	ON

M3316 DKC8-A OPTION #1 MODULE.

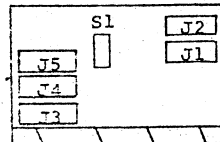

POLE	1	2	3	4	5	6	7	8
S1	ON	ON	ON	ON	ON	ON	ON	OFF

- J1 - NOT USED
- J2 - INITIALIZER SWITCH CABLE
- J3 - VT5Ø-H CABLE
- J4 - NOT USED
- J5 - NOT USED

REVISIONS		
CHK	CHANGE NO.	REV.

TITLE		SIZE	CODE	NUMBER		REV.
DATASYSTEM 31Ø CONFIGURATIONS		B	AR	DS31Ø-Ø-Ø		
SCALE	NONE	SHEET 6 OF 8		DIST.		

A

B

"THIS DRAWING AND SPECIFICATIONS, HEREIN, ARE THE PROPERTY OF DIGITAL EQUIPMENT CORPORATION AND SHALL NOT BE REPRODUCED OR COPIED OR USED IN WHOLE OR IN PART AS THE BASIS FOR THE MANUFACTURE OR SALE OF ITEMS WITHOUT WRITTEN PERMISSION. COPYRIGHT © DIGITAL EQUIPMENT CORPORATION"

ARRANGEMENT GUIDELINES

5. MODULE CONFIGURATIONS (CONT'D)

M8655 KL8-JA MODULE WHEN USED WITH LA36RO (300 BAUD)

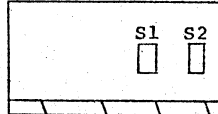

POLE	1	2	3	4	5	6	7	8
S1	OFF	OFF	ON	ON	OFF	ON	ON	OFF
S2	OFF	ON	ON	ON	OFF	ON	OFF	ON

M8357 RX8 MODULE

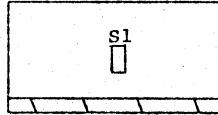

	POLE	1	2	3	4	5	6	7	8
STANDARD DEV. CODE 75:	S1	OFF	ON	OFF	ON	OFF	ON	OFF	OFF
OPTIONAL DEV. CODE 76:	S1	OFF	OFF	ON	ON	ON	OFF	OFF	OFF

4
3
2
1

4
3
2
1

A
B
AR

A
B
AR

REVISIONS		
CHK	CHANGE NO.	REV.

TITLE DATASYSTEM 31Ø CONFIGURATIONS		SIZE B	CODE AR	NUMBER DS31Ø-Ø-Ø		REV.
SCALE NONE	SHEET 7 OF 8		DIST.			

EH-01120-16-N375- (325)

DRB 122

A

B

"THIS DRAWING AND SPECIFICATIONS, HEREIN, ARE THE PROPERTY OF DIGITAL EQUIPMENT CORPORATION AND SHALL NOT BE REPRODUCED OR COPIED OR USED IN WHOLE OR IN PART AS THE BASIS FOR THE MANUFACTURE OR SALE OF ITEMS WITHOUT WRITTEN PERMISSION. COPYRIGHT © , DIGITAL EQUIPMENT CORPORATION"

ARRANGEMENT GUIDELINES

6. RX8 DRIVE UNIT DECALS: THE DS31Ø IS FURNISHED WITH A SET OF DECALS (P/N 3611382) WHICH ARE USED TO IDENTIFY THE LOGICAL UNIT NUMBERS OF THE RX8 DRIVES. ATTACH THE DECALS ABOVE THE RX8 DRIVE HANDLES IN THE SEQUENCE SHOWN BELOW:

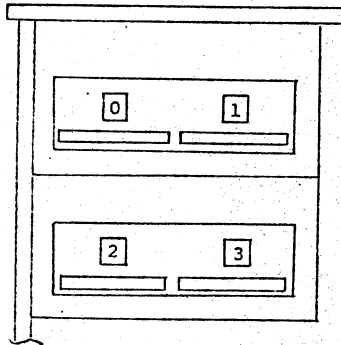

7. AC POWER CABLING: THE AC POWER CABLING FOR THE DS31Ø SYSTEM IS SHOWN BELOW. NOTE THAT THERE IS ONE EXTERNAL AC LINE CORD FOR THE BASIC SYSTEM; THIS LINE CORD ORIGINATES AT THE 861 POWER CONTROL UNIT. NOTE ALSO, THAT THE LA36RO PRINTER MAY BE CONNECTED TO THE 861 CONTROL. HOWEVER, OTHER PRINTERS (LS8 OR LB8) MUST BE CONNECTED DIRECTLY TO AN AC WALL OUTLET.

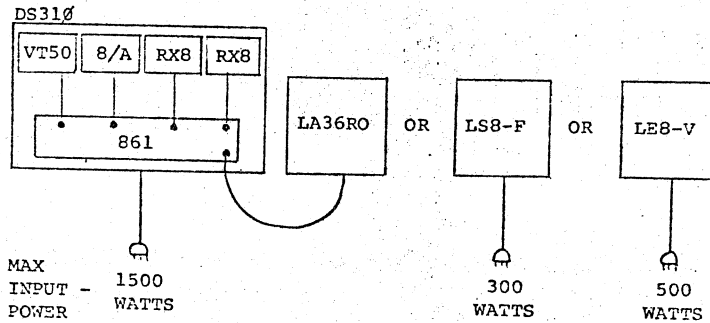

ALL CONNECTORS: 120V/15A/1 PHASE = NEMA 5-15P
OR
240V/15A/1 PHASE = NEMA 6-15P

REVISIONS		
CHK	CHANGE NO.	REV.

TITLE		SIZE	CODE	NUMBER		REV.
DATASYSTEM 31Ø CONFIGURATIONS		B	AR	DS31Ø-Ø-Ø		
SCALE	SHEET	DIST.				
NONE	8 OF 8					