

Digital Equipment Corporation  
Maynard, Massachusetts

PDP-15 Systems

# Installation Manual





# **PDP-15**

# **INSTALLATION MANUAL**

1st Printing January 1970  
2nd Printing (Rev) May 1970

Copyright © 1970 by Digital Equipment Corporation

The material in this manual is for information purposes and is subject to change without notice.

The following are trademarks of Digital Equipment Corporation, Maynard, Massachusetts:

DEC	PDP
FLIP CHIP	FOCAL
DIGITAL	COMPUTER LAB

## CONTENTS

	<b>Page</b>
<b>CHAPTER 1 PLANNING</b>	
1.1	Site Plan 1-1
1.2	Space Requirements 1-1
1.3	System Layout 1-1
1.4	Installation Constraints 1-2
1.5	Fire and Safety Precautions 1-2
1.6	Environmental Considerations 1-2
1.6.1	Humidity and Temperature 1-2
1.6.2	Air-Conditioning System 1-3
1.6.3	Acoustical Damping 1-3
1.6.4	Lighting 1-3
1.6.5	Special Mounting Conditions 1-3
1.6.6	Cleanliness 1-3
1.6.7	Static Electricity 1-3
<b>CHAPTER 2 SYSTEM CONFIGURATIONS</b>	
2.1	Standard Configurations 2-1
2.2	System Expansion 2-1
<b>CHAPTER 3 PREDELIVERY PREPARATION</b>	
3.1	General 3-1
3.1.1	Receipt of Installation Manual 3-1
3.1.2	Three Months Prior to Delivery 3-1
3.1.3	One Month Prior to Delivery 3-1
3.1.4	One Week Prior to Delivery 3-1
3.2	Cabling 3-1
3.3	System Power Requirements 3-2
3.4	Source Power Requirements 3-10
3.4.1	Primary Power Receptacles 3-10
3.4.2	Service Outlets 3-10
<b>CHAPTER 4 INSTALLATION, INSPECTION, AND CHECKOUT</b>	
4.1	Unpacking 4-1
4.1.1	PDP-15 System Cabinet Unpacking 4-1
4.1.2	Teletype Unpacking 4-1
4.2	Inspection 4-2
4.3	Cabinet Installation 4-2
4.4	Peripheral Equipment Inspection 4-4
4.5	Teletype Installation and Setup 4-4
4.5.1	33 ASR and 33 KSR 4-4
4.5.2	35 ASR and 35 KSR 4-4
4.6	Computer-Teletype Cable Installation 4-7

## CONTENTS (Cont)

		<b>Page</b>
4.7	Primary AC Power Cables	4-7
4.8	Transformer Connections	4-7
4.8.1	General	4-7
4.8.2	Transformer T1 Connections	4-7
4.8.3	Plug P15 Connections	4-10
4.9	AC Power Checkout Procedures	4-10
4.10	System Power-Up Activation	4-11

### APPENDIX A MAINTENANCE AND SERVICE OPTIONS

A.1	Service Contracts	A-1
A.1.1	Service Contract Options	A-1
A.1.2	Eligibility for Service Contract Coverage	A-1
A.2	Per-Call Coverage	A-2
A.3	Depot Repair	A-2
A.4	Field Installation of Additional DEC Options	A-3

### APPENDIX B CUSTOMER ACCEPTANCE

B.1	Special Customer Requirements	B-1
B.2	Customer Programs	B-1
B.3	Special Customer Acceptance Testing	B-1
B.4	Diagnostics	B-1
B.5	System Software Acceptance	B-2

### APPENDIX C FORMS AND CHECKLISTS

C.1	Customer Acceptance Forms	C-1
C.2	Customer Data Forms	C-1
C.3	Software Trouble Reports	C-1
C.4	Decus Information	C-1
C.5	Basic Accessory Checklist	C-1
C.6	Optional Equipment Checklist	C-2
C.7	Software Checklist	C-2
C.8	Final Distribution of Forms	C-2

## ILLUSTRATIONS

		<b>Page</b>
2-1	PDP-15/10 System Configuration Diagram	2-2
2-2	PDP-15/20 System Configuration Diagram	2-3
2-3	PDP-15/30 System Configuration Diagram	2-5
2-4	PDP-15/40 System Configuration Diagram	2-7
2-5	PDP-15 Maximum Configuration	2-13
2-6	Memory Multiplexer Maximum Configuration	2-18

## ILLUSTRATIONS (Cont)

		<b>Page</b>
3-1	Basic PDP-15 Cabinet	3-2
3-2	System Configuration	3-3
3-3	Free-Standing Peripheral Device Configuration	3-3
3-4	Memory Multiplexer Cabinet Power Requirements	3-4
3-5	Hubbell Wall Receptacle Connector Diagram	3-11
4-1	Cabinet Bolting Diagram	4-3
4-2	33 ASR and 33 KSR Carriage Retaining Wire Location	4-5
4-3	35 ASR and 35 KSR Right-Side Shock Mount Bolts	4-6
4-4	35 ASR and 35 KSR Left-Side Shock Mount Bolts	4-6
4-5	Transformer Connections for Model 715 Power Supply	4-8
4-6	Transformer Terminal Connector Diagram (Top View)	4-9
4-7	Transformer Terminal Connector Diagram (Side View)	4-10
4-8	DC Power Lamp Locations	4-11

## TABLES

		<b>Page</b>
2-1	PDP-15/10 Basic System	2-2
2-2	PDP-15/20 Advanced Monitor System	2-3
2-3	PDP-15/30 Background/Foreground System	2-4
2-4	PDP-15/40 Disk-Oriented Background/Foreground System	2-6
2-5	Optional Peripheral Equipment Specifications	2-8
2-6	Optional Peripheral Equipment Cable Lengths	2-15
3-1	Power Estimations for PDP-15 Options	3-5
3-2	Power Estimations for PDP-15 Peripherals	3-5
3-3	Standard PDP-15 System Power Requirements	3-9
3-4	Hubbell Wall Receptacle Part Numbers	3-10
4-1	Power Cable Line Identification	4-7
4-2	Transformer T1 Primary and Secondary Terminal Connections	4-9
4-3	Plug P15 Connections	4-10





# PDP-15 FAMILY OF MANUALS

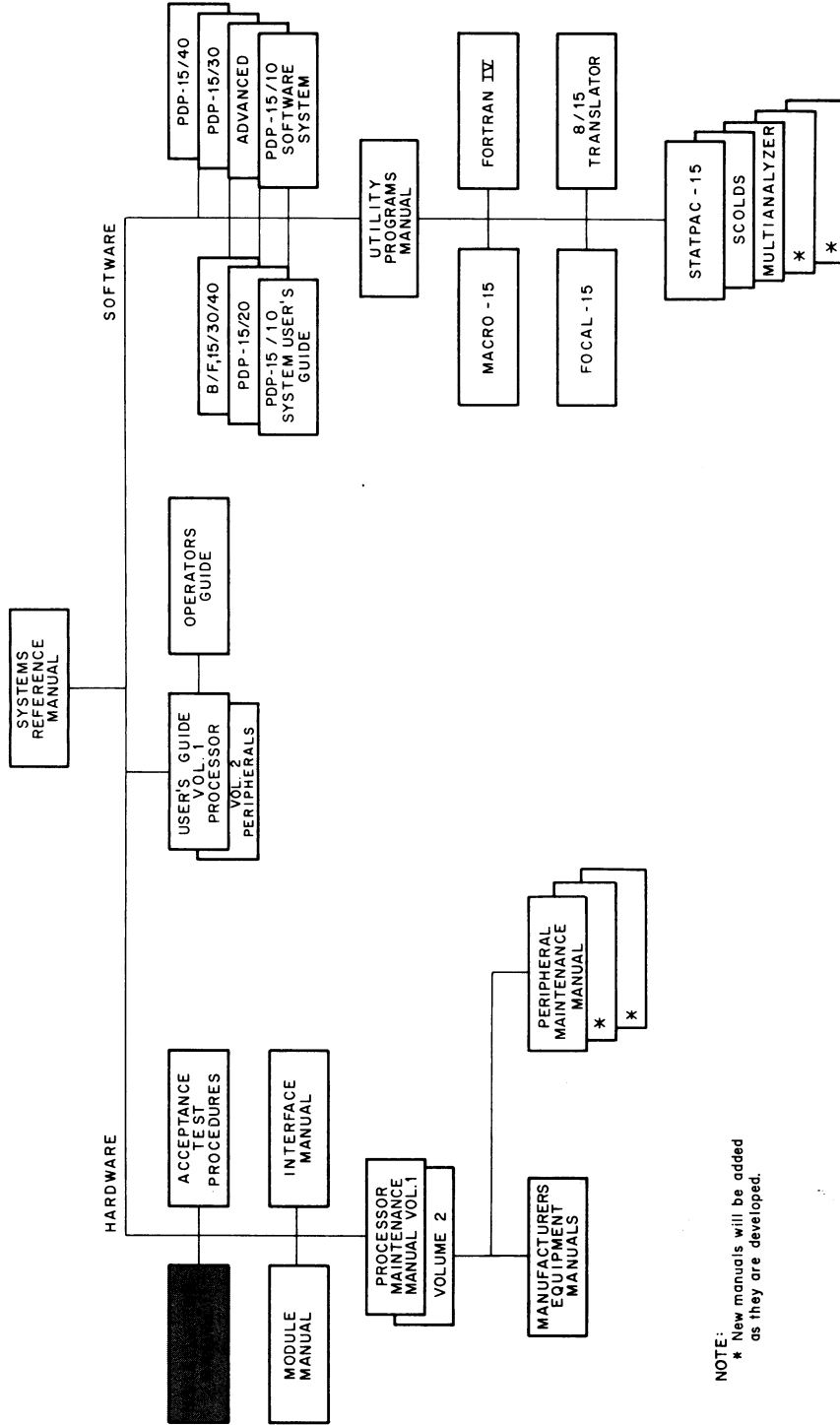

NOTE:  
 \* New manuals will be added as they are developed.

**SYSTEM REFERENCE MANUAL** – Provides overview of PDP-15 hardware and software systems and options, instruction repertoire, expansion features, and descriptions of system peripherals. (DEC-15-GRZA-D)

**USER'S GUIDE VOLUME 1, PROCESSOR** – Principal guide to system hardware includes system and subsystem features, functional descriptions, machine-language programming considerations, instruction repertoire, and system expansion data. (DEC-15-H2DA-D)

**VOLUME 2, PERIPHERALS** – Features functional descriptions and programming considerations of peripheral devices. (DEC-15-H2DA-D)

**OPERATOR'S GUIDE** – Lists procedural data, including operator maintenance, for using the operator's console and the peripheral devices associated with PDP-15 Systems. (DEC-15-H2CA-D)

**PDP-15/10 SYSTEM USER'S GUIDE** – Features COMPACT and Basic I/O Monitor operating procedures. (DEC-15-GG1A-D)

**PDP-15/20 SYSTEM USER'S GUIDE** – Lists Advanced Monitor System operating procedures. (DEC-15-MG2A-D)

**BACKGROUND/FOREGROUND MONITOR SYSTEM USER'S GUIDE** – Lists operating procedures for the DECTape and disk-oriented Background/Foreground monitors. (DEC-15-MG3A-D)

**PDP-15/10 SOFTWARE SYSTEM** – Describes COMPACT software system and Basic I/O Monitor System. (DEC-15-GR1A-D)

**PDP-15/20/30/40 ADVANCED MONITOR SOFTWARE SYSTEM** – Describes Advanced Monitor System; programs include system monitor language, utility, and application types; operation, core organization, and input/output operations within the monitor environment are discussed. (DEC-15-MR2A-D)

**PDP-15/30 BACKGROUND/FOREGROUND MONITOR SOFTWARE SYSTEM** – Describes Background/Foreground Software System including the associated language, utility, and applications program. (DEC-15-MR3A-D)

**PDP-15/40 DISK-ORIENTED BACKGROUND/FOREGROUND MONITOR SOFTWARE SYSTEM** – Describes Background/Foreground Monitor in disk-oriented environment; programs include language, utility, and application types. (DEC-15-MR4A-D)

**MAINTENANCE MANUAL VOLUME 1, PROCESSOR** – Provides block diagram and functional theory of operation of the processor logic; lists preventive and corrective maintenance data. (DEC-15-H2BA-D)

**VOLUME 2, ENGINEERING DRAWINGS** – Provides engineering drawings and signal glossary for the basic processor and options. (DEC-15-H2BA-D)

**INSTALLATION MANUAL** – Provides power specifications, environmental considerations, cabling, and other information pertinent to installing PDP-15 Systems. (DEC-15-H2AB-D)

**ACCEPTANCE TEST PROCEDURES** – Lists step-by-step procedures designed to insure optimum PDP-15 Systems operation.

**PDP-15 MODULE MANUAL** – Provides characteristics, specifications, timing and functional descriptions of modules used in PDP-15 Systems. (DEC-15-H2EA-D)

**INTERFACE MANUAL** – Provides information for interfacing devices to a PDP-15 System. (DEC-15-H0AA-D)

**UTILITY PROGRAMS MANUAL** – Provides utility programs common to PDP-15 Monitor systems. (DEC-15-YWZA-D)

**MACRO-15** – Provides MACRO assembly language for the PDP-15. (DEC-15-AMZA-D)

**FORTRAN IV** – Describes PDP-15 version of the FORTRAN IV compiler language. (DEC-15-KFZA-D)

**FOCAL-15** – Describes an algebraic interactive compiler level language developed by Digital Equipment Corporation. (DEC-15-KJZA-D)

## Preface

This manual provides planning, site preparation, preinstallation, and installation information and recommendations to ensure a successful PDP-15 installation.

Digital Equipment Corporation (DEC) will provide customer assistance in all phases of site planning. The final lay-out plan should be approved jointly by the customer and DEC.

Planning considerations include: floor-plan layout for equipment; environmental considerations; fire and safety precautions; and storage facilities for paper tapes, Teletype<sup>®</sup> paper, punch cards, plotter paper supplies, etc.

Site preparation is keyed basically to the customer's applicable requirements or desires and can, therefore, range from providing the required source-power circuit to the construction or remodeling of the selected installation site.

---

<sup>®</sup>Teletype is the registered trademark of Teletype Corporation.

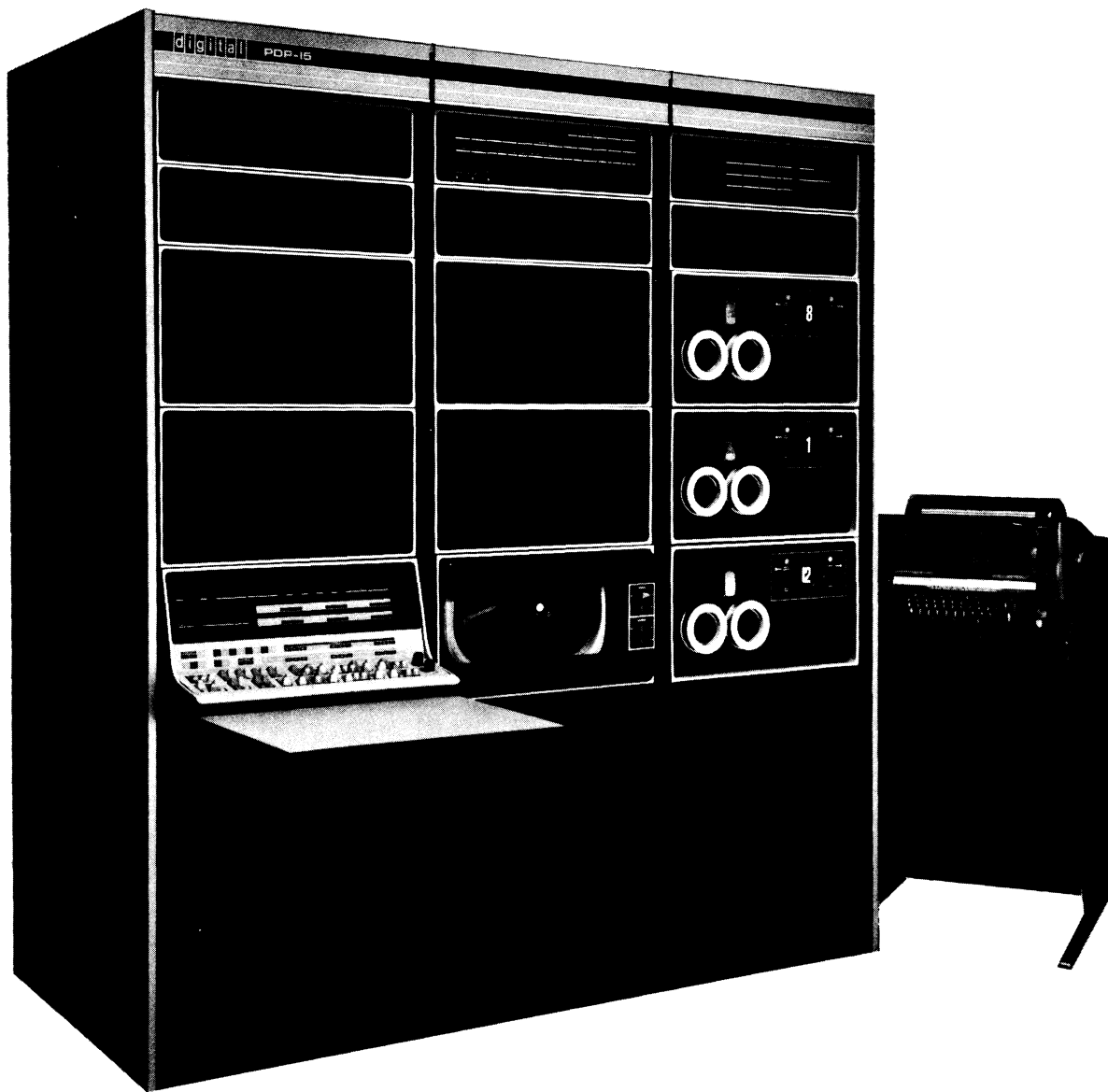

# Chapter 1

## Planning

### 1.1 SITE PLAN

Adequate site planning and preparation can simplify the installation process and result in an efficient, reliable PDP-15 System installation. DEC Sales Engineers and/or Field Service personnel are available for counseling and consultation with customer-designated personnel regarding objectives, course of action, and progress of the installation.

The customer's planning staff should prepare a list of the actual components to be used in the installation. This list should include such items as tape-storage cabinets, work tables and desks, and any other items pertinent to the customer's computer application.

Primary planning considerations are the availability and location of adequate power and the existence of fire and personnel safety precautions. If the existing environmental conditions dictate, air-conditioning and/or humidifying equipment installation can become part of the site planning and preparation program.

### 1.2 SPACE REQUIREMENTS

Space requirements are determined by the specific system configuration to be installed and, when applicable, provision for future expansion. To determine the exact area required for a specific configuration, a machine-room floor plan layout is helpful. When applicable, space is provided in the machine room for storage of tape reels, printer forms, card files, etc. The integration of the work area with the storage area depends on the work-flow requirement between areas.

In large installations where test equipment is maintained, DEC recommends that the test equipment storage area be within or adjacent to the machine room.

### 1.3 SYSTEM LAYOUT

PDP-15 Systems can be ordered under three types of layout plans. The three types are:

Plan A – an unmodified, standard PDP-15 System configuration. This plan provides a fixed configuration including standard cable lengths to free-standing peripherals;

Plan B – a configuration similar to Plan A except that either the cabinet-mounted peripheral configuration or the free-standing peripheral locations are different from DEC specifications;

Plan C – a special PDP-15 installation dictated by the customer's application and built by DEC's Computer Special Systems group. For such a plan, the customer should prepare a layout of PDP-15 cabinet and peripheral equipment locations and submit the layout to DEC for approval. If the PDP-15 control console is to be remotely installed, the distance from the console to the PDP-15 must be specified by the customer. The appropriate interconnecting cable can then be supplied by DEC.

#### NOTE

**Advanced notice for systems of special (non-standard) configuration is required and is subject to approval by the Special Systems engineering group.**

Operational requirements determine the specific location of the various free-standing peripherals of the system. Dimensions, weights, and service clearances of free-standing peripheral equipments are shown in Table 2-5. Standard and maximum cable lengths are shown in Table 2-6. Computer peripherals and/or the remote console must be

located so that the length of connecting cables will not exceed maximum limits. The following points should be considered when planning the PDP-15 layout:

- a. Ease of visual observation of input/output devices by operating personnel.
- b. Adequate work area for installing tapes, allowing access to console, etc.
- c. Space availability for contemplated future expansion.
- d. Proximity of the cabinets and peripherals to any humidity-controlling or air-conditioning equipment.

The final layout is reviewed by the DEC Sales Engineer and in-house engineering personnel to ensure that cable limitations are not exceeded and that proper clearances are maintained.

When applicable, the DEC Field Service Branch Manager provides a scaled layout of the Field Service Engineering equipment to be installed in the computer room.

#### 1.4 INSTALLATION CONSTRAINTS

The route that the equipment is to travel from the receiving area to the installation site should be studied and measurements taken to facilitate delivery of the equipment. All measurements and floor plans should be submitted to the DEC Sales Engineer to ensure that the equipment is packed to suit the installation site facilities. If possible, this information should be provided upon placement of the order. Any restrictions (such as bends or obstructions in the hallways, etc.) should be reported to DEC.

If an elevator is to be used for transferring the PDP-15 and its related equipment to the installation site, DEC should be notified of the size and gross weight limitations of the elevator. The equipment can then be packed and shipped accordingly.

#### 1.5 FIRE AND SAFETY PRECAUTIONS

The following fire and safety precautions are presented as an aid in providing an installation that affords adequate

operational safeguards for personnel and system components.

- a. If an overhead sprinkler system is used, a "dry pipe" system is recommended. This type of system, upon detection of a fire, removes source power to the room and then opens a master valve to fill the room's overhead sprinklers.
- b. If the fire detection system is of the type that shuts off the power to the installation, a battery-operated emergency light source should be provided.
- c. If an automatic carbon-dioxide fire protection system is used, an alarm should sound on release of the CO<sub>2</sub> to warn personnel within the installation.
- d. If power connections are made beneath the floor of a raised-floor installation, waterproof electrical receptacles and connections should be used.
- e. An adequate earth ground connection should be provided for the protection of operating personnel.

#### 1.6 ENVIRONMENTAL CONSIDERATIONS

An ideal computer room environment has an air distribution system which provides cool, well-filtered, humidified air. The room air pressure should be kept higher than the pressure of adjacent areas to prevent dust infiltration.

##### 1.6.1 Humidity and Temperature

The PDP-15 System is designed to operate in a temperature range of from 50°F (10°C) to 110°F (43°C) at a relative humidity of 20 to 90 percent with no condensation. However, typical system configurations using input/output devices such as magnetic tape units, card readers, etc., require an operational temperature range between 65°F (18°C) and 80°F (27.5°C), with 40 to 55 percent relative humidity. Nominal operating conditions for a typical system are a temperature of 70°F (21°C) with a noncondensation relative humidity of 45 percent.

### 1.6.2 Air-Conditioning System

Tables 3-1, 3-2, and 3-3 show the heat dissipation factors of the PDP-15 System and its peripheral equipment. When used, computer room air-conditioning equipment should conform to the requirements of the "Standard for the Installation of Air-Conditioning and Ventilating Systems (non-residential)", N.F.P.A. No. 90A; as well as to the requirements of the "Standard for Electronic Computer Systems", N.F.P.A. No. 75.

### 1.6.3 Acoustical Damping

Some peripheral devices (such as line printers and magnetic tape transports) have a high noise level. In installations that use a group of high noise-level devices, an acoustically damped ceiling reduces the noise.

### 1.6.4 Lighting

If cathode-ray tube peripheral devices are part of the system, the illumination surrounding these peripherals should be reduced to enable the operator to conveniently observe the display.

### 1.6.5 Special Mounting Conditions

If the PDP-15 will be subjected to rolling, pitching, or vibration of the mounting surface (e.g., aboard ship), the cabinetry should be securely anchored to the installation floor by mounting bolts. Because such installations require modifications to the PDP-15 System Cabinets, DEC

must be notified of the special conditions upon placement of the order.

### 1.6.6 Cleanliness

The following precautions are recommended by DEC to ensure optimum PDP-15 operation:

- a. Do not use steel wool for cleaning floors in the computer room. The metal fibers can enter the cabinets and short the electrical components.
- b. To prevent air flow interference, do not place material on top of the cabinets.
- c. Use a nonconductor type nozzle when vacuuming to minimize the possibility of an electrical accident.
- d. Avoid spilling liquids (coffee, soda, etc.) on the equipment and operating controls (e.g., console switches, Teletype keys and controls).

### 1.6.7 Static Electricity

Static electricity can be an annoyance to operating personnel and can (in extreme cases) affect the operational characteristics of the PDP-15 and related peripheral equipments. If carpeting is installed on the installation room floor, it should be of a type designed to minimize the effects of static electricity. Flooring consisting of metal panels, or flooring with metal edges, should be adequately grounded.





# Chapter 2

## System Configurations

### 2.1 STANDARD CONFIGURATIONS

There are four standard PDP-15 System configurations; components are detailed in the table and figure indicated.

- a.* PDP-15/10 (Table 2-1, Figure 2-1)
- b.* PDP-15/20 (Table 2-2, Figure 2-2)
- c.* PDP-15/30 (Table 2-3, Figure 2-3)
- d.* PDP-15/40 (Table 2-4, Figure 2-4)

### 2.2 SYSTEM EXPANSION

PDP-15 Systems can be expanded to the cabinet configuration shown in Figure 2-5 and can be further expanded to include up to three memory multiplexer cabinets. Memory multiplexer maximum configuration is shown in Figure 2-6. Table 2-5 lists all peripheral devices available with PDP-15 Systems, and Figure 2-5 illustrates the physical location of the device controllers and cabinet mounted devices. Free-standing peripheral devices are not shown. Peripherals such as disks, CRT displays, industry-compatible magnetic tape transports, card readers, and line printers are all free-standing; their proximity to the PDP-15 is determined by the length of the cable interconnecting the device and its controller (refer to Table 2-6). All system expansion cables are supplied by DEC.

**Table 2-1**  
**PDP-15/10 Basic System**

Quantity	Item	Model
1	PDP-15 CPU, I/O Processor, Console and Power Supply	
1	18-bit, 800-ns, 4096-word Memory	MM15-A
1	Teletype, with paper-tape reader and punch	33 ASR or 35 ASR

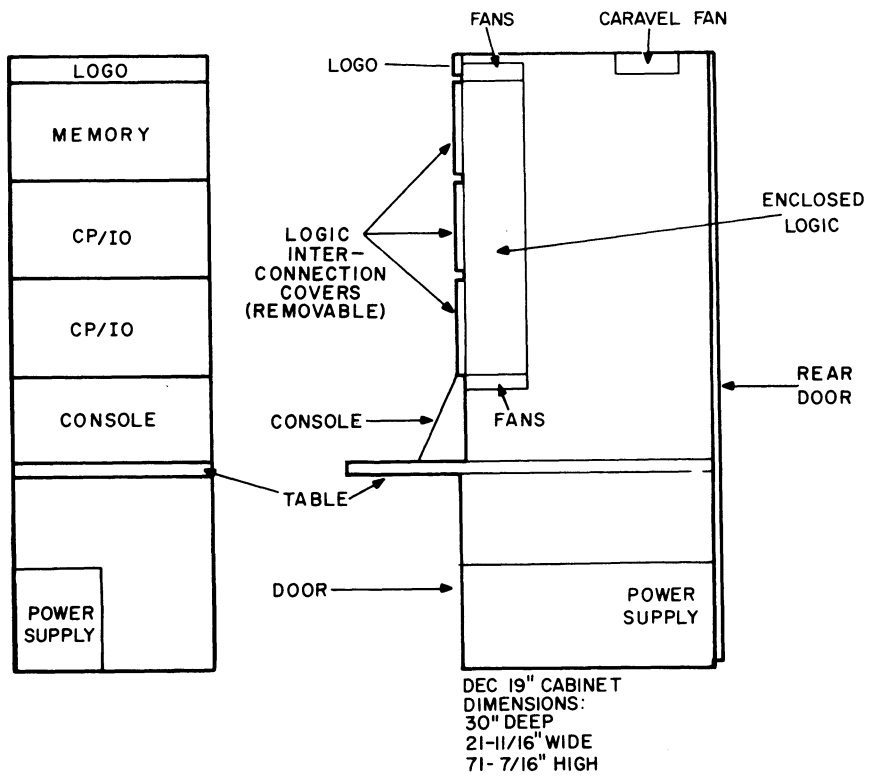

15-0013

Figure 2-1 PDP-15/10 System Configuration Diagram

**Table 2-2  
PDP-15/20 Advanced Monitor System**

Quantity	Name	Model
1	PDP-15 (CPU, I/O Processor, Console and Power Supply)	
1	Extended Arithmetic Element	KE15
1	18-bit, 800-ns, 8192 word memory	MM15-A, MK15-A
1	Teletype	35 KSR
1	High-Speed Paper-Tape Reader/Punch	PC15
2 or 1	DECTape Transport	TU55*
1	Dual DECTape Transport	TU56*
1 or 1	DECTape Control	TC02-D*
1	DECTape Control	TC15*
1	I/O Bus Converter	DW15A*

\*One TU56 can be substituted for two TU55s. The TC02-D controls TU55s; the TC15 controls TU56s. Systems using the TC02-D require the DW15A. Systems using the TC15 do not require the DW15A.

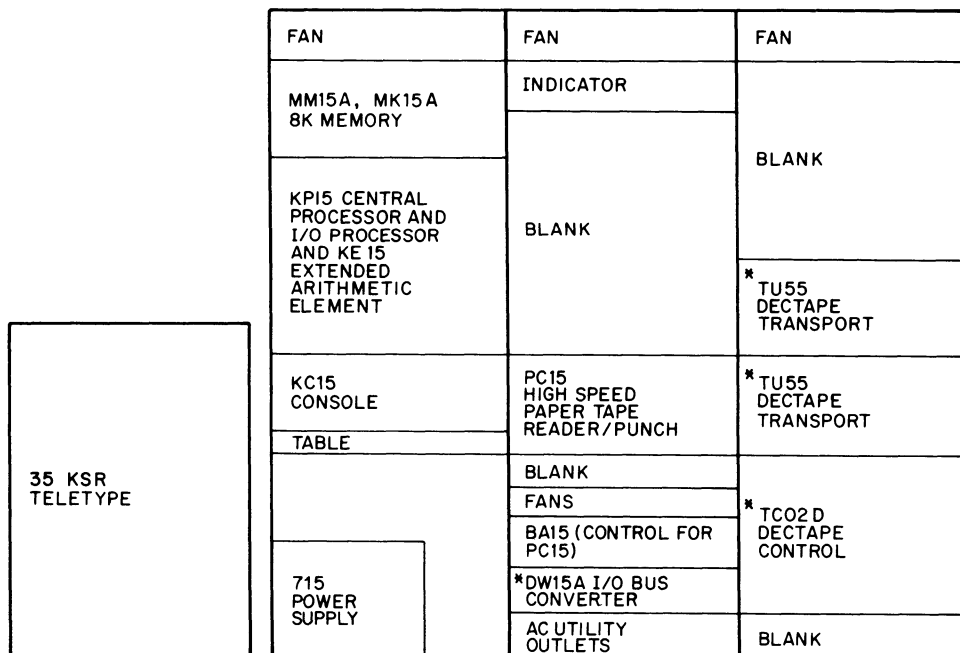

**NOTE**

\* One TU56 Dual DECTape Transport can be substituted for two TU55 DECTape Transports. To control the TU56, a TC15 DECTape Control is required. The TC15 does not require a DW15A. The DW15A is required for the TC02. The TU55, TU56, and TC15 are each 10 1/2 inches high. The TC02 is 15 3/4 inches high.

15-0122

Figure 2-2 PDP-15/20 System Configuration Diagram

**Table 2-3  
PDP-15/30 Background/Foreground System**

Quantity	Name	Model
1	PDP-15 (CPU, I/O Processor, Console and Power Supply)	
1	Extended Arithmetic Element	KE15
1	Automatic Priority Interrupt System	KA15
1	Memory Protect System	KM15
1	Real-Time Clock	KW15
1	18-bit, 800-ns, 16,384 word memory	2-MM15-A 2-MK15-A
1	Teletype (for foreground)	33 KSR
1	Single Teletype Control	LT15A
1	Teletype (for background)	35 KSR
1	High Speed Paper Tape Reader/Punch	PC15
3	DECTape Transport	TU55*
or 2	Dual DECTape Transport	TU56*
1	DECTape Control	TC02-D*
or 1	DECTape Control	TC15*
	I/O Bus Converter	DW15A*

\*Two TU56s can be substituted for the three TU55s. The TC02-D controls TU55s; the TC15 controls TU56s. Systems using the TC02-D require the DW15A. Systems using the TC15 do not require the DW15A.

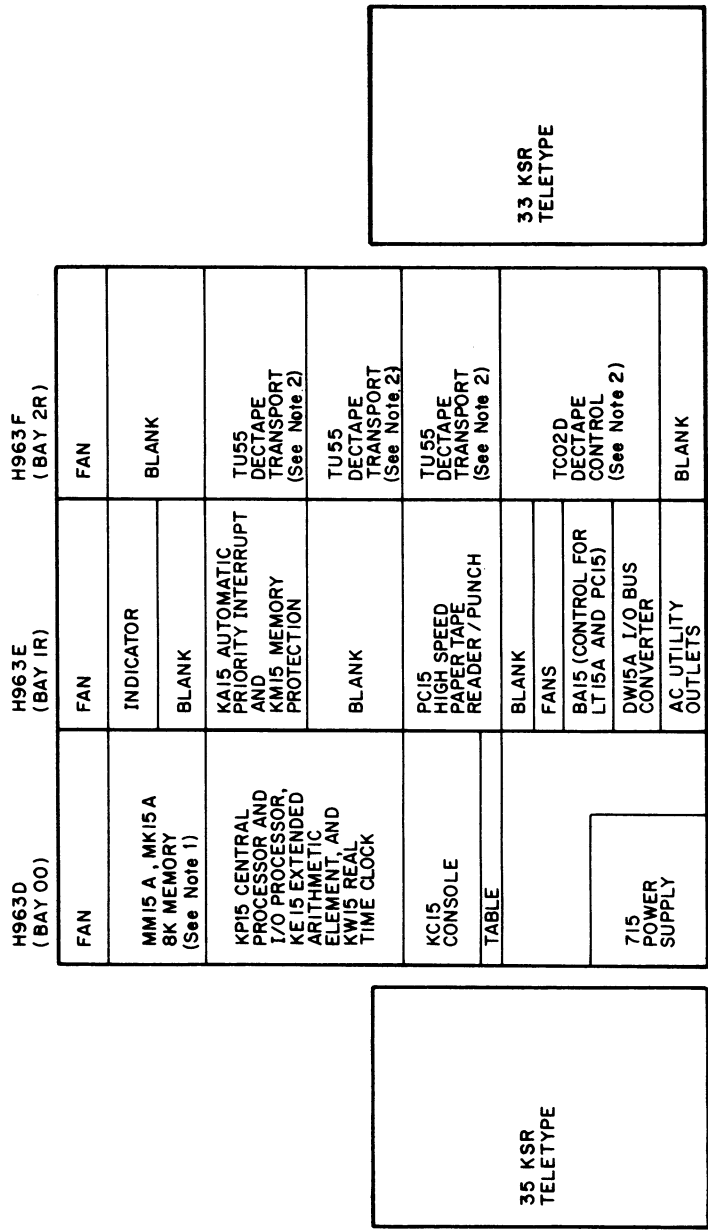

**NOTES**

1. An identical 8K memory is mounted on the rear door of cabinet H963D. There is space on this door for mounting two more 8K modules.
2. Two TU56 Dual DECTape Transports can be substituted for the three TU55 DECTape Transports. To control the TU56s, a TC15 DECTape Control is required. The TC15 does not require a DW15A. The DW15A is required for the TC02D. The TU55, TU56 and TC15 are each 10-1/2 inches high. The TC02D is 15-3/4 inches high.

15-0123

Figure 2-3 PDP-15/30 System Configuration Diagram

**Table 2-4  
PDP-15/40 Disk-Oriented Background/Foreground System**

Quantity	Name	Model
1	PDP-15 (CPU, I/O Processor, Console and Power Supply)	
1	Extended Arithmetic Element	KE15
1	Automatic Priority Interrupt System	KA15
1	Memory Protection	KM15
1	Real-Time Clock	KW15
1	18-bit, 800-ns, 24,576 word memory	3-MM15-A 3-MK15-A
1	Teletype (for background)	35 KSR
1	Single-Teletype Control	LT15A
1	Teletype (for foreground)	33 KSR
1	High Speed Paper Tape Reader/Punch	PC15
2	DECTape Transport	TU55*
or 1	DECTape Transport	TU56*
1	DECTape Control	TC02-D*
or 1	DECTape Control	TC15*
1	I/O Bus Converter	DW15A*
1	DECdisk Control	RF15
2	DECdisk Drives	RS09

\*One TU56 can be substituted for two TU55s. The TC02-D controls TU55s; the TC15 controls TU56s. Systems using the TC02-D require the DW15A. Systems using the TC15 do not require the DW15A.

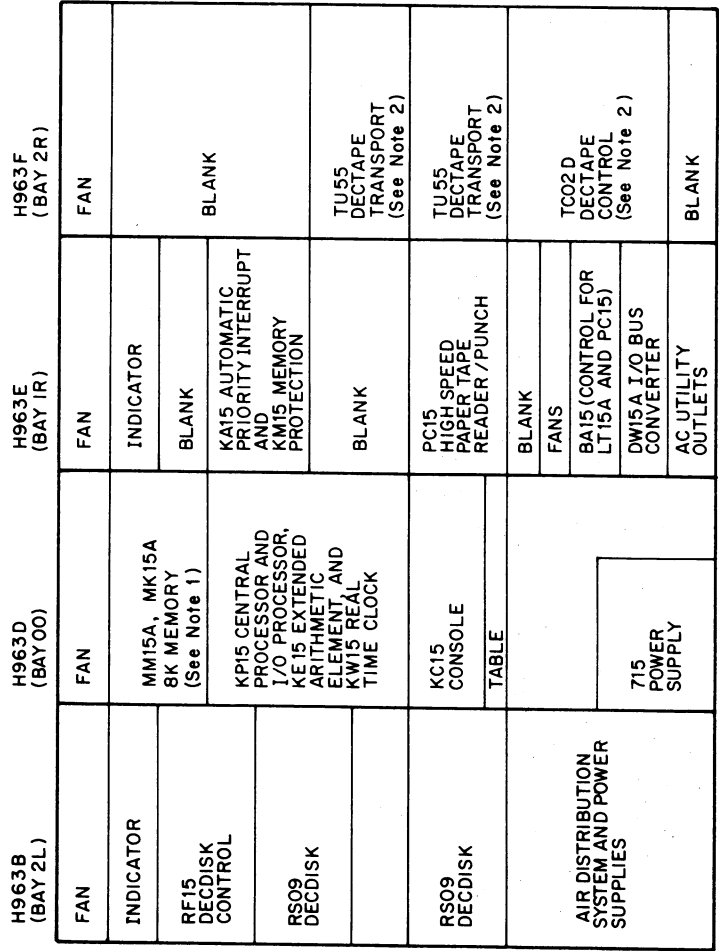

35 KSR  
TELETYPE

33 KSR  
TELETYPE

**NOTES**

1. Two more 8K memory modules are mounted on the rear door of cabinet H963D. There is space on this door for mounting one more 8K module.
2. One TU56, Dual DECTape Transport can be substituted for two TU55 DECTape Transports. To control the TU56, a TC15 DECTape Control is required. The TC15 does not require a DW15A. The DW15A is required for the TC02D. The TU55, TU56, and TC15 are each 10-1/2 inches high. The TC02D is 15-3/4 inches high.

Figure 2-4 PDP-15/40 System Configuration Diagram

**Table 2-5  
Optional Peripheral Equipment Specifications**

	Peripheral Equipment	Prerequisite	Dimensions				Service Clearance	
			Height (in(cm))	Width (in(cm))	Depth (in(cm))	Weight (lb)	Front (in(cm))	Rear (in(cm))
<b>MASS STORAGE DEVICES</b>								
TC02D	DECtape control for up to 8 TU55 DECtape Transport Units	DW15*	Mounted in Cabinet			38		
TC15	DECtape control for up to 4 TU56 Dual DECtape Transport Units	None	Mounted in Cabinet					
TU55	DECtape Transport	TC02D	Mounted in Cabinet			40	16-3/4(42.5)	
TU56	Dual DECtape Transport	TC15	Mounted in Cabinet			80		
TC59D	Magnetic Tape Transport Control for up to 8 TU20, TU20A, TU30, TU30A Magnetic Tape Transport Units	DW15A* KW15	Mounted in Cabinet			50		
TU20B	7-Track, 45 ips Magnetic Tape Transport 200,556 and 800 bpi	TC59D	69-1/8(177)	22-1/4(56.5)	27-1/16(68.6)	400	19(48.3)	19(48.3)
TU20A	9-Track, 45 ips Magnetic Tape Transport 800 bpi	TC59D	69-1/8(176)	22-1/4(56.5)	27-1/16(68.6)	400	19(48.3)	19(48.3)
TU30B	7-Track, 75 ips Magnetic Tape Transport 200,556 and 800 bpi	TC59D	71(180)	31-1/2(80)	27(68.5)	800	27(68.5)	27(68.5)
TU30A	9-Track, 75 ips Magnetic Tape Transport 800 bpi	TC59D	71(180)	31-1/2(80)	27(68.5)	800	27(68.5)	27(68.5)
RF15	DECdisk Control for up to 8 RS09 DECdisk Units	None	Mounted in Cabinet			220		
RS09	262,144 Word DECdisk	RF15	Mounted in Cabinet			100		
RP15	Disk Pack Control for up to 8 RP02 Disk Pack Units	None	Mounted in Cabinet					
RP02	10.24 million-word Drive Unit - Includes one RP02P Disk Pack	RP15	39(99)	30(76)	24(61)	295	36(91.4)	36(91.4)

\*Only one DW15A is required for any system configuration.



Table 2-5 (Cont)  
Optional Peripheral Equipment Specifications

Peripheral Equipment	Prerequisite	Dimensions			Service Clearance		
		Height (in(cm))	Width (in(cm))	Depth (in(cm))	Weight (lb)	Front (in(cm))	Rear (in(cm))
RP02P Disk Pack	RP02	Mounts in RP02					
<b>DISPLAY DEVICES</b>							
VP15A Storage Tube Display VT01 Storage Display Unit Control, and Mounting Hardware	None	14-11/16(36.8)	9-3/4(24.8)	21-5/8(54.8)	51	Table Top (table not supplied)	
VP15B Oscilloscope Display Tektronix RM503 X-Y Oscilloscope, Control, and Mounting Hardware	None	Mounted in Cabinet			28	Rack mounted	
VP15BL Oscilloscope Display Tektronix RM503 X-Y Oscilloscope, Control, Mounting Hardware, and DEC Type 370 Light Pen	None	Mounted in Cabinet			28	Rack mounted	
VP15C Oscilloscope Display VR12 X-Y Display Unit (7 in. x 9 in. CRT) Control, and Mounting Hardware	None	10-1/2(26.6)	19(48.3)	17(43.1)	53		
VP15CL Oscilloscope Display VR12 X-Y Display Unit (7 in. x 9 in. CRT) Control, Mounting Hardware, and DEC type 370 Light Pen	None	10-1/2(26.6)	19(48.3)	17(43.1)	53	Rack mounted	
VT15A Graphic Processor	None	21(53.2)	Mounted in Cabinet			Rack mounted	
VT15B Graphic Processor	None	21(53.2)	Mounted in Cabinet			Rack mounted	
VT04 Graphic Display Console	VT15A or VT15B	51-1/2(129.8)	21-1/2(54.6)	30(76.2)		36(91.4)	36(91.4)
<b>CARD INPUT</b>							
CR03B Card Reader (Table Top) – 200 cards/minute Reader and Control	DW15A*	18-1/4(46.4)	14(35.6)	18(45.7)	47	Sets on table top (table not supplied)	

\*Only one DW15A is required for any system configuration.

**Table 2-5 (Cont)**  
**Optional Peripheral Equipment Specifications**

Peripheral Equipment	Prerequisite	Dimensions				Service Clearance	
		Height (in(cm))	Width (in(cm))	Depth (in(cm))	Weight (lb)	Front (in(cm))	Rear (in(cm))
<b>PAPER TAPE INPUT</b>							
PC15 Paper Tape Station – 300 characters/second Reader, 50 characters/second Punch	None	Mounted in Cabinet			60	18(4.57)	
<b>PRINTERS AND PLOTTERS</b>							
LP15F Line Printer – 300 ipm Line Printer and Control	None	46(117)	23-1/2(60)	32-1/2(83)	100	36(91.4)	48(122)
LP15C Line Printer – 1000 ipm Line Printer and Control	None	55(140)	56(142)	30(76)	600	36(91.4)	36(91.4)
<b>CALCOMP PLOTTER AND CONTROL</b>							
XY15AA 12-in. Drum Plotter, Model 565, and Control 0.01-in. Step 18,000 Steps/Minute	DW15A*	9-3/4(24.9)	18(45.7)	14.7(37.3)	53	Sets on table top (table not supplied)	
XY15AB 0.005-in. Step 18,000 Steps/Minute	DW15A*	9-3/4(24.9)	18(45.7)	14.7(37.3)	53	Sets on table top (table not supplied)	
XY15BA 31-in. Drum Plotter, Model 563, and Control 0.01-in. Step 12,000 Steps/Minute	DW15A*	9-3/4(24.9)	39-3/8(100)	14.7(37.3)	53	Sets on table top (table not supplied)	
XY15BB 0.005-in. Step 18,000 Steps/Minute	DW15A*	9-3/4(24.9)	39-3/8(100)	14.7(37.3)	53	Sets on table top (table not supplied)	
XY15 Control Only	DW15A*	Mounted in Cabinet					
<b>DATA COMMUNICATIONS</b>							
LT19D Multi-Station Teletype Control (Expands to 5 LT19B Line Units)	DW15A*	Mounted in Cabinet			25		
LT19E Line Unit (One Required for each Teletype or EIA Line Adapter)	LT19D	Module sets in LT19D					

\*Only one DW15A is required for any system configuration.

**Table 2-5 (Cont)**  
**Optional Peripheral Equipment Specifications**

	Peripheral Equipment	Prerequisite	Dimensions				Service Clearance	
			Height (in(cm))	Width (in(cm))	Depth (in(cm))	Weight (lb)	Front (in(cm))	Rear (in(cm))
LT19F	EIA Line Adapter (Per Line)	LT19D, E	Module sets in LT19D					
LT15A	Single-Teletype Control	None	Mounted in Cabinet					
33 KSR	Teletype Model 33 Keyboard Send-Receive Unit	None	33(83.62)	19(48.3)	19(48.3)	52		
33 ASR	Teletype Model 33 Automatic Send-Receive Unit with Paper Tape Reader and Punch	None	33(83.62)	22(55.9)	19(48.3)	56		
35 KSR	Teletype Model 35 Keyboard Send-Receive Unit	None	40(102)	20(51)	28(71)	150		
35 ASR	Teletype Model 35 Automatic Send-Receive Unit with Paper Tape Reader and Punch	None	40(102)	40(102)	28(71)	220		
DP09A	Data Communications System Compatible with EIA RS 232B Interface, Bell System Type 201 Dataphone	DW15A*	Mounted in Cabinet					
<b>SCANNER AND CONTROLLER</b>								
AF04B	IDVM/Scanner		Mounted in Cabinet					
	200 Channels		24(61)			220		
	400 Channels		34(86.4)			240		
	600 Channels		44(112)			260		
	800 Channels		54(137)			280		
	1000 Channels		64(163)			300		
AA15A	DAC Controller	None	Mounted in Cabinet					
AA22	DAC Controller Extension	AA15A	Mounted in Cabinet					
<b>MULTIPLXER</b>								
AF01B	ADC Multiplexer		Mounted in Cabinet					

\*Only one DW15A required for any system configuration.



**Table 2-6  
Optional Peripheral Equipment Cable Lengths**

Peripheral Equipment		Cable Length (ft(m))	
		Standard	Maximum*
<b>MASS STORAGE DEVICES</b>			
TC02D	DECtape control for up to 8 TU55 DECtape Transport Units		
TC15	DECtape control for up to 4 TU56 Dual DECtape Transport Units		
TU55	DECtape Transport	up to 15(4.5)	15(4.5)
TU56	Dual DECtape Transport	4(1.2)	15(4.5)
TC59D	Magnetic Tape Transport Control for up to 8 TU20B, TU20A, TU30B, TU30A Magnetic Tape Transport Units		
TU20B	7-Track, 45 ips Magnetic Tape Transport 200,556 and 800 bpi	10(3.048)	100(30.48)
TU20A	9-Track, 45 ips Magnetic Tape Transport 800 bpi	10(3.048)	100(30.48)
TU30B	7-Track, 75 ips Magnetic Tape Transport 200,556 and 800 bpi	15(4.5)	100(30.48)
TU30A	9-Track, 75 ips Magnetic Tape Transport 800 bpi	15(4.5)	100(30.48)
RF15	DECdisk Control for up to 8 RS09 DECdisk Units		
RS09	262,144 Word DECdisk		
RP15	Disk Pack Control for up to 8 RP02 Disk Pack Units		
RP02	10.24 million-word Drive Unit – Includes one RP02P Disk Pack	20(6.1)	50(15.24)
RP02P	Disk Pack		
<b>DISPLAY DEVICES</b>			
VP15A	Storage Tube Display VT01 Storage Display Unit Control, and Mounting Hardware	up to 15(4.5)	15(4.5)
VP15B	Oscilloscope Display Tektronix RM503 X-Y Oscilloscope, Control, and Mounting Hardware		
VP15BL	Oscilloscope Display Tektronix RM503 X-Y Oscilloscope, Control, Mounting Hardware, and DEC Type 370 Light Pen		
*Special quotations are required for nonstandard cable lengths. See paragraph 3.2.			

**Table 2-6 (Cont)  
Optional Peripheral Equipment Cable Lengths**

Peripheral Equipment		Cable Length (ft(m))	
		Standard	Maximum*
VP15C	Oscilloscope Display VR12 X-Y Display Unit (7 in. x 9 in. CRT) Control, and Mounting Hardware	up to 15(4.5)	15(4.5)
VP15CL	Oscilloscope Display VR12 X-& Display Unit (7 in. x 9 in. CRT) Control, Mounting Hardware, and DEC Type 370 Light Pen	up to 15(4.5)	15(4.5)
VT15	Graphic Processor	up to 75(22.5)	75(22.5)
VT04	Graphic Display Console	up to 25(7.5)	25(7.5)
<b>CARD INPUT</b>			
CR03B	Card Reader (Table Top) – 200 characters/minute Reader and Control	7(2.134)	15(4.5)
<b>PAPER TAPE INPUT</b>			
PC15	Paper Tape Station – 300 characters/second Reader, 50 characters/second Punch		
<b>PRINTERS AND PLOTTERS</b>			
LP15F	Line Printer – 300 ipm Line Printer and Control	25(7.62)	25(7.62)
LP15C	Line Printer – 1000 ipm Line Printer and Control	15(4.5)	25(7.62)
<b>CALCOMP PLOTTER AND CONTROL</b>			
XY15AA	12-in. Drum Plotter, Model 565, and Control 0.01-in. Step 18,000 Steps/Minute	10(3.048)	10(3.048)
XY15AB	0.005-in. Step 18,000 Steps/Minute	10(3.048)	10(3.048)
XY15BA	31-in. Drum Plotter, Model 563, and Control 0.01-in. Step 12,000 Steps/Minute	10(3.048)	10(3.048)
XY15BB	0.005-in. Step 18,000 Steps/Minute	10(3.048)	10(3.048)
XY15	Control Only		
<b>DATA COMMUNICATIONS</b>			
LT19D	Multi-Station Teletype Control (Expands to 5 LT19B Line Units)	12(3.66)	2000(609.6)

\*Special quotations are required for nonstandard cable lengths. See paragraph 3.2.

**Table 2-6 (Cont)**  
**Optional Peripheral Equipment Cable Lengths**

Peripheral Equipment		Cable Length (ft(m))	
		Standard	Maximum*
LT19E	Line Unit (One Required for each Teletype or EIA Line Adapter)	12(3.66)	2000(609.6)
LT19F	EIA Line Adapter (Per Line)		
LT15A	Single-Teletype Control		
33 KSR	Teletype Model 33 Keyboard Send-Receive Unit	12(3.66)	2000(609.6)
33 ASR	Teletype Model 33 Automatic Send-Receive Unit with Paper Tape Reader and Punch	12(3.66)	2000(609.6)
35 KSR	Teletype Model 35 Keyboard Send-Receive Unit	12(3.66)	2000(609.6)
35 ASR	Teletype Model 35 Automatic Send-Receive Unit with Paper Tape Reader and Punch	12(3.66)	2000(609.6)
DP09A	Data Communications System Compatible with EIA RS 232B Interface, Bell System Type 201 Dataphone		
<b>SCANNER AND CONTROLLER</b>			
AF04B	IDVM/Scanner 200 Channels 400 Channels 600 Channels 800 Channels 1000 Channels		
AA15A	DAC Controller		
AAC2	DAC Controller Extension		
<b>MULTIPLEXER</b>			
AF01B	ADC Multiplexer		
*Special quotations are required for nonstandard cable lengths. See paragraph 3.2.			

H963	H963	H963
FANS	FANS	FANS
MM15A, MK15A 8K MEMORY	MM15A, MK15A 8K MEMORY	MM15A, MK15A 8K MEMORY
MM15A, MK15A 8K MEMORY	MM15A, MK15A 8K MEMORY	MM15A, MK15A 8K MEMORY
FANS	FANS	FANS
MM15A, MK15A 8K MEMORY	MM15A, MK15A 8K MEMORY	MM15A, MK15A 8K MEMORY
MM15A, MK15A 8K MEMORY	MM15A, MK15A 8K MEMORY	MM15A, MK15A 8K MEMORY
FANS	FANS	FANS
MX15A MULTIPLEXER	MX15A MULTIPLEXER	MX15A MULTIPLEXER
BLANK	BLANK	MX15B MULTIPLEXER
		BLANK

15-0124

Figure 2-6 Memory Multiplexer Maximum Configuration



# Chapter 3

## Predelivery Preparation

### 3.1 GENERAL

The size of the system to be installed is the prime consideration in determining the degree of planning and site preparation required. The following general schedule is suggested as a guide in site preparation and planning.

#### 3.1.1 Receipt of Installation Manual

The following course of action should be initiated upon receipt of the Installation Manual.

- a. Read the Installation Manual and consult with DEC regarding preinstallation planning.
- b. Determine the location of the installation and the system configuration. If applicable, make an installation lay-out diagram using the information in Table 2-5 and Figure 2-5 of Chapter 2. Figure 3-1 illustrates basic PDP-15 cabinet dimensions.
- c. Determine the placement of air-conditioning, lighting, power receptacles, etc.
- d. Check the size of doors, passageways, elevators, etc., that could create receiving and/or installation problems. If a problem is noted, DEC must be informed 1 month in advance of the shipping date. Special packing/shipping provisions can then be implemented.
- e. Determine the power requirements of the system. This information is provided in Section 3.3, System Power Requirements.
- f. Check the local delivery date for all power and air-conditioning equipment to ensure delivery and installation of these items prior to delivery of the PDP-15 System.

#### 3.1.2 Three Months Prior to Delivery

The installation layout should be agreed upon by the customer and DEC three months prior to the delivery date. All cables are specified and ordered at this time.

#### 3.1.3 One Month Prior to Delivery

The DEC Sales Engineer visits the installation site one month prior to the delivery date to determine the specific requirements for moving system components from the delivery van to the installation site. Any installation site restrictions and/or receiving area-to-installation site constraints should be noted and reported to the DEC Sales Engineer.

#### 3.1.4 One Week Prior to Delivery

Installation of air-conditioning equipment, electrical and power facilities, lighting, etc., should be completed one week prior to delivery.

### 3.2 CABLING

DEC cabinet interconnecting cables are of standard lengths and are factory installed. If the cabinets must be shipped separately because of shipping or receiving restrictions, the cabinet interconnecting cables are reconnected at the installation site. The termination point of each cable is identified.

Cables for a Type B or C plan as outlined in Chapter 1 are measured and ordered in accordance with the DEC-approved installation layout. The part number and required cable length is specified by the DEC Sales Engineer for each cable or group in the PDP-15 System.

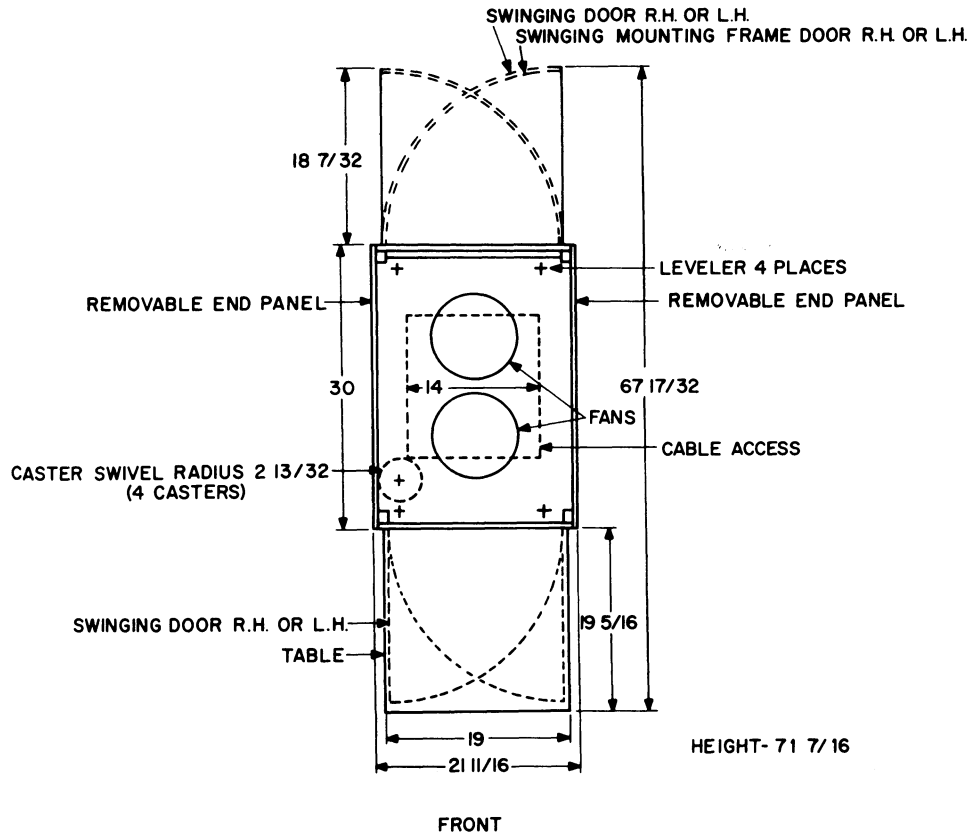

15-0033

Figure 3-1 Basic PDP-15 Cabinet

All cable lengths should be as short as possible, and under no circumstances should any of the maximum lengths be exceeded. External interconnecting cables should be protected from damage by installing a protective metal cover over the cables in a manner that will not present a safety hazard to operating personnel.

If additional equipment is added to the system after the PDP-15 has been installed, only the standard cables to connect the new equipment into the system are supplied. Configuration control is maintained by DEC; therefore, all additional equipment changes must be submitted to DEC for approval. This procedure facilitates cable layout and planning.

Cable change requests for any reason other than the above (such as installation floor plan lay-out changes) are considered by DEC on a special request basis only. Such cable changes can affect the delivery time of the PDP-15.

### 3.3 SYSTEM POWER REQUIREMENTS

Figures 3-2 and 3-3 show the total current requirements of the PDP-15 System. Tables 3-1 and 3-2 give the power and Btu/hr rating of each option and peripheral in the PDP-15 Systems. Additionally, Table 3-2 provides the current requirements for each free-standing peripheral. Table 3-3 provides the power requirements for the standard PDP-15 configurations.

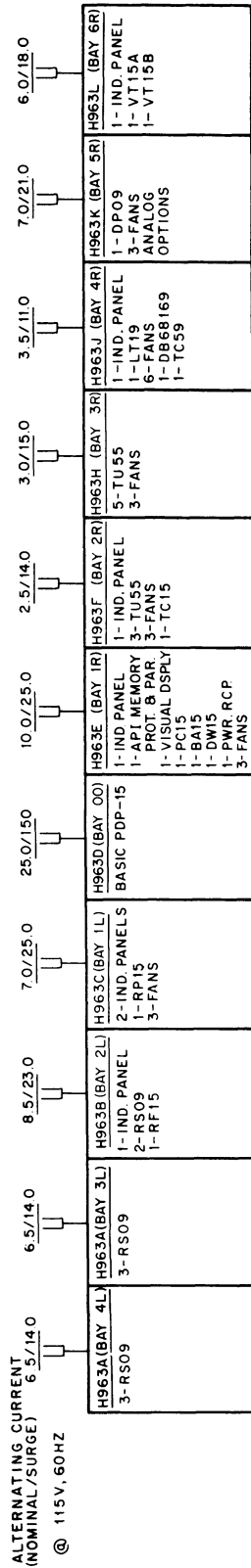

NOTE 1:  
VALUES ARE GIVEN AS A GUIDELINE FOR POWER ESTIMATION

Figure 3-2 System Configuration (Excluding Memory Multiplexer Cabinets)

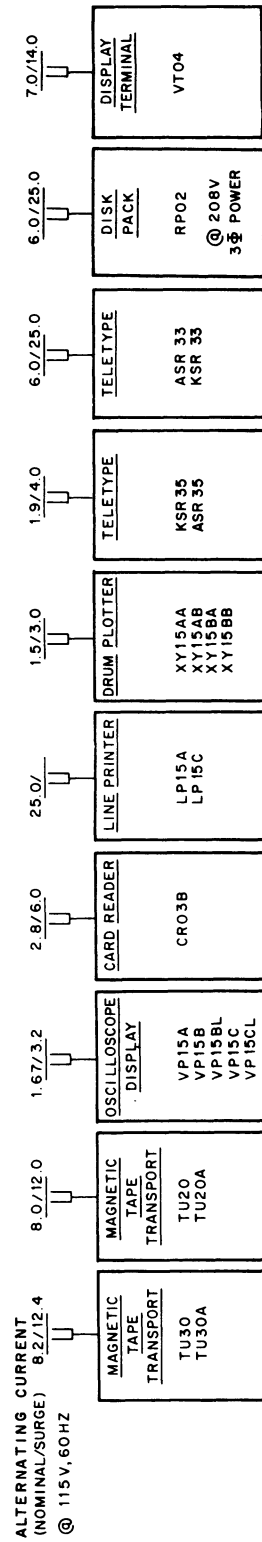

NOTE 1:  
THE NOMINAL/SURGE CURRENT RATINGS ARE PRELIMINARY SPECIFICATIONS

NOTE 2:  
VALUES ARE GIVEN AS A GUIDELINE FOR POWER ESTIMATION

Figure 3-3 Free-Standing Peripheral Device Configuration

CURRENT  
(NOMINAL/SURGE)  
@ 115 Vac, 60 Hz

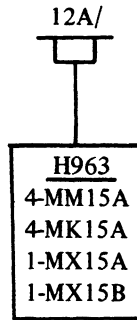

Figure 3-4 Memory Multiplexer Cabinet Power Requirements

The total current required by the PDP-15 installation can be determined by the following procedure:

- a. From the PDP-15 System Configuration Chart, Figure 3-2, determine the equipment and corresponding cabinet requirements of the particular system to be installed. Repeat this procedure for the free-standing peripheral devices (see Figure 3-3).
- b. Using Table 3-2, determine the current required by each free-standing peripheral device (see Figure 3-3).
- c. The total current required by the PDP-15 installation can now be determined by adding together

all currents associated with each cabinet and peripheral device. From this data, the type and quantity of ac connectors can be determined. Provide one ac connector for each cabinet and one ac connector for each free-standing peripheral.

Even though an installation may not use all the options in a particular cabinet, it is recommended that adequate ac power for the entire cabinet be provided.

Example:

An installation requiring bays 00, 1R, and 4R requires the following three ac outlets:

- (1) 25A (150A surge)\*
- (1) 10A (25A surge)\*
- (1) 3.5A (11A surge)\*

\*These amperages are applicable when using 115 Vac 60 Hz power.

**Table 3-1**  
**Power Estimations for PDP-15 Options**

Options	Current (Amperes at 115 Vac 60 Hz)	Heat Dissipation (Btu/hr)	Power Dissipation (W)
<b>BASIC PROCESSOR</b> (Including up to 32K of memory, KE15, KF15, and KW15)	25	9775	2875
<b>MEMORY EXPANSION</b>			
MM15-A 4K Memory Module that can be expanded to 8K with an MK15-A	8	3128	920
MK15-A 4K Expansion Kit that expands MM15-A to 8K	4	1564	460
MX15 Memory Multiplexer		85	25
MP15 Memory Parity for each 4K Words of Memory		54	16
KT15 Memory Location		64	19
KM15 Memory Protection		41	12
<b>INPUT/OUTPUT PROCESSOR</b>			
KA15 Automatic Priority Interrupt		71	21
DW15A Positive-to-Negative Bus Converter		112	33
<b>NOTE</b> Alternating-current figures are given for free-standing units only. To determine ac requirements for units mounted in cabinets, see Figure 3-2.			

**Table 3-2**  
**Power Estimations for PDP-15 Peripherals**

Peripheral	Current (115 Vac 60 Hz)		Heat Dissi- pation (Btu/hr)	Power Dissi- pation (W)
	Nominal (A)	Surge (A)		
<b>MASS STORAGE DEVICES</b>				
TC02D DECTape Control for up to eight TU55 DECTape Transport Units	0.5		198	58
TC15 DECTape Control for up to four TU56 Dual DECTape Transport Units	0.8		327	96
TU55 DECTape Transport			410	170
TU56 Dual DECTape Transport	3.0	9.0	1190	350

**Table 3-2 (Cont)**  
**Power Estimations for PDP-15 Peripherals**

Peripheral		Current (115 Vac 60 Hz)		Heat Dissi- pation (Btu/hr)	Power Dissi- pation (W)
		Nominal (A)	Surge (A)		
TC59D	Magnetic Tape Transport Control for up to eight TU20B, TU20A, TU30B, TU30A Magnetic Tape Transport Units			784	230
TU20B	7-Track, 45 ips Magnetic Tape Transport; 200,556, and 800 bpi	8.0	12.0	3128	920
TU20A	9-Track, 45 ips Magnetic Tape Transport; 800 bpi	8.0	12.4	3128	920
TU30B	7-Track, 75 ips Magnetic Tape Transport; 800 bpi	8.2	12.4	3196	943
TU30A	9-Track, 75 ips Magnetic Tape Transport; 800 bpi	8.2	12.0	3196	943
*RF15	DECdisk Control for up to eight RS09 DECDisk Drives				
**RS09	One DECDisk Drive	6.5	14.0	2543	748
	Two DECDisk Drives	8.0	23.0	3128	920
	Three DECDisk Drives	11.5		4498	1323
	Four DECDisk Drives	13.0		5083	1495
	Five DECDisk Drives	14.5		5671	1668
	Six DECDisk Drives	18.0		7038	2070
	Seven DECDisk Drives	19.5		7626	2243
	Eight DECDisk Drives	21.0		8211	2415
RP02	10.24 million-word Disk Pack Drive Unit Drive Unit Includes one RP02P Disk Pack	6.0 @ 208V	25.0	4250	1250
RP02P	Disk Pack	NA	NA	NA	NA
<b>DISPLAY DEVICES</b>					
VP15A	Storage Tube Display VT01 Storage Display Unit, Control, and Mounting Hardware	2.4		932	274
VP15B	Oscilloscope Display Tektronix RM503 X-Y Oscilloscope, Control, and Mounting Hardware	1.6		592	174
VP15BL	Oscilloscope Display Tektronix RM503 X-Y Oscilloscope, Control, Mounting Hardware, and DEC Type 370 Light Pen	1.6		598	176
*Alternating-current figures for the RF15 are included in the figures given for the RS09 DECDisk Drives. **For each RS09 started, an additional 7.5A is drawn for 20 seconds. Because the circuit breaker opens at 30A, no more than two RS09s can be started at the same time.					

**Table 3-2 (Cont)**  
**Power Estimations for PDP-15 Peripherals**

Peripheral		Current (115 Vac 60 Hz)		Heat Dissi- pation (Btu/hr)	Power Dissi- pation (W)
		Nominal (A)	Surge (A)		
VP15C	Oscilloscope Display VR12 X-Y Display Unit (7 in. x 9 in. CRT) Control, and Mounting Hardware	1.6		592	174
VP15CL	Oscilloscope Display VR12 X-Y Display Unit (7 in. x 9 in. CRT) Control, and Mounting Hardware and DEC Type 370 LP	1.6		598	176
VT04	Graphic Display Console	7.0	14.0	2737	805
VT15	Graphic Processor	6.0	18.0	2346	690
<b>CARD INPUT</b>					
CR03B	Card Reader – 200 cpm Reader and Control	2.8	6.0	1095	306
<b>HIGH SPEED PAPER TAPE</b>					
PC15	Paper Tape Section – 300 cps Reader, 50 cps Punch			1040	306
<b>LINE PRINTERS</b>					
LP15F	Line Printer – 300 ipm Line Printer and Control	20.0 <sup>†</sup>		1700 <sup>†</sup>	500 <sup>†</sup>
LP15C	Line Printer – 1000 ipm Line Printer and Control	25.0 <sup>†</sup>		10,200 <sup>†</sup>	3000 <sup>†</sup>
<b>CALCOMP PLOTTER AND CONTROL</b>					
12-in. Drum Plotter, Model 565, and Control					
XY15AA	0.01-in. Step – 18,000 steps/minute	1.5	3.0	595	175
XY15AB	0.005-in. Step – 18,000 steps/minute	1.5	3.0	626	184
31-in. Drum Plotter, Model 563, and Control					
XY15BA	0.01-in. Step – 12,000 steps/minute	1.5	3.0	626	184
XY15BB	0.005-in. Step – 18,000 steps/minute	1.5	3.0	626	184
<b>DATA COMMUNICATIONS</b>					
LT19A	Multi-Station Teletype Control (Expands to 5 LT19B Line Units)			47	14

<sup>†</sup>Preliminary

**Table 3-2 (Cont)**  
**Power Estimations for PDP-15 Peripherals**

Peripheral		Current (115 Vac 60 Hz)		Heat Dissi- pation (Btu/hr)	Power Dissi- pation (W)
		Nominal (A)	Surge (A)		
LT19B	Line Unit (One Required for Each Teletype to EIA Line Adapter)			51	15
LT19C	EIA Line Adapter (Per Line)				
LT15A	Single-Teletype Control				
33 KSR	Teletype Model 33 Keyboard Send-Receive Unit	1.7	4.0	680	200
33 ASR	Teletype Model 33 Automatic Send-Receive Unit with Paper-Tape Reader and Punch	1.8	4.0	680	200
35 KSR	Teletype Model 35 Keyboard Send-Receive Unit	1.7	4.0	680	200
35 ASR	Teletype Model 35 Automatic Send-Receive Unit with Paper-Tape Reader and Punch	1.9	4.0	680	200
DP09A	Data Communications System Compatible with EIA RS 232B Interface, Bell System Type 201 Dataphone			253	75
<b>SCANNER AND CONTROLLER</b>					
AF04B	IDVM/Scanner				
	200 Channels			1564	460
	400 Channels			1762	517
	600 Channels			1955	575
	800 Channels			2153	633
	1000 Channels			2346	690
AA15A	DAC Controller			95	28
AAC2	DAC Controller Extension				
<b>MULTIPLEXER</b>					
AF01B	ADC Multiplexer			198	58
AF02B	ADC/MPXR				
	128 Channels			292	86
	256 Channels			292	86
	512 Channels			391	115
	1024 Channels			588	173



**Table 3-2 (Cont)**  
**Power Estimations for PDP-15 Peripherals**

Peripheral	Current (115 Vac 60 Hz)		Heat Dissi- pation (Btu/hr)	Power Dissi- pation (W)
	Nominal (A)	Surge (A)		
AF03B    ADC/MPXR	64 Channels		588	173
	128 Channels		683	201
	256 Channels		979	288
	512 Channels		1955	575
	1024 Channels		3910	1150
AM02			2346	690
	128 Channels		130	38
	256 Channels		180	53
	512 Channels		360	106
	1024 Channels		720	212
AM03			2346	690
	128 Channels		130	38
	256 Channels		180	53
	512 Channels		360	106
	1024 Channels		720	212

**Table 3-3**  
**Standard PDP-15 System Power Requirements**

System	Current Per Cabinet (Nominal/Surge Amperes at 115 Vac, 60 Hz)				Current Total (Nominal/Surge)	Heat Dissi- pation (Btu/hr)	Power Dissi- pation (W)
	H963B	H963D	H963E	H963F			
PDP-15/10		25/150			25.0/150	9,775	2875
PDP-15/20		25/150	10/25	2.5/14.0	37.5/189	14,661	4312
PDP-15/30		25/150	10/25	2.5/14.0	37.5/189	14,661	4312
PDP-15/40	8.5/23	25/150	10/25	2.5/14.0	46.0/212	17,986	5290

### 3.4 SOURCE POWER REQUIREMENTS

The PDP-15 can be operated from a 100, 115, 200, 215, or 230V 50 Hz ac power source; or from a 120/240V 60 Hz ac power source. The primary ac operational voltages should be maintained as closely as possible to the nominal value.

Line voltage tolerance must be maintained within  $\pm 15$  percent of the nominal values, and the 50/60 Hz line frequency should not vary more than  $\pm 2$  Hz.

Primary power to the system should be provided on a line separate from lighting, air-conditioning, etc., so that computer operation will not be affected by voltage surges or fluctuations.

The PDP-15 cabinet grounding point should be connected to the building power transformer ground or the building ground point.

Any questions regarding power requirements and installation wiring should be directed to the DEC Regional Sales Engineer.

#### 3.4.1 Primary Power Receptacles

The installation site primary power line must terminate in Hubbell wall receptacles (or equivalent) to be compatible with the PDP-15 power line Hubbell connector. The Hubbell wall receptacle part numbers are shown in Table 3-5. Figure 3-5 shows the primary power wall receptacles and the points where the site primary power lines are terminated. One receptacle is required for each cabinet and one for each free-standing peripheral.

#### 3.4.2 Service Outlets

Duplex ac outlets should be provided to power test equipment when maintenance tasks are performed. The duplex outlet (see Figure 3-5) should be located near the PDP-15 and its related equipment and should be rated at 120 Vac  $\pm 15\%$ , 50/60 Hz, 15 or 20A. These outlets should be separately fused and switch-controlled and should be installed approximately 10 feet apart.

**Table 3-4**  
**Hubbell Wall Receptacle Part Numbers**

Line Voltage	Hubbell Receptacle Part Numbers
115 Vac, 60 Hz, 30A	Receptacle 3330-G (3330 may be used) Cap 3331-G (3331 may be used)
230 Vac, 50 Hz, 20A	Receptacle 7310-G (7310 may be used) Cap 3321-G (3321 may be used)

SERVICE OUTLET  
120V 60Hz  
SINGLE PHASE  
15 amp / U Gnd

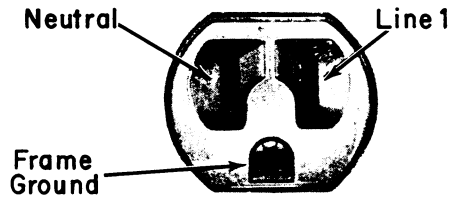

**CAUTION**

*WHEN NEUTRAL IS NOT AVAILABLE FOR THE ABOVE SERVICE, A RECEPTACLE OF THE ABOVE DESIGN SHALL BE USED, BUT BOTH PARALLEL SLOTS SHALL BE SHORT TO PREVENT POLARIZED PARALLEL BLADE PLUGS (CAPS) FROM FITTING.*

115V 60Hz  
SINGLE PHASE  
30 amp / Twist Lock

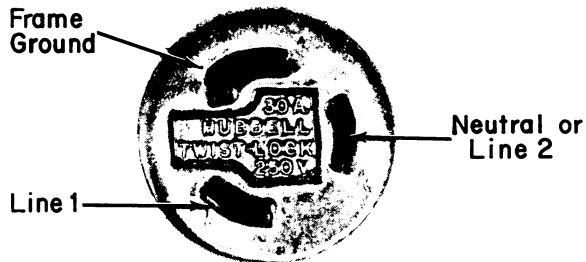

230V 50Hz  
SINGLE PHASE  
20amp / Twist Lock

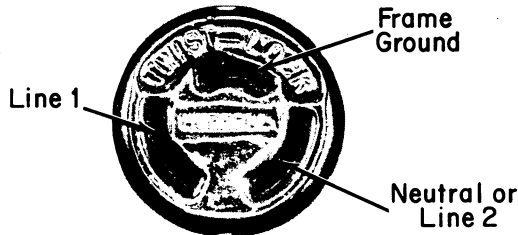

Figure 3-5 Hubbell Wall Receptacle Connector Diagram



# Chapter 4

## Installation, Inspection, And Checkout

### 4.1 UNPACKING

#### WARNING

Do not attempt to install the system until DEC has been notified and a Field Service Representative is present.

Unpack the equipment using the following procedures.

#### 4.1.1 PDP-15 System Cabinet Unpacking

Perform the steps listed below.

Step	Procedure
1	Remove the outer shipping container.
	<b>NOTE</b>
	The container may be either heavy corrugated cardboard or plywood. In either case remove all metal straps first, and then remove any fasteners and cleats securing the container to the skid. If applicable, remove the wood framing and supports from around the cabinet perimeter.
2	After removing the outer container, if applicable, remove the cardboard container containing the console table.
3	Remove the polyethylene cover from the cabinets.
4	Remove the tape or plastic shipping pins, as applicable, from the cabinet(s) rear access door(s).

Step	Procedure
5	Unbolt the cabinet(s) from the shipping skid. Access to the bolts, located on the lower supporting siderails, is facilitated by opening the access door(s). Remove the bolts.
6	Raise the leveling feet above the level of the roll-around casters.
7	Use wooden blocks and planks to form a ramp from the skid to the floor and carefully roll the cabinets onto the floor.
8	Roll the system to the proper location for installation.
9	If applicable, repeat Steps 1 through 8 for the remaining system cabinets.
10	When the cabinets are oriented properly, follow the procedure of Paragraph 4.3 to install the cabinet(s).

#### 4.1.2 Teletype Unpacking

##### 4.1.2.1 35 ASR and 35 KSR

Perform the steps listed below.

Step	Procedure
1	Use cutters to remove the dual steel straps.
2	Remove the fasteners securing the corrugated container to the shipping skid.

Step	Procedure
3	Lift off, or carefully cut open and remove, the outer corrugated container from the skid.
4	Remove the inner corrugated top and end pads.
5	Remove the Kimpak bags or the polyethylene cover as applicable.
6	Remove the tape from the plexiglas dome and the keyboard.
7	If applicable (35 ASR), carefully remove the tape securing the chad box to the unit's front panel.
8	Remove the four bolts securing the Teletype to the upper skid.
9	Dismount the Teletype from the skid.
10	Locate the teleprinter at the proper site and follow the procedure of Paragraph 4.5.2 to install the unit.

#### 4.1.2.2 33 ASR and 33 KSR

Perform the steps listed below.

Step	Procedure
1	Carefully cut open the top flaps of the carton and fold back the four flaps.
2	Remove the two corrugated edge protectors from each end of the box.
3	Remove the four corner support pieces.
4	Carefully lift out the cabinet assembly.
5	Lift out the cabinet assembly container.
6	Carefully lift out the Teletype unit and the accessory parts container.
7	Carefully remove the tape strips from the keyboard and plexiglas dome. These strips also secure the envelope containing the paper spindle and control knob.
8	If applicable (33 ASR), remove the tapes from the reader and punch mechanisms.

Step	Procedure
9	Follow the procedure in Paragraph 4.5.1 to install the Teletype.

#### 4.2 INSPECTION

After removing the equipment packing material, inspect the equipment. Report any damage to the local DEC sales office. Inspection procedures are as follows:

Step	Procedure
1	Inspect the external surfaces of the cabinets and related equipment for surface, bezel, switch, and light damage, etc.
2	Remove the shipping bolts from the rear door and open the rear door of the cabinet. Internally inspect the cabinet for console, processor, and interconnecting cable damage; loose mounting rails; loose or broken modules; blower or fan damage; loose nuts, bolts, screws, etc.
3	Inspect the wiring side of the logic panels for bent pins, cut wires, loose external components, and foreign material. Remedy any defects found.
4	Inspect the power supply for the proper seating of fuses and the proper seating of power-connecting plugs.

#### 4.3 CABINET INSTALLATION

The PDP-15 Cabinets are provided with roll-around casters and adjustable leveling feet. It is not necessary to bolt the cabinet to the mounting floor unless conditions indicate otherwise (e.g., shipboard installation). Cabinet installation procedures are as follows:

##### NOTE

**In multiple cabinet installations, receiving restrictions may necessitate shipping cabinets individually or in pairs. In such cases the cabinets are connected at the installation site.**

**Step****Procedure**

- 1 With the cabinets positioned in the room, install, if applicable, the filler strips between cabinet groups (filler strips are attached to the end of a cabinet group). Remove the 4 bolts securing the front and rear filler strips, butt the cabinet groups together while holding the filler strips in place, and rebolt through both cabinets and the filler strips (see Figure 4-1). Do not tighten the bolts securely at this time.

**Step****Procedure**

- 2 Lower the leveling feet, making sure that the cabinet(s) are not resting on the roll-around casters but are supported on the leveling feet.
- 3 Level all cabinets with a spirit level and ensure that all leveling feet are seated firmly on the floor.
- 4 Tighten the bolts that secure the cabinet groups together and then recheck the cabinet leveling. Again ensure that all leveling feet are seated firmly on the floor.

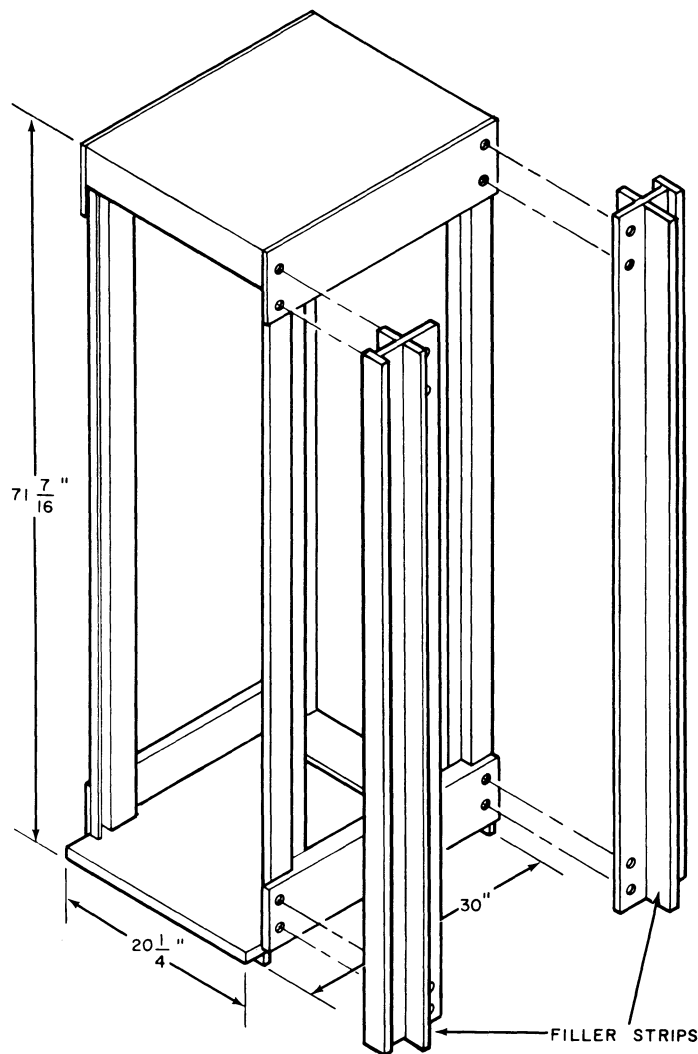

15-0088

Figure 4-1 Cabinet Bolting Diagram

Step	Procedure
5	Remove the shipping bolts and tape from the slide runners of the reader/punch assembly, if the reader/punch assembly is a part of the system.
6	Mount the table beneath the console. Using the hardware supplied, bolt the table supports to the front and rear rack supports within the cabinet.

#### 4.4 PERIPHERAL EQUIPMENT INSPECTION

All peripheral equipment should be inspected for internal and external damage. This includes inspection of magnetic tape and DECTape transport heads, motors, paper-tape sprockets, etc.

##### CAUTION

Do not operate any peripheral device that employs motors, tape heads, sprockets, etc., if they are damaged.

#### 4.5 TELETYPE INSTALLATION AND SETUP

The following procedures describe the sequence for preparing the Teletype(s) for power turn-on. Procedures for installing paper in the printer and in the reader/punch are included in the Operator's Guide, DEC-15-H2CA-D.

##### 4.5.1 33 ASR and 33 KSR

Perform the steps listed below.

Step	Procedure
1	After unpacking the Teletype, lift the cover and remove the wire that secures the carriage (see Figure 4-2).
2	Inspect the Teletype for external damage, loose screws, loose nuts, loose bolts, and loose code bars.
3	If the Teletype is to be mounted on a stand, run the cables down through the stand and out through the opening at the rear of the stand. Attach the cable clamp to secure the cables at the point where the cables exit from the stand. Secure the unit to the stand with the four bolts supplied.

Step	Procedure
4	Connect the Teletype's ac power cord to the ac receptacle located on the side of the PDP-15 main power supply. Run the cables under the cabinet containing the console and into the cabinet via the cable access hole in the base of the cabinet.
5	Connect the white nylon connector of the Teletype signal cable to the edge of the module in location K02.

##### 4.5.2 35 ASR and 35 KSR

Perform the steps listed below.

Step	Procedure
1	If applicable (35 ASR), remove the two bolts located under the front corners of the unit's cover.
2	Raise the cover and replace the two bolts (35 ASR) on the underside of the cover.
3	Remove the four shock-mount retaining bolts and the associated hardware (split washers and stand-offs beneath the carriage) that secure the teleprinter (see Figures 4-3 and 4-4).
4	If applicable (35 ASR), remove the two shock-mount retaining bolts and the associated hardware (split washers and stand-offs beneath the mechanism chassis) that secure the reader/punch mechanism (see Figure 4-4).
5	Reclose the cover.
6	Connect the ac power cable to either the ac receptacle located on the side of the power supply in the cabinet containing the console or to a convenient service outlet.
7	Connect the white nylon connector on the signal cable to the appropriate module within the cabinet.





CARRIAGE RETAINING WIRE

Figure 4-2 33 ASR and 33 KSR Carriage Retaining Wire Location

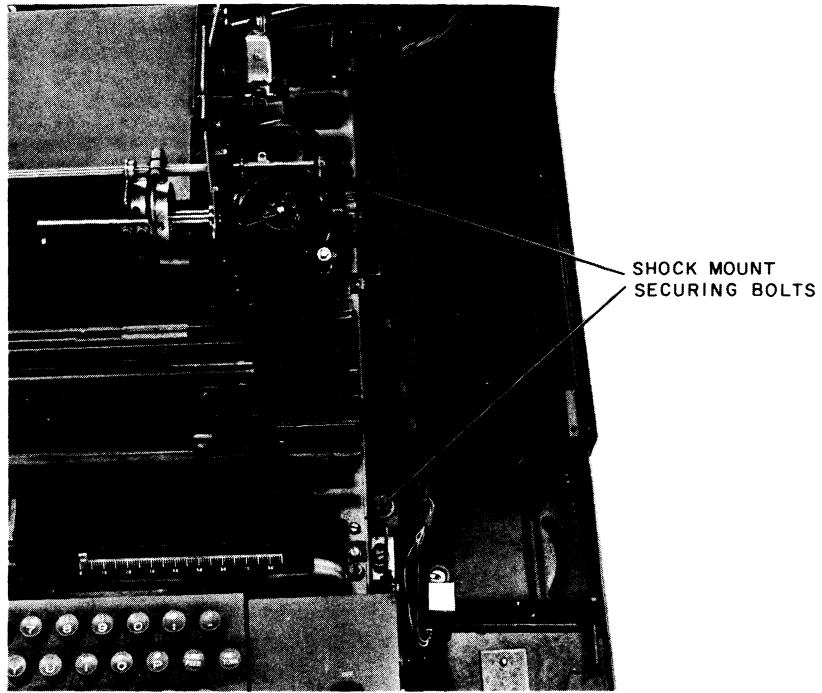

Figure 4-3 35 ASR and 35 KSR Right-Side Shock Mount Bolts

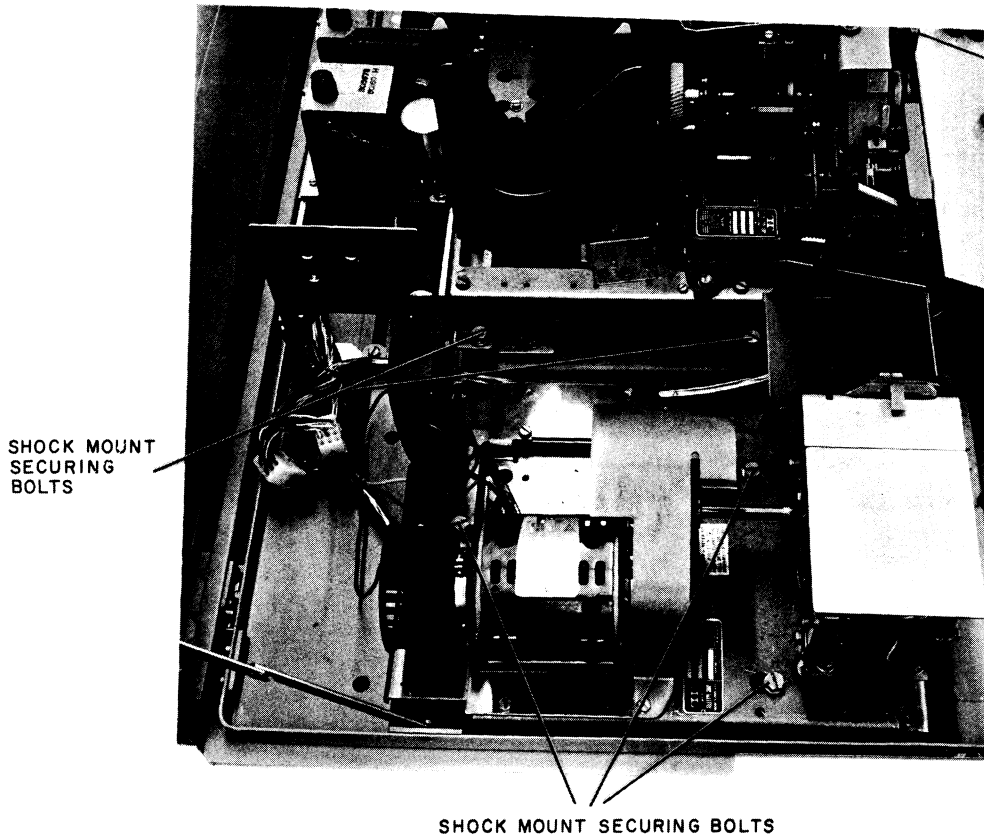

Figure 4-4 35 ASR and 35 KSR Left-Side Shock Mount Bolts

#### 4.6 COMPUTER-TELETYPE CABLE INSTALLATION

The Teletype is connected to the PDP-15 using the cable supplied as part of the Teletype unit. The cable is terminated with a white nylon connector. Run this cable into the cable access opening under the cabinet containing the console. Secure the nylon connector to the edge of the module located in slot K02 within the cabinet.

#### 4.7 PRIMARY AC POWER CABLES

Primary ac power cables are three-wire cables that interconnect the installation-site source power to the PDP-15 power supplies. The cables are connected at the factory to the PDP-15 power supplies for either 50 Hz or 60 Hz operation. All cabinets (excluding cabinets having disks and DECTapes mounted in them) have a self-contained power supply and an ac power cable.

Each wire in the power cable is color-coded (refer to Table 4-1). The power cable for the Model 715 power supply is connected to terminal strip TS3 (see Figure 4-5).

#### 4.8 TRANSFORMER CONNECTIONS

##### 4.8.1 General

The following information comprises a check for proper connection of the Model 715 power-supply transformer T1 and plug P15 before power is applied to the PDP-15. The main primary power source should be protected by 40A circuit breakers.

##### 4.8.2 Transformer T1 Connections

The T1 primary windings have been connected at the factory for either 50 or 60 Hz operation. However, before proceeding to the following sections, ensure that the jumpers are correctly connected to correspond to the installation site power-line voltage. T1 connection information is provided in Table 4-2 and Figure 4-5. The information is also provided on the rear cover of the main power supply. The T1 connectors are shown in Figures 4-6 and 4-7.

**Table 4-1**  
**Power Cable Line Identification**

Pigtail Information		Terminal Strip Nomenclature
Line	Wire Color	
Green	Frame Ground	Frame Ground
White	Neutral/Line 2	Neutral or Line 2
Black	Line 1	Line 1
<p><b>CAUTION</b></p> <p>a. The green wire is the cabinet frame ground and does not carry load current; however, the green wire must be connected for safety reasons. This wire must be securely connected from the PDP-15 cabinet to the grounding point on the primary power source.</p> <p>b. The white or light gray wire is the neutral lead (common, ac return, or cold lead) and must never be used for purposes of grounding the PDP-15 cabinet.</p>		

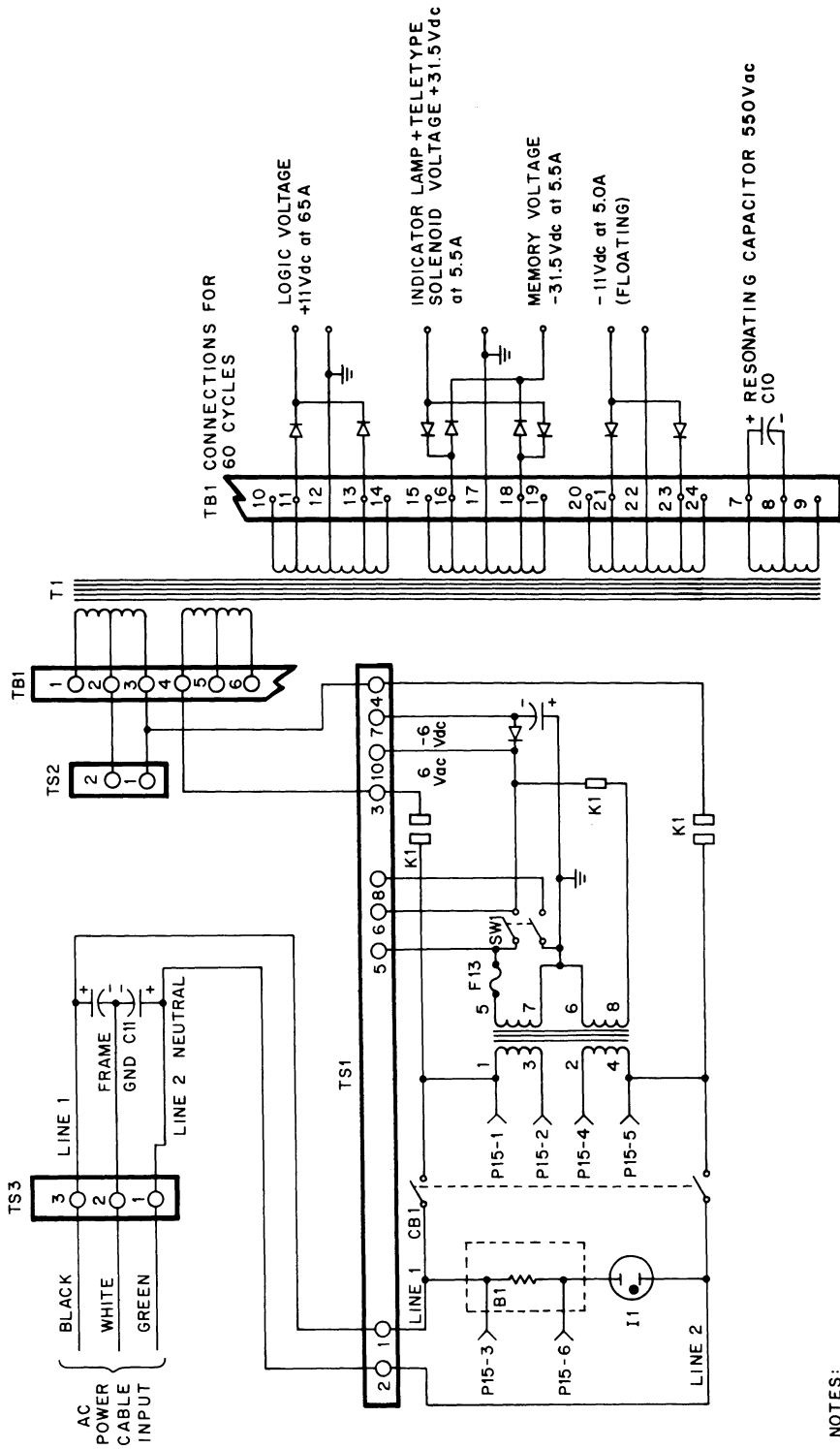

NOTES:  
 Jumper connections for TB1 and P15 are given in tables 4-2, and 4-3, respectively.  
 For detailed schematic see Engineering Drawing 715-0-1.

15-0127

Figure 4-5 Transformer Connections for Model 715 Power Supply

**Table 4-2**  
**Transformer T1 Primary and Secondary Terminal Connections**

Primary Terminal Connections			Secondary Terminal Connections		
Input Voltage	Jumpers	AC Lines Connections	Output Connections	Line Frequency	Power Supplied with Rating
100 Vac, 50 Hz	3-5, 4-2	3-4	10-12-14 (copper lugs)	50 Hz	+11.5 Vdc ± 13%, 65A*
115 Vac, 50 Hz	3-6, 4-1	3-4	11-12-13 (copper lugs)	60 Hz	+11.5 Vdc ± 13%, 65A*
200 Vac, 50 Hz	2-5	3-4	15-17-19	50 Hz	-31.5 Vdc ± 13%, 5.5A*
215 Vac, 50 Hz	2-6	3-4	16-17-18	60 Hz	-31.5 Vdc ± 13%, 5.5A*
230 Vac, 50 Hz	1-6	3-4	15-17-19	50 Hz	+31.5 Vdc ± 13%, 5.5A*
120 Vac, 60 Hz	3-5, 4-2	3-4	16-17-18	60 Hz	+31.5 Vdc ± 13%, 5.5A*
240 Vac, 60 Hz	2-5	3-4	20-22-24	50 Hz	-11.5 Vdc ± 13%, (floating) 5.0A*
115V, 6.0A Auto Tap 50 Hz 1-3 120V, 6.0A Auto Tap 60 Hz 2-3			21-22-23	60 Hz	-11.5 Vdc ± 13%, (floating) 5.0A*
			C Secondary	50 Hz	7-9 (RED) - 550 Vac
			C Secondary	60 Hz	7-8 (RED) - Resonating Capacitor
*These dc voltages should be maintained as closely as possible to their nominal value.					

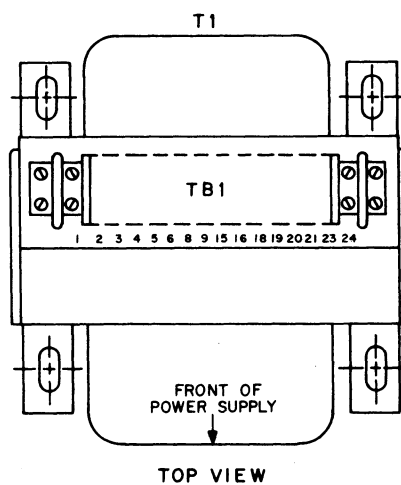

15-0035

Figure 4-6 Transformer Terminal Connector Diagram (Top View)

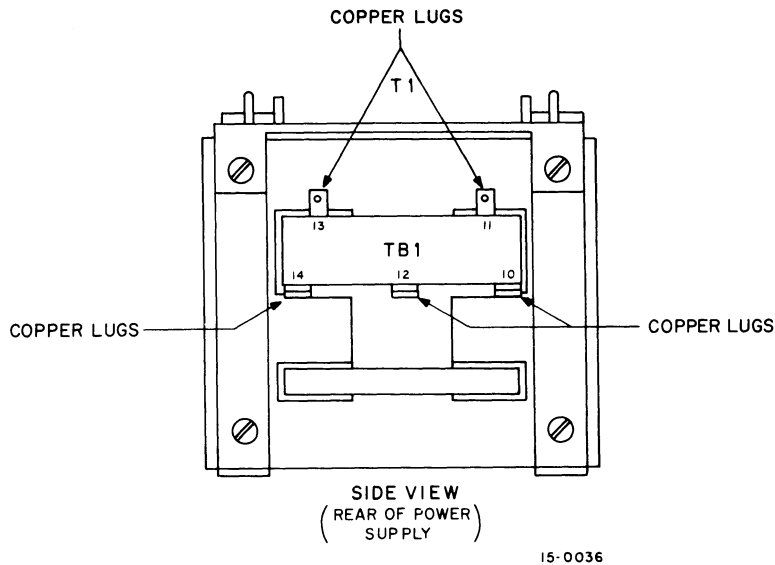

Figure 4-7 Transformer Terminal Connector Diagram (Side View)

### 4.8.3 Plug P15 Connections

Before applying power to the Model 715 Power Supply, ensure that the P15 connections are made in accordance with Table 4-3.

Table 4-3  
Plug P15 Connections

Input Voltage	P15 Connections
100 Vac	1-4, 2-5, 3-6
115 Vac	1-4, 2-5, 3-6
120 Vac	1-4, 2-5, 3-6
200 Vac	2-4
215 Vac	2-4
230 Vac	2-4
240 Vac	2-4

## 4.9 AC POWER CHECKOUT PROCEDURES

### WARNING

Under no circumstances should the customer apply power to the PDP-15 or its related equipment unless a DEC Field Service Engineer is in attendance during installation.

Before connecting the power cords of the PDP-15 and related equipment, perform the following check-out procedures.

- | Step | Procedure                                                                                                                                                                                                                                                                                                                                                                                                                  |
|------|----------------------------------------------------------------------------------------------------------------------------------------------------------------------------------------------------------------------------------------------------------------------------------------------------------------------------------------------------------------------------------------------------------------------------|
| 1    | Measure the source power ac voltage and ensure that the proper voltage is present.                                                                                                                                                                                                                                                                                                                                         |
| 2    | Measure the voltage potential between the ac return line and the frame ground line to ensure that no potential exists between earth ground (cold water pipe) and the computer ground.                                                                                                                                                                                                                                      |
| 3    | Refer to Table 4-2 and see Figures 4-5, 4-6, and 4-7. Check the Model 715 Power-Supply transformer T1 connections to be certain that T1 is connected for proper voltage and line frequency (this requires the removal of the screen covering the top of the power supply). Also check connector P15 (next to the toggle switch on the power supply) to ensure that this connector is wired correctly (refer to Table 4-3). |
| 4    | Set installation source power circuit breaker to the OFF position; then plug the PDP-15 primary power line cord into the wall outlet. The red light on the PDP-15 power supply should light indicating primary ac power is applied to the transformer.                                                                                                                                                                     |

Step	Procedure
5	Set the source power breaker to ON. The red light on the rear of the power supply should light indicating primary ac power is applied to the mainframe.

#### 4.10 SYSTEM POWER-UP ACTIVATION

Perform the following steps for system power-up activation.

Step	Procedure
1	Set the dc circuit breaker located on the front of the power supply to ON. Access to the breaker is obtained by opening the door under the console table.
2	Set the PDP-15 power supply ON-OFF circuit breaker on the back of the power supply to its ON position.
3	The PDP-15 power supply is switch-locked by a toggle switch. Unlock the ac power line by setting the switch to the up position to allow acti-

Step	Procedure
3 (cont)	vation of the system. Access to the switch, located on the left-hand side at the rear of the power supply, is obtained by opening the rear door of the cabinet.
4	Rotate the console power switch clockwise. Observe that the hour meter is operational. (Note the meter reading; note again 15 minutes later.) This meter is located on the rear of the power supply.
5	Ensure that the regulator lights in the memory/memories and CP-I/O are illuminated, indicating that dc power is supplied to each rack (see Figure 4-8). These lights may be observed by removing the covers from the logic racks located above the operator's console and opening the rear door, if applicable. To remove a cover, grasp the cover at each end and carefully pull forward.
6	For further acceptance information refer to Customer Acceptance, Appendix B. For detailed procedures refer to the Customer Acceptance procedure.

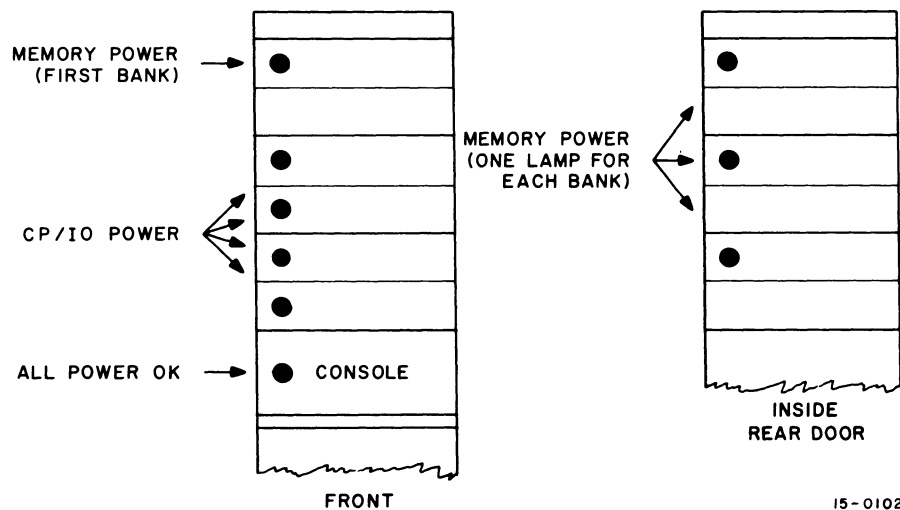

Figure 4-8 DC Power Lamp Locations





# Appendix A

## Maintenance And Service Options

Digital Equipment Corporation's Field Service Organization offers a wide range of services for DEC equipment users. Customers may choose from a broad selection of Service Contract Options and Per-Call Service or Depot Repair Maintenance plans to ensure optimum operating efficiency for their DEC equipment.

### A.1 SERVICE CONTRACTS

Service Contracts are tailored to the user's individual operation. In addition to providing all the necessary parts, labor, and test equipment required for remedial maintenance, Service Contracts also ensure system reliability by providing scheduled, systematic preventive maintenance. Planning and budgeting are greatly simplified because these contracts allow the user to fill his maintenance needs at a fixed, monthly charge.

#### A.1.1 Service Contract Options

On-Call Service Contract Coverage provides remedial maintenance when the customer notifies DEC of a system malfunction. Preventive maintenance is scheduled and performed during the period selected by the user. The principal period of coverage consists of eight consecutive hours of on-call coverage during the period 7 a.m. through 6 p.m., Monday through Friday. The user can extend his coverage from the principal period by selecting:

- a. 12 consecutive hours of on-call coverage
- b. 16 consecutive hours of on-call coverage
- c. 20 consecutive hours of on-call coverage
- d. 24 consecutive hours of on-call coverage

Coverage of 24 consecutive hours, Monday through Friday, begins on Monday of each week at 7 a.m. and terminates on Saturday of each week at 7 a.m.

The Saturday period of coverage consists of eight consecutive hours of on-call coverage during the period 7 a.m. through 6 p.m. The Sunday period of coverage consists of eight consecutive hours of on-call coverage during the period 7 a.m. through 6 p.m. As with the principal period of coverage, Saturday/Sunday coverage can be extended to 12, 16, 20, and 24 hours.

An on-site resident engineer plan can be implemented if the size, complexity, and/or critical nature of an installation require such a plan. The services of a resident engineer consist of 40 hours of coverage during the normal work week. In addition, all necessary spare parts, materials, and test equipment are physically stationed at the user's site to further ensure prompt and efficient remedial and preventive maintenance services. Monthly rates for contracted coverage are supplied on request.

There are no additional charges for travel in connection with service contracts except for remote installations. Remote installations are defined as installations located at a distance greater than 100 miles from a DEC Field Service Office.

#### A.1.2 Eligibility for Service Contract Coverage

A Pre-Service Contract Inspection is required for installations that were not under DEC's maintenance responsibility immediately prior to the requested commencement date of the service agreement. All charges associated with this inspection (including travel, labor, and parts) are billed to the user at the prevailing standard DEC rates. A minimum charge is associated with the Pre-Service Contract

Inspection. No inspection is required for service agreements that are scheduled to commence immediately after the expiration of a standard DEC Warranty or Service Contract.

## A.2 PER-CALL COVERAGE

Per-Call Coverage is designed to permit the users of DEC equipment to obtain service on a time and materials basis. Requests for Per-Call Coverage are considered after requests for Service Contract Coverage; thus, only users with their own service capabilities or users who are not critically tied to their equipment are encouraged to use this form of coverage. All charges for Per-Call Coverage are computed on a portal-to-portal basis. Commercial travel expenses related to the performance of services are billed as incurred. Material and parts consumption associated with Per-Call Coverage is charged to the user at the prevailing prices listed in the DEC Spare Parts Catalogue. Labor charges for Per-Call Service are on an hourly basis and are available on request.

A minimum charge for Per-Call Service applies to each service call; in addition, DEC neither implies nor guarantees the availability of Per-Call Coverage outside the hours of 7 a.m. through 6 p.m., Monday through Friday. Users in need of extended periods of coverage are encouraged to use the many Service Contract options available.

Users receive an invoice for all service rendered under Per-Call Coverage. It is the responsibility of the user to inform the DEC Field Service Office servicing the equipment of any special billing instructions related to the use of Per-Call Coverage. Such notification must be rendered before the commencement of any services on the part of DEC; in the absence of such notification, invoicing shall be accomplished in accordance with procedures determined by DEC. Installations requiring Purchase Orders for the authorization of work performed on a time and materials basis are encouraged to submit a blanket order for one year's duration to cover such services. There will be no additional charge for processing and administering such blanket orders. Terms for all services provided on a per-call basis are net 30 days. In addition to the charges outlined above, customers are also charged for all federal, state, municipal, or other government, excise, sales, use, occupational, or like taxes, now in force or enacted in the future, incurred as a result of the performance of per-call service. Installations enjoying tax exemption are requested to present their current exemption certificate number at the time that Per-Call Service is rendered or with the submission of the blanket Purchase Order.

## A.3 DEPOT REPAIR

Depot repair facilities have been strategically located throughout the world to enable users of DEC equipment to receive prompt, efficient service on many standard DEC options. Depots are also fully equipped to service and completely rebuild, if necessary, ASR and KSR Teletypes. Further, users of DEC equipment interested in purchasing rebuilt ASR and KSR Teletypes, or using their existing Teletypes on a trade-in basis toward the purchase of new machines, are urged to contact their nearest DEC Field Service Office for further information.

Depots are fully equipped and staffed with experienced personnel to offer rapid and economical repair services to the DEC customer. At the user's option, a national transportation firm, contracted by DEC, can be used to route equipment to and from the depot facility.

Charges for depot service, in addition to freight and insurance both ways, are computed per hour for labor, parts, and material consumed. There is no minimum charge for the use of the depot repair facility.

Customers wishing to use the depot facilities are requested to contact the nearest depot and furnish the following:

- a. Customer name
- b. Customer address
- c. Purchase Order number
- d. Billing address
- e. Name and telephone number of individual
- f. Type, Model Number, and Serial Number of equipment to be serviced
- g. Brief description of service problem or malfunction
- h. Mode of transportation to be used (DEC carrier or other)

Upon receiving the above information, the depot issues a return authorization number that enables the user to ship the equipment for servicing.

#### **A.4 FIELD INSTALLATION OF ADDITIONAL DEC OPTIONS**

Customers wishing to expand their existing systems by purchasing additional DEC options may elect to have the installation of the new equipment performed at a fixed rate to facilitate the budgeting and purchasing processes.

Field installation rates are available on request. To compute the installation charges for an option or group of options,

the total charge is equal to the sum of the option installation charges plus a one-time travel charge.

For the purpose of performing field installations, remote locations are defined as areas outside those areas normally serviced by DEC or its subsidiaries. Requests for installations in remote locations are considered on an individual basis. Field installations are performed from 7 a.m. to 6 p.m., Monday through Friday. A minimum charge is associated with a field installation.



## **Appendix B**

### **Customer Acceptance**

Customer acceptance of the PDP-15 consists of a demonstration of machine operation by running all diagnostics and an operating test of the system software. Some of the symbolic tapes provided with the software package are not used. These tapes are usually subroutines used in conjunction with main programs and are verified when produced.

#### **B.1 SPECIAL CUSTOMER REQUIREMENTS**

Any special customer acceptance requirements must be submitted to DEC at least 30 days prior to final acceptance. All customer acceptance requirements must be approved by the DEC PDP-15 Product Line Manager. Approved customer-specified acceptance requirements are listed on the construction requisition with proper reference to detailed documents.

#### **B.2 CUSTOMER PROGRAMS**

Acceptance tests are not contingent upon any customer programs unless these programs and their write-ups are supplied at least 30 days in advance of final acceptance, and are approved by the DEC PDP-15 Product Line Manager; this statement includes those programs and documents the customer deems "classified material". The programs must include ASCII and binary tapes, write-ups, and listings. These tapes are returned to the customer with the machine. In the event of difficulties, the customer must agree to send a capable representative to DEC in Maynard, Mass.

The DECUS library receives copies of all programs submitted and the librarian obtains written customer approval before publication.

#### **B.3 SPECIAL CUSTOMER ACCEPTANCE TESTING**

All special on-site acceptances must be listed on the construction requisition with reference to detailed documents

and will be exactly duplicated in-plant prior to shipment. Any special apparatus and test descriptions necessary for acceptance must be supplied, with full documentation, to DEC thirty days prior to customer acceptance. This documentation shall include: programs, listings, prints, block schematics, circuit schematics, manuals, and comprehensive operating and interfacing instructions. Any deviations must be waived by the DEC PDP-15 Product Line Manager and the DEC Field Service Manager or their assigned representatives.

#### **B.4 DIAGNOSTICS**

All diagnostics are operated in the order and for the time duration specified for the appropriate PDP-15/10, 20, 30 or 40 machine configuration. If a machine configuration is not standard (such as a 15/10 with the PC15 High-Speed Paper-Tape Reader/Punch), then the appropriate diagnostics for the option are supplied and these programs (in this case the high-speed reader test and the high-speed punch test program), are run for the amount of time indicated for either the PDP-15/10, 20, 30 or 40 System.

A diagnostic program tape and write-up are supplied with any standard or special option. A standard option is an option supplied by DEC but not included as a basic option of a PDP-15/10, 20, 30 or 40 System (e.g., a display or line printer). Special options are defined as hardware designed from customer specifications to fulfill a specific requirement or any standard option that is modified in any way. An installation procedure, acceptance procedure, and accessory check list are provided for such options. The installation procedure includes the interfacing of the option to the PDP-15.

The acceptance procedure outlines the programs to be run and the time duration for acceptance of the option. The accessory check list contains a list of all manuals, prints, programs, etc., that are normally supplied with the option.

Consult the appropriate diagnostic write-up for operating procedures and correct operation indications.

### **B.5 SYSTEM SOFTWARE ACCEPTANCE**

The system software acceptance is provided in the System Monitor Bulk Storage Acceptance document for the appropriate PDP-15/10, 20, 30 or 40 System. Each document is designed to demonstrate the operation of the system software for the particular configuration, to exercise the

machine to its fullest capabilities, and to use the various routines supplied in the software.

#### **NOTE**

**All programs have been previously checked and certified as being error free.**

Successful completion of Sections B.4 and B.5 shall constitute system acceptance. Discrepancies must be listed as "exceptions" on the Customer Acceptance Form.

## Appendix C

### Forms And Checklists

A large envelope, enclosed with the PDP-15 Accessory Kit, contains the following items:

- a.* Customer Acceptance Forms
- b.* Key Sheet
- c.* Customer Data Forms
- d.* Software Trouble Reports
- e.* DECUS information
- f.* Basic Accessory Checklists
- g.* Optional Equipment Checklists
- h.* Software Checklists
- i.* Final Distribution Lists

Each of the items listed is discussed in the following paragraphs. The sole intent of this information is to produce uniformity in customer acceptance procedures.

#### C.1 CUSTOMER ACCEPTANCE FORMS

The Customer Acceptance Forms are logged at DEC in Maynard, Massachusetts, prior to equipment acceptance. The form lists the equipment items that are included in the shipment. The customer name, the DEC installation code, the DEC order number, and the customer purchase orders are also included on the form. Personnel installing the equipment must check the keyed equipment serial numbers listing against the serial number on the equipment and enter the serial numbers in the appropriate column on the Customer Acceptance Form. All serial numbers, including those on vendor supplied material, are verified in this manner.

All future PDP-15 System additions, modifications, and inquiries are solely dependent on the accuracy of the Key Sheet, which lists all system components by model and serial number, and the Acceptance Forms. Upon successful completion of acceptance testing, any "exceptions" are listed in the appropriate section on the Customer Acceptance Form. The "exceptions" should include missing manuals or prints and any hardware, etc., that was not acceptable.

#### C.2 CUSTOMER DATA FORMS

The Customer Data Form is used to establish an accurate mailing list and customer contact file. The form should be completely filled out and the appropriate copy returned to DEC's Field Service Organization in Maynard, Massachusetts.

#### C.3 SOFTWARE TROUBLE REPORTS

Software Trouble Reports enable the customer to communicate directly with the DEC Software Group. Any software problems should be described in detail and, if possible, examples attached.

#### C.4 DECUS INFORMATION

The DECUS information and introductory letter familiarizes the user with the Digital Equipment Computer Users Society. The letter invites membership and includes application forms.

#### C.5 BASIC ACCESSORY CHECKLIST

The Basic Accessory Checklist contains an accurate list of all items that are normally supplied with the basic

PDP-15. DEC personnel check each item on this list with the customer, and the customer then signs the complete form. The appropriate copy is then returned to DEC in Maynard, Massachusetts. The remaining copies should be distributed as indicated on the bottom of the form. Specified items that are not included should be listed as "exceptions" on the Customer Acceptance Forms.

#### **C.6 OPTIONAL EQUIPMENT CHECKLIST**

Accessory checklists for each option are supplied. The Basic Accessory Checklist procedures apply.

#### **C.7 SOFTWARE CHECKLIST**

The Software Checklist enclosed has been checked at the factory and is rechecked with the customer. Any items missing should be listed as "exceptions". This form is also signed by the customer and returned to DEC in Maynard, Massachusetts. Requests for additional copies of programs should be submitted to the DEC Program Library.

#### **C.8 FINAL DISTRIBUTION OF FORMS**

The return-addressed envelope is sent to DEC in Maynard, Massachusetts with the following completed forms:

- a. Customer Acceptance Forms
- b. Customer Data Forms
- c. Basic Accessory List
- d. Optional Equipment Checklist
- e. Software Checklist
- f. Installation Report
- g. Final Distribution Lists

All of the items above, except *b* and *f*, require the customer's signature. Only items listed as "exceptions" are replaced at no cost. All other items must be substantiated by a Customer Purchase Order.

A complete set of prints is supplied with the PDP-15 System. The Key Sheet should be used to reference the Master Drawing List (MDL) for each subsection (I/O, CP, MEMORY) or option (EAE, TC02) in the PDP-15 System. Wire lists, parts lists, and mechanical assembly prints are not supplied with any print set. These may be obtained only by special order.



H963A (BAY 4L)	H963A (BAY 3L)	H963B (BAY 2L)	H963C (BAY 1L)	H963D (BAY 00)	H963E (BAY 1R)	H963F (BAY 2R)	H963H (BAY 3R)	H963J (BAY 4R)	H963K (BAY 5R)	H963L (BAY 6R)						
FAN	FAN	FAN	FAN	FAN	FAN	FAN	FAN	FAN	FAN	FAN						
RS09 DECDISK	RS09 DECDISK	INDICATOR	INDICATOR	MM15A, MK15A 8K MEMORY (See Note 1)	INDICATOR	TU55 DECTAPE TRANSPORT (See Note 2)	TU 55 DECTAPE TRANSPORT (See Note 2)	DP 09 DATA COMMUNICATION CHANNEL	AF01B ANALOG - DIGITAL CONVERTER AND MULTIPLEXER OR ADC1/9 ANALOG - DIGITAL CONVERTER	INDICATOR						
BLANK	BLANK	RF15 DECDISK CONTROL	INDICATOR		BLANK	TU 55 DECTAPE TRANSPORT (See Note 2)	TU 55 DECTAPE TRANSPORT (See Note 2)	CRO3B CARD READER AND CONTROL		AM09 MULTIPLEXER CONTR.	INDICATOR					
RS09 DECDISK	RS09 DECDISK	RS09 DECDISK	RP15 DISKPACK CONTROL	KP15 CENTRAL PROCESSOR AND I/O PROCESSOR, KE15 EXTENDED ARITHMETIC ELEMENT, KW15 REAL TIME CLOCK, AND KF15 POWER FAIL	KA15 AUTOMATIC PRIORITY INTERRUPT, KM15 MEM. PROTECT, KT15 MEM. RELOC. & MPI5 MEMORY PARITY	TU 55 DECTAPE TRANSPORT (See Note 2)	TU 55 DECTAPE TRANSPORT (See Note 2)	DB09 INTER-PROCESSOR BUFFER	AM02A, AM02B, AM03A, OR AM03B ANALOG-DIGITAL CONVERTER	VT15A GRAPHIC PROCESSOR						
BLANK	BLANK	BLANK			VP15A, VP15B, OR VP15C, DISPLAY (See Note 2)	TU 55 DECTAPE TRANSPORT (See Note 2)	TU 55 DECTAPE TRANSPORT (See Note 2)				LT19 MULTI-STATION TELETYPE CONTROL					
RS09 DECDISK	RS09 DECDISK	RS09 DECDISK	BLANK	KC15 CONSOLE	PC15 HIGH SPEED PAPER TAPE READER/PUNCH	TU 55 DECTAPE TRANSPORT (See Note 2)	TU 55 DECTAPE TRANSPORT (See Note 2)	TC 59 MAGNETIC TAPE CONTROL	AGO1 OR AGO2 ANALOG-DIGITAL CONVERTER	FANS						
AIR DISTRIBUTION SYSTEM AND POWER SUPPLIES	AIR DISTRIBUTION SYSTEM AND POWER SUPPLIES	AIR DISTRIBUTION SYSTEM AND POWER SUPPLIES		TABLE	BLANK	TC02D DECTAPE TRANSPORT CONTROL (See Note 2)	BLANK		BLANK	TC 59 MAGNETIC TAPE CONTROL	AA15 DIGITAL-ANALOG CONVERTER	VT15B GRAPHIC PROCESSOR				
			715 POWER SUPPLY	FANS	BAI5 (CONTROL FOR LT15A, PC15, AND VP15)			DW15A CONVERTER			AC UTILITY OUTLETS		BLANK	BLANK	BLANK	
				BLANK												AA15 DIGITAL-ANALOG CONVERTER
				BLANK												
BLANK	BLANK	BLANK	BLANK	BLANK	BLANK	BLANK	BLANK	BLANK	BLANK							

**NOTES**

1. Three more 8K memory modules can be mounted on the rear door of cabinet H963D.
2. On some PDP-15 systems the eight TU55 DECTape Transports have been replaced by four TU56 Dual DECTape Transports, the TC02D DECTape has been replaced by a TC15 DECTape Control, and cabinet H963H and the DW15A I/O Bus Converter in cabinet H963E have been eliminated. TU55, TU56, and TC15 are 10 1/2 inches high; TC02D is 15 3/4 inches high.

15-0126

Figure 2-5 PDP-15 Maximum Configuration  
(Excluding Memory Multiplexer Cabinets  
and Free-Standing Peripherals)



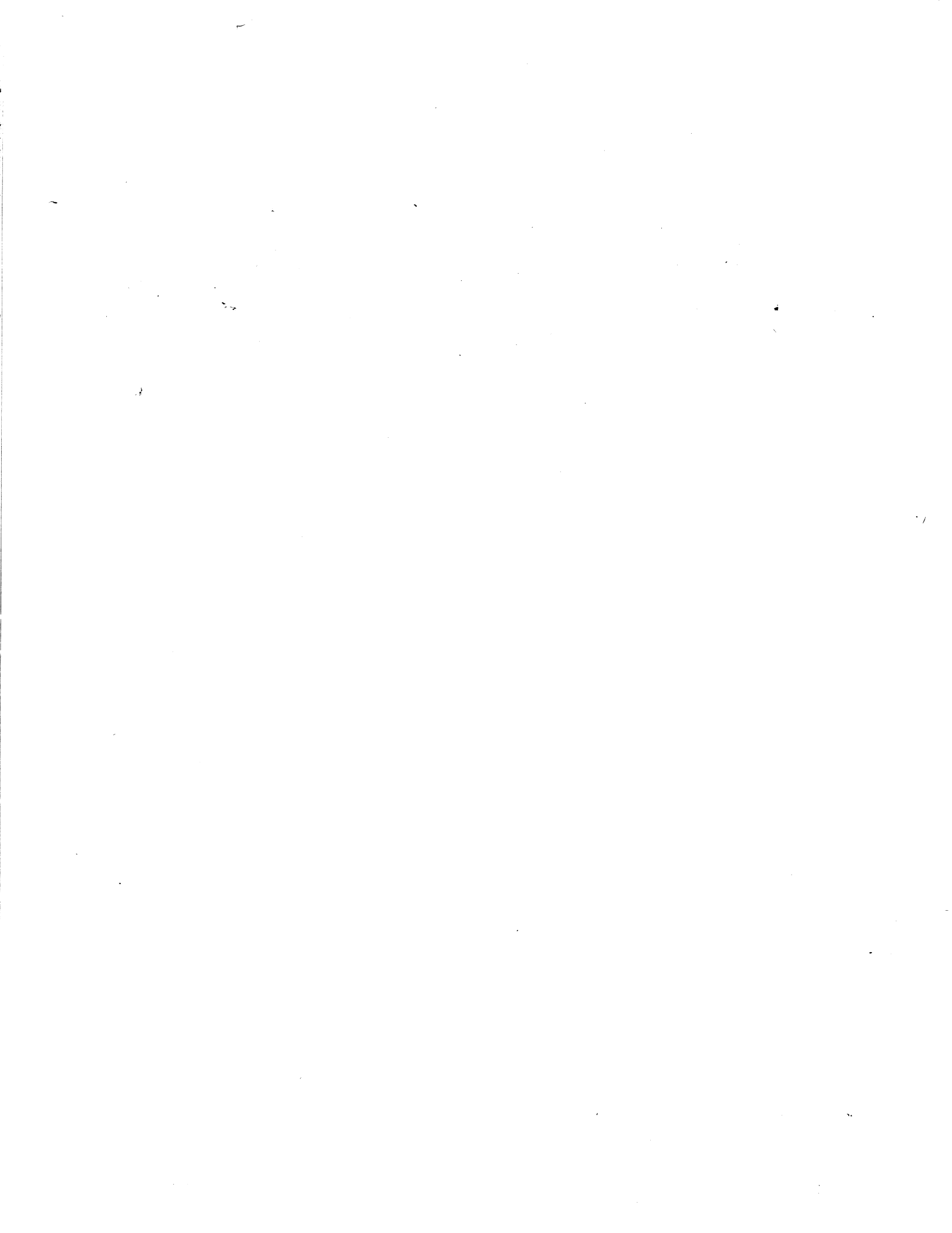

**Digital Equipment Corporation  
Maynard, Massachusetts**

**digital**