

RD52-A

5.25 INCH WINCHESTER DRIVE

REPAIR MANUAL

ABSTRACT: This manual describes the repair procedure for the RD52-A 5.25 inch Winchester drive. The manual is intended for use by personnel at incoming inspection and the appropriate repair facility.

The drawings and specifications contained herein are the property of Digital Equipment Corporation and shall not be reproduced or copied or used in whole or in part as the basis for the manufacture or sale of items without written permission.

This is an unpublished work protected under U.S. Copyright Laws. Copyright (c) Digital Equipment Corporation, 1986, 1988, 1989, 1990. All rights Reserved.

SIGN-OFF:

RESPONSIBLE ENG Cal Tingly DATE 3/20/86
PROCESS ENG'G Bradley G. Blaine DATE 3/20/86
QUALITY ENG Leon G. Fink DATE 3/20/86
P.T.E. SUPERVISOR George E. Sherman DATE 3/20/86

DATE	ICO #	ORIGINATOR	APPROVED	REV
7/5/84	First Issue	Kai Figwer	George Sherman	A
1/31/85	W0001	-----	George Sherman	B
3/13/86	W0002	Guy Piche	Robert Hamel	C
9/26/88	DAS001	Joe Pardo	Leo Roy	D
4/10/89	DAS002	Joe Pardo	John Breen	E
8/21/90	DAS003	Lee Timmons	Rob Richards	F
10/3/90	DAS004	<i>Lee Timmons</i>	<i>George Sherman</i>	H

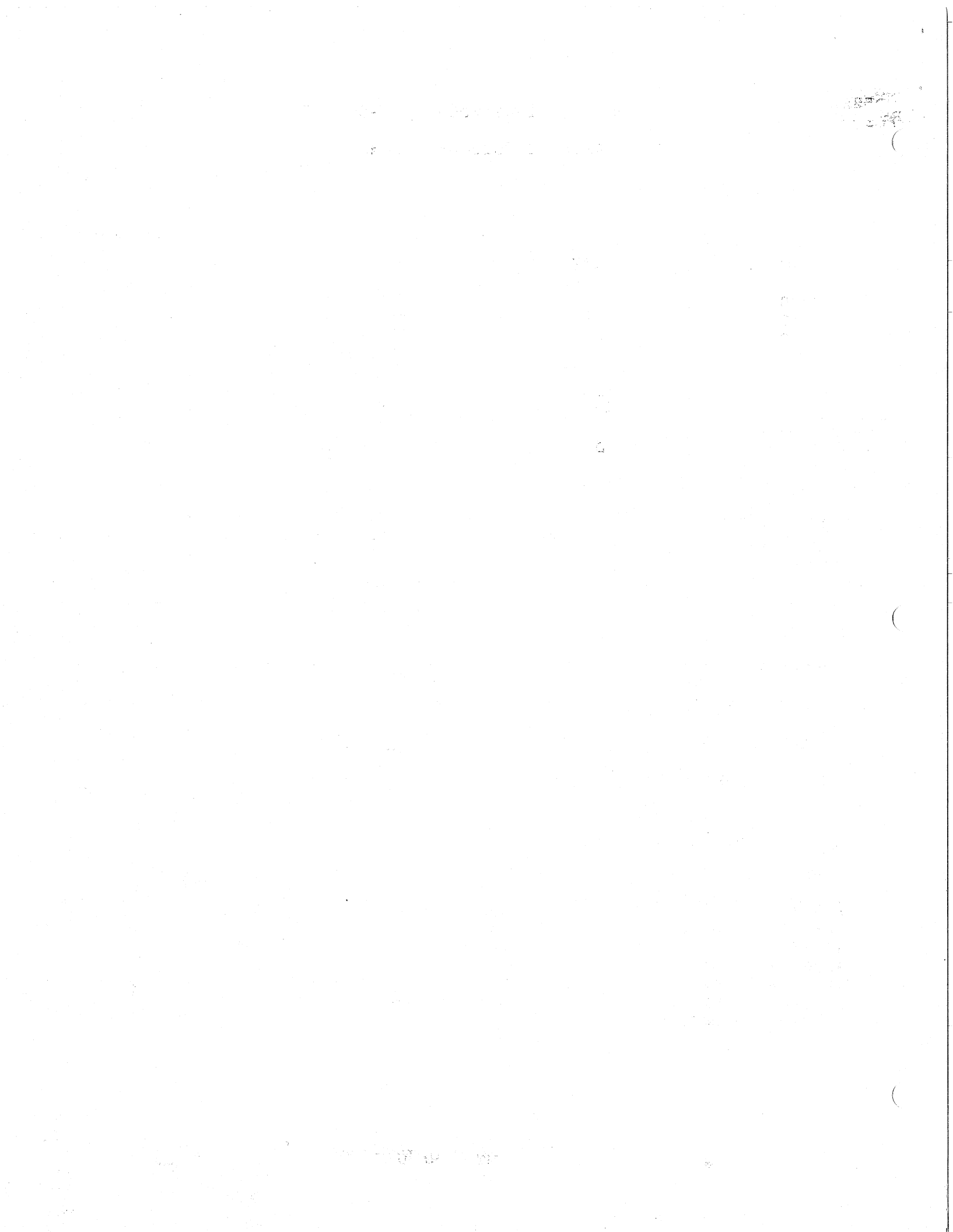

List of Current Pages

<u>Section</u>	<u>Rev</u>	<u>Date</u>
0	H	10/3/90
1	D	8/21/90
2	D	8/21/90
3	D	8/21/90
4	E	10/3/90
5	D	8/21/90
6	F	8/21/90
7	D	8/21/90
8	D	8/21/90

1000
1000
1000
1000
1000

1000
1000
1000

1000
1000
1000
1000
1000
1000
1000

<u>SECTION</u>	<u>PAGE</u>
6.0 REPAIR PROCEDURE	6-1
6.1 Incoming Inspection	6-3
6.2 Unit Hook Up	6-3
6.3 Tester Set Up	6-7
6.4 Unit Set Up	6-16
6.5 Dedicated Testing	6-19
6.6 Troubleshooting	6-21
6.7 Removal and Replacement	6-26
6.8 FCT Check	6-29
6.9 Final Inspection	6-31
6.10 DEC STD 101 Envelope	6-31
6.11 Packaging	6-31
7.0 APPENDICES	7-1
7.1 ECO's/FCO's	7-1
7.2 Decentralization Requirements	7-2
7.3 Torque Specifications	7-2
8.0 COMMENTS AND FEEDBACK	8-1
8.1 Literature Comment Form	8-1
8.2 ECO Recommendation Form	8-2
8.3 Technical Contact Form	8-3

<u>FIGURE</u>	<u>DESCRIPTION</u>	<u>PAGE</u>
1.1	RD52-A Winchester Disk Drive	1-4
6.1	Repair Process Flowchart	6-2
6.2	RD52-A Power and Interface Connections	6-5
6.3	Device PCB drive select jumper location	6-6
6.4	Troubleshooting Flowchart	6-22
6.5	Bezel screws and 2-pin connector removal	6-26
6.6	Front Bezel removal	6-27
6.7	Device PCB screws removal	6-27
6.8	Device PCB removal	6-28

TO THE USERS OF THIS MANUAL

The purpose of this repair manual is to describe the materials and procedures for repairing the RD52-A 5.25 inch Winchester drives. The intended users of the manual are the technicians, assemblers, and supervisors who will be either personally repairing the unit or supervising the repair. The paragraphs that follow describe what we hope to be the relationship between the designers of the manual, FSL Mechanical Engineering, and its users.

In designing this repair process, we have attempted to consider all possible details. We have tried to provide or define all tools and materials you will need for the repair. We have also tried to present a workable, "real life" picture of the steps of the repair process.

We are aware, however, that no process can be designed completely "bug free". There will always be a better way, a simpler way, or a faster way to do things. We are also aware that you, in your daily work, are in a unique position to see problems and help to find ways to improve the process. We strongly encourage and appreciate this.

Three forms have been provided in Section 8.0 so that you can feed information back to us. One is a general Literature Comment Form. Please use this form to tell us of your general impression of the manual, of any sections in the manual you feel need improvement, of information that you feel is missing, etc.

The second form is an ECO Recommendation Form. This is the form to use when you see a problem in the repair process itself. This might be anything from a change in the order of the repair steps, to a suggestion for a new custom-made tool, to a better way to stage parts waiting for repair.

The third form is to establish a Technical Contact with the appropriate Development Engineer to confer about problems that need more definition.

Feel very free to submit either of these forms at any time. We need and appreciate your help in ironing the bugs out of the repair process. Thank you!

FSL Mechanical Engineering Group

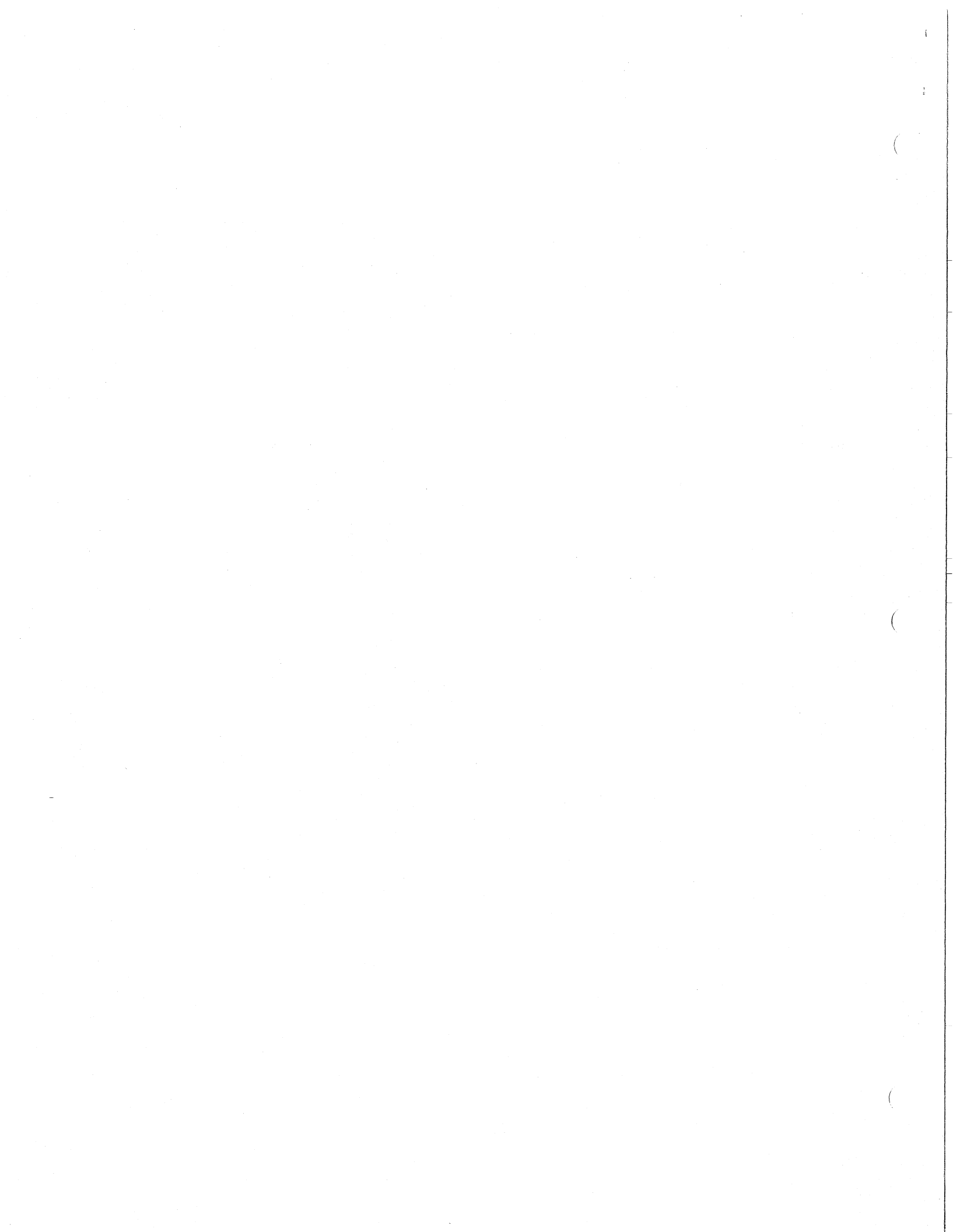

1.0 OVERVIEW

This section contains a general description of the RD52-A Winchester Disk Drive used in the PC100 family, Pro 350/380, Micro-11, and MicroVAX systems. Important cautions and documents which pertain to this repair process are also included in this section.

1.1 GENERAL DESCRIPTION

The RD52-A Winchester Disk Drive, is a random access storage device. The storage media consists of four 5-1/4 inch diameter hard discs. Eight movable Read/Write heads are used to service 512 data cylinders. The total formatted capacity of the drive is 33.55 megabytes. Refer to figure 1-1.

This repair manual provides a procedure for isolating a fault in the RD52-A Winchester Drive to the Field Replaceable Unit (FRU) by utilizing the Wilson Winchester Disk Analyzer. It then gives a removal and replacement procedure for each FRU.

The Wilson Winchester Disk Analyzer is used to perform a series of standard off-line exerciser/test functions. It produces a hard copy when interfaced with a standard line printer. The Wilson Tester features the Z80 CPU Module which provides control of the analyzer, and the 8X305 bipolar microprocessor for I/O processing.

1.2 CAUTIONS

To insure the safety of the operator and the proper care of the equipment, the following cautions must be observed during the repair process:



1.0 OVERVIEW

This section contains a general description of the RD52-A Winchester Disk Drive used in the PC100 family, Pro 350/380, Micro-11, and MicroVAX systems. Important cautions and documents which pertain to this repair process are also included in this section.

1.1 GENERAL DESCRIPTION

The RD52-A Winchester Disk Drive, is a random access storage device. The storage media consists of four 5-1/4 inch diameter hard discs. Eight movable Read/Write heads are used to service 512 data cylinders. The total formatted capacity of the drive is 33.55 megabytes. Refer to figure 1-1.

This repair manual provides a procedure for isolating a fault in the RD52-A Winchester Drive to the Field Replaceable Unit (FRU) by utilizing the Wilson Winchester Disk Analyzer. It then gives a removal and replacement procedure for each FRU.

The Wilson Winchester Disk Analyzer is used to perform a series of standard off-line exerciser/test functions. It produces a hard copy when interfaced with a standard line printer. The Wilson Tester features the Z80 CPU Module which provides control of the analyzer, and the 8X305 bipolar microprocessor for I/O processing.

1.2 CAUTIONS

To insure the safety of the operator and the proper care of the equipment, the following cautions must be observed during the repair process:

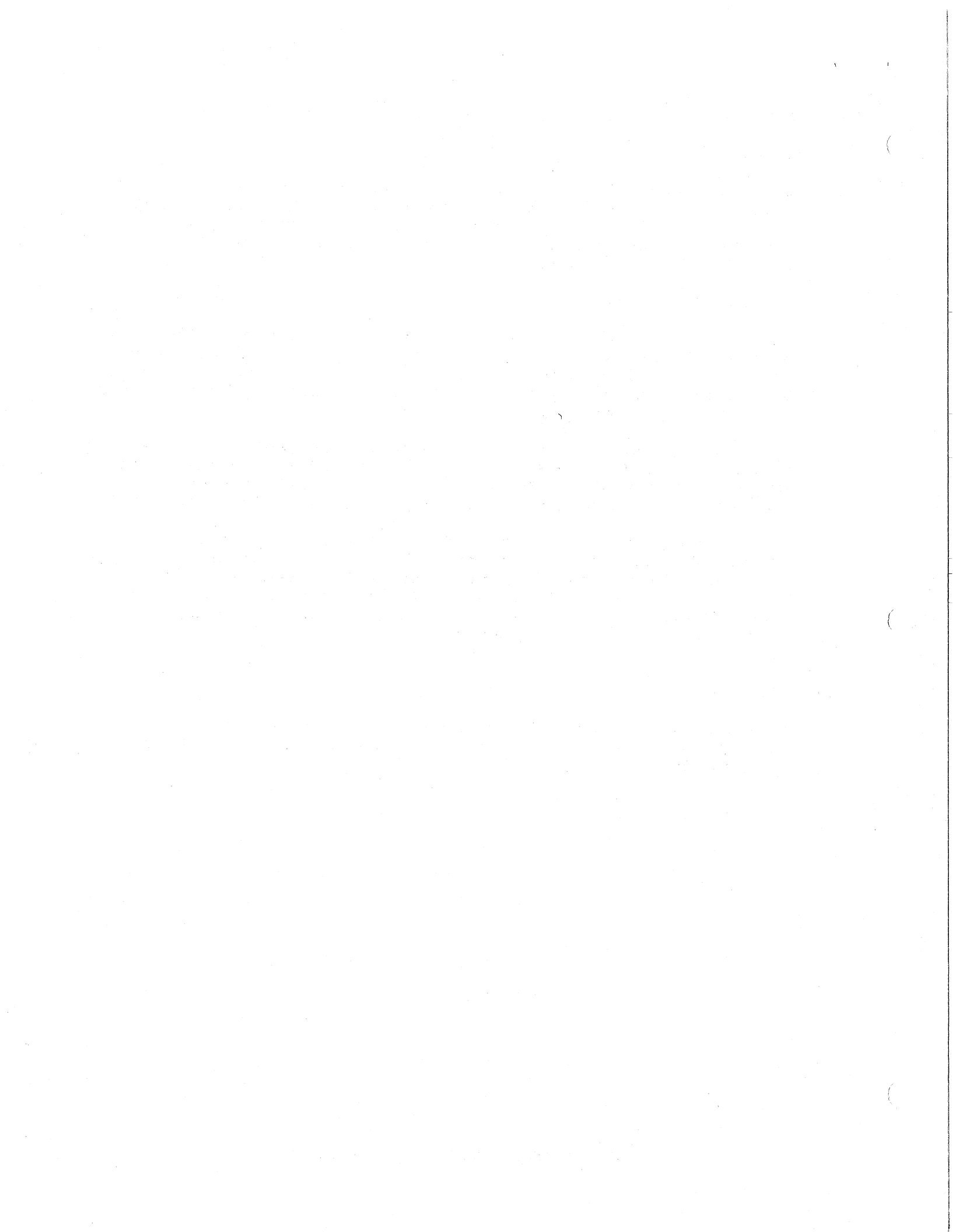

*
* **C A U T I O N** *
*
* After unpacking, the RD52-A is exposed to potential *
* handling and **ESD** hazards. What might otherwise appear *
* to be normal handling of the equipment is very *
* likely to result in permanent damage to this unit. *
*
* To guard against such damage, it is required that *
* the RD52-A be received, stored, and transported in *
* approved packaging only. Handling of the unit *
* outside of the protective package must be kept to *
* just that which is necessary. Care must be *
* exercised by the inspector to eliminate or *
* minimize impact loading of any kind to the Head/Disk *
* Assembly (HDA) while observing static discharge *
* precautions. It is recommended that a foam cushion *
* be provided on the inspection bench for this purpose. *
*
* **A DROP OF AS LITTLE AS 3 INCHES TO A HARD SURFACE WILL** *
* **DAMAGE THIS UNIT, POTENTIALLY BEYOND REPAIR.** *
*
* **DO NOT TOUCH THE EDGE CONNECTOR PINS OR BOARD** *
* **COMPONENTS WITHOUT OBSERVING STATIC DISCHARGE** *
* **PRECAUTIONS.** *
*

1.3 RELATED DOCUMENTS

Information in the documents listed below will prove useful to the repair process.

1.3.1 DIGITAL DOCUMENTS

<u>Document</u>	<u>Description</u>
DEC STD 116	Workmanship
DEC STD 031	Option Serialization and Identification
DEC STD 060	Digital Policy Requiring Hardware Products to be Certified and Designed to National and International Regulations.

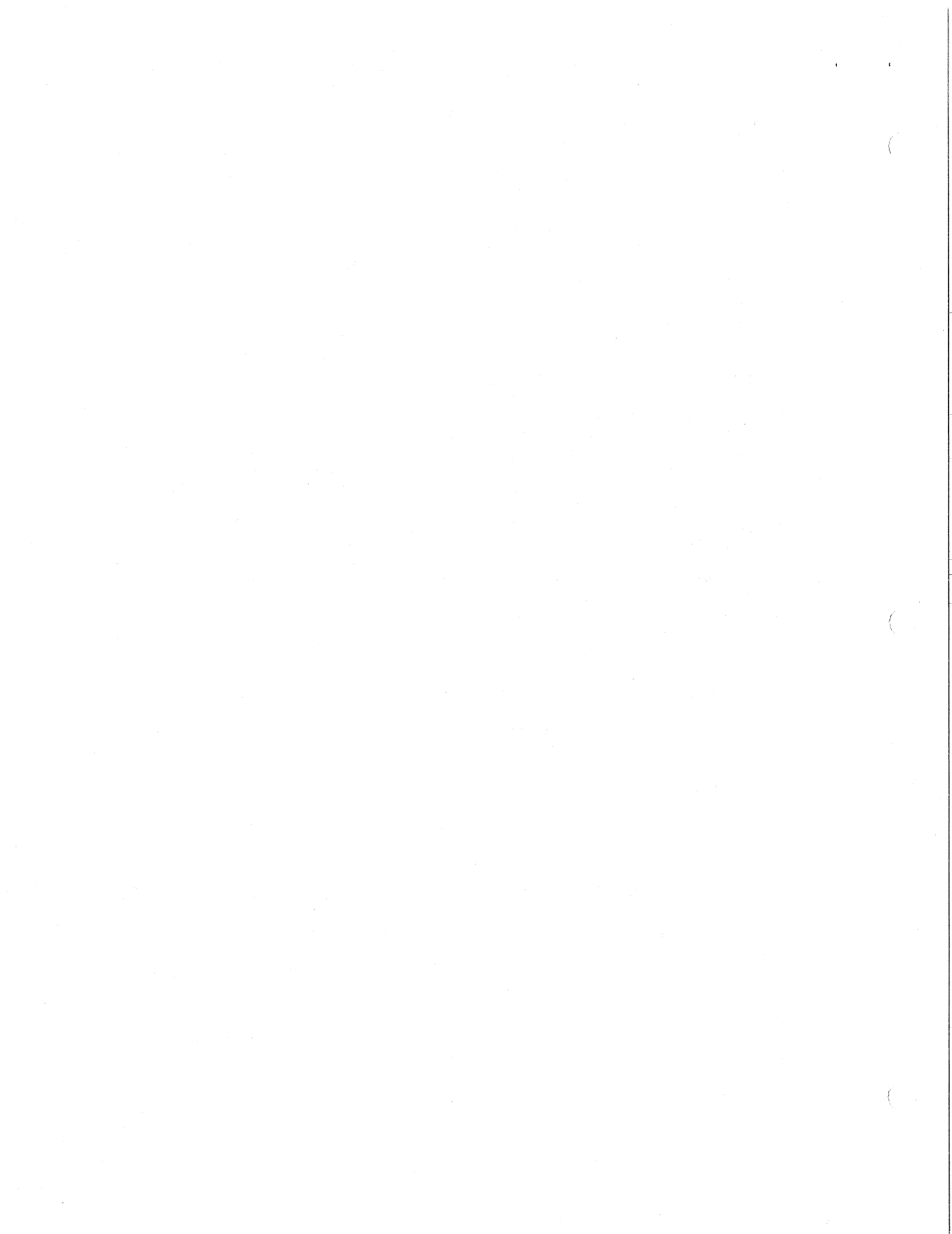

DEC STD 102 Environmental Standard for Computers
and Peripherals.
DEC STD 104 Product Acoustic Noise Limits.
DEC STD 119 Digital Product Safety
A-PG-3700811-05-W000 FSL Packaging Specifications

1.3.2 NON-DIGITAL DOCUMENTS

<u>Document</u>	<u>Part #</u>	<u>Source</u>
Wilson Laboratories MWX-1000 Winchester Disk Analyzer Operator's Manual (For single unit testing)	VPN 650113-B	Wilson Laboratories 2237 N. Batavia Orange, Ca. 92665
Wilson Laboratories DTS-1000 Winchester Disk Test Station Operator's Manual (For mult. unit testing)	VPN DTS-1000D	Wilson Laboratories 2237 N. Batavia Orange, Ca. 92665

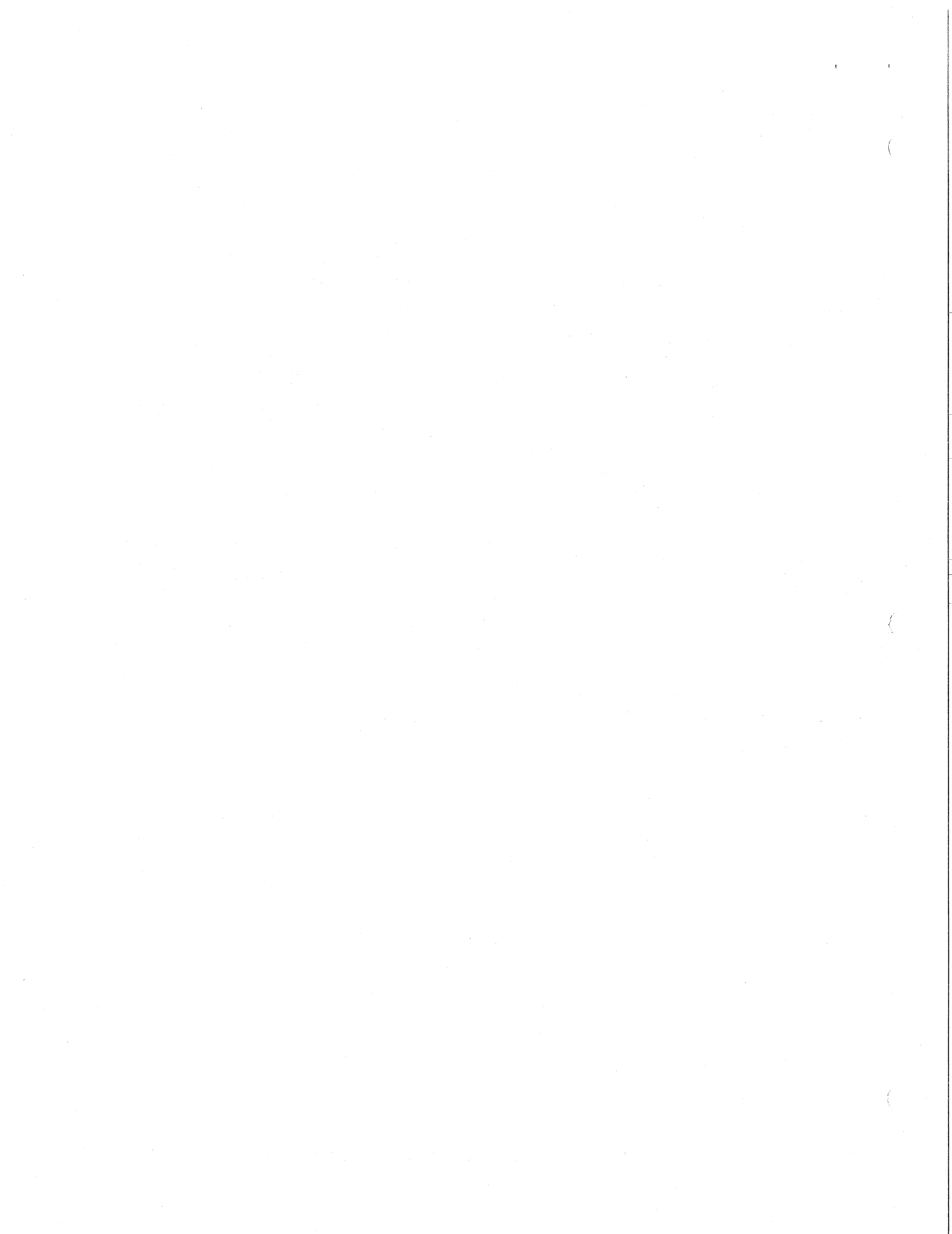
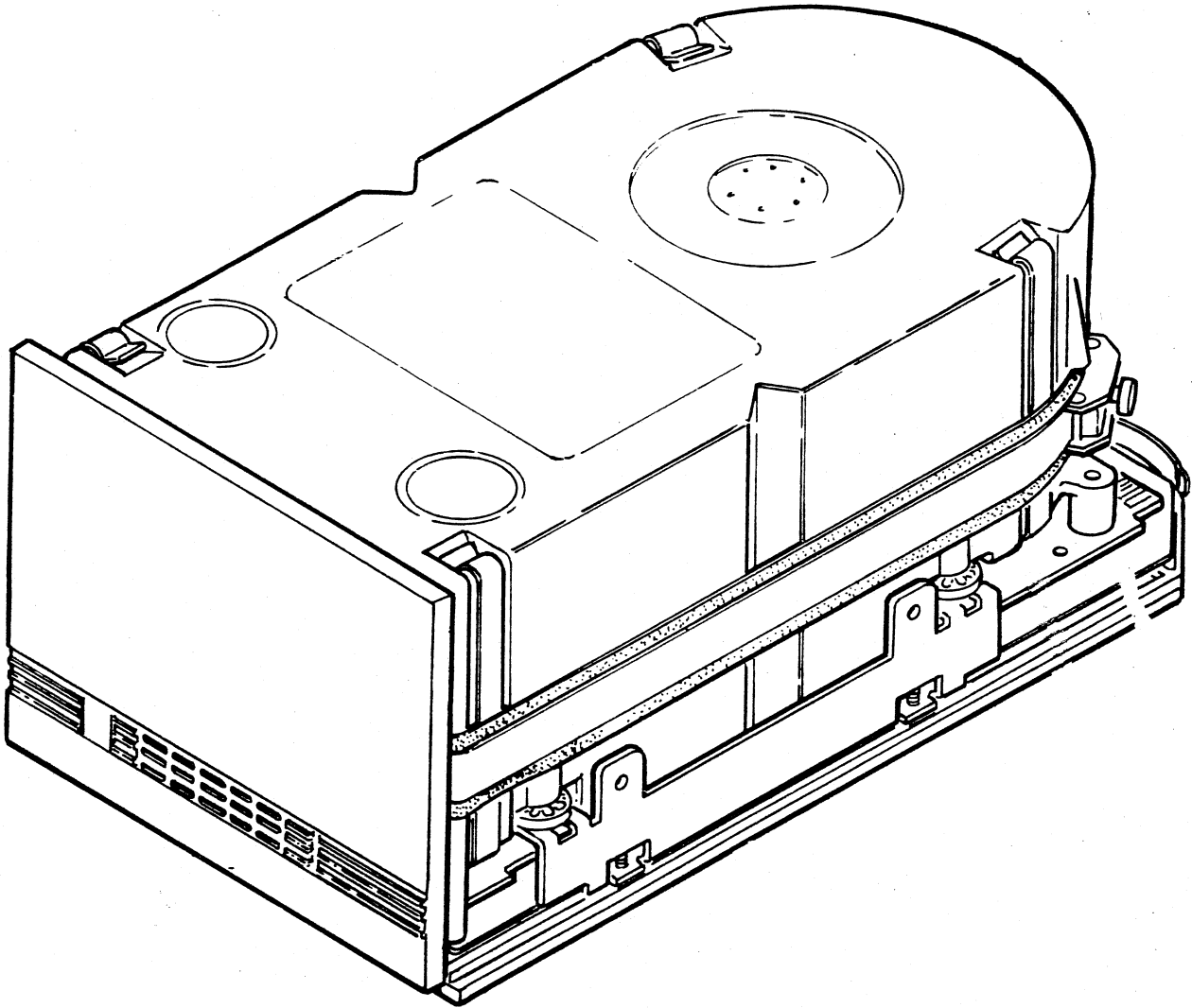

Figure 1-1. RD52-A Winchester Disk Drive.



2.0 REQUIRED PARTS, TEST EQUIPMENT, AND TOOLS

This section identifies all replacement items, tools, fixtures, and test equipment required for the repair.

2.1 REPLACEMENT PARTS

All parts replaced during the repair are listed below:

2.1.1 RD52-A Part List

<u>DEC P/N</u>	<u>VENDOR P/N</u>	<u>DESCRIPTION</u>	<u>QTY</u>	<u>QTY/100</u>
29-24992-00		Device PCB	1	40
29-24993-00		Bezel Assembly	1	5
74-25652-01		Slide Plate	1	5
74-28201-01		Ground Clip	1	5
30-21721-02		RD52 with slide plate, mounting screws, and ground clip	1	

2.2 CAPITAL EQUIPMENT

<u>Description</u>	<u>Part #</u>	<u>Source</u>
Winchester Disk Analyzer Wilson Laboratories (For Single Unit Testing)	VPN MWK-1000	Wilson Labs. 2237 N. Batavia Orange, CA 92665
Winchester Disk Station Wilson Laboratories (For Multiple Unit Testing)	VPN DTS-1000	Wilson Lab 2237 N. Batavia Orange, CA 92665
PRO 350 or 380 (with RCD52 controller)	PC350 or PC380	Digital
Self-Test Card	100479	Wilson Labs.

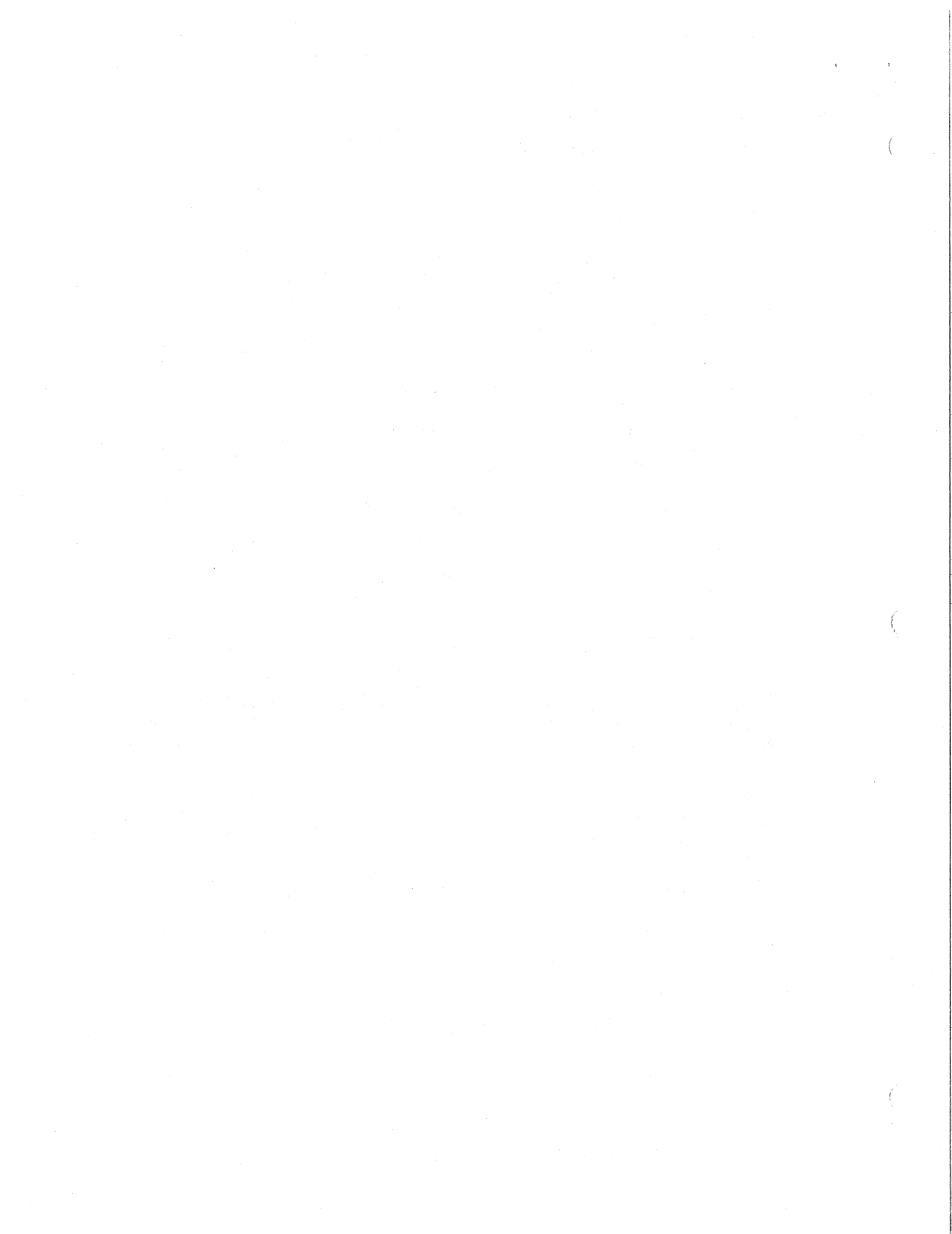

2.3 NON-CAPITAL EQUIPMENT

<u>Description</u>	<u>Part #</u>	<u>Source</u>
LA50 Printer	LA50-RA, RB	Digital
Keyboard	LK201-AA	Digital
Monitor	VR201-A,B,C	Digital

2.4 REQUIRED TOOLS

<u>Description</u>	<u>Part #</u>	<u>Source</u>
Phillips Screwdriver (No. 2)	29-13472-00	Corp/Local
LA50/Wilson MTS Cable Assembly	95-09728-00	FSL Eng'g Serv
Cable Extender Assy.	20028	Seagate

2.5 SOFTWARE

<u>Description</u>	<u>Part #</u>	<u>Source</u>
RDxx FCT Check	K-TP-RDFCT-XX-W000	FSL Eng'g Serv

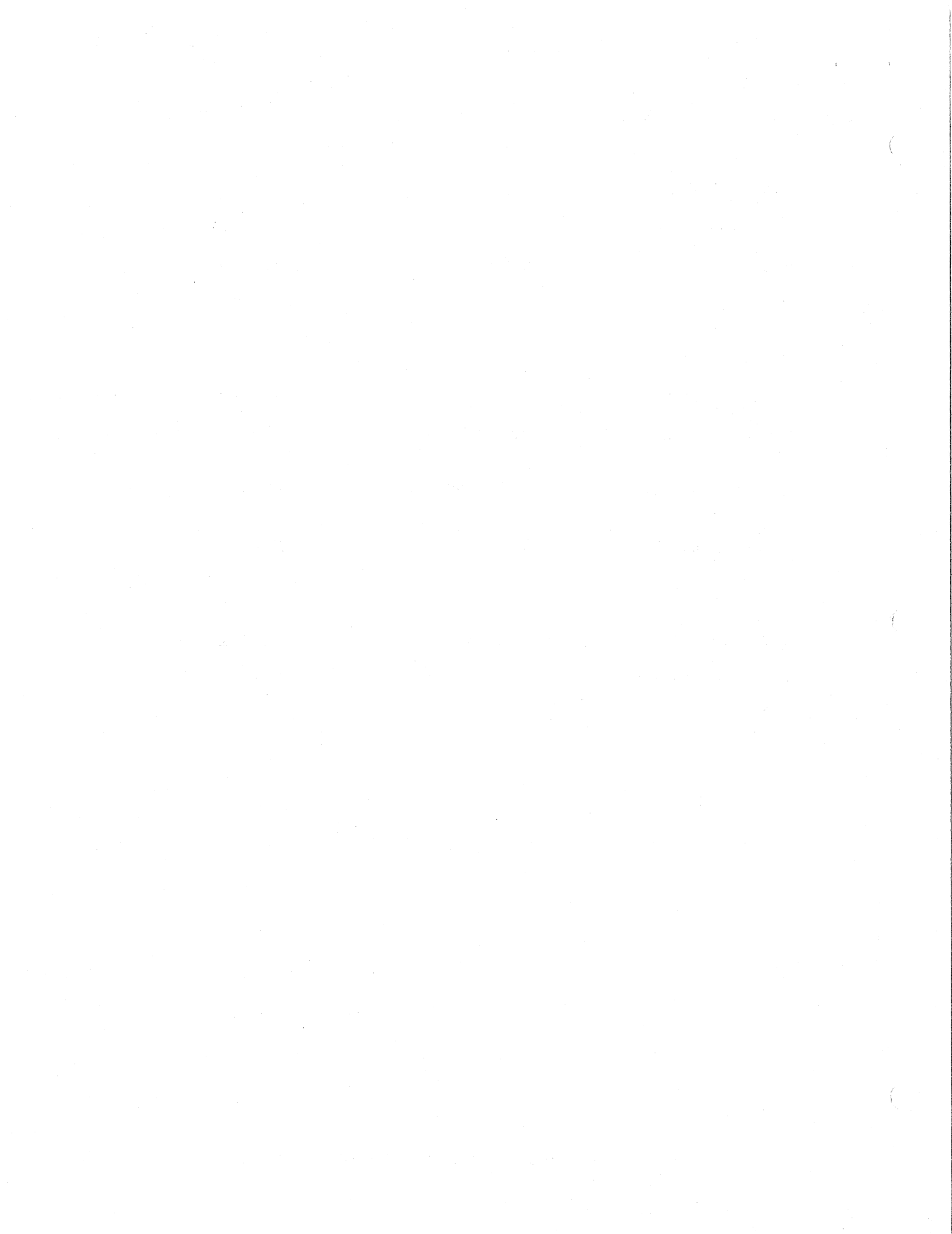

3.0 STANDARDS

This section identifies standards associated with the repair process.

3.1 PROCESS STANDARDS

Part Description:	5.25 in. Winchester Drive
Part Number:	RD52-A (30-21721-02)
Mean Time to Repair:	.70 hrs. (1)
Mean Time to Inspect:	.05 hrs. (1)
Weight:	
Unit Only	7.0 lbs.
Unit and Carton	7.5 lbs. (1)
Size:	
Unit Only	5.75" wide x 8.00" deep x 3.25" high
Carton	13.75" wide x 17.50" deep x 11.25" high

(1) Estimated

3.2 WORKMANSHIP STANDARDS

Acceptable workmanship standards are defined in DEC STD 116. Pay particular attention to Section 5, Hardware and Section 7, Safety.

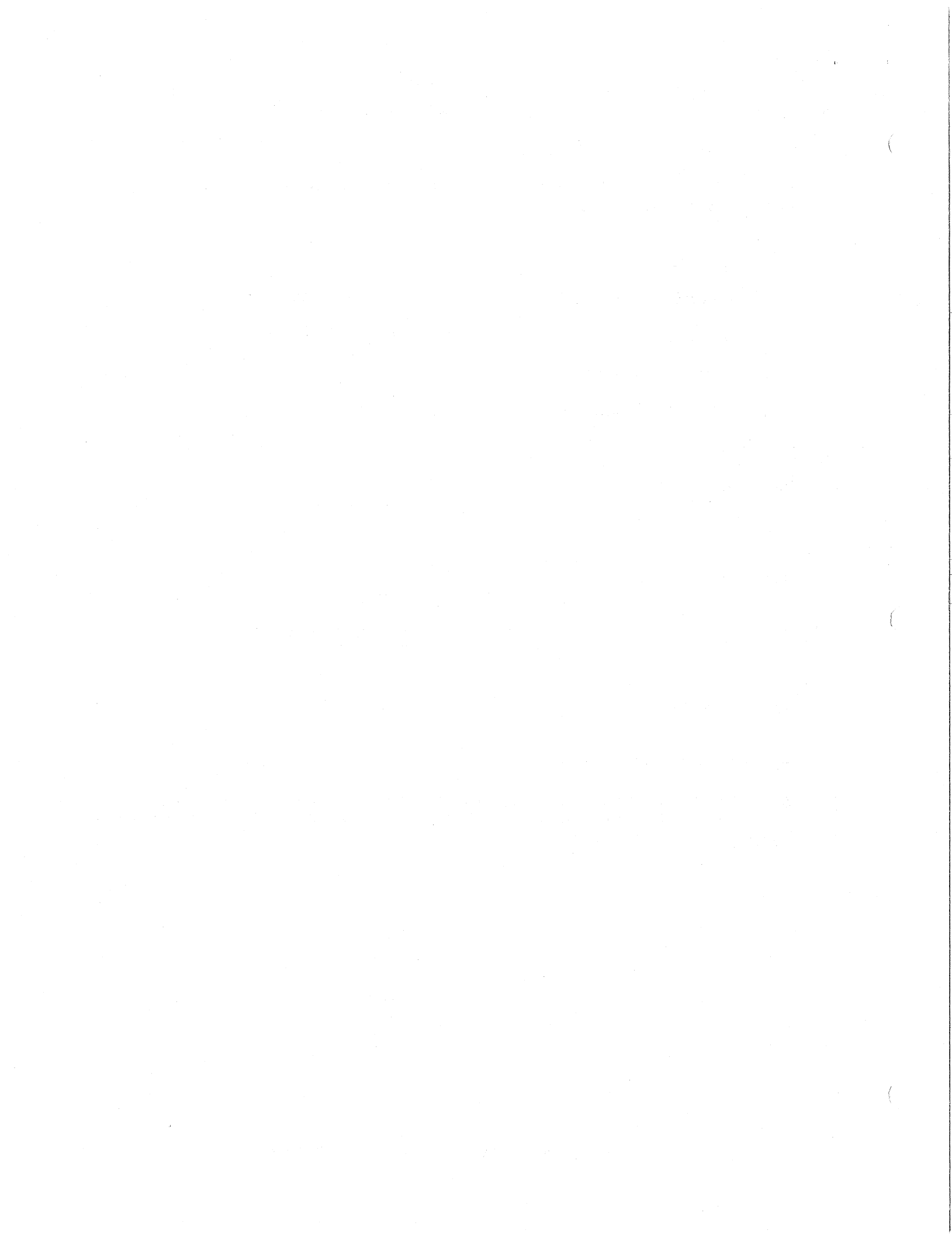

3.3 REFERENCE STANDARDS

<u>DOCUMENTS</u>	<u>DESCRIPTION</u>
DEC STD 031	Option Serialization and Identification
DEC STD 060	Digital Policy Requiring Hardware Products to be Certified and Designed to National and International Regulations.
DEC STD 102	Environmental Standard for Computers and Peripherals.
DEC STD 104	Product Acoustic Noise Limits.
DEC STD 119	Digital Product Safety

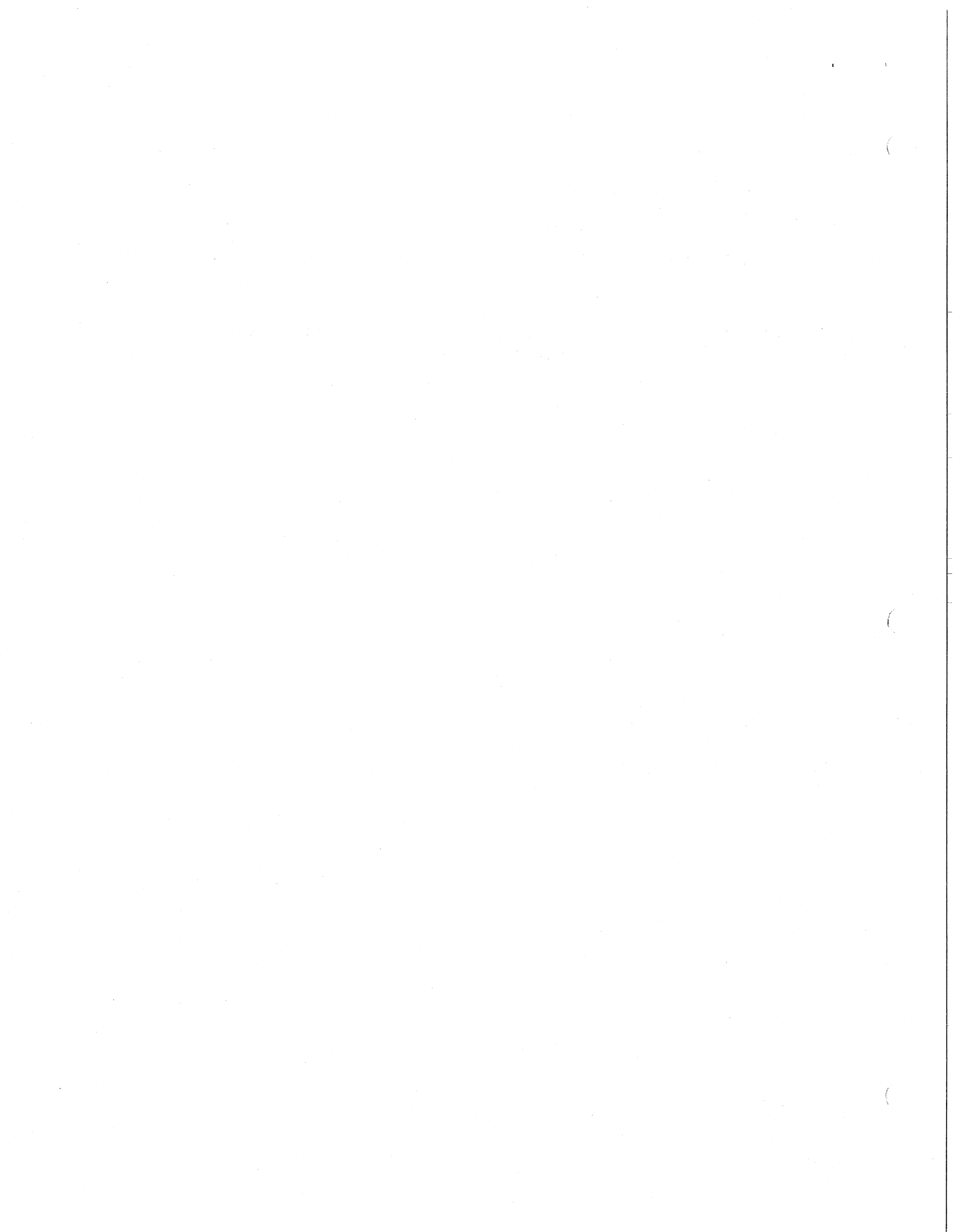

4.0 CALIBRATION AND MAINTENANCE

This section describes the calibration and maintenance routines for the test equipment used in this repair manual.

4.1 CALIBRATION

The following equipment requires calibration at the specified interval.

- 4.1.1 The Wilson Winchester Disk Analyzer upon powering up steps through and verifies that all internal circuitry is functioning properly. The analyzer responds to the completion of the self-tests performed with the prompt:

MWX-1000 READY.

The following equipment allows the Wilson Winchester Disk Analyzer to test and verify the connector cables and connectors.

<u>EQUIPMENT</u>	<u>INTERVAL</u>
Winchester Disk Analyzer MWX-1000 Self-Test Adapter	Annual
Winchester Disk Test Station DTS-1000 Self-Test Adapter	Annual
Data Cables	1 Month

4.2 MAINTENANCE

Repair arrangements must be made with the appropriate equipment manufacturer.

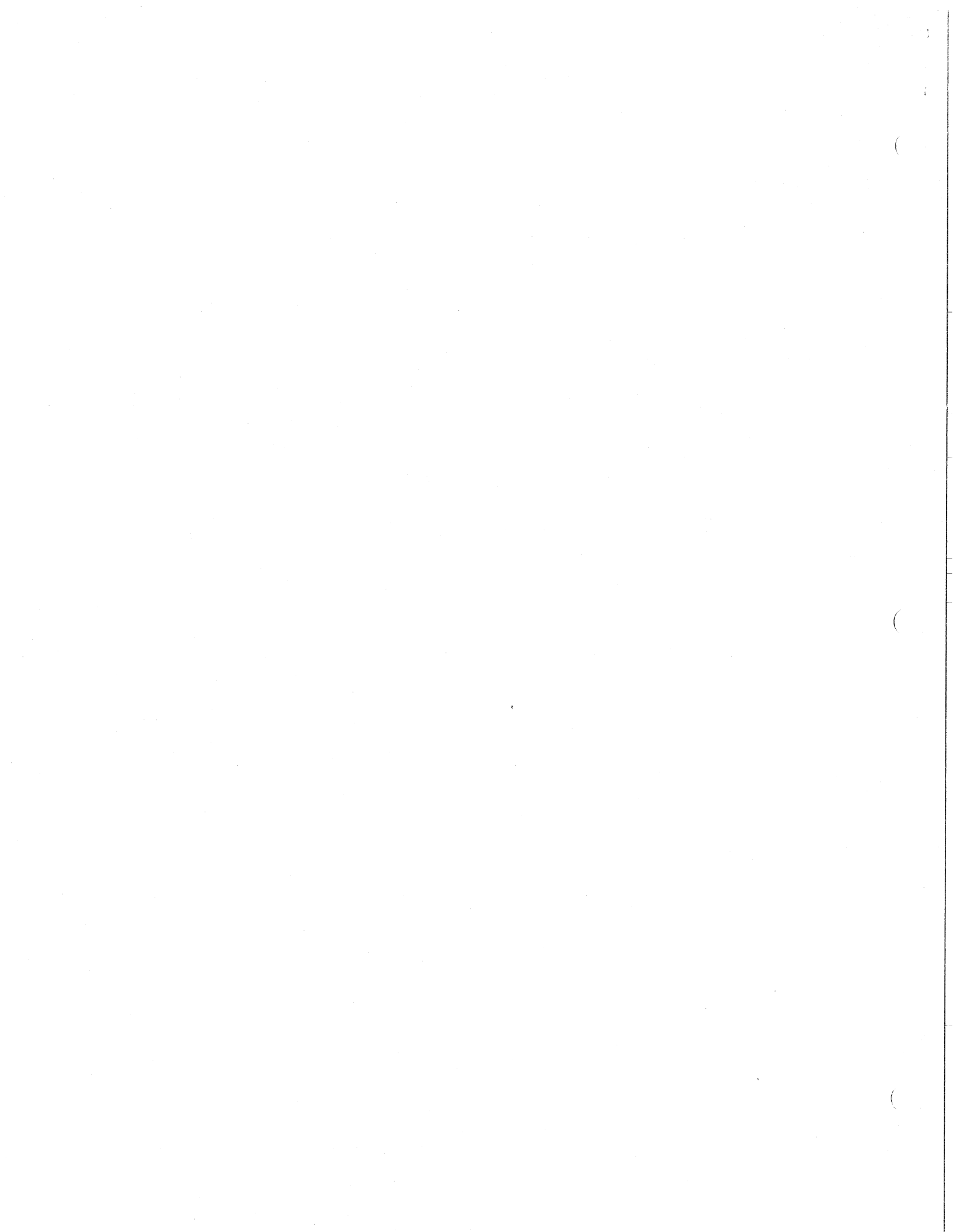

5.0 INCOMING INSPECTION PROCEDURES

This section describes the procedure for identifying the RD52-A at incoming inspection in SR126 and for screening out the units to be scrapped.

5.1 IDENTIFYING THE PART

Identification of the part is only possible through its DEC identification label, white, approximately 0.5" x 4", affixed to the HDA, which is a non-removable portion of the drive.

5.2 INSPECTING THE PART

```

*****
*
*          C A U T I O N          *
*
* After unpacking, the RD52-A is exposed to potential
* handling and ESD hazards. What might otherwise appear
* to be normal handling of the equipment is very likely
* to result in permanent damage to this unit.
*
* To guard against such damage, it is required that the
* RD52-A be received, stored, and transported in
* approved packaging only. Handling of the unit
* outside of the protective package must be kept to
* just that which is necessary. Care must be
* exercised by the inspector to eliminate or minimize
* impact loading of any kind to the Head/Disk Assembly
* (HDA) while observing static discharge precautions.
* It is recommended that a foam cushion be
* provided at the inspection bench for this purpose.
*
* A DROP OF AS LITTLE AS 3 INCHES TO A HARD SURFACE WILL
* DAMAGE THIS UNIT, POTENTIALLY BEYOND REPAIR.
*
* DO NOT TOUCH THE EDGE CONNECTOR PINS OR BOARD
* COMPONENTS WITHOUT OBSERVING STATIC DISCHARGE
* PRECAUTIONS.
*
*****

```

With these cautions in mind, inspection of the device is as follows:

- 5.2.1 Open the shipping carton and verify that the unit was properly packaged. Reference FSL packaging document A-PG-3700811-05-W000.
- 5.2.2 Carefully remove the RD52-A from its shipping package and place it on the inspection bench resting on its skid plate with its spring clip toward you.
- 5.2.3 During inspection, returned RD52-A drives must be in original or DEC approved packaging, should show no evidence of physical damage, broken HDA air seal or missing HDA cover screws and must have the DEC identification label attached. Any physical damage, a violated HDA air seal, cover screws missing from the HDA, no DEC identification label and units not returned in original or DEC approved packaging are unacceptable and the drive must be rejected (no Credit).
- 5.2.4 Upon completion of the inspection process, carefully return the unit to its shipping container.

5.3 PROTECTIVE HANDLING

The RD52-A is a delicate device that requires special handling to insure that it is not damaged during shipping. Use the specially designed carrying containers for handling between stations and for shipment to the repair facility.

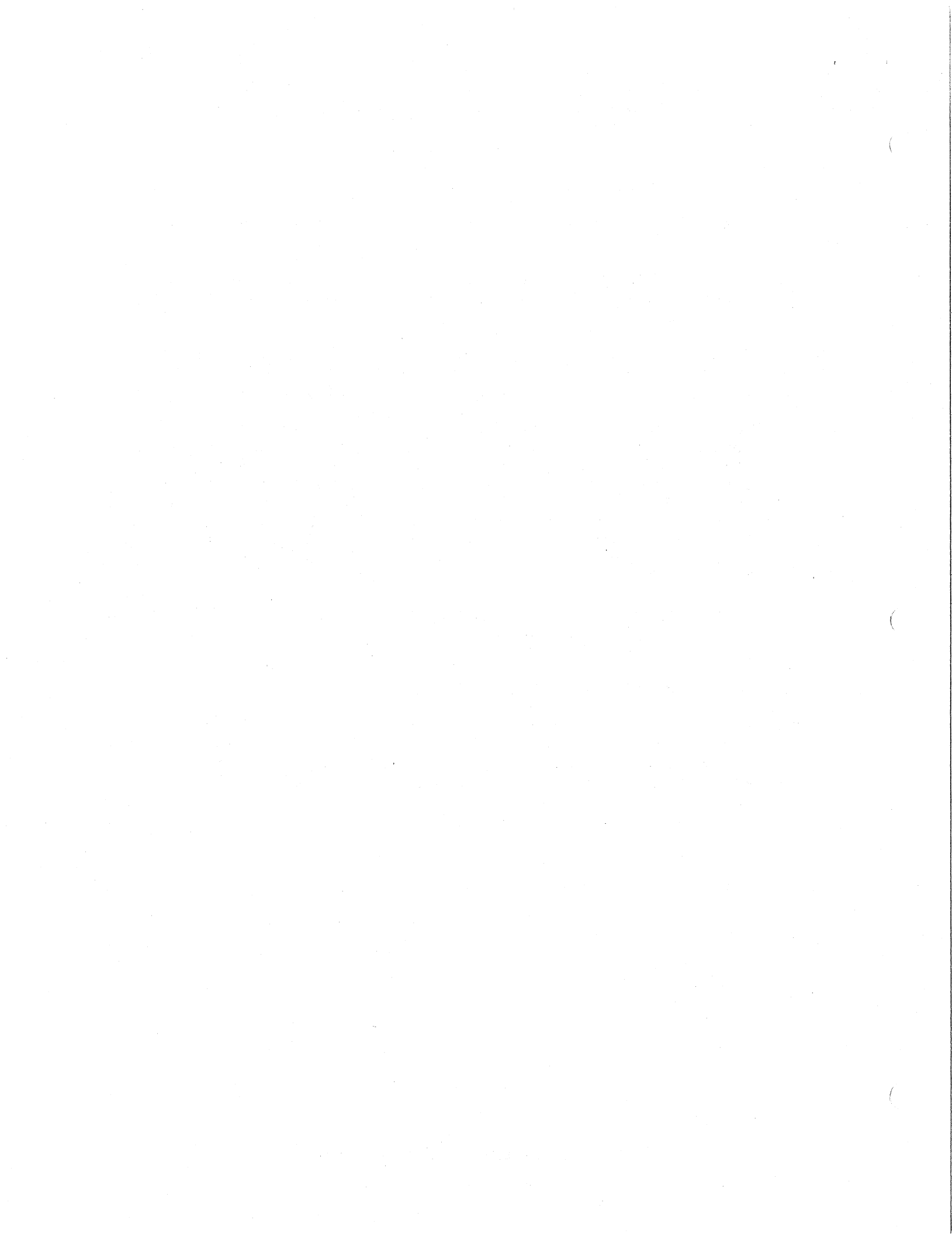

6.0 REPAIR PROCEDURE

This section presents a detailed description of the entire procedure to be performed at the repair facility. Figures are used to clarify specific repair techniques. The repair steps should be performed in the order presented in this section.

*
* **C A U T I O N** *
*
* After unpacking, the RD52-A is exposed to potential *
* handling and ESD hazards. What might otherwise appear *
* to be normal handling of the equipment is very *
* likely to result in permanent damage to this unit. *
*
* To guard against such damage, it is required that *
* the RD52-A be received, stored, and transported in *
* approved packaging only. Handling of the unit *
* outside of the protective package must be kept *
* to just that which is necessary. Care must *
* be exercised by the inspector to eliminate or *
* minimize impact loading of any kind to the Head/Disk *
* Assembly (HDA) while observing static discharge *
* precautions. It is recommended that a foam cushion be *
* provided at the inspection bench for this purpose. *
*
* **A DROP OF AS LITTLE AS 3 INCHES TO A HARD SURFACE WILL** *
* **DAMAGE THIS UNIT, POTENTIALLY BEYOND REPAIR.** *
*
* **DO NOT TOUCH THE EDGE CONNECTOR PINS OR BOARD** *
* **COMPONENTS WITHOUT OBSERVING STATIC DISCHARGE** *
* **PRECAUTIONS.** *
*



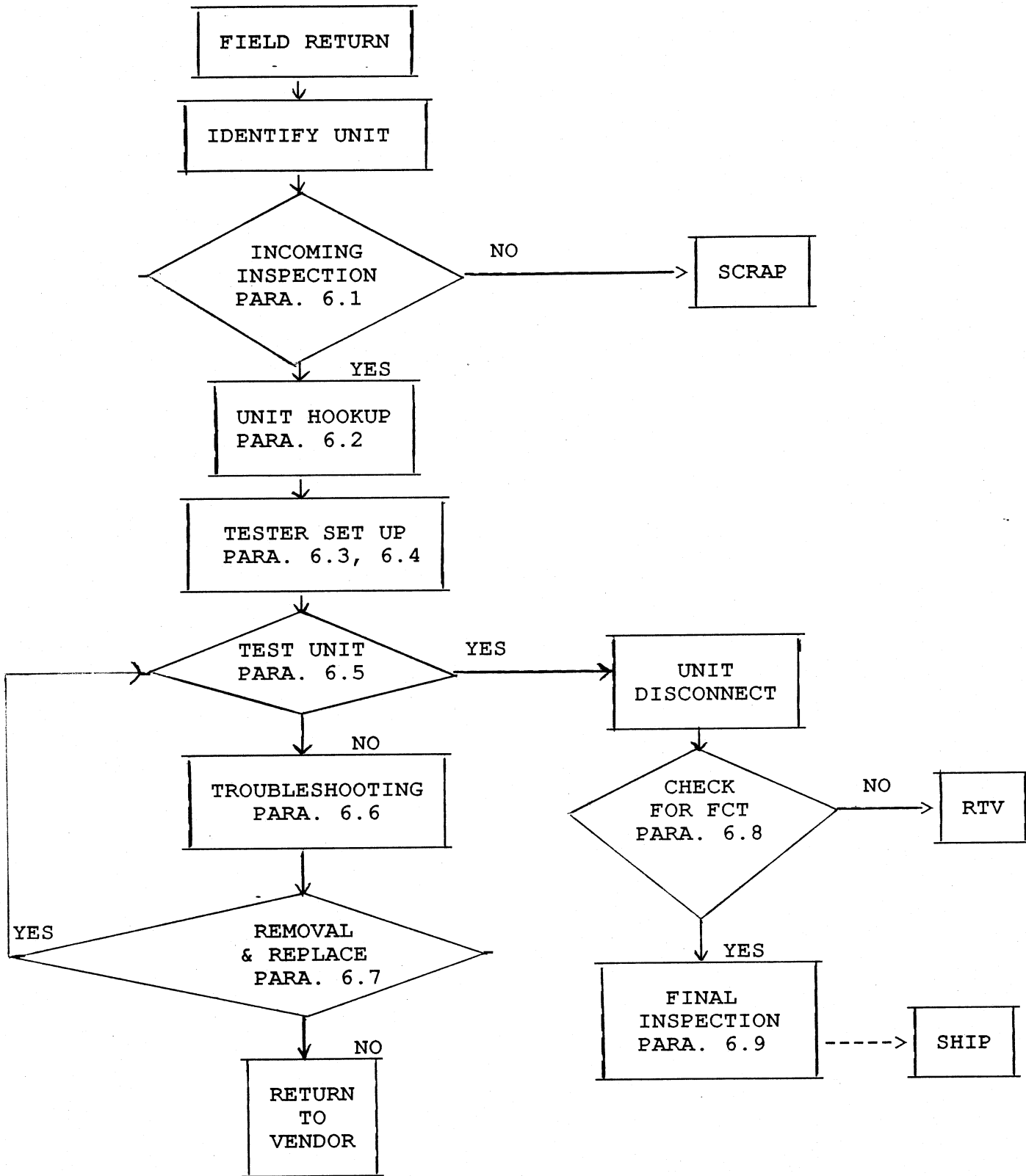

Figure 6-1 Repair Process Flowchart.
*** FOR DIGITAL INTERNAL USE ONLY ***

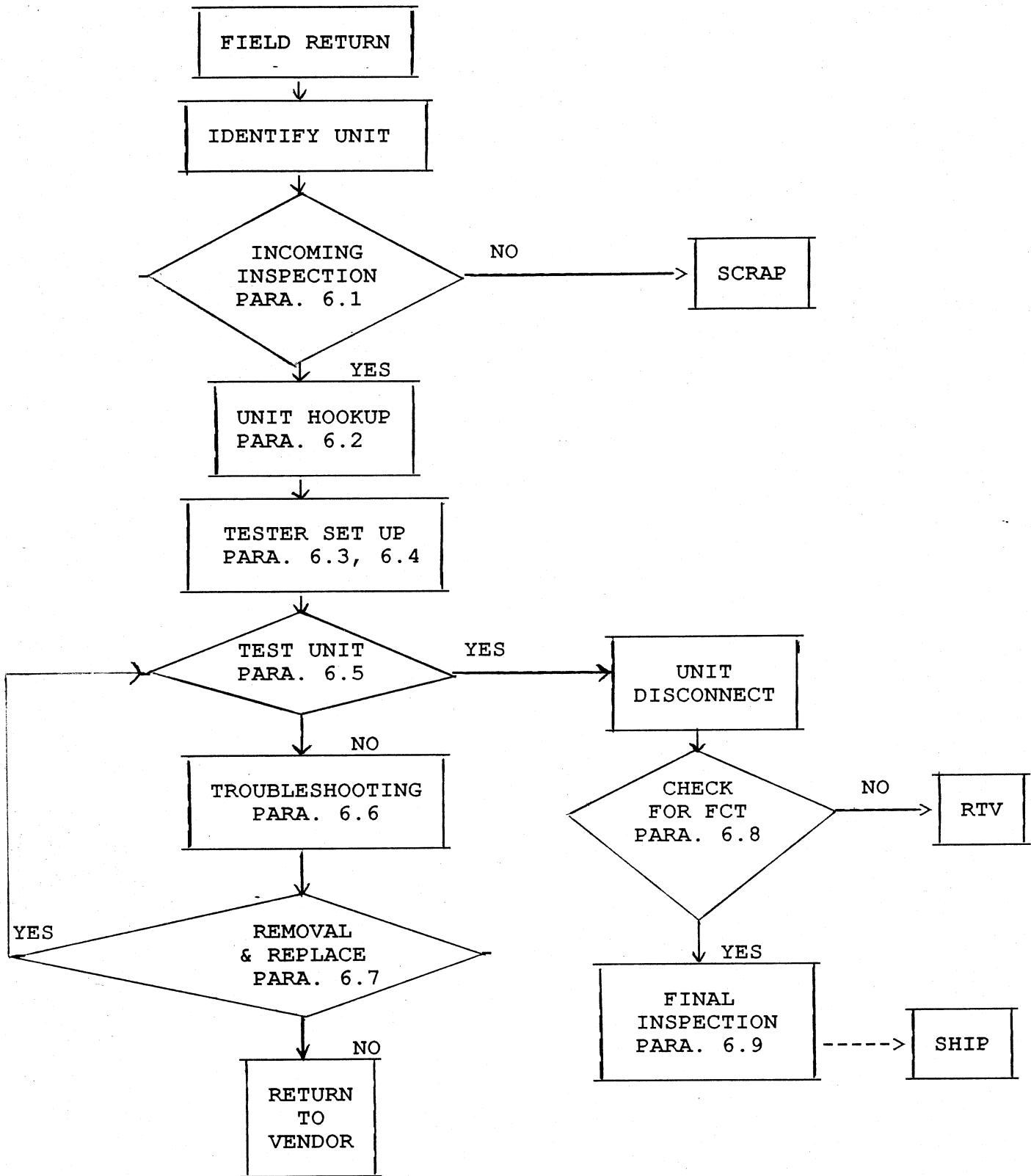

Figure 6-1 Repair Process Flowchart.
*** FOR DIGITAL INTERNAL USE ONLY ***

6.1 INCOMING INSPECTION

6.1.1 Identifying Scrap Units

Remove the drive from its shipping container and inspect. Returned RD52-A drives must be in original or DEC approved packaging, should show no evidence of physical damage, broken HDA air seal or missing HDA cover screws and must have the DEC identification label attached. Any physical damage, a violated HDA air seal, cover screws missing from the HDA, no DEC identification label and units not returned in original or DEC approved packaging are unacceptable and the drive must be rejected (no credit).

6.2 UNIT HOOKUP

- 6.2.1 Carefully place the drive unit on the bench with the Device board down and the edge connectors facing away from you.
- 6.2.2 Connect the data signals through the 20 pin PWA edge connector from the connector location J2 (Figure 6-2) of the drive to the first of four 20 pin connectors provided at the analyzer. Ensure the red line on the ribbon cable corresponds to the location of pin 2 of the series.
- 6.2.3 Connect the control signals through the 34 pin PWA edge connector from location J1 to the 34 pin connector of the analyzer. Once again, ensure the red line on the ribbon cable corresponds to location of pin 2 of the series.
- 6.2.4 Connect the DC power through the 4 pin connector from location J3 to the drive power connector at the analyzer. Also connect the frame grounding wire, which is part of the power cable, to connector location J4.
- 6.2.5 Make sure the drive select jumper is in place over the DS1 pins located on the Device PCB (Figure 6.3).
- 6.2.6 Make sure that the jumper at E7 is at A & B.
- 6.2.7 For the DATS 1000 test station only - Hook-up one of the white probes to L3, either end, and the other white probe to L4, either end. Hook-up the black probe to a ground terminal (there is one easily accessible near the micro-chip.)
- 6.2.8 Connect the LA50 Printer through the 25 pin connector from the RS232 output connector at the back of the analyzer to the back of the printer.
- 6.2.9 Plug the printer and analyzer AC power cord into a standard wall outlet.

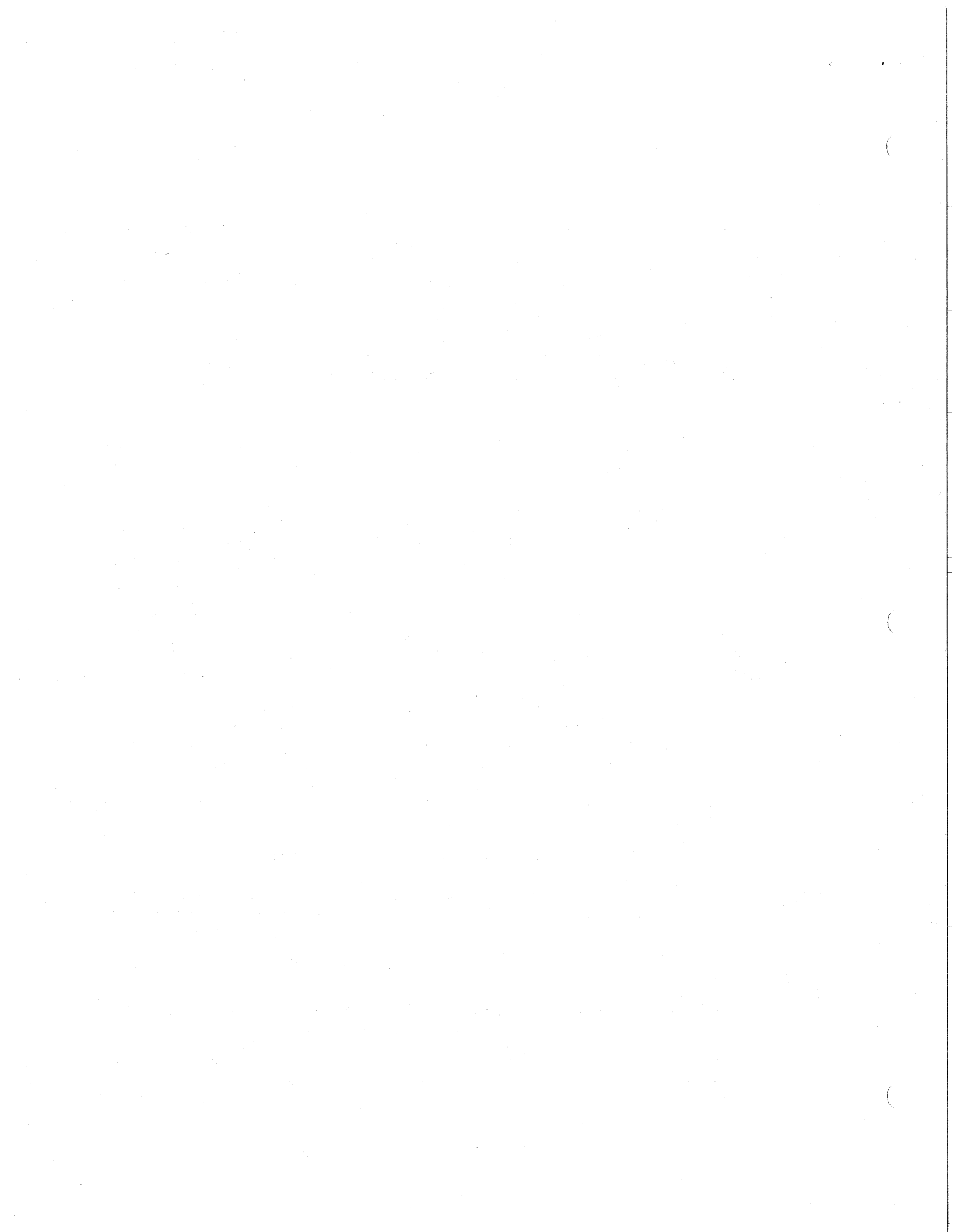

6.2.10 The AC power switch is located on the left hand side of the printer and at the rear of the analyzer. The DTS-1000 has two power switches at the rear. After being powered up, the analyzer screen should display:

MWX-1000 READY

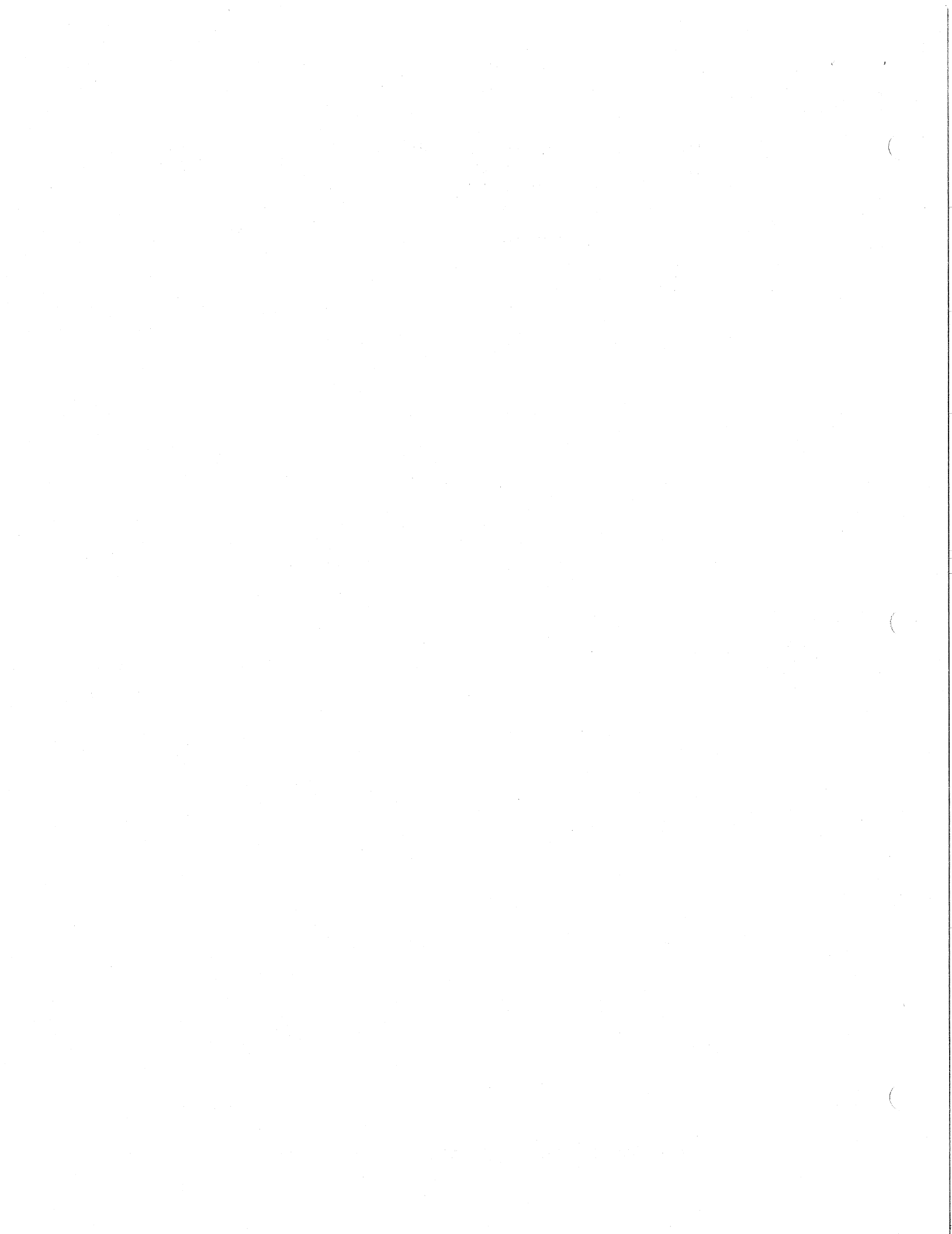
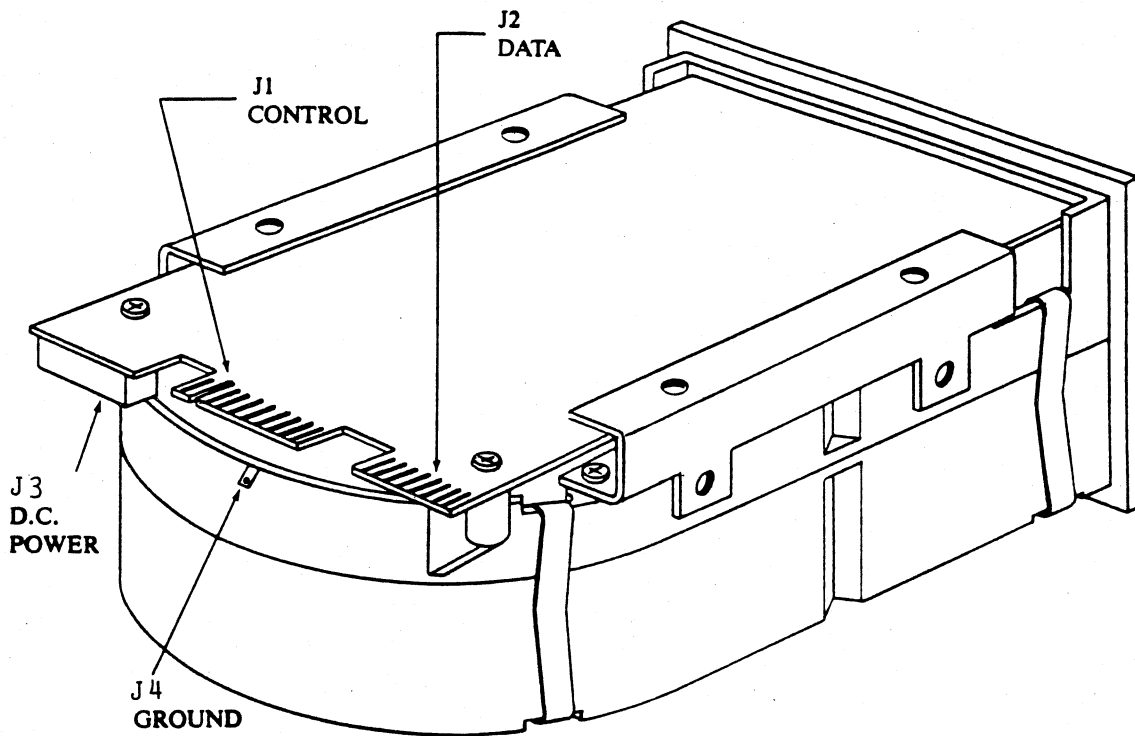

Figure 6-2. RD52-A Power and Interface Connections.



*** FOR DIGITAL INTERNAL USE ONLY ***

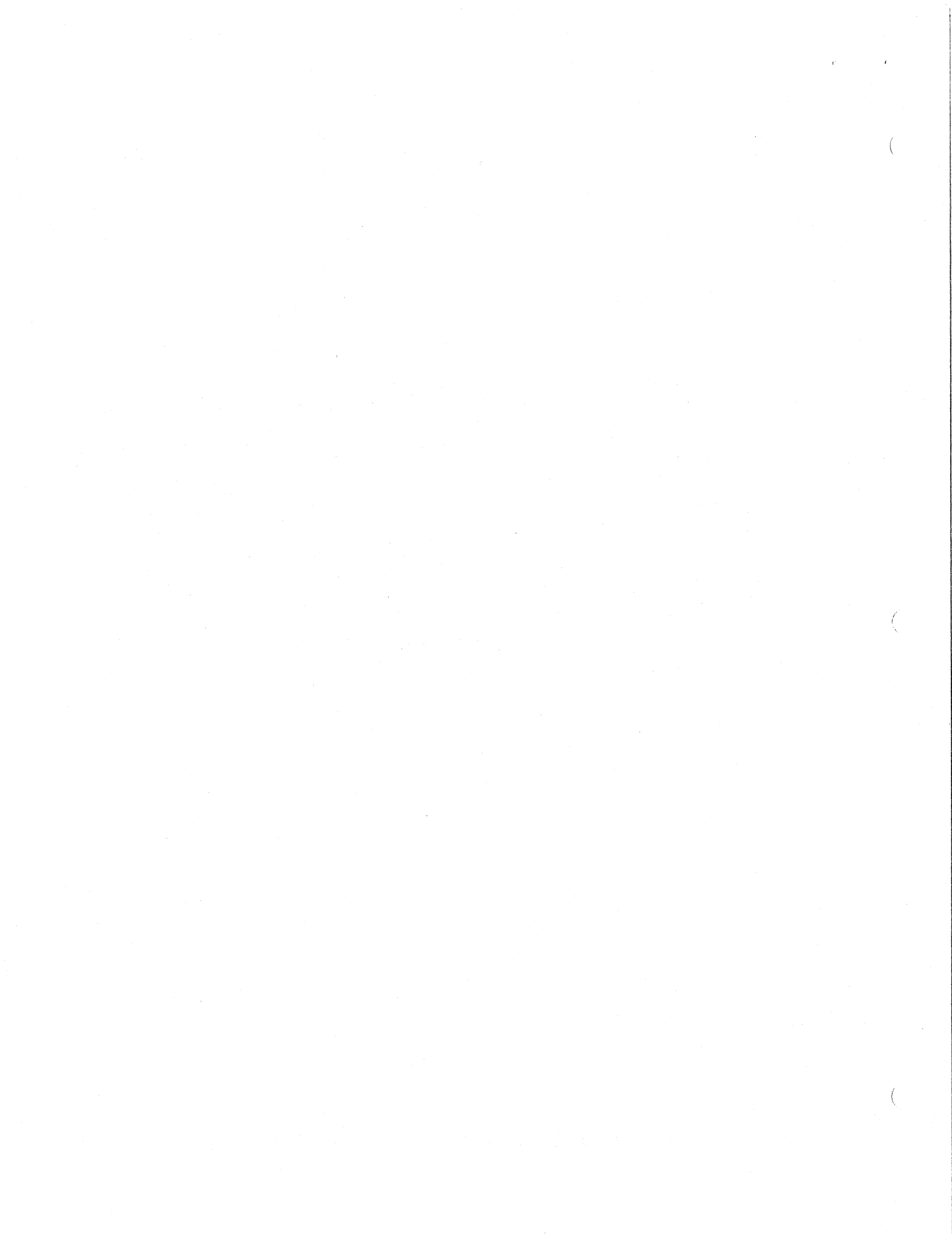
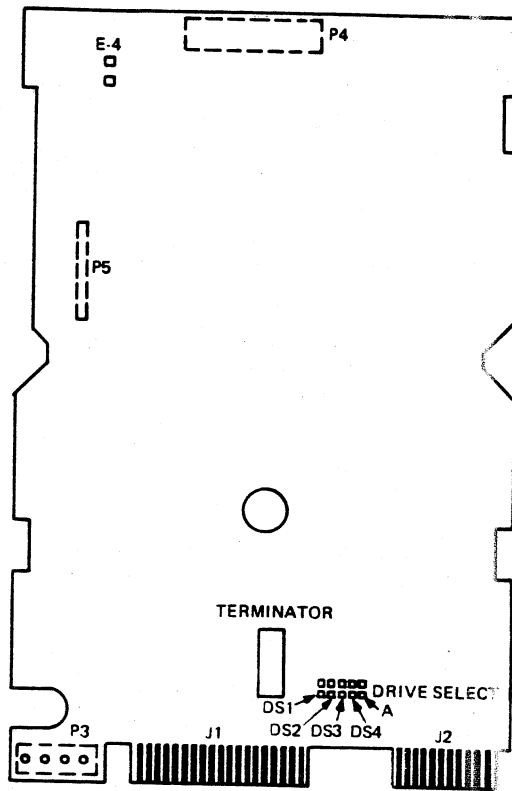
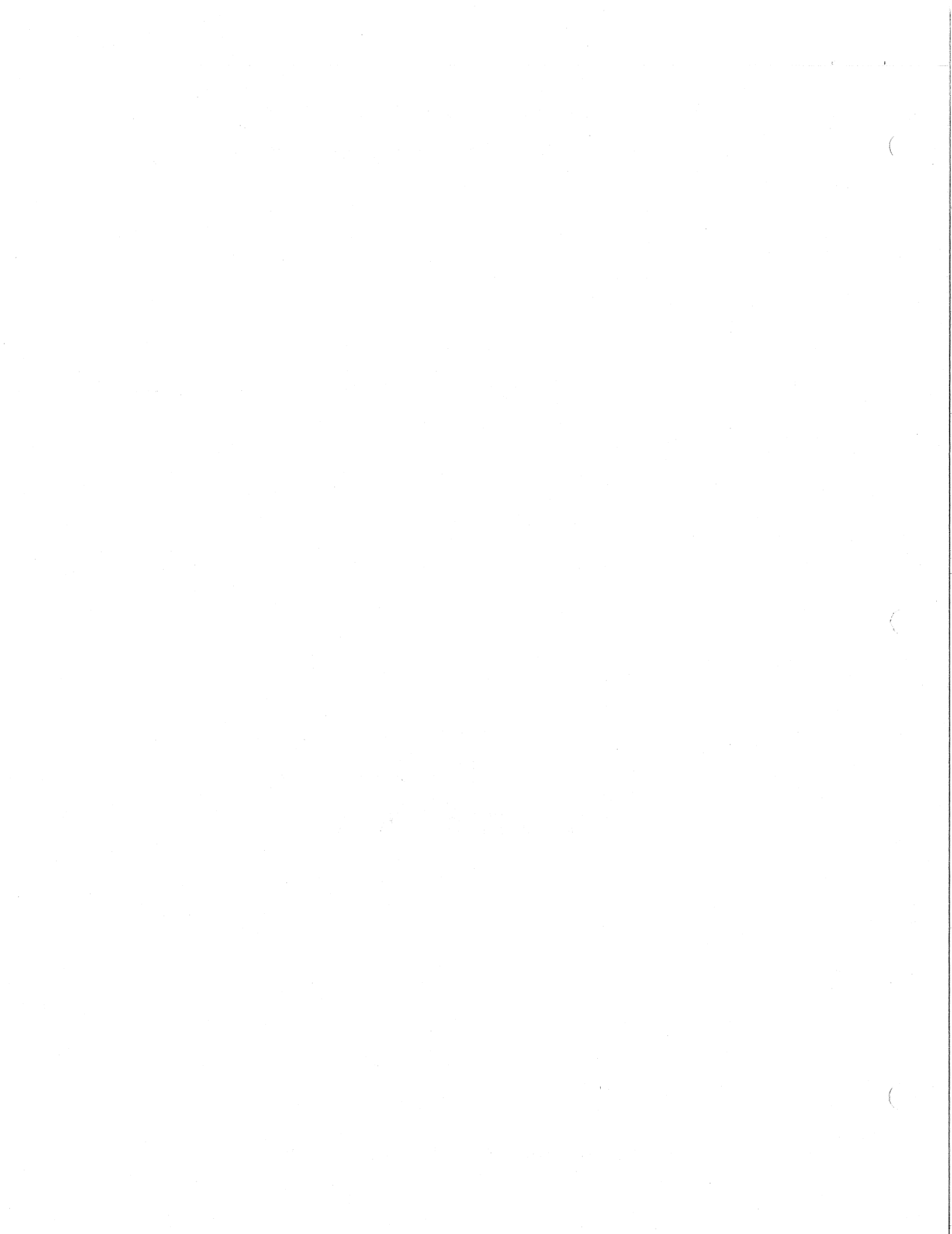

Figure 6.3 Device PCB drive select jumper location.





6.3 TESTER SET UP

6.3.1 To insure proper testing, the following function values must be checked and changed, if different from those values listed. First, turn on the power switch to the printer and the analyzer.

6.3.1.1 Press Function.

Respond to the prompt FUNCTION with the value [3] if different from the code shown in the display.

- Press Enter/Next.

Respond to the prompt PRINT ERR YES with the value YES [1] if different from the code shown on the display.

- Press Enter/Next.

6.3.1.2 Press Function.

Respond to the prompt FUNCTION with the value [6] if different from the code shown on the display.

- Press Enter/Next.

Respond to the prompt READ ERROR ON with the value YES [1] if different from the code shown on the display.

- Press Enter/Next.

6.3.1.3 Press Function.

Respond to the prompt FUNCTION with the value [7] if different from the code shown on the display.

Respond to the prompt TEST SUMMARY ON with the value YES [1] if different from the code shown on the display.

- Press Enter/Next.

6.3.1.4 Press Function.

Respond to the prompt FUNCTION with the value [8] if different from the code shown the display.

- Press Enter/Next.

Respond to the prompt TEST STATUS ON with the value YES [1] if different from the code shown on the display.

- Press Enter/Next.

6.3.1.5 Press Function.

Respond to the prompt FUNCTION with the value [9] if different from the code shown on the display.

- Press Enter/Next.

Verify that the prompt shows VRSN X0175/Z0177 or X0176/Z0177.

6.3.1.6 Press Function.

Respond to the prompt FUNCTION with the value [10] if different from the code shown on the display.

- Press Enter/Next.

Respond to the prompt LOCK MODE (1-6) with the value [1] if different from the code shown on the display.

- Press Enter/Next.

Verify that the prompt shows LOCKOUT ENABLE.

- Press Enter/Next.

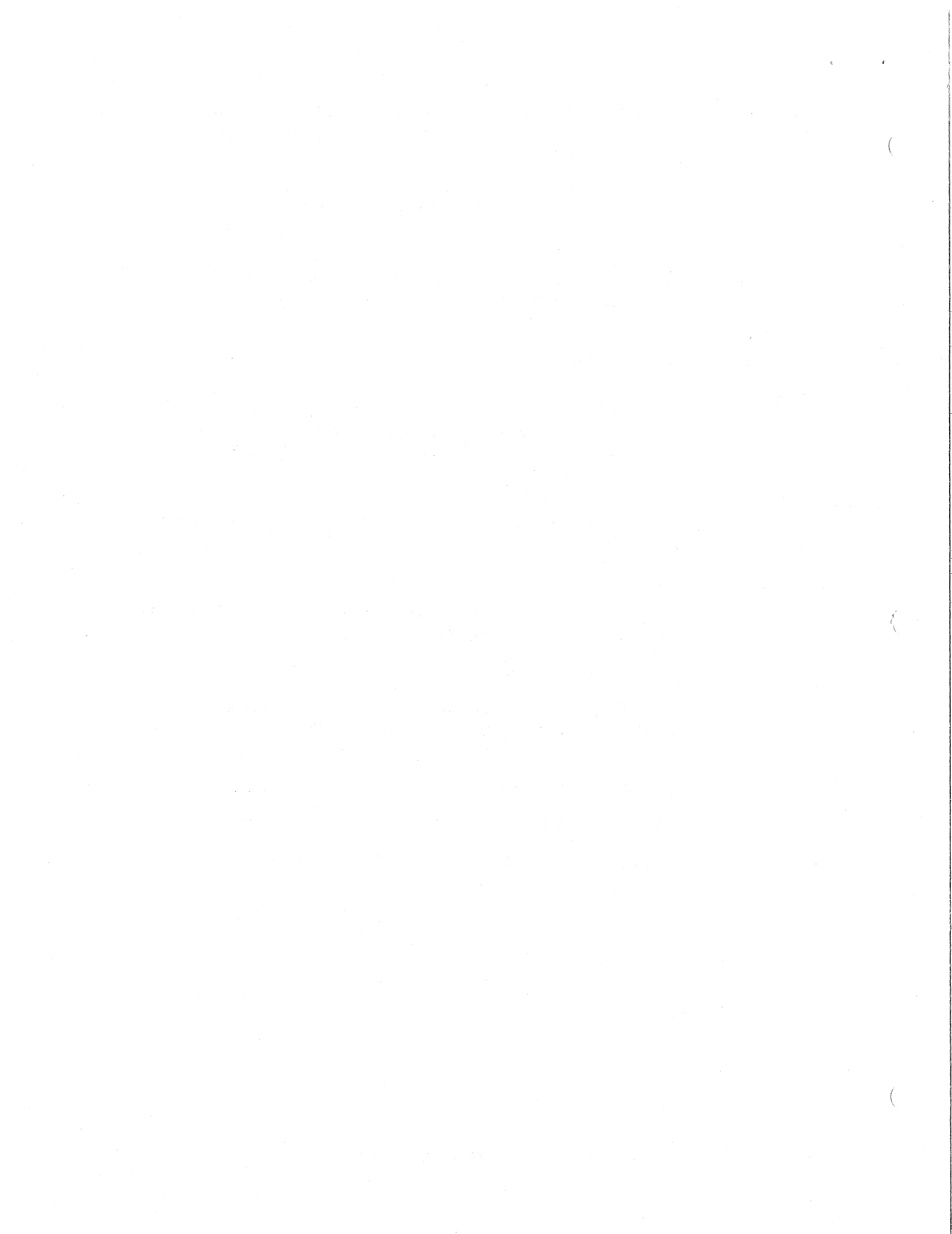

6.3.1.7 Press Function.

Respond to the prompt FUNCTION with the value [13] if different from the code shown on the display.

- Press Enter/Next.

Respond to the prompt 24 BIT PTRN NO with the value NO [0] if different from the code shown on the display.

- Press Enter/Next.

6.3.1.8 Press Function.

Respond to the prompt FUNCTION with the value [17] if different from the code shown on the display.

- Press Enter/Next.

Respond to the prompt CYLINDER MODE NO with the value NO [0] if different from the code shown on the display.

- Press Enter/Next.

6.3.1.9 Press Function.

Respond to the prompt FUNCTION with the value [18] if different from the code shown on the display.

- Press Enter/Next.

Respond to the prompt R MRG STROBE 14 with the value [14] if different from the code shown on the display.

- Press Enter/Next.

6.3.1.10 Press Function.

Respond to the prompt FUNCTION with the value [19] if different from the code shown on the display.

- Press Enter/Next.

Respond to the prompt BAUD RATE 4800 with the value [4800] if different from the code shown on the display.

- Press Enter/Next.

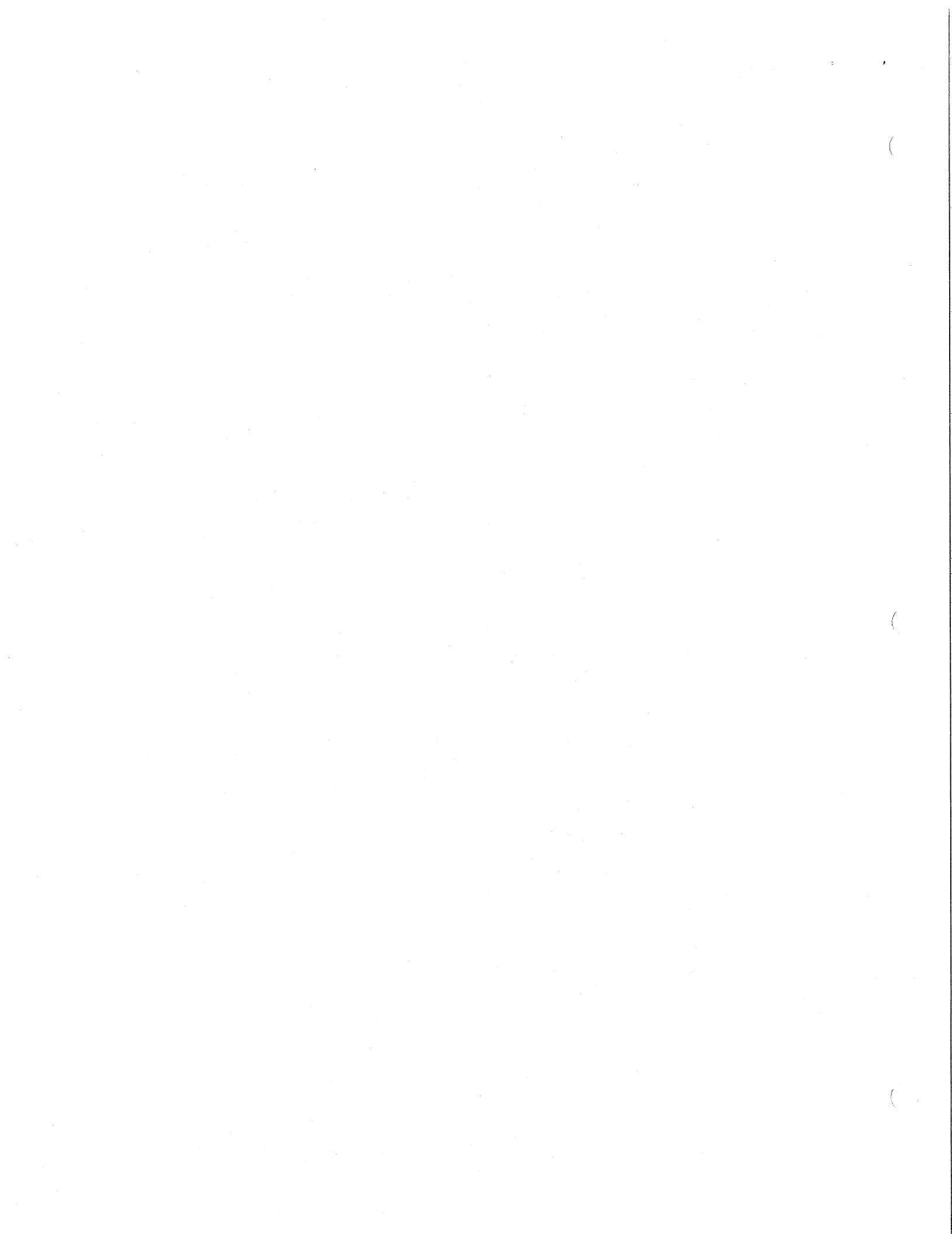

6.3.1.11 Press Function.

Respond to the prompt FUNCTION with the value [20] if different from the code shown on the display.

- Press Enter/Next.

Respond to the prompt ENABLE DTS (*) with the value corresponding to the specific analyzer being used, if different from the code shown on the display.

* If using the MWX-1000 Winchester disk analyzer, respond NO [0].

Press Enter/Next and proceed to step 6.3.1.12.

* If using the DTS-1000 Winchester disk station, respond YES [1].

- Press Enter/Next.

Respond to the prompt TYP DTS 1/2/3 2 with the value [2] if different from the code shown on the display.

- Press Enter/Next.

Respond to the prompt POWER LOW NO with the value NO [0] if different from the code shown on the display.

- Press Enter/Next.

Respond to the prompt POWER NORML NO with the value NO [0] if different from the code shown on the display.

- Press Enter/Next.

Respond to the prompt POWER HIGH NO with the value NO [0] if different from the code shown on the display.

- Press Enter/Next.

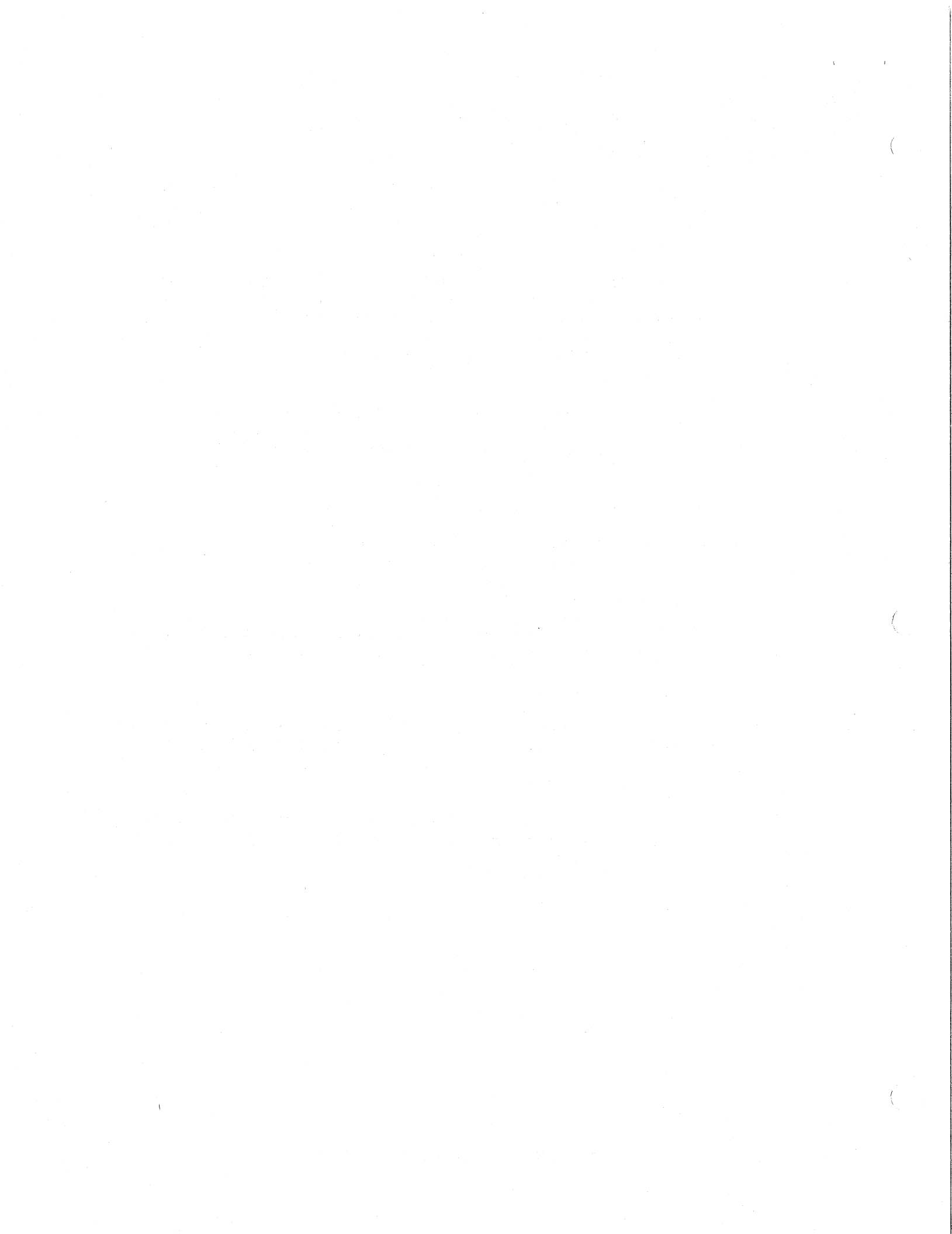

6.3.1.12 Press Function.

Respond to the prompt FUNCTION with the value [22] if different from the code shown on the display.

- Press Enter/Next.

Respond to the prompt NO OF M/V 1 with the value [1] if different from the code shown on the display.

- Press Enter/Next.

6.3.1.13 Press Function.

Respond to the prompt FUNCTION with the value [23] if different from the code shown on the display.

- Press Enter/Next.

Respond to the prompt B/T SFT ERR YES with the value YES [1] if different from the code shown on the display.

- Press Enter/Next.

6.3.1.14 Press Function.

Respond to the prompt FUNCTION with the value [24] if different from the code shown on the display.

- Press Enter/Next.

Respond to the prompt OTR MRG LMT 16 with the value [16] if different from the code shown on the display.

- Press Enter/Next.

Respond to the prompt INNR MRG LMT 16 with the value [16] if different from the code shown on the display.

- Press Enter/Next.

6.3.1.15 Press Function.

Respond to the prompt FUNCTION with the value [25]
if different from the code shown on the display.

- Press Enter/Next.

Respond to the prompt TL HARD ERR 0 with the value [0]
if different from the code shown on the display.

- Press Enter/Next.

Respond to the prompt TL SOFT ERR 0 with the value [0]
if different from the code shown on the display.

- Press Enter/Next.

Respond to the prompt HARD ERR/HD 0 with the value [0]
if different from the code shown on the display.

- Press Enter/Next.

Respond to the prompt SOFT ERR/HD 0 with the value [0]
if different from the code shown on the display.

- Press Enter/Next.

Respond to the prompt STEP ERRS 0 with the value [0]
if different from the code shown on the display.

- Press Enter/Next.

6.3.1.16 Press Function.

Respond to the prompt FUNCTION with the value [26]
if different from the code shown on the display.

- Press Enter/Next.

Respond to the prompt ENABLE PARK NO with the value NO
[0] if different from the code shown on the display.

- Press Enter/Next.

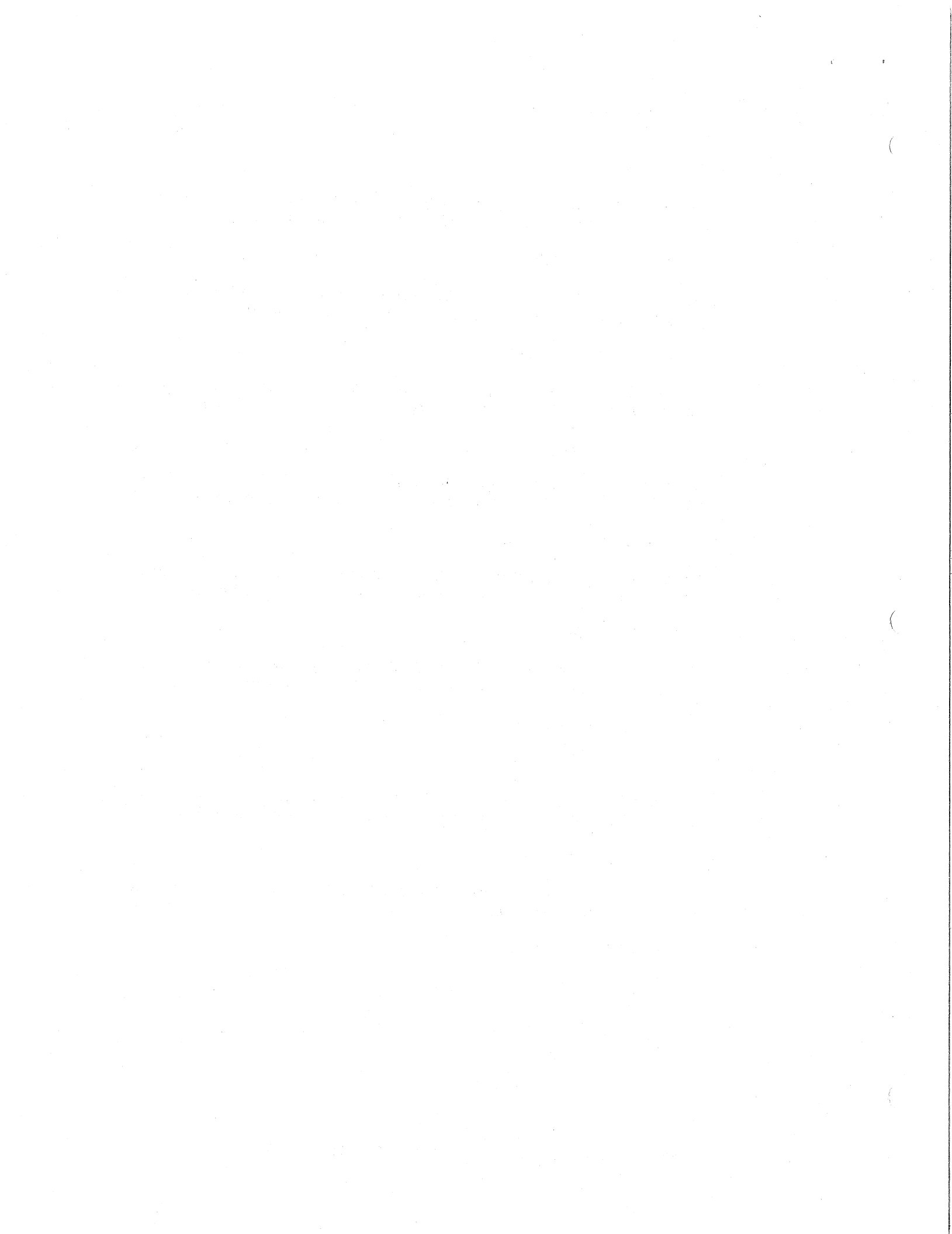

6.3.1.17 Press Function.

Respond to the prompt FUNCTION with the value [31] if different from the code shown on the display.

- Press Enter/Next.

Respond to the prompt NO OF SEEK with the value [128] if different from the code shown on the display.

- Press Enter/Next.

6.3.1.18 Press Function.

Respond to the prompt FUNCTION with the key marked [TIME] if different from the code shown on the display.

- Press Enter/Next.

Respond to the prompt ENTER YEAR - [] with the value corresponding to the present year.

- Press Enter/Next.

Respond to the prompt ENTER MON - [] with the value corresponding to the present month.

- Press Enter/Next.

Respond to the prompt ENTER DAY - [] with the value corresponding to the present day of the month.

- Press Enter/Next.

Respond to the prompt ENTER HOUR - [] with the value corresponding to the present hour of the day.

- Press Enter/Next.

Respond to the prompt ENTER MIN - [] with the value corresponding to the present minute of the hour.

- Press Enter/Next.

Respond to the prompt ENTER SEC - [] with the value corresponding to the present second of the minute.

- Press Enter/Next.

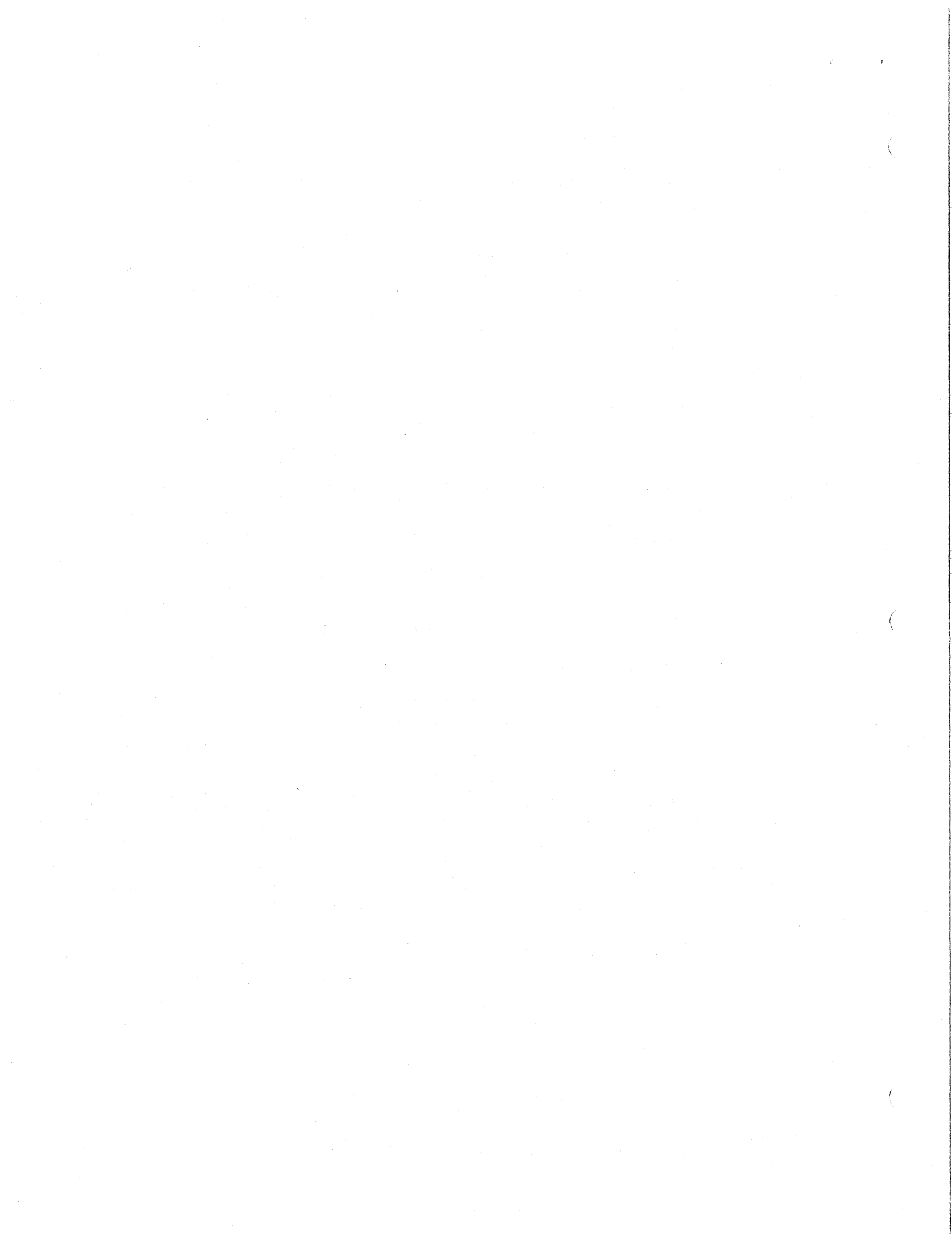

6.3.2 Tester Set Up Quick Check Chart

<u>FUNCTION</u>	<u>VALUE</u>
3	PRINT ERR YES [1]
6	READ ERROR ON [1]
7	TEST SUMMARY ON [1]
8	TEST STATUS ON [1]
9	VRSN X0175/Z0177 VRSN X0176/Z0177
10	LOCK MODE (1-6) [1] LOCKOUT ENABLE
13	24 BIT PTRN NO [0]
17	CYLINDER MODE NO [0]
18	R MRG STROBE [14]
19	BAUD RATE [4800]
20	ENABLE DTS if MWX-1000: NO [0] if DTS-1000: YES [1] TYP DTS 1/2/3 [2] POWER LOW NO [0] POWER NORML NO [0] POWER HIGH NO [0]
22	NO OF M/V [1]
23	B/T SFT ERR YES [1]
24	OUTR MRG LMT [16] INNR MRG LMT [16]

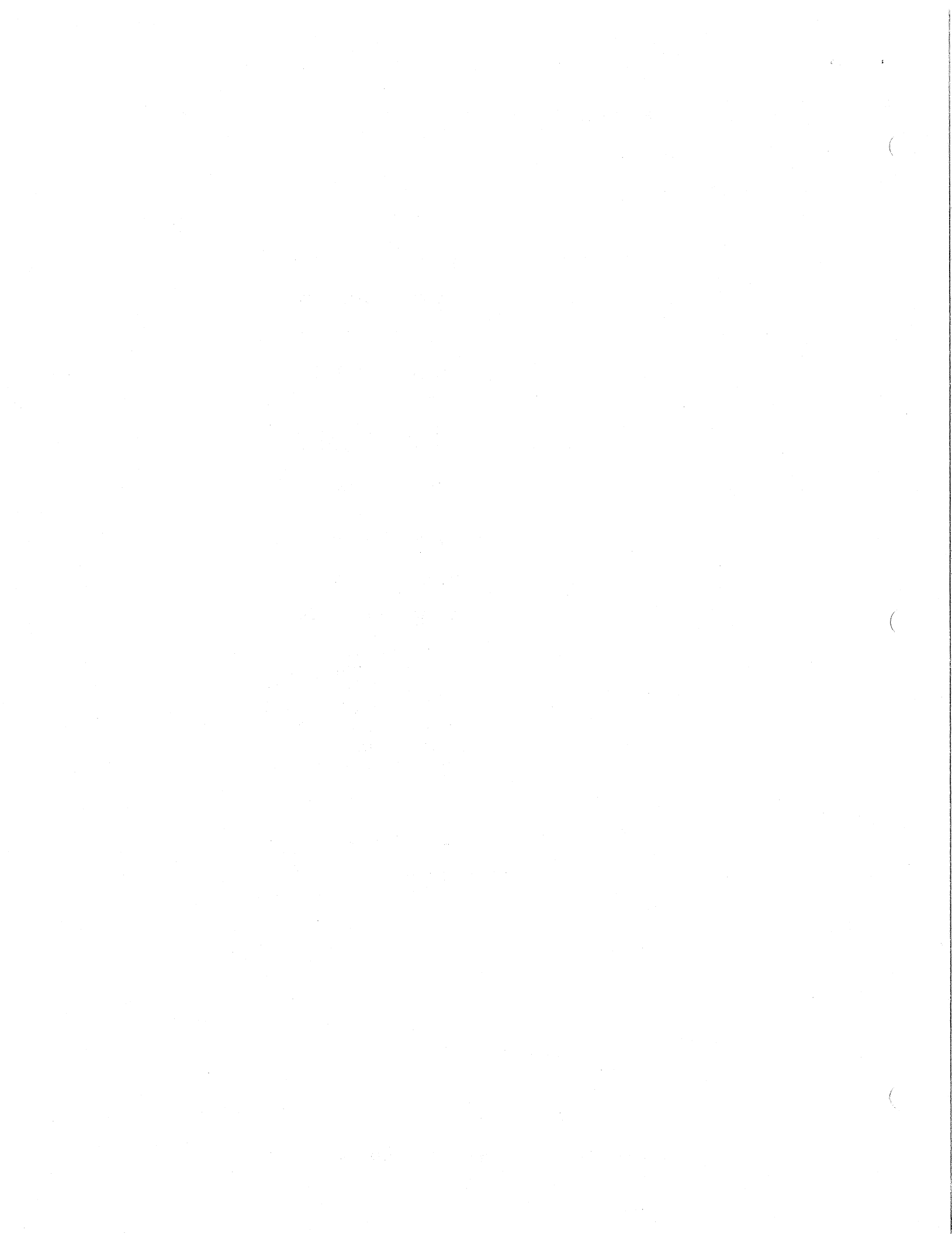

25

TL HARD ERR [0]
TL SOFT ERR [0]
HARD ERR/HD [0]
SOFT ERR/HD [0]
STEP ERRS [0]

26

ENABLE PARK NO [0]

31

NO OF SEEK [128]

TIME

TIME

ENTER YEAR - []

ENTER MON - []

ENTER DAY - []

ENTER HOUR - []

ENTER MIN - []

ENTER SEC - []

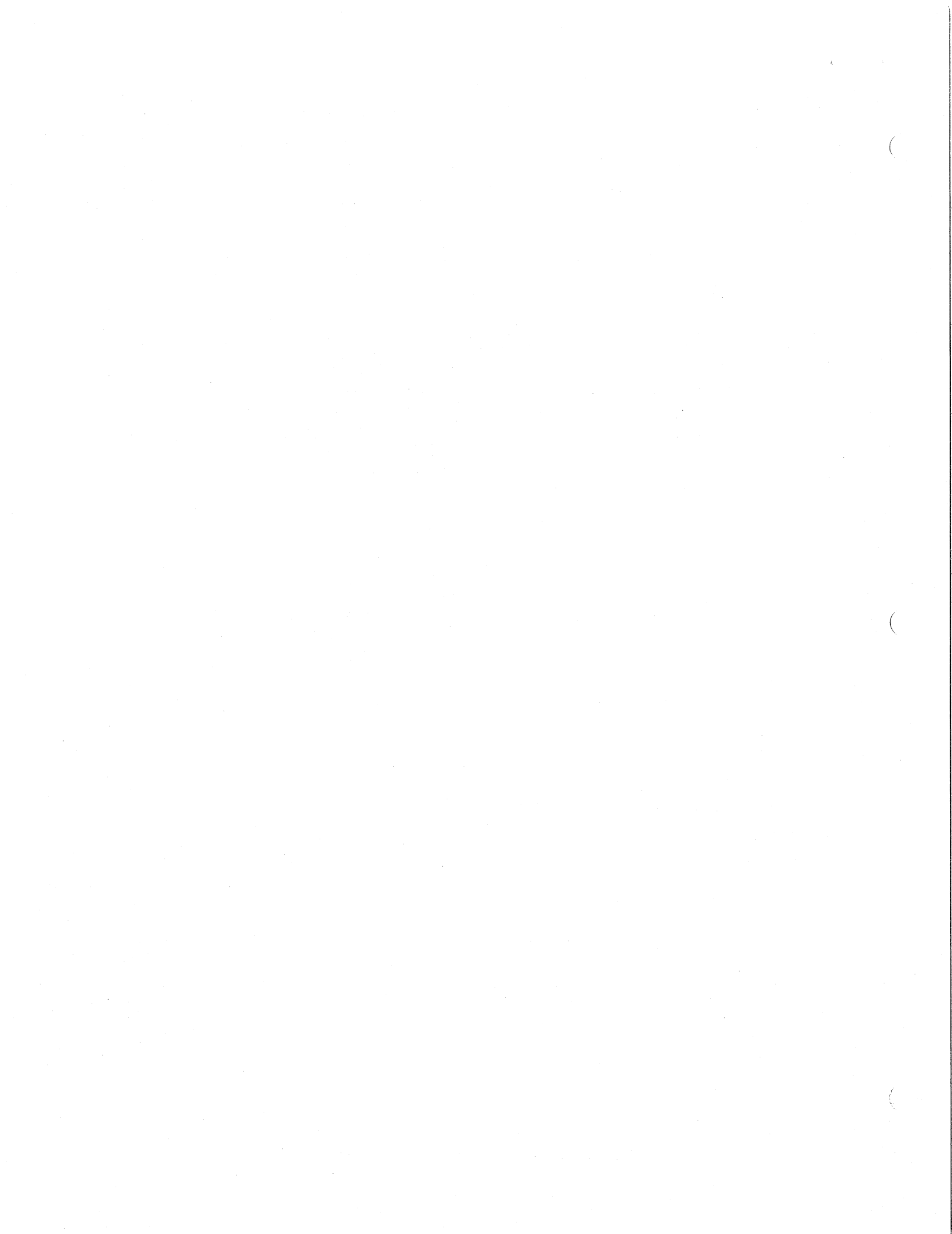

6.4 UNIT SET UP

6.4.1 Step through and verify that the following set up parameters have been properly executed:

6.4.1.1 SELECTING A DRIVE:

- Press Drive Number.

Enter the select code [0] if different from the code shown on the display. If several drives are to be tested, specify the number of the specific drive to be tested.

- Press Enter/Next.
- Press Single Run.

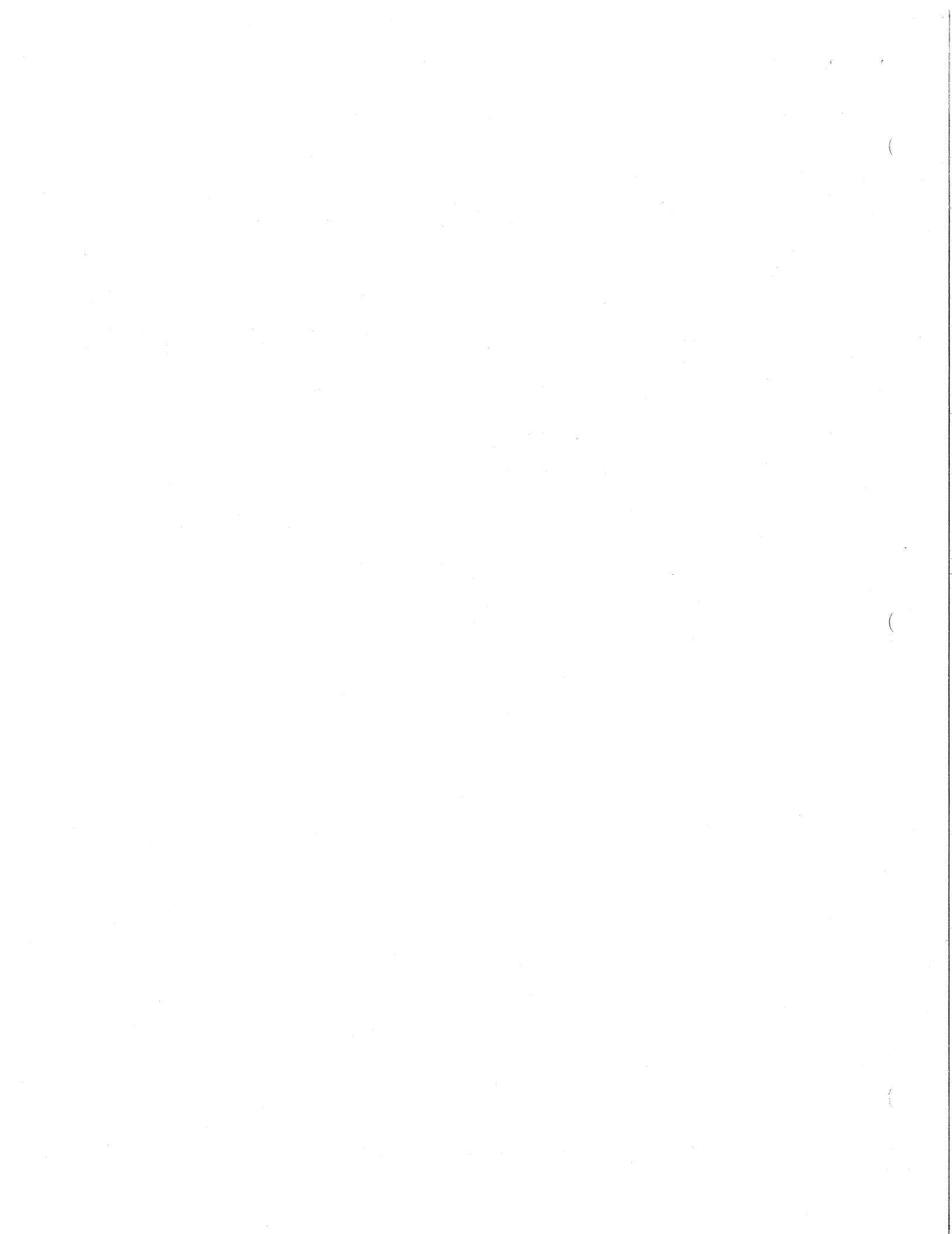

6.4.1.2 CONFIGURING THE MWX-1000:

- Press Drive Config.

Respond to the prompt FIRST HEAD NUMBER by entering the value [0] if different from that code shown on the display.

- Press Enter/Next.

Respond to the prompt LAST HEAD NUMBER by entering the value [7] if different from that code shown on the display.

- Press Enter/Next.

Respond to the prompt FIRST CYL by entering the value [0] if different from the code shown on the display.

- Press Enter/Next.

Respond to the prompt LAST CYL by entering the value [510] if different from the code shown on the display.

CAUTION

CARE MUST BE TAKEN TO ENSURE THAT THE CORRECT VALUE FOR THE FINAL CYLINDER IS INSERTED. THIS IS TO INSURE THAT THE BAD BLOCK INFORMATION LOCATED ON THE LAST (INNERMOST) CYLINDER IS NOT DESTROYED BY THE TESTING PROCESS.

- Press Enter/Next.

Respond to the prompt SOFT/HARD ERROR by entering the value [8] if different from the code shown on the display.

- Press Enter/Next.

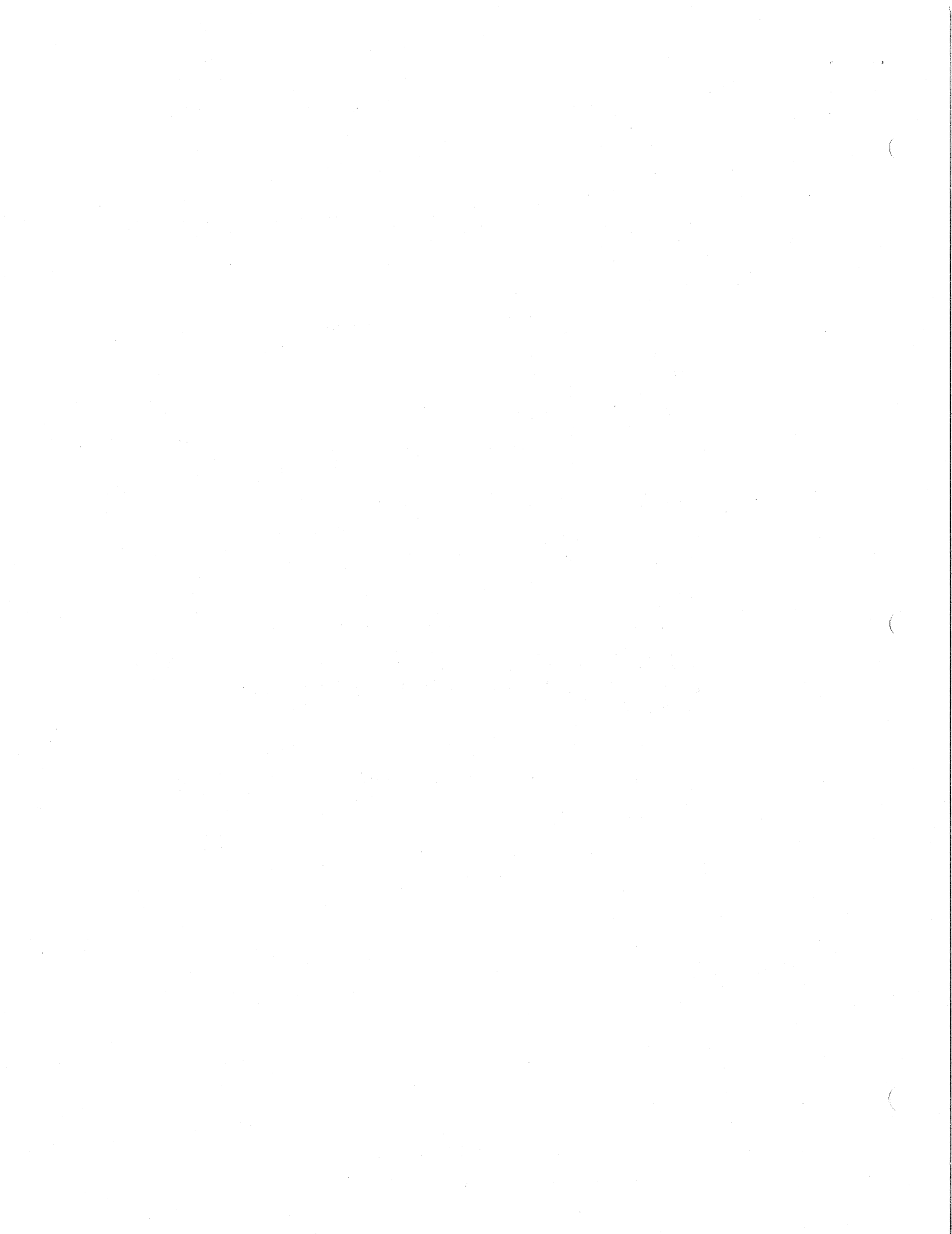

6.4.1.3 SETTING STEP RATE:

- Press Step Rate.

Enter the value [10] if different from the code shown on the display.

- Press Enter/Next.
- Press Single Run.

6.4.1.4 SETTING WRITE PRECOMPENSATION:

- Press Write Precmp.

Respond to the prompt WRT PRECOM with the value YES [1] for write precompensation to be ON if different from the code shown on the display.

- Press Enter/Next.

Respond to the prompt START CYL with the value [256] if different from the code shown on the display.

- Press Enter/Next.
- Press Single Run.

6.4.1.5 SETTING REDUCED WRITE CURRENT:

- Press Special Set.
- Press Enter/Next.

Respond to the prompt REDUCE CUR with the value YES [1] to set it to ON if different from the code shown on the display.

- Press Enter/Next.

Respond to the prompt START CYL with the value [256] if different from the code shown on the display.

- Press Enter/Next.
- Press Single Run.

6.4.1.6 If using the DTS-1000, verify that the small power switch that corresponds to the drive hooked up on the front panel is in the AUTO or ON position.

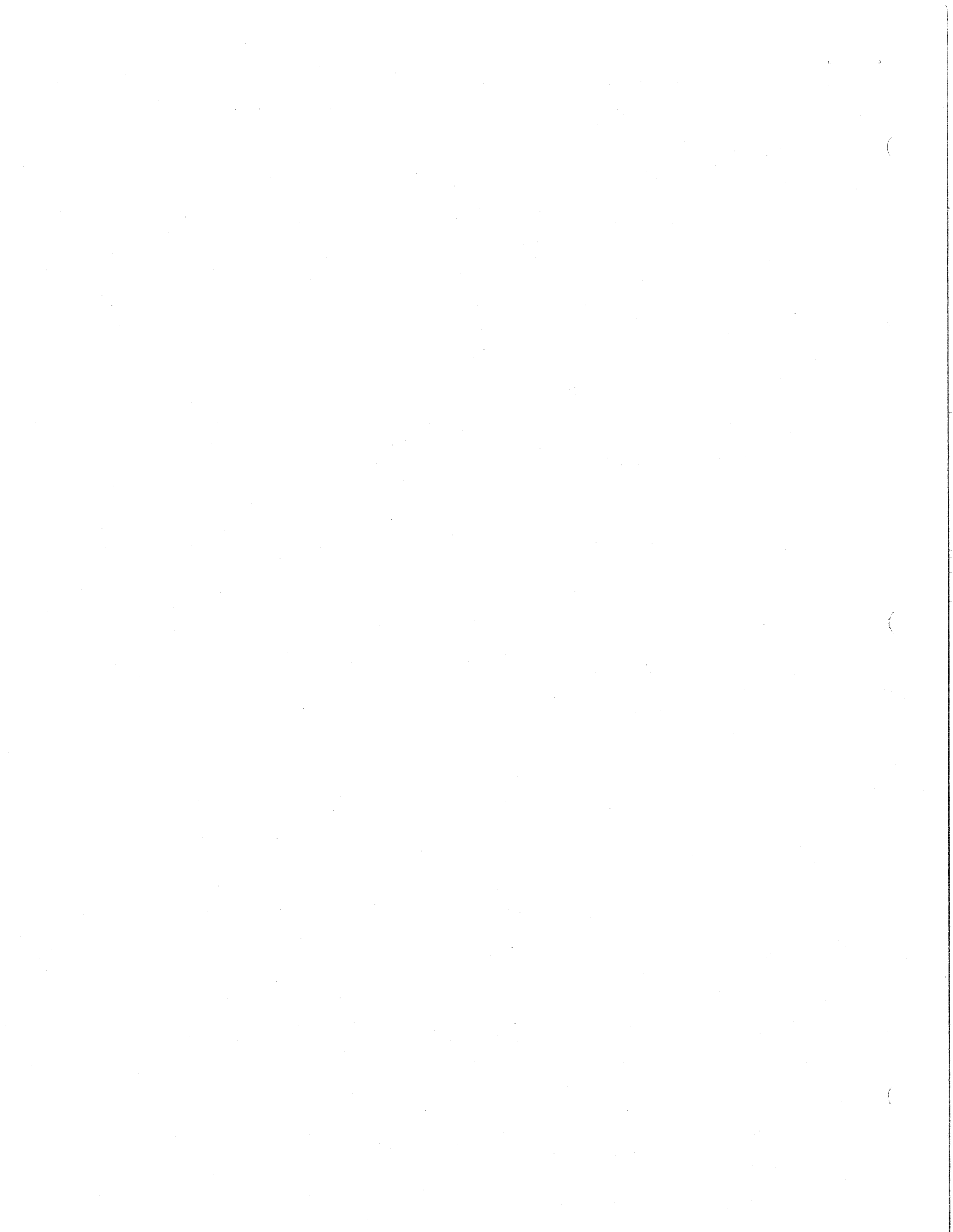

6.5 DEDICATED TESTING - Wilson Winchester Disk Analyzer

6.5.1 Call Special Program 20, an industry standard routine for testing of the Winchester disk drive. Step through and verify the following:

6.5.1.1 Press Special Prog.

Respond to the prompt SPECIAL PROGRAM 0 with the value [0] if different from the code shown on the display.

- Press Enter/Next.

Respond to the prompt NO OF DRIVES 1 with the value corresponding to the number of drives to be tested.

- Press Enter/Next.

Respond to the prompt SERIAL NUMBER with the value corresponding to the serial number of the specific drive to be tested.

- Press Enter/Next

Respond to the prompt SET PARAMETERS YES with the value YES [1] if different from the code shown on the display.

- Press Enter/Next.

Respond to the prompt CHANGE PTRN YES with the value YES [1] if different from the code shown on the display.

- Press Enter/Next.

Respond to the prompt DATA PTRN 6DB6 with the value [6DB6] if different from the code on the display.

- Press Enter/Next.

Respond to the prompt RUN FOREVER NO with the value NO [0] if different from the code shown on the display.

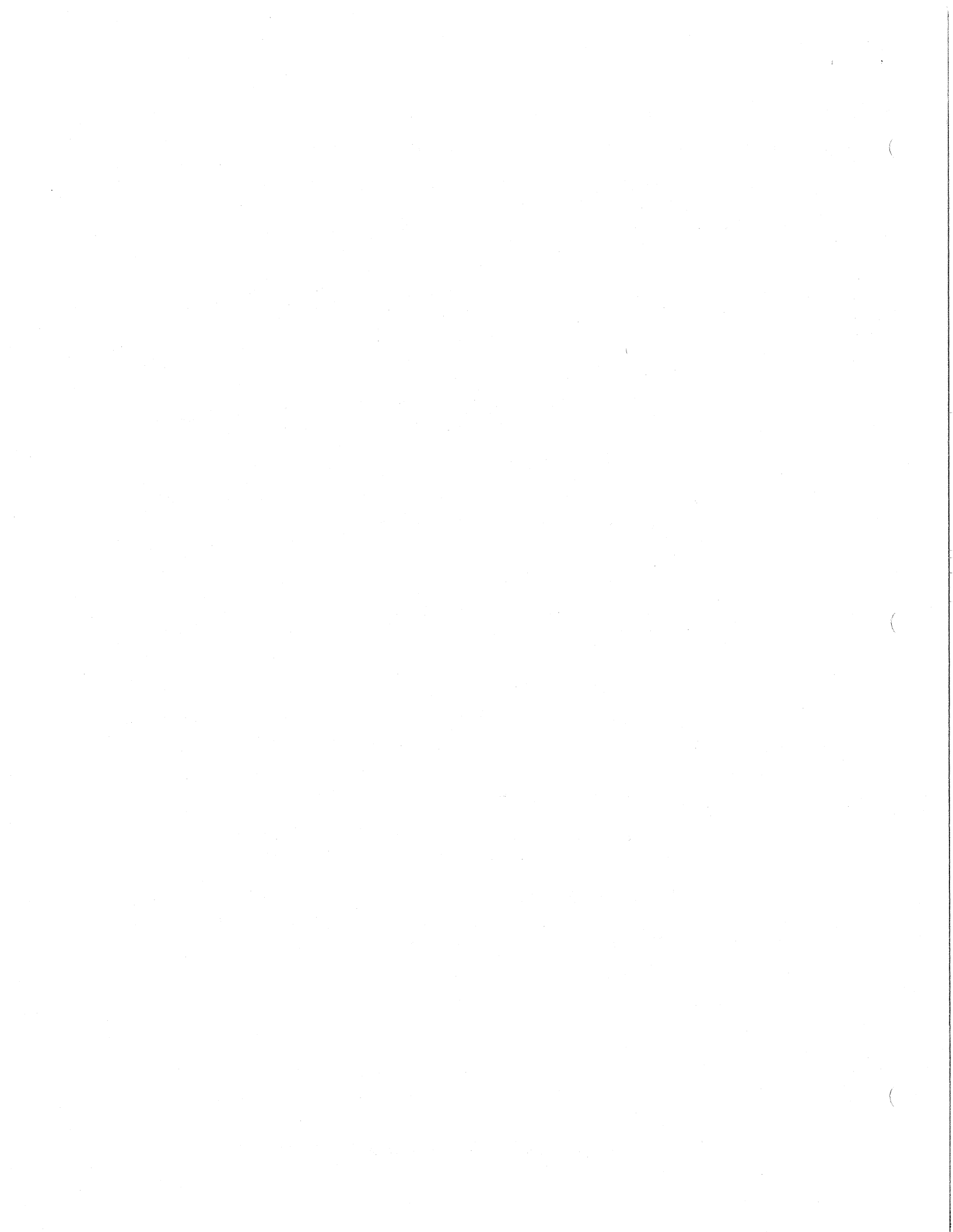

- Press Enter/Next.

Respond to the prompt NO OF RUNS 1 with the value [1]- if different from the code shown on the display.

- Press Enter/Next.

Respond to the prompt ALL TESTS YES with the value NO [0] if different from the code shown on the display.

- Press Enter/Next.

Respond to the prompt TEST NO 0 with the test numbers to be run. Enter the values [1],[2],[3],[4],[6] and [7], each followed by pressing Enter/Next.

- Press Enter/Next

The display will show DO TEST 123467.

The display will then step through and stop to verify the prompt FIRST HEAD NO 0.

- Press Enter/Next.

The display will then stop to verify the prompt LAST HEAD NO 7.

- Press Enter/Next.

The display will then stop to verify the prompt FIRST CYL 0.

- Press Enter/Next.

The display will then stop to verify the prompt LAST CYL 510.

- Press Enter/Next.

6.5.2 The analyzer should now start and run through a series of six tests. When the testing is complete consult the Troubleshooting section 6.6.

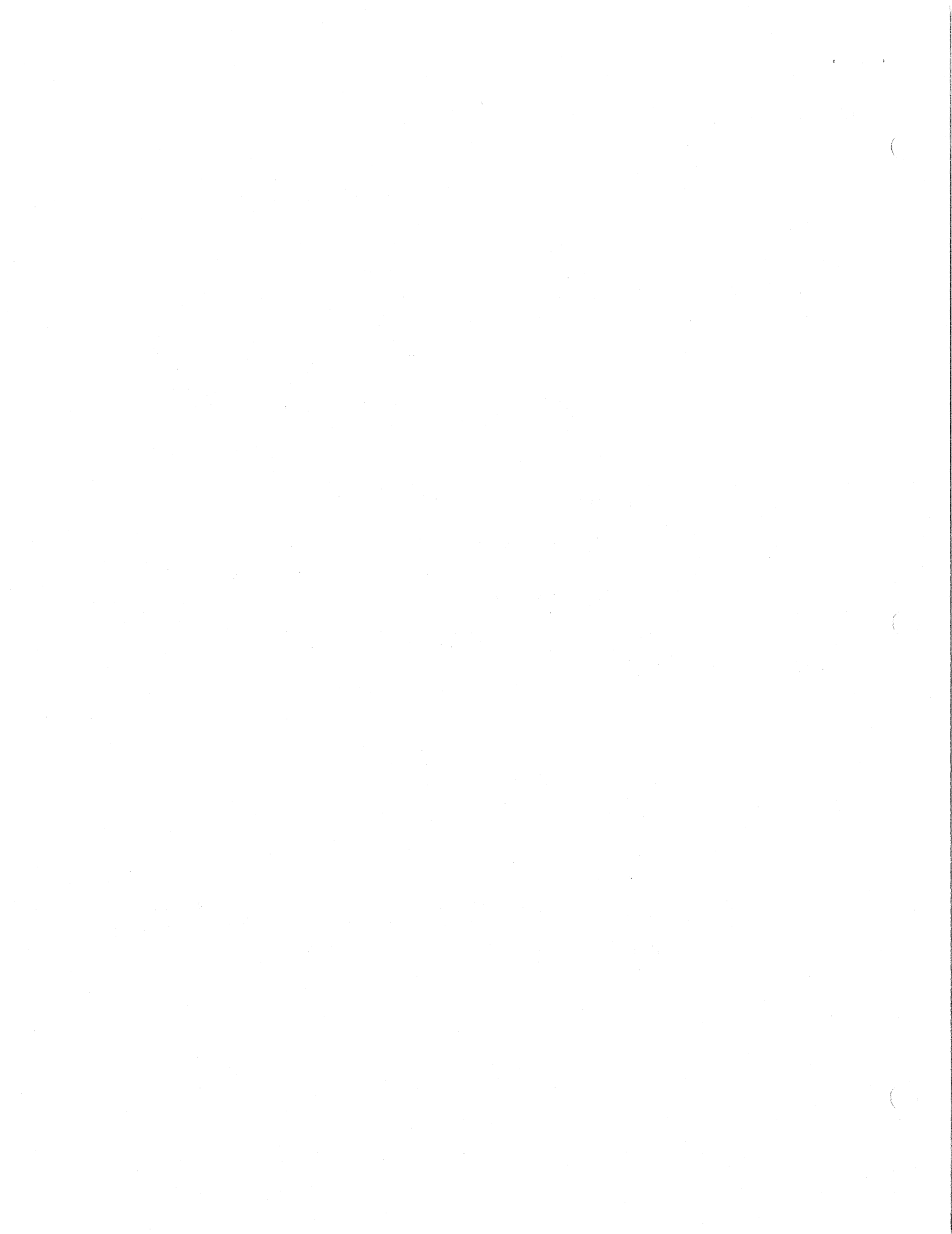

6.6 TROUBLESHOOTING

This section provides a Troubleshooting Flowchart and a Fault Isolation Table to be used in locating a fault in the RD52-A Winchester Drive to its Field Replaceable Units (FRUs). Compare the hard copy print out from the Wilson Tester with the Fault Isolation Table limits to locate all faults. Use the Troubleshooting Flowchart as a procedure for determining which FRUs to replace and what to do next. The actual procedure for removing and replacing FRUs is outlined in Section 6.7.

NOTE

Remember that replacement FRUs can also be defective.

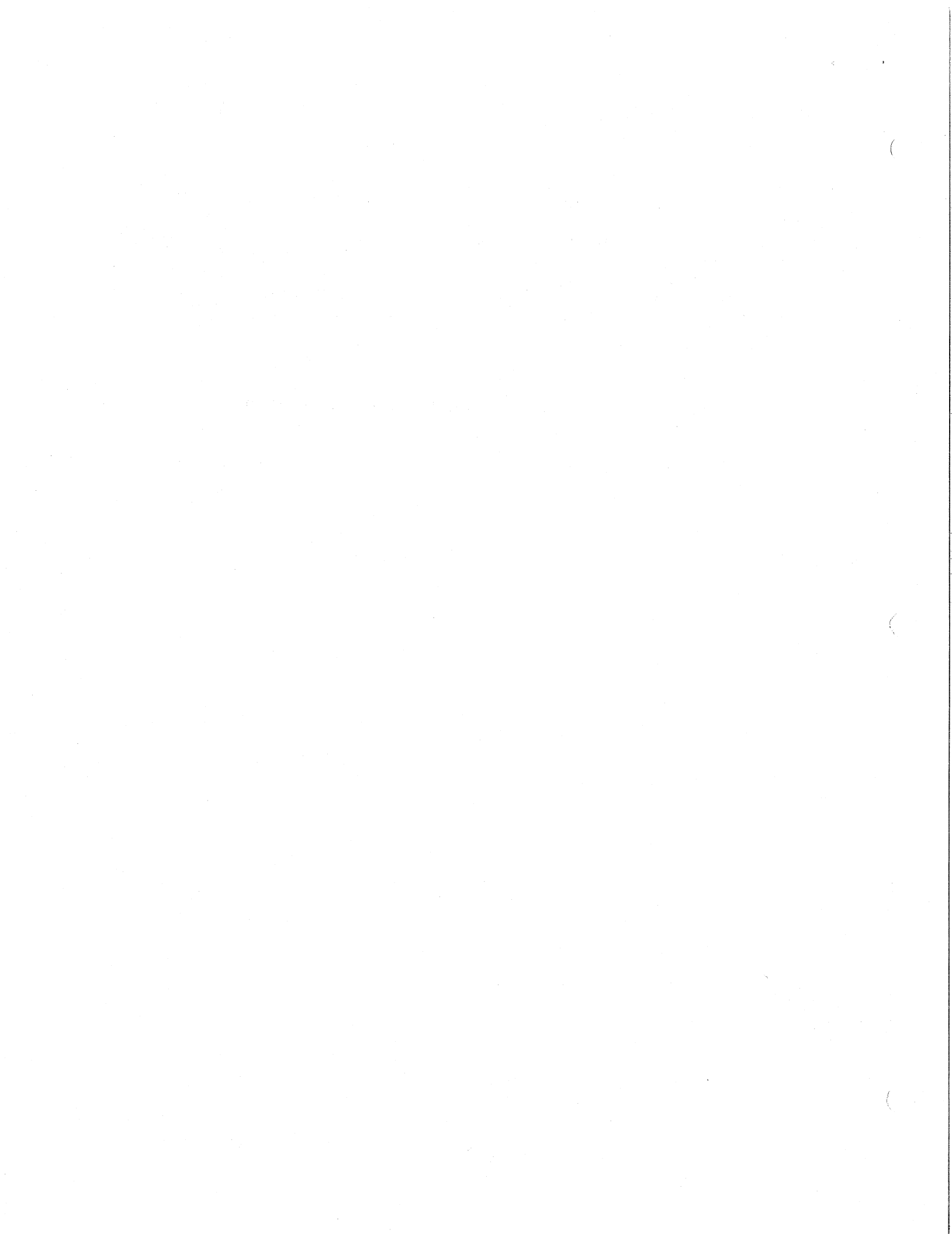
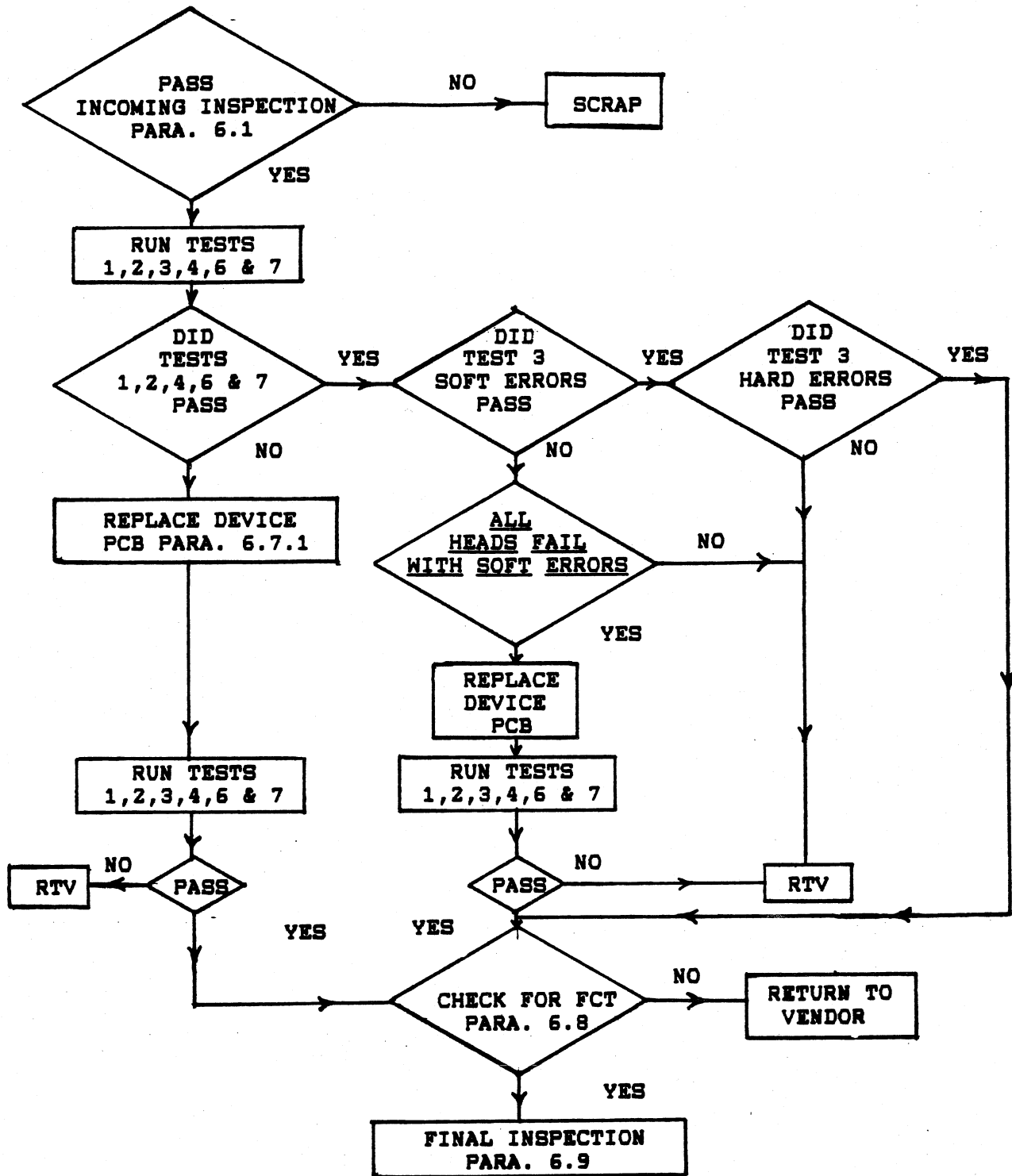

Figure 6.4 Troubleshooting Flowchart



6.6.1 FAULT ISOLATION TABLE - Wilson MWX-1000 Disk Analyzer

6.6.1.1 # TEST NAME LIMIT TEST FAILS

1 BASIC DRIVE VERIFY

Unit Select	Pass/Fail	
Drive Fault	Pass/Fail	
Drive Ready	Pass/Fail	
Seek Complete	Pass/Fail	Refer to
Index	Pass/Fail	Figure 6-4
Trk 000 tests	Pass/Fail	
Basic Write/Read	Pass/Fail	
Rotation Time	16.84 to 17.17 ms	

Test Status Summary

Total Soft Errors	4	
Total Hard Errors	**	Refer to
Total Format Errors	**	Figure 6-4
Total Step Errors	0	

** For RD52, 40 hard/format errors with no more than 10 hard/format errors per surface.

6.6.1.2 # TEST LIMIT TEST FAILS

2 INNER TRACK ACCESS TEST

Test Status Summary

Total Soft Errors	4	
Total Hard Errors	**	Refer to
Total Format Errors	**	Figure 6-4
Total Step Errors	0	

** For RD52, 40 hard/format errors with no more than 10 hard/format errors per surface.

6.6.1.3 # TEST NAME LIMIT TEST FAILS

3 MEDIA VERIFY

Early/Late Strobe

14 NSEC

Verify Tester
Set Up

Test Status Summary

Total Soft Errors	4	
Total Hard Errors	**	See Para.
Total Format Errors	**	6.6.1.7
Total Step Errors	0	

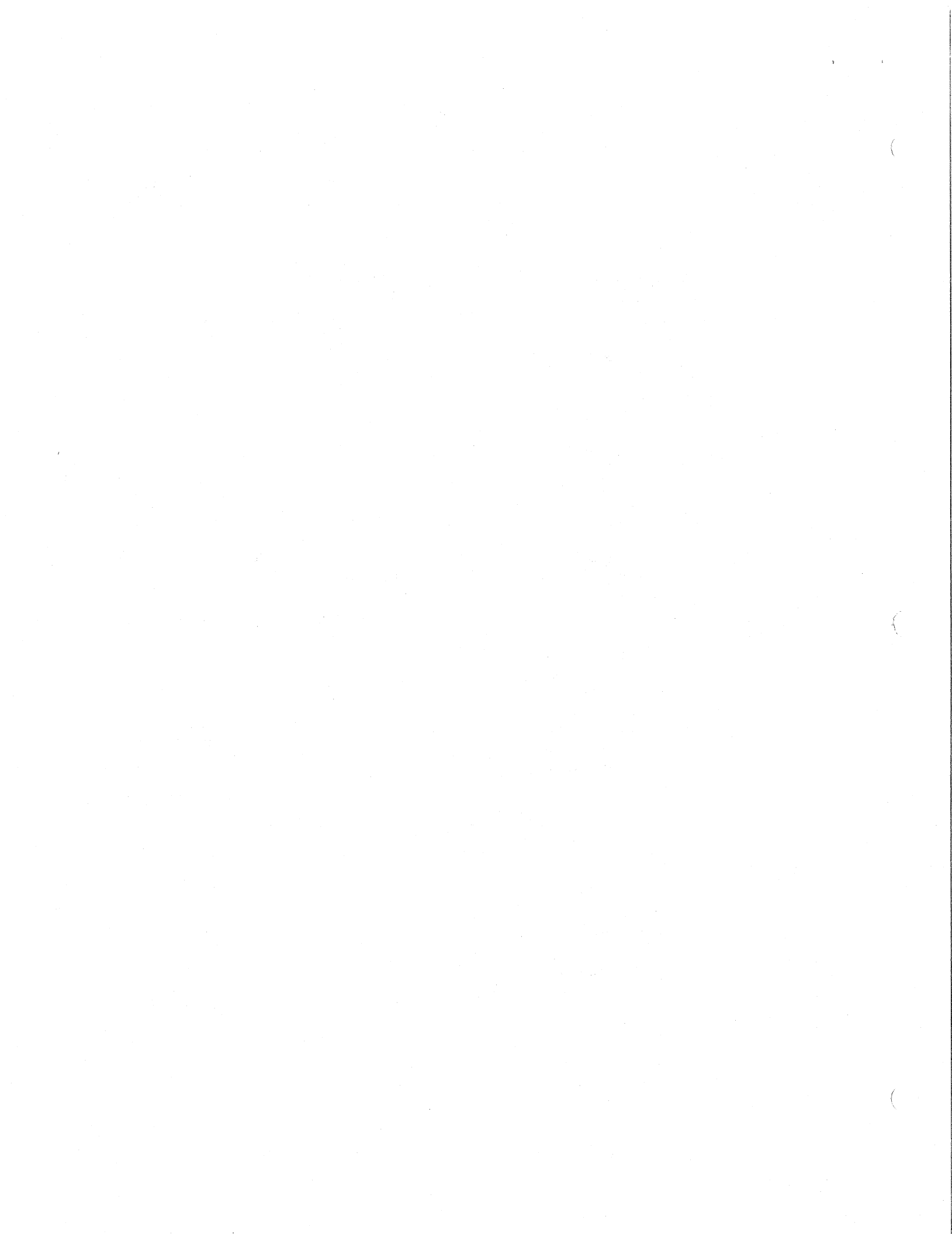

** For RD52, 40 hard/format errors with no more than 10 hard/format errors per surface.

NOTE

Test 3 makes six passes before printing the Test Status Summary. The totals printed in the summary include all six passes.

6.6.1.4 #	<u>TEST NAME</u>	<u>LIMIT</u>	<u>TEST FAILS</u>
4	STEP & VERIFY		
	Early/Late Strobe	14 NSEC	Verify Tester Set Up
	Test Status Summary		
	Total Soft	4	
	Errors Total Hard Errors	**	Refer to
	Total Format Errors	**	Figure 6-4
	Total Step Errors	0	

** For RD52, 40 hard/format errors with no more than 10 hard/format errors per surface.

6.6.1.5 #	<u>TEST NAME</u>	<u>LIMIT</u>	<u>TEST FAILS</u>
6	MARGIN TEST (OUTER 5 CYLINDERS)	Pass/Fail	Refer to Figure 6-4
	Test Status Summary		
	Total Soft Errors	4	
	Total Hard Errors	**	Refer to
	Total Format Errors	**	Figure 6-4
	Total Step Errors	0	

** For RD52, 40 hard/format errors with no more than 10 hard/format errors per surface.

6.6.1.6 #	<u>TEST NAME</u>	<u>LIMIT</u>	<u>TEST FAILS</u>
7	MARGIN TEST (INNER 5 CYLINDERS)	Pass/Fail	Refer to Figure 6-4
	Test Status Summary		
	Total Soft Errors	4	
	Total Hard Errors	**	Refer to
	Total Format Errors	**	Figure 6-4
	Total Step Errors	0	

** For RD52, 40 hard/format errors with no more than 10 hard/format errors per surface.

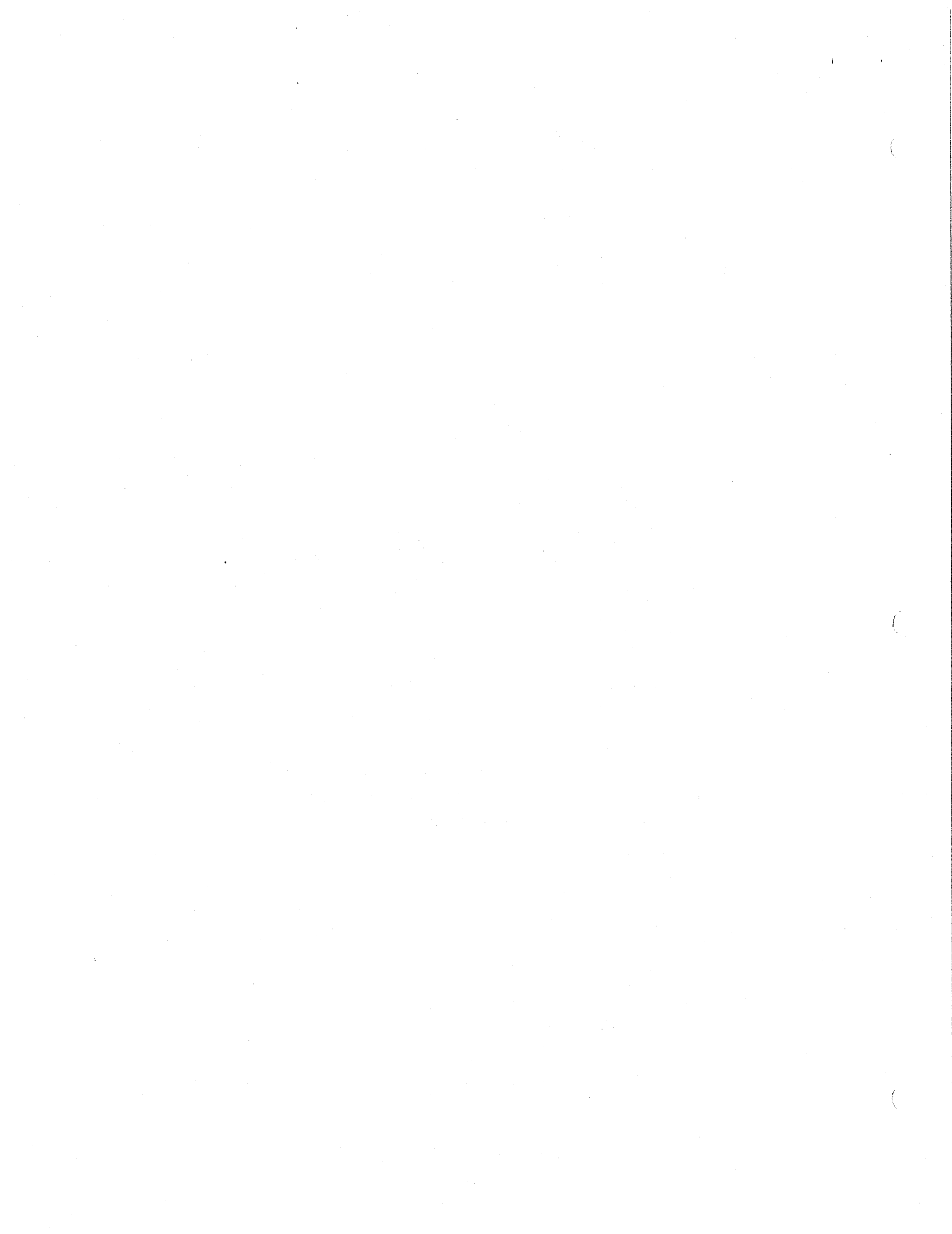

6.6.1.7

TEST NAME

LIMIT

TEST FAILS

BAD TRACK SUMMARY

Total Hard Errors
Total Soft Errors
Total Firm Errors

**

**

Refer to
Figure 6-4

** For RD52, 40 hard/firm errors with no more than 10 hard/firm errors per surface.

*** Total Soft Errors must not exceed 4.

NOTE

All soft errors located in the Bad Track Summary of the test printout must be compared to the list of defects found on the outside of the drive. If a soft error has the same head, cylinder and byte (+or- 10) as a defect in that list, then that error has already been mapped off in the drive FCT and should not be counted as a soft error.

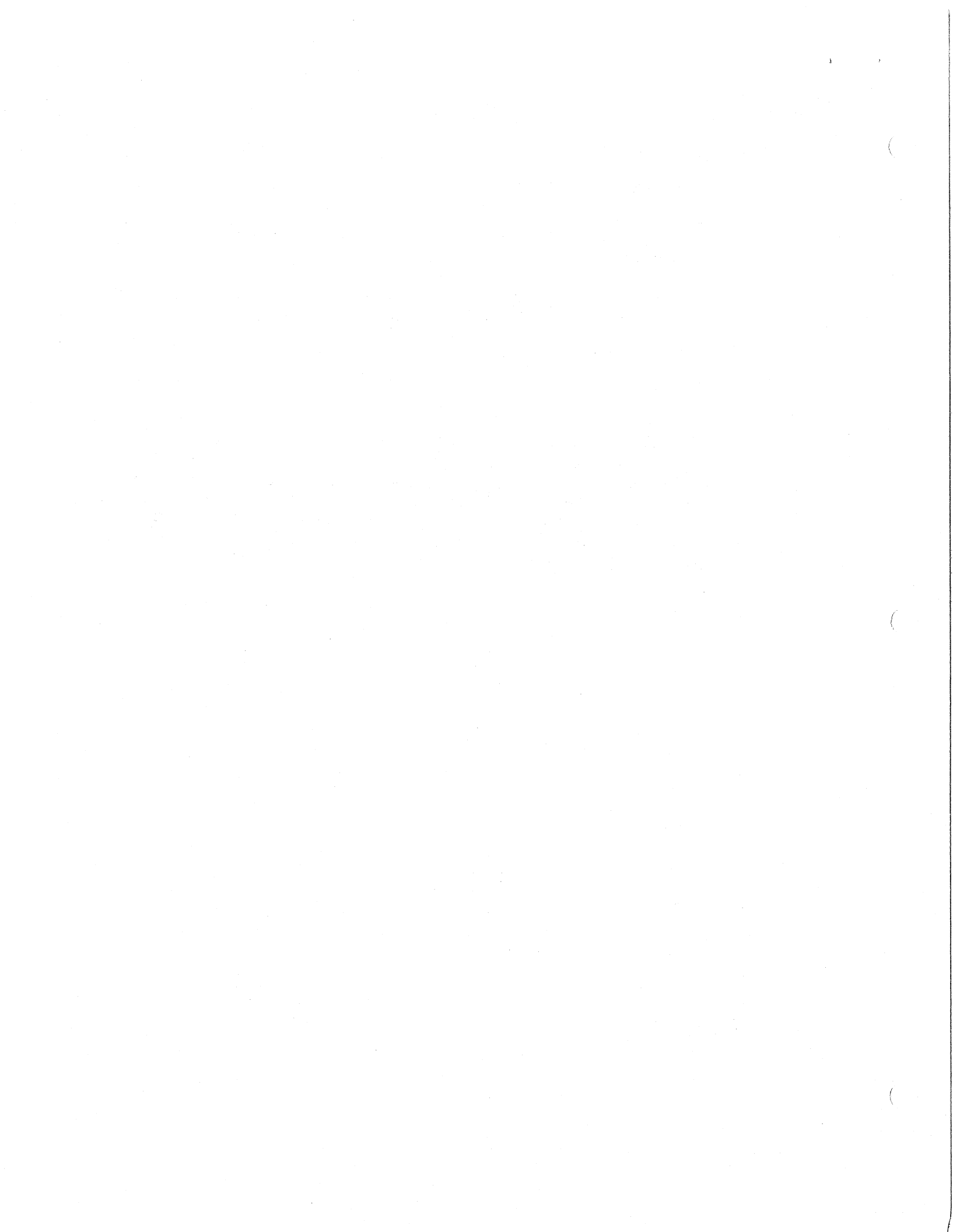

6.6.1.7

<u>TEST NAME</u>	<u>LIMIT</u>	<u>TEST FAILS</u>
BAD TRACK SUMMARY		
Total Hard Errors	**	Refer to
Total Soft Errors	***	Figure 6-4
Total Firm Errors	**	

** For RD52, 40 hard/firm errors with no more than 10 hard/firm errors per surface.

*** Total Soft Errors must not exceed 4.

NOTE

All soft errors located in the Bad Track Summary of the test printout must be compared to the list of defects found on the outside of the drive. If a soft error has the same head, cylinder and byte (+or- 10) as a defect in that list, then that error has already been mapped off in the drive FCT and should not be counted as a soft error.

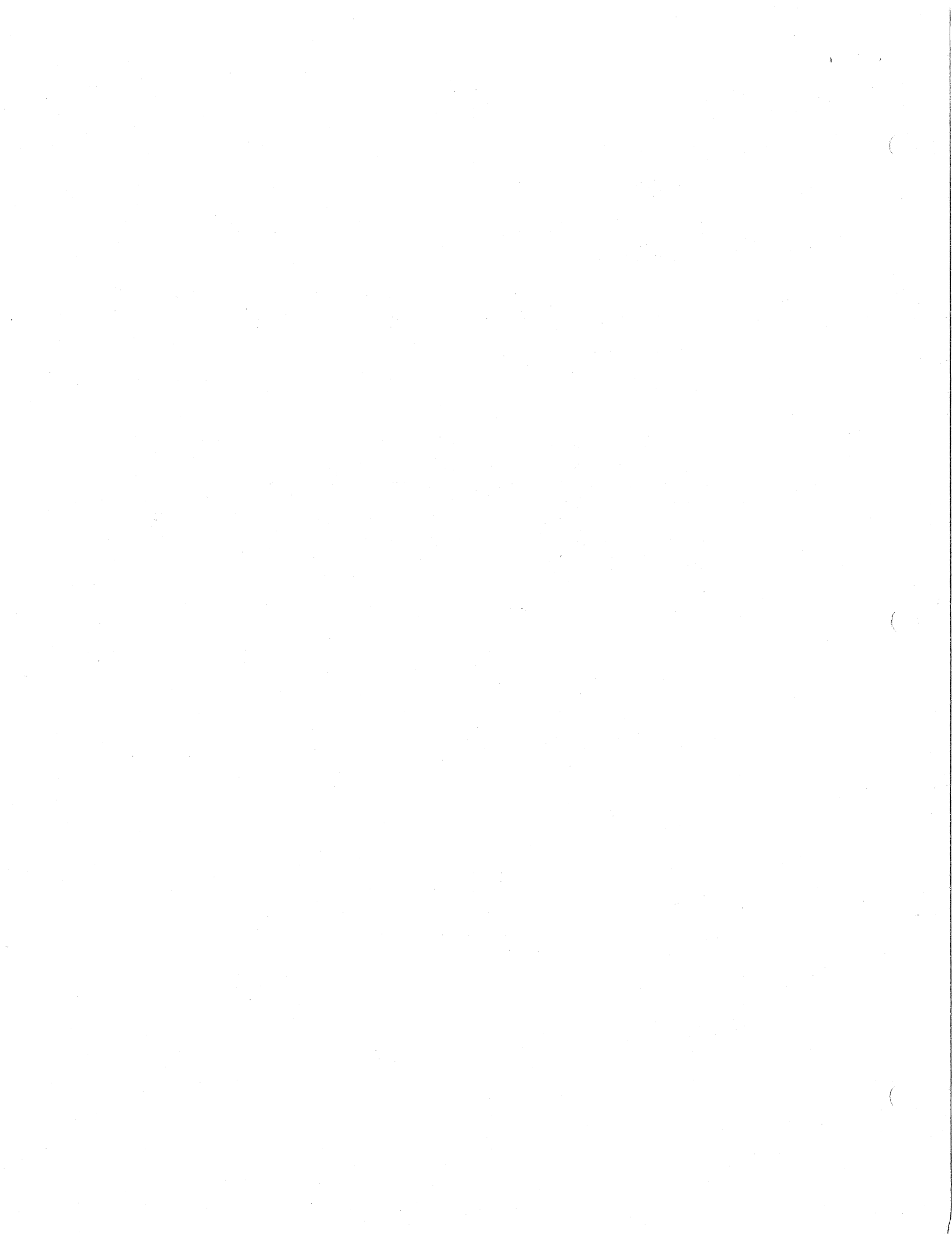

6.7 REMOVAL AND REPLACEMENT

This section provides a detailed removal and replacement procedure for each of the Field Replaceable Units (FRUs) found in the RD52-A Winchester Disk Drive. Make sure the power to the drive is turned off before beginning.

NOTE

Screws located on the Device PCB are different sizes. Make sure you reinstall the screws in their proper location.

CAUTION

The connectors and cables are fragile and require proper handling to avoid damage.

6.7.1 DEVICE PCB

- 6.7.1.1 Disconnect the Wilson Disk Analyzer interface and power cables from the drive to be repaired.
- 6.7.1.2 Carefully turn the drive over. Detach the slide plate from the drive by removing the four phillip screws that hold it in place. Some drives might not have the slide plate, ground clip and mounting screws attached.
- 6.7.1.3 Remove the two phillip screws that attach the Front Bezel to the drive. Disconnect the front bezel LED 2-pin connector from the Device PCB.

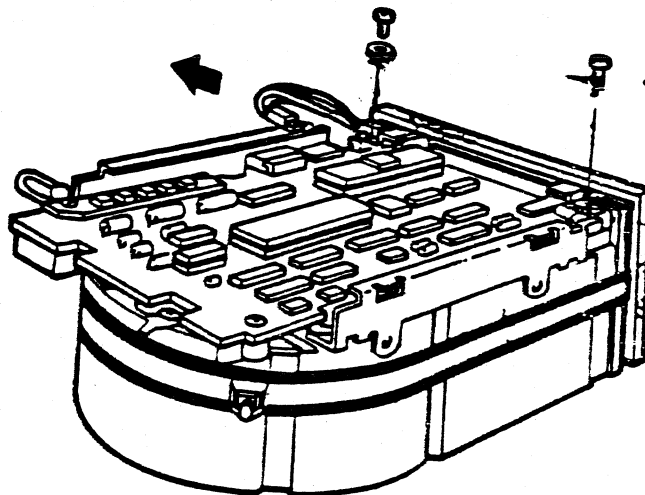
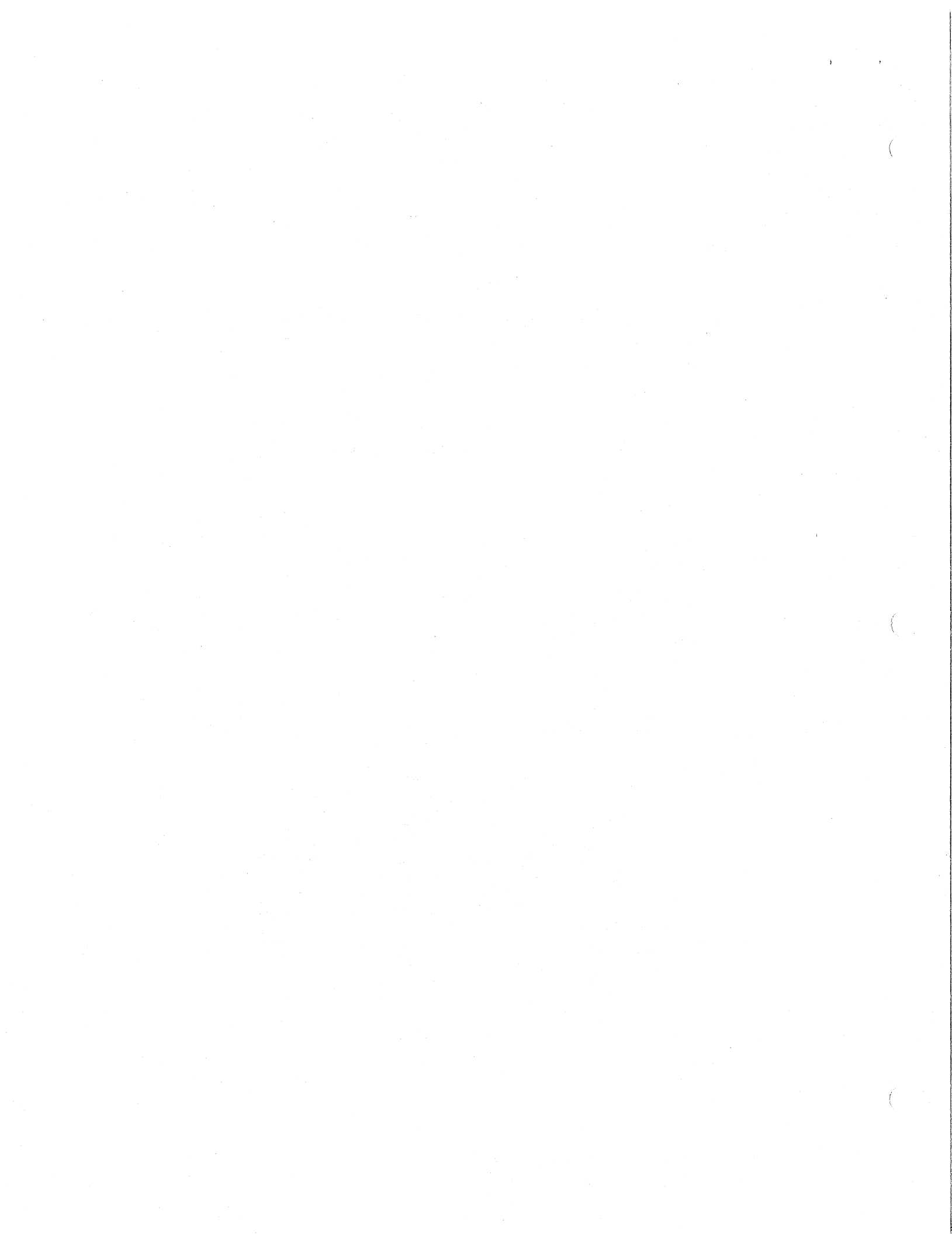

Figure 6.5 Bezel screws and 2-pin connector removal.



- 6.7.1.4 Remove the Front Bezel by pulling it away from the drive. The bezel is held in place by two pop fasteners.

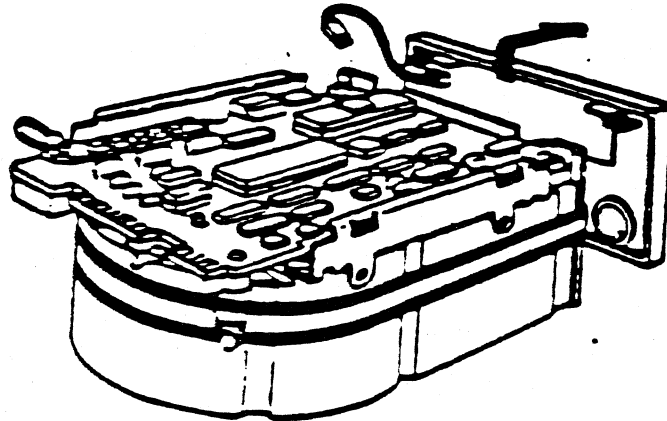

Figure 6.6 Front Bezel removal.

- 6.7.1.5 Remove the three screws from the heat sink, grounding strip and corner opposite the heat sink. These are the screws which hold the Device PCB in place.

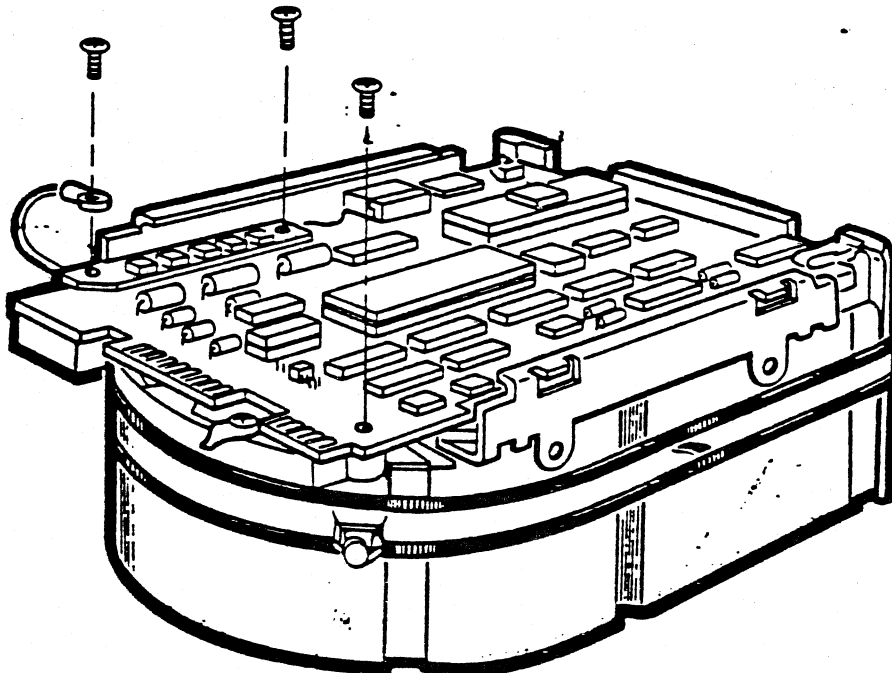
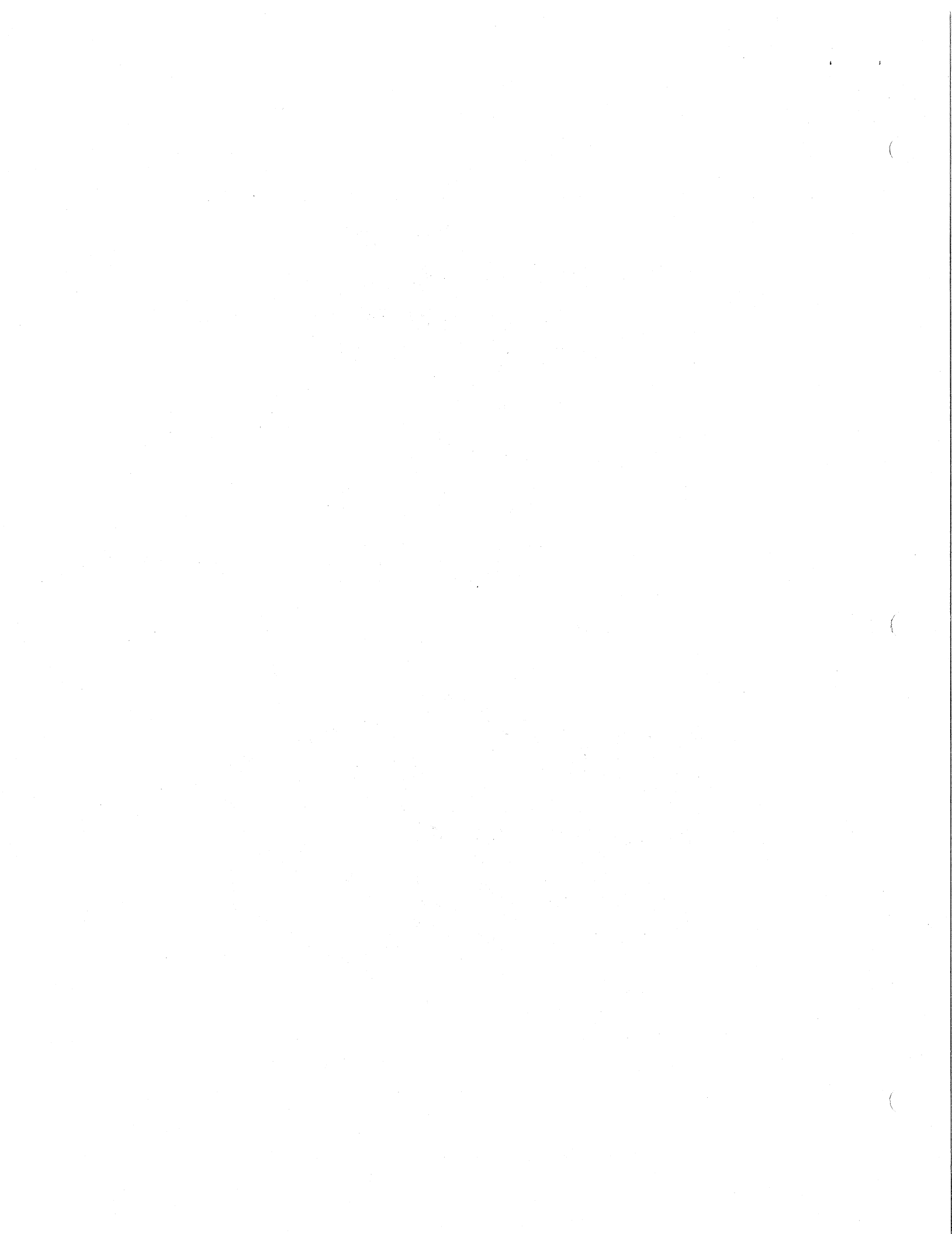

Figure 6.7 Device PCB screws removal.



- 6.7.1.6 Gently lift the Device PCB straight up until it clears the chassis and disconnects the 12 pin connector P4.
- 6.7.1.7 Disconnect the 10-pin connector P5.

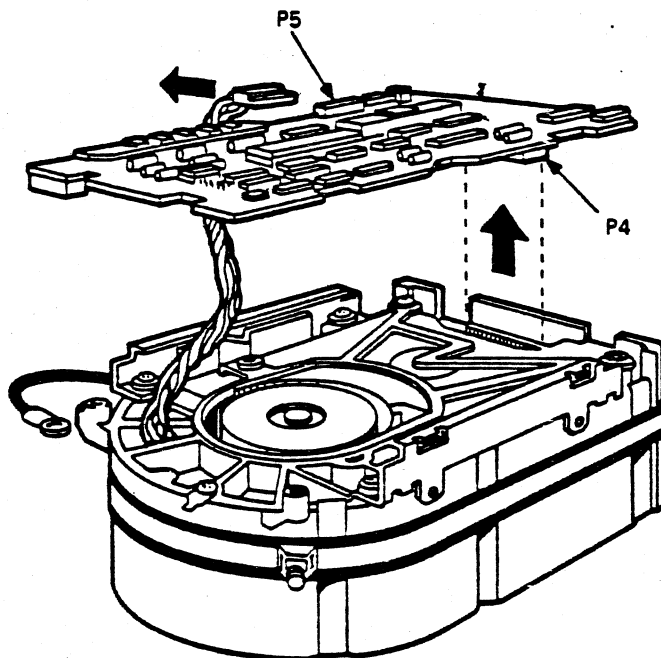
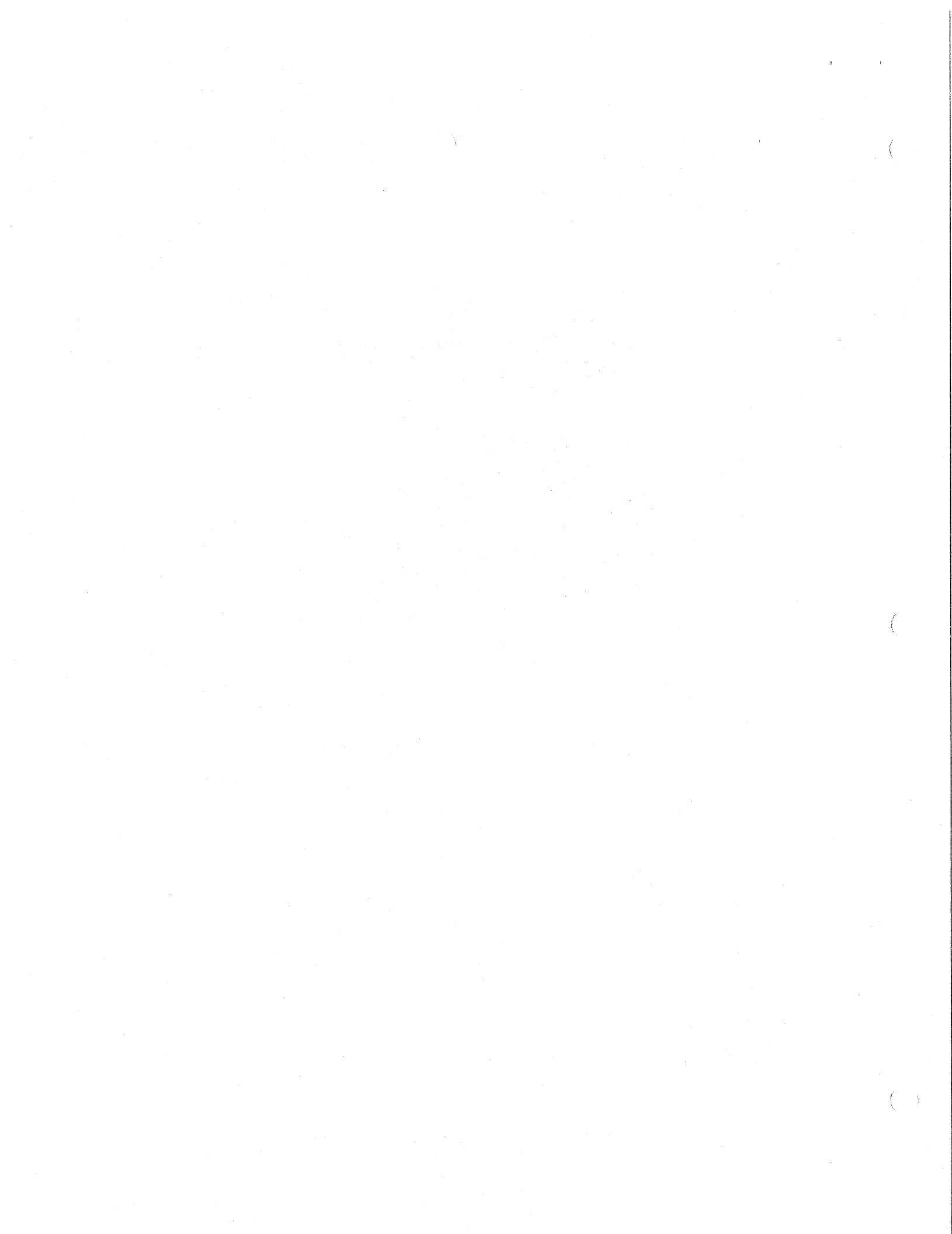

Figure 6.8 Device PCB removal.

- 6.7.1.8 Make sure the drive select jumper is in place over the DS1 pins on the replacement module.
- 6.7.1.9 Replace the Device PCB and install the new module by reversing the above procedure.



6.8 FCT CHECK

Once the RD52-A drive has been passed by the Wilson Analyzer it will then need to be checked to make sure the FCT (Factory Control Table) is located on the last cylinder.

6.8.1 SET UP

- 6.8.1.1 Set up the PRO 350/380 test station. This station should include the PRO system box, LK201 keyboard, and VR201 terminal.
- 6.8.1.2 Slide the RD52-A drive to be checked into place beside the RX50 diskette drive and connect the drive to the PRO hard disk interface cables.
- 6.8.1.3 Insert the RDXX FCT CHECK (K-TP-RDFCT-XX-W000) diskette into drive 0. Turn the system power on and close the drive 0 door.

6.8.2 PROCEDURE

The system will go through a series of internal self tests before booting directly into the FCT CHECK program. The terminal screen will then display a user friendly menu.

- 6.8.2.1 At the prompt "Enter Choice (1-3) >" type 2, then press <Return>.
- 6.8.2.2 At the prompt "Please enter serial number (10 digits maximum) >>>" type the drive serial number, then press <Return>.

6.8.3 VALID FCT

If a valid FCT is found, the following message will appear on your screen:

THE DRIVE HAS A VALID FCT

- 6.8.3.1 At the prompt "Do you want to display the FCT information?" type Y, then press <Return>.
- 6.8.3.2 At the prompt "Do you want hard copy of FCT?" type N, then press <Return>.

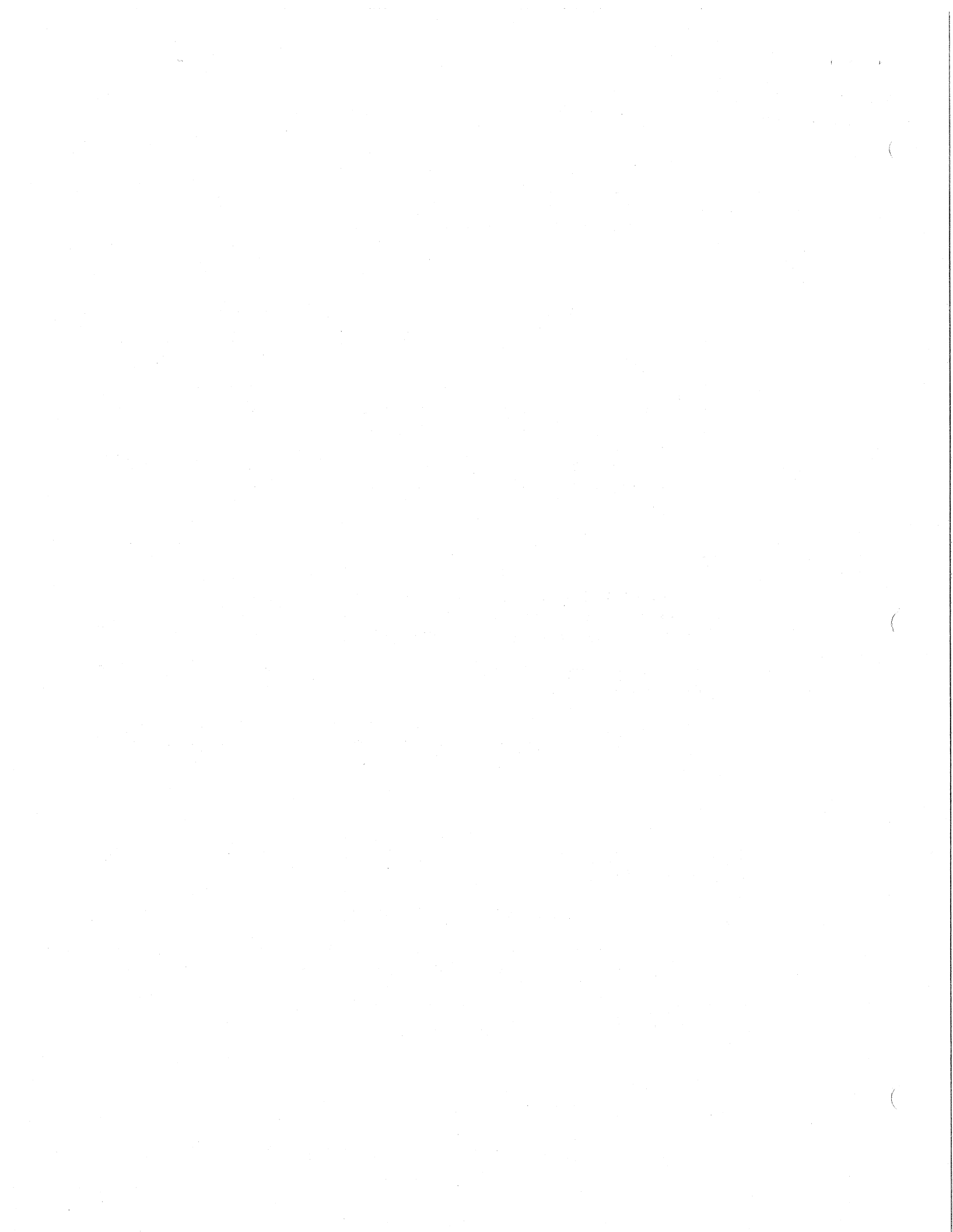

- 6.8.3.3 Verify the FCT by comparing the information on your screen with that found on the top of the RD52-A drive.
 - 6.8.3.4 At the RT11 prompt "." turn the system power off. Return to step 6.8.1.2 when you wish to check the FCT of the next drive.
 - 6.8.3.5 Check for a Repair History Label on unit and mark as appropriate. If none is present, add one and mark.
- 6.8.4 INVALID FCT

If an invalid FCT is found, the following message will appear on your screen:

FCT IS CORRUPTED OR NOT ON DRIVE

NOTE

The occurrence of a corrupted or missing FCT should be minimal.

- 6.8.4.1 If the invalid FCT message appears, ensure that the correct drive type was chosen and that all drive interface cables are connected properly.
- 6.8.4.2 Perform the following steps, if the incorrect drive type was selected or the cables were connected improperly:
 - At the RT11 prompt "." type "FCTCHK", then press <Return>.
 - Return to step 6.8.2.1 and repeat procedure.
- 6.8.4.3 After the RD52-A drive has been determined to have a corrupt or missing FCT, return the drive to the appropriate vendor.

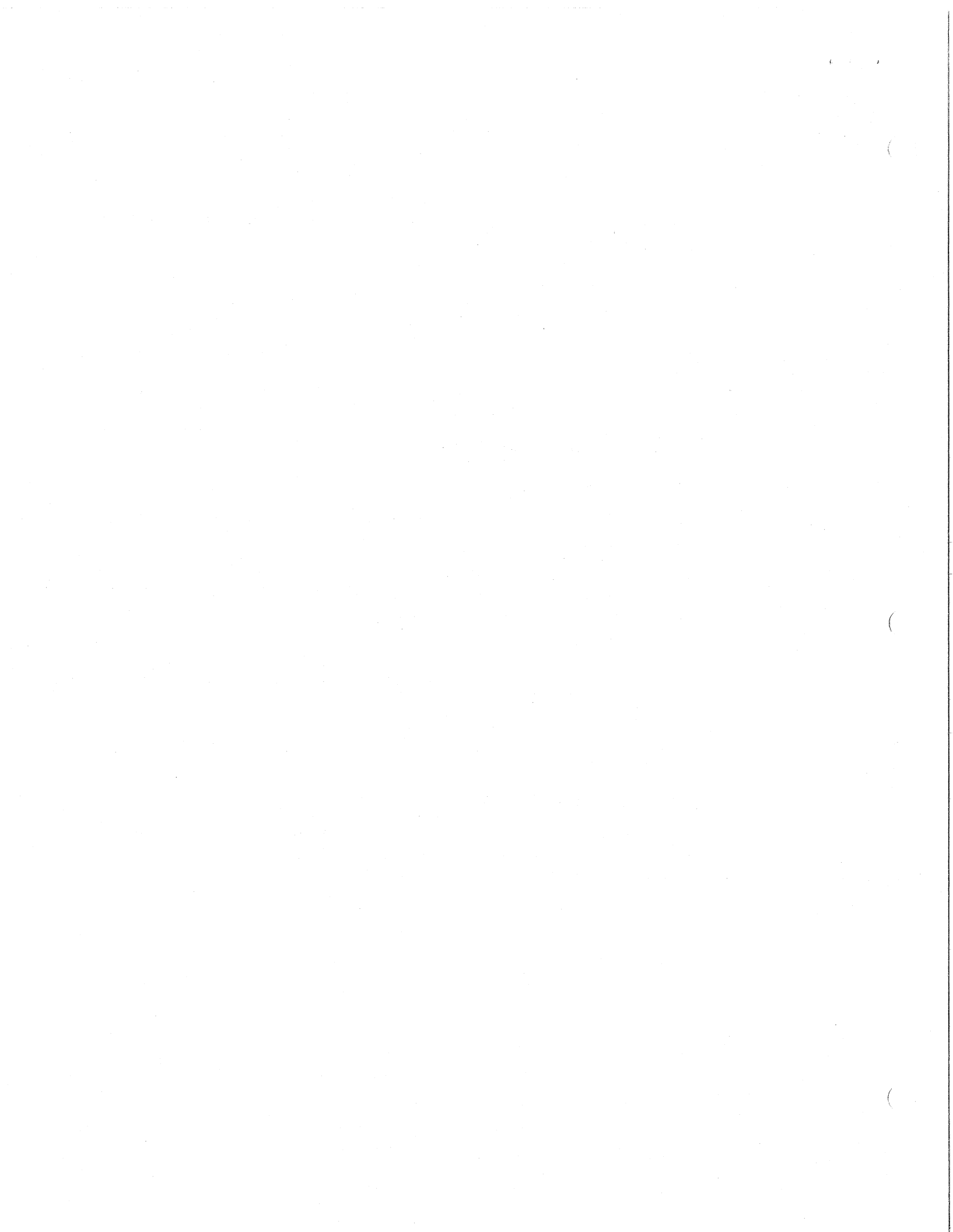

6.9 FINAL INSPECTION

After the RD52-A Disk Drive has been repaired, it is now ready for final inspection. First, disconnect all power and interface cables from the RD52-A. Make sure all internal cables are connected and that the Device PCB is secured in place by the four mounting screws. Reattach the slide plate that was removed at the start of testing. Visually inspect the drive for any obvious physical damage. Place the drive back into its original or DEC approved packaging.

NOTE

The slide plate, ground clip and mounting screws must be added to all drives that are missing these parts before it is repackaged and shipped to its authorized stockroom. All drives that are to be returned to the vendor for repair must also have these parts attached.

6.10 DEC STD 101 ENVELOPE

Obtain a DEC STD 101 Envelope, one per each container of RD52's. Put the test read-out papers for those drives in the envelope. Mark the serial numbers of those drives in the open area next to the instructions. Fill in line 1, Item, with the drive type (RD52-A). Fill in line 2, DEC NO, with the lot number. Initial and Date both lines 5 and 10.

6.11 PACKAGING

For complete packaging instructions refer to CSL Document A-PG-3700916-03-W000.

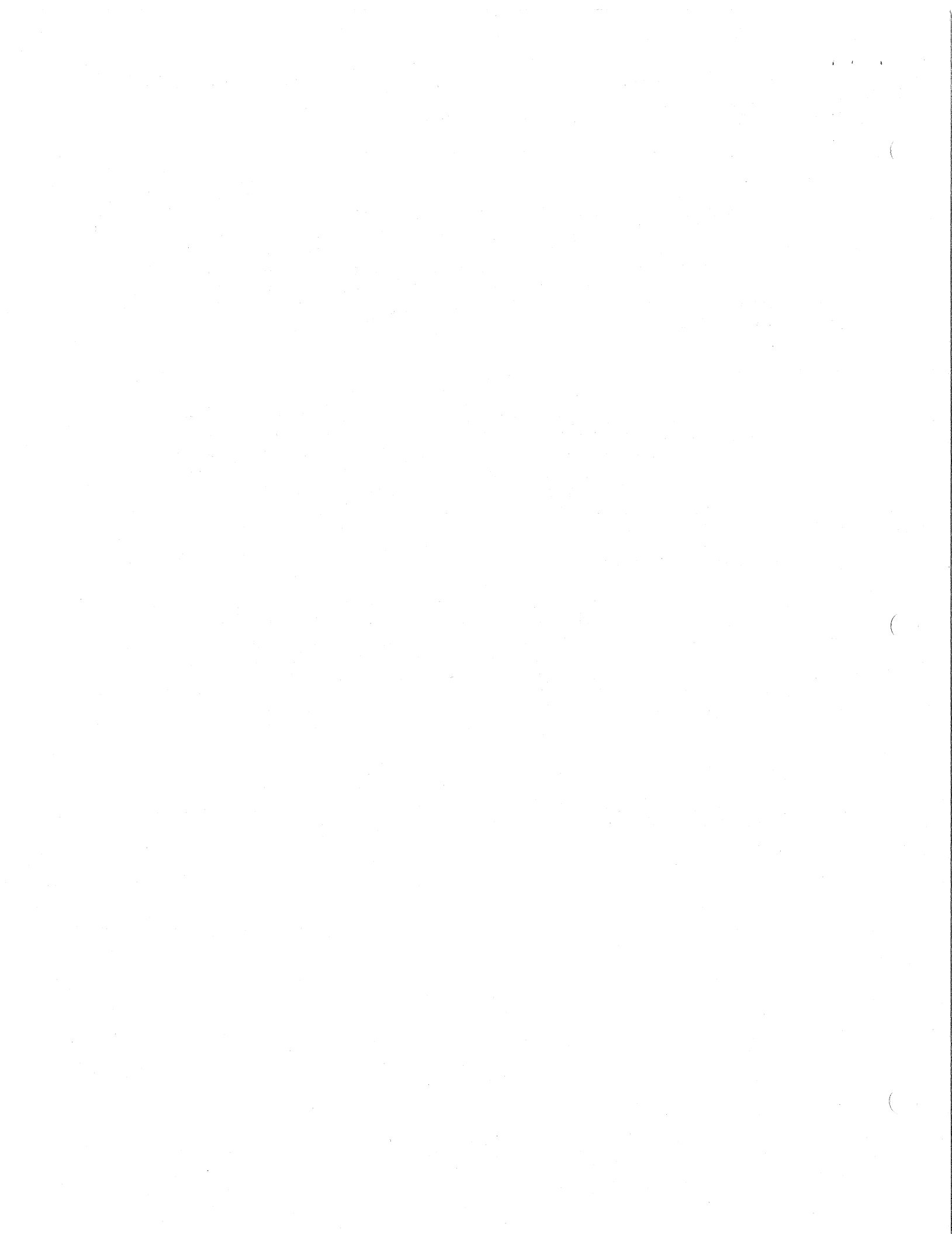

7.0 APPENDICES

7.1 ECOS/FCOs

There are no ECO's or FCO's against this device at the time of this writing.



7.2 DECENTRALIZATION REQUIREMENTS

The following are the decentralization requirements for the RD31-A Winchester Disk Drive.

Power Requirements

The MXW-1000 uses a standard AC power plug. Its requirements are:

100, 115/120 or 200/215/230/240 VAC
50/60 Hertz
1.2 Amp @ 115 VAC
0.6 Amp @ 220 VAC

The DTS-1000 uses a standard AC power plug. Its requirements are:

100, 115/120 or 200/215/230/240 VAC
50/60 Hertz
4.0 Amp @ 115 VAC
2.0 Amp @ 220 VAC

7.3 TORQUE SPECIFICATIONS

<u>QTY</u>	<u>FASTENER</u>	<u>TORQUE (IN-LBS)</u>
4	Skid Plate	9.0
4	Module	5.0



8.0 COMMENTS AND FEEDBACK

8.1 Literature Comment Form

FSM-East Mechanical Engineering

LITERATURE COMMENT FORM

Your comments and suggestions will help us in our continuous effort to improve the quality and usefulness of our publications.

Your name? _____
DEC Address? _____
Mail Stop ? _____ Telephone # (incl. area code)? _____
DTN? _____

Name and Part # of unit being repaired? _____

What is your general reaction to this manual? In your judgement is it complete, accurate, well organized, well written etc.? Is it easy to use?

What features are most useful? _____

What faults have you found in the manual? _____

Does this manual satisfy your needs? _____ Why? _____

Additional Comments? _____

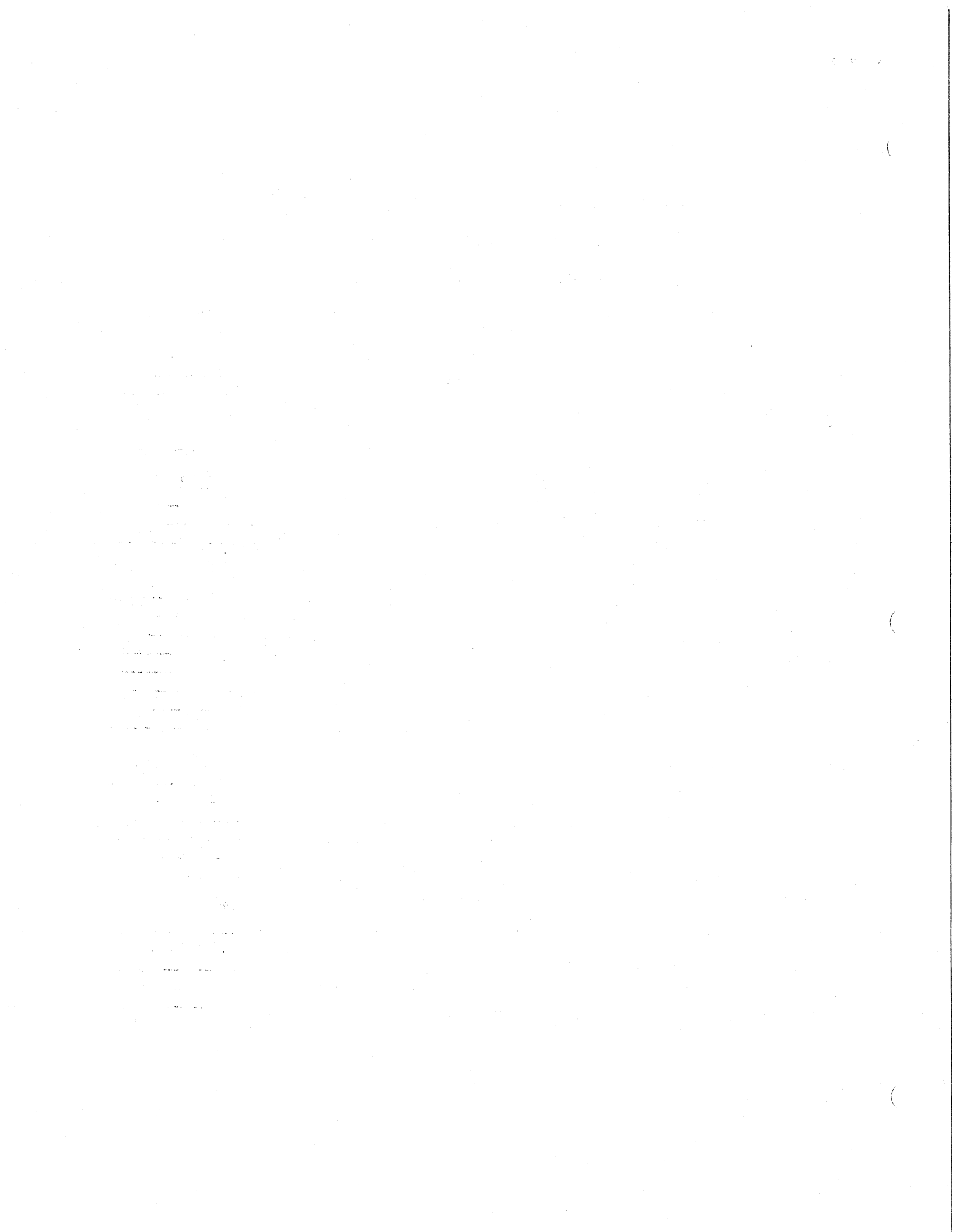

8.2 ECO Recommendation Form

- FSM-East Mechanical Engineering

ECO RECOMMENDATION FORM

Please fill in this form as completely as possible. Use a separate ECO Recommendation Form for each ECO recommendation.

Your name? _____
DEC Address? _____
Mail Stop ? _____ Telephone # (incl. area code)? _____
DTN? _____

Name of the unit being repaired? _____

What paragraph(s) of the manual does this ECO recommendation affect? _____

Describe the problem you see in the repair process. _____

If you can see a possible solution to the problem, describe it. _____

If the solution requires additional tools, describe them. _____

The first part of the document discusses the importance of maintaining accurate records and the role of the auditor in this process. It emphasizes the need for transparency and accountability in financial reporting.

The second part of the document details the various methods used to collect and analyze data, including interviews, surveys, and document analysis. It highlights the challenges associated with data collection and the importance of ensuring the reliability and validity of the information gathered.

The third part of the document focuses on the analysis and interpretation of the data. It discusses the use of statistical techniques and the importance of drawing meaningful conclusions from the findings. It also addresses the potential limitations of the study and the need for further research.

The fourth part of the document provides a summary of the key findings and offers recommendations for future practice. It concludes by emphasizing the value of the research and the potential for positive change through improved financial reporting and auditing practices.

8.3 Technical Contact Form

- FSM-East Mechanical Engineering

TECHNICAL CONTACT FORM

Use this form to feedback any process or testing enhancements, documentaton or product failure related information. The information will be forwarded to the proper individual, to be reviewed and action taken if necessary.

Product Name _____ Document P/N _____

What does the problem concern:

Documentation ___ Troubleshooting ___ Setup ___
Process ___ Test Tip ___ Product Failure ___

If this feedback concerns Product Failure, at what level does it occur:

Option ___ System ___ FRU ___

If the failure is Option level, list FRU P/N _____

If it is a FRU level failure list component P/N _____

Describe the Problem/Enhancement: _____

List any additional test equipment or tooling required: _____

If you can see a possible solution to the problem, describe it.

