

Cisco Reader Comment Card

General Information

- 1 Years of networking experience: _____ Years of experience with Cisco products: _____
- 2 I have these network types: LAN Backbone WAN
 Other: _____
- 3 I have these Cisco products: Switches Routers
 Other (specify models): _____
- 4 I perform these types of tasks: H/W installation and/or maintenance S/W configuration
 Network management Other: _____
- 5 I use these types of documentation: H/W installation H/W configuration S/W configuration
 Command reference Quick reference Release notes Online help
 Other: _____
- 6 I access this information through: _____% Cisco.com (CCO) _____% CD-ROM
_____% Printed docs _____% Other: _____
- 7 I prefer this access method: _____
- 8 I use the following three product features the most:

Document Information

Document Title: Cisco PIX Firewall and VPN Configuration Guide: Version 6.3
Part Number: 78-15033-01 S/W Release (if applicable): PIX Firewall version 6.3

On a scale of 1–5 (5 being the best), please let us know how we rate in the following areas:

- _____ The document is written at my technical level of understanding. _____ The information is accurate.
- _____ The document is complete. _____ The information I wanted was easy to find.
- _____ The information is well organized. _____ The information I found was useful to my job.

Please comment on our lowest scores:

Mailing Information

Company Name _____ Date _____

Contact Name _____ Job Title _____

Mailing Address _____

City _____ State/Province _____ ZIP/Postal Code _____

Country _____ Phone () _____ Extension _____

Fax () _____ E-mail _____

Can we contact you further concerning our documentation? Yes No

You can also send us your comments by e-mail to bug-doc@cisco.com, or by fax to **408-527-8089**.

BUSINESS REPLY MAIL

FIRST-CLASS MAIL PERMIT NO. 4631 SAN JOSE CA

POSTAGE WILL BE PAID BY ADDRESSEE

ATTN DOCUMENT RESOURCE CONNECTION
CISCO SYSTEMS INC
170 WEST TASMAN DRIVE
SAN JOSE CA 95134-9883

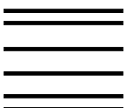

NO POSTAGE
NECESSARY
IF MAILED
IN THE
UNITED STATES

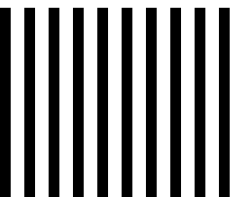



Cisco PIX Firewall and VPN Configuration Guide

Version 6.3

Corporate Headquarters

Cisco Systems, Inc.
170 West Tasman Drive
San Jose, CA 95134-1706
USA
<http://www.cisco.com>
Tel: 408 526-4000
800 553-NETS (6387)
Fax: 408 526-4100

Customer Order Number: DOC-7815033=
Text Part Number: 78-15033-01



THE SPECIFICATIONS AND INFORMATION REGARDING THE PRODUCTS IN THIS MANUAL ARE SUBJECT TO CHANGE WITHOUT NOTICE. ALL STATEMENTS, INFORMATION, AND RECOMMENDATIONS IN THIS MANUAL ARE BELIEVED TO BE ACCURATE BUT ARE PRESENTED WITHOUT WARRANTY OF ANY KIND, EXPRESS OR IMPLIED. USERS MUST TAKE FULL RESPONSIBILITY FOR THEIR APPLICATION OF ANY PRODUCTS.

THE SOFTWARE LICENSE AND LIMITED WARRANTY FOR THE ACCOMPANYING PRODUCT ARE SET FORTH IN THE INFORMATION PACKET THAT SHIPPED WITH THE PRODUCT AND ARE INCORPORATED HEREIN BY THIS REFERENCE. IF YOU ARE UNABLE TO LOCATE THE SOFTWARE LICENSE OR LIMITED WARRANTY, CONTACT YOUR CISCO REPRESENTATIVE FOR A COPY.

The Cisco implementation of TCP header compression is an adaptation of a program developed by the University of California, Berkeley (UCB) as part of UCB's public domain version of the UNIX operating system. All rights reserved. Copyright © 1981, Regents of the University of California.

NOTWITHSTANDING ANY OTHER WARRANTY HEREIN, ALL DOCUMENT FILES AND SOFTWARE OF THESE SUPPLIERS ARE PROVIDED "AS IS" WITH ALL FAULTS. CISCO AND THE ABOVE-NAMED SUPPLIERS DISCLAIM ALL WARRANTIES, EXPRESSED OR IMPLIED, INCLUDING, WITHOUT LIMITATION, THOSE OF MERCHANTABILITY, FITNESS FOR A PARTICULAR PURPOSE AND NONINFRINGEMENT OR ARISING FROM A COURSE OF DEALING, USAGE, OR TRADE PRACTICE.

IN NO EVENT SHALL CISCO OR ITS SUPPLIERS BE LIABLE FOR ANY INDIRECT, SPECIAL, CONSEQUENTIAL, OR INCIDENTAL DAMAGES, INCLUDING, WITHOUT LIMITATION, LOST PROFITS OR LOSS OR DAMAGE TO DATA ARISING OUT OF THE USE OR INABILITY TO USE THIS MANUAL, EVEN IF CISCO OR ITS SUPPLIERS HAVE BEEN ADVISED OF THE POSSIBILITY OF SUCH DAMAGES.

CCIP, CCSP, the Cisco Arrow logo, the Cisco *Powered* Network mark, the Cisco Systems Verified logo, Cisco Unity, Follow Me Browsing, FormShare, iQ Net Readiness Scorecard, Networking Academy, and ScriptShare are trademarks of Cisco Systems, Inc.; Changing the Way We Work, Live, Play, and Learn, The Fastest Way to Increase Your Internet Quotient, and iQuick Study are service marks of Cisco Systems, Inc.; and Aironet, ASIST, BPX, Catalyst, CCDA, CCDP, CCIE, CCNA, CCNP, Cisco, the Cisco Certified Internetwork Expert logo, Cisco IOS, the Cisco IOS logo, Cisco Press, Cisco Systems, Cisco Systems Capital, the Cisco Systems logo, Empowering the Internet Generation, Enterprise/Solver, EtherChannel, EtherSwitch, Fast Step, GigaStack, Internet Quotient, IOS, IP/TV, iQ Expertise, the iQ logo, LightStream, MGX, MICA, the Networkers logo, Network Registrar, *Packet*, PIX, Post-Routing, Pre-Routing, RateMUX, Registrar, SlideCast, SMARTnet, StrataView Plus, Stratm, SwitchProbe, TeleRouter, TransPath, and VCO are registered trademarks of Cisco Systems, Inc. and/or its affiliates in the U.S. and certain other countries.

All other trademarks mentioned in this document or Web site are the property of their respective owners. The use of the word partner does not imply a partnership relationship between Cisco and any other company. (0303R)

Cisco PIX Firewall and VPN Configuration Guide
Copyright ©2001-2003, Cisco Systems, Inc.
All rights reserved.



About This Guide	xix
Document Objectives	xix
Audience	xix
Document Organization	xx
Document Conventions	xxi
Obtaining Documentation	xxi
Cisco.com	xxi
Documentation CD-ROM	xxii
Ordering Documentation	xxii
Documentation Feedback	xxii
Obtaining Technical Assistance	xxiii
Cisco.com	xxiii
Technical Assistance Center	xxiii
Cisco TAC Website	xxiii
Cisco TAC Escalation Center	xxiv
Obtaining Additional Publications and Information	xxiv

CHAPTER 1

Getting Started	1-1
Controlling Network Access	1-1
How the PIX Firewall Works	1-2
Adaptive Security Algorithm	1-3
Multiple Interfaces and Security Levels	1-4
How Data Moves Through the PIX Firewall	1-4
Address Translation	1-5
Cut-Through Proxy	1-6
Supported Routing Protocols	1-6
Access Control	1-6
AAA Integration	1-6
Access Lists	1-7
TurboACL	1-7
Downloadable ACLs	1-7
Object Grouping	1-8
Conduits	1-8
VLAN Support	1-8

Protecting Your Network from Attack	1-8
Unicast Reverse Path Forwarding	1-9
Mail Guard	1-9
Flood Guard	1-9
FragGuard and Virtual Reassembly	1-9
DNS Control	1-9
ActiveX Blocking	1-10
Java Filtering	1-10
URL Filtering	1-10
Configurable Proxy Pinging	1-10
Supporting Specific Protocols and Applications	1-11
How Application Inspection Works	1-11
Voice over IP	1-11
CTIQBE (TAPI)	1-12
H.323	1-12
RAS Version 2	1-12
MGCP	1-12
SCCP	1-12
SIP	1-13
Multimedia Applications	1-13
LDAP Version 2 and ILS	1-14
NetBIOS over IP	1-14
Forwarding Multicast Transmissions	1-14
Creating a Virtual Private Network	1-14
Virtual Private Networks	1-15
IPSec	1-15
Internet Key Exchange (IKE)	1-15
Certification Authorities	1-16
Using a Site-to-Site VPN	1-17
Supporting Remote Access with a Cisco Easy VPN Server	1-18
Using PIX Firewall in a Small Office, Home Office Environment	1-19
Using the PIX Firewall as an Easy VPN Remote Device	1-19
PPPoE	1-19
DHCP Server	1-19
DHCP Relay	1-20
DHCP Client	1-20
Accessing and Monitoring PIX Firewall	1-20
Connecting to the Inside Interface of a Remote PIX Firewall	1-21
Cisco PIX Device Manager (PDM)	1-21

Command Authorization	1-21
Telnet Interface	1-22
SSH Version 1	1-22
NTP	1-22
Auto Update	1-22
Capturing Packets	1-22
Using SNMP	1-22
XDMCP	1-23
Using a Syslog Server	1-23
FTP and URL Logging	1-23
Integration with Cisco IDS	1-23
PIX Firewall Failover	1-24
Upgrading the PIX Firewall OS and License	1-24
Using the Command-Line Interface	1-25
Access Modes	1-25
Accessing Configuration Mode	1-26
Abbreviating Commands	1-27
Backing Up Your PIX Firewall Configuration	1-27
Command Line Editing	1-28
Filtering Show Command Output	1-28
Command Output Paging	1-29
Comments	1-29
Configuration Size	1-29
Help Information	1-30
Viewing the Default Configuration	1-30
Resetting the Default Configuration	1-30
Clearing and Removing Configuration Settings	1-31
Before You Start Configuring PIX Firewall	1-31
Where to Go from Here	1-31

CHAPTER 2**Establishing Connectivity 2-1**

Initial Configuration Checklist	2-1
Setting Default Routes	2-3
Setting Default Routes for Network Routers	2-3
Setting the Default Route for Network Hosts	2-4
Configuring PIX Firewall Interfaces	2-4
Assigning an IP Address and Subnet Mask	2-5
Identifying the Interface Type	2-5
Changing Interface Names or Security Levels	2-6

Establishing Outbound Connectivity with NAT and PAT	2-7
Overview	2-7
How NAT and PAT Work	2-9
Configuring NAT and PAT	2-9
Configuring the PIX Firewall for Routing	2-12
Using RIP	2-12
Configuring RIP Static Routes on PIX Firewall	2-13
Using OSPF	2-14
Overview	2-14
Security Issues When Using OSPF	2-14
OSPF Features Supported	2-15
Restrictions and Limitations	2-16
Configuring OSPF on the PIX Firewall	2-17
Using OSPF in Public Networks	2-17
Using OSPF in Private and Public Networks	2-19
Viewing OSPF Configuration	2-20
Clearing OSPF Configuration	2-21
Testing and Saving Your Configuration	2-21
Testing Connectivity	2-22
Saving Your Configuration	2-24
Basic Configuration Examples	2-24
Two Interfaces Without NAT or PAT	2-25
Two Interfaces with NAT and PAT	2-27
Three Interfaces Without NAT or PAT	2-29
Three Interfaces with NAT and PAT	2-31
Using VLANs with the Firewall	2-33
Overview	2-33
Using Logical Interfaces	2-34
VLAN Security Issues	2-34
Configuring PIX Firewall with VLANs	2-35
Managing VLANs	2-36
Using Outside NAT	2-37
Overview	2-37
Simplifying Routing	2-38
Configuring Overlapping Networks	2-39
Policy NAT	2-40
Limitations	2-42
Configuring Policy NAT	2-42
Configuring Global Translations	2-42

Configuring Static Translations	2-43
Enabling Stub Multicast Routing	2-43
Overview	2-44
Allowing Hosts to Receive Multicast Transmissions	2-44
Forwarding Multicasts from a Transmission Source	2-46
Configuring IGMP Timers	2-47
Setting the Query Interval	2-47
Setting Query Response Time	2-47
Clearing IGMP Configuration	2-47
Viewing and Debugging SMR	2-48
For More Information about Multicast Routing	2-49

CHAPTER 3

Controlling Network Access and Use	3-1
Enabling Server Access with Static NAT	3-1
Enabling Inbound Connections	3-2
Controlling Outbound Connectivity	3-4
Using the Static Command for Port Redirection	3-5
Overview	3-5
Port Redirection Configuration	3-6
Port Redirection Example	3-7
Using Authentication and Authorization	3-8
Configuring AAA	3-8
Enabling Secure Authentication of Web Clients	3-10
Configuring RADIUS Authorization	3-12
Using MAC-Based AAA Exemption	3-13
Access Control Configuration Example	3-14
Basic Configuration	3-14
Authentication and Authorization	3-16
Managing Access to Services	3-16
Adding Comments to ACLs	3-18
Using TurboACL	3-18
Overview	3-18
Globally Configuring TurboACL	3-19
Configuring Individual TurboACLs	3-19
Viewing TurboACL Configuration	3-20
Downloading Access Lists	3-20
Configuring Downloadable ACLs	3-20
Downloading a Named Access List	3-21
Downloading an Access List Without a Name	3-22

- Software Restrictions 3-23
- Simplifying Access Control with Object Grouping 3-24
 - How Object Grouping Works 3-24
 - Using Subcommand Mode 3-25
 - Configuring and Using Object Groups with Access Control 3-26
 - Configuring Protocol Object Groups 3-28
 - Configuring Network Object Groups 3-28
 - Configuring Service Object Groups 3-28
 - Configuring ICMP-Type Object Groups 3-29
 - Nesting Object Groups 3-29
 - Displaying Configured Object Groups 3-30
 - Removing Object Groups 3-30
- Filtering Outbound Connections 3-31
 - Filtering ActiveX Objects 3-31
 - Filtering Java Applets 3-32
 - Filtering URLs with Internet Filtering Servers 3-32
 - Overview 3-32
 - Identifying the Filtering Server 3-33
 - Buffering HTTP Replies for Filtered URLs 3-34
 - Filtering Long URLs with the Websense Filtering Server 3-34
 - Filtering HTTPS and FTP Sites 3-34
 - Configuring Filtering Policy 3-35
 - Filtering Long URLs 3-36
 - Viewing Filtering Statistics and Configuration 3-36
 - Configuration Procedure 3-38

CHAPTER 4

- Using PIX Firewall in SOHO Networks 4-1**
 - Using PIX Firewall as an Easy VPN Remote Device 4-1
 - Overview 4-2
 - Establishing Network Connectivity 4-4
 - Basic Configuration Procedure 4-4
 - Viewing Downloaded Configuration 4-5
 - Controlling Remote Administration 4-6
 - Using Secure Unit Authentication 4-6
 - Overview 4-6
 - Establishing a Connection with SUA Enabled 4-7
 - Managing Connection Behavior with SUA 4-7
 - Using Individual User Authentication 4-8
 - Using X.509 Certificates 4-9

Verifying the DN of an Easy VPN Server	4-10
Using the PIX Firewall PPPoE Client	4-11
Overview	4-11
Configuring the PPPoE Client Username and Password	4-12
Enabling PPPoE on the PIX Firewall	4-13
Using PPPoE with a Fixed IP Address	4-13
Monitoring and Debugging the PPPoE Client	4-14
Using Related Commands	4-15
Using the PIX Firewall DHCP Server	4-15
Overview	4-15
Configuring the DHCP Server Feature	4-17
Using Cisco IP Phones with a DHCP Server	4-19
Using DHCP Relay	4-20
Using the PIX Firewall DHCP Client	4-21
Overview	4-21
Configuring the DHCP Client	4-21
Releasing and Renewing the DHCP Lease	4-22
Monitoring and Debugging the DHCP Client	4-22

CHAPTER 5**Configuring Application Inspection (Fixup) 5-1**

How Application Inspection Works	5-1
Using the fixup Command	5-4
Basic Internet Protocols	5-6
DNS	5-6
FTP	5-7
HTTP	5-9
ICMP	5-9
IPSec	5-9
PPTP	5-10
SMTP	5-11
TFTP	5-11
Application Inspection	5-12
Sample Configuration	5-13
Voice Over IP	5-14
CTIQBE	5-14
CU-SeeMe	5-15
H.323	5-16
Overview	5-16
Multiple Calls on One Call Signalling Connection	5-16

- Viewing Connection Status 5-17
- Technical Background 5-17
- MGCP 5-18
 - Overview 5-18
 - Enabling MGCP Application Inspection 5-19
 - Configuration for Multiple Call Agents and Gateways 5-19
 - Viewing MGCP Information 5-20
- SCCP 5-20
 - Overview 5-21
 - Using PAT with SCCP 5-21
 - Using SCCP with Cisco CallManager on a Higher Security Interface 5-23
 - Problems Occur with Fragmented SCCP Packets 5-23
 - Viewing SCCP Information 5-23
- SIP 5-23
 - Overview 5-24
 - Allowing Outside Phones to Place an Inside Phone on Hold 5-24
 - Providing IP Address Privacy 5-25
 - Instant Messaging (IM) 5-26
 - Viewing SIP Information 5-26
 - Technical Background 5-26
- Multimedia Applications 5-27
 - Netshow 5-27
 - UDP Stream 5-27
 - TCP Stream 5-29
 - Real Time Streaming Protocol (RTSP) 5-29
 - VDO LIVE 5-30
- Database and Directory Support 5-30
 - ILS and LDAP 5-31
 - Network File System and Sun RPC 5-32
 - Oracle SQL*Net (V1/V2) 5-33
- Management Protocols 5-33
 - Internet Control Message Protocol 5-34
 - Remote Shell 5-34
 - X Display Manager Control Protocol 5-34
 - Simple Network Management Protocol Fixup 5-34

CHAPTER 6

Configuring IPsec and Certification Authorities 6-1

- How IPsec Works 6-1
- Internet Key Exchange (IKE) 6-2

IKE Overview	6-2
Configuring IKE	6-4
Disabling IKE	6-6
Using IKE with Pre-Shared Keys	6-6
Using Certification Authorities	6-7
CA Overview	6-8
Public Key Cryptography	6-8
Certificates Provide Scalability	6-8
Supported CA Servers	6-9
Configuring the PIX Firewall to Use Certificates	6-9
Verifying the Distinguished Name of a Certificate	6-12
Configuring IPSec	6-13
IPSec Overview	6-14
Transform Sets	6-15
Crypto Maps	6-15
Applying Crypto Maps to Interfaces	6-17
Access Lists	6-17
IPSec SA Lifetimes	6-19
Basic IPSec Configuration	6-20
Diffie-Hellman Group 5	6-22
Using Dynamic Crypto Maps	6-23
Site-to-Site Redundancy	6-25
Using NAT Traversal	6-25
Manual Configuration of SAs	6-26
Viewing IPSec Configuration	6-29
Clearing SAs	6-29

CHAPTER 7**Site-to-Site VPN Configuration Examples 7-1**

Using Pre-Shared Keys	7-1
Scenario Description	7-1
Configuring PIX Firewall 1 with VPN Tunneling	7-2
Configuring PIX Firewall 2 for VPN Tunneling	7-5
Using PIX Firewall with a VeriSign CA	7-7
Scenario Description	7-7
Configuring PIX Firewall 1 with a VeriSign CA	7-8
Configuring PIX Firewall 2 with a VeriSign CA	7-11
Using PIX Firewall with an In-House CA	7-13
Scenario Description	7-14
Configuring PIX Firewall 1 for an In-House CA	7-15

- Configuring PIX Firewall 2 for an In-House CA 7-18
- Using an Encrypted Tunnel to Obtain Certificates 7-20
 - Establishing a Tunnel Using a Pre-Shared Key 7-21
 - PIX Firewall 1 Configuration 7-21
 - PIX Firewall 2 Configuration 7-23
 - Establishing a Tunnel with a Certificate 7-24
 - PIX Firewall 1 Configuration 7-24
 - PIX Firewall 2 Configuration 7-25
- Connecting to a Catalyst 6500 and Cisco 7600 Series IPSec VPN Services Module 7-25
 - Scenario Description 7-25
 - Configuring IPSec Using a Trunk Port 7-26
 - Configuring IPSec Using a Routed Port 7-30
 - Verifying Your Configuration 7-35
- Manual Configuration with NAT 7-35
 - PIX Firewall 1 Configuration 7-35
 - PIX Firewall 2 Configuration 7-37

CHAPTER 8

Managing VPN Remote Access 8-1

- Using the PIX Firewall as an Easy VPN Server 8-1
 - Overview 8-2
 - Enabling Redundancy 8-4
 - Configuring Secure Unit Authentication 8-4
 - Configuring Individual User Authentication 8-4
 - Bypassing AAA Authentication 8-5
- Configuring Extended Authentication (Xauth) 8-5
- Configuring Easy VPN Remote Devices with IKE Mode Config 8-7
- Using an Easy VPN Remote Device with Pre-Shared Keys 8-8
 - Scenario Description 8-8
 - Configuring the PIX Firewall 8-10
 - Configuring the Easy VPN Remote Software Client 8-13
- Using an Easy VPN Remote Device with Digital Certificates 8-13
 - Client Verification of the Easy VPN Server Certificate 8-14
 - Scenario Description 8-14
 - Configuring the PIX Firewall 8-16
 - Configuring the Easy VPN Remote Software Client 8-19
- Using PPTP for Remote Access 8-20
 - Overview 8-20
 - PPTP Configuration 8-21
 - PPTP Configuration Example 8-21

Accessing and Monitoring PIX Firewall 9-1

Connecting to PIX Firewall Over a VPN Tunnel	9-1
Command Authorization and LOCAL User Authentication	9-2
Privilege Levels	9-2
User Authentication	9-3
Creating User Accounts in the LOCAL Database	9-3
User Authentication Using the LOCAL Database	9-4
Viewing the Current User Account	9-5
Command Authorization	9-5
Overview	9-6
Configuring LOCAL Command Authorization	9-6
Enabling LOCAL Command Authorization	9-7
Viewing LOCAL Command Authorization Settings	9-7
TACACS+ Command Authorization	9-8
Recovering from Lockout	9-9
Configuring PIX Firewall Banners	9-10
Using Network Time Protocol	9-10
Overview	9-11
Enabling NTP	9-11
Viewing NTP Status and Configuration	9-12
Managing the PIX Firewall Clock	9-15
Viewing System Time	9-15
Setting the System Clock	9-15
Setting Daylight Savings Time and Timezones	9-15
Using Telnet for Remote System Management	9-16
Configuring Telnet Console Access to the Inside Interface	9-17
Allowing a Telnet Connection to the Outside Interface	9-18
Overview	9-18
Using Telnet with an Easy VPN Remote Device	9-18
Using Cisco Secure VPN Client Version 1.1	9-19
Using Telnet	9-20
Trace Channel Feature	9-21
Using SSH for Remote System Management	9-21
Overview	9-22
Obtaining an SSH Client	9-22
Identifying the Host Using an SSH Client	9-23
Configuring Authentication for an SSH Client	9-24
Connecting to the PIX Firewall with an SSH Client	9-24
Viewing SSH Status	9-24

- Enabling Auto Update Support 9-25
 - Overview 9-25
 - Identifying the Auto Update Server 9-25
 - Managing Auto Update Support 9-26
 - Viewing the Auto Update Configuration 9-26
- Capturing Packets 9-27
 - Overview 9-27
 - Configuration Procedure 9-27
 - Packet Capture Output Formats 9-29
 - Packet Capture Examples 9-30
- Saving Crash Information to Flash Memory 9-31
- Using Syslog 9-32
 - Enabling Logging to Syslog Servers 9-33
 - Changing Syslog Message Levels 9-33
 - Disabling Syslog Messages 9-34
 - Viewing Modified Message Levels 9-34
 - Logging Access Control List Activity 9-35
 - Overview 9-35
 - Configuration 9-35
 - Logging Behavior 9-37
 - Syslog Message Format 9-38
 - Managing IDS Syslog Messages 9-39
- Using SNMP 9-41
 - Overview 9-41
 - MIB Support 9-42
 - SNMP CPU Utilization 9-42
 - SNMP Usage Notes 9-43
 - SNMP Traps 9-44
 - Receiving Requests and Sending Syslog Traps 9-44
 - Compiling Cisco Syslog MIB Files 9-45
 - Using the Firewall and Memory Pool MIBs 9-46
 - ipAddrTable Notes 9-46
 - Viewing Failover Status 9-47
 - Verifying Memory Usage 9-48
 - Viewing The Connection Count 9-49
 - Viewing System Buffer Usage 9-50

Understanding Failover	10-3
Overview	10-3
Network Connections	10-3
Failover and State Links	10-4
Failover Link	10-4
State Link	10-5
Primary and Secondary Vs. Active and Standby	10-6
Configuration Replication	10-6
Failover Triggers	10-7
Failover Configuration Prerequisites	10-8
Configuring Switches to Support Failover	10-8
Preconfiguring the PIX Firewall for Failover	10-8
Configuring Cable-Based Failover	10-9
Configuring LAN-Based Failover	10-11
Configuring the Primary Unit	10-12
Configuring the Secondary Unit	10-15
Verifying the Failover Configuration	10-16
Using the Show Failover Command	10-17
Testing the Failover Functionality	10-19
Forcing Failover	10-20
Disabling Failover	10-20
Monitoring Failover	10-20
Failover Syslog Messages	10-21
SNMP	10-21
Debugging Command	10-21
ACTIVE Light	10-21
Frequently Asked Failover Questions	10-21
Configuration Replication Questions	10-22
Basic Failover Questions	10-22
Cable-Based Failover Questions	10-23
LAN-Based Failover Questions	10-24
Stateful Failover Questions	10-24
Failover Configuration Examples	10-25
Cable-Based Failover Example	10-25
LAN-Based Failover Example	10-26

- Obtaining an Activation Key 11-2
- Entering a New Activation Key 11-2
- Troubleshooting the License Upgrade 11-4
- Using HTTP to Copy Software and Configurations 11-5
 - Copying PIX Firewall Configurations 11-6
 - Copying a PIX Firewall Image or PDM Software 11-6
- Downloading the Current Software 11-6
 - Getting a TFTP Server 11-7
 - Downloading Software from the Web 11-7
 - Downloading Software with FTP 11-8
- Installing and Recovering PIX Firewall Software 11-9
 - Installing Image Software from the Command Line 11-9
 - Using Monitor Mode to Recover the PIX Firewall Image 11-9
 - Using Boothelper 11-10
 - Get the Boothelper Binary Image 11-11
 - Preparing a Boothelper Diskette with UNIX, Solaris, or LINUX 11-11
 - Preparing a Boothelper Diskette on a Windows System 11-12
 - Downloading an Image with Boothelper 11-12
- Downgrading to a Previous Software Version 11-13
- Upgrading Failover Systems from a Previous Version 11-14
 - Upgrading Failover Systems from the CLI 11-14
 - Upgrading Failover Systems Using Monitor Mode 11-14
 - Upgrading Failover Systems Using Boothelper 11-15
- TFTP Download Error Codes 11-15

APPENDIX A

Acronyms and Abbreviations B - 1

APPENDIX B

Configuration Examples for Other Remote Access Clients B-1

- Xauth with RSA Ace/Server and RSA SecurID B-1
 - Terminology B-1
 - Introduction B-2
 - PIX Firewall Configuration B-3
 - SecurID with Cisco VPN Client Version 3.x B-4
 - Token Enabled B-4
 - Next Tokencode Mode B-4
 - New PIN Mode B-5
 - SecurID with Cisco VPN 3000 Client Version 2.5 B-5
 - Token Enabled B-6
 - Next Tokencode Mode B-6

New PIN Mode	B-6
SecurID with Cisco Secure VPN Client Version 1.1 (3DES)	B-7
Token Enabled	B-7
Next Tokencode Mode	B-8
New PIN Mode	B-8
L2TP with IPsec in Transport Mode	B-8
L2TP Overview	B-9
IPsec Transport and Tunnel Modes	B-9
Configuring L2TP with IPsec in Transport Mode	B-10
Windows 2000 Client with IPsec and L2TP	B-11
Overview	B-12
Configuring the PIX Firewall	B-12
Enabling IPsec Debug	B-15
Getting Additional Information	B-15
Using Cisco VPN Client Version 1.1	B-16
Configuring the PIX Firewall	B-17
Configuring the Cisco Secure VPN Client Version 1.1	B-19
Making an Exception to Xauth for a Site-to-Site VPN Peer	B-21
Making an Exception to IKE Mode Config for Site-to-Site VPN Peers	B-21

APPENDIX C**MS-Exchange Firewall Configuration C - 1**

Configuring the Microsoft Exchange Servers	C - 1
Configuring the PIX Firewall	C - 2
Configuring the Outside Server	C - 3
Configuring the Inside Server	C - 3
Configuring Both Systems After Rebooting	C - 4

APPENDIX D**TCP/IP Reference Information D - 1**

IP Addresses	D - 1
Ports	D - 2
Protocols and Applications	D - 5
Supported Multimedia Applications	D - 6
Supported Protocols and Applications	D - 6
Using Subnet Masks	D - 7
Masks	D - 7
Uses for Subnet Information	D - 9
Using Limited IP Addresses	D - 9
Addresses in the .128 Mask	D - 9

Addresses in the .192 Mask D - 10
Addresses in the .224 Mask D - 10
Addresses in the .240 Mask D - 10
Addresses in the .248 Mask D - 11
Addresses in the .252 Mask D - 12

APPENDIX E

Supported VPN Standards and Security Proposals E-1

IPSec E-1
Internet Key Exchange (IKE) E-2
Certification Authorities (CA) E-3
Supported Easy VPN Proposals E-3

INDEX



About This Guide

This preface introduces the *Cisco PIX Firewall and VPN Configuration Guide* and contains the following sections:

- [Document Objectives, page xix](#)
- [Audience, page xix](#)
- [Document Organization, page xx](#)
- [Document Conventions, page xxi](#)
- [Obtaining Documentation, page xxi](#)
- [Obtaining Technical Assistance, page xxiii](#)
- [Obtaining Additional Publications and Information, page xxiv](#)

Document Objectives

This document describes how to configure the Cisco PIX Firewall to protect your network from unauthorized use and to establish Virtual Private Networks (VPNs) to connect remote sites and users to your network.

Audience

This guide is for network managers who perform any of the following tasks:

- Managing network security
- Installing and configuring firewalls
- Managing default and static routes, and TCP and UDP services

Use this guide with the installation guide supplied with your PIX Firewall unit.

Document Organization

This guide includes the following chapters and appendixes:

- [Chapter 1, “Getting Started,”](#) describes the benefits provided by PIX Firewall and the technology used to implement each feature.
- [Chapter 2, “Establishing Connectivity,”](#) describes how to establish secure connectivity between an unprotected network, such as the public Internet, and one or more protected networks.
- [Chapter 3, “Controlling Network Access and Use,”](#) describes how to control connectivity between unprotected and protected networks and how to control network use through filtering and other PIX Firewall features.
- [Chapter 4, “Using PIX Firewall in SOHO Networks,”](#) describes how to configure the PIX Firewall as a Cisco Easy VPN Remote device and as a Point-to-Point-Protocol over Ethernet (PPPoE) client. It also describes how to use the PIX Firewall as a Dynamic Host Configuration Protocol (DHCP) server, client, and relay agent.
- [Chapter 5, “Configuring Application Inspection \(Fixup\),”](#) describes how the application inspection function enables the secure use of specific applications and services.
- [Chapter 6, “Configuring IPSec and Certification Authorities,”](#) describes how to configure the PIX Firewall to support Virtual Private Networks (VPNs).
- [Chapter 7, “Site-to-Site VPN Configuration Examples,”](#) provides examples of using PIX Firewall to establish site-to-site VPNs.
- [Chapter 8, “Managing VPN Remote Access,”](#) describes how to configure the PIX Firewall as an Easy VPN Server and how to configure Easy VPN Remote software clients. It also describes how to configure the PIX Firewall to support remote PPTP clients.
- [Chapter 9, “Accessing and Monitoring PIX Firewall,”](#) describes how to implement, configure, and integrate PIX Firewall system management tools.
- [Chapter 10, “Using PIX Firewall Failover,”](#) describes how to implement and configure the failover feature.
- [Chapter 11, “Changing Feature Licenses and System Software,”](#) describes how to upgrade or downgrade your PIX Firewall software image and feature license.
- [Appendix A, “Acronyms and Abbreviations,”](#) lists the acronyms and abbreviations used in this guide.
- [Appendix B, “Configuration Examples for Other Remote Access Clients”](#) describes how to use PIX Firewall with different remote access clients, including MS Windows 2000/L2TP and Cisco Secure VPN Client Version 1.1.
- [Appendix C, “MS-Exchange Firewall Configuration,”](#) describes how to configure PIX Firewall to handle mail transfers across the PIX Firewall from Windows NT Servers on protected and unprotected networks.
- [Appendix D, “TCP/IP Reference Information,”](#) lists the IP addresses associated with each subnet mask value.
- [Appendix E, “Supported VPN Standards and Security Proposals,”](#) lists the standards supported for IPSec, IKE, and certification authorities (CA).

Document Conventions

Command descriptions use these conventions:

- Braces ({ }) indicate a required choice.
- Square brackets ([]) indicate optional elements.
- Vertical bars (|) separate alternative, mutually exclusive elements.
- **Boldface** indicates commands and keywords that are entered literally as shown.
- *Italics* indicate arguments for which you supply values.

Examples use these conventions:

- Examples depict screen displays and the command line in *screen* font.
- Information you need to enter in examples is shown in **boldface screen** font.
- Variables for which you must supply a value are shown in *italic screen* font.

Graphic user interface access uses these conventions:

- **Boldface** indicates buttons and menu items.
- Selecting a menu item (or screen) is indicated by the following convention:

Click **Start>Settings>Control Panel**.

**Note**

Means *reader take note*. Notes contain helpful suggestions or references to material not covered in the manual.

Obtaining Documentation

Cisco provides several ways to obtain documentation, technical assistance, and other technical resources. These sections explain how to obtain technical information from Cisco Systems.

Cisco.com

You can access the most current Cisco documentation on the World Wide Web at this URL:

<http://www.cisco.com/univercd/home/home.htm>

You can access the Cisco website at this URL:

<http://www.cisco.com>

International Cisco web sites can be accessed from this URL:

http://www.cisco.com/public/countries_languages.shtml

Documentation CD-ROM

Cisco documentation and additional literature are available in a Cisco Documentation CD-ROM package, which may have shipped with your product. The Documentation CD-ROM is updated monthly and may be more current than printed documentation. The CD-ROM package is available as a single unit or through an annual subscription.

Registered Cisco.com users can order the Documentation CD-ROM (product number DOC-CONDOCCD=) through the online Subscription Store:

<http://www.cisco.com/go/subscription>

Ordering Documentation

You can find instructions for ordering documentation at this URL:

http://www.cisco.com/univercd/cc/td/doc/es_inpk/pdi.htm

You can order Cisco documentation in these ways:

- Registered Cisco.com users (Cisco direct customers) can order Cisco product documentation from the Networking Products MarketPlace:

<http://www.cisco.com/en/US/partner/ordering/index.shtml>

- Registered Cisco.com users can order the Documentation CD-ROM (Customer Order Number DOC-CONDOCCD=) through the online Subscription Store:

<http://www.cisco.com/go/subscription>

- Nonregistered Cisco.com users can order documentation through a local account representative by calling Cisco Systems Corporate Headquarters (California, U.S.A.) at 408 526-7208 or, elsewhere in North America, by calling 800 553-NETS (6387).

Documentation Feedback

You can submit comments electronically on Cisco.com. On the Cisco Documentation home page, click **Feedback** at the top of the page.

You can e-mail your comments to bug-doc@cisco.com.

You can submit your comments by mail by using the response card behind the front cover of your document or by writing to the following address:

Cisco Systems
Attn: Customer Document Ordering
170 West Tasman Drive
San Jose, CA 95134-9883

We appreciate your comments.

Obtaining Technical Assistance

Cisco provides Cisco.com, which includes the Cisco Technical Assistance Center (TAC) Website, as a starting point for all technical assistance. Customers and partners can obtain online documentation, troubleshooting tips, and sample configurations from the Cisco TAC website. Cisco.com registered users have complete access to the technical support resources on the Cisco TAC website, including TAC tools and utilities.

Cisco.com

Cisco.com offers a suite of interactive, networked services that let you access Cisco information, networking solutions, services, programs, and resources at any time, from anywhere in the world.

Cisco.com provides a broad range of features and services to help you with these tasks:

- Streamline business processes and improve productivity
- Resolve technical issues with online support
- Download and test software packages
- Order Cisco learning materials and merchandise
- Register for online skill assessment, training, and certification programs

To obtain customized information and service, you can self-register on Cisco.com at this URL:

<http://www.cisco.com>

Technical Assistance Center

The Cisco TAC is available to all customers who need technical assistance with a Cisco product, technology, or solution. Two levels of support are available: the Cisco TAC website and the Cisco TAC Escalation Center. The avenue of support that you choose depends on the priority of the problem and the conditions stated in service contracts, when applicable.

We categorize Cisco TAC inquiries according to urgency:

- Priority level 4 (P4)—You need information or assistance concerning Cisco product capabilities, product installation, or basic product configuration.
- Priority level 3 (P3)—Your network performance is degraded. Network functionality is noticeably impaired, but most business operations continue.
- Priority level 2 (P2)—Your production network is severely degraded, affecting significant aspects of business operations. No workaround is available.
- Priority level 1 (P1)—Your production network is down, and a critical impact to business operations will occur if service is not restored quickly. No workaround is available.

Cisco TAC Website

You can use the Cisco TAC website to resolve P3 and P4 issues yourself, saving both cost and time. The site provides around-the-clock access to online tools, knowledge bases, and software. To access the Cisco TAC website, go to this URL:

<http://www.cisco.com/tac>

All customers, partners, and resellers who have a valid Cisco service contract have complete access to the technical support resources on the Cisco TAC website. Some services on the Cisco TAC website require a Cisco.com login ID and password. If you have a valid service contract but do not have a login ID or password, go to this URL to register:

<http://tools.cisco.com/RPF/register/register.do>

If you are a Cisco.com registered user, and you cannot resolve your technical issues by using the Cisco TAC website, you can open a case online at this URL:

<http://www.cisco.com/en/US/support/index.html>

If you have Internet access, we recommend that you open P3 and P4 cases through the Cisco TAC website so that you can describe the situation in your own words and attach any necessary files.

Cisco TAC Escalation Center

The Cisco TAC Escalation Center addresses priority level 1 or priority level 2 issues. These classifications are assigned when severe network degradation significantly impacts business operations. When you contact the TAC Escalation Center with a P1 or P2 problem, a Cisco TAC engineer automatically opens a case.

To obtain a directory of toll-free Cisco TAC telephone numbers for your country, go to this URL:

<http://www.cisco.com/warp/public/687/Directory/DirTAC.shtml>

Before calling, please check with your network operations center to determine the level of Cisco support services to which your company is entitled: for example, SMARTnet, SMARTnet Onsite, or Network Supported Accounts (NSA). When you call the center, please have available your service agreement number and your product serial number.

Obtaining Additional Publications and Information

Information about Cisco products, technologies, and network solutions is available from various online and printed sources.

- The *Cisco Product Catalog* describes the networking products offered by Cisco Systems as well as ordering and customer support services. Access the *Cisco Product Catalog* at this URL:
http://www.cisco.com/en/US/products/products_catalog_links_launch.html
- Cisco Press publishes a wide range of networking publications. Cisco suggests these titles for new and experienced users: *Internetworking Terms and Acronyms Dictionary*, *Internetworking Technology Handbook*, *Internetworking Troubleshooting Guide*, and the *Internetworking Design Guide*. For current Cisco Press titles and other information, go to Cisco Press online at this URL:
<http://www.ciscopress.com>
- *Packet* magazine is the Cisco monthly periodical that provides industry professionals with the latest information about the field of networking. You can access *Packet* magazine at this URL:
http://www.cisco.com/en/US/about/ac123/ac114/about_cisco_packet_magazine.html
- *iQ Magazine* is the Cisco monthly periodical that provides business leaders and decision makers with the latest information about the networking industry. You can access *iQ Magazine* at this URL:
http://business.cisco.com/prod/tree.taf%3fasset_id=44699&public_view=true&kbns=1.html

- *Internet Protocol Journal* is a quarterly journal published by Cisco Systems for engineering professionals involved in the design, development, and operation of public and private internets and intranets. You can access the *Internet Protocol Journal* at this URL:

http://www.cisco.com/en/US/about/ac123/ac147/about_cisco_the_internet_protocol_journal.html

- Training—Cisco offers world-class networking training, with current offerings in network training listed at this URL:

http://www.cisco.com/en/US/learning/le31/learning_recommended_training_list.html



Getting Started

The Cisco PIX Firewall lets you establish stateful firewall protection and secure VPN access with a single device. PIX Firewall provides a scalable security solution with failover support available for selected models to provide maximum reliability. PIX Firewall uses a specialized operating system that is more secure and easier to maintain than software firewalls that use a general-purpose operating system, which are subject to frequent threats and attacks.

This chapter describes how you can use the PIX Firewall to protect your network assets and to establish secure VPN access. It contains the following sections:

- [Controlling Network Access, page 1-1](#)
- [Protecting Your Network from Attack, page 1-8](#)
- [Supporting Specific Protocols and Applications, page 1-11](#)
- [Creating a Virtual Private Network, page 1-14](#)
- [Using PIX Firewall in a Small Office, Home Office Environment, page 1-19](#)
- [Accessing and Monitoring PIX Firewall, page 1-20](#)
- [PIX Firewall Failover, page 1-24](#)
- [Upgrading the PIX Firewall OS and License, page 1-24](#)
- [Using the Command-Line Interface, page 1-25](#)
- [Before You Start Configuring PIX Firewall, page 1-31](#)
- [Where to Go from Here, page 1-31](#)

Controlling Network Access

This section describes the network firewall functionality provided by PIX Firewall. It includes the following topics:

- [How the PIX Firewall Works, page 1-2](#)
- [Adaptive Security Algorithm, page 1-3](#)
- [Multiple Interfaces and Security Levels, page 1-4](#)
- [How Data Moves Through the PIX Firewall, page 1-4](#)
- [Address Translation, page 1-5](#)
- [Cut-Through Proxy, page 1-6](#)

- [Access Control](#), page 1-6
- [VLAN Support](#), page 1-8

Chapter 2, “Establishing Connectivity” provides configuration instructions for establishing network connectivity through the PIX Firewall. Chapter 3, “Controlling Network Access and Use” provides configuration instructions for using the PIX Firewall to control network connectivity.

How the PIX Firewall Works

The PIX Firewall protects an inside network from unauthorized access by users on an outside network, such as the public Internet. Most PIX Firewall models can optionally protect one or more perimeter networks, also known as demilitarized zones (DMZs). Access to the perimeter network is typically less restricted than access to the inside network, but more restricted than access to the outside network. Connections between the inside, outside, and perimeter networks are controlled by the PIX Firewall.

To effectively use a firewall in your organization, you need a security policy to ensure that all traffic from the protected networks passes only through the firewall to the unprotected network. You can then control who may access the networks with which services, and how to implement your security policy using the features that the PIX Firewall provides.

Figure 1-1 shows how a PIX Firewall protects a network while allowing outbound connections and secure access to the Internet.

Figure 1-1 The PIX Firewall in a Network

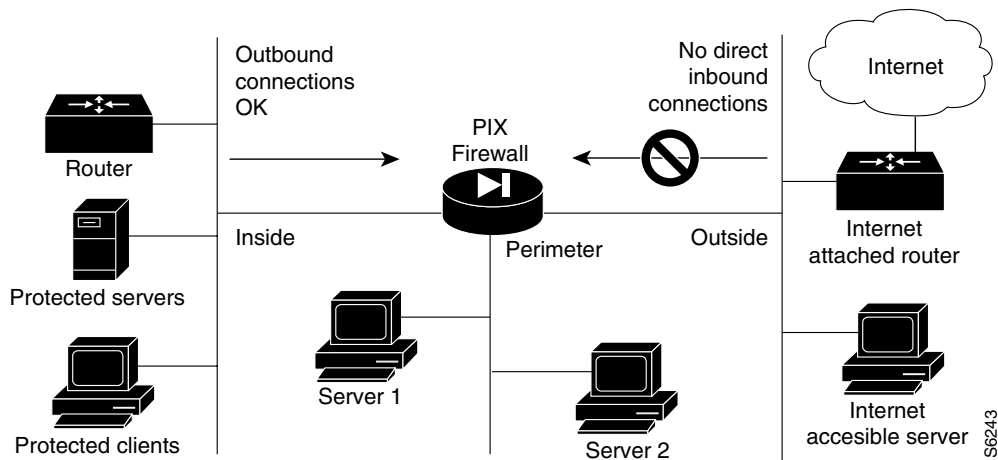

Within this architecture, the PIX Firewall forms the boundary between the protected networks and the unprotected networks. All traffic between the protected and unprotected networks flows through the firewall to maintain security. Traffic may not exit the PIX Firewall on the same network interface it entered. The unprotected network is typically accessible to the Internet. The PIX Firewall lets you locate servers such as those for Web access, SNMP, electronic mail (SMTP) in the protected network, and control who on the outside can access these servers.

For PIX Firewall models with three or more interfaces, server systems can be located on a perimeter network as shown in Figure 1-1, and access to the server systems can be controlled and monitored by the PIX Firewall. The PIX 501 and PIX 506/506E each have two network interfaces, so all systems must be located either on the inside or the outside interfaces.

The PIX Firewall also lets you implement your security policies for connection to and from the inside network.

Typically, the inside network is an organization's own internal network, or intranet, and the outside network is the Internet, but the PIX Firewall can also be used within an intranet to isolate or protect one group of internal computing systems and users from another.

The perimeter network can be configured to be as secure as the inside network or with varying security levels. Security levels are assigned numeric values from 0, the least secure, to 100, the most secure. The outside interface is always 0 and the inside interface is always 100. The perimeter interfaces can be any security level from 1 to 99.

Both the inside and perimeter networks are protected with the PIX Firewall's Adaptive Security Algorithm (ASA). The inside, perimeter, and outside interfaces can listen to RIP routing updates, and all interfaces can broadcast a RIP default route if required.

Adaptive Security Algorithm

The Adaptive Security Algorithm (ASA) is a stateful approach to security. Every inbound packet is checked against the Adaptive Security Algorithm and against connection state information in memory. This stateful approach to security is regarded in the industry as being far more secure than a stateless packet screening approach.

ASA allows one way (inside to outside) connections without an explicit configuration for each internal system and application. ASA is always in operation, monitoring return packets to ensure they are valid. It actively randomizes TCP sequence numbers to minimize the risk of TCP sequence number attack.



Note

The PIX Firewall checks the TCP sequence number and ensures that it fits within an acceptable range.

ASA applies to the dynamic translation slots and static translation slots. You create static translation slots with the **static** command and dynamic translation slots with the **global** command. Collectively, both types of translation slots are referred to as “xlates.” ASA follows these rules:

- No packets can traverse the PIX Firewall without a connection and state.
- Traffic may not exit the PIX Firewall on the same network interface it entered.
- Outbound connections or states are allowed, except those specifically denied by access control lists. An outbound connection is one where the originator or client is on a higher security interface than the receiver or server. The highest security interface is always the inside interface and the lowest is the outside interface. Any perimeter interfaces can have security levels between the inside and outside values.
- Inbound connections or states are denied, except those specifically allowed. An inbound connection or state is one where the originator or client is on a lower security interface/network than the receiver or server. You can apply multiple exceptions to a single xlate (translation). This lets you permit access from an arbitrary machine, network, or any host on the Internet to the host defined by the xlate.
- All ICMP packets are denied unless specifically permitted.
- All attempts to circumvent the previous rules are dropped and a message is sent to the syslog.

PIX Firewall handles UDP data transfers in a manner similar to TCP. Special handling allows DNS, archie, StreamWorks, H.323, and RealAudio to work securely. The PIX Firewall creates UDP “connection” state information when a UDP packet is sent from the inside network. Response packets resulting from this traffic are accepted if they match the connection state information. The connection state information is deleted after a short period of inactivity.

For more information about how ASA works and how you can configure application inspection with different types of applications, refer to [Chapter 5, “Configuring Application Inspection \(Fixup\).”](#)

Multiple Interfaces and Security Levels

All PIX Firewalls provide at least two interfaces, which by default, are called outside and inside, and are assigned a security level of 0 and 100, respectively. A lower security level indicates that the interface is relatively less protected than the higher security level. Typically, the outside interface is connected to the public Internet, while the inside interface is connected to your private network and is protected from public access.

Many PIX Firewall models provide up to eight interfaces, to let you create one or more perimeter networks, also called bastion networks or demilitarized zones (DMZs). A DMZ is a network that is more secure than the outside interface but less secure than the inside interface. You can assign security levels to your perimeter networks from 0 to 100. Typically, you put mail servers or web servers that need to be accessed by users on the public Internet in a DMZ to provide some protection, but without jeopardizing the resources on your internal network.

How Data Moves Through the PIX Firewall

When an outbound packet arrives at a PIX Firewall higher security level interface (security levels can be viewed with the **show nameif** command), the PIX Firewall checks to see if the packet is valid based on the Adaptive Security Algorithm, and then whether or not previous packets have come from that host. If not, then the packet is for a new connection, and PIX Firewall creates a translation slot in its state table for the connection. The information that PIX Firewall stores in the translation slot includes the inside IP address and a globally unique IP address assigned by Network Address Translation (NAT), Port Address Translation (PAT), or Identity (which uses the inside address as the outside address). The PIX Firewall then changes the packet's source IP address to the globally unique address, modifies the checksum and other fields as required, and forwards the packet to the lower security level interface.

When an inbound packet arrives at an external interface such as the outside interface, it first passes the PIX Firewall Adaptive Security criteria. If the packet passes the security tests, the PIX Firewall removes the destination IP address, and the internal IP address is inserted in its place. The packet is forwarded to the protected interface.



Note

Traffic may not exit the PIX Firewall on the same network interface it entered. This condition results in the following message in the system log:

```
%PIX-7-106011: Deny inbound (No xlate) chars
```

Explanation This is a connection-related message. This message occurs when a packet is sent to the same interface that it arrived on. This usually indicates that a security breach is occurring. When the PIX Firewall receives a packet, it tries to establish a translation slot based on the security policy you set with the global and conduit commands, and your routing policy set with the route command.

Address Translation

The Network Address Translation (NAT) feature works by substituting, or translating, host addresses on one interface with a “global address” associated with another interface. This protects internal host addresses from being exposed on other network interfaces. To understand whether you want to use NAT, decide if you want to expose internal addresses on other network interfaces connected to the PIX Firewall. If you choose to protect internal host addresses using NAT, you identify the pool of addresses you want to use for translation.

**Note**

Beginning with Version 6.2 of the PIX Firewall, NAT is also available for translating outside addresses. This helps to simplify network routing by controlling the addresses that can appear on the inside network.

If the addresses that you want to protect access only other networks within your organization, you can use any set of “private” addresses for the pool of translation addresses. For example, if you want to protect the host addresses on the Finance Department’s network (connected to the inside interface on the PIX Firewall) from exposure when connecting to the Sales Department network (connected to the perimeter interface on the PIX Firewall), you can set up translation using any available set of addresses on the Sales network. The effect is that hosts on the Finance network appear as local addresses on the Sales network.

If the addresses that you want to protect require Internet access, you use only NIC-registered addresses (official Internet addresses registered with the Network Information Center for your organization) for the pool of translation addresses. For example, if you want to protect host addresses on the Sales network (connected to a perimeter interface of the PIX Firewall) from exposure when making connections to the Internet (accessible through the outside interface of the PIX Firewall), you can set up translation using a pool of registered addresses on the outside interface. The effect is that hosts on the Internet see only the Internet addresses for the Sales network, not the addresses on the perimeter interface.

If you are installing the PIX Firewall in an established network that has host- or network-registered addresses, you might not want to perform translation for those hosts or networks because that would require using another registered address for the translation.

When considering NAT, it is also important to consider whether you have an equal number of addresses for internal hosts. If not, some internal hosts might not get network access when making a connection. In this case you can either apply for additional NIC-registered addresses or use Port Address Translation (PAT). PAT uses a single external address to manage up to 64,000 concurrent connections.

For inside systems, NAT translates the source IP address of outgoing packets (defined in RFC 1631). It supports both dynamic and static translation. NAT allows inside systems to be assigned private addresses (defined in RFC 1918), or to retain existing invalid addresses. NAT also provides additional security by hiding the real network identity of internal systems from the outside network.

PAT uses port remapping, which allows a single valid IP address to support source IP address translation for up to 64,000 active xlate objects. PAT minimizes the number of globally valid IP addresses required to support private or invalid internal addressing schemes. PAT does not work with multimedia applications that have an inbound data stream different from the outgoing control path. PAT provides additional security by hiding the real network identity of internal systems from the outside network.

Another class of address translation on the PIX Firewall is static translation. Static translation lets you substitute a fixed external IP address for an internal address. This is useful for servers that require fixed IP addresses for access from the public Internet.

The PIX Firewall Identify feature allows address translation to be disabled. If existing internal systems have valid globally unique addresses, the Identity feature allows NAT and PAT to be selectively disabled for these systems. This feature makes internal network addresses visible to the outside network.

Cut-Through Proxy

Cut-through proxy is a feature unique to PIX Firewall that allows user-based authentication of inbound or outbound connections. A proxy server analyzes every packet at layer seven of the OSI model, which is a time- and processing-intensive function. By contrast, the PIX Firewall uses cut-through proxy to authenticate a connection and then allow traffic to flow quickly and directly.

Cut-through proxy allows a much finer level of administrative control over connections than checking source IP addresses. It allows security policies to be enforced based on individual user accounts. Connections can be authenticated with a user ID and password before are established, and one-time dynamic passwords or security tokens are supported for greater security. Authentication and authorization are supported for HTTP, Telnet, or FTP connections.

Supported Routing Protocols

PIX Firewall Version 6.3 introduces support for Open Shortest Path First (OSPF), which allows PIX Firewall to fully participate in dynamic routing updates with dedicated routing devices. PIX Firewall before Version 6.3 only supports Routing Information Protocol (RIP) Version 2.

When using RIP, PIX Firewall only listens in passive mode and/or broadcasts a default route. The PIX Firewall supports Cisco IOS software standards, which conform to RFC 1058, RFC 1388, and RFC 2082 of RIPv2 with text and keyed MD5 authentication. The PIX Firewall supports one key and key ID per interface.

Access Control

This section describes the features implemented by the PIX Firewall to support authentication and authorization of network users. It includes the following topics:

- [AAA Integration, page 1-6](#)
- [Access Lists, page 1-7](#)
- [TurboACL, page 1-7](#)
- [Downloadable ACLs, page 1-7](#)
- [Object Grouping, page 1-8](#)
- [Conduits, page 1-8](#)

Chapter 3, “Controlling Network Access and Use” provides configuration instructions for using the features mentioned in this section.

AAA Integration

PIX Firewall provides integration with AAA (authentication, authorization, and accounting) services. AAA services are provided by Terminal Access Controller Access Control System Plus (TACACS+) or Remote Authentication Dial-In User Service (RADIUS) servers.

PIX Firewall lets you define separate groups of TACACS+ or RADIUS servers for specifying different types of traffic. For example, you could identify one TACACS+ server for inbound traffic and another for outbound traffic.

AAA server groups are defined by a tag name that directs different types of traffic to each authentication server. If accounting is in effect, the accounting information goes to the active server.

The PIX Firewall allows a RADIUS server to send user group attributes to the PIX Firewall in the RADIUS authentication response message. The PIX Firewall then matches an access list to the attribute and determines RADIUS authorization from the access list. After the PIX Firewall authenticates a user, it will apply an access list for the user that was returned by the AAA server using the Cisco **acl** attribute (**acl=<acl_name>**).

For additional information about configuring AAA servers for use with the PIX Firewall see Authentication and Command Authorization for PIX at the following URL:

http://www.cisco.com/en/US/products/hw/vpndevc/ps2030/products_tech_note09186a00800949d6.shtml

Access Lists

Beginning with Version 5.3, the PIX Firewall uses access lists to control connections between inside and outside networks. Access lists are implemented with the **access-list** and **access-group** commands. These commands are used instead of the **conduit** and **outbound** commands, which were used in earlier versions of PIX Firewall software. In major software releases after Version 6.3, the **conduit** and **outbound** commands are no longer supported. To migrate an obsolete PIX configuration file that contains **conduit** and **outbound** commands to a supported configuration file that contains the equivalent **access-list** commands, a tool is available to help with the conversion process:

- <https://cco-dev.cisco.com/cgi-bin/Support/OutputInterpreter/home.pl> (online tool)
- <http://www.cisco.com/cgi-bin/tablebuild.pl/pix> (download tool)



Note

PIX Firewall Version 6.3 improves your ability to log information about activity associated with specific access control lists (ACLs). Version 6.3 also lets you add comments to each ACL, so you can describe the purpose and expected effect of each entry.

You can use access lists to control connections based on source address, destination address, or protocol. Configure access lists carefully to allow the minimum access required. When possible, make access lists more restrictive by specifying a remote source address, local destination address, and protocol. The **access-list** and **access-group** commands take precedence over the **conduit** and **outbound** commands in your configuration.

TurboACL

A feature called TurboACL was introduced in PIX Firewall Version 6.2 that improves the way that the PIX Firewall processes large access control lists. The method by which the PIX Firewall searches for an access list entry has been improved to reduce the time spent searching large access lists. TurboACL supports access lists with up to 16,000 access list entries.

Downloadable ACLs

When used with a AAA server, PIX Firewall lets you create access lists that control connections on a per-user basis. Creating per-user access lists requires creating a user profile for the user on a RADIUS server. In previous versions of PIX Firewall, you also had to configure an access list for each user locally on each PIX Firewall. Beginning with PIX Firewall Version 6.2, the required per-user access list is downloaded from the AAA server based on the user profile. No additional access list configuration is required on any PIX Firewall. This new feature greatly reduces the complexity and improves the scalability of per-user access lists.

Object Grouping

Object grouping, introduced in PIX Firewall Version 6.2, reduces the complexity of configuration and improves scalability for large or complex networks. Object grouping lets you apply access rules to logical groups of network objects. When you apply a PIX Firewall command to an object group, the command affects all network objects defined within the group. This can reduce a very large number of access rules to a manageable number, which reduces time spent configuring and troubleshooting access rules in large or complex networks.

Conduits

Beginning with Version 5.3, the PIX Firewall uses access lists to control connections between inside and outside networks. Access lists are implemented with the **access-list** and **access-group** commands. These commands are used instead of the **conduit** and **outbound** commands, which were used in earlier versions of PIX Firewall software. In major software releases after Version 6.3, the **conduit** and **outbound** commands are no longer supported. To migrate an obsolete PIX configuration file that contains **conduit** and **outbound** commands to a supported configuration file that contains the equivalent **access-list** commands, a tool is available to help with the conversion process:

- <https://cco-dev.cisco.com/cgi-bin/Support/OutputInterpreter/home.pl> (online tool)
- <http://www.cisco.com/cgi-bin/tablebuild.pl/pix> (download tool)

VLAN Support

Virtual LANs (VLANs) are used to create separate broadcast domains within a single switched network. PIX Firewall Version 6.3 can route traffic between these broadcast domains, while applying the firewall policy for your network. PIX Firewall now supports 802.1Q, which allows traffic for multiple VLANs to be exchanged over a single physical link. With Version 6.3, you can define multiple logical interfaces for a single physical interface, and assign different VLANs to each logical interface.

Protecting Your Network from Attack

This section describes the firewall features provided by PIX Firewall. These firewall features control network activity associated with specific kinds of attacks. This section includes the following topics:

- [Unicast Reverse Path Forwarding, page 1-9](#)
- [Mail Guard, page 1-9](#)
- [Flood Guard, page 1-9](#)
- [FragGuard and Virtual Reassembly, page 1-9](#)
- [FragGuard and Virtual Reassembly, page 1-9](#)
- [DNS Control, page 1-9](#)
- [ActiveX Blocking, page 1-10](#)
- [Java Filtering, page 1-10](#)
- [URL Filtering, page 1-10](#)
- [Configurable Proxy Pinging, page 1-10](#)

For more information about the PIX Firewall features used to protect your network against specific attacks, refer to [Chapter 5, “Configuring Application Inspection \(Fixup\).”](#) For information about configuring ActiveX Blocking, Java Filtering, and URL Filtering, refer to the [“Filtering Outbound Connections” section on page 3-31 in Chapter 3, “Controlling Network Access and Use.”](#)

For information about features that allow using specific protocols and applications across the firewall, refer to [“Supporting Specific Protocols and Applications.”](#)

Unicast Reverse Path Forwarding

Unicast Reverse Path Forwarding (Unicast RPF), also known as “reverse route lookup,” provides inbound and outbound filtering to help prevent IP spoofing. This feature checks inbound packets for IP source address integrity, and verifies that packets destined for hosts outside the managed domain have IP source addresses verifiable by routes in the enforcing entities local routing table.

Unicast RPF is limited to addresses for networks in the enforcing entities local routing table. If the incoming packet does not have a source address represented by a route, it is impossible to know whether the packet arrived on the best possible path back to its origin.

Mail Guard

The Mail Guard feature provides safe access for Simple Mail Transfer Protocol (SMTP) connections from the outside to an inside messaging server. This feature allows a single mail server to be deployed within the internal network without it being exposed to known security problems with some SMTP server implementations. This eliminates the need for an external mail relay (or bastion host) system. Mail Guard enforces a safe minimal set of SMTP commands to avoid an SMTP server system from being compromised. This feature also logs all SMTP connections.

Flood Guard

The Flood Guard feature controls the AAA service's tolerance for unanswered login attempts. This helps to prevent a denial of service (DoS) attack on AAA services in particular. This feature optimizes AAA system use. It is enabled by default and can be controlled with the **floodguard 1** command.

FragGuard and Virtual Reassembly

FragGuard and virtual reassembly is a feature that provides IP fragment protection. This feature performs full reassembly of all ICMP error messages and virtual reassembly of the remaining IP fragments that are routed through the PIX Firewall. Virtual reassembly is currently enabled by default. This feature uses syslog to log any fragment overlapping and small fragment offset anomalies, especially those caused by a teardrop attack.

DNS Control

The PIX Firewall identifies each outbound DNS (Domain Name System) resolve request, and only allows a single DNS response. A host may query several servers for a response (in the case that the first server is slow in responding), but only the first answer to the request is allowed. All additional responses to the request are dropped by the firewall. The DNS fixup is configurable and enabled by default.

ActiveX Blocking

ActiveX controls, formerly known as OLE or OCX controls, are components that can be inserted into a web page or other application. The PIX Firewall ActiveX blocking feature blocks HTML <object> commands and comments them out of the HTML web page. As a technology, ActiveX creates many potential problems for the network clients including causing workstations to fail, introducing network security problems, being used to attack servers, or being used to host attacks against servers.

Java Filtering

The Java Filtering feature lets you prevent Java applets from being downloaded by a system on a protected network. Java applets are executable programs that may be prohibited by some security policies because they can enable certain methods of attacking a protected network.

URL Filtering

You can use access control lists to prevent outbound access to specific websites, but configuring and managing web usage this way is not very practical because of the size and dynamic nature of the Internet. The recommended solution is to use the PIX Firewall in conjunction with a separate server running one of the following Internet filtering products:

- Websense Enterprise web filtering application (supported by PIX Firewall Version 5.3 or higher)
- Filtering by N2H2 for IFP-enabled devices (supported by PIX Firewall Version 6.2 or higher)

Compared to using access control lists, this reduces the administrative task and improves filtering effectiveness. Also, because URL filtering is handled on a separate platform, the performance of the PIX Firewall is much less affected.

The PIX Firewall checks outgoing URL requests with the policy defined on the URL filtering server. PIX Firewall either permits or denies the connection, based on the response from the filtering server.

For further information, refer to either of the following websites:

<http://www.websense.com>

<http://www.n2h2.com>

**Note**

PIX Firewall Version 6.3 or higher supports filtering of HTTPS and FTP sites when using the Websense filtering server. PIX Firewall Version 6.2 or higher supports filtering of long URLs, such as those generated by search engines.

Configurable Proxy Pinging

The Configurable Proxy Pinging feature lets you control ICMP access to PIX Firewall interfaces. This feature shields PIX Firewall interfaces from detection by users on an external network.

**Note**

We recommend that you grant permission for ICMP unreachable message type 3. Denying ICMP unreachable messages disables ICMP Path MTU discovery, which can halt IPSec and PPTP traffic.

Supporting Specific Protocols and Applications

This section describes how the PIX Firewall enables the secure use of specific protocols and applications. It includes the following sections:

- [How Application Inspection Works, page 1-11](#)
- [Voice over IP, page 1-11](#)
- [Multimedia Applications, page 1-13](#)
- [LDAP Version 2 and ILS, page 1-14](#)
- [NetBIOS over IP, page 1-14](#)
- [Forwarding Multicast Transmissions, page 1-14](#)

For further information about application inspection and how it works with different applications, refer to [Chapter 5, “Configuring Application Inspection \(Fixup\).”](#)

How Application Inspection Works

The behavior of certain Internet applications, such as FTP or multimedia applications, requires PIX Firewall to make some adjustments to how it performs NAT or PAT, and for the ports it opens to receive replies to outbound requests for services. Application inspection provides PIX Firewall with the information it needs to make these adjustments.

As described in the [“Address Translation”](#) section, PIX Firewall applies NAT or PAT to the source address of IP packets from hosts for which it is enabled. However, “badly behaved” applications create IP packets with network addresses and other information in the user data portion of the packet. If this information is left unchanged, the application will not work because the address in the source address field will not match the address embedded in the user data field.

To solve this problem, when NAT or PAT is applied to these packets, the application inspection function helps the PIX Firewall find the extra address information so address translation can be applied to it. After changing this addressing information, the PIX Firewall uses application inspection to adjust other fields in the packet that are affected, such as those containing packet length and checksum information.

By default, the PIX Firewall allows replies to outbound requests using many Internet applications, such as HTTP. These services send requests and replies on well-known TCP ports.

However, some applications, such as FTP, use a well-known TCP port to negotiate the use of secondary ports, which are used for the actual exchange of user data. To support the secure use of these applications, PIX Firewall must monitor the negotiation that occurs on the first port to determine on which port replies will be received. Again, it is application inspection that provides the information required to identify and open ports required to receive replies from these applications.

Voice over IP

This section describes the support provided by the PIX Firewall for the transmission of Voice over IP (VoIP) traffic and includes the following topics:

- [CTIQBE \(TAPI\), page 1-12](#)
- [H.323, page 1-12](#)
- [RAS Version 2, page 1-12](#)
- [MGCP, page 1-12](#)

- [SCCP, page 1-12](#)
- [SIP, page 1-13](#)

**Note**

Version 6.2 of the PIX Firewall introduces PAT support for H.323 and SIP. This helps to expand your address space to accommodate the large number of endpoints involved when implementing VoIP networks.

CTIQBE (TAPI)

The Telephony API (TAPI) and Java Telephony API (JTAPI) are protocols used by Cisco VoIP applications. PIX Firewall Version 6.3 introduces support for a specific protocol, Computer Telephony Interface Quick Buffer Encoding (CTIQBE), which use Cisco TAPI Service Provider (TSP) to communicate with Cisco CallManager.

H.323

PIX Firewall Version 6.3 introduces support for H.323 Version 3 and 4, including multiple calls on the same call signaling channel. PIX Firewall Version 5.2 or higher supports the secure use of H.323 Version 2. H.323 is a suite of protocols defined by the International Telecommunication Union (ITU) for multimedia conferences over LANs. Some of the features provided include the following:

- Fast Connect or Fast Start Procedure for faster call setup
- H.245 tunneling for resource conservation, call synchronization, and reduced set up time
- Call redirection
- Conferencing—The conference is not established until both endpoints agree to participate
- Multiple calls on the same call signaling channel (Version 6.3)

RAS Version 2

The Registration, Admission, and Status (RAS) protocol is required by multimedia applications such as video conferencing and Voice over IP that require video and audio encoding. A RAS channel carries bandwidth change, registration, admission, and status messages (following the recommendations in H.225) between endpoints and gatekeepers. Multimedia applications use a large number of dynamically negotiated data and control channels to handle the various visual and auditory streams.

MGCP

Cisco Firewall Version 6.3 introduces support for application inspection of the Media Gateway Control Protocol (MGCP). MGCP is used for controlling media gateways from external call control elements called media gateway controllers or Call Agents.

SCCP

Skinny (or Simple) Client Control Protocol (SCCP) is a simplified protocol used in VoIP networks. Secure handling of this protocol is required when using Cisco CallManager, Cisco IP Phones, and other Cisco IP Telephony products.

When coupled with an H.323 Proxy, an SCCP client can interoperate with H.323 compliant terminals. Application inspection in the PIX Firewall works with SCCP Version 3.1.1. The functionality of PIX Firewall application inspection ensures that all SCCP signalling and media packets can traverse the Firewall by providing NAT of the SCCP signaling packets.

**Note**

PIX Firewall Version 6.3 introduces PAT support for SCCP.

SIP

Session Initiation Protocol (SIP) enables call handling sessions—particularly two-party audio conferences, or “calls.” The PIX Firewall supports SIP VoIP gateways and VoIP proxy servers. It also supports definition using SDP for dynamically allocated UDP ports. In addition, SIP supports the Instant Messaging (IM) Chat feature on Windows XP using Windows Messenger RTC Client version 4.7.0105 only.

Multimedia Applications

Users increasingly make use of a wide range of multimedia applications, many of which require special handling in a firewall environment. The PIX Firewall handles these without requiring client reconfiguration and without becoming a performance bottleneck. The specific multimedia applications supported by the PIX Firewall include the following:

- RealAudio
- Streamworks
- CU-SeeMe
- Intel Internet Phone
- IRC
- Vxtreme
- VDO Live

**Note**

Traffic using specific protocols can be prevented using access lists.

The PIX Firewall allows the secure forwarding of Real Time Streaming Protocol (RTSP) packets. RTSP is used by RealAudio, RealNetworks, Apple QuickTime 4, RealPlayer, and Cisco IP/TV connections. This feature lets the firewall handle multimedia applications including Cisco IP/TV connections.

**Note**

PIX Firewall does not yet have the ability to recognize HTTP cloaking where an RTSP message is hidden within an HTTP message. Also, RTSP is not supported with NAT.

LDAP Version 2 and ILS

PIX Firewall Version 6.2 or higher supports using NAT with Lightweight Directory Access Protocol (LDAP) Version 2, used by the Internet Locator Service (ILS). Applications that depend on ILS include Microsoft NetMeeting and SiteServer Active Directory. These applications use ILS to provide registration and location of end points in the ILS directory.

Earlier versions of PIX Firewall supported NetMeeting, but did not provide support for using NAT with ILS. With the addition of NAT support for LDAP Version 2, PIX Firewall supports NAT for H.323 sessions established by NetMeeting.

NetBIOS over IP

The PIX Firewall supports NetBIOS over IP connections from the internal network to the external network. This lets Microsoft client systems on the internal network, possibly using NAT, access servers, such as Windows NT, located on the external network. This lets security policies encompass Microsoft environments across the Internet and inside an intranet. It lets you use access controls native to the Microsoft environment.

Forwarding Multicast Transmissions

The Internet Group Management Protocol (IGMP) is used to dynamically register specific hosts in a multicast group on a particular LAN with a multicast (MC) router. MC routers efficiently route multicast data transmissions to the hosts on each LAN in an internetwork that are registered to receive specific multimedia or other broadcasts.

PIX Firewall Version 6.2 or higher provides the Stub Multicast Routing (SMR) feature. SMR lets the PIX Firewall function as a “stub router,” which is a device that acts as an IGMP proxy agent. A stub router does not operate as a full MC router, but simply forwards IGMP messages between hosts and MC routers.

Creating a Virtual Private Network

This section introduces Virtual Private Network (VPN) technology and describes how this technology is implemented by the PIX Firewall. It contains the following topics:

- [Virtual Private Networks, page 1-15](#)
- [IPSec, page 1-15](#)
- [Internet Key Exchange \(IKE\), page 1-15](#)
- [Certification Authorities, page 1-16](#)
- [Using a Site-to-Site VPN, page 1-17](#)
- [Supporting Remote Access with a Cisco Easy VPN Server, page 1-18](#)

For basic configuration instructions for using IPSec to create a VPN, refer to [Chapter 6, “Configuring IPSec and Certification Authorities.”](#) For configuration instructions and examples to establish site-to-site VPNs and using certification authorities, refer to [Chapter 7, “Site-to-Site VPN Configuration Examples.”](#) For configuration examples and instructions for creating a remote access VPN, refer to [Chapter 8, “Managing VPN Remote Access.”](#)

Virtual Private Networks

Virtual Private Networks (VPNs) let you securely interconnect geographically distributed users and sites over the public Internet. VPNs can provide lower cost, improved reliability, and easier administration than traditional wide-area networks based on private Frame Relay or dial-up connections. VPNs maintain the same security and management policies as a private network. With a VPN, customers, business partners, and remote users, such as telecommuters, can access enterprise computing resources securely.

IPSec is a standard that defines vendor-independent methods of establishing a VPN. As part of its security functions, the PIX Firewall provides IPSec standards-based VPN capability. With IPSec, data can be transmitted across a public network without fear of observation, modification, or spoofing.

Site-to-site and remote access VPNs are the two main types of VPN, both of which are supported by the PIX Firewall.

IPSec

IPSec provides security for transmission of sensitive information over unprotected networks such as the Internet. IPSec acts at the network layer, protecting and authenticating IP packets between participating IPSec devices (peers), such as PIX Firewall units.

IPSec provides the following network security services:

- Data Confidentiality—The IPSec sender can encrypt packets before transmitting them across a network.
- Data Integrity—The IPSec receiver can authenticate packets sent by the IPSec sender to ensure that the data has not been altered during transmission.
- Data Origin Authentication—The IPSec receiver can authenticate the source of the IPSec packets sent. This service is dependent upon the data integrity service.
- Anti-Replay—The IPSec receiver can detect and reject replayed packets.

**Note**

The term data authentication is generally used to mean data integrity and data origin authentication. Within this chapter, it also includes anti-replay services, unless otherwise specified.

IPSec provides secure tunnels between two peers, such as two PIX Firewall units. You define which packets are considered sensitive and should be sent through these secure tunnels, and you define the parameters that should be used to protect these sensitive packets, by specifying the characteristics of these tunnels. Then, when the IPSec peer sees such a sensitive packet, it sets up the appropriate secure tunnel and sends the packet through the tunnel to the remote peer. The secure tunnel used to transmit information is based on encryption keys and other security parameters, described by security associations (SAs).

**Note**

PIX Firewall Version 6.3 introduces support for the Advanced Encryption Standard (AES) and Diffie-Hellman Group 5.

Internet Key Exchange (IKE)

The process by which IPSec can automatically establish a secure tunnel is divided into two phases:

- Phase 1—This phase, implemented through the Internet Key Exchange (IKE) protocol, establishes a pair of IKE SAs. IKE SAs are used for negotiating one or more IPsec SAs, which are used for the actual transmission of application data.
- Phase 2—This phase uses the secure channel provided by the IKE SAs to negotiate the IPsec SAs. At the end of this phase both peers have established a pair of IPsec SAs, which provide the secure tunnel used for transmission of application data. One of the SA parameters is its lifetime, which enhances IPsec security by causing the SA to automatically expire after a configurable length of time.

The IKE protocol establishes a secure tunnel for negotiating IPsec SAs. It lets you implement IPsec without manual configuration of every IPsec peer. Manual configuration of IPsec peers becomes prohibitively complicated as the number of peers increase, because each peer requires a pair of SAs for every other peer with which it communicates using IPsec.

Like IPsec, IKE uses a pair of SAs to establish a secure tunnel for communication between two peers. However, IKE uses its SAs to securely negotiate SAs for IPsec tunnels, rather than for the transmission of user information.

You can manually configure SAs to establish an IPsec tunnel between two peers. However, this method is not as secure, because manually configured SAs do not automatically expire. In addition, a severe problem of scalability occurs as the number of peers increases. A new pair of SAs is required on each existing peer whenever you add a peer that uses IPsec to your network. For this reason, manual configuration is only used when the remote peer does not support IKE.

IKE SAs can be established by using pre-shared keys, in a way similar to manual configuration of IPsec SAs. This method, however, suffers from the same problems of scalability that affects manual configuration of IPsec SAs. A certification authority (CA) provides a scalable method to share keys for establishing IKE SAs.

Certification Authorities

Understanding how CAs help to configure IKE requires understanding something about public/private key encryption. Public/private keys, also called asymmetric keys, are created in pairs. Data encrypted with one key of this pair can only be unencrypted using the other key. One key is kept secret (called a private key) and the other key is made easily available (the public key). When any peer needs to share a secret with the owner of the private key, it simply encrypts the information using the public key. The only way to unencrypt the original information is by using the private key. Using this method, encrypted information can be shared over a non-secure network without transmitting the secret key required to decipher the encrypted information.

This unique property of public/private key pairs also provides an excellent method of authentication. A public key only unencrypts a message encrypted with the corresponding private key. If a message can be read using a given public key, you know for certain that the sender of the message owns the corresponding private key.

This is where the CA comes in. A public key certificate, or digital certificate, is used to associate a public/private key pair with a given IP address or host name. A certification authority (CA) issues public key certificates for a specific period of time. A CA can be a private (in-house) CA, run by your own organization, or a public CA. A public CA, like VeriSign, is operated by a third party that you trust to validate the identity of each client or server to which it issues a certificate.

Digital certificates are used by the IKE protocol to create the first pair of SAs, which provide a secure channel for negotiating the IPsec SAs. To use certificates for negotiating IKE SAs, both IPsec peers have to generate public/private key pairs, request and receive public key certificates, and be configured to trust the CA that issues the certificates.

Most browsers, by default, trust certificates from well-known CAs, such as VeriSign, and provide options for adding CAs, and for generating and requesting a digital certificate. You can also preconfigure browser software before it is distributed to users with your CA and the necessary certificates.

The procedure for configuring PIX Firewall to use IKE with digital certificates is described in [“Using Certification Authorities”](#) in [Chapter 6, “Configuring IPsec and Certification Authorities.”](#)

Using a Site-to-Site VPN

Site-to-site VPNs are an alternative WAN infrastructure that replace and augment existing private networks using leased lines, Frame Relay, or ATM to connect small office, home office (SOHO) environments. For site-to-site VPNs, the PIX Firewall can interoperate with any Cisco VPN-enabled network device, such as a Cisco VPN router.

Site-to-site VPNs are established between the PIX Firewall and a remote IPsec security gateway. The remote IPsec security gateway can be a PIX Firewall, a Cisco VPN concentrator or VPN-enabled router, or any IPsec-compliant third-party device. For configuration instructions, refer to [Chapter 6, “Configuring IPsec and Certification Authorities,”](#) and for example configurations, refer to [Chapter 7, “Site-to-Site VPN Configuration Examples.”](#)

Supporting Remote Access with a Cisco Easy VPN Server

The PIX Firewall supports mixed VPN deployments, including both site-to-site and remote-access traffic. A remote access VPN uses analog, dial, ISDN, DSL, mobile IP, and cable technologies to securely connect mobile users, telecommuters, and other individual systems to a network protected by the PIX Firewall. Using the PIX Firewall as an Easy VPN Server lets you configure your VPN policy in a single location on the PIX Firewall and then push this configuration to multiple Easy VPN Remote devices. You can use any PIX Firewall unit running Version 6.2 or higher as an Easy VPN Server.

The following are the different types of Cisco Easy VPN Remote devices you can use with a PIX Firewall used as an Easy VPN Server:

- Software clients—Connect directly to the Easy VPN Server but require prior installation and configuration of client software on each host computer. These include the following:
 - Cisco VPN Client Version 3.x (also known as Unity Client 3.x)
 - Cisco VPN 3000 Client Version 2.5 (also known as the Altiga VPN Client Version 2.5)
- Hardware clients—Allow multiple hosts on a remote network to access a network protected by an Easy VPN Server without any special configuration or software installation on the remote hosts. These include the following:
 - Cisco PIX 501 or PIX 506/506E
 - Cisco VPN 3002 Hardware Client
 - Cisco IOS software-based Easy VPN Remote devices (for example, Cisco 800 series and 1700 series routers)

PIX Firewall Version 6.3 introduces support for the following features that improve security, reliability, and scalability of remote access VPNs:

- Individual User Authentication (IUA)—Allows authentication of users on remote access networks protected by an Easy VPN Remote hardware client.
- Secure Unit Authentication (SUA)—Allows additional authentication of an Easy VPN Remote hardware client.
- Configurable policy for Internet access—Provides a configurable policy for controlling access through the Easy VPN Remote device when an IKE tunnel does not exist.
- Easy VPN Server load balancing and redundancy—Allows the Easy VPN Remote device to be directed to a server based on load balancing or availability.
- X.509 certificate support—Allows the use of IPSec Main Mode by providing RSA-SIG support.
- Advanced Encryption Standard (AES) and Diffie-Hellman group 5—Provides additional encryption options for use by the Easy VPN Remote device.

PIX Firewall Version 6.3 introduces support for load balancing and redundancy among a cluster of Easy VPN Servers. It also provides additional client authentication options, such as user-level authentication. For further information about using PIX Firewall as an Easy VPN Server, see [Chapter 8, “Managing VPN Remote Access.”](#) Chapter 8 also includes configuration instructions for using Point-to-Point Protocol (PPTP).

For information about using a PIX 501 or PIX 506/506E as an Easy VPN Remote device, refer to [Chapter 4, “Using PIX Firewall in SOHO Networks.”](#) For information about configuring remote access for other VPN software clients, including L2TP, Windows 2000, and Cisco Secure VPN Client Version 1.1, refer to [Appendix B, “Configuration Examples for Other Remote Access Clients.”](#)

Using PIX Firewall in a Small Office, Home Office Environment

This section describes features provided by the PIX Firewall that support its use in a small office, home office (SOHO) environment. It includes the following topics:

- [Using the PIX Firewall as an Easy VPN Remote Device, page 1-19](#)
- [PPPoE, page 1-19](#)
- [DHCP Server, page 1-19](#)
- [DHCP Client, page 1-20](#)

For information about configuring the features in this section, refer to [Chapter 4, “Using PIX Firewall in SOHO Networks.”](#)

Using the PIX Firewall as an Easy VPN Remote Device

You can use a PIX 501 or PIX 506/506E running PIX Firewall Version 6.2 or higher as an Easy VPN Remote hardware client when connecting to an Easy VPN Server, such as a Cisco VPN 3000 Concentrator or another PIX Firewall. An Easy VPN Remote hardware client allows hosts running on the LAN behind the PIX Firewall to connect to an Easy VPN Server without individually running any VPN client software.

PPPoE

Point-to-Point Protocol over Ethernet (PPPoE) combines two widely accepted standards, Ethernet and the Point-to-Point Protocol (PPP), to provide an authenticated method of assigning IP addresses to client systems. PPPoE clients are typically personal computers connected to an ISP over a remote broadband connection, such as DSL or cable service. ISPs deploy PPPoE because it provides a method of supporting high-speed broadband access using the existing remote access infrastructure and that provides superior ease of use to customers.

PIX Firewall Version 6.2 or higher provides PPPoE client functionality. This lets small office, home office (SOHO) users of the PIX Firewall connect to ISPs using DSL modems.



Note

The PIX Firewall PPPoE client can only be enabled on the outside interface.

By using PPPoE, ISPs can deploy DSL without changing their existing infrastructure, which is typically based on the use of PPP over dial-up connections.

DHCP Server

Dynamic Host Configuration Protocol (DHCP) is a protocol that supplies automatic configuration parameters to Internet hosts. This protocol has two components:

- Protocol for delivering host-specific configuration parameters from a DHCP server to a host (DHCP client)
- Mechanism for allocating network addresses to hosts

A DHCP server is simply a computer that provides configuration parameters to a DHCP client, and a DHCP client is a computer or network device that uses DHCP to obtain network configuration parameters.

When functioning as a DHCP server, the PIX Firewall dynamically assigns IP addresses to DHCP clients from a pool of designated IP addresses.

PIX Firewall Version 6.2 or higher supports DHCP option 66 and DHCP option 150 requests. This lets DHCP clients, such as Cisco IP Phones, obtain the address of a designated TFTP server. Cisco IP Phones typically obtain the configuration information required to connect to a Cisco CallManager server from a TFTP server. A DHCP option 66 request causes the DHCP server to provide the address of a single TFTP server; an option 150 request obtains a list of TFTP servers.

PIX Firewall Version 6.3 or higher allows the use of the DHCP server on any interface. Previous versions only allowed the use of the DHCP server on the inside interface.

DHCP Relay

PIX Firewall Version 6.3 provides support for DHCP relay. The DHCP relay agent provided helps dynamically assign IP addresses to hosts on the inside interfaces of the PIX Firewall. When the DHCP relay agent receives a request from a host on an inside interface, it forwards the request to one of the specified DHCP servers on an outside interface.

DHCP Client

DHCP client support within the PIX Firewall is designed for use within a small office, home office (SOHO) environment using a PIX Firewall that is directly connected to a DSL or cable modem that supports the DHCP server function.

**Note**

The PIX Firewall DHCP client can only be enabled on the outside interface.

With the DHCP client feature enabled on a PIX Firewall, the PIX Firewall functions as a DHCP client to a DHCP server allowing the server to configure the outside interface with an IP address, subnet mask, and optionally a default route.

**Note**

Use of the DHCP client feature to acquire an IP address from a generic DHCP server is not supported. Also, the PIX Firewall DHCP client does not support failover configurations.

Accessing and Monitoring PIX Firewall

This section describes how you access and monitor the PIX Firewall system. It contains the following topics:

- [Connecting to the Inside Interface of a Remote PIX Firewall](#), page 1-21
- [Cisco PIX Device Manager \(PDM\)](#), page 1-21
- [Command Authorization](#), page 1-21

- [Telnet Interface](#), page 1-22
- [SSH Version 1](#), page 1-22
- [NTP](#), page 1-22
- [Auto Update](#), page 1-22
- [Capturing Packets](#), page 1-22
- [Using SNMP](#), page 1-22
- [XDMCP](#), page 1-23
- [Using a Syslog Server](#), page 1-23
- [FTP and URL Logging](#), page 1-23
- [Integration with Cisco IDS](#)

For information about configuring the features described in this section, refer to [Chapter 9, “Accessing and Monitoring PIX Firewall.”](#)

Connecting to the Inside Interface of a Remote PIX Firewall

PIX Firewall Version 6.3 allows a remote management connection to the inside interface of a PIX Firewall over a VPN tunnel. This feature is designed to allow an administrator to remotely manage a PIX Firewall used as an Easy VPN Remote device, which typically has an IP address dynamically assigned to its outside interface.

Cisco PIX Device Manager (PDM)

The Cisco PIX Device Manager (PDM) is a browser-based configuration tool that lets you set up, configure, and monitor your PIX Firewall from a graphical user interface (GUI), without any extensive knowledge of the PIX Firewall command-line interface (CLI). PDM provides a management interface from Windows NT, Windows 95, Windows 2000, or Solaris web browsers. PDM access is password protected, uses Secure Sockets Layer (SSL) for encryption, and restricts access to client systems with designated IP addresses.

Command Authorization

PIX Firewall Version 6.2 or higher provides a more flexible method of authenticating and authorizing administrative access to the PIX Firewall. Similar to Cisco IOS software command authorization, PIX Firewall now supports up to 16 privilege levels to be assigned to CLI commands. You can create user accounts or login contexts tied to these privilege levels either locally or using a TACACS+ server. Additional information is also now provided regarding the usage of CLI commands, such as command tracing by means of syslog messages.

Telnet Interface

The PIX Firewall Telnet interface provides a command-line interface similar to Cisco IOS software. The Telnet interface lets you remotely manage the PIX Firewall via the console interface. The Telnet interface limits access of the Telnet interface to specified client systems within the inside network (based on source address) and is password protected. If the inside network is not secure and sessions on the LAN can be snooped, you should limit use of the Telnet interface. If IPSec is configured, you can also access the PIX Firewall console from the outside interface.

SSH Version 1

PIX Firewall supports the SSH remote shell functionality as provided in SSH Version 1. SSH allows secure remote configuration of a PIX Firewall, providing encryption and authentication capabilities.

NTP

PIX Firewall Version 6.2 or higher allows the PIX Firewall to function as a client for Network Time Protocol (NTP) Version 3.0 servers. As an NTP client, the PIX Firewall can synchronize its time to a set of distributed time servers operating in a self-organizing, hierarchical configuration. A precisely coordinated time is required for validating certificate revocation lists (CRLs) when implementing a VPN using Public Key Infrastructure (PKI). A more precise time also improves the accuracy of log entries used for troubleshooting or monitoring security threats.

Auto Update

Auto Update is a protocol specification supported by PIX Firewall Version 6.2 or higher. This specification lets the PIX Firewall download configurations, software images, and perform basic monitoring from an Auto Update Server (AUS) in a centralized location.

Capturing Packets

PIX Firewall Version 6.2 or higher provides an enhanced and improved packet capture capability that lets you capture packets, including ARP packets, to a linear buffer. You can use access lists to define packets to capture on specific interfaces of the PIX Firewall. You can then display the captured packets on any console or transfer the contents of the packet capture buffer to a TFTP server.

Using SNMP

The PIX Firewall provides support for network monitoring using Simple Network Management Protocol (SNMP). The SNMP interface lets you monitor the PIX Firewall through traditional network management systems. The PIX Firewall only supports the SNMP GET command, which allows read-only access.

The SNMP Firewall and Memory Pool MIBs extend the number of traps you can use to discover additional information about the state of the PIX Firewall, including the following events:

- Buffer usage from the **show block** command
- Connection count from the **show conn** command
- Failover status
- Memory usage from the **show memory** command

**Note**

PIX Firewall Version 6.2 or higher supports monitoring CPU utilization through SNMP. This feature allows network administrators to monitor the PIX Firewall CPU usage using SNMP management software, such as HP OpenView, for capacity planning. This CPU usage information is the same as that shown by the **show cpu usage** command.

XDMCP

The PIX Firewall supports connections using XDMCP (X Display Manager Control Protocol) using the **established** command. This feature negotiates an XWindows session and creates an embryonic connection at destination port 6000. XDMCP handling is enabled by default, like other UDP application inspection functions.

Using a Syslog Server

The PIX Firewall sends messages in TCP and UDP Syslog messages to any existing syslog server and provides a syslog server for use on a Windows NT system. The Windows NT Syslog server can provide time-stamped syslog messages, accept messages on alternate ports, and be configured to stop PIX Firewall traffic if messages cannot be received. You can also configure the Windows NT Syslog server to stop PIX Firewall connections if the Windows NT log disk fills or if the server goes down.

FTP and URL Logging

The FTP and URL logging feature lets you view inbound and outbound FTP commands entered by your users as well as the URLs they use to access other sites. You can use this feature to monitor user access of internal and external sites. It provides data you can use to block access to problem sites. You enable this feature with the **logging trap debugging** command statement. Note that this feature can generate a huge amount of syslog data on a high-traffic PIX Firewall.

Integration with Cisco IDS

The PIX Firewall is interoperable with the Cisco Intrusion Detection System (Cisco IDS). The PIX Firewall traps IDS signatures and sends these as syslog messages the Syslog server. This feature supports only single-packet IDS signatures.

PIX Firewall Failover

The PIX Firewall failover feature lets you connect two identical PIX Firewall units with a special failover cable to achieve a fully redundant firewall solution.

To configure the PIX Firewall failover feature, refer to [Chapter 10, “Using PIX Firewall Failover.”](#) For instructions about upgrading failover from a previous version, refer to [“Upgrading Failover Systems from a Previous Version”](#) in [Chapter 11, “Changing Feature Licenses and System Software.”](#)

[Table 1-1](#) summarizes the support for the failover feature provided by different PIX Firewall models.

Table 1-1 Support for Failover

PIX Firewall Model	Support for Failover
PIX 501	Not supported
PIX 506/506E	Not supported
PIX 515/515E	Requires additional license
PIX 525	Ships with full support
PIX 535	Ships with full support

When implementing failover, one unit functions as the active unit, while the other assumes the role of the standby unit. Both units require the same configuration and run the same software version.

PIX Firewall Version 6.2 or higher supports failover between two units connected over a dedicated Ethernet interface (LAN-based failover). LAN-based failover eliminates the need for a special failover cable and overcomes the distance limitations imposed by the failover cable required to implement failover on earlier versions of PIX Firewall.

With failover, two PIX Firewall units synchronize configuration and session state information so that if the active unit fails, the standby unit can assume its role without any interruption in network connectivity or security.

Upgrading the PIX Firewall OS and License

The PIX Firewall software is a specialized, hardened operating system that is continuously being improved to provide greater performance, security, and interoperability with Internet devices and applications. For information about obtaining and installing the latest software release, refer to [Chapter 11, “Changing Feature Licenses and System Software.”](#)

With PIX Firewall Version 6.2 or higher, you can upgrade your license without reinstalling the operating system software. A new CLI command has been added to let you upgrade your activation key from the command-line interface without reinstalling the software image and without entering monitor mode. For detailed instructions, refer to [Chapter 11, “Changing Feature Licenses and System Software.”](#)

You can use a Trivial File Transfer Protocol (TFTP) configuration server to obtain configuration for multiple PIX Firewall units from a central source. However, TFTP is inherently insecure so you should not use it over networks where sharing privileged information in clear text is a violation of your network security policy.

You can also use TFTP to download a .bin image from CCO to a PIX Firewall to upgrade or replace the software image on the PIX Firewall. TFTP does not perform any authentication when transferring files, so a username and password on the remote host are not required.

Using the Command-Line Interface

This section includes the following topics, which describe how to use the PIX Firewall command-line interface (CLI):

- [Access Modes, page 1-25](#)
- [Accessing Configuration Mode, page 1-26](#)
- [Abbreviating Commands, page 1-27](#)
- [Backing Up Your PIX Firewall Configuration, page 1-27](#)
- [Command Line Editing, page 1-28](#)
- [Filtering Show Command Output, page 1-28](#)
- [Command Output Paging, page 1-29](#)
- [Comments, page 1-29](#)
- [Configuration Size, page 1-29](#)
- [Help Information, page 1-30](#)
- [Viewing the Default Configuration, page 1-30](#)
- [Resetting the Default Configuration, page 1-30](#)
- [Clearing and Removing Configuration Settings, page 1-31](#)

**Note**

The PIX Firewall CLI uses similar syntax and other conventions to the Cisco IOS CLI, but the PIX Firewall operating system is not a version of Cisco IOS software. Do not assume that a Cisco IOS CLI command works or has the same function with the PIX Firewall.

Access Modes

PIX Firewall Version 6.2 or higher supports for up to 16 levels of command authorization. This is similar to what is available with Cisco IOS software. With this feature, you can assign specific PIX Firewall commands to one of 16 levels. You can either assign separate passwords for each privilege level or perform authentication using a local or remote AAA database of user accounts.

For information about configuring this feature, refer to the “[Connecting to PIX Firewall Over a VPN Tunnel](#)” section in [Chapter 9, “Accessing and Monitoring PIX Firewall.”](#)

The PIX Firewall provides five administrative access modes:

- Unprivileged mode—Available without entering a password, when you first access the PIX Firewall. In this mode, the PIX Firewall displays the “>” prompt and lets you enter a small number of commands. With PIX Firewall Version 6.2 or higher, commands in this mode are mapped to privilege Level 0, by default.
- Privileged mode—Displays the “#” prompt and lets you change configuration information. Any unprivileged command also works in privileged mode. Use the **enable** command to start privileged mode and the **disable**, **exit**, or **quit** commands to exit.

In PIX Firewall Version 6.2 or higher, all privileged mode commands are mapped to privilege Level 15, by default. You can assign enable passwords to other privilege levels and reassign specific commands to each level.

- Configuration mode—Displays the prompt `<pix_name>(config)#`, where *pixname* is the host name assigned to the PIX Firewall. You use configuration mode to change system configuration. All privileged, unprivileged, and configuration commands work in this mode. Use the **configure terminal** command to start configuration mode and the **exit** or **quit** commands to exit.
- Subcommand mode—Displays the prompt `<pix_name>(config-<main_cmd_name>)#`, where *pixname* is the host name assigned to the PIX Firewall and *main_cmd_name* is the object grouping command used to enter subcommand mode. Object grouping is a way to simplify access control by letting you apply access control statements to groups of network objects, such as protocols or hosts. For further information about enabling and using this mode, refer to the “[Simplifying Access Control with Object Grouping](#)” section in [Chapter 3, “Controlling Network Access and Use.”](#)
- Monitor mode—This is a special mode that enables you to update the image over the network. While in the monitor mode, you can enter commands specifying the location of the TFTP server and the binary image to download. For information about using monitor mode to upgrade your PIX Firewall software, refer to [Chapter 11, “Changing Feature Licenses and System Software.”](#)

Accessing Configuration Mode

Perform the following steps to access the PIX Firewall configuration mode:

-
- Step 1** Start your terminal emulation program.
- Step 2** Power on the PIX Firewall. On newer models, the switch is at the back, on older models, at the front.
- Step 3** If you are configuring a PIX 506/506E, PIX 515/515E, PIX 525, or PIX 535 and your site downloads configuration images from a central source with TFTP, look for the following prompt in the startup messages:

```
Use BREAK or ESC to interrupt flash boot.
```

PIX Firewall displays this prompt for 10 seconds. To download an image, press the **Escape** key to start boot mode. If you are not downloading an image, ignore the prompt or press the Space bar to start immediately and PIX Firewall starts normally.

- Step 4** After the startup messages appear, you are prompted with the following unprivileged mode prompt:

```
pixfirewall>
```

Enter the following command:

```
enable privilegelevel
```

Replace *privilegelevel* with a number from 0 to 15, indicating the privilege level to which you require access. If you omit this parameter, the system assumes you are seeking access to privilege Level 15.

With PIX Firewall Version 6.2 or higher, you can configure up to fifteen different enable passwords for different privilege levels. By default, all commands are assigned to Level 0 or Level 15, and only Level 15 is preconfigured with a password.

Step 5 The following prompt appears:

```
Password:
```

Press the **Enter** key.

Step 6 You are now in privilege Level 15, which lets you use all the commands assigned to this privilege level. The following prompt appears:

```
pixfirewall#
```

Type **configure terminal** and press **Enter**. You are now in configuration mode.



Note

If the Command Authorization feature (introduced in PIX Firewall Version 6.2) is enabled, the commands you are permitted to enter are determined by the administrative privilege level to which your user account has been assigned. For information about configuring this feature, refer to the “[Connecting to PIX Firewall Over a VPN Tunnel](#)” section in [Chapter 9, “Accessing and Monitoring PIX Firewall.”](#)”

Abbreviating Commands

You can abbreviate most commands down to the fewest unique characters for a command; for example, you can enter **wr t** to view the configuration instead of entering the full command **write terminal**, or you can enter **en** to start privileged mode and **con te** to start configuration mode. In addition, you can enter **0** to represent **0.0.0.0**.

Backing Up Your PIX Firewall Configuration

You should back up your configuration in at least one of the following ways:

- Store the configuration in Flash memory with the **write memory** command. Should the need arise, you can restore a configuration from Flash memory using the **configure memory** command.
- Use the **write terminal** command to list the configuration. Then cut and paste the configuration into a text file. Then archive the text file. You can restore a configuration from a text file using the **configure terminal** command and pasting the configuration either line by line or as a whole.
- Store the configuration on another system using the **tftp-server** command to initially specify a host and the **write net** command to store the configuration.
- If you have a PIX 520 or older model, store the configuration on a diskette using the **write floppy** command. If you are using Windows, make sure the diskette is IBM formatted. If you are formatting a disk, access the MS-DOS command prompt and use the **format** command. Do not back up your configuration to the PIX Firewall boot disk.

Each image you store overwrites the last stored image.

Should the need arise, you can restore your configuration from Flash memory with the **configure memory** command, or from diskette with the **configure floppy** command.

Command Line Editing

PIX Firewall uses the same command-line editing conventions as Cisco IOS software. You can view all previously entered commands with the **show history** command or individually with the up arrow or **^p** command. Once you have examined a previously entered command, you can move forward in the list with the down arrow or **^n** command. When you reach a command you wish to reuse, you can edit it or press the **Enter** key to start it. You can also delete the word to the left of the cursor with **^w**, or erase the line with **^u**.

PIX Firewall permits up to 512 characters in a command; additional characters are ignored.

Filtering Show Command Output

With PIX Firewall Version 6.3, you can use the “pipe” operator (**|**) with any **show** command and include a filter option and filtering expression. The filtering is performed by matching each output line with a regular expression, similar to Cisco IOS software. By selecting different filter options you can include or exclude all output that matches the expression. You can also display all output beginning with the line that matches the expression.

The syntax for using filtering options with the **show** command is as follows:

```
show command | <include|exclude|begin|grep <-v>> <regexp>
```

In this command string, the first vertical bar (**|**) is the pipe operator and must be included in the command. This operator directs the output of the **show** command to the filter. In the syntax diagram, the other vertical bars (**|**) indicate alternative options and are not part of the command.

The **include** option includes all output lines that match the regular expression. The **grep** option without **-v** has the same effect. The **exclude** option excludes all output lines that match the regular expression. The **grep** option with **-v** has the same effect. The **begin** option shows all the output lines starting with the line that matches the regular expression.

Replace *regexp* with any Cisco IOS regular expression. The regular expression is not enclosed in quotes or double-quotes, so be careful with trailing white spaces, which will be taken as part of the regular expression.

When creating regular expressions, you can use any letter or number that you want to match. In addition, certain keyboard characters have special meaning when used in regular expressions. [Table 1-2](#) lists the keyboard characters that have special meaning.

Table 1-2 Using Special Characters in Regular Expressions

Character Type	Character	Special Meaning
period	.	Matches any single character, including white space.
asterisk	*	Matches 0 or more sequences of the pattern.
plus sign	+	Matches 1 or more sequences of the pattern.
caret	^	Matches the beginning of the input string.
dollar sign	\$	Matches the end of the input string.
underscore	_	Matches a comma (,), left brace ({}), right brace (}), left parenthesis, right parenthesis, the beginning of the input string, the end of the input string, or a space.
brackets	[]	Designates a range of single-character patterns.

Table 1-2 Using Special Characters in Regular Expressions

Character Type	Character	Special Meaning
hyphen	-	Separates the end points of a range.
parentheses	()	(Border Gateway Protocol (BGP) specific) Designates a group of characters as the name of a confederation.

Command Output Paging

On commands such as **help** or **?**, **show**, **show xlate**, or other commands that provide long listings, you can determine if the information displays a screenful and pauses, or lets the command run to completion. The **pager** command lets you choose the number of lines to display before the More prompt appears.

When paging is enabled, the following prompt appears:

```
<--- More --->
```

The More prompt uses syntax similar to the UNIX **more** command:

- To view another screenful, press the Space bar.
- To view the next line, press the **Enter** key.
- To return to the command line, press the **q** key.

Comments

You can precede a line with a colon (:) to create a comment. However, the comment only appears in the command history buffer and not in the configuration. Therefore, you can view the comment with the **show history** command or by pressing an arrow key to retrieve a previous command, but because the comment is not in the configuration, the **write terminal** command does not display it.

You can also store configurations with comments preceded by a colon or exclamation mark on a server and then use the **configure net** *[[location]:[filename]]* command to load the configuration from a TFTP server to the PIX Firewall. Replace *location* with the TFTP server name and *filename* with the configuration file name. The PIX Firewall will prune the comments and they will not be visible in the PIX Firewall configuration listing.

To add comments to access lists use the **access-list id [line line-num] remark text** command. Replace *id* with the identifier for the access list, replace *text* with up to 100 characters, and replace *line-num* with the line number where you want to insert the text. The remark can be placed before or after an access-list command statement, but place it in a consistent position so it is clear which access list the remark describes. You can also add comments to object groups using the **description text** parameter after the **object-group** command. For more information about access lists and object groups, refer to Chapter 2, “Controlling Network Access and Use.”

Configuration Size

For PIX Firewall Version 5.3(2) and higher, the PIX 525 and PIX 535 support configurations up to 2 MB. The maximum size for the PIX 501 is 256 KB. The maximum configuration size for all other PIX Firewall platforms is 1 MB. For PIX Firewall models using software before Version 5.3(2), the maximum configuration size is 350 KB.

**Note**

Regardless of the platform, smaller configuration sizes are recommended to ensure optimum performance.

Use the UNIX **wc** command or a Windows word processing program, such as Microsoft Word, to view the number of characters in the configuration.

Help Information

Help information is available from the PIX Firewall command line by entering **help** or a question mark to list all commands, or after a command to list command syntax; for example, **arp?**.

The number of commands listed when you use the question mark or **help** command differs by access mode so that unprivileged mode offers the least commands and configuration mode offers the greatest number of commands.

In addition, you can enter any command by itself on the command line and then press **Enter** to view the command syntax.

Viewing the Default Configuration

When you power on your PIX Firewall for the first time, the configuration comes with many of the basic commands required to get started. The configuration you first receive is known as the default configuration. You can use the **write terminal** command to view your configuration at any time. Also use the **write memory** command frequently to save your configuration to Flash memory.

Resetting the Default Configuration

If you make a mistake configuring a PIX 501 or PIX 506/506E, or need to restore the default configuration for any reason, enter the following command:

```
config factory default [inside-ip-address [address-mask]]
```

This command writes the factory default configuration to memory. If you specify the optional *inside-ip-address* and *address-mask* parameters, the command adjusts the default configuration based on the specified IP address and subnetwork mask.

If you enter this command on other PIX Firewall platforms that do not support it, you will receive the following message:

The config factory default command is only supported on the PIX 501 or PIX 506E.

**Note**

The factory default setting for the DHCP address pool size is determined by your PIX Firewall platform and your feature license. For information about the possible options, refer to “[Using the PIX Firewall DHCP Client](#)” in Chapter 4, “[Using PIX Firewall in SOHO Networks.](#)”

Clearing and Removing Configuration Settings

To clear all the configuration for a specified command and all its subcommands, enter the following command:

```
clear configurationcommand [subconfigurationcommand]
```

This command clears all the current configuration for the specified configuration command. If you only want to clear the configuration for a specific subcommand, you can enter a value for *subconfigurationcommand*.

To disable the specific parameters or options of a command or subcommand, enter the **no** form of the command, as follows:

```
no configurationcommand [subconfigurationcommand] qualifier [...]
```

In this case, you use the **no** command to remove the specific configuration identified by *qualifier*.

Before You Start Configuring PIX Firewall

The key to successful implementation of your PIX Firewall is having a clear security policy that describes how to control access and use of your organization's network resources. You need to understand your security policy to ensure that you implement and configure the PIX Firewall in a way that supports this policy. Your security policy should have the support of the various departments and administrators responsible for its implementation and should be well understood by network users.

Before you configure the PIX Firewall, sketch out a network diagram with IP addresses that you will assign to the PIX Firewall and those of routers on each interface. If you have more than two interfaces in the PIX Firewall, note the security level for each interface.

Where to Go from Here

- To complete the configuration required to connect your PIX Firewall to your existing network, refer to [Chapter 2, “Establishing Connectivity.”](#)
- To allow or restrict specific types of network activity and access, refer to [Chapter 3, “Controlling Network Access and Use.”](#)
- To use the application inspection and the **fixup** command to control the secure use of specific applications and services, refer to [Chapter 5, “Configuring Application Inspection \(Fixup\).”](#)
- To use a PIX Firewall as an Easy VPN Remote device in relation to an Easy VPN Server or to use it with DHCP or PPPoE, refer to [Chapter 4, “Using PIX Firewall in SOHO Networks.”](#)
- To perform basic VPN configuration, refer to [Chapter 6, “Configuring IPsec and Certification Authorities.”](#)
- To configure or use PIX Firewall system management tools, refer to [Chapter 9, “Accessing and Monitoring PIX Firewall.”](#)
- To configure the PIX Firewall failover feature, refer to [Chapter 10, “Using PIX Firewall Failover.”](#)
- To upgrade the software image on your PIX Firewall, refer to [Chapter 11, “Changing Feature Licenses and System Software.”](#)

For more information on firewalls, refer to:

- Bernstein, T., Bhimani, A.B., Schultz, E. and Siegel, C. A. *Internet Security for Business*. Wiley. Information about this book is available at: <http://www.wiley.com>
- Chapman, D. B. & Zwicky, E. D. *Building Internet Firewalls*. O'Reilly. Information on this book is available at: <http://www.ora.com/>
- Cheswick, W. and Bellovin, S. *Firewalls & Internet Security*. Addison-Wesley. Information about this book is available at: <http://www.aw.com>
- Garfinkel, S. and Spafford, G. *Practical UNIX Security*. O'Reilly. Information about this book is available at: <http://www.ora.com/>
- Stevens, W. R. *TCP/IP Illustrated, Volume 1 The Protocols*. Addison-Wesley. Information about this book is available at: <http://www.aw.com>
- Cisco's Products and Technologies information on PIX Firewall is available at: <http://www.cisco.com/warp/public/cc/pd/fw/sqfw500/index.shtml>



Establishing Connectivity

This chapter describes the basic preparation and configuration required to use the network firewall features of the Cisco PIX Firewall. After completing this chapter, you will be able to establish basic connectivity from your internal network to the public Internet or resources on your perimeter network. The basic configuration described in this chapter lets protected network users start connections, but prevents users on unprotected networks from accessing (or attacking) protected hosts.

This chapter contains the following sections:

- [Initial Configuration Checklist, page 2-1](#)
- [Setting Default Routes, page 2-3](#)
- [Configuring PIX Firewall Interfaces, page 2-4](#)
- [Establishing Outbound Connectivity with NAT and PAT, page 2-7](#)
- [Configuring the PIX Firewall for Routing, page 2-12](#)
- [Testing and Saving Your Configuration, page 2-21](#)
- [Basic Configuration Examples, page 2-24](#)
- [Using VLANs with the Firewall, page 2-33](#)
- [Using Outside NAT, page 2-37](#)
- [Policy NAT, page 2-40](#)
- [Enabling Stub Multicast Routing, page 2-43](#)

Initial Configuration Checklist

[Table 2-1](#) summarizes the tasks you should perform when you first configure your PIX Firewall to establish unrestricted outbound connectivity through the firewall. For instructions for controlling outbound connectivity or establishing inbound connectivity, see [Chapter 3, “Controlling Network Access and Use.”](#)

Table 2-1 Initial Configuration Checklist

Task	Explanation	Procedure
If you have purchased a new feature license, upgrade your feature license	If you have purchased (or need to purchase) a new activation key for your PIX Firewall, upgrade your license before configuring the firewall.	Refer to the “Upgrading Your License by Entering a New Activation Key” section on page 11-2 in Chapter 11, “Changing Feature Licenses and System Software.”
Deny ICMP traffic to the outside interface	<p>By default, the PIX Firewall denies all inbound traffic through the outside interface. Before enabling inbound connectivity through the outside interface, you should consider configuring the PIX Firewall to deny all ICMP traffic to the outside interface.</p> <p>If no ICMP control list is configured, then the PIX Firewall accepts all ICMP traffic that terminates at any interface, including the outside interface.</p>	<p>To deny all ICMP traffic, including ping requests, through the outside interface, enter the following command:</p> <pre>icmp deny any outside</pre> <p>Enter this command for each additional interface on which you want to deny ICMP traffic.</p> <p>Note To test connectivity through the outside interface, temporarily change this setting, as described in the “Testing and Saving Your Configuration” section on page 2-21.</p> <p>For more information about the icmp command, refer to the <i>Cisco PIX Firewall Command Reference</i>.</p>
Prevent fragmented packets	<p>By default, the PIX Firewall accepts up to 24 fragments to reconstruct a full IP packet. Based on your network security policy, you should consider configuring the PIX Firewall to prevent fragmented packets from traversing the firewall.</p> <p>The PIX Firewall FragGuard feature provides IP fragmentation protection even without explicitly denying fragmented packets.</p>	<p>To prevent fragmented packets on the outside and inside interfaces enter the following command:</p> <pre>fragment chain 1 outside fragment chain 1 inside</pre> <p>Enter this command for each additional interface on which you want to prevent fragmented packets.</p> <p>Note Adjust this setting to allow Network File System (NFS) connectivity through the interface.</p> <p>Setting the limit to 1 means that all packets must be unfragmented.</p> <p>For more information about the fragment command, refer to the <i>Cisco PIX Firewall Command Reference</i>.</p>
Set default routes	Configure the default routes on your routers and hosts to forward traffic to the PIX Firewall.	Refer to the “Setting Default Routes” section on page 2-3.

Table 2-1 Initial Configuration Checklist (continued)

Task	Explanation	Procedure
Configure PIX Firewall interfaces	Assign an IP address and subnet mask to each interface in your PIX Firewall that connects to another network. All interfaces in a new PIX Firewall are shut down by default. You need to explicitly enable each interface you are using. Security levels let you control access between systems on different interfaces. You can use the default interface names and security levels or change them according to your security policy.	Refer to the “Configuring PIX Firewall Interfaces” section on page 2-4.
Configure the PIX Firewall for routing	You can configure each inside or perimeter PIX Firewall interface for the Routing Information Protocol (RIP) or Open Shortest Path First (OSPF) routing protocol. You can also configure the PIX Firewall to broadcast an inside or perimeter interface as a “default” route.	Refer to the “Configuring the PIX Firewall for Routing” section on page 2-12.
Establish outbound connectivity	Enable Network Address Translation (NAT) and Port Address Translation (PAT) to establish outbound connectivity from hosts on higher security interfaces to hosts on lower security interfaces.	Refer to the “Testing and Saving Your Configuration” section on page 2-21.
Test connectivity	Temporarily enable ICMP messages to test that a host is reachable through the PIX Firewall.	Refer to the “Testing and Saving Your Configuration” section on page 2-21.
Save your configuration	When you complete entering commands in the configuration, save it to Flash memory and then reboot the PIX Firewall.	Refer to the “Saving Your Configuration” section on page 2-24.

Setting Default Routes

This section describes how to set default routes on devices and hosts that communicate with the PIX Firewall. It includes the following topics:

- [Setting Default Routes for Network Routers, page 2-3](#)
- [Setting the Default Route for Network Hosts, page 2-4](#)

Setting Default Routes for Network Routers

A route, which is either statically defined or dynamically discovered, specifies the path used by a router or host to forward IP packets. You must define a special route, called the default route, for forwarding packets when no route is known. Packets destined for an unknown network are forwarded to the default router, which is sometimes called the gateway of last resort.

To configure the default routes on a Cisco IOS router to forward traffic to the PIX Firewall complete the following steps:

-
- Step 1** Telnet to the router that connects to the inside interface of the PIX Firewall, or connect to the router's console port.
- If you are using a Windows PC, you can connect to the console port using the HyperTerminal program. You will need to know the password for the router.
- Step 2** Access the Cisco IOS configuration mode.
- Step 3** Set the default route to the inside interface of the PIX Firewall with the following Cisco IOS CLI command:
- ```
ip route 0.0.0.0 0.0.0.0 if_address
```
- For each PIX Firewall interface that is connected to a router, replace *if\_address* with the IP address of the PIX Firewall interface.
- Step 4** Enter the **show ip route** command and make sure that the connected PIX Firewall interface is listed as the "gateway of last resort."
- Step 5** Clear the ARP cache with the **clear arp** command. Then enter **ctrl-z** to exit configuration mode.
- Step 6** From the router, if you changed the default route, use the **write memory** command to store the configuration in Flash memory.
- Step 7** Connect to other routers on the inside and each perimeter interface of the PIX Firewall and repeat Steps 1 through 6 for each PIX Firewall interface and router.
- Step 8** If you have routers on networks subordinate to the routers that connect to the PIX Firewall's interfaces, configure them so that their default routes point to the router connected to the PIX Firewall and then clear their ARP caches as well.
- 

## Setting the Default Route for Network Hosts

Each host on the same subnet as the inside or perimeter interfaces should have its default route pointing to the PIX Firewall. Refer to the documentation for the operating system of a specific host for instructions for setting the default route.

## Configuring PIX Firewall Interfaces

This section includes the following topics, which describe the configuration required for each PIX Firewall interface:

- [Assigning an IP Address and Subnet Mask, page 2-5](#)
- [Identifying the Interface Type, page 2-5](#)
- [Changing Interface Names or Security Levels, page 2-6](#)



## Assigning an IP Address and Subnet Mask

Assign an IP address to each interface in your PIX Firewall that connects to another network. PIX Firewall interfaces do not have IP addresses until you assign them. The format for the **ip address** command is as follows:

```
ip address interface_name ip_address netmask
```

- Replace *interface\_name* with the name assigned to each PIX Firewall interface. By default, the lowest security interface is named **outside**, while the highest security interface is named **inside**. Use the **nameif** command to change the default name of an interface.
- Replace *ip\_address* with the IP address you specify for the interface.

The IP addresses that you assign should be unique for each interface. Do not use an address you previously used for routers, hosts, or with any other PIX Firewall command, such as an IP address in the global pool or for a static.

- Replace *netmask* with the appropriate network mask for the IP subnetwork.

For example, 255.0.0.0 for a Class A address (those that begin with 1 to 127), use 255.255.0.0 for Class B addresses (those that begin with 128 to 191), and 255.255.255.0 for Class C addresses (from those that begin from 192 to 223). Do not use 255.255.255.255 for an interface connected to the network because this will stop traffic on that interface. If subnetting is in use, use the subnet in the mask; for example, 255.255.255.228.

Always specify a network mask with the **ip address** command. If you let PIX Firewall assign a network mask based on the IP address, you may not be permitted to enter subsequent IP addresses if another interface's address is in the same range as the first address.

For example, if you specify an inside interface address of 10.1.1.1 without specifying a network mask and then try to specify 10.1.2.2 for a perimeter interface address, PIX Firewall displays the error message, "Sorry, not allowed to enter IP address on same network as interface *n*." To fix this problem, reenter the first command specifying the correct network mask for the inside interface. Then enter the **ip address** command for the perimeter interface, including the network mask.

Use the **show ip** command to view the commands you entered. If you make a mistake while entering a command, reenter the same command with new information.

An example **ip address** command follows:

```
ip address inside 192.168.1.1 255.255.255.0
```

## Identifying the Interface Type

All interfaces in a new PIX Firewall are shut down by default. You need to use the **interface** command to explicitly enable each interface you are using.

If you have Ethernet interfaces in the PIX Firewall, the default configuration provides the necessary options for the **interface** command. If your PIX Firewall has Gigabit Ethernet, refer to the **interface** command page in the *Cisco PIX Firewall Command Reference* for configuration information.

The format for the **interface** command is as follows:

```
interface hardware_id hardware_speed [shutdown]
```

- Replace *hardware\_id* with the hardware name for the network interface card, such as **ethernet2** and **ethernet3**, and so forth. For details about the interface numbering of a specific PIX Firewall model, refer to the *Cisco PIX Firewall Hardware Installation Guide*.
- Replace *hardware\_speed* with the speed of the interface, using the values shown in [Table 2-2](#).

**Note**

We recommend that you use the **auto** option to allow the PIX Firewall to automatically select the correct speed and duplex setting. If you use a fixed setting and you later change the setting, the interface will shut down.

The **shutdown** option disables use of the interface. When you first install PIX Firewall, all interfaces have the **shutdown** option in effect.

Use the **write terminal** command to view the configuration and locate the **interface** command information. If you make a mistake while entering an **interface** command, reenter the same command with new information.

**Table 2-2 Values for the hardware\_speed Parameter**

| Value                   | Description                                                              |
|-------------------------|--------------------------------------------------------------------------|
| 10baset                 | 10 Mbps Ethernet half-duplex communications.                             |
| 100basetx               | 100 Mbps Ethernet half-duplex communications.                            |
| 100full                 | 100 Mbps Ethernet full-duplex communications.                            |
| 1000full                | 1000 Mbps Gigabit Ethernet, autonegotiates advertising full duplex only. |
| 1000full<br>nonegotiate | 1000 Mbps Gigabit Ethernet, forces speed to 1000 Mbps full duplex.       |
| 1000auto                | 1000 Mbps Gigabit Ethernet to auto-negotiate full or half duplex.        |
| au                      | 10 Mbps Ethernet half-duplex communications for an AUI cable interface.  |
| auto                    | Automatically sets Ethernet speed and duplex operation.                  |
| bnc                     | 10 Mbps Ethernet half-duplex communications for a BNC cable interface.   |

**Note**

Make sure the maximum transmission unit (MTU) is no more than 1500 bytes for Ethernet. To view the MTU, use the **show mtu** command.

## Changing Interface Names or Security Levels

Each interface has a unique name and security level that you can change using the **nameif** command. By default, Ethernet0 is named outside and assigned the level security0. Ethernet1 is named inside with the level security100. By default, perimeter interfaces are named intf*n*, where *n* represents the position of the interface card in the PIX Firewall. The default security level of perimeter interfaces starts at security10 for ethernet2 (intf2), and increments by 5 for each additional interface.

**Note**

You can skip this section if you are using the default interface names and security levels.

Use the show **nameif** command to view the current names and security levels for each interface. The results of this command for a PIX Firewall with three interfaces might be as follows.

```
nameif ethernet0 outside security0
nameif ethernet1 inside security100
nameif ethernet2 intf2 security10
```

Security levels let you control access between systems on different interfaces and the way you enable or restrict access depends on the relative security level of the interfaces:

- To enable access to a higher security level interface from a lower-level interface, use the **static** and **access-list** commands
- To enable access to a lower-level interface from a higher-level interface, use the **nat** and **global** commands

An attacker who obtains access to an interface can easily attack other interfaces with a lower security level. For this reason, locate public servers on a perimeter interface with the lowest security level. However, the TFTP server from where you download PIX Firewall configurations should be kept on a more secure interface to prevent unauthorized access.

The format for the **nameif** command is as follows:

```
nameif hardware_id interface security_level
```

- Replace *hardware\_id* with the value used in the **interface** command, such as **ethernet0**.
- Replace *interface* with any meaningful name, such as **dmz** or **perim** for each perimeter interface. You will need to enter this name frequently, so a shorter name is a better choice, although you can use up to 48 characters. The default names are *intf**n*, where *n* represents the position of the interface card in the PIX Firewall.
- Replace *security\_level* with a value such as **security40** or **security60**.

The default security levels for perimeter interfaces increment by 5 for each interface starting with security10 for intf2 (the default name for the first perimeter interface). For example, intf3 = security15, intf4 = security20, and intf5 = security25. You can choose any unique security level between 1 and 99 for a perimeter interface.

## Establishing Outbound Connectivity with NAT and PAT

This section describes how to use Network Address Translation (NAT) and Port Address Translation (PAT) to establish outbound connectivity from hosts on higher security interfaces to hosts on lower security interfaces. It includes the following topics:

- [Overview, page 2-7](#)
- [How NAT and PAT Work, page 2-9](#)
- [Configuring NAT and PAT, page 2-9](#)

### Overview

Network Address Translation (NAT) allows you to hide internal IP addresses, those behind the PIX Firewall, from external networks. NAT is accomplished by mapping global IP addresses to local IP addresses. Static NAT is described in the “[Enabling Server Access with Static NAT](#)” section in

Chapter 3, “Controlling Network Access and Use.” Static NAT provides a permanent one-to-one map between two addresses. Dynamic NAT uses a range or pool of global addresses to let you support a large number of users with a limited number of global addresses.

Port Address Translation (PAT) maps a single global IP address to many local addresses. PAT extends the range of available outside addresses at your site by dynamically assigning unique port numbers to the outside address as a connection is requested. A single IP address has up to 65,535 ports that are available for making connections. For PAT, the port number uniquely identifies each connection.

Usually, NAT and PAT apply to addresses of inside hosts that are initiating outbound connections through the PIX Firewall. In this case, the global addresses are typically IP addresses registered with the Network Information Center (NIC) for use on the public Internet. The local addresses are internal IP addresses that you do not wish to use on the public Internet. You may wish to translate your internal addresses because they are non-routable (private) or to discourage attacks from the public Internet.

PIX Firewall Version 6.2 and higher supports NAT and PAT of addresses on outside networks (lower security interfaces) that initiate connections to hosts on higher security interfaces. Outside NAT is occasionally useful for controlling routing and for connecting networks with overlapping addresses. For more information about outside NAT, refer to the “Using Outside NAT” section on page 2-37.”

Table 2-3 summarizes the different functions and applications of NAT and PAT.

**Table 2-3 Address Translation Types**

| Type of Address Translation | Function                                                                                                                                                                                                                                                                                                                                                                                                                                                                                                                                      |
|-----------------------------|-----------------------------------------------------------------------------------------------------------------------------------------------------------------------------------------------------------------------------------------------------------------------------------------------------------------------------------------------------------------------------------------------------------------------------------------------------------------------------------------------------------------------------------------------|
| Inside dynamic NAT          | Translates between host addresses on more secure interfaces and a range or pool of IP addresses on a less secure interface. This provides a one-to-one mapping between internal and external addresses that allows internal users to share registered IP addresses and hides internal addresses from view on the public Internet.                                                                                                                                                                                                             |
| Inside dynamic PAT          | Translates between host addresses on more secure interfaces and a single address on a less secure interface. This provides a many-to-one mapping between internal and external addresses. This allows internal users to share a single registered IP address and hides internal addresses from view on the public Internet. PAT is supported for fewer applications than is NAT. For restrictions on its use, refer to the “How Application Inspection Works” section on page 5-1 in Chapter 5, “Configuring Application Inspection (Fixup).” |
| Inside static NAT           | Provides a permanent, one-to-one mapping between an IP address on a more secure interface and an IP address on a less secure interface. This allows hosts to access the inside host from the public Internet without exposing the actual IP address.                                                                                                                                                                                                                                                                                          |
| Outside dynamic NAT         | Translates between a host address on a less secure interface and a range or pool of IP addresses on a more secure interface. This provides a one-to-one mapping between an external and an internal address. This is most useful for controlling the addresses that appear on inside interfaces of the PIX Firewall and for connecting private networks with overlapping addresses.                                                                                                                                                           |

**Table 2-3** Address Translation Types

| Type of Address Translation | Function                                                                                                                                                                                                                                                                                             |
|-----------------------------|------------------------------------------------------------------------------------------------------------------------------------------------------------------------------------------------------------------------------------------------------------------------------------------------------|
| Outside dynamic PAT         | Translates between host addresses on less secure interfaces and a single address on a more secure interface. This provides a many-to-one mapping between external addresses and an internal address.                                                                                                 |
| Outside static NAT          | Provides a permanent, one-to-one mapping between an IP address on a less secure interface and an IP address on a more secure interface.                                                                                                                                                              |
| Policy NAT                  | Translates source and destination address pairs to different global statements, even if the source address is the same. For example, traffic from IP address A to server A can be translated to global address A, while traffic from IP address A to server B can be translated to global address B. |

## How NAT and PAT Work

The PIX Firewall associates internal addresses with global addresses using a NAT identifier (NAT ID). For example, if the inside interface has NAT ID 5, then hosts making connections from the inside interface to another interface (perimeter or outside) get a substitute (translated) address from the pool of global addresses associated with NAT ID 5.

If you decide not to use NAT to protect internal addresses from exposure on outside networks, assign those addresses NAT ID 0, which indicates to the PIX Firewall that translation is not provided for those addresses. Refer to the *Cisco PIX Firewall Command Reference* for configuration information.

For interfaces with a higher security level such as the inside interface, or a perimeter interface relative to the outside interface, use the **nat** and **global** commands to let users on the higher security interface access a lower security interface. For the opposite direction, from lower to higher, you use the **access-list** command described in the *Cisco PIX Firewall Command Reference*.

As you enter the **nat** and **global** commands to let users start connections, you can use the **show nat** or **show global** commands to list the existing commands. If you make a mistake, remove the old command with the **no** form of the command, specifying all the options of the first command. This is where a terminal with cut and paste capability is useful. After you use the **show global** command, you can cut the old command, enter **no** and a space on the command line, paste the old line in, and press the **Enter** key to remove it.

## Configuring NAT and PAT

Follow these steps to let users on a higher security level interface start connections:

- 
- Step 1** Use the **show nameif** command to view the security level of each interface.
  - Step 2** Make a simple sketch of your network with each interface and its security level as shown in [Figure 2-1](#).

Figure 2-1 Sketching Interfaces and Security Levels

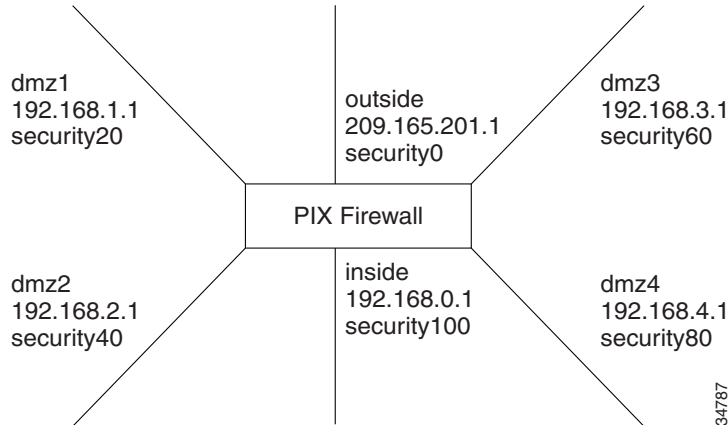

**Step 3** Add a **nat** command statement for each higher security level interface from which you want users to start connections to interfaces with lower security levels:

- To let inside users start connections on any lower security interface, use the **nat (inside) 1 0 0** command.
- To let dmz4 users start connections on any lower security interface such as dmz3, dmz2, dmz1, or the outside, use the **nat (dmz4) 1 0 0** command.
- To let dmz3 users start connections on any lower security interface such as dmz2, dmz1, or the outside, use the **nat (dmz3) 1 0 0** command.
- To let dmz2 users start connections on any lower security interface, such as dmz1 or outside, use the **nat (dmz2) 1 0 0** command.
- To let **dmz1** users start connections to the outside, use the **nat (dmz1) 1 0 0** command.

Instead of specifying “0 0,” to let all hosts start connections, you can specify a host or a network address and mask.

For example, to let only host 192.168.2.42 start connections on the dmz2 interface, you could specify the following:

```
nat (dmz2) 1 192.168.2.42 255.255.255.255
```

The “1” after the interface specifier is the NAT ID. You can use one ID for all interfaces and the PIX Firewall sorts out which **nat** command statement pertains to which **global** command statement on which interface, or you can specify a unique NAT ID to limit access to specific interface. Remember that the **nat** command opens access to all lower security level interfaces so that if you want users on the inside to access the perimeter interfaces as well as the outside, then use one NAT ID for all interfaces. If you only want inside users to access the dmz1 interface but not the outside interface, use unique NAT IDs for each interface.

The NAT ID in the **nat** command must be the same NAT ID you use for the corresponding **global** command.

NAT ID **0** means to disable Network Address Translation.

**Step 4** Add a **global** command statement for each lower security interface which you want users to have access to; for example, on the outside, dmz1, and dmz2. The **global** command creates a pool of addresses that translated connections pass through.

There should be enough global addresses to handle the number of users on each interface simultaneously accessing the lower security interface. You can specify a single PAT entry, which permits up to 64,000 hosts to use a single IP address. PAT has some restrictions in its use such as it cannot support H.323 or caching nameserver use, so you may want to use it to augment a range of global addresses rather than using it as your sole global address.

For example:

```
global (outside) 1 209.165.201.5 netmask 255.255.255.224
global (outside) 1 209.165.201.10-209.165.201.20 netmask 255.255.255.224
```

The first **global** command statement specifies a single IP address, which the PIX Firewall interprets as a PAT. You can specify PAT using the IP address at the interface using the **interface** keyword. The PAT lets up to 65,535 hosts start connections to the outside.



**Note** PIX Firewall Version 5.2 and higher permits multiple PAT global command statements for each interface.

The second **global** command statement configures a pool of global addresses on the outside interface.

When you define IP address pools for NAT and PAT in the same configuration for the same interface, the PIX Firewall uses the NAT address pools first, regardless of the order of the statements in the configuration. If there is more than one statement assigning IP address pools for NAT, the addresses are used in the order of the statements. IP addresses assigned for PAT are used only after any NAT IP address pools are exhausted. This minimizes the exposure of PAT in case users need to use H.323 applications.

```
global (dmz1) 1 192.168.1.10-192.168.1.100 netmask 255.255.255.0
global (dmz2) 1 192.168.2.10-192.168.2.100 netmask 255.255.255.0
```

The **global** command statement for dmz1 lets users on the inside, dmz2, dmz3, and dmz4 start connections on the dmz1 interface.

The **global** command statement for dmz2 lets users on the inside, dmz3, and dmz4 start connections on the dmz2 interface.

If you use network subnetting, specify the subnet mask with the **netmask** option.

You can track usage among different subnets by mapping different internal subnets to different PAT addresses.

For example:

```
nat (inside) 1 10.1.0.0 255.255.0.0
nat (inside) 2 10.1.1.1 255.255.0.0
global (outside) 1 192.168.1.1
global (outside) 2 209.165.200.225
```

In this example, hosts on the internal network 10.1.0.0/16 are mapped to global address 192.168.1.1, and hosts on the internal network 10.1.1.1/16 are mapped to global address 209.165.200.225 in global configuration mode.

Another way to measure traffic is to back up your PAT address.

For example:

```
nat (inside) 1 10.1.0.0 255.255.0.0
global (outside) 1 209.165.200.225
global (outside) 1 192.168.1.1
```

In this example, two port addresses are configured for setting up PAT on hosts from the internal network 10.1.0.0/16 in global configuration mode.

---

## Configuring the PIX Firewall for Routing

A route identifies the interface and router (gateway) to use to forward packets for a specific destination network received by the PIX Firewall. This section describes how to configure the PIX Firewall to correctly route traffic to and from adjacent networks. It includes the following topics:

- [Using RIP, page 2-12](#)
- [Configuring RIP Static Routes on PIX Firewall, page 2-13](#)
- [Using OSPF, page 2-14](#)
- [Configuring OSPF on the PIX Firewall, page 2-17](#)
- [Viewing OSPF Configuration, page 2-20](#)
- [Clearing OSPF Configuration, page 2-21](#)

## Using RIP

Each inside or perimeter PIX Firewall interface is configurable for route and Routing Information Protocol (RIP) information. To determine what route information is required, consider what routers are in use in your network and are adjacent to the planned installation point of the PIX Firewall.

Specifying a route tells the PIX Firewall where to send information that is forwarded on a specific interface and destined for a particular network address. You can specify more than one route per interface, which lets you control where to send network traffic. Refer to the **route** command page in the *Cisco PIX Firewall Command Reference* for more information.

If the PIX Firewall has RIP enabled, it learns where everything is on the network by “passively” listening for RIP network traffic. When the PIX Firewall interface receives RIP traffic, the PIX Firewall updates its routing tables. You can also configure the PIX Firewall to broadcast an inside or perimeter interface as a “default” route. Broadcasting an interface as a default route is useful if you want all network traffic on that interface to go out through that interface. Refer to the **rip** command page in the *Cisco PIX Firewall Command Reference* for configuration information.

When defining a route, specify the IP address and network mask for the destination network. Use 0.0.0.0 as the default value for both the IP address and network mask when defining a default route.

The gateway IP address is the router that routes the traffic to the destination network IP address.

RIP configuration specifies whether the PIX Firewall updates its routing tables by passive listening to RIP traffic, and whether the interface broadcasts itself as a default route for network traffic on that interface.



**Note**

Before testing your configuration, flush the ARP caches on any routers that feed traffic into or from the PIX Firewall and between the PIX Firewall and the Internet. For Cisco routers, use the **clear arp** command to flush the ARP cache.

## Configuring RIP Static Routes on PIX Firewall

Follow these steps to add static routes:

- Step 1** Sketch out a diagram of your network as shown in [Figure 2-2](#).

**Figure 2-2** Sketch Network with Routes

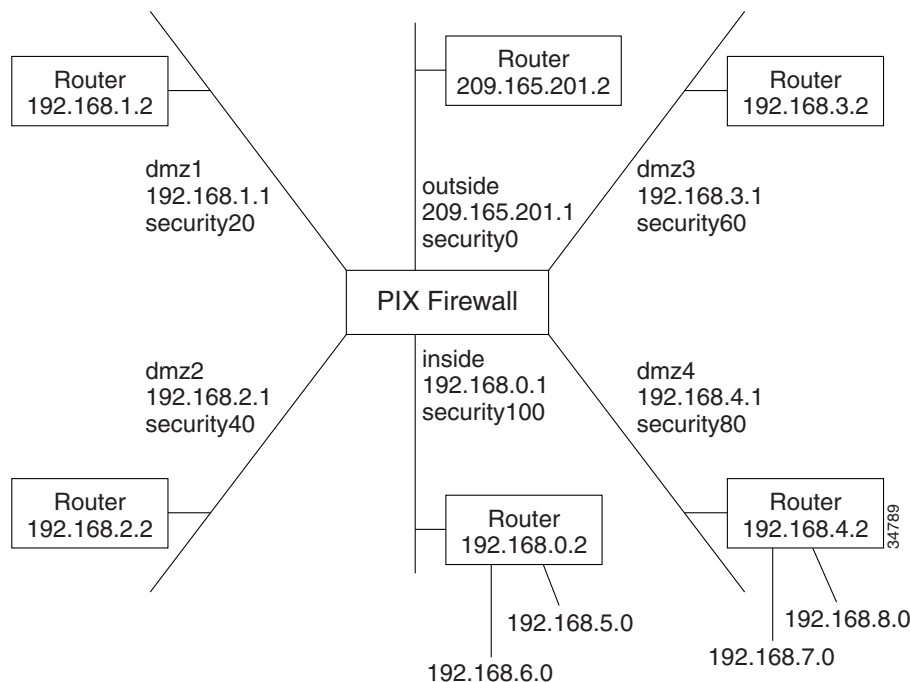

- Step 2** Enter the default route:

```
route outside 0 0 209.165.201.2 1
```

Only one default route is permitted. This command statement sends any packets destined for the default route, IP address 0.0.0.0 (abbreviated as **0**, and **0** for the netmask), to the router 209.165.201.2. The “1” at the end of the command statement indicates that the router is the router closest to the PIX Firewall; that is, one hop away.

In addition, add static routes for the networks that connect to the inside router as follows:

```
route inside 192.168.5.0 255.255.255.0 192.168.0.2 1
route inside 192.168.6.0 255.255.255.0 192.168.0.2 1
```

These static **route** command statements can be read as “for packets intended for either network 192.168.5.0 or 192.168.6.0, ship them to the router at 192.168.0.2.” The router decides which packet goes to which network. The PIX Firewall is not a router and cannot make these decisions.

The “1” at the end of the command statement specifies how many hops (routers) the router is from the PIX Firewall. Because it is the first router, you use 1.

**Step 3** Add the static routes for the dmz4 interface:

```
route dmz4 192.168.7.0 255.255.255.0 192.168.4.2 1
route dmz4 192.168.8.0 255.255.255.0 192.168.4.2 1
```

These command statements direct packets intended to the 192.168.6.0 and 192.168.7.0 networks back through the router at 192.168.4.2.

## Using OSPF

This section describes how the Open Shortest Path First (OSPF) routing protocols are implemented in PIX Firewall Version 6.3. It includes the following topics:

- [Overview, page 2-14](#)
- [Security Issues When Using OSPF, page 2-14](#)
- [OSPF Features Supported, page 2-15](#)
- [Restrictions and Limitations, page 2-16](#)

### Overview

PIX Firewall Version 6.3 introduces support for dynamic routing using the Open Shortest Path First (OSPF) routing protocol. OSPF is widely deployed in large internetworks because of its efficient use of network bandwidth and its rapid convergence after changes in topology.



#### Note

OSPF is not supported on the PIX Firewall 501.

The OSPF functionality in PIX Firewall Version 6.3 is similar to that provided by Cisco IOS Release 12.2(3a). For details about the syntax for each command and subcommand used to manage OSPF, refer to the *Cisco PIX Firewall Command Reference* or to Cisco IOS software documentation.

### Security Issues When Using OSPF

Authentication should be used with all routing protocols when possible because route redistribution between OSPF and other protocols (like RIP) can potentially be used by attackers to subvert routing information. If MD5 authentication is used on all segments, security should not be an issue with OSPF.

When using dynamic routing, the physical security of the PIX Firewall is of increased importance. Access to the physical device and configuration information should be kept secure. Shared-keys should be changed at a reasonable interval.

As part of its normal operation, OSPF advertises routes to networks, and this may not be desirable in many PIX Firewall implementations. You may need to prevent networks from being advertised externally when using private addressing or when required by your security policy.

If NAT is used, if OSPF is operating on public and private areas, and if address filtering is required, then you need to run two OSPF processes—one process for the public areas and one for the private areas.

A router that has interfaces in multiple areas is called an Area Border Router (ABR). A router that redistributes traffic or imports external routes (Type 1 or Type 2) between routing domains is called an Autonomous System Boundary Router (ASBR).

An ABR uses link-state advertisements (LSA) to send information about available routes to other OSPF routers. Using ABR type 3 LSA filtering, you can have separate private and public areas with the PIX Firewall acting as an ABR. Type 3 LSAs (inter-area routes) can be filtered from one area to another. This lets you use NAT and OSPF together without advertising private networks.

**Note**

Only type 3 LSAs can be filtered. If you configure PIX Firewall as an ASBR in a private network, it will send type 5 LSAs describing private networks, which will get flooded to the entire AS including public areas.

If NAT is employed but OSPF is only running in public areas, then routes to public networks can be redistributed inside the private network, either as default or type 5 AS External LSAs. However, you need to configure static routes for the private networks protected by the PIX Firewall. Also, you cannot mix public and private networks on the same PIX Firewall interface.

## OSPF Features Supported

The following is a list of OSPF features supported by PIX Firewall Version 6.3:

- Support of intra-area, inter-area and External (Type I and Type II) routes
- Support for virtual links
- OSPF LSA flooding
- Authentication for OSPF packets (both clear text and MD5 authentication)
- Support for configuring the PIX Firewall as a designated router (DR) or ABR
- Support for configuring the PIX Firewall as an ASBR, with route redistribution between OSPF processes including OSPF, static, and connected routes
- Support for stub areas and not so stubby areas (NSSA)
- ABR type 3 LSA filtering
- Load balancing among a maximum of three peers on a single interface, using Equal Cost Multipath Routes (ECMP).

**Note**

If using ECMP, note that the default cost for a Fast Ethernet link on the PIX Firewall is consistent with a Cisco Firewall Services Module (FWSM) but differs from a Cisco IOS router.

Table 2-4 summarizes the OSPF commands that are supported or that are not supported in PIX Firewall Version 6.3. For the detailed syntax of each command, refer to the Cisco IOS Release 12.2(3a) documentation or to the *Cisco PIX Firewall Command Reference*.

**Table 2-4 Cisco IOS OSPF Commands Supported in PIX Firewall Version 6.3**

| OSPF Command <sup>1</sup> | Supported | OSPF Command            | Supported | OSPF Command            | Supported |
|---------------------------|-----------|-------------------------|-----------|-------------------------|-----------|
| area authentication       | yes       | ip ospf dead-interval   | yes       | show ip ospf flood-list | yes       |
| area default-cost         | yes       | ip ospf flood-reduction | no        | show ip ospf interface  | yes       |
| area filter-list          | yes       | ip ospf hello-interval  | yes       | show ip ospf neighbor   | yes       |

Table 2-4 Cisco IOS OSPF Commands Supported in PIX Firewall Version 6.3 (continued)

| OSPF Command <sup>1</sup>            | Supported          | OSPF Command                | Supported | OSPF Command                     | Supported |
|--------------------------------------|--------------------|-----------------------------|-----------|----------------------------------|-----------|
| area nssa                            | yes                | ip ospf message-digest-key  | yes       | show ip ospf request-list        | yes       |
| area range                           | yes                | ip ospf mtu-ignore          | yes       | show ip ospf retransmission-list | yes       |
| area stub                            | yes                | ip ospf name-lookup         | no        | show ip ospf summary-address     | yes       |
| area virtual-link                    | yes                | ip ospf priority            | yes       | show ip ospf virtual-links       | yes       |
| auto-cost                            | no (use ospf cost) | ip ospf retransmit-interval | yes       | summary-address (OSPF)           | yes       |
| compatible rfc1583                   | yes                | ip ospf transmit-delay      | yes       | timers lsa-group-pacing          | yes       |
| default-information originate (OSPF) | yes                | log-adj-changes             | yes       | timers spf                       | yes       |
| distance ospf                        | yes                | network area                | yes       | clear ip ospf                    | modified  |
| ignore lsa mospf                     | yes                | router-id                   | yes       | default-metric (OSPF)            | no        |
| ip ospf authentication               | yes                | router ospf                 | yes       | ip ospf demand-circuit           | no        |
| ip ospf authentication-key           | yes                | show ip ospf [process-id]   | yes       | ip ospf network                  | no        |
| ip ospf cost                         | yes                | show ip ospf border-routers | yes       | neighbor (OSPF)                  | no        |
| ip ospf database-filter              | yes                | show ip ospf database       | yes       |                                  |           |

1. The exact syntax for some commands used with PIX Firewall may differ slightly from the Cisco IOS software implementation. Refer to the *Cisco PIX Firewall Command Reference* for the exact syntax of a specific command.

**Note**

PIX Firewall does not accept spaces within OSPF authentication keys or message digests but Cisco IOS does. This may create compatibility issues when a PIX Firewall tries to exchange OSPF messages if an adjacent router uses spaces within its authentication key or message digest.

## Restrictions and Limitations

The PIX Firewall does not provide any filtering of OSPF in Version 6.3 beyond what is provided by OSPF.

OSPF does not support dynamic routing over overlapping address spaces, so the PIX Firewall will not support running OSPF on an interface from where it can learn overlapping addresses. To support overlapping address networks, either configure static routes or use passive RIP.

**Note**

Running both OSPF and RIP concurrently on the same PIX Firewall is unsupported.

Only broadcast networks are supported by the implementation of OSPF in PIX Firewall Version 6.3. The following summarizes the OSPF features that are *not* supported by PIX Firewall Version 6.3:

- Point-to-point link/serial interface/nonbroadcast multiaccess (NBMA)
- OSPF on demand Circuit
- Flood Reduction

- Redistribution of routes between non-OSPF routing protocols
- Policy Routing

A maximum of two OSPF processes are allowed and PIX Firewall will only allow redistribution between these OSPF processes.

Any topology in which the same router is connected to two different interfaces of the PIX Firewall is not supported.

**Note**

When you configure OSPF on either IOS or the PIX Firewall using the **default-information originate** command with the **always** keyword and a route-map with match clauses, there must be a route to match in the routing table. If there is no match, then the route is not redistributed. If a system is configured with the **always** keyword, it will not install a default route from another system. Also, do not configure a default route with the IP address of a PIX Firewall interface as a gateway.

## Configuring OSPF on the PIX Firewall

This section describes how to configure the PIX Firewall when using OSPF. It includes the following topics:

- [Using OSPF in Public Networks, page 2-17](#)
- [Using OSPF in Private and Public Networks, page 2-19](#)

### Using OSPF in Public Networks

[Figure 2-3](#) illustrates an implementation of PIX Firewall using OSPF in public and private networks.

**Figure 2-3 Using OSPF with PIX Firewall Version 6.3**

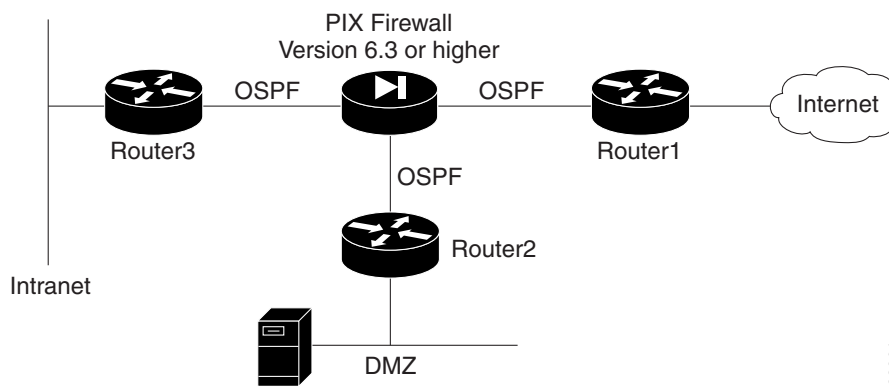

This example illustrates the PIX Firewall as an ABR, configured to filter Type 3 LSAs, with NAT enabled on the inside interface, NAT disabled on the DMZ, and all interfaces running OSPF. Router1 is a locally controlled ASBR running OSPF and Border Gateway Protocol (BGP).

**Note**

If NAT is enabled, but OSPF is running only in public areas, the only special configuration required is to configure static routes for the private networks protected by the PIX Firewall.

In this configuration, the inside interface learns routes dynamically from all areas, but its private routes are not propagated onto the backbone or public areas. The DMZ is visible to the backbone.

Follow these steps to configure this implementation on the PIX Firewall:

**Step 1** To configure the PIX Firewall interfaces, enter the following commands:

```
nameif ethernet0 outside security0
nameif ethernet1 inside security100
nameif ethernet2 dmz security50
ip address outside 1.1.1.1 255.255.255.0
ip address inside 10.0.0.1 255.0.0.0
ip address dmz 1.1.2.1 255.255.255.0
```

**Step 2** To configure the static routes, enter the following commands:

```
static (inside,outside) 1.1.1.2 10.1.1.2 255.255.255.255
static (dmz,outside)1.1.2.2 1.1.2.2 255.255.255.255
```

**Step 3** Configure NAT by entering the following commands:

```
nat (inside) 1 0 0
nat (dmz)0 0 0
global (outside) 1 1.1.1.4-1.1.1.254
```

**Step 4** Configure OSPF by entering the following commands:

```
router ospf 1
area 0 filter-list prefix ten in
network 1.1.1.0 255.255.255.0 area 0
network 1.1.2.0 255.255.255.0 area 1.1.2.0
network 10.0.0.0 255.0.0.0 area 10.0.0.0
prefix-list ten deny 10.0.0.0/8
prefix-list ten permit 1.1.2.0/24
```

### **Example 2-1** Moving a Network to a Different OSPF Process

Before reassigning a network to a new OSPF process ID, remove the OSPF configuration line for the network that assigned it to the previous OSPF process ID. Then configure the new OSPF process ID assignment for that network.

The following example shows the configuration for an existing network:

```
router ospf 10
 distance ospf intra-area 130 inter-area 120
 log-adj-changes
router ospf 50
 network 10.130.12.0 255.255.255.0 area 10.130.12.0
 network 10.132.12.0 255.255.255.0 area 0
 network 10.139.12.0 255.255.255.0 area 50
 area 50 stub
 log-adj-changes
```

To move the network 10.130.12.0 255.255.255.0 area 10.130.12.0 to router ospf 10, enter the following commands:

```

pixfirewall(config-router)# router ospf 50
pixfirewall(config-router)# no network 10.130.12.0 255.255.255.0 area 10.130.12.0
pixfirewall(config-router)# router ospf 10
pixfirewall(config-router)# network 10.130.12.0 255.255.255.0 area 10.130.12.0
pixfirewall(config-router)# s router
router ospf 10
 network 10.130.12.0 255.255.255.0 area 10.130.12.0
 distance ospf intra-area 130 inter-area 120
 log-adj-changes
router ospf 50
 network 10.132.12.0 255.255.255.0 area 0
 network 10.139.12.0 255.255.255.0 area 50
 area 50 stub
 log-adj-changes

```

## Using OSPF in Private and Public Networks

When NAT is used and OSPF is operating on public and private areas you need to run two OSPF processes to prevent the advertising of private networks in public areas. This lets you use NAT and OSPF, without advertising private networks.

In this implementation, the PIX Firewall is used as an ASBR with NAT enabled on both the inside interface and on the DMZ, with all interfaces running OSPF. This configuration allows both the inside and DMZ interfaces to learn routes dynamically from all areas, while preventing the private routes from being propagated onto the backbone or public areas.

Follow these steps to configure this implementation on the PIX Firewall:

---

**Step 1** To configure the PIX Firewall interfaces, enter the following commands:

```

nameif ethernet0 outside security0
nameif ethernet1 inside security100
nameif ethernet2 dmz security50
ip address outside 1.1.1.1 255.255.255.0
ip address inside 10.0.0.1 255.0.0.0
ip address dmz 192.168.1.1 255.255.255.0

```

**Step 2** To configure the static routes, enter the following commands:

```

static (inside,outside) 1.1.1.2 10.1.1.2 255.255.255.255
static (dmz,outside)1.1.1.3 192.168.1.3 255.255.255.255

```

**Step 3** Configure NAT by entering the following commands:

```

nat (inside) 1 0 0
nat (dmz)1 0 0
global (outside) 1 1.1.1.4-1.1.1.254

```

**Step 4** Configure OSPF by entering the following commands:

```

router ospf 1 //public AS
network 1.1.1.0 255.255.255.0 area 0
router ospf 2 //private AS
redistribute ospf 1 //import the public external routes
network 10.0.0.0 255.0.0.0 area 10.0.0.0
network 192.168.1.0 255.255.255.0 area 192.168.1.0

```

---

## Viewing OSPF Configuration

Table 2-5 lists some of the **show** commands that you can enter from privileged or configuration modes to display information about OSPF on the PIX Firewall. Refer to the *Cisco PIX Firewall Command Reference* or to the Cisco IOS documentation for all the options and the detailed syntax.

**Table 2-5 OSPF show Commands**

| Command                                                                                | Result                                                                                                                                                                                                                                                                                     |
|----------------------------------------------------------------------------------------|--------------------------------------------------------------------------------------------------------------------------------------------------------------------------------------------------------------------------------------------------------------------------------------------|
| <code>show routing [interface<br/><i>interface-name</i>]</code>                        | Displays non-default routing configuration information. Use the <b>interface</b> option to display information for a specific interface and replace <i>interface-name</i> with the identifier for a specific interface.                                                                    |
| <code>show ospf [process-id]</code>                                                    | Displays general information about OSPF routing process IDs. Use the <b>process-ID</b> option to display information for a specific routing process.                                                                                                                                       |
| <code>show ospf border-routers</code>                                                  | Displays the internal OSPF routing table entries to an Area Border Router (ABR) and Autonomous System Boundary Router (ASBR).                                                                                                                                                              |
| <code>show ospf database<br/>[router] [network] [external]</code>                      | Displays lists of information related to the OSPF database for a specific router. The different options display information about different OSPF link-state advertisements (LSAs).                                                                                                         |
| <code>show ospf flood-list<br/><i>interface-name</i></code>                            | Displays a list of OSPF link-state advertisements (LSAs) waiting to be flooded over an interface. Replace <i>interface-name</i> with the identifier for a specific interface.                                                                                                              |
| <code>show ospf interface<br/><i>interface-name</i></code>                             | Displays OSPF-related interface information. Use the <b>interface</b> option to display information for a specific interface and replace <i>interface-name</i> with the identifier for a specific interface.                                                                               |
| <code>show ospf neighbor<br/>[<i>interface-name</i>] [neighbor-id]<br/>[detail]</code> | Displays OSPF neighbor information on a per-interface basis. Replace <i>interface-name</i> with the identifier for a specific interface. Use the <b>neighbor-id</b> option to display information about a specific neighbor. Use the <b>detail</b> option to display detailed information. |
| <code>show ospf request-list<br/>[<i>neighbor-addr</i>] [<i>interface-name</i>]</code> | Displays a list of all link-state advertisements (LSAs) requested by a router. Replace <i>neighbor-addr</i> with the IP address of a neighbor. Replace <i>interface-name</i> with the identifier for a specific interface.                                                                 |



Table 2-5 OSPF show Commands (continued)

| Command                                                                     | Result                                                                                                                                                                                                                    |
|-----------------------------------------------------------------------------|---------------------------------------------------------------------------------------------------------------------------------------------------------------------------------------------------------------------------|
| <code>show ospf retransmission-list [neighbor-addr] [interface-name]</code> | Displays a list of all link-state advertisements (LSAs) waiting to be resent. Replace <i>neighbor-addr</i> with the IP address of a neighbor. Replace <i>interface-name</i> with the identifier for a specific interface. |
| <code>show ospf [process-id] summary-address</code>                         | Displays a list of all summary address redistribution information configured under an OSPF process. Replace process-ID with a process identifier for a specific OSPF area ID.                                             |
| <code>show ospf virtual-links</code>                                        | Displays parameters and the current state of OSPF virtual links.                                                                                                                                                          |

## Clearing OSPF Configuration

This section describes how to clear OSPF configuration.

To clear the OSPF routing process ID, use the following command:

```
clear ospf [pid] {process | counters neighbor [neighbor-intf] [neighbor-id]}
```

This command only clears the process ID and does not clear any configuration. Replace *pid* with the OSPF routing process ID. Replace *neighbor-intf* with the interface for a specific neighbor. Replace *neighbor-id* with the IP address of a specific neighbor.

To clear the OSPF configuration, use one of the following commands:

```
no routing interface interface-name>
no router ospf id
```

Replace *interface-name* with the identifier for a specific interface. Replace *id* with the OSPF area identifier.

## Testing and Saving Your Configuration

This section describes how to make sure your configuration works by testing connectivity, and how to save your configuration. It includes the following topics:

- [Testing Connectivity, page 2-22](#)
- [Saving Your Configuration, page 2-24](#)

## Testing Connectivity

You can use the **access-list** command to allow hosts on one interface to ping through to hosts on another interface. This lets you test that a specific host is reachable through the PIX Firewall.

The ping program sends an ICMP echo request message to the IP address and then expects to receive an ICMP echo reply. The ping program also measures how long it takes to receive the reply, which you can use to get a relative sense of how far away the host is.



### Note

We recommend that you only enable pinging during troubleshooting. When you are done testing the interfaces, remove the ICMP **access-list** command statements.

To test your connectivity, perform the following steps:

- Step 1** Start with a sketch of your PIX Firewall, with each interface connected to the inside, outside, and any perimeter networks.

Figure 2-4 shows an example sketch:

**Figure 2-4 Sketch a Network with Interfaces and Routers**

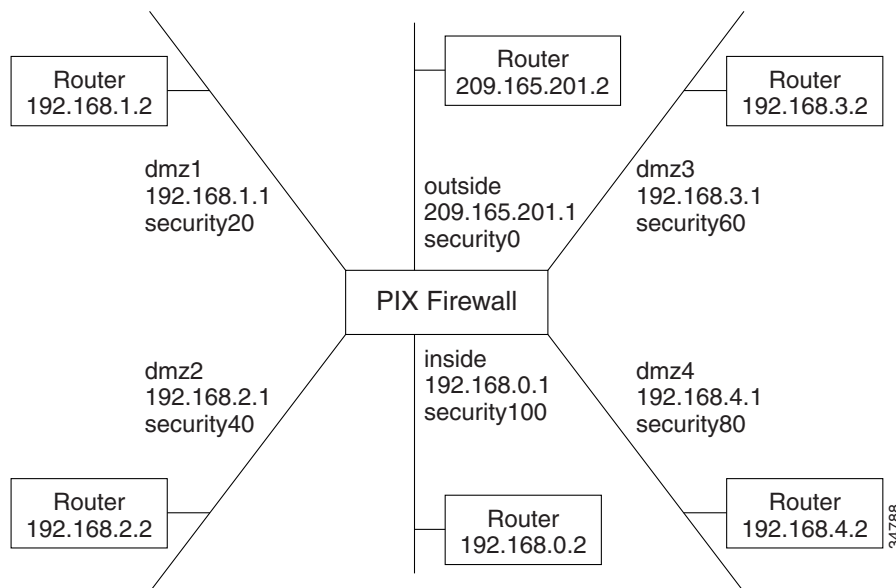

- Step 2** Enable Pinging.

Enter an **access-list** command to permit ICMP access as follows:

```
access-list acl_out permit icmp any any
```

The “acl\_out” is an **access-list** command ID and can be any name or a number you specify. Use the **show access-list** command to view this command in the configuration.

You then need to specify an **access-group** command for each interface through which you want the ICMP packets to pass. Use the **show access-group** command to view this command in the configuration.

To ping from one interface to another, bind the **access-list** and **access-group** command statements to the lower security interface, which lets the ICMP echo reply to return to the sending host.

For example, enter the following command statement to ping from the inside interface to the outside interface:

```
access-group acl_out in interface outside
```

**Step 3** Enable debugging.

Enter configuration mode and start the **debug icmp trace** command to monitor ping results through the PIX Firewall. In addition, start syslog logging with the **logging buffered debugging** command to check for denied connections or ping results. The **debug** messages display directly on the console session. You can view syslog messages with the **show logging** command.

Before using the **debug** command, use the **who** command to see if there are any Telnet sessions to the console. If the **debug** command finds a Telnet session, it automatically sends the **debug** output to the Telnet session instead of the console. This will cause the serial console session to seem as though no output is appearing when it is really going to the Telnet session.

**Step 4** Ping around the PIX Firewall.

Ping from the PIX Firewall to a host or router on each interface. Then go to a host or router on each interface and ping the PIX Firewall unit's interface. In software Version 5.3 and higher, the PIX Firewall **ping** command has been improved so you do not need to specify the interface name if the host's IP address is on the same subnet as a PIX Firewall interface. For the example, you would use these **ping** commands from the PIX Firewall command line to ping hosts or routers.

```
ping 192.168.0.2
ping 192.168.1.2
ping 192.168.2.2
ping 192.168.3.2
ping 192.168.4.2
ping 209.165.201.2
```

Then ping the PIX Firewall interfaces from the hosts or routers with commands such as the following:

- Ping the PIX Firewall's outside interface with **ping 209.165.201.1**
- Ping the PIX Firewall's inside interface with **ping 192.168.0.1**
- Ping the PIX Firewall's dmz1 interface with **ping 192.168.1.1**
- Ping the PIX Firewall's dmz2 interface with **ping 192.168.2.1**
- Ping the PIX Firewall's dmz3 interface with **ping 192.168.3.1**
- Ping the PIX Firewall's dmz4 interface with **ping 192.168.4.1**

If the pings from the hosts or routers to the PIX Firewall interfaces are not successful, check the debug messages, which should have displayed on the console. Successful ping debug messages appear as in this example.

```
ICMP echo reply (len 32 id 1 seq 256) 209.165.201.1 > 209.165.201.2
ICMP echo request (len 32 id 1 seq 512) 209.165.201.2 > 209.165.201.1
```

Both the request and reply statements should appear, which shows that the PIX Firewall and the host responded. If none of these messages appeared while pinging the interfaces, then there is a routing problem between the host or router and the PIX Firewall that caused the ping (ICMP) packets to never arrive at the PIX Firewall.

Also try the following to fix unsuccessful pings:

- a. Verify the physical connectivity of the affected interface(s). If there are switches or hubs between the hosts and the PIX Firewall, verify that all the links are working. You can try connecting a host directly to the PIX Firewall using a crossover cable.
- b. Make sure you have a default **route** command statement for the outside interface. For example:  

```
route outside 0 0 209.165.201.2 1
```
- c. Use the **show access-list** command to ensure that you have **access-list** command statements in your configuration to permit ICMP. Add these commands if they are not present.
- d. Except for the outside interface, make sure that the host or router on each interface has the PIX Firewall as its default gateway. If so, set the host's default gateway to the router and set the router's default route to the PIX Firewall.

If there is a single router between the host and the PIX Firewall, a default route on the router should be unnecessary. However, you might want to try clearing the ARP cache of the router. If there are multiple routers, you might need to set a default route on any router on the path from the PIX Firewall to the host.

- e. Check to see if there is a router between the host and the PIX Firewall. If so, make sure the default route on the router points to the PIX Firewall interface. If there is a hub between the host and the PIX Firewall, make sure that the hub does not have a routing module. If there is a routing module, configure its default route to point to the PIX Firewall.

## Saving Your Configuration

When you complete entering commands in the configuration, save it to Flash memory with the **write memory** command.

Then use the **reload** command to reboot the PIX Firewall. When you reboot, all traffic through the PIX Firewall stops. Once the PIX Firewall unit is again available, connections can restart. After you enter the **reload** command, PIX Firewall prompts you to confirm that you want to continue. Enter **y** and the reboot occurs.

You are now done configuring the PIX Firewall. This basic configuration lets protected network users start connections, but prevents users on unprotected networks from accessing (or attacking) protected hosts.

Use the **write terminal** command to view your current configuration.

## Basic Configuration Examples

This section illustrates and describes a number of common ways to implement the PIX Firewall. It includes the following topics:

- [Two Interfaces Without NAT or PAT, page 2-25](#)
- [Two Interfaces with NAT and PAT, page 2-27](#)
- [Three Interfaces Without NAT or PAT, page 2-29](#)
- [Three Interfaces with NAT and PAT, page 2-31](#)

## Two Interfaces Without NAT or PAT

When you first add a PIX Firewall to an existing network, it is easiest to implement if you do not have to renumber all the inside and outside IP addresses. The configuration in [Figure 2-5](#) illustrates this scenario. All inside hosts can start connections. All external hosts are blocked from initiating connections or sessions on inside hosts.

**Figure 2-5 Two Interfaces Without NAT**

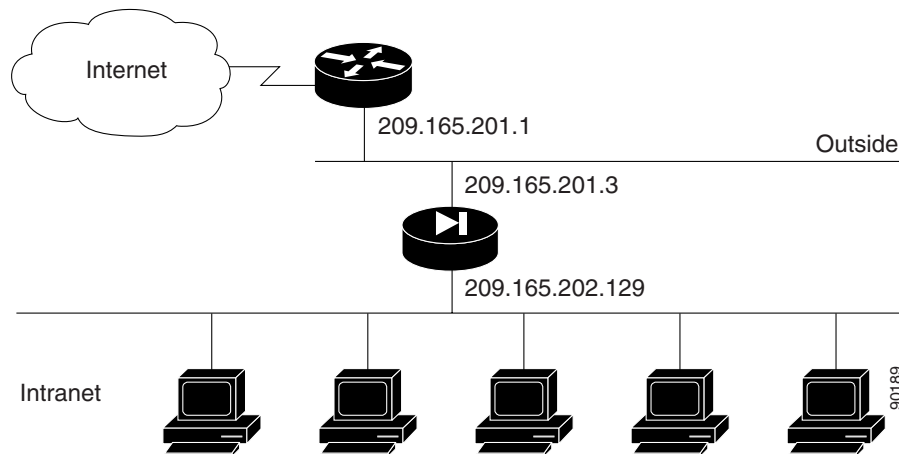

The values given are examples only. You should change this configuration for the information and requirements that are specific for your network.

The following steps describe the configuration procedure that is the same regardless of how you implement your PIX Firewall:

**Step 1** Identify the security level and names of each interface by entering the following commands:

```
nameif ethernet0 outside security0
nameif ethernet1 inside security100
```

**Step 2** Identify the line speed of each interface by entering the following commands:

```
interface ethernet0 100basex
interface ethernet1 100basex
```

You may get better performance by changing the default **auto** option in the **interface** command to the specific line speed for the interface card.

**Step 3** Identify the IP addresses for each interface:

```
ip address outside 209.165.201.3 255.255.255.224
ip address inside 209.165.202.129 255.255.255.0
```

**Step 4** Specify the host name for the PIX Firewall:

```
hostname pixfirewall
```

This name appears in the command line prompt.

**Step 5** Set the ARP timeout to 14,400 seconds (four hours):

```
arp timeout 14400
```

With this command, entries are kept in the ARP table for four hours before they are flushed. Four hours is the standard default value for ARP timeouts.

**Step 6** Disable failover access:

```
no failover
```

**Step 7** Enable the use of text strings instead of IP addresses:

```
names
```

This makes your configuration files more readable.

**Step 8** Enable paging:

```
pager lines 24
```

When 24 lines of information display, PIX Firewall pauses the listing and prompts you to continue.

**Step 9** Enable syslog messages, which provide diagnostic information and status for the PIX Firewall:

```
logging buffered debugging
```

PIX Firewall makes it easy to view syslog messages with the **show logging** command.

**Step 10** Let inside IP addresses be recognized on the outside network and let inside users start outbound connections:

```
nat (inside) 0 209.165.201.3 255.255.255.224
```

**Step 11** Set the outside default route to the router attached to the Internet:

```
route outside 0.0.0.0 0.0.0.0 209.165.201.1 1
```

**Step 12** Allow inbound and outbound pings:

```
access-list acl_out permit icmp any any
access-group acl_out in interface outside
```

These statements allow the PIX Firewall to forward ICMP replies received on the outside interface. These replies are received in response to ping commands issued from the internal network.



---

**Note** When troubleshooting is complete, remove these statements.

---

**Step 13** Set the default values for the maximum duration that PIX Firewall resources can remain idle until being freed:

```
timeout xlate 3:00:00
timeout conn 1:00:00 half-closed 0:10:00
udp 0:02:00 rpc 0:10:00 h323 0:05:00
sip 0:30:00 sip_media 0:02:00
timeout uauth 0:05:00 absolute
```

Additional users cannot make connections until a connection resource is freed either by a user dropping a connection or by an xlate and conn timer time out.

**Step 14** Disable SNMP access and SNMP traps generation:

```
no snmp-server location
no snmp-server contact
snmp-server community public
```

**Step 15** Set the maximum transmission unit value for Ethernet access:

```
mtu outside 1500
mtu inside 1500
```

---

[Example 2-2](#) shows the listing for the basic configuration required to implement a PIX Firewall with two interfaces without NAT.

**Example 2-2 Two Interfaces Without NAT**

```
nameif ethernet0 outside security0
nameif ethernet1 inside security100
interface ethernet0 100basex
interface ethernet1 100basex
ip address outside 209.165.201.3 255.255.255.224
ip address inside 209.165.202.129 255.255.255.0
hostname pixfirewall
arp timeout 14400
no failover
names
pager lines 24
logging buffered debugging
nat (inside) 0 209.165.201.3 255.255.255.224
route outside 0.0.0.0 0.0.0.0 209.165.201.1 1
access-list acl_out permit icmp any any
access-group acl_out in interface outside
timeout xlate 3:00:00
timeout conn 1:00:00 half-closed 0:10:00
udp 0:02:00 rpc 0:10:00 h323 0:05:00
sip 0:30:00 sip_media 0:02:00
timeout uauth 0:05:00 absolute
no snmp-server location
no snmp-server contact
snmp-server community public
mtu outside 1500
mtu inside 1500
```

## Two Interfaces with NAT and PAT

Use NAT if the network addresses in use on your internal network are not valid for use on the public Internet, or when you want to hide your network addresses from potential attackers. Use PAT when you do not have a large enough pool of registered IP addresses for all the users on your internal network that require concurrent connectivity to the public Internet. [Figure 2-6](#) illustrates a network using unregistered IP addresses on the intranet, which requires NAT for connecting to the public Internet.

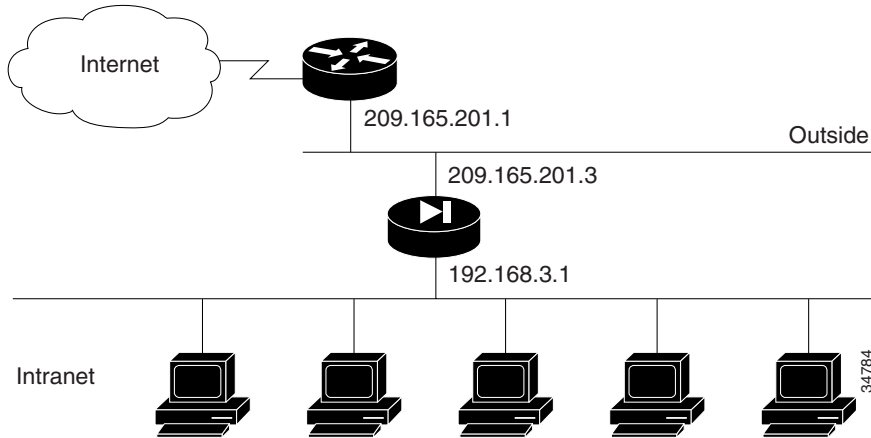
**Figure 2-6 Two Interfaces with NAT or PAT**

The following steps show how to change the example given in “[Two Interfaces Without NAT or PAT](#)” for enabling NAT and PAT:

**Step 1** Identify the IP addresses for each interface:

```
ip address outside 209.165.201.3 255.255.255.224
ip address inside 192.168.3.1 255.255.255.0
```

This step differs from “[Two Interfaces Without NAT or PAT](#)” because the inside IP addresses in this example are unregistered.

**Step 2** Enter the following command to enable NAT and PAT:

```
nat (inside) 1 0 0
```

This permits all inside users to start outbound connections using the translated IP addresses from a global pool. This command replaces the command in [Step 10](#) in “[Two Interfaces Without NAT or PAT](#).”

**Step 3** Create a pool of global addresses that translated addresses use when they exit the PIX Firewall from the protected networks to the unprotected networks:

```
global (outside) 1 209.165.201.10-209.165.201.30
global (outside) 1 209.165.201.8
```

The **global** command statement is associated with a **nat** command statement by the NAT ID, which in this example is 1. Because there are limited IP addresses in the pool, a PAT external (global) address is added to handle overflow.

[Example 2-3](#) shows the complete configuration for configuring two interfaces with NAT.

### **Example 2-3 Two Interfaces with NAT**

```
nameif ethernet0 outside security0
nameif ethernet1 inside security100
interface ethernet0 100basetx
interface ethernet1 100basetx
ip address outside 209.165.201.3 255.255.255.224
ip address inside 192.168.3.1 255.255.255.0
hostname pixfirewall
arp timeout 14400
```



```

no failover
names
pager lines 24
logging buffered debugging
nat (inside) 1 0 0
global (outside) 1 209.165.201.10-209.165.201.30
global (outside) 1 209.165.201.8
route outside 0.0.0.0 0.0.0.0 209.165.201.1 1
access-list acl_out permit icmp any any
access-group acl_out in interface outside
timeout xlate 3:00:00
timeout conn 1:00:00 half-closed 0:10:00
udp 0:02:00 rpc 0:10:00 h323 0:05:00
sip 0:30:00 sip_media 0:02:00
timeout uauth 0:05:00 absolute
no snmp-server location
no snmp-server contact
snmp-server community public
mtu outside 1500
mtu inside 1500

```

## Three Interfaces Without NAT or PAT

In [Figure 2-7](#), the PIX Firewall has three interfaces configured without address translation.

**Figure 2-7** Three-interface Configuration Without NAT or PAT

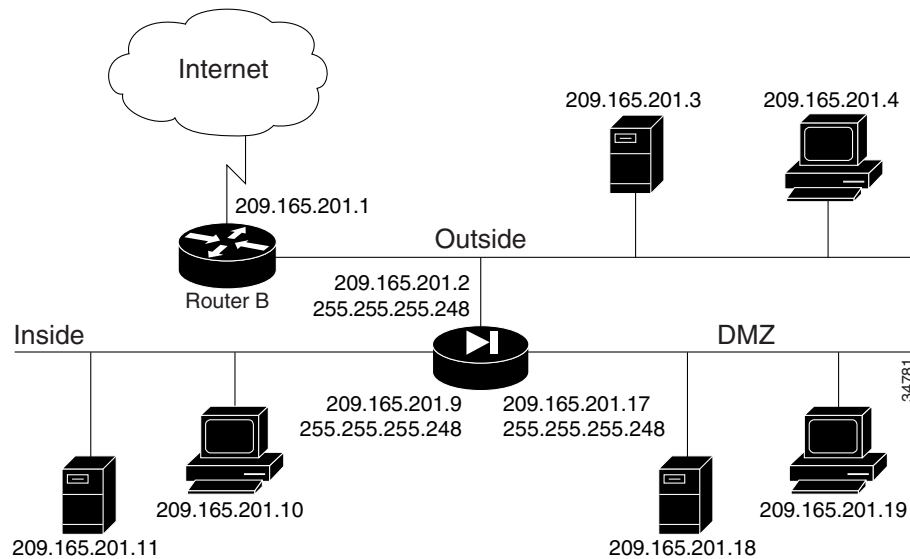

The network has the following IP addresses and network masks:

- Outside network interface address: 209.165.201.2, network mask: 255.255.255.248
- Inside network interface address: 209.165.201.9, network mask: 255.255.255.248
- DMZ network interface address: 209.165.201.17, network mask: 255.255.255.248

In addition, the DMZ host 209.165.201.19 must be accessible from hosts on the outside interface.

The following procedure shows the way the configuration for this example differs from the example shown in “[Two Interfaces Without NAT or PAT](#).”

---

**Step 1** Identify the security level and names of each interface by entering the following commands:

```
nameif ethernet0 outside security0
nameif ethernet1 inside security100
nameif ethernet2 dmz security50
```

An additional **nameif** command is required for the third interface in this example.

**Step 2** Identify the line speed of each interface by entering the following commands:

```
interface ethernet0 100basex
interface ethernet1 100basex
interface ethernet2 100basex
```

An additional **interface** command is required for the third interface in this example.

**Step 3** Identify the IP addresses for each interface:

```
ip address outside 209.165.201.2 255.255.255.248
ip address inside 209.165.201.9 255.255.255.248
ip address dmz 209.165.201.17 255.255.255.248
```

An additional IP address is required for the third interface in this example.

**Step 4** Map access to the 209.165.201.19 host on the dmz interface:

```
static (dmz,outside) 209.165.201.2 209.165.201.19 netmask 255.255.255.248
```

**Step 5** Use the **access-list** command to let any outside user access the DMZ host on any port:

```
access-list acl_out permit tcp any host 209.165.201.19
access-group acl_out in interface outside
```

The **access-list** command lets any outside user access the host on any port.

---

[Example 2-4](#) shows the complete configuration for three interfaces without NAT.

#### **Example 2-4 Three Interfaces Without NAT or PAT**

```
nameif ethernet0 outside security0
nameif ethernet1 inside security100
nameif ethernet2 dmz security50
hostname pixfirewall
names
access-list acl_out permit tcp any host 209.165.201.19
access-list acl_out permit icmp any any
access-list ping_acl permit icmp any any
pager lines 24
logging buffered debugging
interface ethernet0 100basex
interface ethernet1 100basex
interface ethernet2 100basex
mtu outside 1500
mtu inside 1500
ip address outside 209.165.201.2 255.255.255.248
ip address inside 209.165.201.9 255.255.255.248
ip address dmz 209.165.201.17 255.255.255.248
```

```

no failover
arp timeout 14400
nat (inside) 0 209.165.201.8 255.255.255.248
static (dmz,outside) 209.165.201.2 209.165.201.19 netmask 255.255.255.248
access-group acl_out in interface outside
access-group ping_acl in interface inside
access-group ping_acl in interface dmz
route outside 0.0.0.0 0.0.0.0 209.165.201.1 1
timeout xlate 3:00:00
timeout conn 1:00:00 half-closed 0:10:00
udp 0:02:00 rpc 0:10:00 h323 0:05:00
sip 0:30:00 sip_media 0:02:00
timeout uauth 0:05:00 absolute
no snmp-server location
no snmp-server contact
snmp-server community public

```

## Three Interfaces with NAT and PAT

In [Figure 2-8](#), the PIX Firewall has three interfaces and these attributes:

- Address translation is performed between the interfaces.
- A web server on the DMZ interface is publicly accessible. The **name** command maps its host address to the name “webserver.”
- The inside network has private addresses (10.0.0.0), the DMZ interface has RFC 1597 addresses (192.168.0.0), and the outside network has legal, registered addresses (209.165.201.0).
- TCP and UDP connections from the inside are allowed to go out on the DMZ and outside.
- An inside host has been given Telnet access to the PIX Firewall console.

**Figure 2-8** Three Interfaces with NAT and PAT

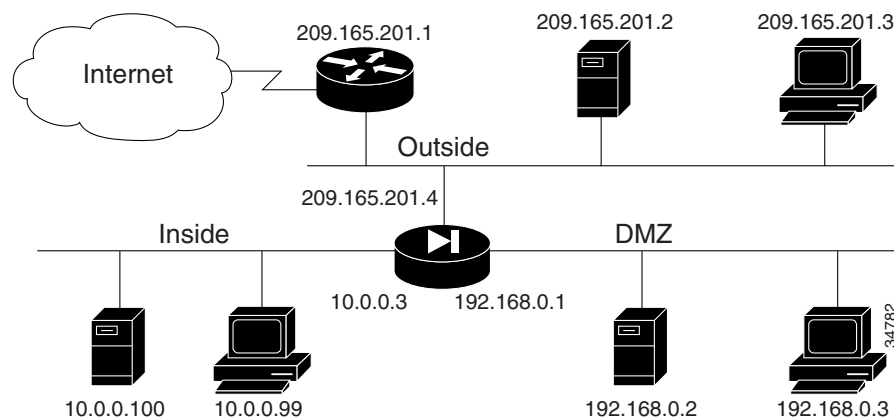

The network has the following IP addresses and network masks:

- Outside network interface address: 209.165.201.4, network mask: 255.255.255.224
- Allowable global and static addresses on the outside network: 209.165.201.5-209.165.201.30, network mask: 255.255.255.224
- Inside network interface address: 10.0.0.3, network mask: 255.0.0.0
- DMZ network interface address: 192.168.0.1, network mask: 255.255.255.0

The following procedure shows the commands that differ from the example shown in “[Three Interfaces Without NAT or PAT](#)”:

- 
- Step 1** Enable Telnet access for a host on the inside interface of the PIX Firewall by entering the following commands:
- ```
telnet 10.0.0.100 255.255.255.255
telnet timeout 15
```
- Step 2** Create a pool of global addresses for the outside and DMZ interfaces. Because there are limited outside IP addresses, add a PAT global to handle overflow. The **global (dmz)** command gives inside users access to the web server on the DMZ interface.
- ```
global (outside) 1 209.165.201.10-209.165.201.30
global (outside) 1 209.165.201.5
global (dmz) 1 192.168.0.10-192.168.0.20
```
- Step 3** Let inside users start connections on the DMZ and outside interfaces, and let DMZ users start connections on the outside interface:
- ```
nat (inside) 1 10.0.0.0 255.0.0.0
nat (dmz) 1 192.168.0.0 255.255.255.0
```
- Step 4** Give the IP address of the web server a label:
- ```
name 192.168.0.2 webserver
```
- Step 5** Let any user on the outside interface access the web server on the DMZ interface:
- ```
static (dmz,outside) 209.165.201.6 webserver netmask 255.255.255.255
access-list acl_out permit tcp any host 209.165.201.6 eq 80
access-group acl_out in interface outside
```

The **access-list** command statement is bound to the outside interface by the **access-group** command statement.

Example 2-5 Three Interfaces with NAT and PAT

```
nameif ethernet0 outside security0
nameif ethernet1 inside security100
nameif ethernet2 dmz security50
hostname pixfirewall
names
name 192.168.0.2 webserver
access-list acl_out permit icmp any any
access-list acl_out permit tcp any host 209.165.201.6 eq 80
access-list ping_acl permit icmp any any
pager lines 24
logging buffered debugging
interface ethernet0 100basetx
interface ethernet1 100basetx
interface ethernet2 100basetx
mtu outside 1500
mtu inside 1500
mtu dmz 1500
ip address outside 209.165.201.4 255.255.255.224
ip address inside 10.0.0.3 255.0.0.0
ip address dmz 192.168.0.1 255.255.255.0
no failover
arp timeout 14400
```

```
global (outside) 1 209.165.201.10-209.165.201.30
global (outside) 1 209.165.201.5
global (dmz) 1 192.168.0.10-192.168.0.20
nat (inside) 1 10.0.0.0 255.0.0.0
nat (dmz) 1 192.168.0.0 255.255.255.0
static (dmz,outside) 209.165.201.6 webserver netmask 255.255.255.255
access-group acl_out in interface outside
access-group ping_acl in interface inside
access-group ping_acl in interface dmz
no rip inside passive
no rip outside passive
no rip inside default
no rip outside default
route outside 0.0.0.0 0.0.0.0 209.165.201.1 1
timeout xlate 3:00:00
timeout conn 1:00:00 half-closed 0:10:00
udp 0:02:00 rpc 0:10:00 h323 0:05:00
sip 0:30:00 sip_media 0:02:00
timeout uauth 0:05:00 absolute
no snmp-server location
no snmp-server contact
snmp-server community public
telnet 10.0.0.100 255.255.255.255
telnet timeout 15
```

Using VLANs with the Firewall

PIX Firewall Version 6.3 introduces support for VLANs. This section describes how to use and implement VLANs with firewall and includes the following topics:

- [Overview, page 2-33](#)
- [Using Logical Interfaces, page 2-34](#)
- [VLAN Security Issues, page 2-34](#)
- [Configuring PIX Firewall with VLANs, page 2-35](#)
- [Managing VLANs, page 2-36](#)

Overview

Virtual LANs (VLANs) are used to create separate broadcast domains within a single switched network. Some of the benefits of VLANs include the following:

- Broadcast control
- Improved security
- Flexibility
- Scalability

A VLAN can be created through software configuration whenever it is needed because no actual separation is required in the physical or data link network. To create a VLAN, you simply assign ports on each switch to the new VLAN. However, the VLAN must then be interconnected to the rest of your network through a router or other device that can forward packets between the ports assigned to the VLAN.

Using Logical Interfaces

With Version 6.3, you can assign VLANs to physical interfaces on the PIX Firewall, or you can configure multiple logical interfaces on a single physical interface and assign each logical interface to a specific VLAN.

A logical interface is similar in many respects to a so-called physical interface. Both logical and physical interfaces are software objects (the actual *physical* object is the network interface card on the PIX Firewall unit). What is called the physical interface for the purpose of configuration is a software object that has both Layer 2 (Data link) and Layer 3 (Network) attributes. Layer 2 attributes include maximum transmission unit (MTU) size and failover status, while Layer 3 attributes include IP address and security level.

A logical interface has only Layer 3 attributes. As a result, you can issue certain commands, such as **failover link** *if_name* or **failover lan interface** *if_name* on a physical interface that you cannot use with a logical interface. When you disable a physical interface, all the associated logical interfaces are also disabled. When you disable a logical interface, it only affects the logical interface.

The number of logical interfaces that you can configure varies according to the model. The minimum number of interfaces for any PIX Firewall is two. Table 2-6 lists the maximum number of logical interfaces supported on a specific PIX Firewall model:

Table 2-6 Maximum Number of Interfaces Supported on PIX Firewall Models

Model	Restricted License ¹			Unrestricted License		
	Total Interfaces	Physical Interfaces	Logical Interfaces	Total Interfaces	Physical Interfaces	Logical Interfaces
PIX 501 ²	NA	NA	NA	2	2	Not supported
PIX 506/506E	NA	NA	NA	2	2	Not supported
PIX 515/515E	5	3	3	10	6	8
PIX 520 ³	NA	NA	NA	12	6	10
PIX 525	8	6	6	12	8	10
PIX 535	10	8	8	24	10	22

1. PIX 501 and PIX 506/506E do not support Restricted/Unrestricted licenses.
2. One interface of the PIX 501 connects to an integrated 4-port switch.
3. PIX 520 supports a connection license and the number of interfaces does not vary with the connection license.



Note

To determine the maximum number of logical interfaces that you can use, subtract the number of physical interfaces in use on your PIX Firewall from the number of total interfaces.

VLAN Security Issues

By default, with no VLANs configured, the PIX Firewall sends untagged packets to any directly connected switch. If an untagged packet is received by a switch on a trunk port, the switch forwards the packet on the native VLAN assigned for that trunk port. By default, switches assign VLAN 1 to the native VLAN.

In the attack called “jumping VLANs” an attacker injects packets onto other VLANs from the native VLAN. To prevent this attack, never allow access to a native VLAN from any untrusted network. For maximum security, we recommend avoiding the use of native VLANs altogether when deploying VLANs in a secure environment. It is permitted to use native VLANs with the PIX Firewall, but you should clearly understand the security implications.

To prevent the forwarding of traffic from the PIX Firewall onto the native VLAN of a switch, use the **interface physical** command to assign a VLAN ID (other than VLAN 1) to the physical interface of the PIX Firewall. Be careful to assign a VLAN ID that is different from whatever VLAN ID is assigned to the native VLAN on the switch.

Configuring PIX Firewall with VLANs

PIX Firewall Version 6.3 introduces the capability to interconnect VLANs, as illustrated in [Figure 2-9](#).

Figure 2-9 Using PIX Firewall (Version 6.3) to Interconnect VLANs

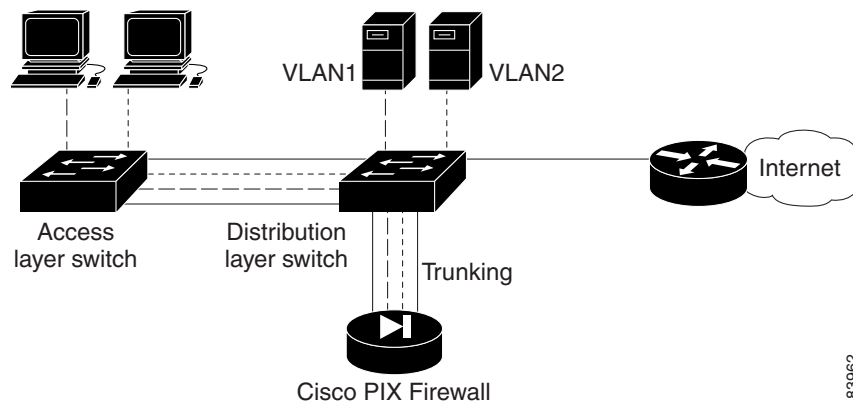

In [Figure 2-9](#), two VLANs are configured on two switches. Workstations are connected to the access layer switch, while servers are connected to the distribution layer switch. Links using the 802.1q protocol interconnect the two switches and the PIX Firewall. The 802.1q protocol allows trunking VLAN traffic between devices, which means that traffic to and from multiple VLANs can be transmitted over a single physical link. Each packet contains a VLAN tag that identifies the source and destination VLAN.

The PIX Firewall supports 802.1q, allowing it to send and receive traffic for multiple VLANs on a single interface.

In [Figure 2-9](#), the PIX Firewall is configured with one physical and one logical interface assigned to VLAN 2 and VLAN 3. The PIX Firewall interconnects the two VLANs, while providing firewall services, such as access lists, to improve network security.

To configure this example, follow these steps:

-
- Step 1** Assign the interface speed to a physical interface by entering the following command:
- ```
interface ethernet0 auto
```
- Step 2** Assign VLAN2 to the physical interface (ethernet0) by entering the following command:
- ```
interface ethernet0 vlan2 physical
```

By assigning a VLAN to the physical interface, you ensure that all frames forwarded on the interface will be tagged. VLAN 1 is not used because that is the default native VLAN for Cisco switches. Without the **physical** parameter, the default for the **interface** command is to create a logical interface.

- Step 3** Create a new logical interface (VLAN3) and tie it to the physical interface (ethernet0) by entering the following command:

```
interface ethernet0 vlan3 logical
```

This will allow the PIX Firewall to send and receive VLAN-tagged packets with a VLAN identifier equal to 3 on the physical interface, ethernet0.

- Step 4** Configure the logical and physical interfaces by entering the following commands:

```
nameif ethernet0 outside security0
nameif vlan3 dmz security50
ipaddress outside 192.168.101.1 255.255.255.0
ipaddress dmz 192.168.103.1 255.255.255.0
```

The first line assigns the name *outside* to ethernet0 (the physical interface) and sets the security level to zero. The second line assigns the name *dmz* to vlan3 (the logical interface) and sets the security level to 50. The third and fourth lines assign IP addresses to both interfaces.

After this configuration is enabled, the outside interface sends packets with a VLAN identifier of 2, and the dmz interface sends packets with a VLAN identifier of 3. Both types of packets are transmitted from the same physical interface (ethernet0).

Managing VLANs

To display information about the VLAN configuration, enter the following command:

```
show interface
```

To temporarily disable a logical interface, enter the following command:

```
interface ethernet0 vlan_id shutdown
```

Replace *vlan_id* with the VLAN ID associated with the logical interface that you want to temporarily shut down.

To change the VLAN ID of a logical interface, enter the following command:

```
interface change-vlan old_vlan_id new_vlan_id
```

Replace *old_vlan_id* with the existing VLAN ID and replace *new_vlan_id* with the new VLAN ID you want to use.

This command lets you change the VLAN ID without removing the logical interface, which is helpful if you have added a number of access-lists or firewall rules to the interface and you do not want to start over.

To disable VLAN tagging on the interface, enter the following command:

```
no interface ethernet0 vlan_id physical
```

Replace *vlan_id* with the VLAN ID for which you want to disable VLAN tagging.

To remove the logical interface and remove all configuration, enter the following command:

```
no interface ethernet0 vlan_id logical
```

Replace *vlan_id* with the VLAN ID associated with the logical interface that you want to remove.

**Caution**

Using this command removes the interfaces and deletes all configuration rules applied to the interface.

Using Outside NAT

Starting with PIX Firewall Version 6.2, NAT and PAT can be applied to traffic from an outside or less secure interface to an inside (more secure) interface. This functionality is called outside NAT and provides the following benefits:

- Provides transparent support for Domain Name System (DNS)
- Simplifies routing by specifying the IP addresses that appear on the more secure interfaces of the PIX Firewall
- Enables connectivity between networks with overlapping IP addresses

For information about how outside NAT enhances support for DNS, refer to the “[Basic Internet Protocols](#)” section in [Chapter 5, “Configuring Application Inspection \(Fixup\).”](#)

**Note**

Outside NAT does not work with application inspection (“fixup”) for Internet Locator Service (ILS).

This section describes the last two scenarios and includes the following topics:

- [Overview, page 2-37](#)
- [Simplifying Routing, page 2-38](#)
- [Configuring Overlapping Networks, page 2-39](#)

Overview

Outside NAT/PAT is similar to inside NAT/PAT, only the address translation is applied to addresses of hosts residing on the outer (less secure) interfaces of the PIX Firewall. To configure dynamic outside NAT, specify the addresses to be translated on the less secure interface and specify the global address or addresses on the inside (more secure) interface. To configure static outside NAT, use the **static** command to specify the one-to-one mapping.

After you configure outside NAT, when a packet arrives at the outer (less secure) interface of the PIX Firewall, the PIX Firewall attempts to locate an existing xlate (address translation entry) in the connections database. If no xlate exists, it searches the NAT policy from the running configuration. If a NAT policy is located, an xlate is created and inserted into the database. The PIX Firewall then rewrites the source address to the mapped or global address and transmits the packet on the inside interface. Once the xlate is established, the addresses of any subsequent packets can be quickly translated by consulting the entries in the connections database.

To enable outside NAT, enter the following command:

```
nat interface natid access-list acl-name outside
```

Replace *interface* with the name of the lower security interface and replace *natid* with the identifier of the NAT entry. Replace *acl-name* with the name of any access list you want to apply. The **outside** option causes the translation of host addresses on the lower security interface. By default, address translation occurs only for host addresses on the higher security or "inside" interface.

**Note**

If outside dynamic NAT is enabled on an interface, explicit NAT policy must be configured for all hosts on the interface.

Use a *natid* of **0** with the **outside** option to disable address translation of hosts residing on the lower security interface. Use this option only if outside dynamic NAT is configured on the interface. By default, address translation is automatically disabled for hosts connected to the lower security interface.

Simplifying Routing

You can use outside NAT to simplify router configuration on your internal or perimeter networks by controlling the addresses that appear on these networks. For example, in [Figure 2-10](#), the security policy allows clients in the network 209.165.201.0 to access only the servers on the internal network 192.168.101.0, including the web server 192.168.101.2.

Figure 2-10 Simplifying Routing with Outside NAT

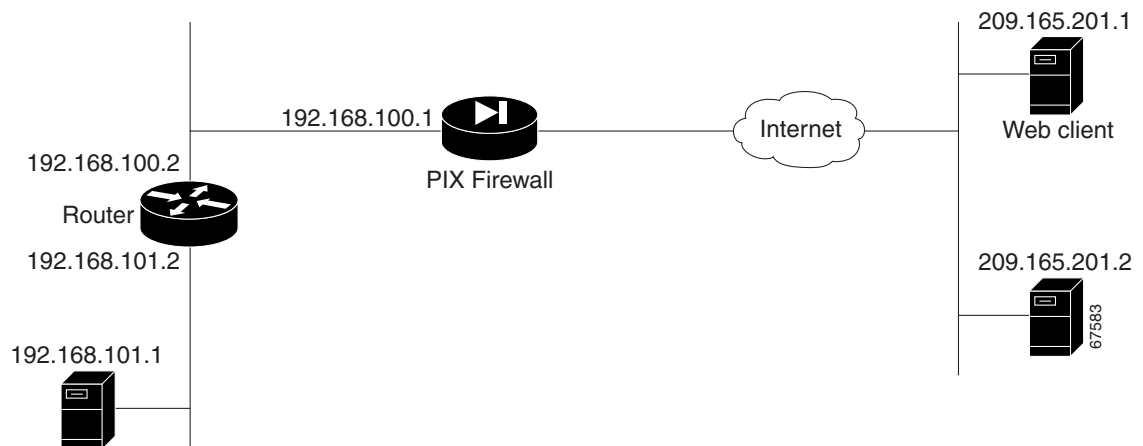

This policy can be supported by using the following command statements:

```
nat (outside) 1 209.165.201.0 255.255.255.0 outside
global (inside) 1 192.168.100.3-192.168.100.128
```

These commands translate all the source addresses on the remote network to a range of internal IP addresses (192.168.100.3-128). The router then automatically distributes the traffic from the inside interface of the PIX Firewall along with traffic originating on the 192.168.100.0 subnetwork.

Configuring Overlapping Networks

In [Figure 2-11](#), the PIX Firewall connects two private networks with overlapping address ranges.

Figure 2-11 Using Outside NAT with Overlapping Networks

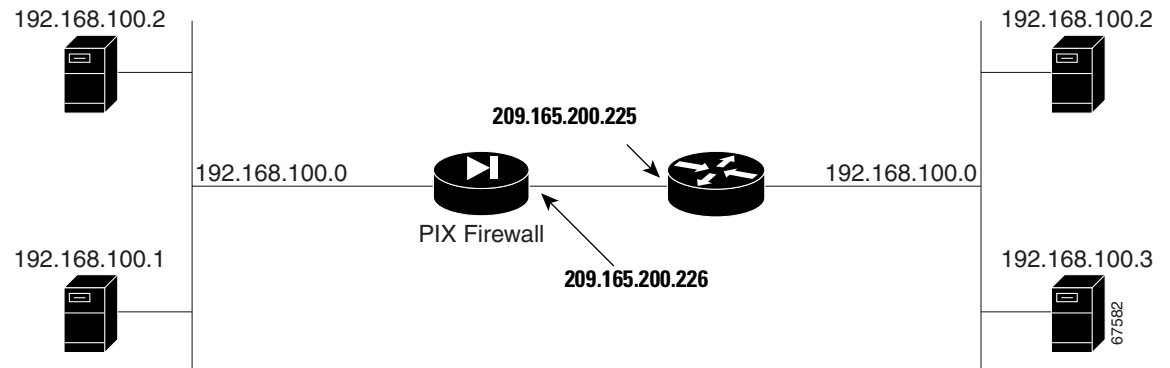

In [Figure 2-11](#), two networks use an overlapping address space and two hosts with the same IP address (192.168.100.2) must communicate. A router (209.165.200.225) connects the outside interface of the PIX Firewall (209.165.200.226) to the network on the right. The following regular NAT and outside NAT statements map each address in the private network 192.168.100.0 to the corresponding address in the public network 209.165.201.0:

```
static (inside,outside) 209.165.201.0 192.168.100.0 netmask 255.255.255.0
static (outside, inside) 209.165.201.0 192.168.100.0 netmask 255.255.255.0
```

In this example, if host 192.168.100.2 on the right network initiates a connection to host 192.168.100.2 on the left network, it uses the IP address 209.165.201.2. When the PIX Firewall receives this message, the destination address is translated from 209.165.201.2 to 192.168.100.2. Then the static that enables outside NAT is applied, and the source address is changed from 192.168.100.2 to 209.165.201.2 and is then forwarded.

The response is forwarded to the PIX Firewall with the destination address 209.165.201.2 so the outside NAT static is applied and the destination address is changed to 192.168.100.2. Then the regular NAT static is applied and the source address gets changed from 192.168.100.2 to 209.165.201.2.



Note

To enable connectivity between the two overlapping networks, the **alias** command can be used with previous versions of PIX Firewall, or static outside NAT can be used with PIX Firewall Version 6.2 or higher. We recommend using static outside NAT instead of the **alias** command because it allows the isolation of address translation between two interfaces and optionally supports rewriting of DNS address resource records.

The NAT command for regular NAT, which translates the inside hosts from 192.168.100.0/24 into 209.165.201.0/24 on the outside network, is as follows:

```
static (inside,outside) 209.165.201.0 192.168.100.0 netmask 255.255.255.0
```

The NAT command for outside NAT, which translates the outside hosts from 192.168.100.0/24 into 209.165.201.0/24 on the inside network, is as follows:

```
static (outside, inside) 209.165.201.0 192.168.100.0 netmask 255.255.255.0
```

In addition, the following routes need to be added in the PIX Firewall:

```
route outside 192.168.100.128 255.255.255.128 209.165.200.225 2
route outside 192.168.100.0 255.255.255.128 209.165.200.225 2
```

**Note**

Splitting the netmask is required because an overlapping route cannot exist with a connected route.

Policy NAT

Policy NAT lets you identify local traffic for address translation by specifying the source and destination addresses (or ports) in an access list. Regular NAT uses source addresses/ports only, whereas policy NAT uses both source and destination addresses/ports.

**Note**

All types of NAT support policy NAT, except for NAT exemption. NAT exemption uses an access list to identify the local addresses, but differs from policy NAT in that the ports are not considered.

With policy NAT, you can create multiple NAT or static statements that identify the same local address as long as the source/port and destination/port combination is unique for each statement. You can then match different global addresses to each source/port and destination/port pair.

Figure 2-12 shows a host on the 10.1.2.0/24 network accessing two different servers. When the host accesses the server at 209.165.201.11, the local address is translated to 209.165.202.129. When the host accesses the server at 209.165.200.225, the local address is translated to 209.165.202.130.

Figure 2-12 Policy NAT with Different Destination Addresses

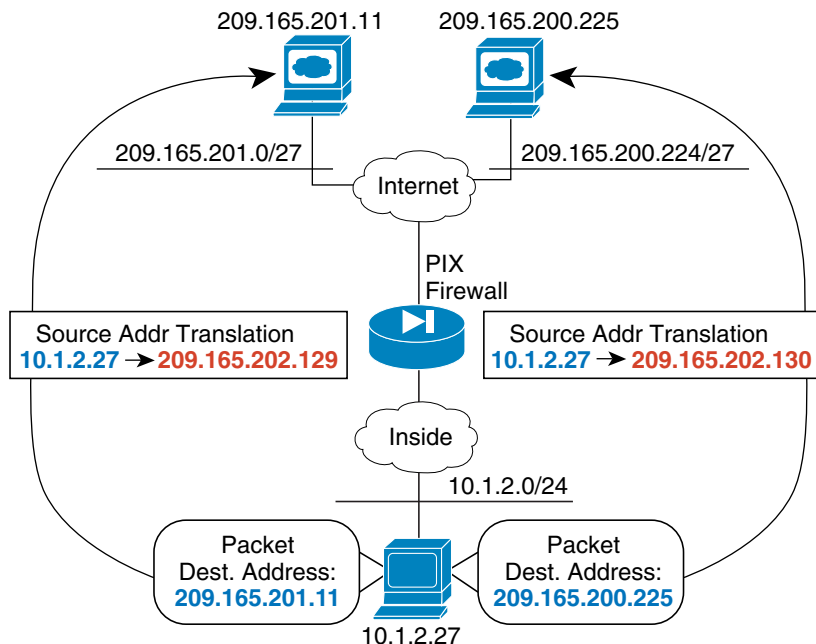

The syntax for using global translations for the hosts shown in Figure 2-12 follows:

```
access-list NET1 permit ip 10.1.2.0 255.255.255.0 209.165.201.0 255.255.255.224
access-list NET2 permit ip 10.1.2.0 255.255.255.0 209.165.200.224 255.255.255.224
nat (inside) 1 access-list NET1
global (outside) 1 209.165.202.129 255.255.255.255
nat (inside) 2 access-list NET2
global (outside) 2 209.165.202.130 255.255.255.255
```

The syntax for using static translations for the two hosts shown in Figure 2-12 follows:

```
access-list NET1 permit ip host 10.1.2.27 209.165.201.0 255.255.255.224
access-list NET2 permit ip host 10.1.2.27 209.165.200.224 255.255.255.224
static (inside,outside) 209.165.202.129 access-list NET1
static (inside,outside) 209.165.202.130 access-list NET2
```

Figure 2-13 shows the use of source and destination ports. The host on the 10.1.2.0/24 network accesses a single host for both web services and Telnet services. When the host accesses the server for web services, the local address is translated to 209.165.202.129. When the host accesses the same server for Telnet services, the local address is translated to 209.165.202.130.

Figure 2-13 Policy NAT with Different Destination Ports

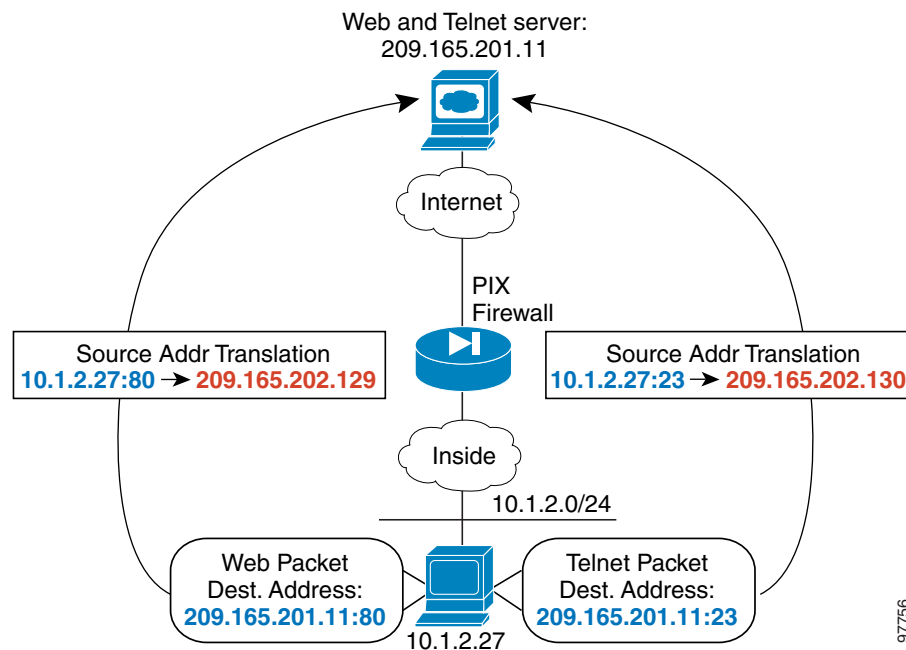

The syntax for this configuration example follows:

```
access-list WEB permit tcp 10.1.2.0 255.255.255.0 209.165.201.11 255.255.255.255 eq 80
access-list TELNET permit tcp 10.1.2.0 255.255.255.0 209.165.201.11 255.255.255.255 eq 23
nat (inside) 1 access-list WEB
global (outside) 1 209.165.202.129 255.255.255.255
nat (inside) 2 access-list TELNET
global (outside) 2 209.165.202.130 255.255.255.255
```

Limitations

The following configuration limitations apply to policy NAT:

- Access lists must contain permit statements only. Access lists for policy NAT cannot contain **deny** statements.
- An access list must be used only once with the **nat** command. For example, the following configuration would produce an error:

```
nat (inside) 1 access-list mylist-A
nat (inside) 2 access-list mylist-A
```

Whereas, the following configuration would *not* produce an error:

```
nat (inside) 1 access-list mylist-A
nat (inside) 2 access-list mylist-B
```

- Use an access list only once between the **nat** and **static** commands.
- A global address cannot be used concurrently for NAT and PAT.
- **static** commands are matched and executed before **nat** commands.
- Policy NAT does not support SQL*Net, which is supported by regular NAT.

Configuring Policy NAT

This section describes how to configure both global translations and static translations. Refer to [Figure 2-12 on page 2-40](#) and proceed with the configuration that fits the needs of your network.

Configuring Global Translations

Step 1 Configure IP addresses for the inside and outside interfaces.

```
ip address inside 10.1.2.1 255.255.255.0
ip address outside 209.165.202.129 255.255.255.255
```

Step 2 Configure access lists to define traffic for translation.



Note Access lists for policy NAT cannot contain **deny** statements.

```
access-list NET1 permit ip 10.1.2.0 255.255.255.0 209.165.201.0 255.255.255.224
access-list NET2 permit ip 10.1.2.0 255.255.255.0 209.165.200.224 255.255.255.224
```

Step 3 Enter **nat** commands that use the same identifier as those defined with the **access-list** statements in Step 2.

```
nat (inside) 1 access-list NET1
nat (inside) 2 access-list NET2
```

- Step 4** Enter **global** commands to associate the outside addresses for translation to the outside destination networks.

```
global (outside) 1 209.165.202.129 255.255.255.255
global (outside) 2 209.165.202.130 255.255.255.255
```

Configuring Static Translations

- Step 1** Configure IP addresses for the inside and outside interfaces.

```
ip address inside 10.1.2.1 255.255.255.0
ip address outside 209.165.202.129 255.255.255.255
```

- Step 2** Configure access lists to define traffic for translation.



Note Access lists for policy NAT cannot contain **deny** statements.

```
access-list NET1 permit ip host 10.1.2.27 209.165.201.0 255.255.255.224
access-list NET2 permit ip host 10.1.2.27 209.165.200.224 255.255.255.224
```

- Step 3** Configure static translations to individual hosts.

```
static (inside,outside) 209.165.202.129 access-list NET1
static (inside,outside) 209.165.202.130 access-list NET2
```

Enabling Stub Multicast Routing

This section describes how to implement the Stub Multicast Routing (SMR) feature, introduced with PIX Firewall Version 6.2. It includes the following topics:

- [Overview, page 2-44](#)
- [Allowing Hosts to Receive Multicast Transmissions](#)
- [Forwarding Multicasts from a Transmission Source, page 2-46](#)
- [Configuring IGMP Timers, page 2-47](#)
- [Clearing IGMP Configuration, page 2-47](#)
- [Viewing and Debugging SMR, page 2-48](#)
- [For More Information about Multicast Routing, page 2-49](#)

Overview

SMR allows the PIX Firewall to function as a “stub router.” A stub router is a device that acts as an Internet Group Management Protocol (IGMP) proxy agent. The IGMP is used to dynamically register specific hosts in a multicast group on a particular LAN with a multicast (MC) router. MC routers route multicast data transmissions to the hosts on each LAN in an internetwork that are registered to receive specific multimedia or other broadcasts. A stub router forwards IGMP messages between hosts and MC routers.

The Protocol Independent Multicast (PIM) protocol provides a scalable method for determining the best paths in a network for distributing a specific multicast transmission to each host that has registered using IGMP to receive the transmission. With PIM sparse mode (PIM/SM), which is the default for Cisco routers, when the source of a multicast transmission begins broadcasting, the traffic is forwarded from one MC router to the next until the packets reach every registered host. If a more direct path to the traffic source exists, the last-hop router sends a join message toward the source that causes the traffic to be rerouted along the better path.

Allowing Hosts to Receive Multicast Transmissions

When hosts that need to receive a multicast transmission are separated from the MC router by a PIX Firewall, configure the PIX Firewall to forward IGMP reports from the downstream hosts and to forward multicast transmissions from the upstream router. The upstream router is the next-hop interface toward the transmission source from the outside interface of the PIX Firewall.

To allow hosts to receive multicast transmissions through the PIX Firewall, perform the following steps:

-
- Step 1** Enable multicast forwarding on each interface by entering the following command:

```
multicast interface interface-name
```

This command enables multicast support on the specified interface and places the interface in multicast promiscuous mode. When you enter this command, the CLI enters multicast subcommand mode and the prompt changes to identify the interface you are configuring.

To use this command, replace *interface-name* with the name of the PIX Firewall interface on which you wish to enable multicast forwarding.

- Step 2** Configure the maximum number of IGMP groups, by entering the following command from multicast subcommand mode:

```
igmp max-groups n
```

To use this command, replace *n* with the maximum number of IGMP groups you wish to allow on the specified interface. The range of groups supported (max-groups) is from 1 to 2000. A value of 0 causes no IGMP groups to be allowed.

- Step 3** Enable IGMP forwarding on each PIX Firewall interface connected to hosts that will receive multicast transmissions.

Enter the following subcommand for each multicast interface, which is typically an inside or more secure interface.

```
igmp forward interface mc-source-if-name
```

Replace *mc-source-if-name* with the name of the PIX Firewall interface that is connected to the MC router. This is typically the outside interface. For example, the following command enables the forwarding of IGMP reports on the currently selected PIX Firewall interface, when the MC router is connected to the interface named “outside.”

```
igmp forward interface outside
```

Step 4 (Optional) Define static IGMP entries by using the following command:

```
igmp join-group group-address
```

Enter this command on the downstream interface, which has receiving hosts in the multicast group.

This command configures the interface to be a statically connected member of the specified group. This allows the PIX Firewall to act for a client that may not be able to respond via IGMP, but still requires reception. This command is applied to the downstream interface toward the receiving hosts.

Step 5 Create an access list entry to permit inbound traffic to the multicast address:

```
access-list acl_ID permit udp host ip-address host group-address
```

Step 6 Apply the access list to the Outside interface for inbound multicast transmissions:

```
access-group acl_ID in interface outside
```



Note It is suggested that you narrow down the host that is sourcing the multicast stream.

Step 7 (Optional) Configure the multicast groups that hosts can join:

```
access-list acl_ID permit igmp any destination_addr destination_mask
```

This command configures an access control list that allows IGMP traffic to permissible Class D destination addresses.

- Replace *acl_ID* with the name of the access control list.
- Replace *destination_addr* with the Class D address of the multicast group from which you wish to allow hosts to receive multicast transmissions. To define many multicast groups with a single command, use the object grouping feature, described in “[Simplifying Access Control with Object Grouping](#)” in [Chapter 3, “Controlling Network Access and Use.”](#)

Step 8 Apply the access list by entering the following command from the multicast subcommand mode:

```
igmp access-group acl_ID
```

This command applies the access list to the multicast interface that you are currently configuring.

Example 2-6 Inside Receiving Hosts

In the following example, inside clients must register with the multicast group with the Class D address 225.2.1.14:

```
multicast interface inside
  igmp join-group 225.2.1.14
```

After entering these commands, the PIX Firewall will act as an interested host for 224.1.1.1 and act accordingly on the interface to which the command was applied. Other downstream interfaces may be added to the list dynamically via IGMP.

Example 2-7 Inside Receiving Hosts with Access Control

The following example configures the inside and DMZ receivers:

```

multicast interface outside
  igmp access-group 1
multicast interface inside
  igmp forward interface outside
  igmp access-group 1
multicast interface dmz
  igmp forward interface outside
  igmp access-group 1
! The following permits igmp messages to 225.2.1.0/25 network
access-list 1 permit igmp any 225.2.1.0 255.255.255.128
access-list 1 deny ip any any

! The following permits multicast packets in the network 225.2.1.0/25 in the
! outside interface of the PIX
access-list 100 permit udp any 225.2.1.0 255.255.255.128
access-list 100 in interface outside

```

Forwarding Multicasts from a Transmission Source

When a multicast transmission source is on the inside (or more secure) interface of a PIX Firewall, you must configure the PIX Firewall to enable multicast forwarding from the source. You enable multicast forwarding on the PIX Firewall interfaces towards each network containing hosts that are registered to receive multicast transmissions from the source.

To configure the PIX Firewall to forward multicast transmissions from a source, perform the following steps:

Step 1 Enable multicast forwarding on each PIX Firewall interface by entering the following command:

```
multicast interface interface-name
```

This command enables multicast support on the specified interface and places the interface in multicast promiscuous mode. When you enter this command, the CLI enters multicast subcommand mode and the prompt changes to identify the interface you are configuring.

To use this command:

- Replace *interface-name* with the name of the PIX Firewall interface on which you wish to enable multicast forwarding.

Step 2 Create a static route from the transmission source to the next-hop router interface:

```
[no] mroute src smask in-if-name dst dmask out-if-name
```

- Replace *src* and *smask* with the IP address and subnet mask of the multicast source.
- Replace *in-if-name* with the name of the PIX Firewall interface connected to the multicast source. This is typically the inside (or more secure) interface.
- Replace *dst* and *dmask* with the Class D address and subnet mask for the multicast transmission from the source.

- Replace *out-if-name* with the name of the PIX Firewall interface connected to the next-hop router interface toward the hosts registered to receive the transmission. This is typically the outside (or less secure) interface.

Example 2-8 Inside Transmission Sources

The following example configures the inside and DMZ sources with no internal receivers:

```
multicast interface outside
multicast interface inside
multicast interface dmz
mroute 1.1.1.1 255.255.255.255 inside 230.1.1.2 255.255.255.255 outside
mroute 2.2.2.2 255.255.255.255 dmz 230.1.1.2 255.255.255.255 outside
```

Configuring IGMP Timers

This section describes how to change the default values for IGMP timers and includes the following topics:

- [Setting the Query Interval, page 2-47](#)
- [Setting Query Response Time, page 2-47](#)

Setting the Query Interval

Use the following command to configure the frequency at which IGMP query messages are sent by the interface:

```
[no] igmp query-interval seconds
```

The default is 60 seconds. To set the query interval back to the default, use the **no igmp query-interval** command.

Setting Query Response Time

Use the following command to change the maximum query response time (for IGMP Version 2 only):

```
[no] igmp query-max-response-time seconds
```

The default is 10 seconds. To set the query response time back to the default, use the **no igmp query-max-response-time** command.

Clearing IGMP Configuration

This section describes how to clear IGMP entries.

Use the following command to delete entries from the IGMP cache:

```
clear igmp group [group-addr | interface interface-name]
```

Replace *group-addr* with the multicast group IP address. Replace *interface-name* with the interface name on your PIX Firewall on which IGMP is enabled.

Use the following command to clear static multicast routes:

```
clear mroute [src-addr | group-addr | interface interface_name]
```

Replace *src-addr* with the IP address of the multicast source. Replace *group-addr* with the address of the receiving multicast group. Replace *interface-name* with the PIX Firewall interface on which multicasts are enabled.

Viewing and Debugging SMR

This section describes commands that you can use to view the current Multicast and IGMP configuration and for enabling debugging.

To display all or per-interface multicast settings, enter the following command:

```
show multicast [interface interface-name]
```

This also displays IGMP configuration for the interface. To use this command, replace *interface-name* with the name of the interface for which you wish to view configuration settings.

To display multicast-related information about one or more groups, enter the following command:

```
show igmp groups [group-address | interface interface-name]
```

Replace *group-address* with the Class D IP address of the group and replace *interface-name* with the name of the interface connected to the network where the groups are registered. The following is sample output for a working configuration:

```
pix-2(config)# show igmp
IGMP is enabled on interface outside
  IGMP querying router is 192.168.9.1
IGMP Connected Group Membership
  Group Address      Interface      Uptime      Expires      Last Reporter
IGMP is enabled on interface inside
  Current IGMP version is 2
  IGMP query interval is 60 seconds
  IGMP querier timeout is 125 seconds
  IGMP max query response time is 10 seconds
  Last member query response interval is 1 seconds
  Inbound IGMP access group is 1
  IGMP max groups is 500
  IGMP activity: 1 joins, 0 leaves
  IGMP forwarding on interface outside
  IGMP querying router is 10.10.10.161 (this system)
IGMP Connected Group Membership
  Group Address      Interface      Uptime      Expires      Last Reporter
  225.2.1.14         inside         19:10:41    never         10.10.10.161
```

To show all static multicast routes, enter the following command:

```
show mroute [src-address | group-address | interface interface_name]
```

Replace *src-address* with the IP address of the multicast transmission source or replace *group-address* with the Class D IP address of the group. Replace *interface-name* with the name of the interface connected to the network where the groups are registered. The following is sample output for a working configuration:

```
pix-2(config)# show mroute
IP Multicast Forwarding Information Base
Entry flags: C - Directly-Connected Check, S - Signal, D - Drop
Interface flags: F - Forward, A - Accept, IC - Internal Copy,
NS - Negate Signal, DP - Don't Preserve, SP - Signal Present,
```

```

EG - Egress
Forwarding Counts: Packets in/Packets out/Bytes out
Failure Counts: RPF / TTL / Empty Olist / Other
(*,225.2.1.14),  Flags: S
  Last Used: 0:00:16
  Forwarding Counts: 3/1/188
  Failure Counts: 0/0/2/0
  inside Flags: F
(192.168.1.113,225.2.1.14),  Flags:
  Last Used: 0:00:00
  Forwarding Counts: 1128/1128/212064
  Failure Counts: 0/0/0/0
  outside Flags: A SP
  inside Flags: F

```

The following is sample output from the **show mroute** command for a non-working configuration:

```

pix-2(config)# show mroute
IP Multicast Forwarding Information Base
Entry flags: C - Directly-Connected Check, S - Signal, D - Drop
Interface flags: F - Forward, A - Accept, IC - Internal Copy,
NS - Negate Signal, DP - Don't Preserve, SP - Signal Present,
EG - Egress
Forwarding Counts: Packets in/Packets out/Bytes out
Failure Counts: RPF / TTL / Empty Olist / Other
(*,225.2.1.14),  Flags: S
  Last Used: 0:02:18
  Forwarding Counts: 4/1/188
  Failure Counts: 0/0/3/0
  inside Flags: F
(192.168.1.113,225.2.1.14),  Flags:
  Last Used: 17:57:09
  Forwarding Counts: 502/0/0
  Failure Counts: 0/0/502/0
  outside Flags: A SP
  inside Flags: F

```

To enable (or disable) debugging for IGMP events, enter the following command:

```
[no] debug igmp
```

To enable (or disable) debugging for multicast forwarding events, enter the following command:

```
[no] debug mfw
```

For More Information about Multicast Routing

The following Cisco public websites provide background information about multicast routing:

http://www.cisco.com/warp/public/cc/pd/iosw/prodlit/ipimt_ov.htm

<http://www.cisco.com/warp/public/732/Tech/multicast/>

The following RFCs from the IETF provide technical details about the IGMP and multicast routing standards used for implementing the SMR feature:

- RFC 2236 IGMPv2
- RFC 2362 PIM-SM
- RFC 2588 IP Multicast and Firewalls
- RFC 2113 IP Router Alert Option
- IETF draft-ietf-idmr-igmp-proxy-01.txt



Controlling Network Access and Use

This chapter describes how to establish and control network connectivity for different applications and implementations after you have completed your basic configuration, described in [Chapter 2](#), “Establishing Connectivity.” This chapter contains the following sections:

- [Enabling Server Access with Static NAT, page 3-1](#)
- [Enabling Inbound Connections, page 3-2](#)
- [Controlling Outbound Connectivity, page 3-4](#)
- [Using the Static Command for Port Redirection, page 3-5](#)
- [Using Authentication and Authorization, page 3-8](#)
- [Access Control Configuration Example, page 3-14](#)
- [Using TurboACL, page 3-18](#)
- [Downloading Access Lists, page 3-20](#)
- [Simplifying Access Control with Object Grouping, page 3-24](#)
- [Filtering Outbound Connections, page 3-31](#)

Enabling Server Access with Static NAT

Static Network Address Translation (NAT) creates a permanent, one-to-one mapping between an address on an internal network (a higher security level interface) and a perimeter or external network (lower security level interface). For example, to share a web server on a perimeter interface with users on the public Internet, use static address translation to map the server’s actual address to a registered IP address. Static address translation hides the actual address of the server from users on the less secure interface, making casual access by unauthorized users less likely. Unlike NAT or PAT, it requires a dedicated address on the outside network for each host, so it does not save registered IP addresses.

If you use a **static** command to allow inbound connections to a fixed IP address, use the **access-list** and **access-group** commands to create an access list and to bind it to the appropriate interface. For more information, refer to “[Enabling Inbound Connections](#).”



Note

Do not use the PIX Firewall interface address with the **static** command if Stateful Failover is enabled. Doing this will prevent Stateful Failover from receiving its interface monitoring probes, which run over IP protocol 105, and as a result, the interface will appear to be in a waiting state. For further information about Stateful Failover, refer to [Chapter 10](#), “Using PIX Firewall Failover.”

The main options of the **static** command are as follows:

```
static [(internal_if_name, external_if_name)] global_ip local_ip [netmask network_mask]
[max_conns]
```

- Replace *internal_if_name* with the internal network interface name. In general, this is the higher security level interface you are accessing.
- Replace *external_if_name* with the external network interface name. In general, this is the lower security level interface you are accessing.
- Replace *global_ip* with the outside (global) IP address. In general, this is the interface with the lower security level. This address cannot be a PAT IP address.
- Replace *local_ip* with the internal (local) IP address from the inside network. In general, this is the interface with the higher security level.
- Replace *network_mask* with the network mask that pertains to both *global_ip* and *local_ip*. For host addresses, always use 255.255.255.255. For network addresses, use the appropriate subnet mask for the network.
- (Optional) replace *max_conns* with the maximum number of concurrent connections permitted through the static address translation.



Note To configure static translation for a host residing on the less secure interface (using outside NAT) reverse the interface in the **static** command. Refer to the *Cisco PIX Firewall Command Reference* for more information about the **static** command.

For example, the following command maps a server with an internal IP address of 10.1.1.3 to the registered IP address 209.165.201.12:

```
static (inside, outside) 209.165.201.12 10.1.1.3 netmask 255.255.255.255
```

This command simply maps the addresses; make sure you also configure access using the **access-list** and **access-group** commands, as described in the next section. Also, you must inform the DNS administrator to create an MX record for the external address so that traffic sent to the server host name is directed to the correct address.



Note For more information about how to configure static translation without NAT, refer to the **static** command in the *Cisco PIX Firewall Command Reference*.

Enabling Inbound Connections

By default, the PIX Firewall denies access to an internal or perimeter (more secure) network from an external (less secure) network. You specifically allow inbound connections by using access lists. Access lists work on a first-match basis, so for inbound access, you must deny first and then permit after.



Note Beginning with Version 5.3, the PIX Firewall uses access lists to control connections between inside and outside networks. Access lists are implemented with the **access-list** and **access-group** commands. These commands are used instead of the **conduit** and **outbound** commands, which were used in earlier versions of PIX Firewall. In PIX Firewall software releases later than Version 6.3, the **conduit** and **outbound** commands are no longer supported. To help you with the conversion process, a tool is available online at: <https://cco-dev.cisco.com/cgi-bin/Support/OutputInterpreter/home.pl>.

You use the **access-list** and **access-group** commands to permit access based on source or destination IP address, or by the protocol port number. Use the **access-list** command to create a single access list entry, and use the **access-group** command to bind one or more access list entries to a specific interface. Only specify one **access-group** command for each interface.

**Note**

To allow access only for specific users, set up authentication, as described in “[Using Authentication and Authorization](#).”

Before you can set up an access list for a host, set up address translation by using a **global** or **static** command. Setting up address translation with the **global** command is described in [Chapter 2, “Establishing Connectivity.”](#) Setting up address translation using the **static** command was described earlier in the previous section “[Enabling Server Access with Static NAT](#).”

The **access-list** command has many features, some of which are described in the following sections:

- [Using TurboACL, page 3-18](#)
- [Downloading Access Lists, page 3-20](#)
- [Simplifying Access Control with Object Grouping, page 3-24](#)

For the complete syntax of the **access-list** command, see the *Cisco PIX Firewall Command Reference*.

The basic syntax for the **access-list** command is as follows:

```
access-list ID [line line-num] {deny|permit} protocol <source_address | interface if_name>
[operator port] destination_address [operator port]
```

- Replace *ID* with a name or number you create to identify a group of **access-list** command statements; for example, “acl_inbound,” which identifies that the permissions apply to access from the outside interface.
- To insert a remark or an access control entry (ACE), use the **line** keyword. Replace *line-num* with the line number at which to make the insertion.
- Use **permit** or **deny** depending on whether you want to permit or deny access to the server. By default, all inbound access is denied, so you must permit access to a specific protocol or port.
- Replace *protocol* with the protocol (tcp or udp). For most servers, such as HTTP or email, use **tcp**. For a complete list of permitted keywords and well-known port assignments, see “[Protocols and Applications](#)” in [Appendix D, “TCP/IP Reference Information.”](#)
- Replace *source_address* with the host or network address for those systems on the lower security level interface that must access the *destination_address*. Use **any** to let any host access the *destination_address*. If you specify a single host, precede the address with **host**; for example **host 192.168.1.2**. If you specify a network address, also specify a network mask; for example, **192.168.1.0 255.255.255.0**.

Use the **interface** keyword if the interface has a dynamically assigned IP address. Replace *if_name* with the name of the interface configured using the **nameif** command.

- Use an *operator* to match port numbers used by the source or destination. The permitted operators are as follows:
 - lt—less than
 - gt—greater than
 - eq—equal to
 - negq—not equal to
 - range—an inclusive range of values

- Use the first *port* parameter after an operator to identify the protocol port used by the source host that initiates the connection.
- Replace *destination_address* with the host or network global address that you specified with the **static** command statement. For a host address, precede the address with **host**; for networks, specify the network address and the appropriate network mask.
- Use the second *port* parameter after an operator to specify the protocol port used by the destination host. For example, to identify a web server, use **eq http** or **eq 80**. For an email server, use **eq smtp** or **eq 25**. For a complete list of permitted keywords and well-known port assignments, see “Ports” in [Appendix D, “TCP/IP Reference Information.”](#)

Two **access-list** command statement definitions are required to permit access to the following ports:

- DNS, Discard, Echo, Ident, NTP, RPC, SUNRPC, and Talk each require one definition for TCP and one for UDP.
- TACACS+ requires one definition for port 49 on TCP.

The format for the **access-group** command is as follows:

```
access-group ID in interface low_interface
```

Replace *ID* with the same identifier that you specified in the **access-list** command statement.

Replace *low_interface* with the lower security interface that you specified in the **static** command statement. This is the interface through which users will access the external (global) address.

The following example illustrates the three commands required to enable access to a web server with the external IP address 209.165.201.12:

```
static (inside, outside) 209.165.201.12 10.1.1.3 netmask 255.255.255.255 0 0
access-list acl_out permit tcp any host 209.165.201.12 eq www
access-group acl_out in interface outside
```

This example uses the same **static** command that was shown in the previous section.

Controlling Outbound Connectivity

By default, all connections initiated on a network with a higher security level are allowed out, and you configure any restrictions required. You can control outbound access by IP address and protocol port, or combine access control with user authentication, as described in “[Using Authentication and Authorization.](#)” If you are not enforcing restrictions on outbound network traffic, outbound access lists are not required.

An outbound access list lets you restrict hosts from starting outbound connections or lets you restrict hosts from accessing specific destination addresses or networks. Access lists work on a first-match basis, so for outbound access lists, you must permit first and then deny after.

For example, you could restrict some hosts from accessing web sites or permit others access. Define access restrictions with the **access-list** command, and use the **access-group** command to bind the **access-list** command statements to an interface.

When creating an outbound access list, the basic syntax for the **access-list** command statement is the same as shown earlier in “[Enabling Inbound Connections:](#)”

```
access-list ID {deny|permit} protocol source_address [operator port] destination_address
[operator port]
```

Use the **deny** parameter to restrict specific types of access. For example, to prevent hosts belonging to the 192.168.1.0 network on the inside interface from starting connections on the outside interface and to permit all others, specify the 192.168.1.0 network address as the source address and the network connected to the outside interface as the destination address. In the example that follows, the network on the outside interface is 209.165.201.0. The **access-list** and **access-group** command statements are as follows.

```
access-list acl_in deny tcp 192.168.1.0 255.255.255.224 209.165.201.0 255.255.255.224
access-list acl_in permit ip any any
access-group acl_in in interface inside
```

You can also use access lists to prevent access to a specific server. For example, if you want to restrict hosts on the inside interface from accessing a website at address 209.165.201.29 on the outside interface, use the following commands.

```
access-list acl_in deny tcp any host 209.165.201.29 eq www
access-list acl_in permit ip any any
access-group acl_in in interface inside
```

These commands let any hosts start connections, but not to 209.165.201.29. The **access-group** command specifies that the hosts are on the inside interface.

**Note**

You can use URL filtering for greater control of outbound access to web sites, as described in the “[Filtering URLs with Internet Filtering Servers](#)” section on page 3-32.”

Using the Static Command for Port Redirection

This section describes the port redirection feature, introduced in PIX Firewall Version 6.0. It includes the following topics:

- [Overview, page 3-5](#)
- [Port Redirection Configuration, page 3-6](#)
- [Port Redirection Example, page 3-7](#)

Overview

Port redirection allows hosts on a lower security interface to connect to a particular IP address and port and to have the PIX Firewall redirect the traffic to the appropriate server on a higher security interface.

The shared address can be a unique address, a shared outbound PAT address, or an address shared with the external interface. To implement port redirection, use the following command.

```
static [(internal_if_name, external_if_name)] {tcp|udp} {global_ip|interface} global_port
local_ip local_port [netmask mask]
```

For an explanation of this command syntax, refer to the *Cisco PIX Firewall Command Reference*.

Port Redirection Configuration

Figure 3-1 illustrates a typical network scenario in which the port redirection feature might be useful.

Figure 3-1 Port Redirection Using the Static Command

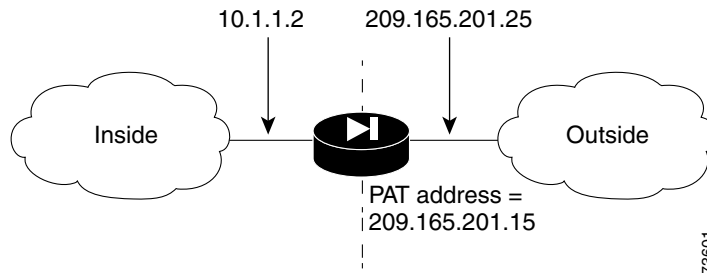

In the configuration described in this section, port redirection occurs for hosts on external networks as follows:

- Telnet requests to unique IP address 209.165.201.5 are redirected to 10.1.1.6
- FTP requests to unique IP address 209.165.201.5 are redirected to 10.1.1.3
- Telnet requests to PAT address 209.165.201.15 are redirected to 10.1.1.4
- Telnet requests to the PIX Firewall outside IP address 209.165.201.25 are redirected to 10.1.1.5
- HTTP request to PIX Firewall outside IP address 209.165.201.25 are redirected to 10.1.1.5
- HTTP port 8080 requests to PAT address 209.165.201.15 are redirected to 10.1.1.7 port 80

To implement this scenario, complete the following steps:

-
- Step 1** Configure application inspection of FTP requests on port 21 by entering the following command:
- ```
fixup protocol ftp 21
```
- Step 2** Configure the IP address of the lower and higher security interfaces of your PIX Firewall by entering the following command:
- ```
ip address outside 209.165.201.25 255.255.255.0
ip address inside 10.1.1.2 255.255.255.0
```
- Step 3** Identify a global PAT address for the lower security interface by entering the following command:
- ```
global (outside) 1 209.165.201.15
```
- Step 4** Configure NAT and PAT by entering the following command:
- ```
nat (inside) 1 0.0.0.0 0.0.0.0 0 0
```
- Step 5** Redirect Telnet requests for 209.165.201.5:
- ```
static (inside,outside) tcp 209.165.201.5 telnet 10.1.1.6 telnet netmask 255.255.255.255 0
0
```

This command causes Telnet requests to be redirected to 10.1.1.6.

**Step 6** Redirect FTP requests for IP address 209.165.201.5:

```
static (inside,outside) tcp 209.165.201.5 ftp 10.1.1.3 ftp netmask 255.255.255.255 0 0
```

This command causes FTP requests to be redirected to 10.1.1.3.

**Step 7** Redirect Telnet requests for PAT address 209.165.201.15:

```
static (inside,outside) tcp 209.165.201.15 telnet 10.1.1.4 telnet netmask 255.255.255.255 0 0
```

This command causes Telnet requests to be redirected to 10.1.1.4.

**Step 8** Redirect Telnet requests for the PIX Firewall outside interface address:

```
static (inside,outside) tcp interface telnet 10.1.1.5 telnet netmask 255.255.255.255 0 0
```

This command causes Telnet requests to be redirected to 10.1.1.5.

**Step 9** Redirect HTTP requests for the PIX Firewall outside interface address:

```
static (inside,outside) tcp interface www 10.1.1.5 www netmask 255.255.255.255 0 0
```

This command causes HTTP request to be redirected to 10.1.1.5.

**Step 10** Redirect HTTP requests on port 8080 for PAT address 209.165.201.15:

```
static (inside,outside) tcp 209.165.201.15 8080 10.1.1.7 www netmask 255.255.255.255 0 0
```

This command causes HTTP port 8080 requests to be redirected to 10.1.1.7 port 80.

## Port Redirection Example

[Example 3-1](#) illustrates the configuration required to implement the port redirection described in this scenario.

### **Example 3-1** Port Redirection with the static Command

```
fixup protocol ftp 21
ip address outside 209.165.201.25 255.255.255.0
ip address inside 10.1.1.2 255.255.255.0
global (outside) 1 209.165.201.15
nat (inside) 1 0.0.0.0 0.0.0.0 0 0
static (inside,outside) tcp 209.165.201.5 telnet 10.1.1.6 telnet netmask 255.255.255.255 0 0
static (inside,outside) tcp 209.165.201.5 ftp 10.1.1.3 ftp netmask 255.255.255.255 0 0
static (inside,outside) tcp 209.165.201.15 telnet 10.1.1.4 telnet netmask 255.255.255.255 0 0
static (inside,outside) tcp interface telnet 10.1.1.5 telnet netmask 255.255.255.255 0 0
static (inside,outside) tcp interface www 10.1.1.5 www netmask 255.255.255.255 0 0
static (inside,outside) tcp 209.165.201.15 8080 10.1.1.7 www netmask 255.255.255.255 0 0
```

# Using Authentication and Authorization

You can use access lists to control traffic based on IP address and protocol, but to control access and use for specific users or groups, you must use authentication and authorization. Authentication, which is the process of identifying users, is supported by the PIX Firewall for RADIUS and TACACS+ servers. Authorization identifies the specific permissions for a given user.

If you want to apply authentication and authorization when an internal (local) host initiates a connection to an external (lower security) network, enable it on the internal (higher security) interface. To set up authentication and authorization to occur when an external host initiates a connection to an internal host, enable it on the outside interface.

**Note**

If you want a host on an outside (lower security level) interface to initiate connections with a host on an internal (higher security level) interface, create **static** and **access-list** command statements for the connection.

This section includes the following topics:

- [Configuring AAA, page 3-8](#)
- [Enabling Secure Authentication of Web Clients, page 3-10](#)
- [Configuring RADIUS Authorization, page 3-12](#)
- [Using MAC-Based AAA Exemption, page 3-13](#)

## Configuring AAA

To enable authentication and authorization, you must complete the following:

- Identify the IP address of the authentication server that you will use and determine a server encryption key to be shared by the authentication server and the PIX Firewall.
- Configure the authentication server with the users that can access the network, the services that they can use, and the hosts that they can access.
- Configure the PIX Firewall to either enable or disable authentication or authorization.

In addition, you can configure the PIX Firewall to control user access to specific hosts or services. However, it is easier to maintain this kind of access control in a single location, at the authentication server. After you enable authentication and authorization, the PIX Firewall prompts users of FTP, Telnet, or HTTP (Web) access. Controlling access to a specific system or service is handled by the authentication and authorization server.

**Note**

When using PIX Firewall Version 6.3 or higher, you can enable authentication with a user database that you configure locally on your PIX Firewall. The configuration steps are similar to those for configuring a RADIUS/TACACS+ server. The differences are noted within each step in the following procedure. For information about configuring the PIX Firewall local user database, refer to “[User Authentication](#)” in [Chapter 3, “Controlling Network Access and Use.”](#)

Follow these steps to enable the PIX Firewall to support user authentication and authorization:

- Step 1** For inbound authentication, create the **static** and **access-list** command statements required to permit outside hosts to access servers on the inside network.
- Step 2** If the internal network connects to the Internet, create a global address pool of registered IP addresses. Then specify the inside hosts that can start outbound connections with the **nat** command using the **access-list** command.
- Step 3** Identify the server that handles authentication or authorization using the **aaa-server** command. Create a unique server group name.

For example:

```
aaa-server AuthInbound protocol tacacs+
aaa-server AuthInbound (inside) host 10.1.1.1 TheUauthKey
aaa-server AuthOutbound protocol tacacs+
aaa-server AuthOutbound (inside) host 10.1.1.2 TheUauthKey
```



**Note** This step is not required when using the LOCAL database for authentication.

The first command statement creates the AuthInbound authentication group using TACACS+ authentication. The second command statement states that the AuthInbound server is on the inside interface, that its IP address is 10.1.1.1, and the encryption key is “TheUauthKey.”

The third command statement creates the AuthOutbound authentication group using TACACS+ authentication. The fourth command statement states that the AuthOutbound server is on the inside interface, that its IP address is 10.1.1.2, and the encryption key is “TheUauthKey.”



**Note** RADIUS authorization is provided with the **access-list** command statement as described in [“Configuring RADIUS Authorization.”](#)

- Step 4** Enable authentication with the **aaa authentication** command:

```
aaa authentication include authen_service if_name 0 0 0 0 <server_tag|LOCAL>
```

Replace *authen\_service* with an identifier that specifies the traffic to be included, such as **ftp**, **telnet**, **http** or **https**. For details about this option, refer to the **aaa authentication** command in the *Cisco PIX Firewall Command Reference*.

Replace *if\_name* with the name of the interface on which you are enabling authentication, as configured with the **nameif** command. To use the LOCAL database for authentication use the LOCAL keyword. To use a AAA server, replace *server\_tag* with the AAA server group name defined with the **aaa-server** command. For example:

```
aaa authentication include ftp outside 0 0 0 0 AuthOutbound
aaa authentication include telnet outside 0 0 0 0 AuthOutbound
aaa authentication include http outside 0 0 0 0 AuthOutbound
aaa authentication include ftp inside 0 0 0 0 AuthInbound
aaa authentication include telnet inside 0 0 0 0 AuthInbound
aaa authentication include http inside 0 0 0 0 AuthInbound
```



**Note** Be careful to apply authentication only to protocols that can be authenticated. Applying authentication using the **any** keyword will prevent protocols such as SMTP from passing through the PIX Firewall.

- Step 5** Enable authorization with the **aaa authorization** command. PIX Firewall checks the authorization request with the AAA server, which makes the decision about what services a user can access.

```
aaa authorization include authen_service if_name 0 0 0 0
```

Replace *authen\_service* with an identifier that specifies the traffic to be included, such as **ftp**, **telnet**, or **http**.



**Note** This step is not required when using the LOCAL database for authentication.

For example:

```
aaa authorization include ftp outside 0 0 0 0
aaa authorization include telnet outside 0 0 0 0
aaa authorization include http outside 0 0 0 0
aaa authorization include ftp inside 0 0 0 0
aaa authorization include telnet inside 0 0 0 0
aaa authorization include http inside 0 0 0 0
```

For further information about the different options available for the **authorization** and **authentication** parameters, refer to the *Cisco PIX Firewall Command Reference*.

## Enabling Secure Authentication of Web Clients

PIX Firewall Version 6.3 introduces a secured method of exchanging usernames and passwords between a web client and a PIX Firewall by using HTTP over SSL (HTTPS). HTTPS encrypts the user name and password and makes the transmission secure.

Previous versions of PIX Firewall, when authenticating a web browser using a AAA server, obtained the user name and password from the HTTP client in clear text.

Add the following keyword to the **aaa** command to enable this feature:

```
aaa authentication secure-http-client
```

The keyword **secure-http-client** enables this feature so that username and password are exchanged securely between HTTP clients and the PIX Firewall.

To enable this feature, you must configure AAA authentication, using one of the following formats:

```
aaa authentication http interface ...
aaa authentication tcp/0 interface ...
```

This feature supports authentication of clients accessing secure (HTTPS) web sites, by using the following command:

```
aaa authentication https interface ...
aaa authentication tcp/0 interface ...
```



**Note** Enabling AAA authentication **secure-http-client** is not required to authenticate HTTPS sessions.

After enabling this feature, when a user accesses a web page requiring authentication, the PIX Firewall displays the Authentication dialog box shown in [Figure 3-2](#).

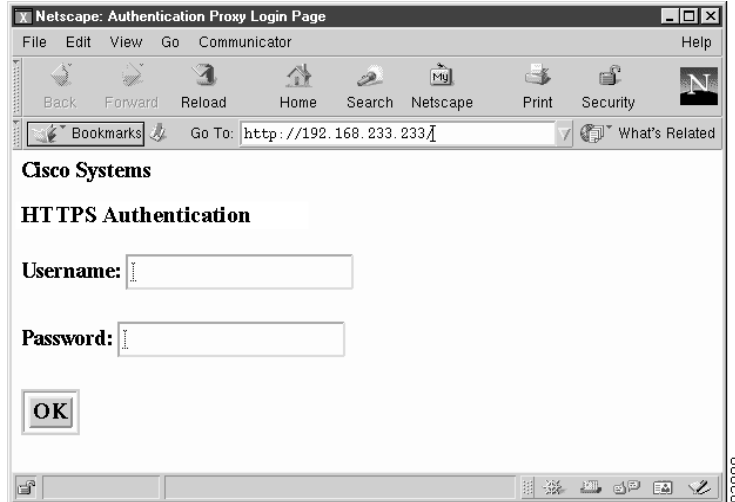

Figure 3-2 Secure Authentication Page

**Note**

The Cisco Systems text field shown in this example was customized using the **auth-prompt** command. For the detailed syntax of this command refer to the *Cisco PIX Firewall Command Reference*. If you do not enter a string using the **auth-prompt** command, this field will be blank.

After the user enters a valid username and password, an “Authentication Successful” page appears and closes automatically. If the user fails to enter a valid username and password, an “Authentication Failed” page appears.

A maximum of 16 concurrent HTTPS authentications are allowed. If all 16 HTTPS authentication processes are running, a new connection requiring authentication will not succeed. An authentication process starts when the PIX Firewall receives the user name and password from the browser and ends when it receives the authentication result from the AAA server. The length of time required to complete each authentication process depends on the response time from the authentication source. If the LOCAL database is used, it is very fast, while if a RADIUS or TACACS+ server is used, it will depend on the server response time.

**Note**

Pre-PIX 6.3 configurations that include AAA authentication include tcp/0.. will inherit the HTTPS Authentication Proxy feature enabled with a code upgrade to PIX 6.3 or later.

When using the **uauth timeout 0** command, HTTPS authentication will not work if a browser initiates multiple TCP connections to get a web page after HTTPS authentication. In this scenario, the first connection is allowed, but the subsequent connections will trigger authentication because the uauth timeout is set to 0. As a result, users will be presented authentication pages continuously even though the correct username and password are entered each time. You can avoid this problem by setting the uauth timeout to 1 second. However, this opens a 1-second window that could conceivably allow a non-authenticated user to obtain access from the same source IP address.

If a web browser launches an HTTPS web page request while secure authentication is in process for a previous HTTP request, the HTTPS request triggers a second secure authentication process, even if secure authentication is not specifically enabled for HTTPS. Once the authentication process for either web page is completed successful, the remaining request can be completed by reloading the page.

Because HTTPS authentication occurs on the SSL port 443, do not use the **access-list** command to block traffic from the HTTP client to HTTP server on port 443. Also, if you configure static PAT for web traffic on port 80, you must also configure a static entry for SSL port 443.

## Configuring RADIUS Authorization

PIX Firewall allows a RADIUS server to send user group attributes to the PIX Firewall in the RADIUS authentication response message.

The administrator first defines access lists on the PIX Firewall for each user group. For example, there could be access lists for each department in an organization, sales, marketing, engineering, and so on. The administrator then lists the access list in the group profile in the Cisco version of RADIUS, called CiscoSecure.

The PIX Firewall requests authentication of the user by the RADIUS server. If the user is authorized, the RADIUS server returns a confirming authorization response message to the PIX Firewall with vendor specific attribute 11 (filter-id) set to the access list for the given user's group. RADIUS attribute 11 cannot be used to pass this information.

To maintain consistency, PIX Firewall also provides the same functionality for TACACS+.



### Note

Access lists can be used with either RADIUS or TACACS but authorizing FTP, HTTP, or Telnet is only possible with TACACS+.

To restrict users in a department to three servers and deny everything else, the **access-list** command statements are as follows:

```
access-list eng permit ip any server1 255.255.255.255
access-list eng permit ip any server2 255.255.255.255
access-list eng permit ip any server3 255.255.255.255
access-list eng deny ip any any
```

In this example, the vendor-specific attribute string in the CiscoSecure configuration has been set to **acl=eng**. Use this field in the CiscoSecure configuration to identify the access list identification name. The PIX Firewall gets the **acl=acl\_ID** string from CiscoSecure, extracts the ACL identifier and puts it in the user's uauth entry.

When a user tries to open a connection, PIX Firewall checks the access list in the user's uauth entry, and depending on the permit or deny status of the access list match, permits or denies the connection. When a connection is denied, PIX Firewall generates a corresponding syslog message. If there is no match, then the implicit rule is to deny.

Because the source IP of a given user can vary depending on where they are logging in from, set the source address in the **access-list** command statement to **any**, and the destination address to identify the network services to which user is permitted or denied access.



### Note

The **aaa authorization** command does not require a separate RADIUS option.

## Using MAC-Based AAA Exemption

PIX Firewall Versions 6.3 and higher let you use Media Access Control (MAC) addresses to bypass authentication for devices, such as Cisco IP Phones, that do not support AAA authentication. To use this feature, you identify the MAC addresses on the inside (higher security) interface. The PIX Firewall bypasses the AAA server for traffic that matches using both the MAC address and the IP address that has been dynamically assigned to the MAC address. Authorization services are automatically disabled when you bypass authentication. Accounting records are still generated (if enabled), but the username is not displayed.

To enable MAC-based AAA exemption, create a list of MAC addresses to be exempted from AAA authentication and then assign the list to a AAA server.

**Note**

---

This feature cannot be applied on the outside or lower security level interface.

---

To define a list of MAC addresses, enter the following command:

```
mac-list mcl-id deny | permit mac mac-mask
```

Enter this command as many times as necessary to define all the MAC addresses you want to add to the list.

Replace *mcl-id* with the identifier of the MAC list. Use the **permit** option to identify the MAC addresses to be exempted from authentication. Use the **deny** option to prevent the bypassing of authentication.

Replace *mac* with a partial MAC address that can be used to select a group of devices based on a common portion of the hardware address, such as the vendor ID. Replace *mac-mask* with a mask that identifies the portion of the MAC address that should be used for matching.

For example, the following entry would bypass authentication for a single MAC address:

```
mypix(config)# mac-list adc permit 00a0.c95d.0282 ffff.ffff.ffff
```

In this example, the mask FFFF.FFFF.FFFF instructs the PIX Firewall to match all 12 digits (six bytes) in the preceding hexadecimal address.

The following entry would bypass authentication for all Cisco IP Phones, which have the hardware ID 0003.E3:

```
mypix(config)# mac-list adc permit 0003.E300.0000 FFFF.FF00.0000
```

To apply the MAC list to the AAA server, enter the following command:

```
aaa mac-exempt match mcl-id
```

Replace *mcl-id* with the identifier for the MAC list that you want to apply.

For example, the following command applies the MAC-list *adc* to the AAA server.

```
aaa mac-exempt match adc
```

To view the current entries in a specific MAC list, enter the following command:

```
show mac-list [mcl-id]
```

If you omit the MAC list identifier, the system displays all currently configured MAC lists.

To clear all the entries on a MAC list, enter the following command:

```
clear mac-list [mclid]
```

If you omit the MAC list identifier, the system clears all the currently configured MAC lists.

## Access Control Configuration Example

This section provides an example of how to implement access control and includes the following topics:

- [Basic Configuration, page 3-14](#)
- [Authentication and Authorization, page 3-16](#)
- [Managing Access to Services, page 3-16](#)
- [Adding Comments to ACLs, page 3-18](#)

### Basic Configuration

Figure 3-3 illustrates the network configuration used in this example.

**Figure 3-3 Two Interfaces with NAT—Access Control**

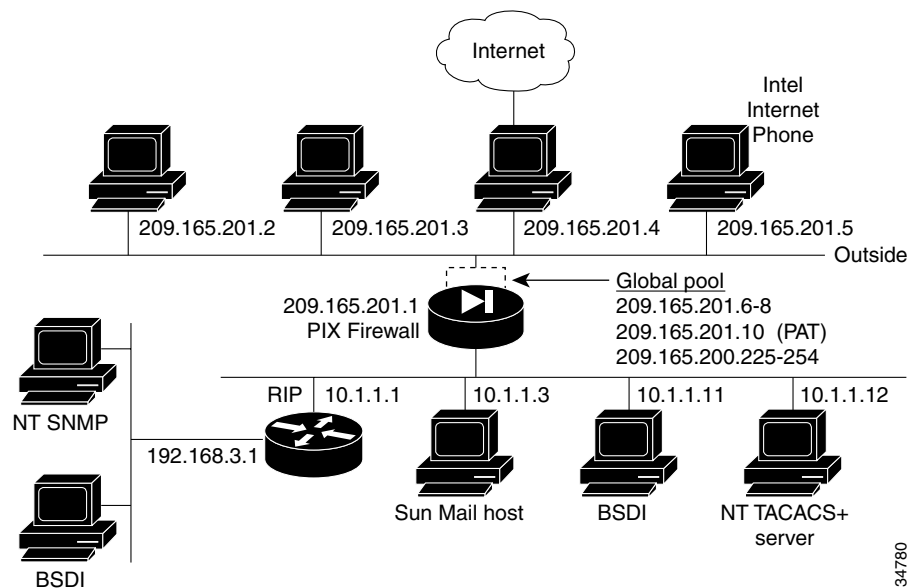

34780

The following procedure shows the basic configuration required for this example. This procedure is similar to the configuration shown in “Basic Configuration Examples:” in Chapter 2, “Establishing Connectivity”:

**Step 1** Identify the security level and names of each interface by entering the following commands:

```
nameif ethernet0 outside security0
nameif ethernet1 inside security100
```

**Step 2** Identify the line speed of each interface by entering the following commands:

```
interface ethernet0 100basex
interface ethernet1 100basex
```

You may get better performance by changing the default **auto** option in the **interface** command to the specific line speed for the interface card.

**Step 3** Identify the IP addresses for each interface:

```
ip address inside 10.1.1.1 255.255.255.0
ip address outside 209.165.201.1 255.255.255.224
```

**Step 4** Specify the host name for the PIX Firewall:

```
hostname pixfirewall
```

This name appears in the command-line prompt.

**Step 5** Let inside IP addresses be recognized on the outside network and let inside users start outbound connections:

```
nat (inside) 1 0.0.0.0 0.0.0.0
nat (inside) 2 192.168.3.0 255.255.255.0
global (outside) 1 209.165.201.6-209.165.201.8 netmask 255.255.255.224
global (outside) 1 209.165.201.10 netmask 255.255.255.224
global (outside) 2 209.165.200.225-209.165.200.254 netmask 255.255.255.224
```

**Step 6** Set the outside default route to the router attached to the Internet:

```
route outside 0 0 209.165.201.4 1
```

**Example 3-2** shows the basic configuration required to implement a PIX Firewall with two interfaces with NAT.

### **Example 3-2 Two Interfaces with NAT—Basic Configuration**

```
nameif ethernet0 outside security0
nameif ethernet1 inside security100
interface ethernet0 100basex
interface ethernet1 100basex
ip address inside 10.1.1.1 255.255.255.0
ip address outside 209.165.201.1 255.255.255.224
hostname pixfirewall
nat (inside) 1 0.0.0.0 0.0.0.0
nat (inside) 2 192.168.3.0 255.255.255.0
global (outside) 1 209.165.201.6-209.165.201.8 netmask 255.255.255.224
global (outside) 1 209.165.201.10 netmask 255.255.255.224
global (outside) 2 209.165.200.225-209.165.200.254 netmask 255.255.255.224
route outside 0 0 209.165.201.4 1
```

## Authentication and Authorization

This section describes how to implement authentication and authorization for traffic through the PIX Firewall, using a TACACS+ server. The commands used for this purpose are in addition to the basic firewall configuration required, which is described in the previous section, “[Basic Configuration](#).”

The **aaa-server** command specifies the IP address of the TACACS+ authentication server. The **aaa authentication** command statement specifies that users on network 192.168.3.0 starting FTP, HTTP, and Web connections from the inside interface be prompted for their usernames and passwords before being permitted to access the servers on other interfaces. The **aaa authorization** command statement lets the users on 192.168.3.0 access FTP, HTTP, or Telnet, and any TCP connections to anywhere as authorized by the AAA server. Even though it appears that the **aaa** commands let the PIX Firewall set security policy, the authentication server actually does the work to decide which users are authenticated and what services they can access when authentication is permitted.

[Example 3-3](#) shows the command listing for configuring access to services for the network illustrated in [Figure 3-3](#).

### Example 3-3 Authentication and Authorization Commands

```
aaa-server TACACS+ (inside) host 10.1.1.12 1q2w3e
aaa authentication include ftp inside 192.168.3.0 255.255.255.0 0 0 TACACS+
aaa authorization include ftp inside 192.168.3.0 255.255.255.0 0 0
aaa authentication include http inside 192.168.3.0 255.255.255.0 0 0 TACACS+
aaa authorization include http inside 192.168.3.0 255.255.255.0 0 0
aaa authentication include telnet inside 192.168.3.0 255.255.255.0 0 0 TACACS+
aaa authorization include telnet inside 192.168.3.0 255.255.255.0 0 0
```

## Managing Access to Services



### Note

The commands in this section are used in addition to the basic firewall configuration required, which is described in the previous section, “[Basic Configuration](#).”

The following procedure shows the commands required to manage user access to H.323 and Web services:

### Step 1 Create outbound access lists to determine which hosts can access services:

```
access-list acl_in deny tcp host 192.168.3.3 any eq 1720
access-list acl_in permit tcp host 192.168.3.3 any eq 80
access-list acl_in permit tcp host 10.1.1.11 any eq 80
access-list acl_in deny tcp any any eq 80
```

The first **access-list** command statement denies host 192.168.3.3 from accessing H.323 (port 1720) services such as MS NetMeeting or Intel Internet Phone. The next command statement permits host 192.168.3.3 to use the Web. The third **access-list** command statement permits host 10.1.1.11 access to the Web (at port 80). The last command statement denies all other hosts from accessing the Web (port 80).

- Step 2** Specify that the **access-list** group regulates the activities of inside hosts starting outbound connections:
- ```
access-group acl_in in interface inside
```



Note For information about logging activity associated with specific ACLs, see “[Logging Access Control List Activity](#)” in Chapter 9, “[Accessing and Monitoring PIX Firewall](#).”

- Step 3** Create static address mappings:

```
static (inside, outside) 209.165.201.16 192.168.3.16 netmask 255.255.255.240
```

This example maps IP addresses 209.165.201.17 through 209.165.201.30 to 192.168.3.17 through 192.168.3.30.

- Step 4** Enable VoIP access:

```
access-list acl_out permit tcp any 209.165.201.16 255.255.255.240 eq h323
```

This command lets users on the Internet send Intel Internet Phone requests to users on the protected network. A request can be sent to any IP address in the range from 209.165.201.16 through 209.165.201.31 and the PIX Firewall will translate this address to the next available IP address in the range from 192.168.3.16 through 192.168.3.31.

- Step 5** Establish an externally visible IP address for Web access:

```
static (inside, outside) 209.165.201.11 10.1.1.11
access-list acl_out permit tcp any host 209.165.201.11 eq 80
```

The **static** command statement with the **access-list** command statement establishes an externally visible IP address for Web access (port 80 in the **access-list** command statement).

[Example 3-4](#) shows the command listing for configuring access to services for the network illustrated in [Figure 3-3](#).

Example 3-4 *Configuring Access to Services*

```
access-list acl_in deny tcp host 192.168.3.3 any eq 1720
access-list acl_in permit tcp host 192.168.3.3 any eq 80
access-list acl_in permit tcp host 10.1.1.11 any eq 80
access-list acl_in deny tcp any any eq 80
access-group acl_in in interface inside
access-list acl_out permit tcp any 209.165.201.16 255.255.255.240 eq h323
static (inside, outside) 209.165.201.11 10.1.1.11
access-list acl_out permit tcp any host 209.165.201.11 eq 80
```

Adding Comments to ACLs

PIX Firewall Version 6.3 and higher lets you include comments about entries in any ACL. The remarks make the ACL easier to understand and scan. A remark can be up to 100 characters and can precede or follow an **access-list** command. However, for clarity, comments should be placed consistently within an access list. There is no run-time performance impact because remarks are stored within an access control entry (ACE) data structure.

Following is the command syntax to specify a comment:

```
access-list acl_id remark text
```

Replace *acl_id* with the ACL identifier and *text* with up to 100 characters of text. If more than 100 characters are entered, it is truncated. The starting position of the text is 1 after the **remark** keyword and leading spaces are allowed. Trailing spaces are ignored.

To remove a remark, precede the command with **no**; trailing spaces in the command line do not affect the matching result.

To allow you to add ACL remarks at the top of an ACL, you can now create an “empty” ACL, containing remarks without any access control entries. When all remarks are removed from this type of ACL, the ACL is also removed.

Using TurboACL

This section describes how to use the TurboACL feature introduced with PIX Firewall Version 6.2. It includes the following topics:

- [Overview, page 3-18](#)
- [Globally Configuring TurboACL, page 3-19](#)
- [Configuring Individual TurboACLs, page 3-19](#)
- [Viewing TurboACL Configuration, page 3-20](#)

Overview

An access list typically consists of multiple access list entries, organized internally by PIX Firewall as a linked list. When a packet is subjected to access list control, the PIX Firewall searches this linked list linearly to find a matching element. The matching element is then examined to determine if the packet is to be transmitted or dropped. With a linear search, the average search time increases proportional to the size of the list.

TurboACL is a feature introduced with PIX Firewall Version 6.2 that improves the average search time for access control lists containing a large number of entries. The TurboACL feature causes the PIX Firewall to compile tables for ACLs and this improves searching of long ACLs.

You can enable this feature for the entire PIX Firewall and then disable it for specific ACLs, or enable it only for specific ACLs. For short ACLs, TurboACL does not improve performance. A TurboACL search, no matter how short the ACL, requires about the same amount of time as a regular ACL search of from twelve to eighteen entries. For this reason, even when enabled, the TurboACL feature is only applied to ACLs with nineteen or more entries.

**Note**

When you add or delete an element from a turbo-enabled ACL the internal data tables associated with the ACL are regenerated, which produces an appreciable load on the PIX Firewall CPU.

The TurboACL feature requires significant amounts of memory and is most appropriate for high-end PIX Firewall models, such as the PIX 525 or PIX 535. The minimum memory required for TurboACL is 2.1 MB and approximately 1 MB of memory is required for every 2000 ACL elements. The actual amount of memory required depends not only on the number of ACL elements but also on the complexity of the entries.

**Note**

With PIX Firewall models having limited memory, such as the PIX 501, implementing the TurboACL feature may cause problems, such as not being able to load Cisco PIX Device Manager (PDM). If memory problems occur after enabling TurboACL, disable it using the **no access-list compiled** command.

Globally Configuring TurboACL

The syntax for enabling TurboACL for the entire PIX Firewall is as follows:

```
access-list compiled
```

This configures TurboACL on all ACLs having 19 or more entries. This command causes the TurboACL process to scan through all existing ACLs. During the scan, it marks and turbo-compiles any ACL which has 19 or more access control entries (ACEs) and has not yet been turbo-compiled.

The command **no access-list compiled**, which is the default, causes the TurboACL process to scan through all compiled ACLs and mark every one as non-turbo. It also deletes all existing TurboACL structures.

When the PIX Firewall is running, the command **access-list compiled** marks every ACL to be turbo-configured, and the command **no access-list compiled** marks every ACL as non-turbo.

Configuring Individual TurboACLs

The individual TurboACL command can be used to enable individual turbo configuration for individual ACLs when TurboACL is not globally enabled. Also, after globally configuring TurboACL, you can disable the turbo-compiled feature for individual ACLs by using the individual TurboACL command. The syntax of this command is as follows.

```
access-list acl_name compiled
```

This command is used to individually enable or disable TurboACL on a specific ACL. The *acl_name* must specify an existing ACL. This command will cause the TurboACL process to mark the ACL specified by *acl_name* to be turbo-compiled if the ACL has 19 or more ACEs and has not yet been turbo-compiled.

If you enter the **no** form of the command, the TurboACL process deletes the TurboACL structures associated with the ACL and marks the ACL as non-turbo.

Viewing TurboACL Configuration

The **show access-list** command displays the memory usage of each individually turbo-compiled ACL and the shared memory usage for all the turbo-compiled ACLs. If no ACL is turbo-compiled, no turbo-statistic is displayed. This command also shows the number of ACEs in an ACL and whether an ACL is configured with TurboACL. Note that an ACL may be configured for turbo but it will not be compiled unless the number of ACEs exceeds the threshold. In such a case, this command will show that the ACL is turbo-configured, but there will not be any entry for the ACL in the TurboACL statistic output.

[Example 3-5](#) provides sample output from the **show access-list** command:

Example 3-5 TurboACL Statistics

```

pix# show access-list
TurboACL statistics:
ACL                State           Memory (KB)
-----
acl_foo            Operational    5
Acl_bar            Operational    2
Shared memory usage: 2046 KB
access-list compiled
access-list acl_foo turbo-configured; 19 elements
access-list acl_foo permit tcp any host 10.0.0.252 (hitcnt=0)
access-list acl_foo permit tcp any host 10.0.0.255 (hitcnt=0)
access-list acl_foo permit tcp any host 10.0.0.253 (hitcnt=0)
access-list acl_foo permit tcp 10.1.0.0 255.0.0.0 host 10.0.0.254 eq telnet (hitcnt=2)
access-list acl_foo permit tcp 10.1.0.0 255.0.0.0 host 10.0.0.254 eq 1 (hitcnt=0)

```

Downloading Access Lists

PIX Firewall supports per-user access list authorization, by which a user is authorized to do only what is permitted in the user's individual access list entries. This section describes how to implement this feature and includes the following topics:

- [Configuring Downloadable ACLs, page 3-20](#)
- [Downloading a Named Access List, page 3-21](#)
- [Downloading an Access List Without a Name, page 3-22](#)
- [Software Restrictions, page 3-23](#)

Configuring Downloadable ACLs

This feature lets you configure per-user access lists on a AAA server and then download the access list to a PIX Firewall during user authentication.

Beginning with PIX Firewall Version 6.2, these access lists can be downloaded from a AAA server and do not need to be configured separately on the PIX Firewall. This feature improves scalability when using access lists for individual users.



Note

Downloadable ACLs are only supported with RADIUS servers and not with TACACS+ servers.

The following are the two methods for downloading an access list from a AAA server to the PIX Firewall:

- Downloading a named access list—Configure a user (real) authentication profile to include a Shared Profile Component (SPC) and then configure the SPC to include the access list name and the actual access list. This method should be used when there are frequent requests for downloading a large access list.
- Downloading an access list without a name—Configure a user authentication profile on a AAA server to include the PIX Firewall access list to be downloaded. This method should be used when there are no frequent requests for the same access list.

Downloading a Named Access List

To download a named access list during a user authentication, the following procedure must be performed on Cisco Secure ACS 3.0 or higher:

-
- Step 1** Select **Downloadable PIX ACLs** from the Shared Profile Component (SPC) menu item.
- Step 2** Click **Add** to add an ACL definition and enter the name, description, and the actual definitions for the ACL.

The ACL definition consists of one or more PIX Firewall **access-list** commands with each command on a separate line. Each command must be entered without the **access-list** keyword and the name for the access list because they are not needed. The rest of the command line must conform to the syntax and semantics rules of the PIX Firewall **access-list** command. A PIX Firewall Syslog message will be logged if there is an error in a downloaded **access-list** command.

The following is an example of an ACL definition before it is downloaded to the PIX Firewall:

```
+-----+
| Shared profile Components
|
|   Downloadable PIX ACLs
|
| Name:          acs_ten_acl
| Description:   10 PIX access-list commands
|
|
|   ACL Definitions
|
| permit tcp any host 10.0.0.254
| permit udp any host 10.0.0.254
| permit icmp any host 10.0.0.254
| permit tcp any host 10.0.0.253
| permit udp any host 10.0.0.253
| permit icmp any host 10.0.0.253
| permit tcp any host 10.0.0.252
| permit udp any host 10.0.0.252
| permit icmp any host 10.0.0.252
| permit ip any any
+-----+
```

- Step 3** Configure a Cisco Secure ACS user or a group through **User Setup** or **Group Setup** to include the defined ACL in the user or group settings.

Once the configuration is properly configured, a user authentication request will first cause the access list name to be sent to the PIX Firewall. The PIX Firewall will determine if the named ACL already exists and if not, the PIX Firewall will request the ACL to be downloaded. A named ACL is not downloaded again as long as it exists on the PIX Firewall.

If the download is successful, the ACL on the PIX Firewall will have the following name:

```
#ACSACL#-acl_name-12345678
```

Where *acl_name* is the name for the access list defined in the SPC and 12345678 is a unique version ID. If the named access list is not configured on ACS or the download fails for any other reason, a Syslog message will be logged.

After the ACL definition has been downloaded to the PIX Firewall, it looks like the following:

```
access-list #ACSACL#-PIX-acs_ten_acl-3b5385f7 permit tcp any host 10.0.0.254
access-list #ACSACL#-PIX-acs_ten_acl-3b5385f7 permit udp any host 10.0.0.254
access-list #ACSACL#-PIX-acs_ten_acl-3b5385f7 permit icmp any host 10.0.0.254
access-list #ACSACL#-PIX-acs_ten_acl-3b5385f7 permit tcp any host 10.0.0.253
access-list #ACSACL#-PIX-acs_ten_acl-3b5385f7 permit udp any host 10.0.0.253
access-list #ACSACL#-PIX-acs_ten_acl-3b5385f7 permit icmp any host 10.0.0.253
access-list #ACSACL#-PIX-acs_ten_acl-3b5385f7 permit tcp any host 10.0.0.252
access-list #ACSACL#-PIX-acs_ten_acl-3b5385f7 permit udp any host 10.0.0.252
access-list #ACSACL#-PIX-acs_ten_acl-3b5385f7 permit icmp any host 10.0.0.252
access-list #ACSACL#-PIX-acs_ten_acl-3b5385f7 permit ip any any
```

- Step 4** Activate the use of downloadable ACLs by performing the following steps:
- Click **Interface Configuration** on the **Cisco Secure ACS** main menu.
 - Click **Advanced Options** on the **Interface Configuration** menu.
 - Select either or both of the following options:
 - User-Level Downloadable ACLs
 - Group-Level Downloadable ACLs

Downloading an Access List Without a Name

To download an access list without using a name during a user authentication, perform the following at a AAA RADIUS server:

Configure CISCO-specific VSA (Attribute 26) string of a user authentication profile in the following format:

```
ip:inacl#nnn=ACL_COMMAND
```

where:

- *ip:inacl#* is the string that specifies an input ACL.
- *nnn* is a number in the range from 0 to 999999999 that identifies the order of the **access-list** command statement to be configured on the PIX Firewall. If this parameter is omitted, the sequence value is 0.
- *ACL_COMMAND* represents one or more PIX Firewall **access-list** commands.

Statements are separated by colons (:). Statements should *not* include the **access-list** command or the access list name. You can configure multiple occurrences of the string “ip:inacl#*nnn*=” in the same user authentication profile to define a PIX Firewall access list. If multiple entries have the same sequence number, they will be configured in the same order as they appear in the Cisco-specific VSA attribute.

Multiple lines may be used to configure multiple elements, but an element must be completely contained on a single line. For example, the **permit tcp any any** command cannot be broken into two separate lines.

A downloadable ACL without a name is assigned a name by the PIX Firewall after it is downloaded in the following format:

```
AAA-user-username
```

Where *username* is the name of the user that is being authenticated.

If an **access-list** command statement has a syntax or semantics error, or if the **no access-list** command is used (an empty access list), Syslog messages will be generated. However, an error with a single **access-list** command does not abort the processing of the entire downloaded ACL.

Example 3-6 Example Configuration for a Downloadable Access List

The following configuration would be entered for the user Admin in the [009\001] cisco-av-pair field under **Group Setup>Cisco IOS/PIX RADIUS Attributes**:

```
ip:inacl#1=permit tcp 10.1.0.0 255.0.0.0 10.0.0.0 255.0.0.0
ip:inacl#99=deny tcp any any
ip:inacl#2=permit udp 10.1.0.0 255.0.0.0 10.0.0.0 255.0.0.0
ip:inacl#99=deny udp any any
ip:inacl#3=permit icmp 10.1.0.0 255.0.0.0 10.0.0.0 255.0.0.0
```

The resulting downloaded **access-list** commands on PIX Firewall are as follows:

```
access-list AAA-user-foo; 5 elements
access-list AAA-user-foo permit tcp 10.1.0.0 255.0.0.0 10.0.0.0 255.0.0.0
access-list AAA-user-foo permit udp 10.1.0.0 255.0.0.0 10.0.0.0 255.0.0.0
access-list AAA-user-foo permit icmp 10.1.0.0 255.0.0.0 10.0.0.0 255.0.0.0
access-list AAA-user-foo deny tcp any any
access-list AAA-user-foo deny udp any any
```

Software Restrictions

When downloading access lists via RADIUS, the following restrictions apply:

- RADIUS packet size is limited to 4096, but the actual size for the access list can vary considerably depending on the existence of other variable-length, RADIUS attributes.
- Each RADIUS attribute field used to specify access lists is limited to 253 bytes.



Note

If there exists any incompatibility between the PIX Firewall and the Cisco IOS access list, the incompatibility will also exist for the downloaded access list. In other words, an access list defined for PIX Firewall on a AAA server may not be valid if the access list is downloaded to Cisco IOS software, and vice versa.

Simplifying Access Control with Object Grouping

This section describes how to use object grouping, a feature introduced in PIX Firewall Version 6.2, for simplifying complex access control policies. It includes the following topics:

- [How Object Grouping Works, page 3-24](#)
- [Using Subcommand Mode, page 3-25](#)
- [Configuring and Using Object Groups with Access Control, page 3-26](#)
- [Configuring Protocol Object Groups, page 3-28](#)
- [Configuring Network Object Groups, page 3-28](#)
- [Configuring Service Object Groups, page 3-28](#)
- [Configuring ICMP-Type Object Groups, page 3-29](#)
- [Nesting Object Groups, page 3-29](#)
- [Displaying Configured Object Groups, page 3-30](#)
- [Removing Object Groups, page 3-30](#)

How Object Grouping Works

Object grouping provides a way to reduce the number of access rules required to describe complex security policies. An access rule can apply to the following types of objects:

- Client host—Makes HTTP, Telnet, FTP, Voice over IP, and other service requests
- Server host—Responds to service requests
- Service type—Services are assigned to well-known, dynamically assigned, or secondary channel TCP or UDP ports
- Subnet—The network address of internal or external subnetworks where server or client hosts are located
- ICMP types—Such as ECHO-REPLY

An access rule allows or denies traffic matching a specific combination of these objects. For example, an access rule might cause the PIX Firewall to allow a designated client to access a particular server host for a specific service. When there is only one client, one host, and one service, only one access rule is needed. However, as the number of clients, servers, and services increases, the number of rules required may increase exponentially.

Object grouping provides a way to group objects of a similar type into a group so that a single access rule can apply to all the objects in the group. For example, consider the following three object groups:

- MyServices—Includes the TCP/UDP port numbers of the service requests that are allowed access to the internal network
- TrustedHosts—Includes the host and network addresses allowed access to the greatest range of services and servers
- PublicServers—Includes the host addresses of servers to which the greatest access is provided

After creating these groups, you could use a single access rule to allow trusted hosts to make specific service requests to a group of public servers. Object groups can also contain other object groups or be contained by other object groups.

Object grouping dramatically compresses the number of access rules required to implement a particular security policy. For example, a customer policy that required 3300 access rules might only require 40 rules after hosts and services are properly grouped.

Using Subcommand Mode

The general syntax of the **object-group** command is as follows:

```
object-group object-type grp-id
```

Replace *object-type* with one of the following object types:

- **protocol**—Group of IP protocols. It can be one of the keywords **icmp**, **ip**, **tcp**, or **udp**, or an integer in the range 1 to 254 representing an IP protocol number. To match any Internet protocol, including ICMP, TCP, and UDP, use the keyword **ip**.
- **service**—Group of TCP or UDP port numbers assigned to different services.
- **icmp-type**—Group of ICMP message types to which you permit or deny access.
- **network**—Group of hosts or subnets

Replace *grp-id* with a descriptive name for the group.

When you enter the **object-group** command, the prompt changes to the subcommand mode appropriate for the type of object. Commands entered in the subcommand mode apply to the object type and group name identified in the **object-group** command.

The prompts in each subcommand mode are as follows:

```
pix(config-protocol)#  
pix(config-service)#  
pix(config-icmp-type)#  
pix(config-network)#
```

Enter a question mark (?) in the subcommand mode to view the permitted subcommands.

In subcommand mode, you can enter object grouping subcommands as well as all other PIX Firewall commands including **show** commands and **clear** commands. When you enter any valid configuration command, such as **access-list**, the subcommand mode is terminated. You can also terminate the subcommand mode by entering the **exit** or **quit** commands. Subcommands are indented when they are shown or saved by any of the following commands:

- **show config**
- **write**
- **config**

Configuring and Using Object Groups with Access Control

To configure an object group and to use it for configuring access lists, perform the following steps:

Step 1 Enter the appropriate subcommand mode for the type of group you want to configure.

The syntax of the **object-group** command is as follows:

```
pix(config)# object-group {protocol|network|icmp-type} grp-id
pix(config)# object-group service grp-id {tcp|udp|tcp-udp}
```

Use the first parameter to identify the type of object group you want to configure. Replace the second parameter *grp-id* with a descriptive name for the group. When you enter the **object-group** command, the system enters the appropriate subcommand mode for the type of object you are configuring.

For example, the following command identifies an object group containing trusted hosts:

```
pix(config)# object-group network TrustedHosts
```

When you enter this command, the system enters the network object subcommand mode and the PIX Firewall system prompt appears as follows:

```
pix(config-network)#
```

All subcommands entered from this prompt apply to the object group identified by the **object-group** command. In this example, the object group name is *TrustedHosts*.

Step 2 Define the members of the object group.

Use the subcommands permitted within the subcommand mode to define members of the object group. Use the **group-object** subcommand to add a subgroup within the current object group.

For example:

```
pix(config)# object-group network ftp_servers
pix(config-network)# network-object host 209.165.201.3
pix(config-network)# network-object host 209.165.201.4
pix(config-network)# exit
pix(config)# object-group network TrustedHosts
pix(config-network)# network-object host sjc.eng.ftp
pix(config-network)# network-object host 209.165.201.1
pix(config-network)# network-object 192.168.1.0 255.255.255.0
pix(config-network)# group-object ftp_servers
```

These commands add the following objects to the group *TrustedHosts*:

- One host by host name
- One host by network address
- One subnetwork
- One subgroup (**ftp_servers**)

Step 3 (Optional) Describe the object group by entering the following command from the subcommand mode:

```
pix(config-network)# description text
```

This command lets you add a description of up to 200 characters to an object group. Replace *text* with the descriptive information you wish to enter.

Step 4 Return to configuration mode by entering the following command:

```
pix(config-network)# exit
```

Step 5 (Optional) Verify that the object group has been configured successfully:

```
pix(config)# show object-group [network | services | icmp-type] [grp-id]
```

This command displays a list of the currently configured object groups of the specified type. Without a parameter, the command displays all object groups.

For example:

```
pix(config)# show object-group
object-group network ftp_servers
  description: This is a group of FTP servers
  network-object host 209.165.201.3
  network-object host 209.165.201.4
object-group network TrustedHosts
  network-object host 209.165.201.1
  network-object 192.168.1.0 255.255.255.0
group-object ftp_servers
```

Step 6 Apply the **access-list** command to the object group.



Note Beginning with Version 5.3, the PIX Firewall uses access lists to control connections between inside and outside networks. Access lists are implemented with the **access-list** and **access-group** commands. These commands are used instead of the **conduit** and **outbound** commands, which were used in earlier versions of PIX Firewall. In PIX Firewall software releases later than Version 6.3, the **conduit** and **outbound** commands are no longer supported. To help you with the conversion process, a tool is available online at: <https://cco-dev.cisco.com/cgi-bin/Support/OutputInterpreter/home.pl>.

Replace the parameters of the **access-list** commands with the corresponding object group:

- Replace the **protocol** parameter with a protocol object group.
- Replace local and remote IP addresses and subnet masks with a network object group.
- Replace the **port** parameter with a service object group.
- Replace the **icmp-type** parameter with an icmp-type object group.



Note Empty object groups cannot be used with any commands.

For example, the following command permits access to the members of the object group TrustedHosts:

```
pix(config)# access-list acl permit tcp object-group TrustedHosts host 1.1.1.1
```

Refer to the **access-list** commands in the *Cisco PIX Firewall Command Reference* for the detailed syntax of these commands.

Step 7 (Optional) Use the **show access-list** command to display the expanded access list entries:

```
pix(config)# show access-list
access-list acl permit tcp host 209.165.201.1 host 1.1.1.1
access-list acl permit tcp 192.168.1.0 255.255.255.0 host 1.1.1.1
access-list acl permit tcp host 209.165.201.3 host 1.1.1.1
access-list acl permit tcp host 209.165.201.4 host 1.1.1.1
```



Note The **show config** and **write** commands display the commands in the same way they are configured.

Configuring Protocol Object Groups

This section describes the commands required to configure a protocol object group.

Enter the following command to enable the protocol object subcommand mode:

```
pix(config)# object-group protocol grp-id
```

Enter the following command to add a single protocol to the current protocol object group:

```
pix(config-protocol)# protocol-object protocol
```

Replace *protocol* with the numeric identifier of the specific IP protocol (1 to 254) or a literal keyword identifier (**icmp**, **tcp**, or **udp**). If you wish to include all IP protocols, use the keyword **ip**.

Enter the following command to add the object group identified by *grp-id* to the current protocol object group:

```
pix(config-protocol)# group-object grp-id
```

Configuring Network Object Groups

This section describes the commands required to configure a network object group.

Enter the following command to enable the network object subcommand mode:

```
pix(config)# object-group network grp-id
```

Enter the following command to add a single host name or IP address (with subnetwork mask) to the current network object group:

```
pix(config-network)# network-object host host_addr | net_addr netmask
```

Replace *host_addr* with the IP address of the host you are adding to the group. Replace *net_addr* and *netmask* with the network number and subnet mask for a subnetwork.

Enter the following command to add the object group identified by *grp-id* to the current protocol object group:

```
pix(config-network)# group-object grp-id
```

Configuring Service Object Groups

This section describes the commands required to configure a service object group.

Enter the following command to enable the service object subcommand mode:

```
pix(config)# object-group service {tcp|udp|tcp-udp}
```

Enter the following command to add a single TCP or UDP port number to the service object group:

```
pix(config-service)# port-object eq service grp-id
```

Enter the following command to add a range of TCP or UDP port numbers to the service object group:

```
pix(config-service)# port-object range begin_service end_service
```

Enter the following command to add the object group identified by *grp-id* to the current service object group:

```
pix(config-service)# group-object grp-id
```

Configuring ICMP-Type Object Groups

This section describes the commands required to configure an icmp-type object group.

Enter the following command to enable the icmp-type object subcommand mode:

```
pix(config)# object-group icmp-type grp-id
```

Enter the following command to add an ICMP type to the service object group:

```
pix(config-icmp-type)# icmp-object icmp-type
```

Replace *icmp-type* with a numeric value. Refer to the **access-list** command in the *Cisco PIX Firewall Command Reference* for a definition of the permitted values.

Enter the following command to add the object group identified by *grp-id* to the current icmp-type object group:

```
pix(config-icmp-type)# group-object grp-id
```

Nesting Object Groups

The **object-group** command allows logical grouping of the same type of objects and construction of hierarchical object groups for structured configuration. To nest an object group within another object group, perform the following steps:

-
- Step 1** Assign a group ID to the object group that you want to nest within another object group, as in the following example:

```
pix(config)# object-group protocol Group_A
```

- Step 2** Add the appropriate type of objects to the object group:

```
pix(config-protocol)# protocol-object 1  
pix(config-protocol)# protocol-object 2  
pix(config-protocol)# protocol-object 3
```

- Step 3** Assign a group identifier to the object group within which you want to nest another object group:

```
pix(config)# object-group protocol Group_B
```

Step 4 Add the first object group to the group that will contain that object:

```
pix(config-protocol)# group-object A
```

Step 5 Add any other objects to the group that are required:

```
pix(config-protocol)# protocol-object 4
```

The resulting configuration of Group_B in this example is equivalent to the following:

```
pix(config-protocol)# protocol-object 1
pix(config-protocol)# protocol-object 2
pix(config-protocol)# protocol-object 3
pix(config-protocol)# protocol-object 4
```

Displaying Configured Object Groups

To display a list of the currently configured object groups, use the **show object-group** command:

```
show object-group [ protocol | network | service | icmp-type ] [ id grp_id]
```

Use the listed parameters to restrict the display to specific object types or to identify a specific object group by name. The system displays a list of the currently configured object groups identified by the command. Replace *grp_id* with the name of a specific object group. If you enter the command without any parameters, the system displays all configured object groups.

[Example 3-7](#) shows sample output from the **show object-group** command.

Example 3-7 Show object-group Command Output

```
pix(config)# show object-group
object-group network ftp_servers
  description: This is a group of FTP servers
  network-object host 209.165.201.3
  network-object host 209.165.201.4
object-group network TrustedHosts
  network-object host 209.165.201.1
  network-object 192.168.1.0 255.255.255.0
group-object ftp_servers
```

Removing Object Groups

To remove the object group configuration for all the groups of a specific type, use the **clear object-group** command:

```
pix(config)# clear object-group [ protocol | network | services | icmp-type ]
```

If you enter the **clear object-group** command without any parameters, the system removes all configured object groups.

To remove a specific object group, use the following command:

```
pix(config)# no object-group grp_id
```

Replace *grp_id* with the identifier assigned to the specific group you want to remove.

**Note**

You cannot remove an object group or make an object group empty if it is used in a command.

Filtering Outbound Connections

This section describes ways to filter web traffic to reduce security risks or inappropriate use and includes the following topics:

- [Filtering ActiveX Objects, page 3-31](#)
- [Filtering Java Applets, page 3-32](#)
- [Filtering URLs with Internet Filtering Servers, page 3-32](#)

ActiveX objects and Java applets may pose security risks because they can contain code intended to attack hosts and servers on a protected network. You can disable ActiveX objects and remove Java applets with the PIX Firewall **filter** command.

You can use the **filter** command to work with a URL filtering server to remove URLs that are inappropriate for use at your site.

Filtering ActiveX Objects

ActiveX controls, formerly known as OLE or OCX controls, are components you can insert in a web page or other application. These controls include custom forms, calendars, or any of the extensive third-party forms for gathering or displaying information. As a technology, ActiveX creates many potential problems for network clients including causing workstations to fail, introducing network security problems, or being used to attack servers.

The syntax of the command for filtering ActiveX objects is as follows:

```
filter activex port[-port] local_ip mask foreign_ip mask
```

This command blocks the HTML `<object>` commands by commenting them out within the HTML web page. This functionality has been added to the **filter** command with the **activex** option.

**Note**

The `<object>` tag is also used for Java applets, image files, and multimedia objects, which will also be blocked by the new command.

If the `<object>` or `</object>` HTML tags split across network packets or if the code in the tags is longer than the number of bytes in the MTU, PIX Firewall cannot block the tag.

Java and ActiveX filtering of HTML files are performed by selectively replacing the `<APPLET>` and `</APPLET>` and `<OBJECT CLASSID>` and `</OBJECT>` tags with comments. Filtering of nested tags is supported by converting top-level tags to comments.

**Note**

ActiveX blocking does not occur when users access an IP address referenced by the **alias** command.

Filtering Java Applets

The **filter java** command filters out Java applets that return to the PIX Firewall from an outbound connection. The user still receives the HTML page, but the web page source for the applet is commented out so that the applet cannot execute. The syntax of the command for filtering Java applets is as follows:

```
filter java port[-port] local_ip mask foreign_ip mask
```

Use 0 for the *local_ip* or *foreign_ip* IP addresses to mean all hosts.



Note

If Java applets are known to be in <object> tags, use the **filteractivex** command to remove them.

Examples

To specify that all outbound connections have Java applet blocking, use the following command:

```
filter java 80 0 0 0 0
```

This command specifies that the Java applet blocking applies to web traffic on port 80 from any local host and for connections to any foreign host. To block downloading of Java applets to a host on a protected network, enter a command like the following:

```
filter java http 192.168.3.3 255.255.255.255 0 0
```

This command prevents host 192.168.3.3 from downloading Java applets.

Filtering URLs with Internet Filtering Servers

This section describes how to enable URL filtering. It contains the following topics:

- [Overview, page 3-32](#)
- [Identifying the Filtering Server, page 3-33](#)
- [Buffering HTTP Replies for Filtered URLs, page 3-34](#)
- [Filtering Long URLs with the Websense Filtering Server, page 3-34](#)
- [Filtering HTTPS and FTP Sites, page 3-34](#)
- [Configuring Filtering Policy, page 3-35](#)
- [Filtering Long URLs, page 3-36](#)
- [Viewing Filtering Statistics and Configuration, page 3-36](#)
- [Configuration Procedure, page 3-38](#)

Overview

The **filter url** command lets you designate webs traffic that is to be filtered using one of the following URL filtering applications:

- Websense Enterprise web filtering application—Supported by PIX Firewall Version 5.3 or higher
- Filtering by N2H2 for IFP-enabled devices—Supported by PIX Firewall Version 6.2 or higher

When a user issues an HTTP request to a website, the PIX Firewall sends the request to the web server and to the filtering server at the same time. If the filtering server permits the connection, the PIX Firewall allows the reply from the website to reach the user who issued the original request. If the filtering server denies the connection, the PIX Firewall redirects the user to a block page, indicating that access was denied. The PIX Firewall sends an authenticated user name, a source IP address, and a destination IP address to the filtering server for URL validation and logging purposes.

**Note**

URL filtering only may considerably increase access times to web sites when the filtering server is remote from the PIX Firewall.

Identifying the Filtering Server

You identify the address of the filtering server using the form of the **url-server** command appropriate for the type of filtering server you are using.

For Websense:

```
pix(config)# url-server [(if_name)] host local_ip [timeout seconds] [protocol TCP [version 1 | 4] | UDP]
```

For N2H2:

```
pix(config)# url-server [(if_name)] vendor n2h2 host local_ip[:port number] [timeout <seconds>] [protocol TCP | UDP]
```

Replace *if_name* with the name of the PIX Firewall interface on which you are enabling filtering. Enclose the interface name within parentheses, as in the following example:

```
url-server (inside) host 192.168.1.1
```

By default, if you do not include this parameter, filtering will apply to the inside interface.

Replace *local_ip* with the IP address of the filtering server. Replace *seconds* with the number of seconds the PIX Firewall should wait before giving up on connecting to the filtering server.

Use the protocol option to identify whether you want to use TCP or UDP. With a Websense server, you can also specify the version of TCP you want to use. TCP version 1 is the default. TCP version 4 allows the PIX Firewall to send authenticated usernames and URL logging information to the Websense server, if the PIX Firewall has already authenticated the user.

**Note**

URL filtering may considerably increase access times to web sites when the filtering server is remote from the PIX Firewall.

You can identify more than one filtering server by entering the **url-server** command multiple times. The primary filtering server is the first server that you identify. If you want to change your primary server, use the **no url-server** command with the address of your primary filtering server. Then issue the **url-server** command with the address of your primary server.

**Note**

If you switch the url-server type after configuration, the existing url-server configurations are dropped and you must reenter the configuration for the new filtering server type.

Buffering HTTP Replies for Filtered URLs

By default, when a user issues a request to connect to a specific website, the PIX Firewall sends the request to the web server and to the filtering server at the same time. If the filtering server does not respond before the web content server, the response from the web server is dropped. This delays the web server response from the point of view of the web client.

By enabling the HTTP response buffer, replies from web content servers are buffered and the responses will be forwarded to the requesting user if the filtering server allows the connection. This prevents the delay that may otherwise occur.

To enable the HTTP response buffer, enter the following command:

```
url-block block block-buffer-limit
```

Replace *block-buffer-limit* with the maximum number of blocks that will be buffered. The permitted values are from 0 to 128, which specifies the number of 1550-byte blocks that can be buffered at one time.

Filtering Long URLs with the Websense Filtering Server



Note

PIX Firewall Versions 6.2 and higher support a fixed, maximum URL length of 1159 bytes for the N2H2 filtering server.

To increase the maximum length of a single URL that can be sent to a Websense filtering server, enter the following command:

```
url-block url-size long-url-size
```

Replace *long-url-size* with a value from 2 to 4 for a maximum URL size of 2 KB to 4 KB.

To configure the maximum memory available for buffering long URLs, enter the following command:

```
url-block url-mempool memory-pool-size
```

Replace *memory-pool-size* with a value from 2 to 10240 for a maximum memory allocation of 2 KB to 10 MB.

Filtering HTTPS and FTP Sites

PIX Firewall Version 6.3 introduces support for filtering of HTTPS and FTP sites for Websense filtering servers.



Note

HTTPS and FTP filtering are not supported for the N2H2 filtering server.

HTTPS filtering works by preventing the completion of SSL connection negotiation if the site is not allowed. The browser displays an error message such as “The Page or the content cannot be displayed.”

Because HTTPS content is encrypted, PIX Firewall sends the URL lookup without directory and filename information.

To enable HTTPS filtering, use the following command:

```
filter https dest_port localIP local_mask foreign_IP foreign_mask [allow]
```

To enable FTP filtering, use the following command:

```
filter ftp dest_port localIP local_mask foreign_IP foreign_mask [allow] [interact-block]
```

The **filter ftp** command lets you identify the FTP traffic to be filtered by a Websense server. FTP filtering is not supported on N2H2 servers.

After enabling this feature, when a user issues an FTP GET request to a server, the PIX Firewall sends the request to the FTP server and to the Websense server at the same time. If the Websense server permits the connection, the firewall allows the successful FTP return code to reach the user unchanged. For example, a successful return code is “250: CWD command successful.”

If the Websense server denies the connection, the PIX Firewall alters the FTP return code to show that the connection was denied. For example, the PIX Firewall would change code 250 to “code 550: Directory not found.” Websense only filters FTP GET commands and not PUT commands).

Use the **interactive-block** option to prevent interactive FTP sessions that do not provide the entire directory path. An interactive FTP client allows the user to change directories without typing the entire path. For example, the user might enter **cd ./files** instead of **cd /public/files**.

You must identify and enable the URL filtering server before using these commands. If all URL filtering servers are removed, any associated filtering commands are also removed.

Configuring Filtering Policy

Use the **filter url** command to configure the policy for filtering URLs. The syntax of the command for filtering URLs is as follows.

```
filter url port[-port] local_ip local_mask foreign_ip foreign_mask] [allow] [proxy-block]
```

Replace *port* with the port number on which to filter HTTP traffic. To identify a range of port numbers, enter the beginning and end of the range separated by a hyphen.

To identify specific HTTP traffic for filtering, replace *local_ip* and *local_mask* with the IP address and subnet mask of a user or subnetwork making requests. Replace *foreign_ip* and *foreign_mask* with the IP address and subnet mask of a server or subnetwork responding to requests.

With filtering enabled, the PIX Firewall stops outbound HTTP traffic until a filtering server permits the connection. If the primary filtering server does not respond, the PIX Firewall directs the filtering request to the secondary filtering server. The **allow** option causes the PIX Firewall to forward HTTP traffic without filtering when the primary filtering server is unavailable.

Use the **proxy-block** command to drop all requests to proxy servers.

If you want to make exceptions to the general filtering policy, use the following command:

```
filter url except local_ip local_mask foreign_ip foreign_mask]
```

Replace *local_ip* and *local_mask* with the IP address and subnet mask of a user or subnetwork that you want to exempt from filtering restrictions. Replace *foreign_ip* and *foreign_mask* with the IP address and subnet mask of a server or subnetwork that you want to exempt from filtering restrictions.

Filtering Long URLs

PIX Firewall Version 6.1 and earlier versions do not support filtering URLs longer than 1159 bytes. PIX Firewall Versions 6.2 and higher support filtering URLs up to 4 KB for the Websense filtering server. PIX Firewall Versions 6.2 and higher support a maximum URL length of 1159 bytes for the N2H2 filtering server.

In addition, PIX Firewall Version 6.2 introduces the **longurl-truncate** and **cgi-truncate** commands to allow handling of URL requests longer than the maximum permitted size. The format for these options is as follows:

```
filter url [http | port[-port] local_ip local_mask foreign_ip foreign_mask] [allow]
[proxy-block] [longurl-truncate | longurl-deny] [cgi-truncate]
```

PIX Firewall Versions 6.2 and higher support a maximum URL length of 1159 bytes for the N2H2 filtering server. Filtering of URLs up to 4 KB is supported for the Websense filtering server. If a URL is longer than the maximum, and you do not enable the **longurl-truncate** or **longurl-deny** options, the firewall drops the packet.

The **longurl-truncate** option causes the PIX Firewall to send only the host name or IP address portion of the URL for evaluation to the filtering server when the URL is longer than the maximum length permitted. Use the **longurl-deny** option to deny outbound URL traffic if the URL is longer than the maximum permitted.

Use the **cgi-truncate** option to truncate CGI URLs to include only the CGI script location and the script name without any parameters. Many long HTTP requests are CGI requests. If the parameters list is very long, waiting and sending the complete CGI request including the parameter list can use up memory resources and affect firewall performance.

Viewing Filtering Statistics and Configuration

Use the commands in this section to view URL filtering information:

To show information about the filtering server, enter the following command:

```
show url-server
```

The following is sample output from this command:

```
url-server (outside) vendor n2h2 host 128.107.254.202 port 4005 timeout 5 protocol TCP
```

To show the URL statistics, enter the following command:

```
show url-server stats
```

The following is sample output from this command:

```
URL Server Statistics:
-----
Vendor                               websense
URLs total/allowed/denied            0/0/0
HTTPSs total/allowed/denied          0/0/0
FTPs total/allowed/denied            0/0/0
```

```

URL Server Status:
-----
10.130.28.18          UP

URL Packets Sent and Received Stats:
-----
Message                Sent      Received
STATUS_REQUEST        65155    34773
LOOKUP_REQUEST         0         0
LOG_REQUEST            0         NA
-----

```

To show URL caching statistics, enter the following command:

```
show url-cache stat
```

The following is sample output from this command:

```

pix(config)# show url-cache stats
URL Filter Cache Stats
-----
      Size :      128KB
  Entries :      1724
    In Use :         0
  Lookups :         0
     Hits :         0

```

To show URL filtering performance statistics, enter the following command:

```
show perfmon
```

The following is sample output from this command:

```

pix(config)# show perfmon

PERFMON STATS:      Current      Average
Xlates              0/s        0/s
Connections         0/s        2/s
TCP Conns           0/s        2/s
UDP Conns           0/s        0/s
URL Access          0/s        2/s
URL Server Req     0/s        3/s
TCP Fixup           0/s        0/s
TCPIntercept       0/s        0/s
HTTP Fixup         0/s        3/s
FTP Fixup           0/s        0/s
AAA Authen         0/s        0/s
AAA Author          0/s        0/s
AAA Account         0/s        0/s

```

To show filtering configuration, enter the following command:

```
show filter
```

The following is sample output from this command:

```

pix(config)# show filter
filter url http 0.0.0.0 0.0.0.0 0.0.0.0 0.0.0.0

```

Configuration Procedure

Perform the following steps to filter URLs:

Step 1 Identify the address of the filtering server with the **url-server** commands:

For Websense:

```
# url-server [(if_name)] host local_ip [timeout seconds] [protocol TCP | UDP version 1|4]
```

For N2H2:

```
# url-server [(if_name)] vendor n2h2 host local_ip[:port number] [timeout seconds]
[protocol TCP | UDP]
```

Replace *if_name* with the name of the PIX Firewall interface that is connected to the filtering server (the default is **inside**). Replace *local_ip* with the IP address of the filtering server. Replace *seconds* with the number of seconds the PIX Firewall should wait before giving up on connecting to the filtering server.



Note The default port is 4005. This is the default port used by the N2H2 server to communicate to the PIX Firewall via TCP or UDP. For information on changing the default port, please refer to the *Filtering by N2H2 Administrator's Guide*.

For example:

```
url-server (perimeter) host 10.0.1.1
url-server (perimeter) vendor n2h2 host 10.0.1.1
```

The first command identifies a Websense filtering server with the IP address 10.0.1.1 on a perimeter interface of the PIX Firewall. The second command identifies an N2H2 server at the same interface and address.

Step 2 Configure your filtering policy with the following command:

```
filter url [http | port[-port] local_ip local_mask foreign_ip foreign_mask] [allow]
[proxy-block]
```

Replace *port* with one or more port numbers if a different port than the default port for HTTP (80) is used. Replace *local_ip* and *local_mask* with the IP address and subnet mask of a user or subnetwork making requests. Replace *foreign_ip* and *foreign_mask* with the IP address and subnet mask of a server or subnetwork responding to requests.

The **allow** option causes the PIX Firewall to forward HTTP traffic without filtering when the primary filtering server is unavailable. Use the **proxy-block** command to drop all requests to proxy servers.

For example:

```
filter url http 0 0 0 0
filter url except 10.0.2.54 255.255.255.255 0 0
```

The first command filters all HTTP traffic. The second command exempts all requests from 10.0.2.54 from filtering restrictions.



Note Step 3 through Step 6 only work with PIX Firewall Version 6.2 or higher. Buffering URLs longer than 1159 bytes is only supported for the Websense filtering server.

- Step 3** (Optional) Enable buffering of HTTP replies for URLs that are pending a response from the filtering server by entering the following command:

```
url-block block block-buffer-limit
```

Replace *block-buffer-limit* with the maximum number of blocks that will be buffered.

- Step 4** (Optional) Configure the maximum memory available for buffering pending URLs (and for buffering long URLs with Websense) with the following command:

```
url-block url-mempool memory-pool-size
```

Replace *memory-pool-size* with a value from 2 to 10240 for a maximum memory allocation of 2 KB to 10 MB.

- Step 5** (Optional for Websense only) Configure the maximum size of a single URL with the following command:

```
url-block url-size long-url-size
```

Replace *long-url-size* with a value from 2 to 4 for a maximum URL size of 2 KB to 4 KB. The default value is 2.

- Step 6** (Optional) To handle URLs that are longer than the maximum available buffer size, enter the **filter** command in the following form:

```
filter url [longurl-truncate | longurl-deny | cgi-truncate]
```

Use the **longurl-truncate** command to send only the host name or IP address portion of the URL for evaluation to the filtering server when the URL is longer than the maximum length permitted.

Use the **longurl-deny** option to deny outbound traffic if the URL is longer than the maximum permitted (1159 for N2H2 or configurable up to 4 KB for Websense).

Use the **cgi-truncate** option to send a CGI script as the URL.

- Step 7** (Optional) To display memory usage, enter the following commands:

```
show chunk
show memory
```

- Step 8** (Optional) Use the **url-cache** command if needed to improve throughput, as follows:

```
url-cache dst | src_dst size
```



Note This command does not update Websense logs, which may affect Websense accounting reports. Accumulate Websense run logs before using the **url-cache** command.

Replace *size* with a value for the cache size within the range 1 to 128 (KB).

Use the **dst** keyword to cache entries based on the URL destination address. Select this mode if all users share the same URL filtering policy on the Websense server.

Use the **src_dst** keyword to cache entries based on both the source address initiating the URL request as well as the URL destination address. Select this mode if users do not share the same URL filtering policy on the Websense server.

Step 9 Configure the required URL filters at the user interface of the filtering server.

For more information about filtering with the N2H2 or Websense filtering servers, refer to the following web sites:

<http://www.websense.com>

<http://www.n2h2.com>

Step 10 Use the following commands to view URL filtering information:

To show URL caching statistics, enter the following command:

```
show url-cache stats
```

To show URL filtering performance statistics, enter the following command:

```
show perfmon
```

To show the information about the filtering server, enter the following command:

```
show url-server
```

To show filtering configuration, enter the following command:

```
show filter
```

Using PIX Firewall in SOHO Networks

This chapter describes features provided by the PIX Firewall that are used in the small office, home office (SOHO) environment. It includes the following sections:

- [Using PIX Firewall as an Easy VPN Remote Device, page 4-1](#)
- [Using the PIX Firewall PPPoE Client, page 4-11](#)
- [Using the PIX Firewall DHCP Server, page 4-15](#)
- [Using DHCP Relay, page 4-20](#)
- [Using the PIX Firewall DHCP Client, page 4-21](#)

Using PIX Firewall as an Easy VPN Remote Device

This section describes the commands and procedures required to configure the PIX Firewall as an Easy VPN Remote device. It includes the following topics:

- [Overview, page 4-2](#)
- [Establishing Network Connectivity, page 4-4](#)
- [Basic Configuration Procedure, page 4-4](#)
- [Viewing Downloaded Configuration, page 4-5](#)
- [Controlling Remote Administration, page 4-6](#)
- [Using Secure Unit Authentication, page 4-6](#)
- [Using Individual User Authentication, page 4-8](#)
- [Using X.509 Certificates, page 4-9](#)
- [Verifying the DN of an Easy VPN Server, page 4-10](#)

For information about configuring the PIX Firewall as an Easy VPN Server, refer to [Chapter 8](#), “Managing VPN Remote Access.”

**Note**

PIX Firewall Version 6.3 allows a management connection to the inside interface of a PIX Firewall over a VPN tunnel. This feature is designed for remote management of a PIX Firewall used as an Easy VPN Remote device, which typically has an IP address dynamically assigned to its outside interface. For further information, refer to the “[Connecting to PIX Firewall Over a VPN Tunnel](#)” section on [page 9-1](#).

Overview

When used with PIX Firewall Versions 6.2 and higher, you can use a PIX Firewall 501 or PIX 506/506E as an Easy VPN Remote device when connecting to an Easy VPN Server, such as a Cisco VPN 3000 Concentrator or another PIX Firewall. Figure 4-1 illustrates how Easy VPN Remote devices can be used in a Virtual Private Network (VPN).

Figure 4-1 Using the PIX Firewall as an Easy VPN Remote Device

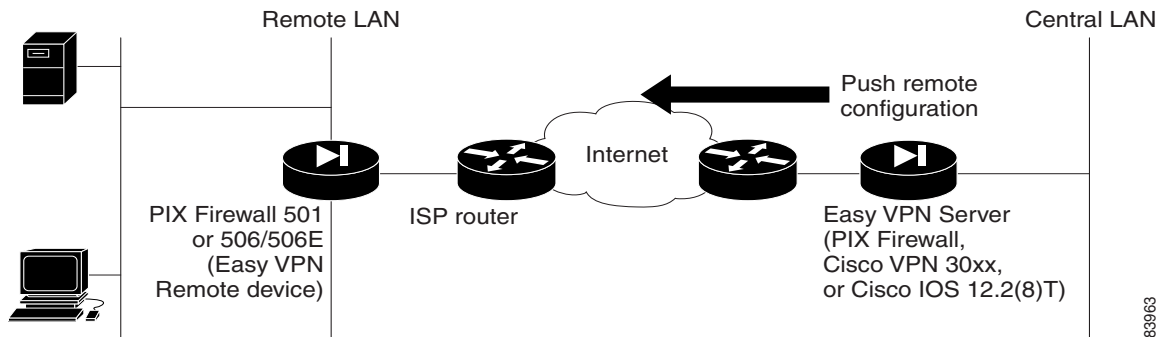

Easy VPN Remote device functionality, sometimes called a “hardware client,” allows the PIX Firewall to establish a VPN tunnel to the Easy VPN Server. Hosts running on the LAN behind the PIX Firewall can connect through the Easy VPN Server without individually running any VPN client software.

PIX Firewall Version 6.3 or higher used as an Easy VPN Remote device can make use of load balancing and redundancy features among two or more Easy VPN Servers. To implement redundancy, a list of backup servers is configured on an Easy VPN Server and is downloaded to your Easy VPN Remote device. The Easy VPN Remote device automatically redirects its connection request to the next backup server on its list if it does not receive a response after five seconds.

Load balancing requires the use of Cisco 3000 Series VPN Concentrators for the Easy VPN Servers. With load balancing, you configure a virtual IP address for the destination of your Easy VPN Remote device connection. Easy VPN Servers that share a virtual IP address form a load balancing cluster, with one of the members acting as the master server. The master server receives request, calculates the optimal server, and directs the connection request to that server.

Two different modes of operation are supported when using the PIX Firewall as an Easy VPN Remote device:

- Client mode
- Network extension mode



Note

If Cisco IP Phones are connected over the VPN tunnel and Session Initiation Protocol (SIP) proxy is used on the network protected by the Easy VPN Server, you must use network extension mode.

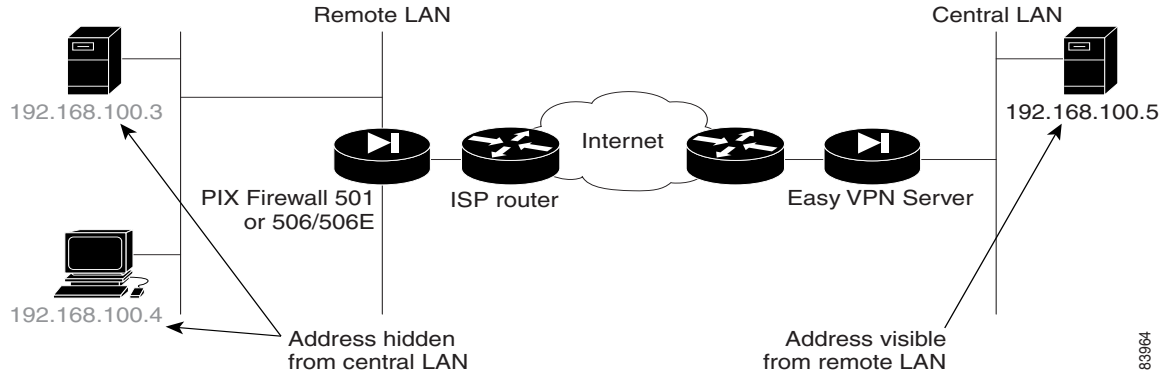
Figure 4-2 Using the PIX Firewall in Client Mode

As shown in [Figure 4-2](#), client mode causes VPN connections to be initiated by traffic, so resources are only used on demand. In client mode, the PIX Firewall applies Network Address Translation (NAT) to all IP addresses of clients connected to the inside (higher security) interface of the PIX Firewall. To use this mode, you must also enable the DHCP server on the inside interface, as described in “[Using the PIX Firewall DHCP Server.](#)”

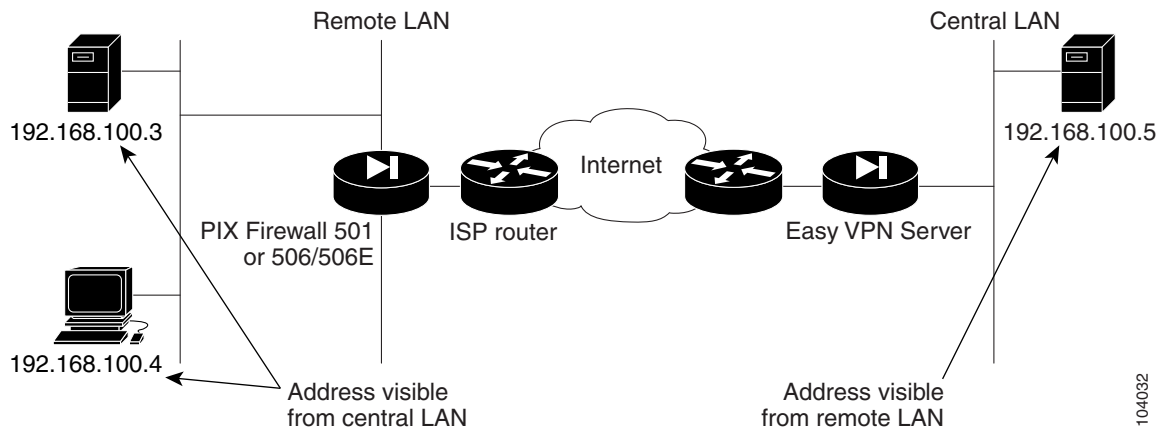
Figure 4-3 Using the PIX Firewall in Network Extension Mode

[Figure 4-3](#) illustrates network extension mode. In this mode, VPN connections are kept open even when not required for transmitting traffic. This option does not apply NAT to any IP addresses of clients on the inside (higher security) interface of the PIX Firewall.

In network extension mode, the IP addresses of clients on the inside interface are received without change at the Easy VPN Server. If these addresses are registered with the Network Information Center (NIC), they may be forwarded to the public Internet without further processing. Otherwise, they may be translated by the Easy VPN Server or forwarded to a private network without translation.

Establishing Network Connectivity

Before you can connect the PIX Firewall Easy VPN Remote device to the Easy VPN Server, you must establish network connectivity between both devices through your Internet service provider (ISP). After connecting your PIX Firewall to the DSL or Cable modem, you should follow the instructions provided by your ISP to complete the network connection. Basically, there are three methods of obtaining an IP address when establishing connectivity to your ISP:

- PPPoE client—Refer to [“Using the PIX Firewall PPPoE Client”](#) section on page 4-11.
- DHCP client—Refer to [“Using the PIX Firewall DHCP Client”](#) section on page 4-21.
- Static IP address configuration—Refer to the [“Assigning an IP Address and Subnet Mask”](#) section on page 2-5, in Chapter 2, “Establishing Connectivity.”

Basic Configuration Procedure

The Easy VPN Server controls the policy enforced on the PIX Firewall Easy VPN Remote device. However, to establish the initial connection to the Easy VPN Server, you must complete some configuration locally. You can perform this configuration by using Cisco PIX Device Manager (PDM) or by using the command-line interface as described in the following steps:

Step 1 If you are using pre-shared keys, enter the following command:

```
vpnclient vpngroup {groupname} password {preshared_key}
```



Note This command is not required if you are using X.509 certificates.

Replace *groupname* with an alphanumeric identifier for the VPN group. Replace *preshared_key* with the encryption key to use for securing communications to the Easy VPN Server.

Step 2 (Optional) If the Easy VPN Server uses extended authentication (Xauth) to authenticate the PIX Firewall client, enter the following command:

```
vpnclient username {xauth_username} password {xauth_password}
```

Replace *xauth_username* with the username assigned for Xauth. Replace *xauth_password* with the password assigned for Xauth.

Step 3 Identify the remote Easy VPN Server by entering the following command:

```
vpnclient server {ip_primary} [ip_secondary_n]
```

Replace *ip_primary* with the IP address of the primary Easy VPN Server. Replace *ip_secondary_n* with the IP address of one or more Easy VPN Servers. A maximum of eleven Easy VPN Servers are supported (one primary and up to ten secondary).

Step 4 Set the Easy VPN Remote device mode by entering the following command:

```
vpnclient mode {client-mode | network-extension-mode}
```

- Client mode applies NAT to all IP addresses of clients connected to the inside (higher security) interface of the PIX Firewall.
- Network extension mode—This option does not apply NAT to any IP addresses of clients on the inside (higher security) interface of the PIX Firewall.

Step 5 Enable the Easy VPN Remote device by entering the following command:

```
vpnclient enable
```

Step 6 (Optional) To display the current status and configuration of Easy VPN Remote device, enter the following command:

```
show vpnclient
```

Viewing Downloaded Configuration

There are two different flash memory areas for saving configuration information. The downloaded configuration is stored in a separate area that is only visible when using the **show vpn detail** command. To view all the configuration (static, dynamic, flash-private storage area FPSA-related) associated with the Easy VPN Remote device, enter the following command:

```
remotepix(config)#show vpnclient detail
```

The output from this command after the Easy VPN Remote device is connected to the Easy VPN Server includes the following (this output has been abridged and annotated for clarity):

```
LOCAL CONFIGURATION
vpnclient server 80.0.0.1
vpnclient mode client-mode
vpnclient vpngroup unity password *****
vpnclient username maruthitacacs password *****
vpnclient management tunnel 10.0.0.0 255.255.255.0
vpnclient enable

DOWNLOADED DYNAMIC POLICY
Current Server                : 80.0.0.1
NAT addr                      : 90.0.0.10
Primary DNS                   : 10.0.0.21
Default Domain                : example.com
PFS Enabled                   : Yes
Secure Unit Authentication Enabled : No
User Authentication Enabled   : Yes
User Authentication Server    : 10.0.0.3
User Authentication Server Port : 1645
User Authentication Idle Timeout : 2:46:40
Device Pass Through Enabled   : Yes
Split Networks                : 10.0.0.0/255.255.255.0 110.0.0.0/255.255.255.0
Split DNS                     : example.com
Backup Servers                 : None

STORED POLICY
Secure Unit Authentication Enabled : No
Split Networks                    : 10.0.0.0/255.255.255.0 110.0.0.0/255.255.255.0
Backup Servers                    : 80.0.0.30

RELATED CONFIGURATION
sysopt connection permit-ipsec
global (outside) 10 interface
global (outside) 65001 90.0.0.10
nat (inside) 10 60.0.0.0 255.255.255.0 0 0
access-list _vpnc_pat_acl permit ip any 10.0.0.0 255.255.255.0
access-list _vpnc_pat_acl permit ip any 110.0.0.0 255.255.255.0
access-list _vpnc_acl permit ip host 90.0.0.10 10.0.0.0 255.255.255.0
access-list _vpnc_acl permit ip host 90.0.0.10 110.0.0.0 255.255.255.0
```

```

access-list _vpnc_acl permit ip host 80.0.0.2 10.0.0.0 255.255.255.0
access-list _vpnc_acl permit ip host 80.0.0.2 host 10.0.0.3
access-list _vpnc_iaa_acl permit ip any 10.0.0.0 255.255.255.0
access-list _vpnc_iaa_acl permit ip any 110.0.0.0 255.255.255.0
aaa-server TACACS+ protocol tacacs+
aaa-server RADIUS protocol radius

```

Controlling Remote Administration

PIX Firewall Version 6.3 introduces a feature that improves administrative security by letting you identify the networks from which your PIX Firewall can be remotely managed or by preventing remote management altogether.

If you do not enable this feature, any host that has access to the outside interface of your PIX Firewall through a VPN tunnel can manage it remotely.

To enable this feature, enter the following command:

```
vpnclient management tunnel ip_addr_1 ip_mask_1 [[ip_addr_2 ip_mask_2] ... ]]
```

Replace *ip_addr_1* and *ip_mask_1* with the IP address and subnet mask of the remote host you would like to allow to remotely manage your PIX Firewall. Use additional IP addresses and subnet masks to enable remote management from more than one host.

To completely prevent remote management using the outside interface of your PIX Firewall, enter the following command:

```
vpnclient management clear
```

After entering this command, no remote management connection is allowed over a VPN tunnel to the outside interface of the PIX Firewall. By default, the PIX Firewall can only be remotely managed by connecting to its outside interface over a secure VPN tunnel. To enable a remote management connection to the inside interface of your PIX Firewall, refer to the [“Connecting to PIX Firewall Over a VPN Tunnel”](#) section on page 9-1 in Chapter 9, [“Accessing and Monitoring PIX Firewall.”](#)

Using Secure Unit Authentication

This section describes how Secure Unit Authentication (SUA) affects the behavior of a PIX Firewall used as an Easy VPN Remote device, and how you can manage this behavior. It includes the following topics:

- [Overview, page 4-6](#)
- [Establishing a Connection with SUA Enabled, page 4-7](#)
- [Managing Connection Behavior with SUA, page 4-7](#)

Overview

Secure unit authentication (SUA) is a feature introduced with PIX Firewall Version 6.3 to improve security when using a PIX Firewall as an Easy VPN Remote device. With SUA, one-time passwords, two-factor authentication, and similar authentication schemes can be used to authenticate the remote PIX Firewall before establishing a VPN tunnel to an Easy VPN Server.

Secure Unit Authentication (SUA) is configured as part of the VPN policy on the Easy VPN Server and cannot be configured directly on the Easy VPN Remote device. After connecting to the Easy VPN Server, the Easy VPN Remote device downloads the VPN policy, which then enables or disables SUA.

When SUA is disabled and the PIX Firewall is in network extension mode, a connection is automatically initiated. When SUA is disabled with client mode, the connection is automatically initiated whenever any traffic is sent through the PIX Firewall to a network protected by the Easy VPN Server.

When SUA is enabled, static credentials included in the local configuration of the Easy VPN Remote device are ignored. A connection request is initiated as soon as an HTTP request is sent from the remote network to the network protected by the Easy VPN Server. All other traffic to the network protected by the Easy VPN Server is dropped until a VPN tunnel is established. You can also initiate a connection request from the CLI of the Easy VPN Remote device.

Establishing a Connection with SUA Enabled

After SUA is enabled and before a VPN tunnel is established, any HTTP request to the network protected by the Easy VPN Server is redirected to the URL as follows:

```
https://inside-ipaddr/vpnclient/connstatus.html
```

Where *inside-ipaddr* is replaced by the IP address of the inside interface of the PIX Firewall used as the Easy VPN Remote device. You can activate the connection by manually entering this URL in the Address or Location box of a browser, and you can use this URL to check the status of the VPN tunnel.

This URL provides a page containing a Connect link that displays an authentication page. If authentication is successful, the VPN tunnel is established. After the VPN tunnel is established, other users on the network protected by the Easy VPN Remote device can access the network protected by the Easy VPN Server without further authentication. If you want to control access by individual users, you can implement Individual User Authentication, as described in the [“Using Individual User Authentication” section on page 4-8](#).

You can manually initiate a connection from the CLI of the PIX Firewall used as an Easy VPN Remote device, by entering the following command:

```
vpnclient connect
```

To close a connection using the CLI, enter the following command:

```
vpnclient disconnect
```

This causes the Easy VPN Remote device to disconnect from the Easy VPN Server and to tear down the IKE tunnel. You can use the **vpnclient connect** and **vpnclient disconnect** commands to force an update of the downloaded policy by disconnecting and reconnecting to the Easy VPN Server.

Managing Connection Behavior with SUA

After the VPN policy is downloaded, the PIX Firewall used as an Easy VPN Remote device stores the downloaded policy, including the status of SUA, in a private area of the FLASH memory. This lets the Easy VPN Remote device determine its connection behavior for the next connection attempt. After downloading a VPN policy that changes its SUA status, the PIX Firewall automatically disconnects from the Easy VPN Server. This allows the Easy VPN Remote device to immediately implement the change in its SUA status.

**Note**

After enabling SUA, your local PIX Firewall will not require static credentials because credentials are entered manually each time a connection is made. However, if SUA is disabled for any reason at the Easy VPN Server, you will need static credentials to make a VPN connection. For this reason, if you have static credentials in your local configuration, do not remove them unless you have a good reason to do so.

The following CLI clears the stored policy, as well as the currently running SUA configuration.

```
clear vpnclient
```

After entering this command (or before connecting a PIX Firewall to an Easy VPN Server for the first time) the PIX Firewall is in “SUA_Unspecified” state. In this state, SUA is enabled if static authentication credentials are not included in the configuration of the local PIX Firewall. Otherwise, if static authentication credentials are *included*, SUA is disabled.

As mentioned earlier, the connection behavior of the PIX Firewall used as an Easy VPN Remote device varies depending on whether it is in client mode or network extension mode. It also varies depending on whether the local configuration contains static credentials (configured using the command **vpnclient username user password pass**), and depending on its SUA state. This behavior is summarized in [Table 4-1](#).

Table 4-1 PIX Firewall Behavior in Different SUA States

PIX Firewall State	Client Mode	Network Extension Mode
SUA_Unspecified and the local configuration contains static credentials.	Traffic from or through the PIX Firewall initiates the VPN tunnel.	The VPN tunnel is initiated automatically.
SUA_Unspecified and the local configuration does <i>not</i> contain static credentials.	Manual connection is required.	Manual connection is required.
SUA_Disabled. Static credentials are required.	Traffic from or through the PIX Firewall initiates the VPN tunnel.	The VPN tunnel is initiated automatically and is maintained in an open state.
SUA_Enabled. Static credentials are not required.	Manual connection is required.	Manual connection is required.

Using Individual User Authentication

Individual User Authentication (IUA) causes clients on the inside network of the Easy VPN Remote to be individually authenticated based on the IP address of the inside client. IUA supports authentication with both static and dynamic password mechanisms.

IUA is enabled by means of the downloaded VPN policy and it cannot be configured locally. For information about enabling IUA on a PIX Firewall used as an Easy VPN Server, refer to the [“Configuring Individual User Authentication”](#) section on page 8-4.

When IUA is enabled, each user on the network protected by the Easy VPN Remote device is prompted for a user name and password when trying to initiate a connection. A PIX Firewall acting as an Easy VPN Server downloads the contact information for the AAA server to the Easy VPN Remote device,

which sends each authentication request directly to the AAA server. A Cisco 3000 Series VPN Concentrator used as an Easy VPN Server performs proxy authentication to the AAA server. The Easy VPN Remote device sends each authentication request to the Cisco 3000 Series VPN Concentrator.

PIX Firewall Version 6.3 or higher lets you use Media Access Control (MAC) addresses to bypass authentication for devices, such as Cisco IP Phones, that do not support this type of authentication. When MAC-based AAA exemption is enabled, the PIX Firewall bypasses the AAA server for traffic that matches both the MAC address of the device and the IP address that has been dynamically assigned by a DHCP server.

This feature, like IUA, is enabled or disabled on the Easy VPN Server. For information about enabling this feature on a PIX Firewall used as an Easy VPN Server, refer to the [“Bypassing AAA Authentication” section on page 8-5](#).

To configure this feature on a PIX Firewall used as an Easy VPN Remote device, refer to the [“Using MAC-Based AAA Exemption” section on page 3-13 in Chapter 3, “Controlling Network Access and Use.”](#)

Using X.509 Certificates

PIX Firewall Version 6.3 allows the use of IPsec Main Mode by providing RSA-SIG support for X.509 certificates.



Note

To establish a VPN tunnel using certificates, an Easy VPN Server using Cisco IOS software needs to be running IOS version 122-13.T1 or later. Earlier versions of Cisco IOS software do not support the XAUTH RSA-SIG policy that is required for using certificates to establish a VPN tunnel.

With previous versions of PIX Firewall used as an Easy VPN Remote, IPsec Aggressive Mode was required so that `vpngroup` to key mappings could be performed at the Easy VPN Server. With RSA-SIG support, this restriction no longer applies and IPsec Main Mode can be used. Aggressive Mode is used for pre-shared keys and Main Mode is used for RSA-SIG based key exchange.

With PIX Firewall Version 6.3, the default option is RSA-SIG. To use pre-shared keys, enter the following command:

```
vpnclient vpngroup groupname password preshared_key
```

PIX Firewall Version 6.3 introduces additional encryption options for use by the Easy VPN Remote. These include Advanced Encryption Standard (AES) and Diffie-Hellman Group 5. Use of these protocols is determined by licensing (3DES, AES) and the use of Main Mode or Aggressive Mode. Diffie-Hellman groups are negotiable only in Main Mode.



Note

A PIX Firewall used as an Easy VPN Remote device does not check to determine if the certificate of the Easy VPN Server is revoked.

PIX Firewall Version 6.3 introduces optional X.500 support. The certificate enrollment process is enhanced to configure X.500 directory content.

To configure X.500 directory content, enter the following command:

```
ca subject-name ca-nickname [x500_DN]
```

You can either enter the full X.500 distinguished name (DN) or if this parameter is omitted, the PIX Firewall prompts you for the required information.

For example, the following command includes the DN:

```
pixfirewall(config)# ca subject-name cn=pixfirewall.example.com,ou=VSEC BU,o=Cisco
System,c=US,e=klee@example.com
```

The following command omits the DN, and as a result the PIX Firewall prompts for this information:

```
pixfirewall(config)# ca subject-name
Common name (cn) [pixfirewall.example.com] :pixfirewall.example.com
Department (ou) []: VSEC BU
Company(o) []:Cisco System
State (st) []:CA
Country (c) []:US
Email (e) []:klee@example.com
Proceed with the above information [no]: yes
```

To display information about the current certification configuration, enter the following command:

```
pixfirewall(config)# show ca cert
...(PIX device cert)
Certificate
  Status: Available
  Certificate Serial Number: 45a490250000000000fa
  Key Usage: General Purpose
  Subject Name:
    CN = myvpn01.example.com
    OU = VSEC BU
    O = Cisco System INC
    UNSTRUCTURED NAME = myvpn01.example.com
  Validity Date:
    start date: 22:35:58 UTC Aug 16 2002
    end date: 22:45:58 UTC Aug 16 2003
```

Verifying the DN of an Easy VPN Server

PIX Firewall Version 6.3, when used as an Easy VPN Remote device, lets you specify the DN of the certificate used to establish a VPN tunnel. We recommend enabling this feature to prevent a possible “man-in-the-middle” attack.

To verify the DN of the certificate received by your PIX Firewall, enter the following command:

```
ca verifycertdn x500 string
```



Note

Every attribute must match exactly to verify the certificate received and to establish a VPN tunnel.

For example, a PIX Firewall used as an Easy VPN Remote Server might have the following certificate:

```
Certificate
  Status: Available
  Certificate Serial Number: 4ebdbd400000000000a2
  Key Usage: General Purpose
  Subject Name:
    CN = myvpn01.myorg.com
    OU = myou
    O = myorg
    ST = CA
    C = US
    UNSTRUCTURED NAME = myvpn01.myorg.com
  Validity Date:
    start date: 23:48:00 UTC Feb 18 2003
```



```
end date: 23:58:00 UTC Feb 18 2004
```

To establish a VPN tunnel with this server, enter the following command on the PIX Firewall used as an Easy VPN Remote device:

```
ca verifycertdn cn*myvpn, ou=myou, o=myorg, st=ca, c=US
```

This command causes the receiving PIX Firewall to accept certificates with any DN having the following attributes:

- Common Name (CN) containing the string *myvpn*
- Organizational Unit (OU) equal to *myou*
- Organization (O) equal to *myorg*
- State (ST) equal to *CA*
- Country (C) equal to *US*

You could be more restrictive by identifying a specific common name, or less restrictive by omitting the CN attribute altogether.

You can use an asterisk (*) to match an attribute containing the string following the asterisk. Use an exclamation mark (!) to match an attribute that does not contain the characters following the exclamation mark.

Using the PIX Firewall PPPoE Client

This section describes how to use the PPPoE client provided with PIX Firewall Version 6.2 and higher. It includes the following topics:

- [Overview, page 4-11](#)
- [Configuring the PPPoE Client Username and Password, page 4-12](#)
- [Enabling PPPoE on the PIX Firewall, page 4-13](#)
- [Using PPPoE with a Fixed IP Address, page 4-13](#)
- [Monitoring and Debugging the PPPoE Client, page 4-14](#)
- [Using Related Commands, page 4-15](#)

Overview

Point-to-Point Protocol over Ethernet (PPPoE) combines two widely accepted standards, Ethernet and PPP, to provide an authenticated method of assigning IP addresses to client systems. PPPoE clients are typically personal computers connected to an ISP over a remote broadband connection, such as DSL or cable service. ISPs deploy PPPoE because it supports high-speed broadband access using their existing remote access infrastructure and because it is easier for customers to use.

PIX Firewall Version 6.2 introduces PPPoE client functionality. This allows small office, home office (SOHO) users of the PIX Firewall to connect to ISPs using DSL modems.

**Note**

The PIX Firewall PPPoE client can only be enabled on the outside interface.

PPPoE provides a standard method of employing the authentication methods of the Point-to-Point Protocol (PPP) over an Ethernet network. When used by ISPs, PPPoE allows authenticated assignment of IP addresses. In this type of implementation, the PPPoE client and server are interconnected by Layer 2 bridging protocols running over a DSL or other broadband connection.

PPPoE is composed of two main phases:

- **Active Discovery Phase**—In this phase, the PPPoE client locates a PPPoE server, called an access concentrator. During this phase, a Session ID is assigned and the PPPoE layer is established.
- **PPP Session Phase**—In this phase, PPP options are negotiated and authentication is performed. Once the link setup is completed, PPPoE functions as a Layer 2 encapsulation method, allowing data to be transferred over the PPP link within PPPoE headers.

At system initialization, the PPPoE client establishes a session with the access concentrator by exchanging a series of packets. Once the session is established, a PPP link is set up, which includes authentication using Password Authentication protocol (PAP). Once the PPP session is established, each packet is encapsulated in the PPPoE and PPP headers.

Configuring the PPPoE Client Username and Password

To configure the username and password used to authenticate the PIX Firewall to the access concentrator, use the PIX Firewall **vpdn** command. The **vpdn** command is used to enable remote access protocols, such as L2TP, PPTP, and PPPoE. To use the **vpdn** command, you first define a VPDN group and then create individual users within the group.

To configure a PPPoE username and password, perform the following steps:

Step 1 Define the VPDN group to be used for PPPoE, by entering the following command:

```
vpdn group group_name request dialout pppoe
```

In this command, replace *group_name* with a descriptive name for the group, such as “pppoe-sbc.”

Step 2 If your ISP requires authentication, select an authentication protocol by entering the following command:

```
vpdn group group_name ppp authentication PAP|CHAP|MSCHAP
```

Replace *group_name* with the same group name you defined in the previous step. Enter the appropriate keyword for the type of authentication used by your ISP:

- **PAP**—Password Authentication Protocol
- **CHAP**—Challenge Handshake Authentication Protocol
- **MS-CHAP**—Microsoft Challenge Handshake Authentication Protocol



Note When using CHAP or MS-CHAP, the username may be referred to as the remote system name, while the password may be referred to as the CHAP secret.

Step 3 Associate the username assigned by your ISP to the VPDN group by entering the following command:

```
vpdn group group_name localname username
```

Replace *group_name* with the VPDN group name and *username* with the username assigned by your ISP.

Step 4 Create a username and password pair for the PPPoE connection by entering the following command:

```
vpdn username username password pass [store-local]
```

Replace *username* with the username and *pass* with the password assigned by your ISP.



Note

The **store-local** option stores the username and password in a special location of NVRAM on the PIX Firewall. If an Auto Update Server sends a **clear config** command to the PIX Firewall and the connection is then interrupted, the PIX Firewall can read the username and password from NVRAM and re-authenticate to the Access Concentrator.

Enabling PPPoE on the PIX Firewall



Note

You must complete the configuration using the **vpdn** command, described in “[Configuring the PPPoE Client Username and Password](#),” before enabling PPPoE.

The PPPoE client functionality is turned off by default. To enable the PPPoE client, enter the following command.

```
ip address ifName pppoe [setroute]
```

Reenter this command to clear and restart the PPPoE session. The current session will be shut down and a new one will be restarted.

For example:

```
ip address outside pppoe
```

The PPPoE client is only supported on the outside interface of the PIX Firewall. PPPoE is not supported in conjunction with DHCP because with PPPoE the IP address is assigned by PPP. The **setroute** option causes a default route to be created if no default route exists. The default router will be the address of the access concentrator. The maximum transmission unit (MTU) size is automatically set to 1492 bytes, which is the correct value to allow PPPoE transmission within an Ethernet frame.

Using PPPoE with a Fixed IP Address

You can also enable PPPoE by manually entering the IP address, using the command in the following format:

```
ip address ifname ipaddress mask pppoe
```

This command causes the PIX Firewall to use the specified address instead of negotiating with the PPPoE server to assign an address dynamically. To use this command, replace *ifname* with the name of the outside interface of the PIX Firewall connected to the PPPoE server. Replace *ipaddress* and *mask* with the IP address and subnet mask assigned to your PIX Firewall.

For example:

```
ip address outside 201.n.n.n 255.255.255.0 pppoe
```

Note

The **setroute** option is an option of the **ip address** command that you can use to allow the access concentrator to set the default routes when the PPPoE client has not yet established a connection. When using the **setroute** option, you cannot have a statically defined route in the configuration.

Monitoring and Debugging the PPPoE Client

Use the following command to display the current PPPoE client configuration information:

```
show ip address outside pppoe
```

Use the following command to enable debugging for the PPPoE client:

```
[no] debug pppoe event | error | packet
```

The following summarizes the function of each keyword:

- **event**—Displays protocol event information
- **error**—Displays error messages
- **packet**—Displays packet information

Use the following command to view the status of PPPoE sessions:

```
show vpdn session [l2tp|pptp|pppoe] [id sess_id|packets|state|window]
```

[Example 4-1](#) shows the kind of information provided by this command.

Example 4-1 show vpdn session Command Output

```
pix1# sh vpdn
Tunnel id 0, 1 active sessions
    time since change 65862 secs
    Remote Internet Address 10.0.0.1
    Local Internet Address 199.99.99.3
    6 packets sent, 6 received, 84 bytes sent, 0 received
Remote Internet Address is 10.0.0.1
    Session state is SESSION_UP
    Time since event change 65865 secs, interface outside
    PPP interface id is 1
    6 packets sent, 6 received, 84 bytes sent, 0 received
pix1#
pix1# sh vpdn session
PPPoE Session Information (Total tunnels=1 sessions=1)
Remote Internet Address is 10.0.0.1
    Session state is SESSION_UP
    Time since event change 65887 secs, interface outside
    PPP interface id is 1
    6 packets sent, 6 received, 84 bytes sent, 0 received
pix1#
pix1# sh vpdn tunnel
```

```
PPPoE Tunnel Information (Total tunnels=1 sessions=1)
Tunnel id 0, 1 active sessions
  time since change 65901 secs
  Remote Internet Address 10.0.0.1
  Local Internet Address 199.99.99.3
  6 packets sent, 6 received, 84 bytes sent, 0 received
pixl#
```

Using Related Commands

Use the following **vpdn** command to set the PPP parameters used during the PPP session:

```
vpdn group group_name ppp authentication [PAP|CHAP|MSCHAP]
```

Use the following command to cause the DHCP server to use the WINS and DNS addresses provided by the access concentrator as part of the PPP/PCP negotiations:

```
dhcpcd auto_config [client_ifx_name]
```

This command is only required if the service provider provides this information as described in RFC 1877. The *client_ifx_name* parameter identifies the interface supported by the DHCP **auto_config** option. At this time, this keyword is not required because the PPPoE client is only supported on a single outside interface.

Using the PIX Firewall DHCP Server

This section describes how to use the DHCP server provided by the PIX Firewall. It includes the following topics:

- [Overview, page 4-15](#)
- [Configuring the DHCP Server Feature, page 4-17](#)
- [Using Cisco IP Phones with a DHCP Server, page 4-19](#)

Overview

PIX Firewall supports Dynamic Host Configuration Protocol (DHCP) servers and DHCP clients. DHCP is a protocol that supplies automatic configuration parameters to Internet hosts. This protocol has two components:

- Protocol for delivering host-specific configuration parameters from a DHCP server to a host (DHCP client)
- Mechanism for allocating network addresses to hosts

A DHCP server is simply a computer that provides configuration parameters to a DHCP client, and a DHCP client is a computer or network device that uses DHCP to obtain network configuration parameters.

As a DHCP server, the PIX Firewall provides network configuration parameters, including dynamically assigned IP addresses, to DHCP clients. These configuration parameters provide a DHCP client the networking parameters required to access an enterprise network and network services, such as DNS.

[Table 4-2](#) lists the number of DHCP clients that can be supported concurrently by different models and versions of the PIX Firewall.

Table 4-2 DHCP Clients Supported by PIX Firewall

PIX Firewall Version	PIX Firewall Platform	Maximum Number of DHCP Client Addresses (Active Hosts)
Version 5.2 and earlier	All platforms	10
Version 5.3 to Version 6.0	PIX 506/506E	32
	All other platforms	256
Version 6.1 and 6.2	PIX 501	32
	PIX 501 with optional 50-user license	128
	PIX 506/506E	256
	All other platforms	256
Version 6.3 and higher	PIX 501	32
	PIX 501 with optional 50-user license	128
	PIX 501 with optional unlimited license	256
	PIX 506/506E	256
	All other platforms	256 per interface

**Note**

A host is considered active when the host has passed traffic through the PIX Firewall within the number of seconds currently configured for the xlate timeout interval. It is also considered active if it has an established NAT/PAT through the PIX Firewall, or it has an established TCP connection or UDP session through the PIX Firewall, or it has an established user authentication through the PIX Firewall.

You cannot configure a DHCP server for 256 clients, using a Class C netmask. For example, if a company has a Class C network address of 172.17.1.0 with netmask 255.255.255.0, then 172.17.1.0 (network IP) and 172.17.1.255 (broadcast) cannot be in the DHCP address pool range. Further, one address is used up for the PIX Firewall interface. Thus, if a user uses a Class C netmask, they can only have up to 253 DHCP Clients.

**Note**

The PIX Firewall DHCP server does not support BOOTP requests. The current version of the DHCP server also does not support failover configurations.

The PIX Firewall commands used to implement the DHCP server feature are described in the **dhcpcd** command page and the **debug** command page in the *Cisco PIX Firewall Command Reference*. Refer to these command pages for more information.

Configuring the DHCP Server Feature

Be sure to configure the IP address and the subnet mask of the interface using the **ip address** command prior to enabling the DHCP server feature.

**Note**

With PIX Firewall Version 6.3 and higher, the DHCP server can be enabled on any interface. With earlier versions, the DHCP server can only be enabled on the inside interface.

Follow these steps to enable the DHCP server feature on a given PIX Firewall interface:

- Step 1** Specify a DHCP address pool using the **dhcpcd address** command. The PIX Firewall will assign to a client one of the addresses from this pool to use for a given length of time.

For example:

```
dhcpcd address 10.0.1.101-10.0.1.110 inside
```

**Note**

When using Network Extension Mode, do *not* enable the DHCP server on the inside interface. Also, in Network Extension Mode, the following two steps (Step 2 and Step 3) are not required because the DNS and WINS information is part of the policy that is downloaded from the Easy VPN Server.

- Step 2** (Optional) If you are using client mode, specify the IP address(es) of the DNS server(s) the client will use. You can specify up to two DNS servers.

For example:

```
dhcpcd dns 209.165.201.2 209.165.202.129
```

- Step 3** (Optional) If you are using client mode, specify the IP address(es) of the WINS server(s) the client will use. You can specify up to two WINS servers.

For example:

```
dhcpcd wins 209.165.201.5
```

- Step 4** (Optional) Specify the lease length to be granted to the client. This lease equals the amount of time (in seconds) the client can use its allocated IP address before the lease expires. The default value is 3600 seconds.

For example:

```
dhcpcd lease 3000
```

- Step 5** (Optional) Configure the domain name the client will use by entering the following command:

```
dhcpcd domain example.com
```

- Step 6** Enable the DHCP daemon within the PIX Firewall to listen for DHCP client requests on the enabled interface.

For example:

```
dhcpcd enable inside
```

- Step 7** (Optional) To display debugging information about the DHCP server, enter the following command:

```
debug dhcpcd event
debug dhcpcd packet
```

[Example 4-2](#) shows a configuration listing for the previous procedure:

Example 4-2 DHCP Server Configuration

```
! set the ip address of the inside interface
ip address inside 10.0.1.2 255.255.255.0
! configure the network parameters the client will use once in the corporate network and
dhcpcd address 10.0.1.101-10.0.1.110 inside
dhcpcd dns 209.165.201.2 209.165.202.129
dhcpcd wins 209.165.201.5
dhcpcd lease 3000
dhcpcd domain example.com
! enable dhcp server daemon on the inside interface
dhcpcd enable inside
```

The following example shows the configuration of a DHCP address pool and a DNS server address with the inside interface being enabled for the DHCP server feature:

```
dhcpcd address 10.0.1.100-10.0.1.108 inside
dhcpcd dns 209.165.200.227
dhcpcd enable inside
```

The following example shows the configuration of a DHCP address pool and uses the `auto_config` command to configure the dns, wins, and domain parameters:

```
dhcpcd address 10.0.1.100-10.0.1.108 inside
dhcpcd auto_config outside
dhcpcd enable inside
```

[Example 4-3](#) is a partial configuration example of the DHCP server and IPSec features configured on a PIX Firewall that is within a remote office. The PIX 506/506E unit's VPN peer is another PIX Firewall that has an outside interface IP address of 209.165.200.228 and functions as a gateway for a corporate network.

Example 4-3 Configuration for DHCP Server with IPSec

```
! configure interface ip address on the inside and outside interfaces
ip address outside 209.165.202.129 255.255.255.0
ip address inside 172.17.1.1 255.255.255.0
! configure ipsec with corporate pix
access-list ipsec-peer permit ip 172.17.1.0 255.255.255.0 192.168.0.0 255.255.255.0
ipsec transform-set myset esp-des esp-sha-hmac
crypto map mymap 10 ipsec-isakmp
crypto map mymap 10 match address ipsec-peer
crypto map mymap 10 set transform-set myset
crypto map mymap 10 set peer 209.165.200.228
```



```

crypto map mymap interface outside
sysopt connection permit-ipsec
nat (inside) 0 access-list ipsec-peer
isakmp policy 10 authentication preshare
isakmp policy 10 encryption des
isakmp policy 10 hash sha
isakmp policy 10 group 1
isakmp policy 10 lifetime 3600
isakmp key 12345678 address 0.0.0.0 netmask 0.0.0.0
isakmp enable outside
!configure dhcp server pool of addresses
dhcpd address 172.17.1.100-172.17.1.109 inside
dhcpd dns 192.168.0.20
dhcpd wins 192.168.0.10
dhcpd lease 3000
dhcpd domain example.com
! enable dhcp server on inside interface
dhcpd enable inside
! use outside interface ip as PAT global address
nat (inside) 1 0 0
global (outside) 1 interface

```

Using Cisco IP Phones with a DHCP Server

Enterprises with small branch offices implementing a Cisco IP Telephony VoIP solution typically implement Cisco CallManager at a central office to control Cisco IP Phones at small branch offices. This implementation allows centralized call processing, reduces the equipment required, and eliminates the administration of additional Cisco CallManager and other servers at branch offices.

Cisco IP Phones download their configuration from a TFTP server. When a Cisco IP Phone starts, if it does not have both the IP address and TFTP server IP address preconfigured, it sends a request with option 150 or 66 to the DHCP server to obtain this information.

- DHCP option 150 provides the IP addresses of a list of TFTP servers
- DHCP option 66, defined in RFC 2132 (DHCP Options and BOOTP Vendor Extensions), gives the IP address or the host name of a single TFTP server.

Cisco IP Phones may include both option 150 and 66 in a single request. In this case, the PIX Firewall DHCP server provides values for both options in the response if they are configured on the PIX Firewall.

Cisco IP Phones may also include DHCP option 3 in their requests. PIX Firewall Version 6.0(1) added support for this option, which lists the IP addresses of default routers.

PIX Firewall Version 6.2 and higher provides the following options for the **dhcpd** command:

```

dhcpd option 66 ascii server_name
dhcpd option 150 ip server_ip1 [server_ip2]

```

When using option 66, replace *server_name* with the TFTP host name. A single TFTP server can be identified using option 66.

When using option 150, replace *server_ip1* with the IP address of the primary TFTP server and replace *server_ip2* with the IP address of the secondary TFTP server. A maximum of two TFTP servers can be identified using option 150.

To disable option 66 or option 150, enter one of the following commands:

```

no dhcpd option 66
no dhcpd option 150

```

**Note**

With PIX Firewall Version 6.2 and lower, the DHCP server can only be enabled on the inside interface and therefore can only respond to DHCP option 150 and 66 requests from Cisco IP Phones or other network devices on the internal network. With PIX Firewall Version 6.3 and higher, the DHCP server can be enabled on any interface and with as many instances as required.

Using DHCP Relay

PIX Firewall Version 6.3 provides a DHCP relay agent. This allows the PIX Firewall to assist in dynamic configuration of IP device hosts on any Ethernet interface. Acting as a DHCP relay agent, when the PIX Firewall receives a request from a host on an interface, it forwards the request to a user-configured DHCP server on another interface.

With previous versions of PIX Firewall, hosts on the inside interfaces must be statically configured or use addresses provided by the PIX Firewall DHCP Server.

The following restrictions apply to the use of the DHCP relay agent:

- The relay agent accepts and responds to client requests on any interface.
- The relay agent cannot be enabled if the PIX Firewall DHCP server is enabled.
- The relay agent will forward requests if IPsec is configured. VPN negotiations will be initiated if a tunnel does not exist.
- Clients must be directly connected to the PIX Firewall and cannot send requests through another relay agent or a router.
- DHCP relay will not work in client mode.

**Note**

Some type of NAT must be specified to allow forwarding of a DHCP release message from a client to a DHCP server.

Use the following command to enable the DHCP relay agent:

```
[no] dhcprelay enable interface
```

Replace *interface* with the name of the interface connected to the DHCP clients.

Use the following command to configure a DHCP server address for the relay agent:

```
[no] dhcprelay server dhcp_server_ip server_ifc
```

Replace *dhcp_server_ip* with the IP address of the DHCP server. Replace *server_ifc* with the interface connected to the DHCP server. You can use this command to identify up to four servers.

By default, the default gateway used by the DHCP server is configured on the DHCP server. To specify the default gateway to be used by the DHCP server in the PIX Firewall configuration, enter the following command:

```
[no] dhcprelay setroute client_ifc
```

Replace *client_ifc* with the PIX Firewall interface to be used as the default gateway by DHCP clients for reaching the DHCP server.

To set the timeout, use the following command:

```
[no] dhcprelay timeout seconds
```

Replace *seconds* with the number of seconds allowed for relay address negotiation.

You can use the following commands to display debugging information for the DHCP Relay Agent:

```
Debug dhcprelay event
Debug dhcprelay error
Debug dhcprelay packet
```

Using the PIX Firewall DHCP Client

This section describes how to enable and manage the DHCP client on a PIX Firewall. It includes the following topics:

- [Overview, page 4-21](#)
- [Configuring the DHCP Client, page 4-21](#)
- [Releasing and Renewing the DHCP Lease, page 4-22](#)
- [Monitoring and Debugging the DHCP Client, page 4-22](#)

Overview

DHCP client support within the PIX Firewall is designed for use within a small office, home office (SOHO) environment using a PIX Firewall that is directly connected to a DSL or cable modem that supports the DHCP server function.

**Note**

The PIX Firewall DHCP client can only be enabled on the outside interface.

With the DHCP client feature enabled on a PIX Firewall, the PIX Firewall functions as a DHCP client to a DHCP server allowing the server to configure the outside interface with an IP address, subnet mask, and optionally a default route. Use of the DHCP client feature to acquire an IP address from a generic DHCP server is not supported. Also, the PIX Firewall DHCP client does not support **failover** configurations.

The DHCP-acquired IP address on the outside interface can also be used as the PAT global address. This makes it unnecessary for the ISP to assign a static IP address to the PIX Firewall. Use the **global** command with the **interface** keyword to enable PAT to use the DHCP-acquired IP address of outside interface. For more information about the **global** command, see the **global** command page in the *Cisco PIX Firewall Command Reference*.

Configuring the DHCP Client

To enable the DHCP client feature on a given PIX Firewall interface and set the default route via the DHCP server, enter the following command:

```
ip address outside dhcp [setroute] [retry retry_cnt]
```

The **ip address dhcp** command enables the DHCP client feature on the outside PIX Firewall interface. The optional **setroute** argument tells the PIX Firewall to set the default route using the default gateway parameter the DHCP server returns. If the **setroute** argument is configured, the **show route** command displays the default route set by the DHCP server.

**Note**

Do not configure the PIX Firewall with a default route when using the **setroute** argument of the **ip address dhcp** command.

Releasing and Renewing the DHCP Lease

To view current information about the DHCP lease, enter the following command:

```
show ip address dhcp
```

To release and renew the DHCP lease from the PIX Firewall, reenter the **ip address** command, as follows:

```
ip address outside dhcp [setroute] [retry retry_cnt]
```

Replace *retry_cnt* with the number of times the request should be issued before terminating. To clear the DHCP default route, use the **clear route static** command.

**Note**

The **clear ip** command can be also used to release and renew the DHCP lease, but this clears the configuration of every PIX Firewall interface.

Monitoring and Debugging the DHCP Client

The following commands provide debugging tools for the DHCP client feature:

- **debug dhcpc packet**
- **debug dhcpc detail**
- **debug dhcpc error**

The PIX Firewall commands used to debug the DHCP client are described in the **debug** command pages in the *Cisco PIX Firewall Command Reference*. Refer to these command pages for more information.



Configuring Application Inspection (Fixup)

This chapter describes how to use and configure application inspection, which is often called “fixup” because you use the **fixup** command to configure it. This chapter includes the following sections:

- [How Application Inspection Works, page 5-1](#)
- [Using the fixup Command, page 5-4](#)
- [Basic Internet Protocols, page 5-6](#)
- [Voice Over IP, page 5-14](#)
- [Multimedia Applications, page 5-27](#)
- [Database and Directory Support, page 5-30](#)
- [Management Protocols, page 5-33](#)

How Application Inspection Works

The Adaptive Security Algorithm (ASA), used by the PIX Firewall for stateful application inspection, ensures the secure use of applications and services. Some applications require special handling by the PIX Firewall application inspection function. Applications that require special application inspection functions are those that embed IP addressing information in the user data packet or open secondary channels on dynamically assigned ports.

The application inspection function works with NAT to help identify the location of embedded addressing information. This allows NAT to translate these embedded addresses and to update any checksum or other fields that are affected by the translation.

The application inspection function also monitors sessions to determine the port numbers for secondary channels. Many protocols open secondary TCP or UDP ports to improve performance. The initial session on a well-known port is used to negotiate dynamically assigned port numbers. The application inspection function monitors these sessions, identifies the dynamic port assignments, and permits data exchange on these ports for the duration of the specific session.

As illustrated in [Figure 5-1](#), ASA uses three databases for its basic operation:

- Access control lists (ACLs)—Used for authentication and authorization of connections based on specific networks, hosts, and services (TCP/UDP port numbers).
- Inspections—Contains a static, pre-defined set of application-level inspection functions.
- Connections (XLATE and CONN tables)—Maintains state and other information about each established connection. This information is used by ASA and cut-through proxy to efficiently forward traffic within established sessions.

Figure 5-1 Basic ASA Operations

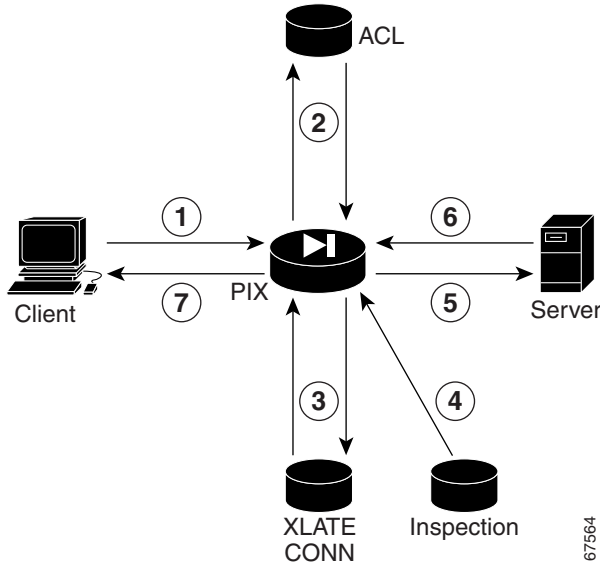

In Figure 5-1, operations are numbered in the order they occur, and are described as follows:

1. A TCP SYN packet arrives at the PIX Firewall to establish a new connection.
2. The PIX Firewall checks the access control list (ACL) database to determine if the connection is permitted.
3. The PIX Firewall creates a new entry in the connection database (XLATE and CONN tables).
4. The PIX Firewall checks the Inspections database to determine if the connection requires application-level inspection.
5. After the application inspection function completes any required operations for the packet, the PIX Firewall forwards the packet to the destination system.
6. The destination system responds to the initial request.
7. The PIX Firewall receives the reply packet, looks up the connection in the connection database, and forwards the packet because it belongs to an established session.

The default configuration of the PIX Firewall includes a set of application inspection entries that associate supported protocols with specific TCP or UDP port numbers and that identify any special handling required. The inspection function does not support NAT or PAT for certain applications because of the constraints imposed by the applications. You can change the port assignments for some applications, while other applications have fixed port assignments that you cannot change. Table 5-1 summarizes this information about the application inspection functions provided with PIX Firewall Version 6.2 and higher.

Table 5-1 Application Inspection Functions

Application	PAT?	NAT (1-1)?	Configure?	Default Port	Standards	Limitations/Comments
CTIQBE	Yes	Yes	Yes	TCP/2748	—	Introduced with PIX Firewall Version 6.3
CU-SeeMe	No	No	No	UDP/7648	—	None.
DNS ¹	Yes	Yes	No	UDP/53	RFC 1123	Only forward NAT. No PTR records are changed.

Table 5-1 Application Inspection Functions (continued)

Application	PAT?	NAT (1-1)?	Configure?	Default Port	Standards	Limitations/Comments
FTP	Yes	Yes	Yes	TCP/21	RFC 1123	None.
H.323	PIX Firewall Version 6.2 and higher	Yes	Yes	TCP/1720 UDP/1718 UDP (RAS) 1718-1719	ITU-T H.323, H.245, H.225.0, Q.931, Q.932	None. Support for Version 3 and 4 introduced with PIX Firewall Version 6.3. Does not support segmented messages.
HTTP	Yes	Yes	Yes	TCP/80	RFC 2616	Beware of MTU limitations when stripping ActiveX and Java. ²
ICMP	Yes	Yes	No	—	—	None.
ILS (LDAP)	Yes	Yes	Yes	—	—	Introduced in PIX Firewall Version 6.2.
MGCP	No	No	Yes	2427, 2727	RFC2705bis-05	Introduced with PIX Firewall Version 6.3.
NBDS / UDP	Yes	Yes	No	UDP/138	—	None.
NBNS / UDP	No	No	No	UDP/137	—	No WINS support.
NetBIOS over IP ³	No	No	No	—	—	None.
PPTP	Yes	Yes	Yes	1723	RFC2637	Introduced with PIX Firewall Version 6.3.
RSH	Yes	Yes	Yes	TCP/514	Berkeley UNIX	None.
RTSP	No	No	Yes	TCP/554	RFC 2326, RFC 2327, RFC 1889	No handling for HTTP cloaking.
SIP	PIX Firewall Version 6.2 or higher	Yes	Yes	TCP/5060 UDP/5060	RFC 2543	None.
SKINNY (SCCP)	PIX Firewall Version 6.3	Yes	Yes	TCP/2000	—	Does not handle TFTP uploaded Cisco IP Phone configurations under certain circumstances.
SMTP	Yes	Yes	Yes	TCP/25	RFC 821, 1123	None.
SNMP	Yes	Yes	Yes	UDP/161-162	—	Introduced with PIX Firewall 6.3.4
SQL*Net	Yes	Yes	Yes	TCP/1521 (v.1)	—	V.1 and v.2.
Sun RPC	No	No	No	UDP/111 TCP/111	—	Payload not NATed.
VDO LIVE	No	Yes	No	TCP/7000	—	None.
Windows Media	No	Yes	No	TCP/1755	—	Can stream Netshow over HTTP, TCP or UDP.
XDCMP	No	No	No	UDP/117	—	None.

1. No NAT support is available for name resolution through WINS.
2. If the MTU is too small to allow the Java or ActiveX tag to be included in one packet, stripping may not occur.
3. NetBIOS is supported by performing NAT of the packets for NBNS UDP port 137 and NBDS UDP port 138.

Using the fixup Command

You can use the **fixup** command to change the default port assignments or to enable or disable application inspection for the following protocols and applications:

- CTIQBE (disabled by default)
- DNS
- ESP-IKE (disabled by default)
- FTP
- H.323
- HTTP
- ILS
- MGCP (disabled by default)
- PPTP (disabled by default)
- RSH
- RTSP
- SIP
- SKINNY (SCCP)
- SMTP
- SNMP
- SQL*Net
- TFTP

The basic syntax for the **fixup** command is as follows:

```
[no] fixup protocol [protocol] [port]
```

To change the default port assignment, identify the protocol and the new port number to assign. Use the **no fixup protocol** command to reset the application inspection entries to the default configuration.



Note

Disabling or modifying application inspection only affects connections that are initiated after the command is processed. Disabling application inspection for a specific port or application does not affect existing connections. If you want the change to take effect immediately, enter the **clear xlate** command to remove all existing application inspection entries. If there are no **xlates**, such as **nat 0 access-list**, use **clear local-host** instead of **clear xlate** to disable or modify application inspection.

The following is the detailed syntax of the **fixup** command showing the syntax for each configurable application:

```
fixup protocol ctiqbe 2748 | dns [maximum-length max-len] | esp-ike | ftp [strict] [port] |
http [port[-port]] | h323 h225 | ras [port[-port]] | ils [port[-port]] | mgcp
[port[-port]] | pptp 1723 | rsh [514] | rtsp [port] | sip udp [port] | skinny [port] | smtp
[port[-port]] | sqlnet [port[-port]]
```

You can view the explicit (configurable) **fixup protocol** settings with the **show fixup** command. The default settings for configurable protocols are as follows.

```
pixHA(config)# sh fix
fixup protocol dns maximum-length 512
fixup protocol ftp 21
fixup protocol h323 h225 1720
fixup protocol h323 ras 1718-1719
fixup protocol http 80
fixup protocol rsh 514
fixup protocol rtsp 554
fixup protocol sip 5060
fixup protocol sip udp 5060
fixup protocol skinny 2000
fixup protocol smtp 25
fixup protocol sqlnet 1521
fixup protocol tftp 69
pixHA(config)#
```

The **show fixup protocol protocol** command displays the configuration for an individual protocol.

The following are other related commands that let you manage fixup configuration:

- **show conn state**—Displays the connections with the state of the designated protocol
- **show timeout**—Displays the timeout value of the designated protocol

The **clear fixup** command removes **fixup** commands from the configuration that you added. It does not remove the default **fixup protocol** commands.

You can disable the fixup of a protocol by removing all fixups of the protocol from the configuration using the **no fixup** command. After you remove all fixups for a protocol, the **no fixup** form of the command or the default port is stored in the configuration.

For some applications, you can define multiple port assignments. This is useful when multiple instances of the same service are running on different ports.

The following example shows how to define multiple ports for FTP by entering separate commands:

```
fixup protocol ftp 2100
fixup protocol ftp 4254
fixup protocol ftp 9090
```

These commands do not change the standard FTP port assignment (21). After entering these commands, the PIX Firewall listens for FTP traffic on port 21, 2100, 4254, and 9090.

Some protocols let you assign a range of ports. This is indicated in the command syntax as port[-port]. For example, the first command example assigns the port range from 1500 to 2000 to SQL*Net. The second command example shows a smaller port range 161 to 162 for SNMP.

```
fixup protocol sqlnet 1500-2000
fixup protocol snmp 161-162
```

**Note**

If you enter a new port assignment for protocols that do not allow multiple port assignments, the value overrides the default value.

Basic Internet Protocols

This section describes how the PIX Firewall supports the most common Internet protocols and how you can use the **fixup** command and other commands to solve specific problems. It includes the following topics:

- [DNS, page 5-6](#)
- [FTP, page 5-7](#)
- [HTTP, page 5-9](#)
- [ICMP, page 5-9](#)
- [IPSec, page 5-9](#)
- [PPTP, page 5-10](#)
- [SMTP, page 5-11](#)
- [TFTP, page 5-11](#)

DNS

The port assignment for the Domain Name System (DNS) is not configurable. DNS requires application inspection so that DNS queries will not be subject to the generic UDP handling based on activity timeouts. Instead, the UDP connections associated with DNS queries and responses are torn down as soon as a reply to a DNS query has been received. This functionality is called DNS Guard.

DNS inspection performs the following tasks:

- Monitors the message exchange to ensure that the ID of the DNS reply matches the ID of the DNS query.
- Translates the DNS A-record on behalf of the **alias** command. With PIX Firewall Version 6.2 and higher, DNS inspection also supports static and dynamic NAT and outside NAT makes the use of the **alias** command unnecessary.
- Reassembles the DNS packet to verify its length. Since DNS packets up to 65535 bytes are permitted to traverse the PIX Firewall, reassembly is done to verify that the packet length is less than the maximum length specified by the user. Otherwise, the packet is dropped.

Only forward lookups are NATed, so PTR records are not touched. Alarms can also be set off in the Intrusion Detection System (IDS) module for DNS zone transfers.



Note

The PIX Firewall drops DNS packets sent to UDP port 53 that are larger than the configured maximum length. The default value is 512 bytes.



Note

If the DNS fixup is disabled, the A-record is not NATed and the DNS ID is not matched in requests and responses. By disabling the DNS fixup, the maximum length check on UDP DNS packets can be bypassed and packets greater than the maximum length configured will be permitted. However, fragmented DNS packets will not go through since reassembling is done only if the fixup is turned on.

PIX Firewall Version 6.2 introduces full support for NAT and PAT of DNS messages originating from either inside (more secure) or outside (less secure) interfaces. This means that if a client on an inside network requests DNS resolution of an inside address from a DNS server on an outside interface, the DNS A-record is translated correctly.

For example, in [Figure 5-2](#), a client on the inside network issues an HTTP request to server 192.168.100.1, using its host name server.example.com. The address of this server is mapped through PAT to a single ISP-assigned address 209.165.200.5. The DNS server resides on the ISP network.

Figure 5-2 NAT/PAT of DNS Messages

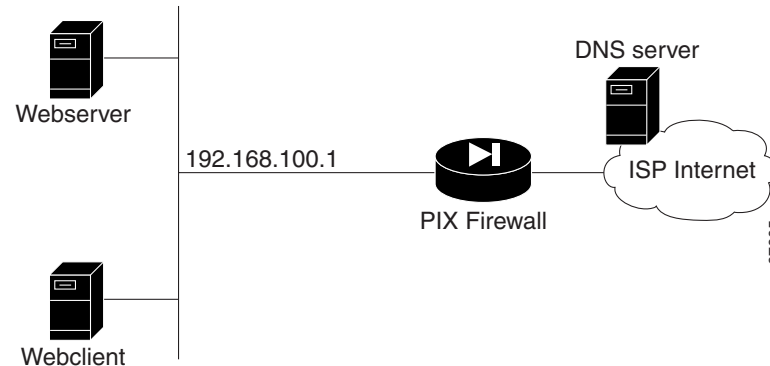

When the request is made to the DNS server, the PIX Firewall translates the non-routable source address in the IP header and forwards the request to the ISP network on its outside interface. When the DNS A-record is returned, the PIX Firewall applies address translation not only to the destination address, but also to the embedded IP address of the web server. This address is contained in the user data portion of the DNS reply packet. As a result, the web client on the inside network gets the address it needs to connect to the web server on the inside network.

The transparent support for DNS in PIX Firewall Version 6.2 and higher means that the same process works if the client making the DNS request is on a DMZ (or other less secure) network and the DNS server is on an inside (or other more secure) interface.

FTP

You can use the **fixup** command to change the default port assignment for the File Transfer Protocol (FTP). The command syntax is as follows:

```
[no] fixup protocol ftp [strict] [port]
```

The **port** parameter lets you configure the port at which the PIX Firewall listens for FTP traffic.

The **strict** option prevents web browsers from sending embedded commands in FTP requests. Each **ftp** command must be acknowledged before a new command is allowed. Connections sending embedded commands are dropped. The **strict** option only lets an FTP server generate the 227 command and only lets an FTP client generate the PORT command. The 227 and PORT commands are checked to ensure they do not appear in an error string.

If you disable FTP fixups with the **no fixup protocol ftp** command, outbound users can start connections only in passive mode, and all inbound FTP is disabled.



Note

The use of the **strict** option may break FTP clients that do not comply with the RFC standards.

The FTP application inspection inspects the FTP sessions and performs four tasks:

- Prepares dynamic secondary data connection
- Tracks **ftp** command-response sequence
- Generates an audit trail
- NATs embedded IP address

FTP application inspection prepares secondary channels for FTP data transfer. The channels are allocated in response to a file upload, a file download, or a directory listing event and must be pre-negotiated. The port is negotiated through the PORT or PASV commands.

If the **strict** option is enabled, each **ftp** command and response sequence is tracked for the following anomalous activity:

- Truncated command—Number of commas in the PORT and PASV reply command is checked to see if it is five. If it is not five, then the PORT command is assumed to be truncated and the TCP connection is closed.
- Incorrect command—Checks the **ftp** command to see if it ends with <CR><LF> characters, as required by the RFC. If it does not, the connection is closed.
- Size of RETR and STOR commands—These are checked against a fixed constant. If the size is greater, then an error message is logged and the connection is closed.
- Command spoofing—The PORT command should always be sent from the client. The TCP connection is denied if a PORT command is sent from the server.
- Reply spoofing—PASV reply command (227) should always be sent from the server. The TCP connection is denied if a PASV reply command is sent from the client. This prevents the security hole when the user executes “227 xxxxx a1, a2, a3, a4, p1, p2.”
- TCP stream editing.
- Invalid port negotiation—The negotiated dynamic port value is checked to see if it is less than 1024. As port numbers in the range from 1 to 1024 are reserved for well-known connections, if the negotiated port falls in this range, then the TCP connection is freed.
- Command pipelining—The number of characters present after the port numbers in the PORT and PASV reply command is cross checked with a constant value of 8. If it is more than 8, then the TCP connection is closed.

FTP application inspection generates the following log messages:

- An Audit record 302002 is generated for each file that is retrieved or uploaded.
- The **ftp** command is checked to see if it is RETR or STOR and the retrieve and store commands are logged.
- The username is obtained by looking up a table providing the IP address.
- The username, source IP address, destination IP address, NAT address, and the file operation are logged.
- Audit record 201005 is generated if the secondary dynamic channel preparation failed due to memory shortage.

In conjunction with NAT, the FTP application inspection translates the IP address within the application payload. This is described in detail in RFC 959.

HTTP

You can use the **fixup** command to change the default port assignment for the Hypertext Transfer Protocol (HTTP). The command syntax is as follows.

```
fixup protocol http [port[-port]]
```

Use the *port* option to change the default port assignments from 80. Use the *-port* option to apply HTTP application inspection to a range of port numbers.

**Note**

The **no fixup protocol http** command statement also disables the **filter url** command.

HTTP inspection performs several functions:

- URL logging of GET messages
- URL screening via N2H2 or Websense
- Java and ActiveX filtering

The latter two features are described in “[Filtering Outbound Connections](#)” in [Chapter 3, “Controlling Network Access and Use.”](#)

ICMP

PIX Firewall Version 6.3 introduces support for NAT of ICMP error messages. NAT for ICMP is disabled by default. When this feature is enabled, the PIX Firewall creates xlates for intermediate hops that send ICMP error messages, based on the static/NAT configuration. The PIX Firewall overwrites the packet with the translated IP addresses.

To enable this feature, use the following command:

```
[no] fixup protocol icmp error
```

When disabled (as is the case with any version before 6.3), the PIX Firewall does not create xlates for intermediate nodes that generate ICMP error messages. ICMP error messages generated by the intermediate nodes between the inside host and the PIX Firewall reach the outside host without consuming any additional NAT resource. This is undesirable when an outside host uses the **traceroute** command to trace the hops to the destination on the inside of the PIX Firewall. When the PIX Firewall does not NAT the intermediate hops, all the intermediate hops appear with the translated destination IP address.

IPSec

PIX Firewall Version 6.3 provides improved support for application inspection of Encapsulating Security Payload (ESP) and for using IPSec with NAT.

ESP is an IPSec protocol that provides data confidentiality, data integrity, and protection services, optional data origin authentication, and anti-replay services. ESP encapsulates the data to be protected.

However, because ESP packets do not identify the ports that are involved, PAT is performed by assigning port 0 (zero). Only one ESP tunnel is supported at a time. Also, when the PIX Firewall has this feature enabled, it cannot terminate VPN tunnels in relation to other IPSec peers.

Application inspection of ESP traffic is disabled by default. To enable this feature, enter the following command:

```
fixup protocol esp-ike
```

When this feature is enabled, PIX Firewall preserves the IKE source port. Support is not provided for the following:

- ESP tunnel serialization
- SPI matching
- Recording of SPIs for each ESP connection

PPTP

The Point-to-Point Tunneling Protocol (PPTP) is a protocol for tunneling PPP traffic. A PPTP session is composed of one TCP channel and usually two PPTP GRE tunnels. The TCP channel is the control channel used for negotiating and managing the PPTP GRE tunnels. The GRE tunnels carries PPP sessions between the two hosts.

As described in RFC 2637, the PPTP protocol is mainly used for the tunneling of PPP sessions initiated from a modem bank PAC (PPTP Access Concentrator) to the headend PNS (PPTP Network Server). When used this way, the PAC is the remote client and the PNS is the server.

However, when used for VPN by Windows, the interaction is inverted. The PNS is a remote single-user PC that initiates connection to the head-end PAC to gain access to a central network.

PPTP application inspection is disabled by default. You use the **fixup** command to enable PPTP. The command syntax is as follows:

```
[no] fixup protocol pptp 1723
```

When enabled, PPTP application inspection inspects PPTP protocol packets and dynamically creates the GRE connections and xlates necessary to permit PPTP traffic. Only Version 1, as defined in RFC 2637, is supported.

PAT is only performed for the modified version of GRE [RFC 2637] when negotiated over the PPTP TCP control channel. Port Address Translation is *not* performed for the unmodified version of GRE [RFC 1701, RFC 1702].

To view the xlates used by PPTP connections, enter the following command:

```
show xlate
```

This command includes output for GRE connection. PAT type is shown with the **detail** option. A string is shown for each GRE xlate. For example:

```
GRE PAT from inside:10.2.1.51/1723 to outside:192.150.49.100/0 flags ri
```

To view the status of GRE connections, enter one of the following commands:

```
show conn fport 1723
show conn lport 1723
```

You can use the **show local-host** command to display both GRE xlate and GRE connection status.

SMTP

This section describes how application inspection works with the Simple Mail Transfer Protocol (SMTP). It includes the following topics:

- [Application Inspection, page 5-12](#)
- [Sample Configuration, page 5-13](#)

You can use the **fixup** command to change the default port assignment for SMTP. The command syntax is as follows.

```
fixup protocol smtp [port[-port]]
```

The **fixup protocol smtp** command enables the Mail Guard feature. This restricts mail servers to receiving the seven minimal commands defined in RFC 821, section 4.5.1 (HELO, MAIL, RCPT, DATA, RSET, NOOP, and QUIT). All other commands are rejected.

Microsoft Exchange server does not strictly comply with RFC 821 section 4.5.1, using extended SMTP commands such as EHLO. PIX Firewall will convert any such commands into NOOP commands, which as specified by the RFC, forces SMTP servers to fall back to using minimal SMTP commands only. This may cause Microsoft Outlook clients and Exchange servers to function unpredictably when their connection passes through PIX Firewall.

Use the *port* option to change the default port assignments from 25. Use the *-port* option to apply SMTP application inspection to a range of port numbers.

As of Version 5.1 and higher, the **fixup protocol smtp** command changes the characters in the server SMTP banner to asterisks except for the “2”, “0”, “0” characters. Carriage return (CR) and linefeed (LF) characters are ignored. PIX Firewall Version 4.4 converts all characters in the SMTP banner to asterisks.

TFTP

Trivial File Transfer Protocol (TFTP), described in RFC1350, is a simple protocol to read and write files between a TFTP server and client. Previous to PIX Firewall Version 6.3(2), the protocol was handled with a built-in rule that permits all UDP connections from a TFTP server back to a client source port if there was a TFTP connection between the server and client.

The **fixup protocol tftp** command enhances the built-in offers several advantages over an implicit rule. The advantages of using TFTP application inspection over an implicit rule are:

- DoS prevention—To prevent a host from opening many invalid connections, a secondary channel is not created if there is an existing incomplete connection between the two hosts. This restriction dictates a client can spoof at most one request.
- Penetration prevention—When TFTP request a read or write request, a secondary channel must be opened, and traffic using the secondary channel must be initiated from the server. This restriction prevents the client from creating the secondary connection and then using that connection.
- Configurable—The **fixup protocol tftp** command can be disabled if needed.

The PIX Firewall inspects TFTP traffic and dynamically creates connections and translations, if necessary, to permit file transfer between a TFTP client and server with the **fixup protocol tftp** command. Specifically, the fixup inspects TFTP read request (RRQ), write request (WRQ), and error notification (ERROR).

A dynamic secondary channel and a PAT translation, if necessary, are allocated on a reception of a valid read (RRQ) or write (WRQ) request. This secondary channel is subsequently used by TFTP for file transfer or error notification.

TFTP application inspection enforces the following characteristics on the secondary channel. Only the TFTP server can initiate traffic over the secondary channel, and at most one incomplete secondary channel can exist between the TFTP client and server. An error notification from the server closes the secondary channel.

**Note**

Note: The **fixup protocol tftp command** is enabled by default.

TFTP Fixup must be enabled if static PAT is used to redirect TFTP traffic.

Application Inspection

An SMTP server responds to client requests with numeric reply codes and optional human readable strings. SMTP application inspection controls and reduces the commands that the user can use as well as the messages that the server returns. SMTP inspection performs three primary tasks:

- Restricts SMTP requests to seven minimal commands (HELO, MAIL, RCPT, DATA, RSET, NOOP, and QUIT).
- Monitors the SMTP command-response sequence.
- Generates an audit trail—Audit record 108002 is generated when invalid character embedded in the mail address is replaced. For more information, see RFC 821.

SMTP inspection monitors the command and response sequence for the following anomalous signatures:

- Truncated commands.
- Incorrect command termination (not terminated with <CR><LR>).
- The MAIL and RCPT commands specify who are the sender and the receiver of the mail. Mail addresses are scanned for strange characters. The pipeline character (|) is deleted (changed to a blank space) and “<” ,”>” are only allowed if they are used to define a mail address (“>” must be preceded by “<”).
- Unexpected transition by the SMTP server.
- For unknown commands, the PIX Firewall changes all the characters in the packet to X. In this case, the server will generate an error code to the client. Because of the change in the packed, the TCP checksum has to be recalculated or adjusted.
- TCP stream editing.
- Command pipelining.

Sample Configuration

Figure 5-3 illustrates a network scenario implementing SMTP and NFS on an internal network.

Figure 5-3 Sample Configuration with SMTP and NFS (Sun RPC)

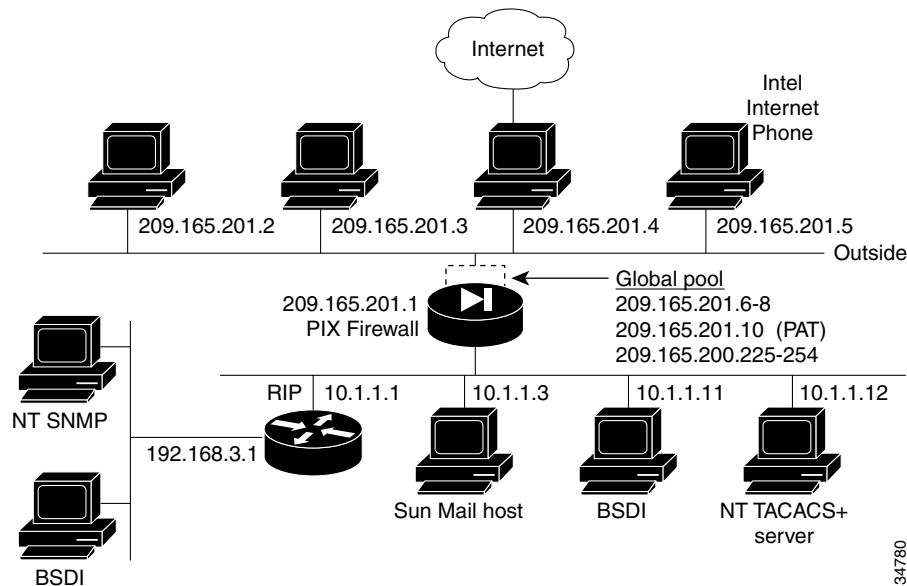

In this example, the **static** command sets up a global address to permit outside hosts access to the 10.1.1.3 Sun Mail host on the Inside interface. (The MX record for DNS must point to the 209.165.201.1 address so that mail is sent to this address.) The **access-list** command lets any outside users access the global address through the SMTP port (25). The **no fixup protocol** command disables the Mail Guard feature.

Perform the following steps to complete the configuration required for this example:

- Step 1** Provide access to the 10.1.1.3 mail server through global address 209.165.201.12:
- ```
static (inside, outside) 209.165.201.12 10.1.1.3 netmask 255.255.255.255 0 0
access-list acl_out permit tcp any host 209.165.201.12 eq smtp
```

The **access-list** command allows any outside host access to the static via SMTP (port 25). By default, the PIX Firewall restricts all access to mail servers to the commands DATA, HELO, MAIL, NOOP, QUIT, RCPT, and RSET, as described in RFC 821, section 4.5.1. This is implemented through the Mail Guard service, which is enabled by default (**fixup protocol smtp 25**).

Another aspect of providing access to a mail server is being sure that you have a DNS MX record for the static's global address, which outside users access when sending mail to your site.

- Step 2** Create access to port 113, the IDENT protocol:
- ```
access-list acl_out permit tcp any host 209.165.201.12 eq 113
access-group acl_out in interface outside
static (inside, outside) 209.165.201.12 10.1.1.3 netmask 255.255.255.255 0 0
access-list acl_out permit tcp any host 209.165.201.12 eq smtp
access-list acl_out permit tcp any host 209.165.201.12 eq 113
access-group acl_out in interface outside
```

If the mail server has to talk to many mail servers on the outside which connect back with the now obsolete and highly criticized IDENT protocol, use this **access-list** command statement to speed up mail transmission. The **access-group** command statement binds the **access-list** command statements to the outside interface.

[Example 5-1](#) shows a command listing for configuring access to services for the network.

Example 5-1 Configuring Mail Server Access

```
static (inside, outside) 209.165.201.12 10.1.1.3 netmask 255.255.255.255 0 0
access-list acl_out permit tcp any host 209.165.201.12 eq smtp
access-list acl_out permit tcp any host 209.165.201.12 eq 113
access-group acl_out in interface outside
static (inside, outside) 209.165.201.12 10.1.1.3 netmask 255.255.255.255 0 0
```

Voice Over IP

This section describes how the PIX Firewall supports Voice over IP (VoIP) applications and protocols and how you can use **fixup** and other commands to solve specific problems. It includes the following topics:

- [CTIQBE, page 5-14](#)
- [CU-SeeMe, page 5-15](#)
- [H.323, page 5-16](#)
- [MGCP, page 5-18](#)
- [SCCP, page 5-20](#)
- [SIP, page 5-23](#)

CTIQBE

The Telephony Application Programming Interface (TAPI) and Java Telephony Application Programming Interface (JTAPI) are used by many Cisco VoIP applications. PIX Firewall Version 6.3 introduces support for a specific protocol, Computer Telephony Interface Quick Buffer Encoding (CTIQBE), which is used by Cisco TAPI Service Provider (TSP) to communicate with Cisco CallManager.

Support for this protocol is disabled by default. To enable support for this protocol, enter the following command:

```
fixup protocol ctiqbe 2748
```

To view the status of CTIQBE connections, enter the following command:

```
show conn state ctiqbe
```

This command displays info about the media connections allocated by CTIQBE Fixup module.

In the output, the media connections allocated by CTIQBE Fixup module are denoted by a 'C' flag.

The following summarizes limitations that apply when using CTIQBE application inspection:

- CTIQBE application inspection does not support configurations using the **alias** command, which is deprecated after the introduction of outside NAT with PIX Firewall Version 6.2.
- Stateful Failover of CTIQBE calls is *not* supported.
- Using the **debug ctiqbe** command may delay message transmission, which may have a performance impact in a real-time environment. When you enable this debugging or logging and Cisco IP SoftPhone seems unable to complete call setup through the PIX Firewall, increase the timeout values in the Cisco TSP settings on the system running Cisco IP SoftPhone.
- CTIQBE application inspection does *not* support CTIQBE message fragmented in multiple TCP packets.

The following summarizes special considerations when using CTIQBE application inspection in specific scenarios:

- If two Cisco IP SoftPhones are registered with different Cisco CallManagers, which are connected to different interfaces of a PIX Firewall, calls between these two phones will fail.
- When Cisco CallManager is located on the higher security interface compared to Cisco IP SoftPhones, if NAT or outside NAT is required for the Cisco CallManager IP address, the mapping must be static as Cisco IP SoftPhone requires the Cisco CallManager IP address to be specified explicitly in its Cisco TSP configuration on the PC.
- When using PAT or Outside PAT, if the Cisco CallManager IP address is to be translated, its TCP port 2748 must be statically mapped to the **same port** of the PAT (interface) address in order for Cisco IP SoftPhone registrations to succeed. The CTIQBE listening port (TCP 2748) is fixed and is not user-configurable on Cisco CallManager, Cisco IP SoftPhone, or Cisco TSP.

To display information regarding the CTIQBE sessions established across the PIX Firewall, enter the following command:

```
show ctiqbe
```

For further information about using this command to troubleshoot CTIQBE application inspection issues, refer to the **show ctiqbe** command in the *Cisco PIX Firewall Command Reference*.

CU-SeeMe

With CU-SeeMe clients, one user can connect directly to another (CU-SeeMe or other H.323 client) for person-to-person audio, video, and data collaboration. CU-SeeMe clients can conference in a mixed client environment that includes both CU-SeeMe clients and H.323-compliant clients from other vendors.

Behind the scenes, CU-SeeMe clients operate in two very different modes. When connected to another CU-SeeMe client or CU-SeeMe Conference Server, the client sends information in CU-SeeMe mode.

When connected to an H.323-compliant videoconferencing client from a different vendor, CU-SeeMe clients communicate using the H.323-standard format in H.323 mode.

CU-SeeMe is supported through H.323 inspection, as well as performing NAT on the CU-SeeMe control stream, which operates on UDP port 7648.

H.323

This section describes how to manage application inspection for the H.323 suite of protocols. It includes the following topics:

- [Overview, page 5-16](#)
- [Multiple Calls on One Call Signalling Connection, page 5-16](#)
- [Viewing Connection Status, page 5-17](#)
- [Technical Background, page 5-17](#)

Overview

You can use the **fixup** command to change the default port assignment for the H.323 protocol. The command syntax is as follows:

```
[no] fixup protocol h323 h225 | ras port [-port]]
```

Use the *port* option to change the default control connection port assignment. The default port assignments are as follows:

- h323 h225 1720
- h323 ras 1718-1719

Use the *-port* option to apply H.323 application inspection to a range of port numbers.

The **fixup protocol h323** command provides support for H.323-compliant endpoints. PIX Firewall Version 5.3 through Version 6.2 supports H.323 Version 2. PIX Firewall Version 6.3 supports H.323 Version 3 and Version 4.

H.323 is a suite of protocols defined by the International Telecommunication Union (ITU) for multimedia conferences over LANs. H.323 supports VoIP gateways and VoIP gatekeepers. H.323 Version 2 adds the following functionality:

- Fast Connect or Fast Start Procedure for faster call setup
- H.245 tunneling for resource conservation, call synchronization, and reduced set up time

Usage Notes

1. Static PAT may not properly translate IP addresses embedded in optional fields within H.323 messages. If you experience this kind of problem, do not use static PAT with H.323.
2. It has been observed that when a NetMeeting client registers with an H.323 gatekeeper and tries to call an H.323 gateway that is also registered with the H.323 gatekeeper, the connection is established but no voice is heard in either direction. This problem is unrelated to the PIX Firewall.
3. If you configure a network static where the network static is the same as a third-party netmask and address, then any outbound H.323 connection fails.

Multiple Calls on One Call Signalling Connection

PIX Firewall Version 6.3 supports multiple calls on the same call signaling channel, a feature introduced with H.323 Version 3. This feature reduces call setup time and reduces the use of ports on the PIX Firewall. A new **timeout** command is introduced to control how long the H.225 call signaling channel stays open when using this feature. The syntax for this command is as follows:

```
timeout h225 hh[mm[ss]]
```

Replace *hh* with the number of hours, *mm* with the minutes and *ss* with the seconds. The default is 1 hour. To keep the channel open without any timeout, set the timer to 0 by entering the following command:

```
timeout h225 00:00:00
```

To disable the timer and close the TCP connection immediately after all calls are cleared, set the timeout value to 1 second, as follows:

```
timeout h225 00:00:01
```

Viewing Connection Status

To display the status of H.225 connections, enter the following command:

```
show conn state h225
```

Technical Background

H.323 inspection supports static NAT or dynamic NAT. H.323 RAS is configurable using the **fixup** command with PIX Firewall Version 6.2 or higher. PAT support for H.323 is introduced with PIX Firewall Version 6.2.

The H.323 collection of protocols collectively may use up to two TCP connection and four to six UDP connections. FastConnect uses only one TCP connection, and RAS uses a single UDP connection for registration, admissions, and status.

An H.323 client may initially establish a TCP connection to an H.323 server using TCP port 1720 to request Q.931 call setup. As part of the call setup process, the H.323 terminal supplies a port number to the client to use for an H.245 TCP connection. In environments where H.323 gatekeeper is in use, the initial packet is transmitted using UDP.

H.323 inspection monitors the Q.931 TCP connection to determine the H.245 port number. If the H.323 terminals are not using FastConnect, the PIX Firewall dynamically allocates the H.245 connection based on the inspection of the H.225 messages.

Within each H.245 message, the H.323 endpoints exchange port numbers that are used for subsequent UDP data streams. H.323 inspection inspects the H.245 messages to identify these ports and dynamically creates connections for the media exchange. Real-Time Transport Protocol (RTP) uses the negotiated port number, while RTP Control Protocol (RTCP) uses the next higher port number.

The H.323 control channel handles H.225 and H.245 and H.323 RAS. H.323 inspection uses the following ports.

- 1718—Gate Keeper Discovery UDP port
- 1719—RAS UDP port
- 1720—TCP Control Port

The two major functions of H.323 inspection are as follows:

- NAT the necessary embedded IPv4 addresses in the H.225 and H.245 messages. Because H.323 messages are encoded in PER encoding format, PIX Firewall uses an ASN.1 decoder to decode the H.323 messages.
- Dynamically allocate the negotiated H.245 and RTP/RTCP connections.

The PIX Firewall administrator must open an access list for the well-known H.323 port 1720 for the H.225 call signaling. However, the H.245 signaling ports are negotiated between the endpoints in the H.225 signaling. When an H.323 gatekeeper is used, the PIX Firewall opens an H.225 connection based on inspection of the ACF message.

The PIX Firewall dynamically allocates the H.245 channel after inspecting the H.225 messages and then “hookup” the H.245 channel to be fixed up as well. That means whatever H.245 messages pass through the PIX Firewall pass through the H.245 application inspection, NATing embedded IP addresses and opening the negotiated media channels.

The H.323 ITU standard requires that a TPKT header, defining the length of the message, precede the H.225 and H.245, before being passed on to the reliable connection. Because the TPKT header does not necessarily need to be sent in the same TCP packet as the H.225/H.245 message, PIX Firewall must remember the TPKT length to process/decode the messages properly. PIX Firewall keeps a data structure for each connection and that data structure contains the TPKT length for the next expected message.

If the PIX Firewall needs to NAT any IP addresses, then it will have to change the checksum, the UIIE (user-user information element) length, and the TPKT, if included in the TCP packet with the H.225 message. If the TPKT is sent in a separate TCP packet, then PIX Firewall will proxy ACK that TPKT and append a new TPKT to the H.245 message with the new length.

Note

PIX Firewall does not support TCP options in the Proxy ACK for the TPKT.

Each UDP connection with a packet going through H.323 inspection is marked as an H.323 connection and will time out with the H.323 timeout as configured by the administrator using the **timeout** command.

MGCP

Cisco PIX Firewall Version 6.3 introduces support for application inspection of the Media Gateway Control Protocol (MGCP). This section describes how to enable application inspection and view application inspection information. It includes the following topics:

- [Overview, page 5-18](#)
- [Enabling MGCP Application Inspection, page 5-19](#)
- [Configuration for Multiple Call Agents and Gateways, page 5-19](#)
- [Viewing MGCP Information, page 5-20](#)

Overview

MGCP is used for controlling media gateways from external call control elements called media gateway controllers or call agents. A media gateway is typically a network element that provides conversion between the audio signals carried on telephone circuits and data packets carried over the Internet or over other packet networks. Examples of media gateways are:

- Trunking gateways, that interface between the telephone network and a Voice over IP network. Such gateways typically manage a large number of digital circuits.
- Residential gateways, that provide a traditional analog (RJ11) interface to a Voice over IP network. Examples of residential gateways include cable modem/cable set-top boxes, xDSL devices, broad-band wireless devices.

- Business gateways, that provide a traditional digital PBX interface or an integrated soft PBX interface to a Voice over IP network.

MGCP messages are transmitted over UDP. A response is sent back to the source address (IP address and UDP port number) of the command, but the response may not arrive from the same address as the command was sent to. This can happen when multiple call agents are being used in a failover configuration and the call agent that received the command has passed control to a backup call agent, which then sends the response.

Enabling MGCP Application Inspection

Enter the following command to enable application inspection for MGCP:

```
[no] fixup protocol mgcp [port[-port]]
```

Application inspection for MGCP is disabled by default. To use MGCP, you typically need to configure at least two ports. One on which the gateway receives commands and one for the port on which the call agent receives commands. Normally, a call agent will send commands to port 2427, while a gateway will send commands to port 2727.

Neither NAT or PAT are supported by PIX Firewall Version 6.3 and lower.

To enable MGCP application inspection for call agents and gateways using the default ports, enter the following commands:

```
fixup protocol mgcp 2427
fixup protocol mgcp 2727
```

Enter the following command to set the duration for the MGCP inactivity timer:

```
timeout mgcp hh[mm[ss]]
```

When the specified time elapses, the MGCP media ports are closed. The default is 5 minutes.



Note

Enabling or changing the MGCP application inspection will have no effect until you reload the PIX Firewall configuration.

Configuration for Multiple Call Agents and Gateways

Use the following commands to configure the PIX Firewall to support the use of multiple MGCP call agents and gateways:

```
[no] mgcp call-agent ip_address group_id
[no] mgcp command-queue limit
[no] mgcp gateway ip_address group_id
```

Use the **mgcp call-agent** command to specify a group of call agents which can manage one or more gateways. This information will be used to open connections for the call agents other than the one a gateway sends a command to so that any of the call agents can send the response. The *ip_address* option specifies the IP address of the call agent. The *group_id* option is a number from 0 to 4294967295. Call agents with the same *group_id* belong to the same group.

Use the **mgcp command-queue** command to specify the maximum number of MGCP commands that will be queued waiting for a response. The range of allowed values for the *limit* option is 1 to 4294967295. The default is 200. When the limit has been reached and a new command arrives, the command that has been in the queue for the longest time will be removed.

Use the **mgcp gateway** command to specify which group of call agents are managing a particular gateway. The IP address of the gateway is specified with the *ip_address* option. The *group_id* option is a number from 0 to 4294967295. It must correspond with the *group_id* of the call agents that are managing the gateway.

Use the **clear mgcp** command to remove all of the MGCP configuration and set the command queue limit to the default of 200.

The following example limits the MGCP command queue to 150 commands, allows call agents 10.10.11.5 and 10.10.11.6 to control gateway 10.10.10.115 and allows call agents 10.10.11.7 and 10.10.11.8 to control gateway 10.10.10.116:

```
mgcp call-agent 10.10.11.5 101
mgcp call-agent 10.10.11.6 101
mgcp call-agent 10.10.11.7 102
mgcp call-agent 10.10.11.8 102
mgcp command-queue 150
mgcp gateway 10.10.10.115 101
mgcp gateway 10.10.10.116 102
```

Viewing MGCP Information

To view information about MGCP, enter the following command:

```
show mgcp commands | sessions [detail]
```

Use the **commands** option to list the commands in the command queue. Use the **sessions** option to list the existing MGCP sessions. Use the **detail** option to list detailed information about each command or session.

To show information about the MGCP connections, enter the following command:

```
show conn detail |state mgcp
```

Use the **detail** option to display detailed information about the MGCP connections. Use the **state** option to display the media connections created for MGCP sessions.

SCCP

Skinny (or Simple) Client Control Protocol (SCCP) is a simplified protocol used in VoIP networks. This section describes the function and limitation of application inspection when using SCCP. It includes the following topics:

- [Overview, page 5-21](#)
- [Using PAT with SCCP, page 5-21](#)
- [Using SCCP with Cisco CallManager on a Higher Security Interface, page 5-23](#)
- [Problems Occur with Fragmented SCCP Packets, page 5-23](#)
- [Viewing SCCP Information, page 5-23](#)

Overview

Cisco IP Phones using SCCP can coexist in an H.323 environment. When used with Cisco CallManager, the SCCP client can interoperate with H.323 compliant terminals. Application layer functions in the PIX Firewall recognize SCCP Version 3.3. The functionality of the application layer software ensures that all SCCP signalling and media packets can traverse the Firewall by providing NAT of the SCCP Signaling packets.

You can use the **fixup** command to change the default port assignment for SCCP. The command syntax is as follows.

```
[no] fixup protocol skinny [port[-port]]
```

There are 5 versions of the SCCP protocol: 2.4, 3.0.4, 3.1.1, 3.2, and 3.3.2. PIX Firewall Version 6.3 supports up to Version 3.3.2.

Application inspection for SCCP is enabled by default. To change the default port assignments from 2000 use the *port* option. Use the *-port* option to apply SCCP application inspection to a range of port numbers.

If the address of a Cisco CallManager server is configured for NAT or PAT to a different address or port and outside phones register to it using TFTP, the connection will fail because PIX Firewall does not support NAT or PAT of the file content transferred using TFTP. Although PIX Firewall does support NAT of TFTP messages and opens a pinhole for the TFTP file to traverse the firewall, PIX Firewall *cannot* translate the Cisco CallManager IP address and port embedded in the Cisco IP Phone's configuration files that are transferred using TFTP during phone registration. For a workaround to this problem, refer to the [“Using SCCP with Cisco CallManager on a Higher Security Interface”](#) section on page 5-23.

PIX Firewall Version 6.2 introduces support of DHCP options 150 and 66, which allow the PIX Firewall to send the location of a TFTP server to Cisco IP Phones and other DHCP clients. For further information about this new feature, refer to [“Using the PIX Firewall DHCP Server”](#) in Chapter 4, [“Using PIX Firewall in SOHO Networks.”](#)

Using PAT with SCCP

PIX Firewall Version 6.3 introduces PAT and NAT support for SCCP. PAT is necessary if you have limited numbers of global IP addresses for use by IP phones. The following are the limitations that apply to the current version of PAT and NAT support for SCCP:

- PAT will not work with configurations using the **alias** command.
- Stateful failover of SCCP calls is **not** supported.
- Use of *debug skinny* command may result in a delay of the sending of the messages which may have a performance impact in a real-time environment.
- No support for fragmented SCCP messages
- Outside NAT or PAT is **not** supported

If the **clear xlate** command is entered after PAT xlates are created for Cisco CallManager, SCCP calls cannot be established because the xlates for the Cisco CallManager are permanently deleted. Under these circumstances, Cisco IP Phones need to reregister with the Cisco CallManager to establish calls through the PIX Firewall.

In topologies where Cisco CallManager is located on the higher security interface with respect to the Cisco IP Phones, if NAT is required for the Cisco CallManager IP address, the mapping must be **static** as a Cisco IP Phone requires the Cisco CallManager IP address to be specified explicitly in its configuration.

**Note**

If the Cisco CallManager IP address and the SCCP port must both be translated, the SCCP port must be statically mapped to the same port of the actual address for Cisco IP Phone registrations to succeed.

Using SCCP with Cisco CallManager on a Higher Security Interface

Cisco IP Phones require access to a TFTP server to download the configuration information they need to connect to the Cisco CallManager server.

When the Cisco IP Phones are on a lower security interface compared to the TFTP server, you must use an access list to connect to the protected TFTP server on UDP port 69. While you do need a static entry for the TFTP server, this does not have to be an "identity" static entry. When using NAT, an identity static entry maps to the same IP address. When using PAT, it maps to the same IP address and port.

However, if the Cisco IP Phones are on a lower security interface compared to the Cisco CallManager, we recommend that you do create an identity static entry to allow the Cisco CallManager on the higher security interface to accept registrations from the Cisco IP Phones.

When the Cisco IP Phones are on a *higher* security interface compared to the TFTP server and Cisco CallManager, no access list or static entry is required to allow the Cisco IP Phones to initiate the connection.

**Note**

Normal traffic between the Cisco CallManager and Cisco IP Phones uses SCCP and is handled by SCCP inspection without any special configuration.

Problems Occur with Fragmented SCCP Packets

At this time, PIX Firewall is not able to correctly handle fragmented SCCP packets. For instance, when using a voice conference bridge, SCCP packets may become fragmented and are then dropped by the PIX Firewall. This happens because the SCCP inspection checks each packet and drops what appear to be bad packets. When a single SCCP packet is fragmented into multiple TCP packets, the SCCP inspection function finds that the internal checksums within the SCCP packet fragments are not accurate and so it drops the packet.

Viewing SCCP Information

To view information about the SCCP sessions established across the PIX Firewall, enter the following command:

```
show skinny
```

For further information about using this command to troubleshoot SCCP application inspection issues, refer to the **show skinny** command in the *Cisco PIX Firewall Command Reference*.

SIP

Session Initiation Protocol (SIP), as defined by the Internet Engineering Task Force (IETF), enables call handling sessions, particularly two-party audio conferences, or "calls." This section describes how application inspection works with SIP. It includes the following topics:

- [Overview, page 5-24](#)
- [Allowing Outside Phones to Place an Inside Phone on Hold, page 5-24](#)
- [Instant Messaging \(IM\), page 5-26](#)
- [Viewing SIP Information, page 5-26](#)
- [Technical Background, page 5-26](#)

Overview

SIP works with Session Description Protocol (SDP) for call signalling. SDP specifies the ports for the media stream. Using SIP, the PIX Firewall can support any SIP Voice over IP (VoIP) gateways and VoIP proxy servers. SIP and SDP are defined in the following RFCs:

- SIP: Session Initiation Protocol, RFC 2543
- SDP: Session Description Protocol, RFC 2327

You can use the **fixup** command to change the default TCP port assignment for the Session Initiation Protocol (SIP). The command syntax is as follows.

```
[no] fixup protocol sip <udp> [port[-port]]
```



Note

PAT support for SIP is provided by PIX Firewall Version 6.2 or higher. Only static NAT and dynamic NAT are supported in earlier versions.

To change the default port assignments from 5060 use the *port* option. Use the *-port* option to apply SIP application inspection to a range of port numbers.

To view the current timeout value for SIP connections, enter the following command:

```
show timeout sip
```

To view the state of SIP connections, enter the following command:

```
show conn state sip
```

To support SIP calls through the PIX Firewall, signaling messages for the media connection addresses, media ports, and embryonic connections for the media must be inspected, because while the signaling is sent over a well-known destination port (UDP/TCP 5060), the media streams are dynamically allocated. Also, SIP embeds IP addresses in the user-data portion of the IP packet. SIP inspection applies NAT for these embedded IP addresses.

With SIP application inspection enabled, the PIX Firewall does support connectivity between a SIP phone and a Music on Hold (MOH) server. The specific scenario that has been tested is with a phone on the more secure network connected to an MOH server with the SIP proxy on the less secure network.



Note

If a remote endpoint tries to register with a SIP proxy on a network protected by PIX Firewall, the registration will fail if the To field in the request does not specify the port number and if the SIP proxy is configured with PAT.

Allowing Outside Phones to Place an Inside Phone on Hold

When an outbound call is made by an IP phone using SIP and the outside phone tries to put the inside phone on hold, the operation fails. This is because a new connection is initiated to send the INVITE packet from the outside phone and the PIX Firewall drops the packet.

To solve this problem, do one of the following:

- Configure an access list to allow the Re-INVITE packet to the inside gateway using port 5060
- Use the **established** command, as in the following example:

```
established udp 5060 permitto udp 5060 permitfrom udp 0
```

This command statement causes the PIX Firewall to allow a new connection on port 5060 from an outside phone if a UDP connection already exists from that phone to an inside phone. A call can be placed on hold for the time specified in the timeout interval for SIP. You can increase this interval as necessary with the **timeout** command.

Providing IP Address Privacy

Achieving IP address privacy requires the ability to retain outside IP addresses embedded in inbound SIP packets for all transactions. With the exception of REGISTER, you can hide phone IP addresses from one another by invoking `ip-address-privacy`.

The REGISTER message and the response to REGISTER message will be exempt from this operation since this message is exchanged between the phone and the proxy.

You can turn on this feature by using the `[no] sip ip-address-privacy` command.



Note

By default this command is turned off.

When the above command is turned on, SIP fixup will retain outside IP addresses in the SIP header and SDP data of inbound SIP packets.

Here is an example of enabled IP address privacy:

```
INVITE sip:bob@Proxy SIP/2.0
Via: SIP/2.0/UDP A:5060 =====> A':patport#
From: terry@A =====> terry@A'
To: robin@Proxy
Call-ID:
Contact:terry@A =====> terry@A'
SDP
o=A =====> A'
c=IN IP4 A =====> A'
m=port# =====> patport# (if applicable)
```

When the Proxy sends the INVITE to B:

```
INVITE sip:bob@Proxy SIP/2.0
Via: SIP/2.0/UDP A':5060 =====>Has to remain as A':patport#
From: terry@A' =====>Has to remain as A'
To: robin@Proxy
Call-ID:
Contact:terry@A' =====>Has to remain as A'
SDP
o=A' =====>Has to remain as A'
c=IN IP4 A' =====>Has to remain as A'
m=patport#
```

If there is a requirement to hide phone IP addresses connected on the same PIX interface from each other and eliminate the direct P2P communication between the phones, this feature should be enabled. SIP `ip-address-privacy` managed with `fixup sip`, controls traffic (SIP) and voice (RTP/RTCP) traffic flow by creating pin holes for voice traffic. Using this feature eliminates direct point-to-point communication between phones.

**Note**

When this feature is turned on, outside NAT/alias/bi-directional NAT and Policy NAT will not work. When a packet from the lower security level (e.g., outside) comes to the higher security level (e.g., inside), since we retain the NATted IP addresses in it, and don't send the packet through the NAT engine, outside NAT will not be performed for the inbound SIP packets.

Instant Messaging (IM)

Instant Messaging refers to the transfer of messages between users in near real-time. SIP supports the Chat feature on Windows XP using Windows Messenger RTC Client version 4.7.0105 only. The MESSAGE/INFO methods and 202 Accept response are used to support IM as defined in the following RFCs:

- Session Initiation Protocol (SIP)-Specific Event Notification, RFC 3265
- Session Initiation Protocol (SIP) Extension for Instant Messaging, RFC 3428

MESSAGE/INFO requests can come in at any time after registration/subscription. For example, two users can be online at any time, but not chat for hours. Therefore, the SIP fixup opens U_sip pinholes which will time out according to the configured SIP timeout value. This value must be configured at least five minutes longer than the subscription duration. The subscription duration is defined in the Contact Expires value and is typically 30 minutes.

Because MESSAGE/INFO requests are typically sent using a dynamically allocated port other than port 5060, they are required to go through the SIP fixup.

**Note**

Only the Chat feature is currently supported. Whiteboard, File Transfer, and Application Sharing are not supported. RTC Client 5.0 is not supported.

Viewing SIP Information

To view information about the SIP sessions established across the PIX Firewall, enter the following command:

```
show sip
```

For further information about using this command to troubleshoot CTIQBE application inspection issues, refer to the **show sip** command in the *Cisco PIX Firewall Command Reference*.

Technical Background

SIP inspection NATs the SIP text-based messages, recalculates the content length for the SDP portion of the message, and recalculates the packet length and checksum. It dynamically opens media connections for ports specified in the SDP portion of the SIP message as address/ports on which the endpoint should listen.

SIP inspection has a database with indices CALL_ID/FROM/TO from the SIP payload that identifies the call, as well as the source and destination. Contained within this database are the media addresses and media ports that were contained in the SDP media information fields and the media type. There can be multiple media addresses and ports for a session. RTP/RTCP connections are opened between the two endpoints using these media addresses/ports. The well-known port 5060 must be used on the initial call

setup (INVITE) message. However, subsequent messages may not have this port number. The SIP fixup opens signaling connection pinholes, and marks these connections as SIP connections. This is done for the messages to reach the SIP application and be NATed.

As a call is set up, the SIP session is considered in the “transient” state until the media address and media port is received in a Response message from the called endpoint indicating the RTP port the called endpoint will listen on. If there is a failure to receive the response messages within one minute, the signaling connection will be torn down.

Once the final handshake is made, the call state is moved to active and the signaling connection will remain until a BYE message is received.

If an inside endpoint initiates a call to an outside endpoint, a media hole is opened to the outside interface to allow RTP/RTCP UDP packets to flow to the inside endpoint media address and media port specified in the INVITE message from the inside endpoint. Unsolicited RTP/RTCP UDP packets to an inside interface will not traverse the Firewall, unless the PIX Firewall configuration specifically allows it.

The media connections are torn down within two minutes after the connection becomes idle. This is, however, a configurable timeout and can be set for a shorter or longer period of time.

Multimedia Applications

This section describes how the PIX Firewall supports multimedia or video-on-demand applications and protocols and how you can use **fixup** and other commands to solve specific problems. It includes the following topics:

- [Netshow, page 5-27](#)
- [Real Time Streaming Protocol \(RTSP\), page 5-29](#)
- [VDO LIVE, page 5-30](#)

Netshow

Netshow is a streaming multimedia service that allows users to receive audio and video streams from across the Internet. Users play Netshow content using Windows Media player, which connects to the Netshow server to receive the multimedia stream.

The data channel in which the streams are transmitted is negotiated in a control channel. This section describes the different streams and includes the following topics.

- [UDP Stream, page 5-27](#)
- [TCP Stream, page 5-29](#)

UDP Stream

UDP streams are used with Netshow as follows:

1. Client makes a TCP connection to the server at the well-known port 1755.
2. Once a connection is established, the client sends an LVMConnectFunnel message to the server indicating the UDP port that it expects to receive the data.
3. Server chooses a UDP port in the range 1024-5000 to stream the netshow data down to the client.
4. Server sends the stream in the negotiated port.

5. Netshow session ends by tearing down the TCP connection.

TCP Stream

TCP streams are used with Netshow as follows:

1. Client makes a TCP connection to the server using the well-known port 1755.
2. Once a connection is established, the client sends an LVMConnectFunnel message to the server confirming the use of TCP connection.
3. Server sends the stream in the already connected TCP port.
4. Netshow session ends by tearing down the TCP connection.

Real Time Streaming Protocol (RTSP)

You can use the **fixup** command to change the default port assignment for the Real Time Streaming Protocol (RTSP). The command syntax is as follows.

```
fixup rtsp [port]
```

The **fixup protocol rtsp** command lets PIX Firewall pass RTSP packets. RTSP is used by RealAudio, RealNetworks, Apple QuickTime 4, RealPlayer, and Cisco IP/TV connections. PIX Firewall does not support multicast RTSP.

If you are using Cisco IP/TV, use RTSP TCP port 554 and TCP 8554:

```
fixup protocol rtsp 554
fixup protocol rtsp 8554
```

The following restrictions apply to the **fixup protocol rtsp** command:

- This PIX Firewall will not fix RTSP messages passing through UDP ports.
- PIX Firewall does not support RealNetworks multicast mode (x-real-rdt/mcast).
- PAT is not supported with the **fixup protocol rtsp** command.
- PIX Firewall does not have the ability to recognize HTTP cloaking where RTSP messages are hidden in the HTTP messages.
- PIX Firewall cannot perform NAT on RTSP messages because the embedded IP addresses are contained in the SDP files as part of HTTP or RTSP messages. Packets could be fragmented and PIX Firewall cannot perform NAT on fragmented packets.
- With Cisco IP/TV, the number of NATs the PIX Firewall performs on the SDP part of the message is proportional to the number of program listings in the Content Manager (each program listing can have at least six embedded IP addresses).
- You can configure NAT for Apple QuickTime 4 or RealPlayer. Cisco IP/TV only works with NAT if the Viewer and Content Manager are on the outside network and the server is on the inside network.
- When using RealPlayer, it is important to properly configure transport mode. For the PIX Firewall, add an **access-list** command statement from the server to the client or vice versa. For RealPlayer, change transport mode by clicking **Options>Preferences>Transport>RTSP Settings**.

If using TCP mode on the RealPlayer, select the **Use TCP to Connect to Server** and **Attempt to use TCP for all content** check boxes. On the PIX Firewall, there is no need to configure the fixup.

If using UDP mode on the RealPlayer, select the **Use TCP to Connect to Server** and **Attempt to use UDP for static content** check boxes. On the PIX Firewall, add a **fixup protocol rtsp port** command statement.

RTSP applications use the well-known port 554 with TCP (rarely UDP) as a control channel. PIX Firewall only supports TCP, in conformity with RFC 2326.

This TCP control channel will be used to negotiate the data channels that will be used to transmit audio/video traffic, depending on the transport mode that is configured on the client.

The supported RDT transports are: rtp/avp, rtp/avp/udp, x-real-rdt, x-real-rdt/udp, and x-pn-tng/udp.

The PIX Firewall parses Setup response messages with a status code of 200. If the response message is travelling inbound, the server is outside relative to the PIX Firewall and dynamic channels need to be opened for connections coming inbound from the server. If the response message is outbound, then the PIX Firewall does not need to open dynamic channels.

Because RFC 2326 does not require that the client and server ports must be in the SETUP response message, the PIX Firewall will need to keep state and remember the client ports in the SETUP message. QuickTime places the client ports in the SETUP message and then the server responds with only the server ports.

RTSP inspection does not support PAT or dual-NAT. Also, PIX Firewall cannot recognize HTTP cloaking where RTSP messages are hidden in the HTTP messages.

VDO LIVE

VDO LIVE is a streaming multimedia service that allows users to receive audio and video streams from across the Internet.

There are two connections, TCP for control messages and UDP for streams. TCP session uses a fixed port of 7000; while the UDP source port is always 7001. The UDP stream uses a destination port provided by the client over the control connection.

PIX Firewall monitors the VDO Live TCP control session and allows only the VDO live server system to communicate with the client via the solicited UDP port with source port 7001. During this time, the TCP channel should be active. When one goes down, PIX Firewall tears down the other connection.

PIX Firewall bypasses the data channel by opening up the port that was negotiated in the control channel. The application inspection scans the control channel and opens up the negotiated ports.

When NAT is involved, the negotiated IP address and the port number is NAT translated, which means that the payload has to be modified.

Database and Directory Support

This section describes how to allow access to database or directory services through the PIX Firewall. It includes the following topics:

- [ILS and LDAP, page 5-31](#)
- [Network File System and Sun RPC, page 5-32](#)
- [Oracle SQL*Net \(V1/V2\), page 5-33](#)

ILS and LDAP

The Internet Locator Service (ILS) is based on the Lightweight Directory Access Protocol (LDAP) and is LDAPv2 compliant. ILS was developed by Microsoft for use with its NetMeeting, SiteServer, and Active Directory products.

By default, **fixup protocol ils** is disabled. You can use the **fixup** command to enable the ILS fixup and, optionally, change the default port assignment. The command syntax is as follows.

```
[no] fixup protocol ils [port[-port]]
```

Use the *port* option to change the default port assignment from 389. Use the *-port* option to apply ILS inspection to a range of port numbers.

To show the configuration of ILS inspection, enter the following command:

```
show fixup [protocol ils]
```

PIX Firewall Version 6.2 introduces NAT support for ILS, which is used to register and locate endpoints in the ILS or SiteServer Directory. PAT cannot be supported because only IP addresses are stored by an LDAP database.

For search responses, when the LDAP server is located outside, NAT should be considered to allow internal peers to communicate locally while registered to external LDAP servers. For such search responses, xlates will be searched first, and then DNAT entries to obtain the correct address. If both of these searches fail, then the address will not be changed. For sites using NAT 0 (no NAT) and not expecting DNAT interaction, we recommend that the fixup be turned off to provide better performance.

Additional configuration may be necessary when the ILS server is located inside the PIX Firewall border. This would require a hole for outside clients to access the LDAP server on the specified port, typically TCP 389.

ILS/LDAP follows a client/server model with sessions handled over a single TCP connection. Depending on the client's actions, several of these sessions may be created.

During connection negotiation time, a BIND PDU is sent from the client to the server. Once a successful BIND RESPONSE from the server is received, other operational messages may be exchanged (such as ADD, DEL, SEARCH, or MODIFY) to perform operations on the ILS Directory. The ADD REQUEST and SEARCH RESPONSE PDUs may contain IP addresses of NetMeeting peers, used by H.323 (SETUP and CONNECT messages) to establish the NetMeeting sessions. Microsoft NetMeeting v2.X and v3.X provides ILS support.

The ILS inspection performs the following operations:

- Decodes the LDAP REQUEST/RESPONSE PDUs using the BER decode functions
- Parses the LDAP packet
- Extracts IP addresses
- Translates IP addresses as necessary
- Encodes the PDU with translated addresses using BER encode functions
- Copies the newly encoded PDU back to the TCP packet
- Performs incremental TCP checksum and sequence number adjustment

ILS inspection has the following limitations:

- Referral requests and responses are not supported
- Users in multiple directories are not unified
- Single users having multiple identities in multiple directories cannot be recognized by NAT

Network File System and Sun RPC

The port assignment for Sun Remote Procedure Call (RPC) is not configurable. Sun RPC is used by Network File System (NFS) and Network Information Service (NIS).

Sun RPC services can run on any port on the system. When a client attempts to access an RPC service on a server, it must find out which port that service is running on. It does this by querying the portmapper process on the well-known port of 111.

The client sends the RPC program number of the service, and gets back the port number. From this point on, the client program will send its RPC queries to that new port.

Only frames going from inside to outside are inspected. (for example, the portmapper service running on one of the internal servers has sent a reply). When a server behind the firewall (on the inside interface) sends out a reply, PIX Firewall intercepts this packet and opens both embryonic TCP and UDP connections on that port.

NAT or PAT of RPC payload information is not supported.

The following commands demonstrate how to implement Network File System (NFS) for the network shown in [Figure 5-3](#). These commands are used in addition to the basic firewall configuration required:

Step 1 Refine the accessibility of the **static** command by permitting Sun RPC over the UDP portmapper on port 111 with the **sunrpc** literal:

```
access-list acl_out permit udp host 209.165.201.2 host 209.165.201.11 eq sunrpc
```

Refer to the UNIX `/etc/rpc` file and the UNIX **rpc(3N)** command page for more information.

Once you create an **access-list** command statement for RPC, you can use the following command from outside host 209.165.201.2 to track down the activity of a PCNFSD on RPC 150001:

```
rpcinfo -u 209.165.201.11 150001
```

Another use of RPC is with the following command to see the exports of 209.165.201.11 if you want to allow mounting NFS from the outside network to the inside network:

```
showmount -e 209.165.201.11
```

Many protocols based on RPC, as well as NFS, are insecure and should be used with caution. Review your security policies carefully before permitting access to RPC.

Step 2 Permit NFS access:

```
access-list acl_out permit udp host 209.165.201.2 host 209.165.201.11 eq 2049
```

NFS access occurs at port 2049 and provides access between the outside and inside, such that host 209.165.201.2 can mount 10.1.1.11 via the global address 209.165.201.11.

[Example 5-2](#) shows the command listing for configuring access to services for the network illustrated in [Figure 5-3](#).

Example 5-2 Configuring NFS Access

```
access-list acl_out permit udp host 209.165.201.2 host 209.165.201.11 eq sunrpc
access-list acl_out permit udp host 209.165.201.2 host 209.165.201.11 eq 2049
```

Oracle SQL*Net (V1/V2)

The SQL*Net protocol consists of different packet types that PIX Firewall handles to make the data stream appear consistent to the Oracle applications on either side of the firewall. You can use the **fixup** command to change the default port assignment for Oracle SQL*Net. The command syntax is as follows.

```
fixup protocol sqlnet [port[-port]]
```

Use the *port* option to change the default port assignment from 1521. This is the value used by Oracle for SQL*Net, but this value does not agree with IANA port assignments for Structured Query Language (SQL). Use the *-port* option to apply SQL*Net inspection to a range of port numbers.

The PIX Firewall NATs all addresses and looks in the packets for all embedded ports to open for SQL*Net Version 1.

For SQL*Net Version 2, all DATA or REDIRECT packets that immediately follow REDIRECT packets with a zero data length will be fixed up.

The packets that need fix-up contain embedded host/port addresses in the following format:

```
(ADDRESS=(PROTOCOL=tcp) (DEV=6) (HOST=a.b.c.d) (PORT=a) )
```

SQL*Net Version 2 TNSFrame types (Connect, Accept, Refuse, Resend, and Marker) will not be scanned for addresses to NAT nor will inspection open dynamic connections for any embedded ports in the packet.

SQL*Net Version 2 TNSFrames, Redirect, and Data packets will be scanned for ports to open and addresses to NAT, if preceded by a REDIRECT TNSFrame type with a zero data length for the payload. When the Redirect message with data length zero passes through the PIX Firewall, a flag will be set in the connection data Structure to expect the Data or Redirect message that follows to be NATed and ports to be dynamically opened. If one of the TNS frames in the preceding paragraph arrive after the Redirect message, the flag will be reset.

The SQL*Net fixup will recalculate the checksum, change IP, TCP lengths, and readjust Sequence Numbers and Acknowledgment Numbers using the delta of the length of the new and old message.

SQL*Net Version 1 is assumed for all other cases. TNSFrame types (Connect, Accept, Refuse, Resend, Marker, Redirect, and Data) and all packets will be scanned for ports and addresses. Addresses will be NATed and port connections will be opened.

Management Protocols

This section describes how the PIX Firewall supports management protocols to solve specific problems. It includes the following topics:

- [Internet Control Message Protocol, page 5-34](#)
- [Remote Shell, page 5-34](#)
- [X Display Manager Control Protocol, page 5-34](#)
- [Simple Network Management Protocol Fixup, page 5-34](#)

Internet Control Message Protocol

The ICMP payload is scanned to retrieve the five-tuple from the original packet. ICMP inspection supports both one-to-one NAT and PAT. Using the retrieved five-tuple, a lookup is performed to determine the original address of the client. ICMP inspection makes the following changes to the ICMP packet:

- In the IP Header, the NAT IP is changed to Client IP (Destination Address) and the IP checksum is modified.
- In ICMP Header, the ICMP checksum is modified due to the changes in the ICMP packet.
- In the Payload, the following changes are made:
 - Original packet NAT IP is changed to Client IP
 - Original packet NAT port is changed to Client Port
 - Original packet IP checksum is updated

Remote Shell

You can use the **fixup** command to change the default port assignment for the Remote Shell protocol (RSH). The command syntax is as follows.

```
fixup protocol rsh [514]
```

The RSH protocol uses a TCP connection from the RSH client to the RSH server on TCP port 514. The client and server negotiate the TCP port number where the client will listen for the STDERR output stream. RSH inspection supports NAT of the negotiated port number if necessary.

X Display Manager Control Protocol

The port assignment for the X Display Manager Control Protocol (XDMCP) is not configurable. XDMCP is a protocol that uses UDP port 177 to negotiate X sessions, which use TCP when established.

For successful negotiation and start of an Xwindows session, the PIX Firewall must allow the TCP back connection from the Xhosted computer. To permit the back connection use the **established** command on the PIX Firewall. Once XDMCP negotiates the port to send the display, The **established** command is consulted to verify if this back connection should be permitted.

During the X Windows session, the manager talks to the display's Xserver on the well-known port 6000 + n. Each display has a separate connection to the Xserver, as a result of the following terminal setting.

```
setenv DISPLAY Xserver:n
```

where *n* is the display number.

When XDMCP is used, the display is negotiated using IP addresses, which the PIX Firewall can NAT if needed. XDCMP inspection does not support PAT.

Simple Network Management Protocol Fixup

SNMP fixup enables packet traffic monitoring between network devices. Using the **fixup protocol snmp command**, the PIX Firewall can be configured to deny traffic based on packet version.

The fixup can be enabled or disabled via the fixup command **[no] fixup protocol snmp 161-162**. However, existing connections will retain the fixup configuration present when the connection was created. Use **clear xlate** or **clear local** to clear connections and allow any new fixup configuration to take effect.

Configuring IPsec and Certification Authorities

This chapter provides information about using IP Security Protocol (IPsec), Internet Key Exchange (IKE), and certification authority (CA) technology with the PIX Firewall.

This chapter includes the following sections:

- [How IPsec Works, page 6-1](#)
- [Internet Key Exchange \(IKE\), page 6-2](#)
- [Using Certification Authorities, page 6-7](#)
- [Configuring IPsec, page 6-13](#)
- [Using Dynamic Crypto Maps, page 6-23](#)
- [Manual Configuration of SAs, page 6-26](#)
- [Viewing IPsec Configuration, page 6-29](#)
- [Clearing SAs, page 6-29](#)

How IPsec Works

IPsec provides authentication and encryption services to protect unauthorized viewing or modification of data within your network or as it is transferred over an unprotected network, such as the public Internet. IPsec is generally implemented in two types of configurations:

- **Site-to-site**—This configuration is used between two IPsec security gateways, such as PIX Firewall units. A site-to-site VPN interconnects networks in different geographic locations. For information that is specific for configuring IPsec in this configuration, refer to [Chapter 7, “Site-to-Site VPN Configuration Examples.”](#)
- **Remote access**—This configuration is used to allow secure remote access for VPN clients, such as mobile users. A remote access VPN allows remote users to securely access centralized network resources. For information that is specific for configuring IPsec in this configuration, refer to [Chapter 8, “Managing VPN Remote Access.”](#)

Two different security protocols are included within the IPsec standard:

- **Encapsulating Security Payload (ESP)**—Provides authentication, encryption, and anti-replay services.
- **Authentication Header (AH)**—Provides authentication and anti-replay services.

IPSec can be configured to work in two different modes:

- **Tunnel Mode**—This is the normal way in which IPSec is implemented between two PIX Firewall units (or other security gateways) that are connected over an untrusted network, such as the public Internet.
- **Transport Mode**—This method of implementing IPSec is typically done with L2TP to allow authentication of native Windows 2000 VPN clients. For information about configuring L2TP, refer to “[Using PPTP for Remote Access](#),” in [Chapter 8, “Managing VPN Remote Access.”](#)

The main task of IPSec is to allow the exchange of private information over an insecure connection. IPSec uses encryption to protect information from interception or eavesdropping. However, to use encryption efficiently, both parties should share a secret that is used for both encryption and decryption of the information.

IPSec operates in two phases to allow the confidential exchange of a shared secret:

- **Phase 1**, which handles the negotiation of security parameters required to establish a secure channel between two IPSec peers. Phase 1 is generally implemented through the Internet Key Exchange (IKE) protocol. If the remote IPSec peer cannot perform IKE, you can use manual configuration with pre-shared keys to complete Phase 1.
- **Phase 2**, which uses the secure tunnel established in Phase 1 to exchange the security parameters required to actually transmit user data.

The secure tunnels used in both phases of IPSec are based on security associations (SAs) used at each IPSec end point. SAs describe the security parameters, such as the type of authentication and encryption that both end points agree to use.

Internet Key Exchange (IKE)

This section describes the Internet Key Exchange (IKE) protocol and how it works with IPSec to make VPNs more scalable. This section includes the following topics:

- [IKE Overview, page 6-2](#)
- [Configuring IKE, page 6-4](#)
- [Disabling IKE, page 6-6](#)
- [Using IKE with Pre-Shared Keys, page 6-6](#)

IKE Overview

IKE is a protocol used by IPSec for completion of Phase 1. IKE negotiates and assigns SAs for each IPSec peer, which provide a secure channel for the negotiation of the IPSec SAs in Phase 2. IKE provides the following benefits:

- Eliminates the need to manually specify all the IPSec security parameters at both peers
- Lets you specify a lifetime for the IKE SAs
- Allows encryption keys to change during IPSec sessions
- Allows IPSec to provide anti-replay services
- Enables CA support for a manageable, scalable IPSec implementation
- Allows dynamic authentication of peers

IKE negotiations must be protected, so each IKE negotiation begins by each peer agreeing on a common (shared) IKE policy. This policy states the security parameters that will be used to protect subsequent IKE negotiations. After the two peers agree upon a policy, the security parameters of the policy are identified by an SA established at each peer, and these SAs apply to all subsequent IKE traffic during the negotiation.

There are five parameters to define in each IKE policy. These parameters apply to the IKE negotiations when the IKE SA is established. [Table 6-1](#) provides the five IKE policy keywords and their permitted values.

Table 6-1 IKE Policy Keywords

Keyword	Meaning	Description
des 3des	56-bit DES-CBC 168-bit Triple DES	Specifies the symmetric encryption algorithm used to protect user data transmitted between two IPSec peers. The default is 56-bit DES-CBC, which is less secure and faster than the alternatives.
aes aes-192 ase-256		The Advanced Encryption Standard is introduced with PIX Firewall version 6.3 and supports three different key lengths of 128, 192, 256 bytes.
sha md5	SHA-1 (HMAC variant) MD5 (HMAC variant)	Specifies the hash algorithm used to ensure data integrity. The default is SHA-1. MD5 has a smaller digest and is considered to be slightly faster than SHA-1. There has been a demonstrated successful (but extremely difficult) attack against MD5; however, the HMAC variant used by IKE prevents this attack.
rsa-sig pre-share	RSA signatures pre-shared keys	Specifies the method of authentication used to establish the identity of each IPSec peer. The default, RSA signatures, provide non-repudiation for the IKE negotiation (you can prove to a third party after the fact that you had an IKE negotiation with a specific peer). Pre-shared keys do not scale well with a growing network but are easier to set up in a small network. For further information about the two authentication methods, refer to the following sections: <ul style="list-style-type: none"> • “Using IKE with Pre-Shared Keys” • “Using Certification Authorities”
1 2 5	Group 1 (768-bit Diffie-Hellman) Group 2 (1024-bit Diffie-Hellman) Group 5 (1536-bit Diffie-Hellman)	Specifies the Diffie-Hellman group identifier, which is used by the two IPSec peers to derive a shared secret without transmitting it to each other. The default, Group 1 (768-bit Diffie-Hellman) requires less CPU time to execute but is less secure than Group 2 (1024-bit Diffie-Hellman). Support for Diffie-Hellman Group 5 is introduced with PIX Firewall Version 6.3.
integer value	120 to 86,400 seconds	Specifies the SA lifetime. The default is 86,400 seconds or 24 hours. As a general rule, a shorter lifetime (up to a point) provides more secure IKE negotiations. However, with longer lifetimes, future IPSec security associations can be set up more quickly.

There is an implicit trade-off between security and performance when you choose a specific value for each parameter. The level of security provided by the default values is adequate for the security requirements of most organizations. If you are interoperating with a peer that supports only one of the values for a parameter, your choice is limited to the other peer's supported value.

You can create multiple IKE policies, each with a different combination of parameter values. For each policy that you create, you assign a unique priority (1 through 65,534, with 1 being the highest priority). If you do not configure any policies, your PIX Firewall will use the default policy, which is always set to the lowest priority, and which contains each parameter's default value. If you do not specify a value for a specific parameter, the default value is assigned.

When the IKE negotiation begins, the peer that initiates the negotiation will send all its policies to the remote peer, and the remote peer will try to find a match. The remote peer checks each of its policies in order of its priority (highest priority first) until a match is found.

A match is made when both policies from the two peers contain the same encryption, hash, authentication, and Diffie-Hellman parameter values, and when the remote peer's policy specifies a lifetime less than or equal to the lifetime in the policy being compared. If the lifetimes are not identical, the shorter lifetime—from the remote peer's policy—will be used. If no acceptable match is found, IKE refuses negotiation and the IKE SA will not be established.

Configuring IKE

To enable and configure IKE, perform the following steps:



Note

If you do not specify a value for a given policy parameter, the default value is assigned.

Step 1 Identify the policy to create. Each policy is uniquely identified by the priority number you assign.

```
isakmp policy priority
```

For example:

```
isakmp policy 20
```

Step 2 Specify the encryption algorithm:

```
isakmp policy priority encryption aes | aes-192 | aes-256 | des | 3des
```

For example:

```
isakmp policy 20 encryption des
```

Step 3 Specify the hash algorithm:

```
isakmp policy priority hash md5 | sha
```

For example:

```
isakmp policy 20 hash md5
```

Step 4 Specify the authentication method:

```
isakmp policy priority authentication pre-share | rsa-sig
```

For example:

```
isakmp policy 20 authentication rsa-sig
```

For further information about the two authentication methods, refer to the following sections:

- [“Using IKE with Pre-Shared Keys”](#)
- [“Using Certification Authorities”](#)

Step 5 Specify the Diffie-Hellman group identifier:

```
isakmp policy priority group 1 | 2 | 5
```



Note Support for Diffie-Hellman group 5 is introduced with PIX Firewall version 6.3

For example:

```
isakmp policy 20 group 2
```

Step 6 Specify the security association’s lifetime:

```
isakmp policy priority lifetime seconds
```

For example:

```
isakmp policy 20 lifetime 5000
```

The following example shows two policies with policy 20 as the highest priority, policy 30 as the next priority, and the existing default policy as the lowest priority:

```
isakmp policy 20 encryption des
isakmp policy 20 hash md5
isakmp policy 20 authentication rsa-sig
isakmp policy 20 group 2
isakmp policy 20 lifetime 5000
```

```
isakmp policy 30 authentication pre-share
isakmp policy 30 lifetime 10000
```

In this example, the encryption des of policy 20 would not appear in the written configuration because this is the default for the encryption algorithm parameter.

Step 7 (Optional) View all existing IKE policies:

```
show isakmp policy
```

The following is an example of the output after the policies 20 and 30 in the previous example were configured:

```
Protection suite priority 20
  encryption algorithm:  DES - Data Encryption Standard (56 bit keys)
  hash algorithm:        Message Digest 5
  authentication method: Rivest-Shamir-Adleman Signature
  Diffie-Hellman group:  #2 (1024 bit)
  lifetime:              5000 seconds, no volume limit
Protection suite priority 30
  encryption algorithm:  DES - Data Encryption Standard (56 bit keys)
  hash algorithm:        Secure Hash Standard
  authentication method: Pre-Shared Key
  Diffie-Hellman group:  #1 (768 bit)
  lifetime:              10000 seconds, no volume limit
```

```

Default protection suite
  encryption algorithm:  DES - Data Encryption Standard (56 bit keys)
  hash algorithm:       Secure Hash Standard
  authentication method: Rivest-Shamir-Adleman Signature
  Diffie-Hellman group:  #1 (768 bit)
  lifetime:             86400 seconds, no volume limit

```

**Note**

Although the output shows “no volume limit” for the lifetimes, you can currently only configure a time lifetime (such as 86,400 seconds) with IKE; volume limit lifetimes are not currently configurable.

Disabling IKE

To disable IKE, you must make these concessions at the peers:

- All the IPSec security associations are manually specified in the crypto maps at all peers.
- IPSec security associations will never time out for a given IPSec session.
- The encryption keys never change during IPSec sessions between peers.
- Anti-replay services will not be available between the peers.
- CA support cannot be used.

To disable IKE, use the following command:

```
no crypto isakmp enable interface-name
```

For example:

```
no crypto isakmp enable outside
```

Using IKE with Pre-Shared Keys

If you use the IKE authentication method of pre-shared keys, manually configure these keys on the PIX Firewall and its peer(s). You can specify the same key to share with multiple peers, but it is more secure to specify different keys to share between different pairs of peers. To configure a pre-shared key on the PIX Firewall, perform the following steps:

Step 1 Configure the PIX Firewall host name:

```
hostname newname
```

For example:

```
hostname mypixfirewall
```

In this example, “mypixfirewall” is the name of a unique host in the domain.

When two peers use IKE to establish IPSec security associations, each peer sends its identity to its peer. Each peer’s identity is set either to its host name or its IP address. By default, the identity of the PIX Firewall is set to its IP address. If necessary, you can change the identity to be a host name instead. As a general rule, set all peers’ identities the same way—either all peers should use their IP addresses or all peers should use their host names. If some peers use their host names and some peers use their IP addresses to identify themselves to one another, IKE negotiations could fail if a peer’s identity is not recognized and a DNS lookup is unable to resolve the identity.

Step 2 Configure the PIX Firewall domain name:

```
domain-name name
```

For example:

```
domain-name example.com
```

Step 3 Specify the pre-shared key at the PIX Firewall:

```
isakmp key keystring address peer-address [netmask mask]
```

Replace *keystring* with the password string that the PIX Firewall and its peer will use for authentication. Replace *peer-address* with the remote peer's IP address.

For example:

```
isakmp key 1234567890 address 192.168.1.100
```

The pre-shared key is 1234567890, and the peer's address is 192.168.1.100.



Note Netmask lets you configure a single key to be shared among multiple peers. You would use the netmask of 0.0.0.0. However, we strongly recommend using a unique key for each peer.

Step 4 Specify the pre-shared key at the remote IPSec peer.

If the remote peer is a PIX Firewall, use the same command as shown in Step 3.



Note

The pre-shared key should be configured at both the PIX Firewall and its peer, otherwise the policy cannot be used. Configure a pre-shared key associated with a given security gateway to be distinct from a wildcard, pre-shared key (pre-shared key plus a netmask of 0.0.0.0) used to identify and authenticate the remote VPN clients.

Using Certification Authorities

This section provides background information about certification authorities (CAs) and describes how to configure the PIX Firewall to work with a CA. It includes the following topics:

- [CA Overview, page 6-8](#)
- [Public Key Cryptography, page 6-8](#)
- [Certificates Provide Scalability, page 6-8](#)
- [Supported CA Servers, page 6-9](#)
- [Configuring the PIX Firewall to Use Certificates, page 6-9](#)

CA Overview

Certification authorities (CAs) are responsible for managing certificate requests and issuing digital certificates. A digital certificate contains information that identifies a user or device, such as a name, serial number, company, department, or IP address. A digital certificate also contains a copy of the entity's public key. A CA can be a trusted third party, such as VeriSign, or a private (in-house) CA that you establish within your organization.

Public Key Cryptography

Digital signatures, enabled by public key cryptography, provide a means to digitally authenticate devices and individual users. In public key cryptography, such as the RSA encryption system, each user has a key-pair containing both a public and a private key. The keys act as complements, and anything encrypted with one of the keys can be decrypted with the other. In simple terms, a signature is formed when data is encrypted with a user's private key. The receiver verifies the signature by decrypting the message with the sender's public key.

The fact that the message could be decrypted using the sender's public key means that the holder of the private key created the message. This process relies on the receiver having a copy of the sender's public key and knowing with a high degree of certainty that it really does belong to the sender, and not to someone pretending to be the sender.

To validate the CA's signature, the receiver must know the CA's public key. Normally this is handled out-of-band or through an operation done at installation. For instance, most web browsers are configured with the root certificates of several CAs by default. The IKE, a key component of IPSec, can use digital signatures to authenticate peer devices before setting up security associations.

Certificates Provide Scalability

Without digital certificates, each IPSec peer must be manually configured for every peer with which it communicates. Without certificates, every new peer added to the network requires a configuration change on every other peer it securely communicates with. However, when using digital certificates, each peer is enrolled with a CA. When two peers wish to communicate, they exchange certificates and digitally sign data to authenticate each other.

When a new peer is added to the network, one simply enrolls that peer with a CA, and none of the other peers need modification. When the new peer attempts an IPSec connection, certificates are automatically exchanged and the peer can be authenticated.

With a CA, a peer authenticates itself to the remote peer by sending a certificate to the remote peer and performing some public key cryptography. Each peer sends its own unique certificate which was issued and validated by the CA. This process works because each peer's certificate encapsulates the peer's public key, each certificate is authenticated by the CA, and all participating peers recognize the CA as an authenticating authority. This is called IKE with an RSA signature.

The peer can continue sending its own certificate for multiple IPSec sessions, and to multiple IPSec peers, until the certificate expires. When its certificate expires, the peer administrator must obtain a new one from the CA.

CAs can also revoke certificates for peers that will no longer participate in IPSec. Revoked certificates are not recognized as valid by other peers. Revoked certificates are listed in a certificate revocation list (CRL), which each peer may check before accepting another peer's certificate.

Some CAs have a registration authority (RA) as part of their implementation. An RA is essentially a server that acts as a proxy for the CA so that CA functions can continue when the CA is off line.

Supported CA Servers

Currently, the PIX Firewall supports the following CA servers:

- VeriSign support is provided through the VeriSign Private Certificate Services (PCS) and the OnSite service, which lets you establish an in-house CA system for issuing digital certificates.
- Entrust, Entrust VPN Connector, version 4.1 (build 4.1.0.337) or higher. The Entrust CA server is an in-house CA server solution.
- Baltimore Technologies, UniCERT Certificate Management System, version 3.1.2 or higher. The Baltimore CA server is an in-house CA server solution.
- Microsoft Windows 2000, specifically the Windows 2000 Advanced Server, version 5.00.2195 or higher. The Windows 2000 CA server is an in-house CA server solution.

**Note**

The Microsoft CA must be a standalone root CA, not subordinated, or it will be rejected and a syslog CRYPTO_PKI: WARNING message will be entered. Example: CRYPTO_PKI: WARNING: A certificate chain could not be constructed while selecting certificate status.

Configuring the PIX Firewall to Use Certificates

For site-to-site VPNs, you must perform this series of steps for each PIX Firewall. For remote access VPNs, perform these steps for each PIX Firewall and each remote access VPN client.

**Note**

You need to have a CA available to your network before you configure CA. The CA should support Cisco's PKI protocol, the simple certificate enrollment protocol.

When certificates are revoked, they are added to a certificate revocation list (CRL). When you implement authentication using certificates, you can choose to use CRLs or not. Using CRLs lets you easily revoke certificates before they expire, but the CRL is generally only maintained by the CA or its authorized registration authority (RA). If you are using CRLs and the connection to the CA or RA is not available when authentication is requested, the authentication request will fail.

**Note**

Be sure that the PIX Firewall clock is set to GMT, month, day, and year before configuring the CA. Otherwise, the CA may reject or allow certificates based on an incorrect timestamp. Cisco's PKI protocol uses the clock to make sure that a CRL is not expired. The lifetime of a certificate and CRL is checked in GMT time. If you are using IPSec with certificates, set the PIX Firewall clock to GMT to ensure that CRL checking works correctly.

Follow these steps to enable your PIX Firewall to interoperate with a CA and obtain your PIX Firewall certificate(s):

Step 1 Configure the PIX Firewall host name:

```
hostname newname
```

For example:

```
hostname mypixfirewall
```

In this example, “mypixfirewall” is the name of a unique host in the domain.

Step 2 Configure the PIX Firewall domain name:

```
domain-name name
```

For example:

```
domain-name example.com
```

Step 3 Generate the PIX Firewall RSA key pair(s):

```
ca generate rsa key key_modulus_size
```

For example:

```
ca generate rsa key 512
```

In this example, one general purpose RSA key pair is to be generated. The other option is to generate two special-purpose keys. The selected size of the key modulus is 512.

Step 4 (Optional) View your RSA key pair(s):

```
show ca mypubkey rsa
```

The following is sample output from the **show ca mypubkey rsa** command:

```
show ca mypubkey rsa
```

```
% Key pair was generated at: 15:34:55 Aug 05 1999
```

```
Key name: mypixfirewall.example.com
```

```
Usage: General Purpose Key
```

```
Key Data:
```

```
305c300d 06092a86 4886f70d 01010105 00034b00 30480241 00c31f4a ad32f60d
6e7ed9a2 32883ca9 319a4b30 e7470888 87732e83 c909fb17 fb5cae70 3de738cf
6e2fd12c 5b3ffa98 8c5adc59 1ec84d78 90bdb53f 2218cfe7 3f020301 0001
```

Step 5 Declare a CA:

```
ca identity ca_nickname ca_ipaddress [:ca_script_location] [ldap_ip address]
```

For example:

```
ca identity myca.example.com 209.165.202.130
```

In this example, 209.165.202.130 is the IP address of the CA. The CA name is myca.example.com.



Note The CA may require a particular name for you to use, such as its domain name. When using VeriSign as your CA, VeriSign assigns the CA name you are to use in your CA configuration.

Step 6 Configure the parameters of communication between the PIX Firewall and the CA:

```
ca configure ca_nickname ca | ra retry_period retry_count [crloptional]
```

For example:

```
ca configure myca.example.com ca 1 20 crloptional
```

If the PIX Firewall does not receive a certificate from the CA within 1 minute (the default) of sending a certificate request, it will resend the certificate request. The PIX Firewall will continue sending a certificate request every 1 minute until a certificate is received or until 20 requests have been sent. With the keyword **crloptional** included within the command statement, other peer's certificates can still be accepted by your PIX Firewall even if the CRL is not accessible to your PIX Firewall.

Step 7 Authenticate the CA by obtaining its public key and its certificate:

```
ca authenticate ca_nickname [fingerprint]
```

For example:

```
ca authenticate myca.example.com 0123 4567 89AB CDEF 0123
```

The fingerprint (0123 4567 89AB CDEF 0123 in the example) is optional and is used to authenticate the CA's public key within its certificate. The PIX Firewall will discard the CA certificate if the fingerprint that you included in the command statement is not equal to the fingerprint within the CA's certificate.

You also have the option to manually authenticate the public key by simply comparing the two fingerprints after you receive the CA's certificate rather than entering it within the command statement.



Note Depending on the CA you are using, you may need to ask your local CA administrator for this fingerprint.

Step 8 Request signed certificates from your CA for all of your PIX Firewall's RSA key pairs. Before entering this command, contact your CA administrator because they must authenticate your PIX Firewall manually before granting its certificate(s).

```
ca enroll ca_nickname challenge_password [serial] [ipaddress]
```

For example:

```
ca enroll myca.example.com mypassword1234567 serial ipaddress
```

The keyword `mypassword1234567` in the example is a password, which is not saved with the configuration. The options "serial" and "ipaddress" are included, which indicates the PIX Firewall unit's serial number and IP address will be included in the signed certificate.



Note The password is required in the event your certificate needs to be revoked, so it is crucial that you remember this password. Note it and store it in a safe place.

The **ca enroll** command requests as many certificates as there are RSA key pairs. You will only need to perform this command once, even if you have special usage RSA key pairs.



Note If your PIX Firewall reboots after you issued the **ca enroll** command but before you received the certificate(s), reissue the command and notify the CA administrator.

Step 9 Verify that the enrollment process was successful using the **show ca certificate** command:

```
show ca certificate
```

The following is sample output from the **show ca certificate** command including a PIX Firewall general purpose certificate and the RA and CA public-key certificates:

```
Subject Name
  Name: mypixfirewall.example.com
IP Address: 192.150.50.110
Status: Available
Certificate Serial Number: 36f97573
Key Usage: General Purpose

RA Signature Certificate
Status: Available
Certificate Serial Number: 36f972f4
Key Usage: Signature

CA Certificate
Status: Available
Certificate Serial Number: 36f972e5
Key Usage: Not Set

RA KeyEncipher Certificate
Status: Available
Certificate Serial Number: 36f972f3
Key Usage: Encryption
```

Step 10 Save the configuration:

```
ca save all
write memory
```

Verifying the Distinguished Name of a Certificate

PIX Firewall Version 6.3 lets you specify the distinguished name (DN) of the certificate used to establish a VPN tunnel. We recommend enabling this feature to prevent a possible “man-in-the-middle” attack.

To verify the DN of the certificate received by your PIX Firewall, enter the following command:

```
ca verifycertdn x500 string
```



Note

Every attribute must match exactly to verify the certificate received and to establish a VPN tunnel.

For example, a PIX Firewall might have the following certificate:

```
Certificate
Status: Available
Certificate Serial Number: 4ebdbd400000000000a2
Key Usage: General Purpose
Subject Name:
  CN = myvpn01.myorg.com
  OU = myou
  O = myorg
  ST = CA
  C = US
```

```
UNSTRUCTURED NAME = myvpn01.myorg.com
Validity Date:
  start date: 23:48:00 UTC Feb 18 2003
  end   date: 23:58:00 UTC Feb 18 2004
-----
```

To establish a VPN tunnel with this server, enter the following command on the PIX Firewall that will receive this certificate:

```
ca verifycertdn cn*myvpn, ou=myou, o=myorg, st=ca, c=US
```

This command causes the receiving PIX Firewall to accept certificates with any DN having the following attributes:

- Common name (CN) contains the string *myvpn*
- Organizational unit (OU) equals *myou*
- Organization (O) equals *myorg*
- State (ST) equals *CA*
- Country (C) equals *US*

You could be more restrictive by identifying a specific common name, or less restrictive by omitting the CN attribute altogether.

You can use an asterisk (*) to match an attribute containing the string following the asterisk. Use an exclamation mark (!) to match an attribute that does not contain the characters following the exclamation mark.

Configuring IPsec

This section provides background information about IPsec and describes the procedures required to configure the PIX Firewall when using IPsec to implement a VPN. It contains the following topics:

- [IPsec Overview, page 6-14](#)
- [Transform Sets, page 6-15](#)
- [Crypto Maps, page 6-15](#)
- [Applying Crypto Maps to Interfaces, page 6-17](#)
- [Access Lists, page 6-17](#)
- [IPsec SA Lifetimes, page 6-19](#)
- [Basic IPsec Configuration, page 6-20](#)
- [Diffie-Hellman Group 5, page 6-22](#)
- [Using Dynamic Crypto Maps, page 6-23](#)
- [Site-to-Site Redundancy, page 6-25](#)

IPSec Overview

IPSec tunnels are sets of security associations that are established between two remote IPSec peers. The security associations define which protocols and algorithms should be applied to sensitive packets, and also specify the keying material to be used by the two peers. IPSec SAs are used during the actual transmission of user traffic. SAs are unidirectional and are established separately for different security protocols (AH and/or ESP).

You can establish IPSec SAs in two ways:

- **Manual SAs with Pre-Shared Keys** —The use of manual IPSec SAs requires a prior agreement between administrators of the PIX Firewall and the IPSec peer. There is no negotiation of SAs, so the configuration information in both systems should be the same for traffic to be processed successfully by IPSec.
- **IKE-Established SAs**—When IKE is used to establish IPSec SAs, the peers can negotiate the settings they will use for the new security associations. This means that you can specify lists (such as lists of acceptable transforms) within the crypto map entry.

The PIX Firewall can simultaneously support manual and IKE-established security associations.

Transform Sets

A transform set represents a certain combination of security protocols and algorithms. During the IPSec security association negotiation, the peers agree to use a particular transform set for protecting a particular data flow.

You can specify multiple transform sets, and then specify one or more of these transform sets in a crypto map entry. The transform set defined in the crypto map entry will be used in the IPSec security association negotiation to protect the data flows specified by that crypto map entry's access list.

During IPSec security association negotiations with IKE, the peers search for a transform set that is the same at both peers. When such a transform set is found, it is selected and will be applied to the protected traffic as part of both peers' IPSec security associations. With manually established security associations, there is no negotiation with the peer, so both sides have to specify the same transform set.

If you change a transform set definition, the change will not be applied to existing security associations, but will be used in subsequent negotiations to establish new security associations. If you want the new settings to take effect sooner, clear all or part of the security association database by using the **clear [crypto] ipsec sa** command. See "[Clearing SAs](#)" for further information.

Crypto Maps

Crypto maps specify IPSec policy. Crypto map entries created for IPSec pull together the various parts used to set up IPSec security associations, including the following:

- Which traffic should be protected by IPSec (per a crypto access list)
- Where IPSec-protected traffic should be sent (who the peer is)
- The local address to be used for the IPSec traffic (See "[Applying Crypto Maps to Interfaces](#)" for more details.)
- What IPSec security should be applied to this traffic (selecting from a list of one or more transform sets)
- Whether security associations are manually established or are established via IKE
- Other parameters that might be necessary to define an IPSec SA

Crypto map entries with the same crypto map name (but different map sequence numbers) are grouped into a crypto map set. Later, you will apply these crypto map sets to interfaces; then, all IP traffic passing through the interface is evaluated against the applied crypto map set. If a crypto map entry sees outbound IP traffic that should be protected and the crypto map specifies the use of IKE, a security association is negotiated with the peer according to the parameters included in the crypto map entry; otherwise, if the crypto map entry specifies the use of manual security associations, a security association should have already been established via configuration. (If a dynamic crypto map entry sees outbound traffic that should be protected and no security association exists, the packet is dropped.)

The policy described in the crypto map entries is used during the negotiation of security associations. If the local PIX Firewall initiates the negotiation, it will use the policy specified in the static crypto map entries to create the offer to be sent to the specified peer. If the peer initiates the negotiation, the PIX Firewall will check the policy from the static crypto map entries, as well as any referenced dynamic crypto map entries to decide whether to accept or reject the peer's request (offer).

For IPSec to succeed between two peers, both peers' crypto map entries have to contain compatible configuration statements.

When two peers try to establish a security association, they should each have at least one crypto map entry that is compatible with one of the other peer's crypto map entries. For two crypto map entries to be compatible, they should, at a minimum, meet the following criteria:

- The crypto map entries contain compatible crypto access lists (for example, mirror image access lists). In the case where the responding peer is using dynamic crypto maps, the entries in the PIX Firewall crypto access list must be "permitted" by the peer's crypto access list.
- The crypto map entries each identify the other peer (unless the responding peer is using dynamic crypto maps).
- The crypto map entries have at least one transform set in common.

You can apply only one crypto map set to a single interface. The crypto map set can include a combination of IPSec/IKE and IPSec/manual entries.

If you create more than one crypto map entry for a given interface, use the seq-num of each map entry to rank the map entries: the lower the seq-num, the higher the priority. At the interface that has the crypto map set, traffic is evaluated against higher priority map entries first.

Create multiple crypto map entries for a given PIX Firewall interface, if any of the following conditions exist:

- If different data flows are to be handled by separate peers.
- If you want to apply different IPSec security to different types of traffic (to the same or separate peers); for example, if you want traffic between one set of subnets to be authenticated, and traffic between another set of subnets to be both authenticated and encrypted. In this case, the different types of traffic should have been defined in two separate access lists, and you create a separate crypto map entry for each crypto access list.
- If you are configuring manual SAs to establish a particular set of IPSec security associations, and want to specify multiple access list entries, create separate access lists (one per permit entry) and specify a separate crypto map entry for each access list.

Applying Crypto Maps to Interfaces

You must apply a crypto map set to each interface through which IPSec traffic will flow. The PIX Firewall supports IPSec on all of its interfaces. Applying the crypto map set to an interface instructs the PIX Firewall to evaluate all the interface's traffic against the crypto map set and to use the specified policy during connection or security association negotiation on behalf of traffic to be protected by crypto IPSec.

Binding a crypto map to an interface will also initialize the run-time data structures, such as the security association database and the security policy database. If the crypto map is modified in any way, reapplying the crypto map to the interface will resynchronize the various run-time data structures with the crypto map configuration. In addition, any existing connections will be torn down and will be reestablished after the new crypto map is triggered.

Access Lists

By default, IPSec and all packets that traverse the PIX Firewall are subjected to blocking as specified by access lists. To enable IPSec packets to traverse the PIX Firewall, ensure that you have statements in access lists that permit the packets. Optionally, the **sysopt connection permit-ipsec** command can be configured to enable IPSec packets to bypass access list blocking.



Note

The **sysopt connection permit-ipsec** command enables packets that have been processed by IPSec to bypass access list checks.

IPSec packets that are destined to an IPSec tunnel are selected by the crypto map access list bound to the outgoing interface. IPSec packets that arrive from an IPSec tunnel are authenticated/deciphered by IPSec, and are subjected to the proxy identity match of the tunnel.

Crypto access lists are used to define which IP traffic will be protected by crypto and which traffic will not be protected by crypto. For example, access lists can be created to protect all IP traffic between Subnet A and Subnet Y or between Host A and Host B. (These access lists are similar to access lists used with the **access-group** command. With the **access-group** command, the access list determines which traffic to forward or block at an interface.)

The access lists themselves are not specific to IPSec. It is the crypto map entry referencing the specific access list that defines whether IPSec processing is applied to the traffic matching a permit in the access list.

Crypto access lists associated with IPSec crypto map entries have four primary functions:

- Select outbound traffic to be protected by IPSec (permit = protect).
- Indicate the data flow to be protected by the new security associations (specified by a single permit entry) when initiating negotiations for IPSec security associations.
- Process inbound traffic to filter out and discard traffic that should have been protected by IPSec.
- Determine whether or not to accept requests for IPSec security associations on behalf of the requested data flows when processing IKE negotiation from the peer. (Negotiation is only done for **ipsec-isakmp crypto map** entries.) For the peer's request to be accepted during negotiation, the peer should specify a data flow that is "permitted" by a crypto access list associated with an **ipsec-isakmp crypto map** command entry.

If you want certain traffic to receive one combination of IPSec protection (for example, authentication only) and other traffic to receive a different combination of IPSec protection (for example, both authentication and encryption), you must create two different crypto access lists to define the two different types of traffic. These different access lists are then used in different crypto map entries which specify different IPSec policies.

Using the **permit** keyword causes all IP traffic that matches the specified conditions to be protected by crypto, using the policy described by the corresponding crypto map entry. Using the **deny** keyword prevents traffic from being protected by crypto IPSec in the context of that particular crypto map entry. (In other words, it does not allow the policy as specified in this crypto map entry to be applied to this traffic.) If this traffic is denied in all the crypto map entries for that interface, the traffic is not protected by crypto IPSec.

The crypto access list you define will be applied to an interface after you define the corresponding crypto map entry and apply the crypto map set to the interface. Different access lists should be used in different entries of the same crypto map set. However, both inbound and outbound traffic will be evaluated against the same “outbound” IPSec access list.

Therefore, the access list’s criteria are applied in the forward direction to traffic exiting your PIX Firewall, and the reverse direction to traffic entering your PIX Firewall. In [Figure 6-1](#), IPSec protection is applied to traffic between Host 10.0.0.1 and Host 10.2.2.2 as the data exits PIX Firewall A’s outside interface toward Host 10.2.2.2. For traffic from Host 10.0.0.1 to Host 10.2.2.2, the access list entry on PIX Firewall A is evaluated as follows:

source = host 10.0.0.1

dest = host 10.2.2.2

For traffic from Host 10.2.2.2 to Host 10.0.0.1, that same access list entry on PIX Firewall A is evaluated as follows:

source = host 10.2.2.2

dest = host 10.0.0.1

Figure 6-1 How Crypto Access Lists Are Applied for Processing IPSec

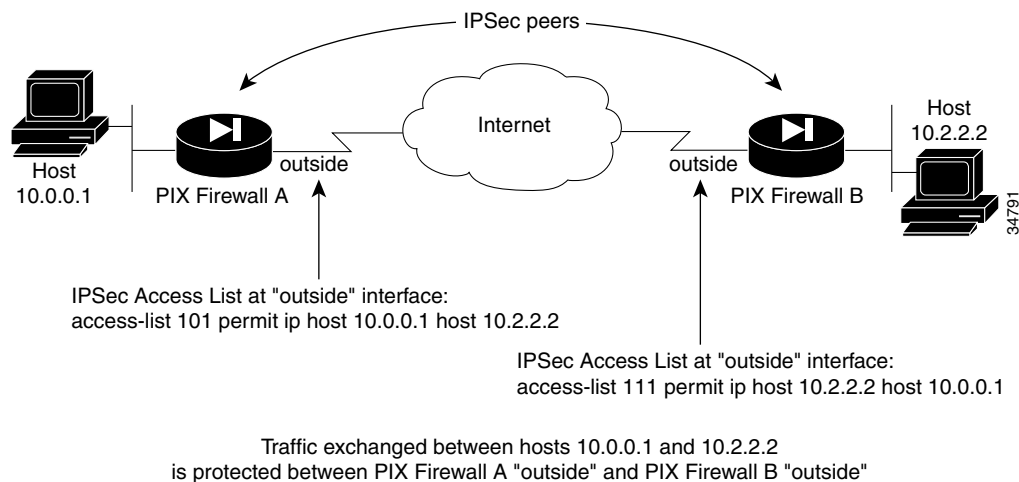

If you configure multiple statements for a given crypto access list that is used for IPSec, in general the first permit statement that is matched will be the statement used to determine the scope of the IPSec security association. That is, the IPSec security association will be set up to protect traffic that meets the

criteria of the matched statement only. Later, if traffic matches a different permit statement of the crypto access list, a new, separate IPSec security association will be negotiated to protect traffic matching the newly matched access list statement.

Any unprotected inbound traffic that matches a permit entry in the crypto access list for a crypto map entry flagged as IPSec will be dropped because this traffic was expected to be protected by IPSec.

Access lists for crypto map entries tagged as `ipsec-manual` are restricted to a single permit entry and subsequent entries are ignored. In other words, the security associations established by that particular crypto map entry are only for a single data flow. To support multiple manually established security associations for different kinds of traffic, define multiple crypto access lists, and apply each one to a separate **ipsec-manual crypto map** command entry. Each access list should include one permit statement defining which traffic to protect.

**Note**

If you clear or delete the last element from an access list, the crypto map references to the destroyed access list are also removed.

If you modify an access list that is currently referenced by one or more crypto map entries, the run-time security association database will need to be re initialized using the **crypto map interface** command. See the **crypto map** command page for more information.

We recommend that for every crypto access list specified for a static crypto map entry that you define at the local peer, you define a “mirror image” crypto access list at the remote peer. This ensures that traffic that has IPSec protection applied locally can be processed correctly at the remote peer. (The crypto map entries themselves should also support common transforms and refer to the other system as a peer.)

**Note**

Every static crypto map must define an access list and an IPsec peer. If either is missing, the crypto map is considered incomplete and any traffic that has not already been matched to an earlier, complete crypto map is dropped. Use the **show conf** command to ensure that every crypto map is complete. To fix an incomplete crypto map, remove the crypto map, add the missing entries, and reapply it.

When you create crypto access lists, using the **any** keyword could cause problems. We discourage the use of the **any** keyword to specify source or destination addresses.

The **permit any any** command statement is strongly discouraged, as this will cause all outbound traffic to be protected (and all protected traffic sent to the peer specified in the corresponding crypto map entry) and will require protection for all inbound traffic. Then, all inbound packets that lack IPSec protection will be silently dropped.

You must be sure that you define which packets to protect. If you use the **any** keyword in a **permit** command statement, preface that statement with a series of **deny** command statements to filter out any traffic (that would otherwise fall within that **permit** command statement) that you do not want to be protected.

IPSec SA Lifetimes

You can change the global lifetime values that are used when negotiating new IPSec security associations. (These global lifetime values can be overridden for a particular crypto map entry.)

These lifetimes only apply to security associations established via IKE. Manually established security associations do not expire.

There are two lifetimes: a “timed” lifetime and a “traffic-volume” lifetime. A security association expires after the respective lifetime is reached and negotiations will be initiated for a new one. The default lifetimes are 28,800 seconds (eight hours) and 4,608,000 kilobytes (10 megabytes per second for one hour).

If you change a global lifetime, the new lifetime value will not be applied to currently existing security associations, but will be used in the negotiation of subsequently established security associations. If you wish to use the new values immediately, you can clear all or part of the security association database. See the **clear [crypto] ipsec sa** command for more information within the **crypto ipsec** command page of *Cisco PIX Firewall Command Reference*.

IPSec security associations use one or more shared secret keys. These keys and their security associations time out together.

Assuming that the particular crypto map entry does not have lifetime values configured, when the PIX Firewall requests new security associations it will specify its global lifetime values in the request to the peer; it will use this value as the lifetime of the new security associations. When the PIX Firewall receives a negotiation request from the peer, it will use the smaller of either the lifetime value proposed by the peer or the locally configured lifetime value as the lifetime of the new security associations.

The security association and the corresponding keys expire after a configurable interval of time or after forwarding a configurable volume of traffic.

A new security association is negotiated before the lifetime threshold of the existing security association is reached to ensure that a new security association is ready for use when the old one expires. The new security association is negotiated either 30 seconds before the seconds lifetime expires or when the volume of traffic through the tunnel reaches 256 kilobytes less than the kilobytes lifetime (whichever occurs first).

If no traffic has passed through the tunnel during the entire life of the security association, a new security association is not negotiated when the lifetime expires. Instead, a new security association will be negotiated only when IPSec sees another packet that should be protected.

Basic IPSec Configuration

The following steps cover basic IPSec configuration where the IPSec security associations are established with IKE and static crypto maps are used. For information about configuring IPSec for specific implementations, see the following chapters:

- [Chapter 7, “Site-to-Site VPN Configuration Examples.”](#)
- [Chapter 8, “Managing VPN Remote Access.”](#)

In general, to configure the PIX Firewall for using IPSec, perform the following steps:

Step 1 Create an access list to define the traffic to protect:

```
access-list access-list-name {deny | permit} ip source source-netmask destination destination-netmask
```

For example:

```
access-list 101 permit ip 10.0.0.0 255.255.255.0 10.1.1.0 255.255.255.0
```

In this example, the **permit** keyword causes all traffic that matches the specified conditions to be protected by crypto.

- Step 2** Configure a transform set that defines how the traffic will be protected. You can configure multiple transform sets, and then specify one or more of these transform sets in a crypto map entry (Step 3d).

```
crypto ipsec transform-set transform-set-name transform1 [transform2, transform3]
```

For example:

```
crypto ipsec transform-set myset1 esp-des esp-sha-hmac
crypto ipsec transform-set myset2 ah-sha-hmac esp-3des esp-sha-hmac
crypto ipsec transform-set aes_set ah-md5-hmac esp-aes-256
```



Note PIX Firewall version 6.3 introduces support for AES, which provides for encryption keys of 128, 192, and 256 bits.

In this example, “myset1” and “myset2” are the names of the transform sets. “myset1” has two transforms defined, while “myset2” has three transforms defined.

- Step 3** Create a crypto map entry by performing the following steps:

- a. Create a crypto map entry in IPSec ISAKMP mode:

```
crypto map map-name seq-num ipsec-isakmp
```

For example:

```
crypto map mymap 10 ipsec-isakmp
```

In this example, “mymap” is the name of the crypto map set. The map set’s sequence number is 10, which is used to rank multiple entries within one crypto map set. The lower the sequence number, the higher the priority.

- b. Assign an access list to a crypto map entry:

```
crypto map map-name seq-num match address access-list-name
```

For example:

```
crypto map mymap 10 match address 101
```

In this example, access list 101 is assigned to crypto map “mymap.”

- c. Specify the peer to which the IPSec protected traffic can be forwarded:

```
crypto map map-name seq-num set peer ip-address
```

For example:

```
crypto map mymap 10 set peer 192.168.1.100
```

The security association will be set up with the peer having an IP address of 192.168.1.100. Specify multiple peers by repeating this command.

- d. Specify which transform sets are allowed for this crypto map entry. List multiple transform sets in order of priority (highest priority first). You can specify up to six transform sets.

```
crypto map map-name seq-num set transform-set transform-set-name1
[transform-set-name2, ...transform-set-name6]
```

For example:

```
crypto map mymap 10 set transform-set myset1 myset2
```

In this example, when traffic matches access list 101, the security association can use either “myset1” (first priority) or “myset2” (second priority) depending on which transform set matches the peer’s transform set.

- e. (Optional) Specify security association lifetime for the crypto map entry, if you want the security associations for this entry to be negotiated using different IPSec security association lifetimes other than the global lifetimes.

```
crypto map map-name seq-num set security-association lifetime {seconds seconds |
kilobytes kilobytes}
```

For example:

```
crypto map mymap 10 set security-association lifetime seconds 2700
```

This example shortens the timed lifetime for the crypto map “mymap 10” to 2700 seconds (45 minutes). The traffic volume lifetime is not changed.

- f. (Optional) Specify that IPSec should ask for perfect forward secrecy (PFS) when requesting new security associations for this crypto map entry, or should require PFS in requests received from the peer:

```
crypto map map-name seq-num set pfs [group1 | group2 | group5]
```



Note Support for Diffie-Hellman group 5 is introduced with PIX Firewall version 6.3.

For example:

```
crypto map mymap 10 set pfs group2
```

This example specifies that PFS should be used whenever a new security association is negotiated for the crypto map “mymap 10.” The 1024-bit Diffie-Hellman prime modulus group will be used when a new security association is negotiated using the Diffie-Hellman exchange.

- Step 4** Apply a crypto map set to an interface on which the IPSec traffic will be evaluated:

```
crypto map map-name interface interface-name
```

For example:

```
crypto map mymap interface outside
```

In this example, the PIX Firewall will evaluate the traffic going through the outside interface against the crypto map “mymap” to determine whether it needs to be protected.

- Step 5** Specify that IPSec traffic be implicitly trusted (permitted):

```
sysopt connection permit-ipsec
```

Diffie-Hellman Group 5

Diffie-Hellman is a public key operation that provides a method for two IPSec peers to agree on a key to use. To perform the Diffie-Hellman operation, both sides must agree to use a number or group for the mathematical calculation. Versions of PIX Firewall prior to Version 6.3 support group 1 (768 bits) and group 2 (1024 bits). PIX Firewall Version 6.3 introduces support for Group 5 (1536 bits), which provides higher security for the Diffie-Hellman operation. In version 6.3, PIX Firewall also supports AES (Advance Encryption Standard) which provides cryptographic keys of 256 bits and which requires the use of Diffie-Hellman Group 5 keys.

Using Dynamic Crypto Maps

Dynamic crypto maps, used with IKE, can ease IPSec configuration and are recommended for use in networks where the peers are not always predetermined. You use dynamic crypto maps for VPN clients (such as mobile users) and routers that obtain dynamically assigned IP addresses. For an example of using dynamic crypto maps in a remote access VPN configuration, see [Chapter 8, “Managing VPN Remote Access.”](#)

**Note**

Use care when using the **any** keyword in **permit** command entries in dynamic crypto maps. If it is possible for the traffic covered by such a **permit** command entry to include multicast or broadcast traffic, the access list should include **deny** command entries for the appropriate address range. Access lists should also include **deny** command entries for network and subnet broadcast traffic, and for any other traffic that should not be IPSec protected.

Dynamic crypto maps can only be used for negotiating SAs with remote peers that initiate the connection. They cannot be used for initiating connections to a remote peer. With a dynamic crypto map entry, if outbound traffic matches a permit statement in an access list and the corresponding security association is not yet established, the PIX Firewall will drop the traffic.

A dynamic crypto map entry is essentially a crypto map entry without all the parameters configured. It acts as a policy template where the missing parameters are later dynamically configured (as the result of an IPSec negotiation) to match a peer's requirements. This allows peers to exchange IPSec traffic with the PIX Firewall even if the PIX Firewall does not have a crypto map entry specifically configured to meet all the peer's requirements.

**Note**

Only the **transform-set** parameter is required to be configured within each dynamic crypto map entry.

A dynamic crypto map set is included by reference as part of a crypto map set. Any crypto map entries that reference dynamic crypto map sets should be the lowest priority crypto map entries in the crypto map set (that is, have the highest sequence numbers) so that the other crypto map entries are evaluated first; that way, the dynamic crypto map set is examined only when the other (static) map entries are not successfully matched.

If the PIX Firewall accepts the peer's request at the point that it installs the new IPSec security associations, it also installs a temporary crypto map entry. This entry is filled in with the results of the negotiation. At this point, the PIX Firewall performs normal processing, using this temporary crypto map entry as a normal entry, even requesting new security associations if the current ones are expiring (based upon the policy specified in the temporary crypto map entry). Once the flow expires (that is, all the corresponding security associations expire), the temporary crypto map entry is then removed.

Dynamic crypto map entries, like regular static crypto map entries, are grouped into sets. A set is a group of dynamic crypto map entries all with the same dynamic-map-name but each with a different dynamic-seq-num. If this is configured, the data flow identity proposed by the IPSec peer should fall within a **permit** statement for this crypto access list. If this is not configured, the PIX Firewall will accept any data flow identity proposed by the peer.

You can add one or more dynamic crypto map sets into a crypto map set via crypto map entries that reference the dynamic crypto map sets. You should set the crypto map entries referencing dynamic maps to be the lowest priority entries in a crypto map set (that is, use the highest sequence numbers).

**Note**

Use care when using the **any** keyword in **permit** entries in dynamic crypto maps. If it is possible for the traffic covered by such a **permit** entry to include multicast or broadcast traffic, the access list should include deny entries for the appropriate address range. Access lists should also include **deny** entries for network and subnet broadcast traffic, and for any other traffic that should not be IPSec protected.

The procedure for using a crypto dynamic map entry is the same as the basic configuration described in “[Basic IPSec Configuration](#),” except that instead of creating a static crypto map entry, you create a crypto dynamic map entry. You can also combine static and dynamic map entries within a single crypto map set.

Create a crypto dynamic map entry by performing the following steps:

Step 1 Assign an access list to a dynamic crypto map entry:

```
crypto dynamic-map dynamic-map-name dynamic-seq-num match address access-list-name
```

This determines which traffic should be protected and not protected.

For example:

```
crypto dynamic-map dyn1 10 match address 101
```

In this example, access list 101 is assigned to dynamic crypto map “dyn1.” The map’s sequence number is 10.

Step 2 Specify which transform sets are allowed for this dynamic crypto map entry. List multiple transform sets in order of priority (highest priority first).

```
crypto dynamic-map dynamic-map-name dynamic-seq-num set transform-set transform-set-name1,  
[transform-set-name2, ...transform-set-name9]
```

For example:

```
crypto dynamic-map dyn 10 set transform-set myset1 myset2
```

In this example, when traffic matches access list 101, the security association can use either “myset1” (first priority) or “myset2” (second priority) depending on which transform set matches the peer’s transform sets.

Step 3 Specify security association lifetime for the crypto dynamic map entry, if you want the security associations for this entry to be negotiated using different IPSec security association lifetimes other than the global lifetimes:

```
crypto dynamic-map dynamic-map-name dynamic-seq-num set security-association lifetime  
{seconds seconds | kilobytes kilobytes}
```

For example:

```
crypto dynamic-map dyn1 10 set security-association lifetime 2700
```

This example shortens the timed lifetime for dynamic crypto map “dyn1 10” to 2700 seconds (45 minutes). The time volume lifetime is not changed.

- Step 4** Specify that IPSec should ask for PFS when requesting new security associations for this dynamic crypto map entry, or should demand PFS in requests received from the peer:

```
crypto dynamic-map dynamic-map-name dynamic-seq-num set pfs [group1 | group2]
```

For example:

```
crypto dynamic-map dyn1 10 set pfs group1
```

- Step 5** Add the dynamic crypto map set into a static crypto map set.

Be sure to set the crypto map entries referencing dynamic maps to be the lowest priority entries (highest sequence numbers) in a crypto map set.

```
crypto map map-name seq-num ipsec-isakmp dynamic dynamic-map-name
```

For example:

```
crypto map mymap 200 ipsec-isakmp dynamic dyn1
```

Site-to-Site Redundancy

You can define multiple peers by using crypto maps to allow for redundancy. This configuration is also most useful for site-to-site VPNs. If one peer fails, there will still be a protected path. The peer that packets are actually sent to is determined by the last peer that the PIX Firewall heard from (received either traffic or a negotiation request from) for a given data flow. If the attempt fails with the first peer, IKE tries the next peer on the crypto map list.

Using NAT Traversal

Network Address Translation (NAT) and Port Address Translation (PAT) are implemented in many networks where IPSec is also used, but the a number of incompatibilities that prevent IPSec packets from successfully traversing a NAT device.

PIX Firewall Version 6.3 provides a feature called “Nat Traversal,” as described by Version 2 and Version 3 of the draft IETF standard, UDP Encapsulation of IPsec Packets,” which is available at the following URL:

<http://www.ietf.org/html.charters/ipsec-charter.html>

NAT Traversal allows ESP packets to pass through one or more NAT devices. This feature is disabled by default.



Note

NAT Traversal is supported for both dynamic and static crypto maps.

To enable NAT traversal, enter the following command:

```
isakmp nat-traversal [natkeepalive]
```

Valid values for *natkeepalive* are 10 to 3600 seconds; the default is 20 seconds.

Manual Configuration of SAs

When you cannot use IKE to establish SAs between your PIX Firewall and a remote IPSec peer, you can manually configure the SAs. This is only practical with a limited number of IPSec peers having known IP addresses (or DNS host names), so this method of configuration is most practical for site-to-site VPNs.

Manually configuring SAs is very similar to the basic configuration described in “[Configuring IPSec](#).” The following are the main differences:

- The crypto map is configured using the **ipsec-manual** keyword, as in the following example:

```
crypto map map-name seq-num ipsec-manual
```

- SA lifetimes and perfect forward secrecy (PFS) are not configurable
- You manually configure the session keys on both IPSec peers

When you manually configure SAs, you lose the benefits of enhanced security and scalability that IKE can provide. Manually configure each pair of IPSec peers that communicate securely, and session keys do not change unless you manually reconfigure the SAs.



Note

Manual configuration of SAs is not supported on the PIX 501 because of the restriction in the number of ISAKMP peers allowed on that platform.

To manually configure SAs, perform the following steps:

- Step 1** Create an access list to define the traffic to protect:

```
access-list access-list-name {deny | permit} ip source source-netmask destination
destination-netmask
```

For example:

```
access-list 101 permit ip 10.0.0.0 255.255.255.0 10.1.1.0 255.255.255.0
```

In this example, the **permit** keyword causes all traffic that matches the specified conditions to be protected by crypto.

- Step 2** Configure a transform set that defines how the traffic will be protected. You can configure multiple transform sets, and then specify one or more of these transform sets in a crypto map entry (Step 4d).

```
crypto ipsec transform-set transform-set-name transform1 [transform2, transform3]
```

For example:

```
crypto ipsec transform-set myset1 esp-des esp-sha-hmac
crypto ipsec transform-set myset2 ah-sha-hmac esp-3des esp-sha-hmac
```

In this example, “myset1” and “myset2” are the names of the transform sets. “myset1” has two transforms defined, while “myset2” has three transforms defined.

Step 3 Create a crypto map entry by performing the following steps:

- a. Create a crypto map entry in IPSec manual configuration mode:

```
crypto map map-name seq-num ipsec-manual
```

For example:

```
crypto map mymap 10 ipsec-manual
```

In this example, “mymap” is the name of the crypto map set. The map set’s sequence number is 10, which is used to rank multiple entries within one crypto map set. The lower the sequence number, the higher the priority.

- b. Assign an access list to a crypto map entry:

```
crypto map map-name seq-num match address access-list-name
```

For example:

```
crypto map mymap 10 match address 101
```

In this example, access list 101 is assigned to crypto map “mymap.”

- c. Specify the peer to which the IPSec protected traffic can be forwarded:

```
crypto map map-name seq-num set peer ip-address
```

For example:

```
crypto map mymap 10 set peer 192.168.1.100
```

The security association will be set up with the peer having an IP address of 192.168.1.100. Specify multiple peers by repeating this command.

- d. Specify which transform sets are allowed for this crypto map entry. List multiple transform sets in order of priority (highest priority first). You can specify up to six transform sets.

```
crypto map map-name seq-num set transform-set transform-set-name1
[transform-set-name2, ...transform-set-name6]
```

For example:

```
crypto map mymap 10 set transform-set myset1 myset2
```

In this example, when traffic matches access list 101, the security association can use either “myset1” (first priority) or “myset2” (second priority) depending on which transform set matches the peer’s transform set.

Step 4 If the specified transform set includes the AH protocol (authentication via MD5-HMAC or SHA-HMAC), set the AH Security Parameter Index (SPI) and key to apply to inbound protected traffic. If the specified transform set includes only the ESP protocol, skip to [Step 6](#).

```
crypto map map-name seq-num set session-key inbound ah spi hex-key-data
```

For example:

```
crypto map mymaptwo 30 set session-key inbound ah 300
123456789A123456789A123456789A123456789A
```

In this example, the IPSec session key for AH protocol is specified within crypto map “mymaptwo” to be used with the inbound protected traffic.

Step 5 Set the AH SPIs and keys to apply to outbound protected traffic:

```
crypto map map-name seq-num set session-key outbound ah spi hex-key-data
```

For example:

```
crypto map mymaptwo 30 set session-key outbound ah 400
123456789A123456789A123456789A123456789A
```

Step 6 If the specified transform set includes the ESP protocol, set the ESP SPIs and keys to apply to inbound protected traffic. If the transform set includes an ESP cipher algorithm, specify the cipher keys. If the transform set includes an ESP authenticator algorithm, specify the authenticator keys.

```
crypto map map-name seq-num set session-key inbound esp spi cipher hex-key-data
[authenticator hex-key-data]
```

For example:

```
crypto map mymaptwo 30 set session-key inbound esp 300 cipher 1234567890123456
authenticator 0000111122223333444455556666777788889999
```

Step 7 Set the ESP SPIs and keys to apply to outbound protected traffic. If the transform set includes an ESP cipher algorithm, specify the cipher keys. If the transform set includes an ESP authenticator algorithm, specify the authenticator keys.

```
crypto map map-name seq-num set session-key outbound esp spi cipher hex-key-data
[authenticator hex-key-data]
```

For example:

```
crypto map mymaptwo 30 set session-key outbound esp 300 cipher abcdefghijklmnop
authenticator 9999888877776666555544443333222211110000
```

Step 8 Apply a crypto map set to an interface on which the IPSec traffic will be evaluated:

```
crypto map map-name interface interface-name
```

For example:

```
crypto map mymap interface outside
```

In this example, the PIX Firewall will evaluate the traffic going through the outside interface against the crypto map “mymap” to determine whether it needs to be protected.

Step 9 Specify that IPSec traffic be implicitly trusted (permitted):

```
sysopt connection permit-ipsec
```



Note

This command also permits L2TP/IPSec traffic.

Viewing IPSec Configuration

Table 6-2 lists commands you can use to view information about your IPSec configuration.

Table 6-2 Commands to View IPSec Configuration Information

Command	Purpose
<code>show crypto ipsec transform-set</code>	View your transform set configuration.
<code>show crypto map [interface <i>interface-name</i> tag <i>map-name</i>]</code>	View your crypto map configuration.
<code>show crypto ipsec sa [map <i>map-name</i> address identity] [detail]</code>	View information about IPSec security associations.
<code>show crypto dynamic-map [tag <i>map-name</i>]</code>	View information about dynamic crypto maps.
<code>show crypto ipsec security-association lifetime</code>	View global security association lifetime values.

Clearing SAs

Certain configuration changes will only take effect when negotiating subsequent security associations. If you want the new settings to take immediate effect, clear the existing security associations so that they will be re-established with the changed configuration. For manually established security associations, clear and reinitialize the security associations or the changes will never take effect. If the PIX Firewall is actively processing IPSec traffic, it is desirable to clear only the portion of the security association database that would be affected by the configuration changes (that is, clear only the security associations established by a given crypto map set). Clearing the full security association database should be reserved for large-scale changes, or when the PIX Firewall is processing a small number of other IPSec traffic.

Table 6-3 lists commands you can use to clear and reinitialize IPSec security associations.

Table 6-3 Commands to Clear and Reinitialize IPSec SAs

Command	Purpose
<code>crypto map <i>map-name</i> interface <i>interface-name</i></code>	Reinitialize the IPSec run-time security association database and security policy database.
<code>clear [crypto] ipsec sa</code> or <code>clear [crypto] ipsec sa peer <i>ip-address</i> <i>peer-name</i></code> or <code>clear [crypto] ipsec sa map <i>map-name</i></code> or <code>clear [crypto] ipsec sa entry <i>destination-address</i> <i>protocol spi</i></code>	Clear IPSec security associations. Note Using the <code>clear [crypto] ipsec sa</code> command without parameters will clear out the full security association database, which will clear out active security sessions. You may also specify the peer , map , or entry keywords to clear out only a subset of the security association database. For more information, see the <code>clear [crypto] ipsec sa</code> command within the <i>Cisco PIX Firewall Command Reference</i> .

■ Clearing SAs

Site-to-Site VPN Configuration Examples

A site-to-site VPN protects the network resources on your protected networks from unauthorized use by users on an unprotected network, such as the public Internet. The basic configuration for this type of implementation has been covered in [Chapter 6, “Configuring IPSec and Certification Authorities.”](#) This chapter provides examples of the following site-to-site VPN configurations:

- [Using Pre-Shared Keys, page 7-1](#)
- [Using PIX Firewall with a VeriSign CA, page 7-7](#)
- [Using PIX Firewall with an In-House CA, page 7-13](#)
- [Using an Encrypted Tunnel to Obtain Certificates, page 7-20](#)
- [Connecting to a Catalyst 6500 and Cisco 7600 Series IPSec VPN Services Module, page 7-25](#)
- [Manual Configuration with NAT, page 7-35](#)

**Note**

Throughout the examples in this chapter, the local PIX Firewall unit is identified as PIX Firewall 1 while the remote unit is identified as PIX Firewall 2. This designation makes it easier to clarify the configuration required for each.

Using Pre-Shared Keys

This section describes an example configuration for using pre-shared keys. It contains the following topics:

- [Scenario Description, page 7-1](#)
- [Configuring PIX Firewall 1 with VPN Tunneling, page 7-2](#)
- [Configuring PIX Firewall 2 for VPN Tunneling, page 7-5](#)

Scenario Description

In the example illustrated in [Figure 7-1](#), the intranets use unregistered addresses and are connected over the public Internet by a site-to-site VPN. In this scenario, NAT is required for connections to the public Internet. However, NAT is not required for traffic between the two intranets, which can be transmitted using a VPN tunnel over the public Internet.

**Note**

If you do not need to do VPN tunneling for intranet traffic, you can use this example without the **access-list** or the **nat 0 access-list** commands. These commands disable NAT for traffic that matches the access list criteria.

If you have a limited number of registered IP addresses and you cannot use PAT, you can configure PIX Firewall to use NAT for connections to the public Internet, but avoid NAT for traffic between the two intranets. This configuration might also be useful if you were replacing a direct, leased-line connection between two intranets.

Figure 7-1 VPN Tunnel Network

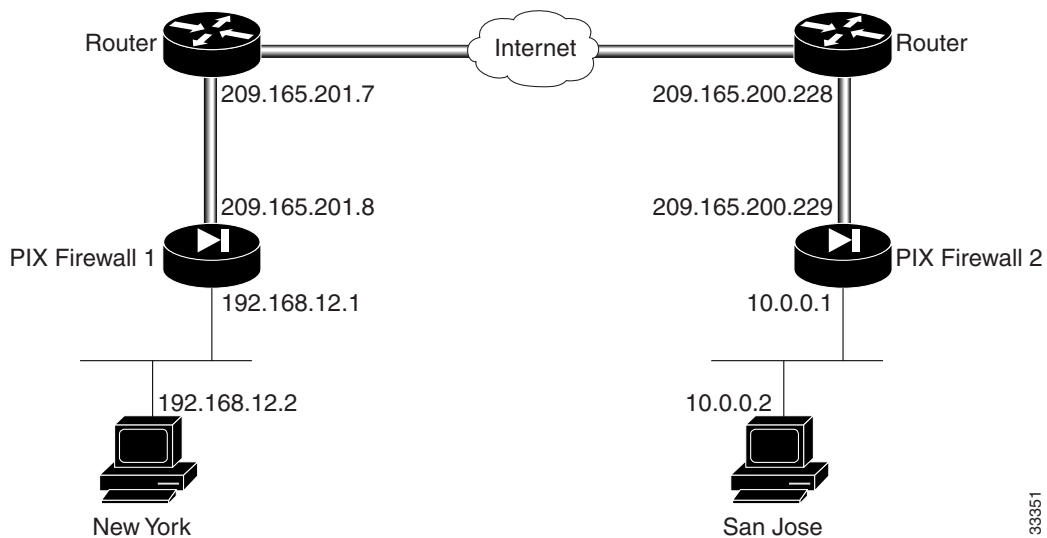

33351

The configuration shown for this example uses an access list to exclude traffic between the two intranets from NAT. The configuration assigns a global pool of registered IP addresses for use by NAT for all other traffic. By excluding intranet traffic from NAT, you need fewer registered IP addresses.

Configuring PIX Firewall 1 with VPN Tunneling

Follow these steps to configure PIX Firewall 1:

-
- Step 1** Define a host name:
- ```
hostname NewYork
```
- Step 2** Configure an ISAKMP policy:
- ```
isakmp enable outside
isakmp policy 9 authentication pre-share
isakmp policy 9 encrypt 3des
```
- Step 3** Configure a pre-shared key and associate with the peer:
- ```
crypto isakmp key cisco1234 address 209.165.200.229
```



**Step 4** Configure the supported IPsec transforms:

```
crypto ipsec transform-set strong esp-3des esp-sha-hmac
```

**Step 5** Create an access list:

```
access-list 90 permit ip 192.168.12.0 255.255.255.0 10.0.0.0 255.0.0.0
```

This access list defines traffic from network 192.168.12.0 to 10.0.0.0. Both of these networks use unregistered addresses.



---

**Note** Steps 5 and 6 are not required if you want to enable NAT for all traffic.

---

**Step 6** Exclude traffic between the intranets from NAT:

```
nat 0 access-list 90
```

This excludes traffic matching access list 90 from NAT. The **nat 0** command is always processed before any other **nat** commands.

**Step 7** Enable NAT for all other traffic:

```
nat (inside) 1 0 0
```

**Step 8** Assign a pool of global addresses for NAT and PAT:

```
global (outside) 1 209.165.201.9-209.165.201.30
global (outside) 1 209.165.201.7
```

The pool of registered addresses are only used for connections to the public Internet.

**Step 9** Define a crypto map:

```
crypto map toSanJose 20 ipsec-isakmp
crypto map toSanJose 20 match address 90
crypto map toSanJose 20 set transform-set strong
crypto map toSanJose 20 set peer 209.165.200.229
```

**Step 10** Apply the crypto map to the outside interface:

```
crypto map toSanJose interface outside
```

**Step 11** Specify that IPsec traffic be implicitly trusted (permitted):

```
sysopt connection permit-ipsec
```

---

[Example 7-1](#) lists the configuration for PIX Firewall 1.

#### **Example 7-1 PIX Firewall 1 VPN Tunnel Configuration**

```
nameif ethernet0 outside security0
nameif ethernet1 inside security100
interface ethernet0 auto
interface ethernet1 auto
enable password 8Ry2YjIyt7RRXU24 encrypted
passwd 2KFQnbNIdI.2KYOU encrypted
hostname NewYork
domain-name example.com
fixup protocol ftp 21
fixup protocol http 80
fixup protocol smtp 25
```

```

fixup protocol h323 1720
fixup protocol rsh 514
fixup protocol sqlnet 1521
names
pager lines 24
no logging on
mtu outside 1500
mtu inside 1500
ip address outside 209.165.201.8 255.255.255.224
ip address inside 192.168.12.1 255.255.255.0
no failover
failover ip address outside 0.0.0.0
failover ip address inside 0.0.0.0
arp timeout 14400
nat (inside) 0 access-list 90
access-list 90 permit ip 192.168.12.0 255.255.255.0 10.0.0.0 255.0.0.0
nat (inside) 1 0 0
global (outside) 1 209.165.201.9-209.165.201.30
global (outside) 1 209.165.201.7
no rip outside passive
no rip outside default
rip inside passive
no rip inside default
route outside 0.0.0.0 0.0.0.0 209.165.201.7 1
timeout xlate 3:00:00 conn 1:00:00 half-closed 0:10:00 udp 0:02:00
timeout rpc 0:10:00 h323 0:05:00
timeout uauth 0:05:00 absolute
aaa-server TACACS+ protocol tacacs+
aaa-server RADIUS protocol radius
no snmp-server location
no snmp-server contact
snmp-server community public
no snmp-server enable traps
sysopt connection permit-ipsec
crypto ipsec transform-set strong esp-3des esp-sha-hmac
crypto map toSanJose 20 ipsec-isakmp
crypto map toSanJose 20 match address 90
crypto map toSanJose 20 set peer 209.165.200.229
crypto map toSanJose 20 set transform-set strong
crypto map toSanJose interface outside
isakmp enable outside
isakmp key cisco1234 address 209.165.200.229 netmask 255.255.255.255
isakmp policy 9 authentication pre-share
isakmp policy 9 encryption 3des
telnet timeout 5
terminal width 80

```

**Note**

In this example, the following statements are not used when enabling NAT for all traffic:

```

nat 0 access-list 90
access-list 90 permit ip 192.168.12.0 255.255.255.0 10.0.0.0 255.0.0.0

```

## Configuring PIX Firewall 2 for VPN Tunneling

Follow these steps to configure PIX Firewall 2:

**Step 1** Define a host name:

```
hostname SanJose
```

**Step 2** Define the domain name:

```
domain-name example.com
```

**Step 3** Configure the ISAKMP policy:

```
isakmp enable outside
isakmp policy 8 authentication pre-share
isakmp policy 8 encryption 3des
```

**Step 4** Configure a pre-shared key and associate it with the peer:

```
crypto isakmp key cisco1234 address 209.165.201.8
```

**Step 5** Configure IPSec supported transforms:

```
crypto ipsec transform-set strong esp-3des esp-sha-hmac
```

**Step 6** Create an access list:

```
access-list 80 permit ip 10.0.0.0 255.0.0.0 192.168.12.0 255.255.255.0
```

This access list defines traffic from network 10.0.0.0 to 192.168.12.0. Both of these networks use unregistered addresses.



**Note** Step 7 and Step 8 are not required if you want to enable NAT for all traffic.

**Step 7** Exclude traffic between the intranets from NAT:

```
nat 0 access-list 80
```

This excludes traffic matching access list 80 from NAT. The **nat 0** command is always processed before any other **nat** commands.

**Step 8** Enable NAT for all other traffic:

```
nat (inside) 1 0 0
```

**Step 9** Assign a pool of global addresses for NAT and PAT:

```
global (outside) 1 209.165.200.240-209.165.200.250
global (outside) 1 209.165.202.251
```

The pool of registered addresses are only used for connections to the public Internet.

**Step 10** Define a crypto map:

```
crypto map newyork 10 ipsec-isakmp
crypto map newyork 10 match address 80
crypto map newyork 10 set transform-set strong
crypto map newyork 10 set peer 209.165.201.8
```

**Step 11** Apply the crypto map to an interface:

```
crypto map newyork interface outside
```

**Step 12** Specify that IPSec traffic be implicitly trusted (permitted):

```
sysopt connection permit-ipsec
```

---

[Example 7-2](#) lists the configuration for PIX Firewall 2.

**Example 7-2 PIX Firewall 2 VPN Tunnel Configuration**

```
nameif ethernet0 outside security0
nameif ethernet1 inside security100
nameif ethernet2 dmz security50
nameif ethernet3 perimeter security40
enable password 8Ry2YjIyt7RRXU24 encrypted
passwd 2KFQnbNIdI.2KYOU encrypted
hostname SanJose
domain-name example.com
fixup protocol ftp 21
fixup protocol http 80
fixup protocol smtp 25
fixup protocol h323 1720
fixup protocol rsh 514
fixup protocol sqlnet 1521
names
pager lines 24
no logging on
interface ethernet0 auto
interface ethernet1 auto
interface ethernet2 auto
interface ethernet3 auto
mtu outside 1500
mtu inside 1500
mtu dmz 1500
mtu perimeter 1500
ip address outside 209.165.200.229 255.255.255.224
ip address inside 10.0.0.1 255.0.0.0
ip address dmz 192.168.101.1 255.255.255.0
ip address perimeter 192.168.102.1 255.255.255.0
no failover
failover ip address outside 0.0.0.0
failover ip address inside 0.0.0.0
failover ip address dmz 0.0.0.0
failover ip address perimeter 0.0.0.0
arp timeout 14400
nat 0 access-list 80
access-list 80 permit ip 10.0.0.0 255.0.0.0 192.168.12.0 255.255.255.0
nat (inside) 1 0 0
global (outside) 1 209.165.200.240-209.165.200.250
global (outside) 1 209.165.202.251
no rip outside passive
no rip outside default
no rip inside passive
no rip inside default
no rip dmz passive
no rip dmz default
no rip perimeter passive
no rip perimeter default
route outside 0.0.0.0 0.0.0.0 209.165.200.228 1
```

```

timeout xlate 3:00:00 conn 1:00:00 half-closed 0:10:00 udp 0:02:00
timeout rpc 0:10:00 h323 0:05:00
timeout uauth 0:05:00 absolute
aaa-server TACACS+ protocol tacacs+
aaa-server RADIUS protocol radius
no snmp-server location
no snmp-server contact
snmp-server community public
no snmp-server enable traps
sysopt connection permit-ipsec
crypto ipsec transform-set strong esp-3des esp-sha-hmac
crypto map newyork 10 ipsec-isakmp
crypto map newyork 10 match address 80
crypto map newyork 10 set peer 209.165.201.8
crypto map newyork 10 set transform-set strong
crypto map newyork interface outside
isakmp enable outside
isakmp key cisco1234 address 209.165.201.8 netmask 255.255.255.255
isakmp policy 8 authentication pre-share
isakmp policy 8 encryption 3des
telnet timeout 5
terminal width 80

```

**Note**

In [Example 7-2](#), the following statements are not used when enabling NAT for all traffic:

```

nat 0 access-list 80
access-list 80 permit ip 10.0.0.0 255.0.0.0 192.168.12.0 255.255.255.00

```

## Using PIX Firewall with a VeriSign CA

This section provides configuration examples showing how to configure interoperability between two PIX Firewall units (PIX Firewall 1 and 2) for site-to-site VPN using the VeriSign CA server for device enrollment, certificate requests, and digital certificates for the IKE authentication. This section includes the following topics:

- [Scenario Description, page 7-7](#)
- [Configuring PIX Firewall 1 with a VeriSign CA, page 7-8](#)
- [Configuring PIX Firewall 2 with a VeriSign CA, page 7-11](#)

## Scenario Description

The two VPN peers in the configuration examples are shown to be configured to enroll with VeriSign at the IP address of 209.165.202.130 and to obtain their CA certificates from this CA server. VeriSign is a public CA that issues its CA-signed certificates over the Internet. Once each peer obtains its CA-signed certificate, tunnels can be established between the two VPN peers using digital certificates as the authentication method used during IKE authentication. The peers dynamically authenticate each other using the digital certificates.

**Note**

VeriSign's actual CA server address differs. The example CA server address is to be used for example purposes only.

For the general procedures to configure the PIX Firewall for a CA, see “Using Certification Authorities” in Chapter 6, “Configuring IPSec and Certification Authorities.”

This section provides an example configuration for the specific network illustrated in Figure 7-2.

Figure 7-2 VPN Tunnel Network

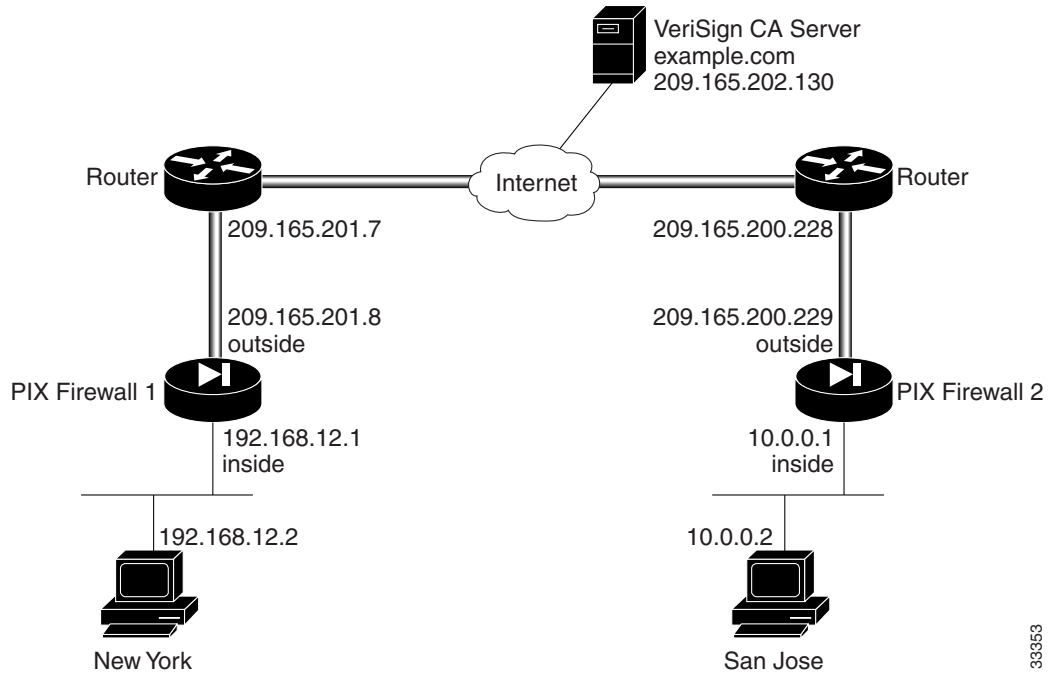

33353

## Configuring PIX Firewall 1 with a VeriSign CA

Perform the following steps to configure PIX Firewall 1 to use a public CA:

- 
- Step 1** Define a host name:  
`hostname NewYork`
- Step 2** Define the domain name:  
`domain-name example.com`
- Step 3** Generate the PIX Firewall RSA key pair:  
`ca generate rsa key 512`
- This command is not stored in the configuration.
- Step 4** Define VeriSign-related enrollment commands:  
`ca identity example.com 209.165.202.130`  
`ca configure example.com ca 2 20 crloptional`

These commands are stored in the configuration. “2” is the retry period, “20” is the retry count, and the `crloptional` option disables CRL checking.

**Step 5** Authenticate the CA by obtaining its public key and its certificate:

```
ca authenticate example.com
```

This command is not stored in the configuration.

**Step 6** Request signed certificates from your CA for your PIX Firewall's RSA key pair. Before entering this command, contact your CA administrator because they will have to authenticate your PIX Firewall manually before granting its certificate.

```
ca enroll example.com abcdef
```

"abcdef" is a challenge password. This can be anything. This command is not stored in the configuration.

**Step 7** Verify that the enrollment process was successful using the **show ca certificate** command:

```
show ca certificate
```

**Step 8** Save keys and certificates, and the CA commands (except those indicated) in Flash memory:

```
ca save all
write memory
```



---

**Note** Use the **ca save all** command any time you add, change, or delete **ca** commands in the configuration. This command is not stored in the configuration.

---

**Step 9** Configure an IKE policy:

```
isakmp enable outside
isakmp policy 8 auth rsa-sig
```

**Step 10** Create a partial access list:

```
access-list 90 permit ip 192.168.12.0 255.255.255.0 10.0.0.0 255.0.0.0
```

**Step 11** Configure a transform set that defines how the traffic will be protected:

```
crypto ipsec transform-set strong esp-3des esp-sha-hmac
```

**Step 12** Define a crypto map:

```
crypto map toSanJose 20 ipsec-isakmp
crypto map toSanJose 20 match address 90
crypto map toSanJose 20 set transform-set strong
crypto map toSanJose 20 set peer 209.165.200.229
```

**Step 13** Apply the crypto map to the outside interface:

```
crypto map toSanJose interface outside
```

**Step 14** Tell the PIX Firewall to implicitly permit IPSec traffic:

```
sysopt connection permit-ipsec
```

---

[Example 7-3](#) lists the configuration for PIX Firewall 1. PIX Firewall default configuration values and certain CA commands are not displayed in configuration listings.

**Example 7-3 PIX Firewall 1 with Public CA**

```

nameif ethernet0 outside security0
nameif ethernet1 inside security100
enable password 8Ry2YjIyt7RRXU24 encrypted
passwd 2KFQnbNIdI.2KYOU encrypted
hostname NewYork
domain-name example.com
fixup protocol ftp 21
fixup protocol http 80
fixup protocol smtp 25
fixup protocol h323 1720
fixup protocol rsh 514
fixup protocol sqlnet 1521
names
pager lines 24
no logging on
interface ethernet0 auto
interface ethernet1 auto
mtu outside 1500
mtu inside 1500
ip address outside 209.165.201.8 255.255.255.224
ip address inside 192.168.12.1 255.255.255.0
no failover
failover ip address outside 0.0.0.0
failover ip address inside 0.0.0.0
arp timeout 14400
nat (inside) 0 0.0.0.0 0.0.0.0 0 0
nat 0 access-list 90
access-list 90 permit ip 192.168.12.0 255.255.255.0 10.0.0.0 255.0.0.0
no rip outside passive
no rip outside default
rip inside passive
no rip inside default
route outside 0.0.0.0 0.0.0.0 209.165.201.7 1
timeout xlate 3:00:00 conn 1:00:00 half-closed 0:10:00 udp 0:02:00
timeout rpc 0:10:00 h323 0:05:00
timeout uauth 0:05:00 absolute
aaa-server TACACS+ protocol tacacs+
aaa-server RADIUS protocol radius
no snmp-server location
no snmp-server contact
snmp-server community public
no snmp-server enable traps
sysopt connection permit-ipsec
crypto ipsec transform-set strong esp-3des esp-sha-hmac
crypto map toSanJose 20 ipsec-isakmp
crypto map toSanJose 20 match address 90
crypto map toSanJose 20 set peer 209.165.200.229
crypto map toSanJose 20 set transform-set strong
crypto map toSanJose interface outside
isakmp policy 8 authentication rsa-sig
isakmp policy 8 encryption des
isakmp policy 8 hash sha
isakmp policy 8 group 1
isakmp policy 8 lifetime 86400
ca identity example.com 209.165.202.130:cgi-bin/pkclient.exe
ca configure example.com ca 1 100 crloptional
telnet timeout 5
terminal width 80

```



## Configuring PIX Firewall 2 with a VeriSign CA

**Note**

The following steps are nearly the same as those in the previous section “[Configuring PIX Firewall 1 with a VeriSign CA](#)” for configuring PIX Firewall 2. The differences are in Steps 1 and 2, and Steps 11 to 13, which are specific for the PIX Firewall 2 in this example.

Perform the following steps to configure PIX Firewall 2 for using a VeriSign CA:

**Step 1** Define a host name:

```
hostname SanJose
```

**Step 2** Define the domain name:

```
domain-name example.com
```

**Step 3** Generate the PIX Firewall RSA key pair:

```
ca generate rsa key 512
```

This command is not stored in the configuration.

**Step 4** Define VeriSign-related enrollment commands:

```
ca identity example.com 209.165.202.130
ca configure example.com ca 2 20 crloptional
```

These commands are stored in the configuration. “2” is the retry period, “20” is the retry count, and the **crloptional** option disables CRL checking.

**Step 5** Authenticate the CA by obtaining its public key and its certificate:

```
ca authenticate example.com
```

This command is not stored in the configuration.

**Step 6** Request signed certificates from your CA for your PIX Firewall’s RSA key pair:

```
ca enroll example.com abcdef
```

Before entering this command, contact your CA administrator because they will have to authenticate your PIX Firewall manually before granting its certificate.

“abcdef” is a challenge password. This can be anything. This command is not stored in the configuration.

**Step 7** Verify that the enrollment process was successful using the following command:

```
show ca certificate
```

**Step 8** Save keys and certificates, and the CA commands (except those indicated) in Flash memory:

```
ca save all
write memory
```

**Note**

Use the **ca save all** command any time you add, change, or delete **ca** commands in the configuration. This command is not stored in the configuration.

**Step 9** Configure an IKE policy:

```
isakmp enable outside
isakmp policy 8 auth rsa-sig
```

**Step 10** Create a partial access list:

```
access-list 80 permit ip 10.0.0.0 255.0.0.0 192.168.12.0 255.255.255.0
```

**Step 11** Configure a transform set that defines how the traffic will be protected:

```
crypto ipsec transform-set strong esp-3des esp-sha-hmac
```

**Step 12** Define a crypto map:

```
crypto map newyork 10 ipsec-isakmp
crypto map newyork 10 match address 80
crypto map newyork 10 set transform-set strong
crypto map newyork 10 set peer 209.165.201.8
```

**Step 13** Apply the crypto map to the outside interface:

```
crypto map newyork interface outside
```

**Step 14** Tell the PIX Firewall to implicitly permit IPSec traffic:

```
sysopt connection permit-ipsec
```

---

[Example 7-4](#) lists the configuration for PIX Firewall 2. PIX Firewall default configuration values and certain CA commands are not displayed in a configuration listing.

#### **Example 7-4 PIX Firewall 2 CA Configuration**

```
nameif ethernet0 outside security0
nameif ethernet1 inside security100
nameif ethernet2 dmz security50
nameif ethernet3 perimeter security40
enable password 8Ry2YjIyt7RRXU24 encrypted
passwd 2KFQnbNIdI.2KYOU encrypted
hostname SanJose
domain-name example.com
fixup protocol ftp 21
fixup protocol http 80
fixup protocol smtp 25
fixup protocol h323 1720
fixup protocol rsh 514
fixup protocol sqlnet 1521
names
pager lines 24
no logging on
interface ethernet0 auto
interface ethernet1 auto
interface ethernet2 auto
interface ethernet3 auto
mtu outside 1500
mtu inside 1500
mtu dmz 1500
mtu perimeter 1500
ip address outside 209.165.200.229 255.255.255.224
ip address inside 10.0.0.1 255.0.0.0
ip address dmz 192.168.101.1 255.255.255.0
ip address perimeter 192.168.102.1 255.255.255.0
```

```
no failover
failover ip address outside 0.0.0.0
failover ip address inside 0.0.0.0
failover ip address dmz 0.0.0.0
failover ip address perimeter 0.0.0.0
arp timeout 14400
nat (inside) 0 10.0.0.0 255.0.0.0 0 0
nat 0 access-list 80
access-list 80 permit ip 10.0.0.0 255.0.0.0 192.168.12.0 255.255.255.0
no rip outside passive
no rip outside default
no rip inside passive
no rip inside default
no rip dmz passive
no rip dmz default
no rip perimeter passive
no rip perimeter default
route outside 0.0.0.0 0.0.0.0 209.165.200.228 1
timeout xlate 3:00:00 conn 1:00:00 half-closed 0:10:00 udp 0:02:00
timeout rpc 0:10:00 h323 0:05:00
timeout uauth 0:05:00 absolute
aaa-server TACACS+ protocol tacacs+
aaa-server RADIUS protocol radius
no snmp-server location
no snmp-server contact
snmp-server community public
no snmp-server enable traps
sysopt connection permit-ipsec
crypto ipsec transform-set strong esp-3des esp-sha-hmac
crypto map newyork 10 ipsec-isakmp
crypto map newyork 10 match address 80
crypto map newyork 10 set peer 209.165.201.8
crypto map newyork 10 set transform-set strong
crypto map newyork interface outside
isakmp policy 8 authentication rsa-sig
isakmp policy 8 encryption des
isakmp policy 8 hash sha
isakmp policy 8 group 1
isakmp policy 8 lifetime 86400
ca identity example.com 209.165.202.130:cgi-bin/pkiclient.exe
ca configure example.com ca 2 20 crloptional
telnet timeout 5
terminal width 80
```

## Using PIX Firewall with an In-House CA

For the general procedures to configure the PIX Firewall for a CA, see “[Using Certification Authorities](#)” in [Chapter 6, “Configuring IPsec and Certification Authorities.”](#) This section provides a specific example for the network illustrated in [Figure 7-3](#) and includes the following topics:

- [Scenario Description, page 7-14](#)
- [Configuring PIX Firewall 1 for an In-House CA, page 7-15](#)
- [Configuring PIX Firewall 2 for an In-House CA, page 7-18](#)

## Scenario Description

PIX Firewall supports the use of the following certification authorities (CAs):

- VeriSign support is provided through the VeriSign Private Certificate Services (PCS) and the OnSite service, which lets you establish an in-house CA system for issuing digital certificates.
- Entrust, Entrust VPN Connector, version 4.1 (build 4.1.0.337) or higher. The Entrust CA server is an in-house CA server solution.
- Baltimore Technologies, UniCERT Certificate Management System, version 3.1.2 or higher. The Baltimore CA server is an in-house CA server solution.
- Microsoft Windows 2000, specifically the Windows 2000 Advanced Server, version 5.00.2195 or higher. The Windows 2000 CA server is an in-house CA server solution.

These are all in-house CA servers, except for VeriSign, which provides both a public CA and a private CA solution.



### Note

The example CA server address is to be used for example purposes only.

The in-house CA server in the following example is placed within the DMZ network of one PIX Firewall network (PIX Firewall 1). The VPN peer, PIX Firewall 2, should enroll and obtain its CA-signed certificates from the CA server residing within the network of PIX Firewall 1. PIX Firewall 2's enrollment and certificate request process is accomplished through the Internet.

The two VPN peers in the configuration examples are shown to be configured to enroll with and obtain their CA-signed certificates from the Entrust CA server. PIX Firewall 1 will obtain its certificate from the CA's local IP address of 10.1.0.2. PIX Firewall 2 will obtain its certificate from the CA's global IP address of 209.165.202.131. After each peer obtains its CA-signed certificate, tunnels can be established between the two VPN peers. The peers dynamically authenticate each other using the digital certificates.

**Figure 7-3 VPN Tunnel Network**

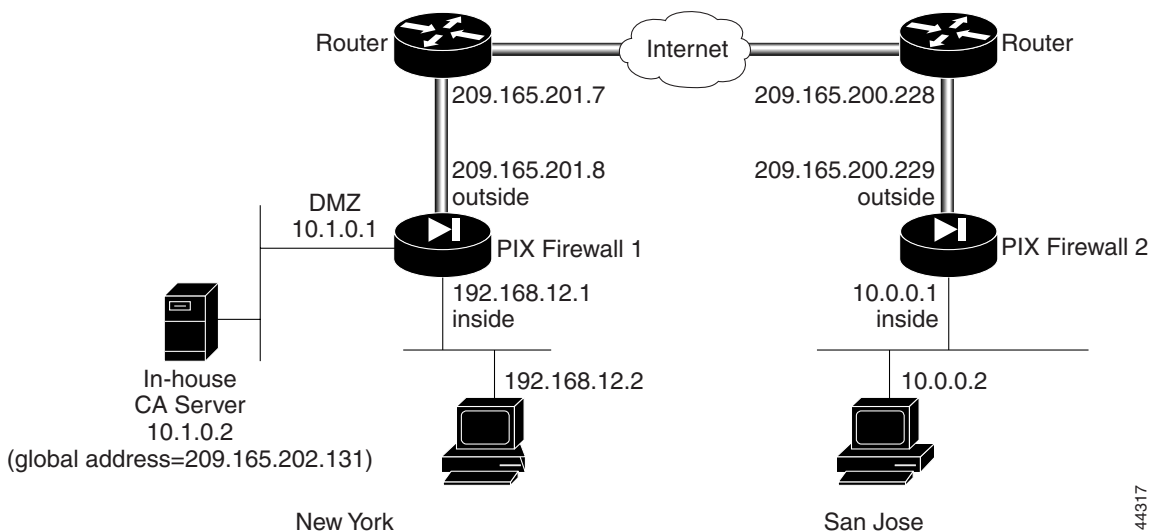

44317

## Configuring PIX Firewall 1 for an In-House CA

Follow these steps to configure PIX Firewall 1 for use with an in-house CA. These steps are similar to the procedure shown in “Using PIX Firewall with a VeriSign CA.”

**Step 1** Define a host name:

```
hostname NewYork
```

**Step 2** Define the domain name:

```
domain-name example.com
```

**Step 3** Generate the PIX Firewall RSA key pair:

```
ca generate rsa key 512
```

This command is entered at the command line and does not get stored in the configuration.

**Step 4** Define CA-related enrollment commands:

```
ca identity abcd 10.1.0.2 10.1.0.2
ca configure abcd ra 2 20 crloptional
```

These commands are stored in the configuration. **2** is the retry period, **20** is the retry count, and the **crloptional** option disables CRL checking.



**Note** For a Microsoft CA server, specify the internal network address followed by a colon and the pathname to the server executable, such as 10.1.0.2:/CERTSRV/mscep/mscep.dll.

**Step 5** Authenticate the CA by obtaining its public key and its certificate:

```
ca authenticate abcd
```

This command is entered at the command line and does not get stored in the configuration.

**Step 6** Request signed certificates from your CA for your PIX Firewall’s RSA key pair:

```
ca enroll abcd cisco
```

Before entering this command, contact your CA administrator because they will have to authenticate your PIX Firewall manually before granting its certificate.

“cisco” is a challenge password. This can be anything. This command is entered at the command line and does not get stored in the configuration.

**Step 7** Verify that the enrollment process was successful using the **show ca certificate** command:

```
show ca certificate
```

**Step 8** Save keys and certificates, and the CA commands (except those indicated) in Flash memory:

```
ca save all
write memory
```



**Note** Use the **ca save all** command any time you add, change, or delete **ca** commands in the configuration. This command is not stored in the configuration.

- Step 9** Map a local IP address to a global IP address:
- ```
static (dmz, outside) 209.165.202.131 10.1.0.2 netmask 255.255.255.255
```
- Step 10** Permit the host (PIX Firewall 2) to access the global host via LDAP, port 389:
- ```
access-list globalhost permit tcp 209.165.200.229 255.255.255.255 host 209.165.202.131 eq 389
```
- Step 11** Permit the host (PIX Firewall 2) to access the global host via HTTP:
- ```
access-list globalhost permit tcp 209.165.200.229 255.255.255.255 host 209.165.202.131 eq http
```
- Step 12** Create an access group to bind the access list to an interface:
- ```
access-group globalhost in interface outside
```
- Step 13** Configure an IKE policy:
- ```
isakmp enable outside
isakmp policy 8 auth rsa-sig
isakmp identity hostname
```
- Step 14** Configure a transform set that defines how the traffic will be protected:
- ```
crypto ipsec transform-set strong esp-3des esp-sha-hmac
```
- Step 15** Create a partial access list:
- ```
access-list 90 permit ip 192.168.12.0 255.255.255.0 10.0.0.0 255.0.0.0
```
- Step 16** Define a crypto map:
- ```
crypto map toSanJose 20 ipsec-isakmp
crypto map toSanJose 20 match address 90
crypto map toSanJose 20 set transform-set strong
crypto map toSanJose 20 set peer 209.165.200.229
```
- Step 17** Apply the crypto map to the outside interface:
- ```
crypto map toSanJose interface outside
```
- Step 18** Tell the PIX Firewall to implicitly permit IPsec traffic:
- ```
sysopt connection permit-ipsec
```

---

[Example 7-5](#) lists the configuration for PIX Firewall 1.

**Example 7-5 PIX Firewall 1 VPN Tunnel Configuration**

```
nameif ethernet0 outside security0
nameif ethernet1 inside security100
enable password 8Ry2YjIyt7RRXU24 encrypted
passwd 2KFQnbNIdI.2KYOU encrypted
hostname NewYork
domain-name example.com
```

```
fixup protocol ftp 21
fixup protocol http 80
fixup protocol smtp 25
fixup protocol h323 1720
fixup protocol rsh 514
fixup protocol sqlnet 1521
names
pager lines 24
no logging on
interface ethernet0 auto
interface ethernet1 auto
mtu outside 1500
mtu inside 1500
ip address outside 209.165.201.8 255.255.255.224
ip address inside 192.168.12.1 255.255.255.0
no failover
failover ip address outside 0.0.0.0
failover ip address inside 0.0.0.0
arp timeout 14400
static (dmz, outside) 209.165.202.131 10.1.0.2 netmask 255.255.255.255
access-list globalhost permit tcp 209.165.200.229 255.255.255.255 host 209.165.202.131 eq
389
access-list globalhost permit tcp 209.165.200.229 255.255.255.255 host 209.165.202.131 eq
http
access-group globalhost in interface outside
nat 0 access-list 90
access-list 90 permit ip 192.168.12.0 255.255.255.0 10.0.0.0 255.0.0.0
no rip outside passive
no rip outside default
rip inside passive
no rip inside default
route outside 0.0.0.0 0.0.0.0 209.165.201.7 1
timeout xlate 3:00:00 conn 1:00:00 half-closed 0:10:00 udp 0:02:00
timeout rpc 0:10:00 h323 0:05:00
timeout uauth 0:05:00 absolute
aaa-server TACACS+ protocol tacacs+
aaa-server RADIUS protocol radius
no snmp-server location
no snmp-server contact
snmp-server community public
no snmp-server enable traps
sysopt connection permit-ipsec
crypto ipsec transform-set strong esp-3des esp-sha-hmac
crypto map toSanJose 20 ipsec-isakmp
crypto map toSanJose 20 match address 90
crypto map toSanJose 20 set peer 209.165.200.229
crypto map toSanJose 20 set transform-set strong
crypto map toSanJose interface outside
isakmp policy 8 authentication rsa-sig
isakmp policy 8 encryption des
isakmp policy 8 hash sha
isakmp policy 8 group 1
isakmp policy 8 lifetime 86400
ca identity abcd 10.1.0.2 10.1.0.2
ca configure abcd ra 1 100 crloptional
telnet timeout 5
terminal width 80
```

## Configuring PIX Firewall 2 for an In-House CA

Follow these steps to configure PIX Firewall 2:

**Step 1** Define a host name:

```
hostname SanJose
```

**Step 2** Define the domain name:

```
domain-name example.com
```

**Step 3** Configure an IKE policy:

```
isakmp enable outside
isakmp policy 8 auth rsa-sig
```

**Step 4** Define CA-related enrollment commands:

```
ca identity abcd 209.165.202.131 209.165.202.131
ca configure abcd ra 2 20 crloptional
```

These commands are stored in the configuration. **2** is the retry period, **20** is the retry count, and the **crloptional** option disables CRL checking.



**Note** For a Microsoft CA server, specify the external (global) network address followed by a colon and the pathname to the server executable, such as 209.165.202.131:/certserv/mscep/mscep.dll.

**Step 5** Generate the PIX Firewall RSA key pair:

```
ca generate rsa key 512
```

This command is entered at the command line and does not get stored in the configuration.

**Step 6** Get the public key and the certificate of the CA server:

```
ca authenticate abcd
```

This command is entered at the command line and does not get stored in the configuration.

**Step 7** Contact your CA administrator and send your certificate request:

```
ca enroll abcd cisco
```

“cisco” is a challenge password. This can be anything. This command is entered at the command line and does not get stored in the configuration.

**Step 8** Configure supported IPsec transforms:

```
crypto ipsec transform-set strong esp-3des esp-sha-hmac
```

**Step 9** Save keys and certificates, and the CA commands (except those indicated) in Flash memory:

```
ca save all
write memory
```



**Note** Use the **ca save all** command any time you add, change, or delete **ca** commands in the configuration. This command is not stored in the configuration.



**Step 10** Create a partial access list:

```
access-list 80 permit ip 10.0.0.0 255.0.0.0 192.168.12.0 255.255.255.0
```

**Step 11** Define a crypto map:

```
crypto map newyork 20 ipsec-isakmp
crypto map newyork 20 match address 80
crypto map newyork 20 set transform-set strong
crypto map newyork 20 set peer 209.165.201.8
```

**Step 12** Apply the crypto map to the outside interface:

```
crypto map newyork interface outside
```

**Step 13** Tell the PIX Firewall to implicitly permit IPSec traffic:

```
sysopt connection permit-ipsec
```

---

[Example 7-6](#) lists the configuration for PIX Firewall 2.

#### **Example 7-6** PIX Firewall 2 VPN Tunnel Configuration

```
nameif ethernet0 outside security0
nameif ethernet1 inside security100
nameif ethernet2 dmz security50
nameif ethernet3 perimeter security40
enable password 8Ry2YjIyt7RRXU24 encrypted
passwd 2KFQnbNIdI.2KYOU encrypted
hostname SanJose
domain-name example.com
fixup protocol ftp 21
fixup protocol http 80
fixup protocol smtp 25
fixup protocol h323 1720
fixup protocol rsh 514
fixup protocol sqlnet 1521
names
pager lines 24
no logging on
interface ethernet0 auto
interface ethernet1 auto
interface ethernet2 auto
interface ethernet3 auto
mtu outside 1500
mtu inside 1500
mtu dmz 1500
mtu perimeter 1500
ip address outside 209.165.200.229 255.255.255.224
ip address inside 10.0.0.1 255.0.0.0
ip address dmz 192.168.101.1 255.255.255.0
ip address perimeter 192.168.102.1 255.255.255.0
no failover
failover ip address outside 0.0.0.0
failover ip address inside 0.0.0.0
failover ip address dmz 0.0.0.0
failover ip address perimeter 0.0.0.0
arp timeout 14400
nat 0 access-list 80
access-list 80 permit ip 10.0.0.0 255.0.0.0 192.168.12.0 255.255.255.0
no rip outside passive
no rip outside default
```

```

no rip inside passive
no rip inside default
no rip dmz passive
no rip dmz default
no rip perimeter passive
no rip perimeter default
route outside 0.0.0.0 0.0.0.0 209.165.200.228 1
timeout xlate 3:00:00 conn 1:00:00 half-closed 0:10:00 udp 0:02:00
timeout rpc 0:10:00 h323 0:05:00
timeout uauth 0:05:00 absolute
aaa-server TACACS+ protocol tacacs+
aaa-server RADIUS protocol radius
no snmp-server location
no snmp-server contact
snmp-server community public
no snmp-server enable traps
sysopt connection permit-ipsec
crypto ipsec transform-set strong esp-3des esp-sha-hmac
crypto map newyork 10 ipsec-isakmp
crypto map newyork 10 match address 80
crypto map newyork 10 set peer 209.165.201.8
crypto map newyork 10 set transform-set strong
crypto map newyork interface outside
isakmp policy 8 authentication rsa-sig
isakmp policy 8 encryption des
isakmp policy 8 hash sha
isakmp policy 8 group 1
isakmp policy 8 lifetime 86400
ca identity abcd 209.165.202.131 209.165.202.131
ca configure abcd ra 1 100 crloptional
telnet timeout 5
terminal width 80

```

## Using an Encrypted Tunnel to Obtain Certificates

This section shows an example of how to perform CA enrollment and certificate requests via a site-to-site VPN tunnel between two PIX Firewall units (PIX Firewall 1 and 2). In the example, both PIX Firewall units enroll and request certificates from a CA server protected by PIX Firewall 1. PIX Firewall 2 enrolls and requests its certificate using an encrypted tunnel.

To accomplish this, you first establish a tunnel between the PIX Firewalls using a pre-shared key. You then use this tunnel to enroll and request the certificate for PIX Firewall 2. After obtaining a certificate, clear the IKE and IPSec SAs on both units and then configure them to use digital certificates.



### Note

---

The example CA server address is to be used for example purposes only.

---

This section includes the following topics:

- [Establishing a Tunnel Using a Pre-Shared Key, page 7-21](#)
- [Establishing a Tunnel with a Certificate, page 7-24](#)

This example uses the network diagram shown in [Figure 7-4](#).

Figure 7-4 VPN Tunnel Network

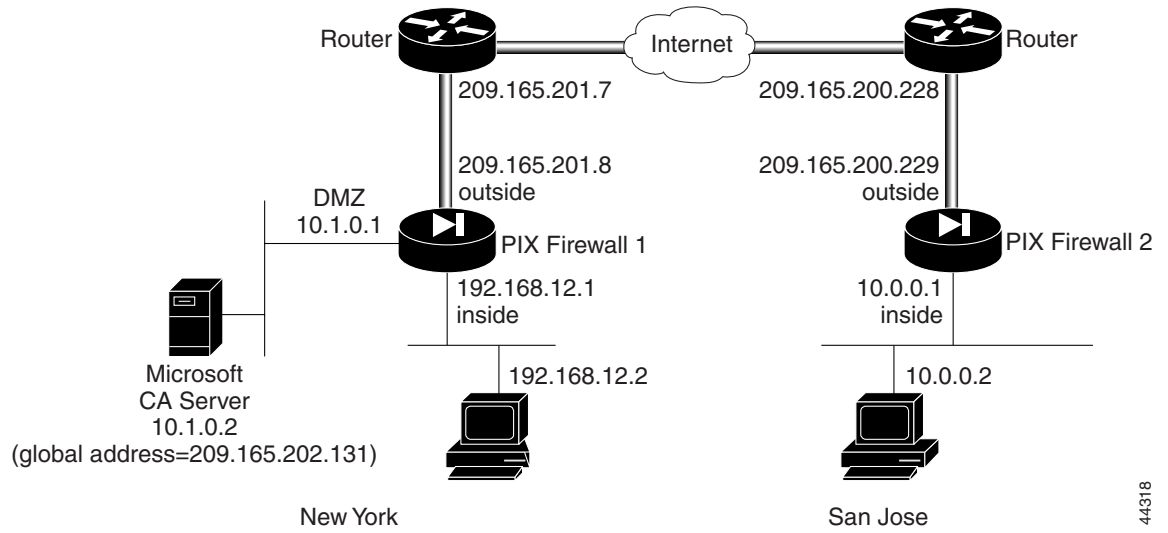

44318

## Establishing a Tunnel Using a Pre-Shared Key

This section describes how to establish a tunnel using a pre-shared key. It includes the following topics:

- [PIX Firewall 1 Configuration, page 7-21](#)
- [PIX Firewall 2 Configuration, page 7-23](#)

### PIX Firewall 1 Configuration

Follow these steps to configure PIX Firewall 1:

- 
- Step 1** Define a host name:
- ```
hostname NewYork
```
- Step 2** Define the domain name:
- ```
domain-name example.com
```
- Step 3** Configure an IKE policy:
- ```
isakmp enable outside
isakmp policy 8 auth pre-share
isakmp key cisco address 209.165.200.229 netmask 255.255.255.255
```
- Step 4** Create a partial access list:
- ```
access-list 90 permit ip host 10.1.0.2 host 209.165.200.229
```

**Step 5** Configure NAT 0:

```
nat (dmz) 0 access-list 90
```

**Step 6** Configure a transform set that defines how the traffic will be protected:

```
crypto ipsec transform-set strong esp-3des esp-sha-hmac
```

**Step 7** Define a crypto map:

```
crypto map toSanJose 20 ipsec-isakmp
crypto map toSanJose 20 match address 90
crypto map toSanJose 20 set transform-set strong
crypto map toSanJose 20 set peer 209.165.200.229
```

**Step 8** Apply the crypto map to the outside interface:

```
crypto map toSanJose interface outside
```

**Step 9** Tell the PIX Firewall to implicitly permit IPsec traffic:

```
sysopt connection permit-ipsec
```

**Step 10** Generate the PIX Firewall RSA key pair:

```
ca generate rsa key 512
```

This command is entered at the command line and does not get stored in the configuration.

**Step 11** Define CA-related enrollment commands:

```
ca identity abcd 10.1.0.2:/certsrv/mscep/mscep.dll
ca configure abcd ra 1 20 crloptional
```

These commands are stored in the configuration.



---

**Note** The **ca identity** command shown is specific to the Microsoft CA. The **ca identity** you use depends on the CA you are using.

---

**Step 12** Get the public key and the certificate of the CA server:

```
ca authenticate abcd
```

This command is entered at the command line and does not get stored in the configuration.

**Step 13** Contact your CA administrator and send your certificate request:

```
ca enroll abcd cisco
```

The string “cisco” is a challenge password. This can be anything. This command is entered at the command line and does not get stored in the configuration.

**Step 14** Save keys and certificates, and the **ca** commands (except those indicated) in Flash memory:

```
ca save all
write memory
```



---

**Note** Use the **ca save all** command any time you add, change, or delete **ca** commands in the configuration. This command is not stored in the configuration.

---

## PIX Firewall 2 Configuration

Follow these steps to configure PIX Firewall 2:

- 
- Step 1** Define a host name:
- ```
hostname SanJose
```
- Step 2** Define the domain name:
- ```
domain-name example.com
```
- Step 3** Configure an IKE policy:
- ```
isakmp enable outside
isakmp policy 8 auth pre-share
isakmp key cisco address 209.165.201.8 netmask 255.255.255.255
```
- Step 4** Create a partial access list:
- ```
access-list 80 permit ip host 209.165.200.229 host 10.1.0.2
```
- Step 5** Configure NAT 0:
- ```
nat (inside) 0 access-list 80
```
- Step 6** Configure a transform set that defines how the traffic will be protected:
- ```
crypto ipsec transform-set strong esp-3des esp-sha-hmac
```
- Step 7** Define a crypto map:
- ```
crypto map newyork 20 ipsec-isakmp
crypto map newyork 20 match address 80
crypto map newyork 20 set transform-set strong
crypto map newyork 20 set peer 209.165.201.8
```
- Step 8** Apply the crypto map to the outside interface:
- ```
crypto map newyork interface outside
```
- Step 9** Tell the PIX Firewall to implicitly permit IPsec traffic:
- ```
sysopt connection permit-ipsec
```
- Step 10** Generate the PIX Firewall RSA key pair:
- ```
ca generate rsa key 512
```
- This command is entered at the command line and does not get stored in the configuration.
- Step 11** Define CA-related enrollment commands:
- ```
ca identity abcd 10.1.0.2:/certsrv/mscep/mscep.dll
ca configure abcd ra 1 20 crloptional
```

These commands are stored in the configuration.



Note The `ca identity` command shown is specific to the Microsoft CA. The `ca identity` you use depends on the CA you are using.

Step 12 Authenticate the CA by obtaining its public key and its certificate:

```
ca authenticate abcd
```

This command is entered at the command line and does not get stored in the configuration.

Step 13 Request signed certificates from your CA for your PIX Firewall's RSA key pair. Before entering this command, contact your CA administrator because they will have to authenticate your PIX Firewall manually before granting its certificate:

```
ca enroll abcd cisco
```

“cisco” is a challenge password. This can be anything. This command is entered at the command line and does not get stored in the configuration.

Step 14 Save keys and certificates, and the CA commands (except those indicated) in Flash memory:

```
ca save all
write memory
```



Note

Use the **ca save all** command any time you add, change, or delete **ca** commands in the configuration. This command is not stored in the configuration.

Establishing a Tunnel with a Certificate

This section describes how to clear the SAs on each PIX Firewall and to establish a tunnel using a certificate. It includes the following topics:

- [PIX Firewall 1 Configuration, page 7-24](#)
- [PIX Firewall 2 Configuration, page 7-25](#)

PIX Firewall 1 Configuration

Follow these steps to configure PIX Firewall 1:

Step 1 Clear the IPsec SAs:

```
clear ipsec sa
```

Step 2 Clear the ISAKMP SAs:

```
clear isakmp sa
```

Step 3 Create a partial access list:

```
access-list 90 permit ip 192.168.12.0 255.255.255.0 10.0.0.0 255.0.0.0
```

Step 4 Configure NAT 0:

```
nat (inside) 0 access-list 90
```

Step 5 Specify the authentication method of rsa-signatures for the IKE policy:

```
isakmp policy 8 auth rsa-sig
```

PIX Firewall 2 Configuration

Follow these steps to configure PIX Firewall 2:

-
- Step 1** Clear the IPsec SAs:
- ```
clear ipsec sa
```
- Step 2** Clear the ISAKMP SAs:
- ```
clear isakmp sa
```
- Step 3** Create a partial access list:
- ```
access-list 80 permit ip 10.0.0.0 255.0.0.0 192.168.12.0 255.255.255.0
```
- Step 4** Specify the authentication method of rsa-signatures for the IKE policy:
- ```
isakmp policy 8 auth rsa-sig
```
-

Connecting to a Catalyst 6500 and Cisco 7600 Series IPsec VPN Services Module

This section describes how to create an IPsec site-to-site tunnel between a Cisco Catalyst 6500 series switch with the Catalyst 6500 and Cisco 7600 Series IPsec VPN Services Module (VPNSM) and a PIX Firewall. It includes the following topics:

- [Scenario Description, page 7-25](#)
- [Configuring IPsec Using a Trunk Port, page 7-26](#)
- [Configuring IPsec Using a Routed Port, page 7-30](#)
- [Verifying Your Configuration, page 7-35](#)

Scenario Description

[Figure 7-5](#) illustrates the network setup used in this example configuration.

Figure 7-5 VPN Tunnel Between PIX Firewall and Catalyst 6500 with VPNSM

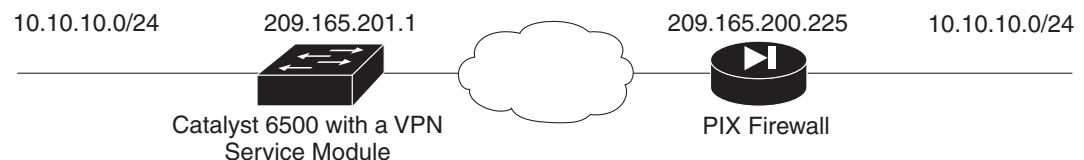

The VPNSM has two Gigabit Ethernet (GE) ports with no externally visible connectors. These ports are addressable for configuration purposes only. Port 1 is always the inside port. This port handles all traffic from and to the inside network. The second port (port 2) handles all traffic from and to the WAN or outside networks. These two ports are always configured in 802.1q trunking mode.

Packets are processed by a pair of VLANs, one Layer 3 (L3) inside VLAN and one Layer 2 (L2) outside VLAN. The packets are routed to the inside VLAN. After encrypting the packets the VPN SM uses the corresponding outside VLAN. In the decryption process, the packets from the outside to the inside are bridged to the VPN SM using the outside VLAN. After the VPN SM decrypts the packet and maps the VLAN to the corresponding inside VLAN, EARL routes the packet to the appropriate LAN port. The L3 inside VLAN and the L2 VLANs are joined together by issuing the **crypto connect vlan** command. There are three types of ports in the Catalyst 6500 series switches:

- Routed Ports—By default all Ethernet ports are routed ports. These ports have a hidden VLAN associated with them.
- Access Ports—These ports have an external or VLAN Trunking Protocol (VTP) VLAN associated with them. You can associate more than one port to a defined VLAN.
- Trunk Ports—These ports carry many external or VTP VLANs, on which all packets are encapsulated with an 802.1q header.

Configuring IPsec Using a Trunk Port

Perform the following steps to configure an IPsec tunnel using the Catalyst 6500 trunk port configuration:

- Step 1** Add the inside VLANs to the inside port of the VPN SM. Assuming that the VPN SM is on slot 3, use VLAN 100 as the inside VLAN and VLAN 200 as the outside, and configure the GE ports on the VPN SM as follows.

```
interface GigabitEthernet3/1
no ip address
switchport
switchport trunk encapsulation dot1q
switchport trunk allowed vlan 1,100,1002-1005
switchport mode trunk

interface GigabitEthernet3/2
no ip address
switchport
switchport trunk encapsulation dot1q
switchport trunk allowed vlan 1,200,1002-1005
switchport mode trunk
```

- Step 2** Add the VLAN 100 interface and the interface where the tunnel will be terminated (in this case, FastEthernet2/2):

```
interface Vlan100
ip address 209.165.201.1 255.255.255.0

interface FastEthernet2/2
no ip address
switchport
switchport access vlan 200
switchport mode access
crypto connect vlan 100
```

- Step 3** Create an ACL (in this case, ACL 100) defining the traffic from the inside network 10.10.10.0/24 to the remote network 10.20.20.0/24:

```
access-list 100 permit ip 10.10.10.0 0.0.0.255 10.20.20.0 0.0.0.255
```

Step 4 Define your Internet Security Association and Key Management Protocol (ISAKMP) policy proposals:

```
crypto isakmp policy 1
hash md5
authentication pre-share
group 2
```

Step 5 In this example, pre-shared keys are used and defined by issuing the following command:

```
crypto isakmp key cisco address 209.165.200.225
```

Step 6 Define your IPsec proposals:

```
crypto ipsec transform-set cisco esp-des esp-md5-hmac
```

Step 7 Create your crypto map statement:

```
crypto map cisco 10 ipsec-isakmp
set peer 209.165.200.225
set transform-set cisco
match address 100
```

Step 8 Apply the crypto map to the VLAN 100 interface:

```
interface vlan100
crypto map cisco
```

[Example 7-7](#) shows the complete configuration for the VPNSM.

Example 7-7 VPNSM Configuration

```
!--- Define Phase 1 policy.
crypto isakmp policy 1
hash md5
authentication pre-share
group 2
crypto isakmp key cisco address 209.165.200.225
!
!
!--- Define the encryption policy for this setup.
crypto ipsec transform-set cisco ESP-Des esp-md5-hmac
!
!--- Define a static crypto map entry for the peer
!--- with mode ipsec-isakmp.
!--- This indicates that Internet Key Exchange (IKE)
!--- will be used to establish the IPsec
!--- Security Associations (SAs) for protecting the traffic
!--- specified by this crypto map entry.
crypto map cisco 10 ipsec-isakmp
set peer 209.165.200.225
set transform-set cisco
match address 100
!
!
no spanning-tree vlan 100
!
!
!
interface GigabitEthernet1/1
no ip address
shutdown
snmp trap link-status
switchport
```

```

!
interface GigabitEthernet1/2
no ip address
shutdown
!
interface FastEthernet2/1
ip address 10.10.10.1 255.255.255.0
no keepalive
!
!--- This is the secure port which is configured in routed port mode.
!--- This routed port mode purposely does not have an L3 IP address
!--- configured, which is normal for the BITW process.
!--- The IP address was moved from this interface to the VLAN 100 to
!--- accomplish BITW, thereby bringing the VPN Services Module into
!--- the packet path. This will be the L2 port VLAN on which the
!--- VPN Services Module's outside port also belongs.
interface FastEthernet2/2
no ip address
snmp trap link-status
switchport
switchport access vlan 200
switchport mode access
crypto connect vlan 100
!
interface GigabitEthernet3/1
no ip address
snmp trap link-status
switchport
switchport trunk encapsulation dot1q
!--- VLAN 100 is defined as the Interface VLAN (IVLAN).
switchport trunk allowed vlan 1,100,1002-1005
switchport mode trunk
flowcontrol receive on
cdp enable
!
interface GigabitEthernet3/2
no ip address
snmp trap link-status
switchport
switchport trunk encapsulation dot1q
!--- The Port VLAN (PVLAN) configuration is handled by the VPN Services Module
!--- transparently without user configuration
!--- or involvement. It also is not shown in the configuration.
!--- Note that for every IVLAN a corresponding PVLAN exists.
switchport trunk allowed vlan 1,200,1002-1005
switchport mode trunk
flowcontrol receive on
cdp enable
!
interface Vlan1
no ip address
shutdown
!
!--- This is the IVLAN configured for intercepting the traffic
!--- destined to the secure port on which the VPN Services Module's inside port
!--- is the only port present.
Interface Vlan100
ip address 209.165.201.1 255.255.255.0
crypto map cisco
!
interface Vlan200
no ip address
!

```

```

ip classless
!--- Configure the routing so that the device
!--- knows how to reach its destination network.
ip route 0.0.0.0 0.0.0.0 172.18.124.1
!
!--- This is the crypto ACL.
access-list 100 permit ip 10.10.10.0 0.0.0.255 10.20.20.0 0.0.0.255

```

Example 7-8 shows the complete configuration for the PIX Firewall.

Example 7-8 PIX Firewall Configuration

```

nameif ethernet0 outside security0
nameif ethernet1 inside security100
nameif ethernet2 intf2 security10
nameif ethernet3 intf3 security15
nameif ethernet4 intf4 security20
nameif ethernet5 intf5 security25
enable password 8Ry2YjIyt7RRXU24 encrypted
passwd 2KFQnbNIdI.2KYOU encrypted
hostname pix515B
domain-name cisco.com
fixup protocol ftp 21
fixup protocol http 80
fixup protocol h323 h225 1720
fixup protocol h323 ras 1718-1719
fixup protocol ils 389
fixup protocol rsh 514
fixup protocol rtsp 554
fixup protocol smtp 25
fixup protocol sqlnet 1521
fixup protocol sip 5060
fixup protocol skinny 2000
names
!--- Traffic to the router.
Access-list 100 permit ip 10.20.20.0 255.255.255.0 10.10.10.0 255.255.255.0
pager lines 24
interface ethernet0 auto
interface ethernet1 auto
interface ethernet2 auto shutdown
interface ethernet3 auto shutdown
interface ethernet4 auto shutdown
interface ethernet5 auto shutdown
mtu outside 1500
mtu inside 1500
mtu intf2 1500
mtu intf3 1500
mtu intf4 1500
mtu intf5 1500
ip address outside 209.165.200.225 255.255.255.0
ip address inside 10.20.20.1 255.255.255.0
ip address intf2 127.0.0.1 255.255.255.255
ip address intf3 127.0.0.1 255.255.255.255
ip address intf4 127.0.0.1 255.255.255.255
ip address intf5 127.0.0.1 255.255.255.255
ip audit info action alarm
ip audit attack action alarm
no failover
failover timeout 0:00:00
failover poll 15
failover ip address outside 0.0.0.0
failover ip address inside 0.0.0.0
failover ip address intf2 0.0.0.0

```

```

failover ip address intf3 0.0.0.0
failover ip address intf4 0.0.0.0
failover ip address intf5 0.0.0.0
pdm history enable
arp timeout 14400
access-list host1 permit icmp any any
access-group host1 in interface outside
route outside 0.0.0.0 0.0.0.0 14.36.1.1 1
timeout xlate 3:00:00
timeout conn 1:00:00 half-closed 0:10:00 udp 0:02:00 rpc 0:10:00 h323
    0:05:00 sip 0:30:00 sip_media 0:02:00
timeout uauth 0:05:00 absolute
aaa-server TACACS+ protocol tacacs+
AAA-server RADIUS protocol radius
AAA-server LOCAL protocol local
no snmp-server location
no snmp-server contact
snmp-server community public
no snmp-server enable traps
floodguard enable
!--- IPsec policies.
sysopt connection permit-ipsec
no sysopt route dnat
crypto ipsec transform-set cisco esp-des esp-md5-hmac
crypto map cisco 10 ipsec-isakmp
crypto map cisco 10 match address 100
crypto map cisco 10 set peer 209.165.201.1
crypto map cisco 10 set transform-set cisco
crypto map cisco interface outside
!--- IKE policies.
isakmp enable outside
isakmp key ***** address 209.165.201.1 netmask 255.255.255.255
isakmp policy 1 authentication pre-share
isakmp policy 1 encryption des
isakmp policy 1 hash md5
isakmp policy 1 group 2
isakmp policy 1 lifetime 86400
telnet timeout 5
ssh timeout 5
terminal width 80
Cryptochecksum:02a61666fbc808eaf2ba99b69d544df7
: end
[OK]

```

Configuring IPsec Using a Routed Port

Perform the following steps to configure IPsec using the routed port configuration on the Catalyst 6500 VPN Services Module.

- Step 1** Add the inside VLANs to the inside port of the VPNSM. Assuming that the VPNSM is on slot 3, use VLAN 100 as the inside VLAN and VLAN 200 as the outside, and configure the GE ports on the VPNSM as follows.

```

interface GigabitEthernet3/1
no ip address
switchport
switchport trunk encapsulation dot1q
switchport trunk allowed vlan 1,100,1002-1005
switchport mode trunk

```

```
interface GigabitEthernet3/2
no ip address
switchport
switchport trunk encapsulation dot1q
switchport trunk allowed vlan 1,200,1002-1005
switchport mode trunk
```

- Step 2** Add the VLAN 100 interface, and the interface where the tunnel will be terminated (in this case, FastEthernet2/2):

```
interface Vlan100
ip address 209.165.201.1 255.255.255.0
```

```
interface FastEthernet2/2
no ip address
crypto connect vlan 100
```

- Step 3** Create an ACL (in this case, ACL 100) defining the traffic from the inside network 10.10.10.0/24 to the remote network 10.20.20.0/24:

```
access-list 100 permit ip 10.10.10.0 0.0.0.255 10.20.20.0 0.0.0.255
```

- Step 4** Define your ISAKMP policy proposals:

```
crypto isakmp policy 1
hash md5
authentication pre-share
group 2
```

- Step 5** In this example, pre-shared keys are used and defined by issuing the following command:

```
crypto isakmp key cisco address 209.165.200.225
```

- Step 6** Define your IPsec proposals:

```
crypto ipsec transform-set cisco esp-des esp-md5-hmac
```

```
Create your crypto map statement.
crypto map cisco 10 ipsec-isakmp
set peer 209.165.200.225
set transform-set cisco
match address 100
```

- Step 7** Apply the crypto map to the VLAN 100 interface:

```
interface vlan100
crypto map cisco
```

[Example 7-9](#) shows the complete configuration for the VPNSM.

Example 7-9 Catalyst 6500 Configuration

```
!--- Define Phase 1 policy.
crypto isakmp policy 1
hash md5
authentication pre-share
group 2
crypto isakmp key cisco address 209.165.200.225
!
!
!--- Define the encryption policy for this setup.
crypto ipsec transform-set cisco ESP-Des esp-md5-hmac
```

```

!
!--- Define a static crypto map entry for the peer
!--- with mode ipsec-isakmp. This indicates that IKE
!--- will be used to establish the IPSec
!--- SAs for protecting the traffic
!--- specified by this crypto map entry.

crypto map cisco 10 ipsec-isakmp
set peer 209.165.200.225
set transform-set cisco
match address 100
!
!
no spanning-tree vlan 100
!
!
!
interface GigabitEthernet1/1
no ip address
shutdown
snmp trap link-status
switchport
!
interface GigabitEthernet1/2
no ip address
shutdown
!
interface FastEthernet2/1
ip address 10.10.10.1 255.255.255.0
no keepalive
!
!--- This is the secure port which is configured in routed port mode.
!--- This routed port mode does not have an L3 IP address
!--- configured, which is normal for the BITW process.
!--- The IP address was moved from this interface to the VLAN 100 to
!--- accomplish BITW, thereby bringing the VPN Services Module into
!--- the packet path. This will be the L2 port VLAN on which the
!--- VPN Services Module's outside port also belongs.
Interface FastEthernet2/2
no ip address
crypto connect vlan 100
!
interface GigabitEthernet3/1
no ip address
snmp trap link-status
switchport
switchport trunk encapsulation dot1q
!--- VLAN 100 is defined as the IVLAN.
switchport trunk allowed vlan 1,100,1002-1005
switchport mode trunk
flowcontrol receive on
cdp enable
!
interface GigabitEthernet3/2
no ip address
snmp trap link-status
switchport
switchport trunk encapsulation dot1q
!--- The PVLAN configuration is handled by the VPN Services Module
!--- transparently without user configuration
!--- or involvement. It also is not shown in the configuration.
!--- Note that for every IVLAN a corresponding PVLAN exists.
switchport trunk allowed vlan 1,200,1002-1005
switchport mode trunk

```

```

flowcontrol receive on
cdp enable
!
interface Vlan1
no ip address
shutdown
!
!--- This is the IVLAN configured for intercepting the traffic
!--- destined to the secure port on which the VPN Services Module's inside port
!--- is the only port present.
Interface Vlan100
ip address 209.165.201.1 255.255.255.0
crypto map cisco
!
interface Vlan200
no ip address
!
ip classless
!--- Configure the routing so that the device
!--- knows how to reach its destination network.
ip route 0.0.0.0 0.0.0.0 172.18.124.1
ip route 10.20.20.0 255.255.255.0 209.165.200.225
!
!--- This is the crypto ACL.
Access-list 100 permit ip 10.10.10.0 0.0.0.255 10.20.20.0 0.0.0.255

```

Example 7-10 shows the complete configuration for the PIX Firewall.

Example 7-10 PIX Firewall Configuration

```

nameif ethernet0 outside security0
nameif ethernet1 inside security100
nameif ethernet2 intf2 security10
nameif ethernet3 intf3 security15
nameif ethernet4 intf4 security20
nameif ethernet5 intf5 security25
enable password 8Ry2YjIyt7RRXU24 encrypted
passwd 2KFQnbNIdI.2KYOU encrypted
hostname pix515B
domain-name cisco.com
fixup protocol ftp 21
fixup protocol http 80
fixup protocol h323 h225 1720
fixup protocol h323 ras 1718-1719
fixup protocol ils 389
fixup protocol rsh 514
fixup protocol rtsp 554
fixup protocol smtp 25
fixup protocol sqlnet 1521
fixup protocol sip 5060
fixup protocol skinny 2000
names
!--- Traffic to the router.
Access-list 100 permit ip 10.20.20.0 255.255.255.0 10.10.10.0 255.255.255.0
pager lines 24
interface ethernet0 auto
interface ethernet1 auto
interface ethernet2 auto shutdown
interface ethernet3 auto shutdown
interface ethernet4 auto shutdown
interface ethernet5 auto shutdown
mtu outside 1500
mtu inside 1500

```

```

mtu intf2 1500
mtu intf3 1500
mtu intf4 1500
mtu intf5 1500
ip address outside 209.165.200.225 255.255.255.0
ip address inside 10.20.20.1 255.255.255.0
ip address intf2 127.0.0.1 255.255.255.255
ip address intf3 127.0.0.1 255.255.255.255
ip address intf4 127.0.0.1 255.255.255.255
ip address intf5 127.0.0.1 255.255.255.255
ip audit info action alarm
ip audit attack action alarm
no failover
failover timeout 0:00:00
failover poll 15
failover ip address outside 0.0.0.0
failover ip address inside 0.0.0.0
failover ip address intf2 0.0.0.0
failover ip address intf3 0.0.0.0
failover ip address intf4 0.0.0.0
failover ip address intf5 0.0.0.0

pdm history enable
arp timeout 14400
access-list host1 permit icmp any any
access-group host1 in interface outside
route outside 0.0.0.0 0.0.0.0 14.36.1.1 1
timeout xlate 3:00:00
timeout conn 1:00:00 half-closed 0:10:00 udp 0:02:00 rpc 0:10:00 h323
    0:05:00 sip 0:30:00 sip_media 0:02:00
timeout uauth 0:05:00 absolute
AAA-server TACACS+ protocol tacacs+
AAA-server RADIUS protocol radius
AAA-server LOCAL protocol local
no snmp-server location
no snmp-server contact
snmp-server community public
no snmp-server enable traps
floodguard enable
!--- IPsec policies.
sysopt connection permit-ipsec
no sysopt route dnat
crypto ipsec transform-set cisco ESP-Des esp-md5-hmac
crypto map cisco 10 ipsec-isakmp
crypto map cisco 10 match address 100
crypto map cisco 10 set peer 209.165.201.1
crypto map cisco 10 set transform-set cisco
crypto map cisco interface outside
!--- IKE policies.
isakmp enable outside
isakmp key ***** address 209.165.201.1 netmask 255.255.255.255
isakmp policy 1 authentication pre-share
isakmp policy 1 encryption Des
isakmp policy 1 hash md5
isakmp policy 1 group 2
isakmp policy 1 lifetime 86400
telnet timeout 5
ssh timeout 5
terminal width 80
Cryptochecksum:02a61666fbc808eaf2ba99b69d544df7
: end
[OK]

```

Verifying Your Configuration

You can use the following commands to confirm that your configuration is working properly.

To display the settings used by the current IPSec SAs, enter the following command:

```
show crypto ipsec sa
```

To display all the current IKE SAs at a peer, enter the following command:

```
show crypto isakmp sa
```

To display the VLAN associated with the crypto configuration, enter the following command:

```
show crypto vlan
```

To display the VPNSM statistics, enter the following command:

```
show crypto eli
```

Manual Configuration with NAT

In this example, two PIX Firewall units are used to create a Virtual Private Network (VPN) between the networks on each PIX Firewall unit's inside interface. This section includes the following topics:

- [PIX Firewall 1 Configuration, page 35](#)
- [PIX Firewall 2 Configuration, page 7-37](#)

This network is part of an intranet. In this example, the VPN is created without the use of IKE or a CA and pre-shared keys are used.

PIX Firewall 1 Configuration

Follow these steps to program the PIX Firewall 1 unit for IPSec:

Step 1 Create a **crypto map** command statement.

Step 2 Create the **access-list** command entries to select traffic for this policy.



Note For manual keying, only one **access-list permit** command statement is permitted in the configuration.

Step 3 Create the transform set for the **crypto** command statement entry.

Step 4 Define cryptographic state informations. These include SPI, and the necessary keys for manual keying and policy negotiation for ISAKMP.

Step 5 Repeat Steps 1-4 for each group of policies.

Step 6 Associate the **crypto map** command statement with an interface.

Example 7-11 lists the configuration for PIX Firewall 1.

Example 7-11 Two Interfaces with IPSec—PIX Firewall 1 Configuration

```

nameif ethernet0 outside security0
nameif ethernet1 inside security100
interface ethernet0 auto
interface ethernet1 auto
ip address outside 192.168.1.1 255.255.255.0
ip address inside 10.1.1.1 255.255.255.0
enable password 8Ry2YjIyt7RRXU24 encrypted
passwd 2KFQnbNIdI.2KYOU encrypted
hostname pixfirewall
fixup protocol ftp 21
fixup protocol http 80
fixup protocol smtp 25
fixup protocol h323 1720
fixup protocol rsh 514
fixup protocol sqlnet 1521
access-list 10 permit ip host 192.168.128.3 host 209.165.200.225
no failover
failover ip address outside 0.0.0.0
failover ip address inside 0.0.0.0
names
pager lines 24
no logging timestamp
logging console debugging
logging monitor errors
logging buffered errors
no logging trap
logging facility 20
mtu outside 1500
mtu inside 1500
arp timeout 14400
nat (inside) 1 0 0
global (outside) 1 192.168.1.100-192.168.1.150
static (inside,outside) 192.168.128.3 10.1.1.3 netmask 255.255.255.255 0 0
no rip outside passive
no rip outside default
no rip inside passive
no rip inside default
route outside 0.0.0.0 0.0.0.0 192.168.1.49 1
timeout xlate 3:00:00 conn 1:00:00 half-closed 0:10:00 udp 0:02:00
timeout rpc 0:10:00 h323 0:05:00
timeout uauth 0:05:00 absolute
no snmp-server location
no snmp-server contact
snmp-server community public
no snmp-server enable traps
sysopt connection tcpmss 1380
sysopt connection permit-ipsec
crypto ipsec transform-set myset ah-md5-hmac esp-des
crypto map mymap 10 ipsec-manual
crypto map mymap 10 match address 10
crypto map mymap 10 set peer 192.168.1.100
crypto map mymap 10 set transform-set myset
crypto map mymap 10 set session-key inbound ah 400 123456789A123456789A123456789A12
crypto map mymap 10 set session-key outbound ah 300 123456789A123456789A123456789A12
crypto map mymap 10 set session-key inbound esp 400 cipher abcd1234abcd1234
crypto map mymap 10 set session-key outbound esp 300 cipher abcd1234abcd1234
telnet timeout 5
terminal width 80
crypto map mymap interface outside

```

PIX Firewall 2 Configuration

Follow these steps to program the PIX Firewall 2 unit for IPsec:

-
- Step 1** Create a **crypto map** command statement.
- Step 2** Create the **access-list** command entries to select traffic for this policy.
-  **Note** For manual keying, only one **access-list permit** command statement is permitted in the configuration.
-
- Step 3** Create the transform set for the **crypto** command statement entry.
- Step 4** Define cryptographic state informations. These include SPI, and the necessary keys for manual keying and policy negotiation for ISAKMP.
- Step 5** Repeat Steps 1-4 for each group of policies.
- Step 6** Associate the **crypto map** command statement with an interface.
-

[Example 7-12](#) lists the configuration for PIX Firewall 2.

Example 7-12 Two Interfaces with IPsec—PIX Firewall 2 Configuration

```
nameif ethernet0 outside security0
nameif ethernet1 inside security100
interface ethernet0 auto
interface ethernet1 auto
ip address outside 209.165.201.3 255.255.255.224
ip address inside 10.0.0.3 255.255.255.0
enable password 8Ry2YjIyt7RRXU24 encrypted
passwd 2KFQnbNIdI.2KYOU encrypted
hostname pixfirewall
fixup protocol ftp 21
fixup protocol http 80
fixup protocol smtp 25
fixup protocol h323 1720
fixup protocol rsh 514
fixup protocol sqlnet 1521
access-list 10 permit ip host 209.165.200.225 host 192.168.128.3
no failover
failover ip address outside 0.0.0.0
failover ip address inside 0.0.0.0
names
pager lines 24
no logging timestamp
logging console debugging
logging monitor errors
logging buffered errors
no logging trap
logging facility 20
mtu outside 1500
mtu inside 1500
arp timeout 14400
nat (inside) 1 0 0
static (inside,outside) 209.165.200.225 10.0.0.3 netmask 255.255.255.255 0 0
route outside 0.0.0.0 0.0.0.0 192.168.1.49 1
route inside 10.0.0.0 255.255.255.0 10.0.0.3 1
timeout xlate 3:00:00 conn 1:00:00 half-closed 0:10:00 udp 0:02:00
timeout rpc 0:10:00 h323 0:05:00
```

```
timeout uauth 0:05:00 absolute
no snmp-server location
no snmp-server contact
snmp-server community public
no snmp-server enable traps
no rip outside passive
no rip outside default
no rip inside passive
no rip inside default
sysopt connection tcpmss 1380
crypto ipsec transform-set myset ah-md5-hmac esp-des
crypto map mymap 10 ipsec-manual
crypto map mymap 10 match address 10
crypto map mymap 10 set peer 192.168.1.1
crypto map mymap 10 set transform-set myset
crypto map mymap 10 set session-key inbound ah 300 123456789A123456789A123456789A12
crypto map mymap 10 set session-key outbound ah 400 123456789A123456789A123456789A12
crypto map mymap 10 set session-key inbound esp 300 cipher abcd1234abcd1234
crypto map mymap 10 set session-key outbound esp 400 cipher abcd1234abcd1234
telnet timeout 5
terminal width 80
```



Managing VPN Remote Access

This chapter describes how to configure the PIX Firewall as an Easy VPN Server and how to configure Easy VPN Remote software clients. It also describes how to use the PIX Firewall with Point-to-Point Tunneling Protocol (PPTP) clients. This chapter includes the following sections:

- [Using the PIX Firewall as an Easy VPN Server, page 8-1](#)
- [Configuring Extended Authentication \(Xauth\), page 8-5](#)
- [Configuring Easy VPN Remote Devices with IKE Mode Config, page 8-7](#)
- [Using an Easy VPN Remote Device with Pre-Shared Keys, page 8-8](#)
- [Using an Easy VPN Remote Device with Digital Certificates, page 8-13](#)
- [Using PPTP for Remote Access, page 8-20](#)



Note

To enable remote access to the firewall, you must use a dynamic crypto map when configuring IPSec. A dynamic crypto map acts as a template where the missing parameters are dynamically assigned based on the IKE negotiation. For more information about configuring dynamic crypto maps, see “[Using Dynamic Crypto Maps](#)” in [Chapter 6, “Configuring IPSec and Certification Authorities.”](#)”

Using the PIX Firewall as an Easy VPN Server

This section describes how to use the PIX Firewall as an Easy VPN Server and includes the following topics:

- [Overview, page 8-2](#)
- [Enabling Redundancy, page 8-4](#)
- [Configuring Secure Unit Authentication, page 8-4](#)
- [Configuring Individual User Authentication, page 8-4](#)
- [Bypassing AAA Authentication, page 8-5](#)

Overview

With software Version 6.2 and later releases, you can configure the PIX Firewall as an Easy VPN Server. When used as an Easy VPN Server, the firewall can push VPN configuration to any Easy VPN Remote device, which greatly simplifies configuration and administration. [Figure 8-1](#) illustrates how an Easy VPN Server can be used in a Virtual Private Network (VPN).

Figure 8-1 Using the PIX Firewall as an Easy VPN Server

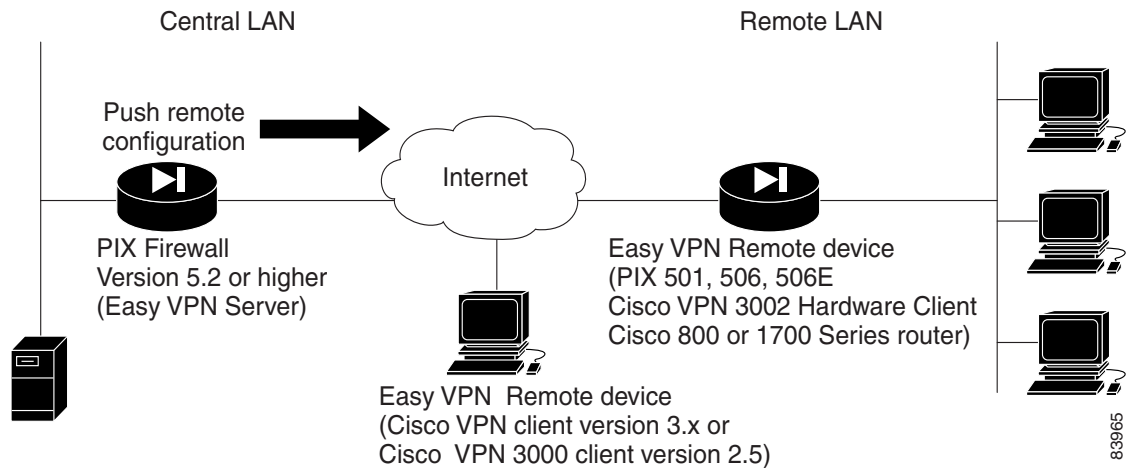

Using the PIX Firewall as an Easy VPN Server lets you configure your VPN policy in a single location on the PIX Firewall and then push this configuration to multiple Easy VPN Remote devices. The following are the different types of Easy VPN Remote devices you can use with a PIX Firewall configured as an Easy VPN Server:

- Software clients—Connect directly to the Easy VPN Server but require prior installation and configuration of client software on each host computer. These include the following:
 - Cisco VPN Client Version 3.x (also known as Unity Client 3.x)
 - Cisco VPN 3000 Client version 2.5 (also known as the Altiga VPN Client Version 2.5)
- Hardware clients—Allow multiple hosts on a remote network to access a network protected by an Easy VPN Server without any special configuration or software installation on the remote hosts. These include the following:
 - PIX 501 or PIX 506/506E
 - Cisco VPN 3002 Hardware Client
 - Cisco IOS-based Easy VPN Remote devices (for example, Cisco 800 series and Cisco 1700 series routers)

You use the **vpngroup** command to associate security policy attributes with a VPN group name. These attributes are pushed to any Easy VPN Remote devices assigned to the group. The subsequent sections and examples in this chapter describe how to use this command for implementing different options and scenarios. See the *Cisco PIX Firewall Command Reference* for the complete command syntax.

The configuration instructions and examples in this chapter assume that you are using an Easy VPN Remote device (except for the [“Using PPTP for Remote Access”](#) section on page 8-20). For information about using a PIX 501 or PIX 506/506E as an Easy VPN Remote device, refer to [Chapter 4, “Using PIX Firewall in SOHO Networks.”](#)

**Note**

PIX Firewall Version 6.3 introduces a feature that lets you establish a management connection to the inside interface of a PIX Firewall over a VPN tunnel. This feature is designed for remote management of a PIX Firewall used as an Easy VPN Remote device, which typically has an IP address dynamically assigned to its outside interface. For further information, refer to [“Connecting to PIX Firewall Over a VPN Tunnel”](#) in Chapter 9, [“Accessing and Monitoring PIX Firewall.”](#)

For information about configuring remote access for other VPN software clients, including L2TP, Windows 2000, and Cisco Secure VPN Client Version 1.1, refer to [Appendix B, “Configuration Examples for Other Remote Access Clients.”](#)

**Note**

Before you install the Cisco VPN 3000 Client Version 2.5 or the Cisco VPN Client Version 3.x on a remote host computer, uninstall any Cisco Secure VPN Client Version 1.1 software and clear the associated directories.

The configuration of the PIX Firewall as an Easy VPN Server is similar regardless of the type of Easy VPN Remote device that you are using. However, certain Easy VPN Server features and options only apply when using an Easy VPN Remote hardware client.

For instance, when using a hardware client, two different modes of operation can be enabled on the Easy VPN Remote device:

- Client mode
- Network extension mode

Client mode causes VPN connections to be initiated by traffic from the Easy VPN Remote device, so resources are only used on demand. In client mode, the Easy VPN Remote device applies Network Address Translation (NAT) to all IP addresses of clients connected to the inside (higher security) interface of the Easy VPN Remote device.

Network extension mode keeps VPN connections open even when not required for transmitting traffic and no address translation is applied. In network extension mode, the IP addresses of clients on the inside interface of the Easy VPN Remote device are sent without change to the Easy VPN Server.

**Note**

Client mode and network extension mode are configured on the Easy VPN Remote device. For more information, refer to [“Using PIX Firewall as an Easy VPN Remote Device”](#) in Chapter 4, [“Using PIX Firewall in SOHO Networks.”](#)

The PIX Firewall uses the IKE Mode Config protocol to download the attributes to the Easy VPN Remote device, including the following:

- DNS, WINS, and default domain (in client mode)
- Split tunnel mode attributes

The split tunnel mode allows the PIX Firewall to define a policy for encrypting certain traffic and transmitting other traffic in clear text. With split tunnelling enabled, the VPN client PC can access the Internet while the VPN client is running. For more information about configuring these parameters, refer to [“Configuring Easy VPN Remote Devices with IKE Mode Config”](#) in Chapter 8, [“Managing VPN Remote Access.”](#)

Enabling Redundancy

PIX Firewall Version 6.3 introduces support for redundancy among Easy VPN Servers. You can define a list of servers on an Easy VPN Server that can be pushed to the Easy VPN Remote. When no backup Easy VPN Server is configured, what happens after a failure to connect to the Easy VPN server depends on SUA status and whether the Easy VPN Remote device is in client mode or network extension mode. In client mode, without SUA, traffic continues to trigger subsequent connections to the Easy VPN Server. In network extension mode, without SUA, the Easy VPN Remote device continually tries to reconnect to the primary server. With SUA, a connection failure message is displayed and all connection attempts must be manually triggered.

To define a list of backup servers, enter the following command on the PIX Firewall used as the Easy VPN Server:

```
vpngroup groupname backup-server ipaddr1 [ipaddr2 .. ipaddr10]
```

To clear the current client configuration, enter the following command on the PIX Firewall used as the Easy VPN Server:

```
vpngroup groupname backup-server clear-client-cfg
```

Configuring Secure Unit Authentication

Secure Unit Authentication (SUA) provides increased security when allowing access to an Easy VPN Server from an Easy VPN Remote device. With SUA, one-time passwords, two-factor authentication, and similar authentication schemes can be used to authenticate the Easy VPN Remote device during Extended Authentication (Xauth). SUA is specified in the VPN Policy on the Easy VPN Server and is downloaded to the Easy VPN Remote device. This enables SUA and determines the connection behavior of the Easy VPN Remote device.

To add SUA to the VPN policy for a VPN group, enter the following command at the CLI of the Easy VPN Server:

```
vpngroup groupname secure-unit-authentication
```

This command enables SUA for the VPN group identified by *groupname*.

To disable SUA for a VPN policy, remove the configuration for the corresponding VPN group. Note that VPN policy changes are updated on Easy VPN Remote devices only after the next connection following the policy configuration change.

Configuring Individual User Authentication

Individual User Authentication (IUA) supports individually authenticating clients on the inside network of the Easy VPN Remote, based on the IP address of each inside client. IUA supports both static and OTP authentication mechanisms.

IUA is enabled by means of the downloaded VPN policy and it cannot be configured locally. To enable IUA on a PIX Firewall used as the Easy VPN Server, enter the following command:

```
vpngroup groupname user-authentication
```

This command enables individual user authentication for the VPN group identified by *groupname*.

To specify the length of time that a VPN tunnel can remain open without user activity, enter the following command:

```
vpngroup groupname user-idle-timeout {hh:mm:ss}
```

This command specifies the length of time for the specified VPN group in hours, minutes, and seconds (hh:mm:ss).

Once a downloaded VPN policy activates SUA on an Easy VPN Remote, this policy is stored locally in the FLASH memory of the PIX Firewall used as an Easy VPN Remote device.

When using IUA with a PIX Firewall, the Easy VPN Remote device sends its authentication request directly to the AAA server.

To specify the AAA server to use for IUA on a PIX Firewall being used as the Easy VPN Server, enter the following command:

```
vpngroup groupname authentication-server server_tag
```

This command specifies the AAA server identified by *server_tag* for the VPN group identified by *groupname*.

Bypassing AAA Authentication

PIX Firewall Version 6.3 lets you use Media Access Control (MAC) addresses to bypass authentication for devices, such as Cisco IP Phones, that do not support AAA authentication.

When MAC-based AAA exemption is enabled the Easy VPN Remote bypasses the AAA server for traffic that matches both the MAC address of the device and the IP address that has been dynamically assigned by a DHCP server. Authorization services are automatically disabled when you bypass authentication. Accounting records are still generated (if enabled), but the username is not displayed.

To enable this feature for a specific Easy VPN Remote device, enter the following command:

```
vpngroup groupname device-pass-through
```



Note

When using this feature with a PIX Firewall acting as an Easy VPN Remote device, the remote administrator must identify the MAC addresses that are exempt from authentication. For information about how to perform this configuration on the remote PIX Firewall, refer to “[Using MAC-Based AAA Exemption](#)” in [Chapter 3, “Controlling Network Access and Use.”](#)

Configuring Extended Authentication (Xauth)

The PIX Firewall supports the Extended Authentication (Xauth) feature within the IKE protocol. Xauth lets you deploy IPSec VPNs using TACACS+ or RADIUS as your user authentication method.

This feature, which is designed for VPN clients, provides user authentication by prompting the user for username and password and verifies them with the information stored in your TACACS+ or RADIUS database. Xauth is negotiated between IKE Phase 1 (IKE device authentication phase) and IKE Phase 2 (IPSec SA negotiation phase). If the Xauth fails, the IPSec security association will not be established and the IKE security association will be deleted.

**Note**

The IKE Mode Config feature also is negotiated between IKE Phase 1 and 2. If both features are configured, Xauth is performed first.

The Xauth feature is optional and is enabled using the **crypto map map-name client authentication aaa-group-tag** command. AAA must be configured on the PIX Firewall using the **aaa-server group_tag (if_name) host server_ip key timeout seconds** command before Xauth is enabled. Use the same AAA server name within the **aaa-server** and **crypto map client authentication** command statements. See the **aaa-server** command and the **crypto map** command in the *Cisco PIX Firewall Command Reference* for more information.

Follow these steps to configure Xauth on your PIX Firewall:

Step 1 Set up your basic AAA Server:

```
aaa-server group_tag (if_name) host server_ip key
```

For example:

```
aaa-server TACACS+ (outside) host 10.0.0.2 secret123
```

This example specifies that the authentication server with the IP address 10.0.0.2 resides on the outside interface and is in the default TACACS+ server group. The key “secret123” is used between the PIX Firewall and the TACACS+ server for encrypting data between them.

Step 2 Enable Xauth. Be sure to specify the same AAA server group tag within the **crypto map client authentication** command statement as was specified in the **aaa-server** command statement.

```
crypto map map-name client authentication aaa-group-tag
```

For example:

```
crypto map mymap client authentication TACACS+
```

In this example, Xauth is enabled at the crypto map “mymap” and the server specified in the TACACS+ group will be used for user authentication.

Step 3 (Optional) Perform this step for each site-to-site VPN peer that shares the same interface as the VPN client(s) and is configured to use a pre-shared key. This step allows the PIX Firewall to make an exception to the Xauth feature for the given site-to-site VPN peer.

```
isakmp key keystring address ip-address [netmask mask] [no-xauth] [no-config-mode]
```

For example:

```
isakmp key secretkey1234 address 10.2.2.2 netmask 255.255.255.255 no-xauth
```

Step 4 (Optional) To make an exception to the Xauth feature for the given site-to-site VPN peer, enter the following command:

```
isakmp peer fqdn fqdn [no-xauth] [no-config-mode]
```

Perform this step for each site-to-site VPN peer that shares the same interface as the VPN client(s) and is configured to use RSA-signatures.

For example:

```
isakmp peer fqdn hostname1.example.com no-xauth
```

Configuring Easy VPN Remote Devices with IKE Mode Config

A PIX Firewall used as an Easy VPN Server uses the IKE Mode Configuration (Config) protocol to download an IP address and other network level configuration to an Easy VPN Remote device as part of the IKE negotiation. During this exchange, the PIX Firewall gives an IP address to the Easy VPN Remote device that is used as an “inner” IP address encapsulated under IPsec. This provides a known IP address for the Easy VPN Remote device, which can then be matched against the IPsec policy on the Easy VPN Server.



Note

If you use IKE Mode Config on the PIX Firewall, the routers handling the IPsec traffic must also support IKE Mode Config. Cisco IOS Release 12.0(7)T and higher supports IKE Mode Config.

To configure IKE Mode Config, use the following command:

```
vpngroup groupname option
```

Replace *groupname* with an identifier to be used when configuring a particular group of Easy VPN Remote devices. The administrator of each Easy VPN Remote device enters a specific group name to access the Easy VPN Remote server.

Replace *option* with the different options required in your VPN implementation. Some of these options are required when using network extension mode, which allow central configuration of additional parameters, such as the address of the DNS server. You also use options with the **vpngroup** command to enable various Easy VPN features such as SUA, IUA, and backup servers, as described in the “Using the PIX Firewall as an Easy VPN Server” section on page 8-1.



Note

For step-by-step procedures using the **vpngroup** command to implement Easy VPN Remote devices in different scenarios, refer to the examples later in this chapter.

Table 8-1 summarizes the required and optional parameters used when configuring IKE Mode Config.

Table 8-1 Required and Optional IKE Mode Config Parameters

Option	Description	Usage
address-pool <i>poolname</i>	Pool of local addresses to be assigned to the VPN group. Use the ip local range command to identify a range of IP addresses.	Required.
dns-server <i>address</i>	IP address of a DNS server to download to the Cisco Easy VPN Remote device.	Required for network extension mode.
wins-server <i>address</i>	IP address of a WINS server to download to the Cisco Easy VPN Remote device.	Required for network extension mode.
default-domain <i>domain-name</i>	Default domain name to download to the Cisco Easy VPN Remote device.	Required for network extension mode.
split-tunnel <i>access-list</i>	Split tunneling allows both encrypted and clear traffic between the Cisco Easy VPN Remote device and the PIX Firewall.	Optional.
idle-time <i>seconds</i>	Inactivity timeout setting for the Cisco Easy VPN Remote device. The default is 30 minutes.	Optional.

When the Cisco Easy VPN Remote device initiates ISAKMP with the PIX Firewall, the VPN group name and pre-shared key (or certificate) are sent to the PIX Firewall. The PIX Firewall then uses the group name to look up the configured client policy attributes for the given Cisco Easy VPN Remote device and downloads the matching policy attributes to the client during the IKE negotiation.

If you are using a remote client other than a Cisco Easy VPN Remote device, you can still assign IP addresses dynamically, as long as the remote client supports the IKE Mode Config protocol within IPSec. For configuration examples for clients other than Easy VPN Remote devices, refer to [Appendix B, “Configuration Examples for Other Remote Access Clients”](#)

Using an Easy VPN Remote Device with Pre-Shared Keys

This example shows use of the following supported features:

- Extended Authentication (Xauth) for user authentication
- RADIUS authorization for user services authorization
- IKE Mode Config for VPN IP address assignment
- Wildcard pre-shared key for IKE authentication

This section shows use of eXtended Authentication (Xauth), RADIUS authorization, IKE Mode Config, and a wildcard, pre-shared key for IKE authentication between a PIX Firewall and an Easy VPN Remote software client.



Note

The PIX Firewall configuration provided in the first section applies to any Easy VPN Remote device. However the last section describes the configuration required for software clients. For configuration instructions when using a PIX Firewall as an Easy VPN Remote device, refer to [“Using PIX Firewall as an Easy VPN Remote Device”](#) in [Chapter 4, “Using PIX Firewall in SOHO Networks.”](#)

This section includes the following topics:

- [Scenario Description, page 8-8](#)
- [Configuring the PIX Firewall, page 8-10](#)
- [Configuring the Easy VPN Remote Software Client, page 8-13](#)

Scenario Description

With the **vpngroup** command set, you configure the PIX Firewall for a specified group of Cisco Easy VPN Remote devices, using the following parameters:

- Group name for a given group of Cisco Easy VPN Remote devices.
- Pre-shared key or group password used to authenticate your VPN access to the remote server (PIX Firewall).



Note

This pre-shared key is equivalent to the password entered in the Group Password box of Cisco Easy VPN Remote software clients while configuring the group access information for a connection entry.

- Pool of local addresses to be assigned to the VPN group.
- (Optional) IP address of a DNS server to download to the Cisco Easy VPN Remote device.
- (Optional) IP address of a WINS server to download to the Cisco Easy VPN Remote device.
- (Optional) Default domain name to download to the Cisco Easy VPN Remote device.
- (Optional) Split tunneling enabled on the PIX Firewall allowing both encrypted and clear traffic between the Cisco Easy VPN Remote device and the PIX Firewall.



Note If split tunneling is not enabled, all traffic between the Cisco Easy VPN Remote device and the PIX Firewall will be encrypted.

- (Optional) Inactivity timeout setting for the Cisco Easy VPN Remote device. The default is 30 minutes.

On the Cisco Easy VPN Remote device, you would configure the `vpngroup` name and group password to match that which you configured on the PIX Firewall.

When the Cisco Easy VPN Remote device initiates ISAKMP with the PIX Firewall, the VPN group name and pre-shared key are sent to the PIX Firewall. The PIX Firewall then uses the group name to look up the configured client policy attributes for the given Cisco Easy VPN Remote device and downloads the matching policy attributes to the client during the IKE negotiation.

Figure 8-2 illustrates the example network.

Figure 8-2 Cisco Easy VPN Remote Device Access

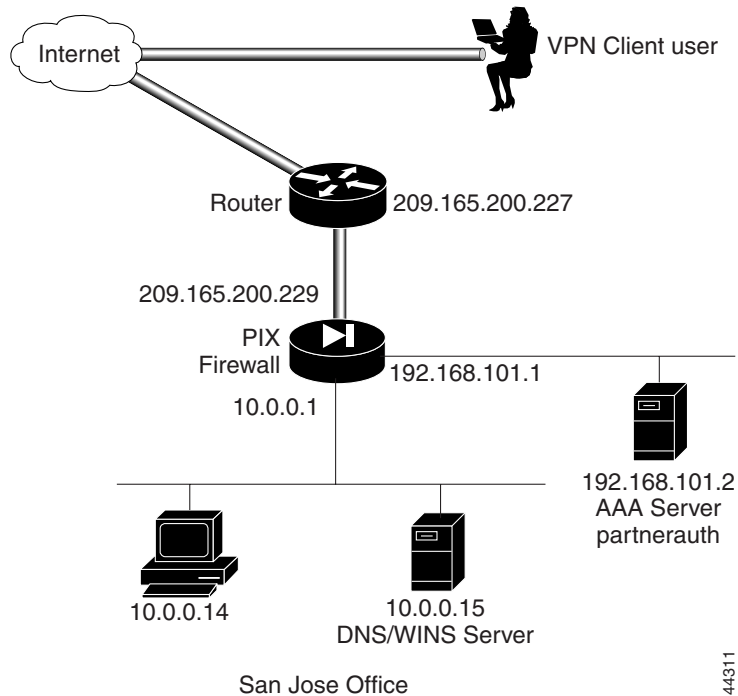

44811

Configuring the PIX Firewall

Follow these steps to configure the PIX Firewall to interoperate with the Cisco Easy VPN Remote device using Xauth, IKE Mode Config, AAA authorization with RADIUS, and a wildcard, pre-shared key:

Step 1 Define AAA related parameters:

```
aaa-server radius protocol radius
aaa-server partnerauth protocol radius
aaa-server partnerauth (dmz) host 192.168.101.2 abcdef timeout 5
```

Step 2 Configure the IKE policy:

```
isakmp enable outside
isakmp policy 8 encr 3des
isakmp policy 8 hash md5
isakmp policy 8 authentication pre-share
```



Note To configure the Cisco VPN Client Version 3.x, include the **isakmp policy 8 group 2** command in this step.

Step 3 Configure a wildcard, pre-shared key:

```
isakmp key cisco1234 address 0.0.0.0 netmask 0.0.0.0
```

Step 4 Create an access list that defines the PIX Firewall local network(s) requiring IPsec protection:

```
access-list 80 permit ip 10.0.0.0 255.255.255.0 10.1.1.0 255.255.255.0
```

Step 5 Create access lists that define the services the VPN clients are authorized to use with the RADIUS server:

```
access-list 100 permit tcp 10.1.1.0 255.255.255.0 10.0.0.0 255.255.255.0 eq telnet
access-list 100 permit tcp 10.1.1.0 255.255.255.0 10.0.0.0 255.255.255.0 eq ftp
access-list 100 permit tcp 10.1.1.0 255.255.255.0 10.0.0.0 255.255.255.0 eq http
```



Note Configure the authentication server with the vendor-specific `acl=acl_ID` identifier to specify the access-list ID. In this example, the access-list ID is 100. The entry in the authentication server would then be `acl=100`.

Step 6 Configure NAT 0:

```
nat (inside) 0 access-list 80
```

Step 7 Configure a transform set that defines how the traffic will be protected:

```
crypto ipsec transform-set strong-des esp-3des esp-sha-hmac
```

Step 8 Create a dynamic crypto map:

```
crypto dynamic-map cisco 4 set transform-set strong-des
```

Specify which transform sets are allowed for this dynamic crypto map entry.

Step 9 Add the dynamic crypto map set into a static crypto map set:

```
crypto map partner-map 20 ipsec-isakmp dynamic cisco
```

Step 10 Apply the crypto map to the outside interface:

```
crypto map partner-map interface outside
```

Step 11 Enable Xauth:

```
crypto map partner-map client authentication partnerauth
```

Step 12 Configure IKE Mode Config related parameters:

```
ip local pool dealer 10.1.1.1-10.1.1.254
```



Note To configure the Cisco VPN 3000 Client Version 2.5, include the **crypto map partner-map client configuration address initiate** command in this step.

Step 13 Configure Cisco Easy VPN Remote device policy attributes to download:

```
vpngroup superteam address-pool dealer
vpngroup superteam dns-server 10.0.0.15
vpngroup superteam wins-server 10.0.0.15
vpngroup superteam default-domain example.com
vpngroup superteam split-tunnel 80
vpngroup superteam idle-time 1800
```

The keyword “superteam” is the name of a VPN group. You will enter this VPN group name within an Easy VPN Remote software client as part of the group access information.

Step 14 Tell PIX Firewall to implicitly permit IPsec traffic:

```
sysopt connection permit-ipsec
```

[Example 8-1](#) provides the complete PIX Firewall configuration.

Example 8-1 VPN Access with Extended Authentication, RADIUS Authorization, IKE Mode Config, and Wildcard Pre-Shared Key

```
nameif ethernet0 outside security0
nameif ethernet1 inside security100
nameif ethernet2 dmz security10
enable password 8Ry2YjIyt7RRXU24 encrypted
passwd 2KFQnbNIdI.2KYOU encrypted
hostname SanJose
domain-name example.com
fixup protocol ftp 21
fixup protocol http 80
fixup protocol smtp 25
fixup protocol h323 1720
fixup protocol rsh 514
fixup protocol sqlnet 1521
names
pager lines 24
no logging on
interface ethernet0 auto
interface ethernet1 auto
interface ethernet2 auto
mtu outside 1500
mtu inside 1500
mtu dmz 1500
ip address outside 209.165.200.229 255.255.255.224
```

```

ip address inside 10.0.0.1 255.255.255.0
ip address dmz 192.168.101.1 255.255.255.0
no failover
failover ip address outside 0.0.0.0
failover ip address inside 0.0.0.0
failover ip address dmz 0.0.0.0
arp timeout 14400
nat (inside) 1 0.0.0.0 0.0.0.0 0 0
access-list 80 permit ip 10.0.0.0 255.255.255.0 10.1.1.0 255.255.255.0
access-list 100 permit tcp 10.1.1.0 255.255.255.0 10.0.0.0 255.255.255.0 eq telnet
access-list 100 permit tcp 10.1.1.0 255.255.255.0 10.0.0.0 255.255.255.0 eq ftp
access-list 100 permit tcp 10.1.1.0 255.255.255.0 10.0.0.0 255.255.255.0 eq http
nat (inside) 0 access-list 80
global (outside) 1 209.165.200.45-209.165.200.50 netmask 255.255.255.224
route outside 0.0.0.0 0.0.0.0 209.165.200.227 1
timeout xlate 3:00:00 conn 1:00:00 half-closed 0:10:00 udp 0:02:00
timeout rpc 0:10:00 h323 0:05:00
timeout uauth 0:05:00 absolute
ip local pool dealer 10.1.1.1-10.1.1.254
aaa-server TACACS+ protocol tacacs+
aaa-server RADIUS protocol radius
aaa-server partnerauth protocol tacacs+
aaa-server partnerauth (dmz) host 192.168.101.2 abcdef timeout 5
no snmp-server location
no snmp-server contact
snmp-server community public
no snmp-server enable traps
crypto map partner-map client configuration address initiate;
crypto ipsec transform-set strong-des esp-3des esp-sha-hmac
crypto dynamic-map cisco 4 set transform-set strong-des
crypto map partner-map 20 ipsec-isakmp dynamic cisco
crypto map partner-map client authentication partnerauth
crypto map partner-map interface outside
isakmp key cisco1234 address 0.0.0.0 netmask 0.0.0.0
isakmp enable outside
isakmp policy 8 authentication pre-share
isakmp policy 8 encryption 3des
isakmp policy 8 hash md5
isakmp policy 8 group 2
vpngroup superteam address-pool dealer
vpngroup superteam dns-server 10.0.0.15
vpngroup superteam wins-server 10.0.0.15
vpngroup superteam default-domain example.com
vpngroup superteam split-tunnel 80
vpngroup superteam idle-time 1800
sysopt connection permit-ipsec
telnet timeout 5
terminal width 80

```

**Note**

The **crypto map partner-map client configuration address initiate** command is only required to configure the Cisco VPN 3000 Client Version 2.5. The **isakmp policy 8 group 2** command is only required to configure the Cisco VPN Client Version 3.x.

Configuring the Easy VPN Remote Software Client

This section describes how to configure an Easy VPN Remote software client to match the configurations in “[Configuring the PIX Firewall](#).” It is assumed the Easy VPN Remote software client is already installed on your system and is configured for general use. You can find the Easy VPN Remote software client documentation online at the following website:

<http://www.cisco.com/univercd/cc/td/doc/product/vpn/index.htm>

To allow the Easy VPN Remote software client to gain VPN access to the PIX Firewall using a pre-shared key, create one connection entry for the Easy VPN Remote software client that identifies the following:

- Host name or IP address of the remote server you want to access, which in this case is a PIX Firewall
- Name of the VPN group you belong to
- Pre-shared key or password of the VPN group you belong to

Refer to the *VPN Client User Guide* for the detailed steps to configure the Easy VPN Remote software client.

Using an Easy VPN Remote Device with Digital Certificates

This example shows use of the following supported features:

- Extended Authentication (Xauth) for user authentication
- IKE Mode Config for VPN IP address assignment
- Digital certificates for IKE authentication

This section shows use of Xauth, IKE Mode Config, and digital certificates for IKE authentication between a PIX Firewall and an Easy VPN Remote software client.



Note

The PIX Firewall configuration provided in the first section applies to any Easy VPN Remote device. However, the last section describes the configuration required for software clients. For configuration instructions when using a PIX Firewall as an Easy VPN Remote device, refer to the “[Using PIX Firewall as an Easy VPN Remote Device](#)” section on page 4-1.

This section includes the following topics:

- [Client Verification of the Easy VPN Server Certificate, page 8-14](#)
- [Scenario Description, page 8-14](#)
- [Configuring the PIX Firewall, page 8-16](#)
- [Configuring the Easy VPN Remote Software Client, page 8-19](#)



Note

Both the PIX Firewall and the Easy VPN Remote device must obtain digital certificates from the same CA server so that both are certified by the same root CA server. The PIX Firewall only supports use of one root CA server per VPN peer.

Client Verification of the Easy VPN Server Certificate

PIX Firewall Version 6.3 introduces a method for verifying the distinguished name (DN) of the Easy VPN Server during ISAKMP negotiation. If the DN of the certificate received by the Easy VPN Remote device does not match, the negotiation fails. We recommend using this feature to prevent a “man-in-the-middle” attack. To identify the DN of the PIX Firewall on a PIX Firewall used as an Easy VPN hardware client, refer to [“Verifying the DN of an Easy VPN Server” section on page 4-10](#).

To identify the DN of the PIX Firewall on an Easy VPN software client, create a .pcf file and use the CertSubjectName keyword. On the line following the CertSubjectName keyword, enter the following parameter:

```
VerifyCertDn=x500 string
```

For example, consider the following entry:

```
CertSubjectName
VerifyCertDn=cn*myvpn, ou=myou, o=myorg, st=ca, c=US
```

This entry causes the receiving Easy VPN software client to accept certificates with a DN having the following attributes:

- Common name (CN) contains the string *myvpn*
- Organizational unit (OU) equals *myou*
- Organization (O) equals *myorg*
- State (ST) equals *CA*
- Country (C) equals *US*

You could be more restrictive by identifying a specific common name, or less restrictive by omitting the CN attribute altogether.

You can use an asterisk (*) to match an attribute containing the string following the asterisk. Use an exclamation mark (!) to match an attribute that does not contain the characters following the exclamation mark.



Note

The verification of the DN fails unless every attribute matches exactly.

For details about using a .pcf file for creating a connection profile for an Easy VPN software client, refer to the VPN Client Administrator Guide.

Scenario Description

For example purposes, the PIX Firewall is shown to interoperate with the Entrust CA server. The specific CA-related commands you enter depend on the CA you are using.



Note

The PIX Firewall supports CA servers developed by VeriSign, Entrust, Baltimore Technologies, and Microsoft. See [“Using Certification Authorities”](#) in [Chapter 6, “Configuring IPsec and Certification Authorities,”](#) for general configuration procedures. See [Chapter 7, “Site-to-Site VPN Configuration Examples,”](#) for examples showing how to interoperate with different PIX Firewall-supported CA servers.

On the PIX Firewall, configure the unit to interoperate with the CA server to obtain a digital certificate. With the **vpngroup** command set, configure the PIX Firewall for a specified group of Easy VPN Remote devices, using the following parameters:

- Pool of local addresses to be assigned to the VPN group
- (Optional) IP address of a DNS server to download to the Easy VPN Remote device
- (Optional) IP address of a WINS server to download to the Easy VPN Remote device
- (Optional) Default domain name to download to the Easy VPN Remote device
- (Optional) Split tunneling on the PIX Firewall, which allows both encrypted and clear traffic between the Easy VPN Remote device and the PIX Firewall.



Note If split tunnelling is not enabled, all traffic between the Easy VPN Remote device and the PIX Firewall will be encrypted.

- (Optional) Inactivity timeout for the Easy VPN Remote device. The default is 30 minutes.

On the Easy VPN Remote device, configure the client to obtain a digital certificate. After obtaining the certificate, set the Easy VPN Remote software client connection entry to use the digital certificate.

When the Easy VPN Remote device initiates ISAKMP with the PIX Firewall, the digital certificate is sent to the PIX Firewall. The PIX Firewall uses the digital certificate to look up the configured client policy attributes for the given Easy VPN Remote device and downloads the matching policy attributes to the client during the IKE negotiation.

Figure 8-3 illustrates the example network.

Figure 8-3 Easy VPN Remote Software Client Access

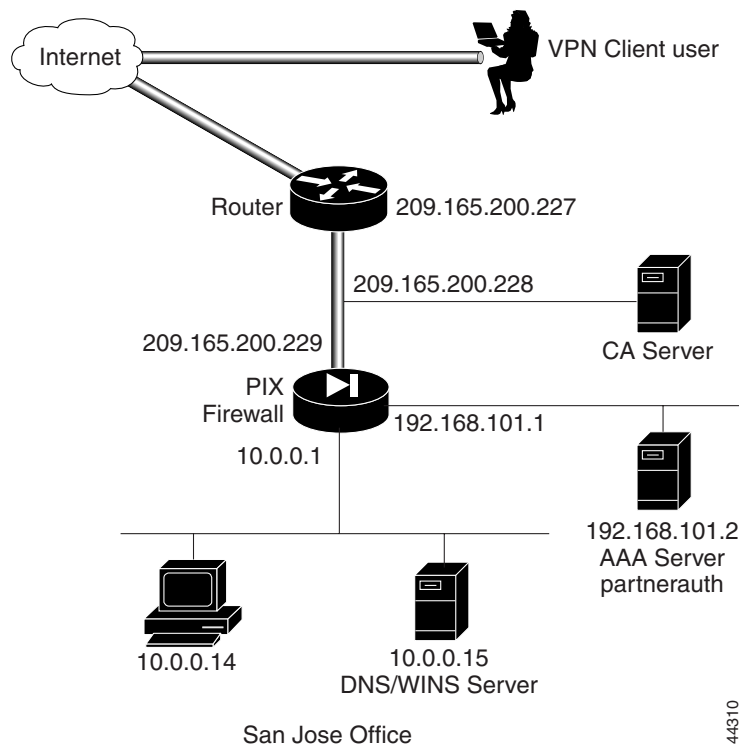

44310

Configuring the PIX Firewall

Follow these steps to configure the PIX Firewall to interoperate with the Easy VPN Remote device:

Step 1 Define AAA related parameters:

```
aaa-server TACACS+ protocol tacacs+
aaa-server partnerauth protocol tacacs+
aaa-server partnerauth (dmz) host 192.168.101.2 abcdef timeout 5
```

Step 2 Define a host name:

```
hostname SanJose
```

Step 3 Define the domain name:

```
domain-name example.com
```

Step 4 Generate the PIX Firewall RSA key pair:

```
ca generate rsa key 512
```

This command is entered at the command line and does not get stored in the configuration.

Step 5 Declare a CA:

```
ca identity abcd 209.165.200.228 209.165.200.228
```

This command is stored in the configuration.

Step 6 Configure the parameters of communication between the PIX Firewall and the CA:

```
ca configure abcd ra 1 20 crloptional
```

This command is stored in the configuration. **1** is the retry period, **20** is the retry count, and the **crloptional** option disables CRL checking.

Step 7 Authenticate the CA by obtaining its public key and its certificate:

```
ca authenticate abcd
```

This command is entered at the command line and does not get stored in the configuration:

Step 8 Request signed certificates from your CA for your PIX Firewall's RSA key pair:

```
ca enroll abcd cisco
```

Before entering this command, contact your CA administrator because they will have to authenticate your PIX Firewall manually before granting its certificate(s):

“cisco” is a challenge password. This can be anything. This command is entered at the command line and does not get stored in the configuration.

Step 9 Verify that the enrollment process was successful using the **show ca certificate** command:

```
show ca certificate
```

Step 10 Save keys and certificates, and the CA commands (except those indicated) in Flash memory:

```
ca save all
write memory
```



Note Use the **ca save all** command any time you add, change, or delete **ca** commands in the configuration. This command is not stored in the configuration.

Step 11 Set the system clock.

The clock must be accurate if you are using certificates. Enter the following command to update the system clock.

```
clock set
```

Step 12 Configure the IKE policy:

```
isakmp enable outside
isakmp policy 8 encr 3des
isakmp policy 8 hash md5
isakmp policy 8 authentication rsa-sig
```

Step 13 Create an access list that defines the local network(s) requiring IPsec protection:

```
access-list 90 permit ip 10.0.0.0 255.255.255.0 10.1.1.0 255.255.255.0
```

Step 14 Configure NAT 0:

```
nat (inside) 0 access-list 90
```

Step 15 Configure a transform set that defines how the traffic will be protected:

```
crypto ipsec transform-set strong-des esp-3des esp-sha-hmac
```

Step 16 Create a dynamic crypto map. Specify which transform sets are allowed for this dynamic crypto map entry:

```
crypto dynamic-map cisco 4 set transform-set strong-des
```

Step 17 Add the dynamic crypto map into a static crypto map:

```
crypto map partner-map 20 ipsec-isakmp dynamic cisco
```

Step 18 Apply the crypto map to the outside interface:

```
crypto map partner-map interface outside
```

Step 19 Configure the firewall to permit IPsec traffic:

```
sysopt connection permit-ipsec
```

Step 20 Enable Xauth:

```
crypto map partner-map client authentication partnerauth
```

Step 21 Configure IKE Mode parameters:

```
ip local pool dealer 10.1.1.1-10.1.1.254
crypto map partner-map client configuration address initiate
```

Step 22 Configure Easy VPN Remote device policy attributes to download to the Easy VPN Remote device:

```
vpngroup superteam address-pool dealer
vpngroup superteam dns-server 10.0.0.15
vpngroup superteam wins-server 10.0.0.15
vpngroup superteam default-domain example.com
vpngroup superteam access-list 90
vpngroup superteam idle-time 1800
```

**Note**

When configuring the VPN group name, make sure it matches the Organization Unit (OU) field in the Easy VPN Remote device certificate. The PIX Firewall uses the VPN group name to match a given VPN client policy. For example, you would use the VPN group “superteam” if the OU field is “superteam.”

[Example 8-2](#) shows the command listing. PIX Firewall default configuration and certain CA commands do not appear in configuration listings.

Example 8-2 VPN Access with Extended Authentication, RADIUS Authorization, IKE Mode Config, and Digital Certificates

```

nameif ethernet0 outside security0
nameif ethernet1 inside security100
nameif ethernet2 dmz security10
enable password 8Ry2YjIyt7RRXU24 encrypted
passwd 2KFQnbNIdI.2KYOU encrypted
hostname SanJose
domain-name example.com
fixup protocol ftp 21
fixup protocol http 80
fixup protocol smtp 25
fixup protocol h323 1720
fixup protocol rsh 514
fixup protocol sqlnet 1521
names
pager lines 24
no logging on
interface ethernet0 auto
interface ethernet1 auto
interface ethernet2 auto
mtu outside 1500
mtu inside 1500
mtu dmz 1500
ip address outside 209.165.200.229 255.255.255.224
ip address inside 10.0.0.1 255.255.255.0
ip address dmz 192.168.101.1 255.255.255.0
no failover
failover ip address outside 0.0.0.0
failover ip address inside 0.0.0.0
failover ip address dmz 0.0.0.0
arp timeout 14400
nat (inside) 1 0.0.0.0 0.0.0.0 0 0
access-list 90 permit ip 10.0.0.0 255.255.255.0 10.1.1.0 255.255.255.0
access-list 100 permit tcp 10.1.1.0 255.255.255.0 10.0.0.0 255.255.255.0 eq telnet
access-list 100 permit tcp 10.1.1.0 255.255.255.0 10.0.0.0 255.255.255.0 eq ftp
access-list 100 permit tcp 10.1.1.0 255.255.255.0 10.0.0.0 255.255.255.0 eq http
nat (inside) 0 access-list 90
global (outside) 1 209.165.200.45-209.165.200.50 netmask 255.255.255.224
route outside 0.0.0.0 0.0.0.0 209.165.200.227 1
timeout xlate 3:00:00 conn 1:00:00 half-closed 0:10:00 udp 0:02:00
timeout rpc 0:10:00 h323 0:05:00
timeout uauth 0:05:00 absolute
ip local pool dealer 10.1.1.1-10.1.1.254
aaa-server TACACS+ protocol tacacs+
aaa-server RADIUS protocol radius
aaa-server partnerauth protocol tacacs+
aaa-server partnerauth (dmz) host 192.168.101.2 abcdef timeout 5
no snmp-server location

```

```

no snmp-server contact
snmp-server community public
no snmp-server enable traps
crypto ipsec transform-set strong-des esp-3des esp-sha-hmac
crypto dynamic-map cisco 4 set transform-set strong-des
crypto map partner-map 20 ipsec-isakmp dynamic cisco
crypto map partner-map client authentication partnerauth
crypto map partner-map interface outside
isakmp enable outside
isakmp policy 8 encryption 3des
isakmp policy 8 hash md5
isakmp policy 8 authentication rsa-sig
vpngroup superteam address-pool dealer
vpngroup superteam dns-server 10.0.0.15
vpngroup superteam wins-server 10.0.0.15
vpngroup superteam default-domain example.com
vpngroup superteam split-tunnel 90
vpngroup superteam idle-time 1800
ca identity abcd 209.165.200.228 209.165.200.228
ca configure abcd ra 1 100 crloptional
sysopt connection permit-ipsec
telnet timeout 5
terminal width 80

```

**Note**

The `crypto map partner-map client configuration address initiate` command is only required to configure the Cisco VPN client Version 2.5.

Configuring the Easy VPN Remote Software Client

This section describes how to configure the Easy VPN Remote software client to match the configurations in “[Configuring the PIX Firewall](#).” It is assumed the Easy VPN Remote software client is already installed on your system and is configured for general use. You can find the Easy VPN Remote software client documentation online at the following website:

<http://www.cisco.com/univercd/cc/td/doc/product/vpn/index.htm>

For the Easy VPN Remote software client to gain VPN access to the PIX Firewall using a digital certificate, obtain a digital certificate from a CA server. Once you have this certificate, create a VPN client connection entry that identifies the following:

- Host name or IP address of the remote server you want to access, which in this case is a PIX Firewall.
- Certificate name. (This should already be installed on your Easy VPN Remote software client.)

This section does not cover how to obtain a digital certificate for the Easy VPN Remote software client. For information about obtaining a certificate for the Easy VPN Remote software client, refer to the chapter “Enrolling and Managing Certificates” within the *VPN Client User Guide*.

To obtain the detailed steps to follow when configuring the Easy VPN Remote software client, refer to the chapter “Configuring and Managing Connection Entries” in the *VPN Client User Guide*.

Using PPTP for Remote Access

This section describes how to implement the Point-to-Point Tunneling Protocol (PPTP) using the PIX Firewall. It contains the following topics:

- [Overview, page 8-20](#)
- [PPTP Configuration, page 8-21](#)
- [PPTP Configuration Example, page 8-21](#)

Overview

The firewall provides support for Microsoft PPTP, which is an alternative to IPSec handling for VPN clients. While PPTP is less secure than IPSec, PPTP may be easier in some networks to implement and maintain.

The **vpdn** command implements the PPTP feature for inbound connections between the firewall and a Windows client. Point-to-Point Tunneling Protocol (PPTP) is a Layer 2 tunneling protocol, which lets a remote client use a public IP network to communicate securely with servers at a private corporate network. PPTP tunnels the IP protocol. RFC 2637 describes the PPTP protocol.

Support is provided for only inbound PPTP and only one firewall interface can have the **vpdn** command enabled.

Supported authentication protocols include: PAP, CHAP, and MS-CHAP using external AAA (RADIUS or TACACS+) servers or the firewall local username and password database. Through the PPP IPCP protocol negotiation, the firewall assigns a dynamic internal IP address to the PPTP client allocated from a locally defined IP address pool.

The firewall PPTP VPN supports standard PPP CCP negotiations with Microsoft Point-To-Point Encryption (MPPE) extensions using RSA/RC4 algorithm. MPPE currently supports 40-bit and 128-bit session keys. MPPE generates an initial key during user authentication and refreshes the key regularly. In this release, compression is not supported.

When you specify MPPE, use the MS-CHAP PPP authentication protocol. If you are using an external AAA server, the protocol should be RADIUS and the external RADIUS server should be able to return the Microsoft MSCHAP_MPPE_KEY attribute to the firewall in the RADIUS Authentication Accept packet. See RFC 2548, "Microsoft Vendor Specific RADIUS Attributes," for more information on the MSCHAP_MPPE_KEY attribute.

Cisco Secure ACS 2.5/2.6 and higher releases support the MS-CHAP/MPPE encryption.

The firewall PPTP VPN has been tested with the following Microsoft Windows products: Windows 95 with DUN1.3, Windows 98, Windows NT 4.0 with SP6, and Windows 2000.



Note

If you configure the firewall for 128-bit encryption and if a Windows 95 or Windows 98 client does not support 128-bit or greater encryption, then the connection to the firewall is refused. When this occurs, the Windows client moves the dial-up connection menu down to the screen corner while the PPP negotiation is in progress. This gives the appearance that the connection is accepted when it is not. When the PPP negotiation completes, the tunnel terminates and the firewall ends the connection. The Windows client eventually times out and disconnects.

PPTP Configuration

Use the **vpdn** command with the **sysopt connection permit-pptp** command to allow PPTP traffic to bypass checking of **access-list** command statements.

The **show vpdn** command lists tunnel and session information.

The **clear vpdn** command removes all **vpdn** commands from the configurations and stops all the active PPTP tunnels. The **clear vpdn all** command lets you remove all tunnels, and the **clear vpdn id tunnel_id** command lets you remove tunnels associated with *tunnel_id*. (You can view the *tunnel_id* with the **show vpdn** command.)

The **clear vpdn group** command removes all the **vpdn group** commands from the configuration. The **clear vpdn username** command removes all the **vpdn username** commands from the configuration. The **clear vpdn** command removes all **vpdn** commands from the configuration.

You can troubleshoot PPTP traffic with the **debug ppp** and **debug vpdn** commands.

PPTP Configuration Example

[Example 8-3](#) shows a simple configuration, which lets a Windows PPTP client dial in without any authentication (not recommended). Refer to the **vpdn** command page in the *Cisco PIX Firewall Command Reference* for more examples and descriptions of the **vpdn** commands and the command syntax.

Example 8-3 PPTP Configuration Example

```
ip local pool my-addr-pool 10.1.1.1-10.1.1.254
vpdn group 1 accept dialin pptp
vpdn group 1 client configuration address local my-addr-pool
vpdn enable outside
static (inside, outside) 209.165.201.2 192.168.0.2 netmask 255.255.255.255
access-list acl_out permit tcp any host 209.165.201.2 eq telnet
access-group acl_out in interface outside
```

The **ip local pool** command specifies the IP addresses assigned to each VPN client as they log in to the network. The Windows client can Telnet to host 192.168.0.2 through the global IP address 209.165.201.2 in the **static** command statement. The **access-list** command statement permits Telnet access to the host.



Accessing and Monitoring PIX Firewall

This chapter describes how to configure and use the tools and features provided by the PIX Firewall for monitoring and configuring the system, and for monitoring network activity. It contains the following sections:

- [Connecting to PIX Firewall Over a VPN Tunnel, page 9-1](#)
- [Command Authorization and LOCAL User Authentication, page 9-2](#)
- [Configuring PIX Firewall Banners, page 9-10](#)
- [Using Network Time Protocol, page 9-10](#)
- [Managing the PIX Firewall Clock, page 9-15](#)
- [Using Telnet for Remote System Management, page 9-16](#)
- [Using SSH for Remote System Management, page 9-21](#)
- [Enabling Auto Update Support, page 9-25](#)
- [Capturing Packets, page 9-27](#)
- [Saving Crash Information to Flash Memory, page 9-31](#)
- [Using Syslog, page 9-32](#)
- [Using SNMP, page 9-41](#)

Connecting to PIX Firewall Over a VPN Tunnel

PIX Firewall Version 6.3 allows a remote management connection to any interface of a PIX Firewall over a VPN tunnel. This feature is useful for remotely managing a PIX Firewall used as an Easy VPN Remote device, which typically has an unknown IP address assigned dynamically to the outside interface.

The network management applications that are currently supported include the following:

- AAA
- Network Time Protocol (NTP)
- Ping
- PIX Device Manager (PDM)
- Telnet
- Secure shell (SSH)

- SNMP
- SNMP traps
- Syslogs

To enable management access over a VPN tunnel, enter the following command:

```
management-access mgmt_if
```

Replace *mgmt_if* with the IP address assigned to the interface of the remote PIX Firewall to which you want to connect.

Note

You must enable management access for each interface that is connected to the supported management services that you want to use.

Command Authorization and LOCAL User Authentication

This section describes the Command Authorization feature and related topics, introduced with PIX Firewall Version 6.2. It includes the following topics:

- [Privilege Levels, page 9-2](#)
- [User Authentication, page 9-3](#)
- [Command Authorization, page 9-5](#)
- [Recovering from Lockout, page 9-9](#)

Privilege Levels

PIX Firewall Version 6.2 and higher supports up to 16 privilege levels. This is similar to what is available with Cisco IOS software. With this feature, you can assign PIX Firewall commands to one of 16 levels. Also, users logging into the PIX Firewall are assigned privilege levels.

Note

Users with a privilege level greater than or equal to 2 have access to the enable and configuration mode and therefore the PIX Firewall prompt changes to #. Users with a privilege level 0 or 1 see the prompt >.

When a user tries to access enable mode, if the message “T+ enable privilege too low” appears on the AAA server, set the Max privilege of the AAA client to Level1 in the Advanced TACACS options.

To enable different privilege levels on the PIX Firewall, use the **enable** command in configuration mode. To assign a password to a privilege level, enter the following command:

```
pix(config)# enable password [password] [level level] [encrypted]
```

Replace *password* with a character string from three to sixteen characters long, with no spaces. Replace *level* with the privilege level you want to assign to the enable password.

Note

The **encrypted** keyword indicates to the PIX Firewall that the password supplied with the **enable** command is already encrypted.

For example, the following command assigns the enable password Passw0rD to privilege Level 10:

```
enable password Passw0rD level 10
```

The following example shows the usage of the **enable password** command with the **encrypted** keyword:

```
enable password .SUTWWLlTIApDYYx level 9 encrypted
```

**Note**

Encrypted passwords that are associated with a level can only be moved among PIX Firewall units along with the associated levels.

Once the different privilege levels are created, you can gain access to a particular privilege level from the > prompt by entering the **enable** command, as follows:

```
pix> enable [privilege level]
```

Replace *privilege level* with the privilege level to which you want to gain access. If the privilege level is not specified, the default of 15 is used. By default, privilege level 15 is assigned the password **cisco**. It will always have a password associated with it unless someone assigns it a blank password using the **enable password** command.

User Authentication

This section describes how to configure the PIX Firewall to use LOCAL user authentication. It includes the following topics:

- [Creating User Accounts in the LOCAL Database, page 9-3](#)
- [User Authentication Using the LOCAL Database, page 9-4](#)
- [Viewing the Current User Account, page 9-5](#)

**Note**

PIX Firewall Version 6.2 only supports authentication using the LOCAL database for administrative access to the PIX Firewall. When using PIX Firewall Version 6.3 or higher, you can also use the LOCAL database for authentication *through* the PIX Firewall. For further information, refer to “[Configuring AAA](#)” in [Chapter 3, “Controlling Network Access and Use.”](#)

Creating User Accounts in the LOCAL Database

To define a user account in the LOCAL database, enter the following command:

```
username username {nopassword|password password [encrypted]} [privilege level]
```

Replace *username* with a character string from four to fifteen characters long. Replace *password* with a character string from three to sixteen characters long. Replace *privilege level* with the privilege level you want to assign to the new user account (from 0 to 15). Use the **nopassword** keyword to create a user account with no password. Use the **encrypted** keyword if the password you are supplying is already encrypted.

**Note**

The username database that you configure can be moved among PIX Firewall units with the rest of the configuration. Encrypted passwords can only be moved along with the associated username in the database.

For example, the following command assigns a privilege level of 15 to the user account *admin*.

```
username admin password passw0rd privilege 15
```

If no privilege level is specified, the user account is created with a privilege level of 2. You can define as many user accounts as you need.

Use the following command to create a user account with no password:

```
username username nopassword
```

Replace *username* with the user account that you want to create without a password.

To delete an existing user account, enter the following command:

```
no username username
```

Replace *username* with the user account that you want to delete. For example, the following command deletes the user account **admin**.

```
no username admin
```

To remove all the entries from the user database, enter the following command:

```
clear username
```

User Authentication Using the LOCAL Database

User authentication can be completed using the LOCAL database after user accounts are created in this database.

To enable authentication using the LOCAL database, enter the following command:

```
pix(config)# aaa authentication serial|telnet|ssh|http|enable console LOCAL
```

After entering this command, the LOCAL user accounts are used for authentication.

You can also use the **login** command, as follows, to access the PIX Firewall with a particular username and password:

```
pix> login
```

The **login** command only checks the local database while authenticating a user and does not check any authentication or authorization (AAA) server.

When you enter the **login** command, the system prompts for a username and password as follows:

```
Username:admin
Password:*****
```



Note

Users with a privilege level greater than or equal to 2 have access to the enable and configuration modes and the PIX Firewall prompt changes to #. Users with the privilege level 0 or 1 see the prompt >.

Use the following command to log out from the currently logged in user account:

```
logout
```

Viewing the Current User Account

The PIX Firewall maintains usernames in the following authentication mechanisms:

- LOCAL
- TACACS+
- RADIUS

To view the user account that is currently logged in, enter the following command:

```
show curpriv
```

The system displays the current user name and privilege level, as follows:

```
Username:admin
Current privilege level: 15
Current Mode/s:P_PRIV
```

As mentioned in the section “[Privilege Levels](#),” you use the **enable** command to obtain access to different privilege levels with the following command:

```
pix> enable [privilege level]
```

When you assign a password to a privilege level, the privilege level is associated with the password in the LOCAL database in the same way a username is associated with a password. When you obtain access to a privilege level using the **enable** command, the **show curpriv** command displays the current privilege level as a username in the format **enable_n**, where *n* is a privilege level from 1 to 15.

An example follows:

```
pix(config)# show curpriv
Username : enable_9
Current privilege level : 9
Current Mode/s : P_PRIV
```

When you enter the **enable** command without specifying the privilege level, the default privilege level (15) is assumed and the username is set to **enable_15**.

When you log into the PIX Firewall for the first time or exit from the current session, the default user name is **enable_1**, as follows:

```
pix> show curpriv
Username : enable_1
Current privilege level : 1
Current Mode/s : P_UNPR
```

Command Authorization

This section describes how to assign commands to different privilege levels. It includes the following topics:

- [Overview, page 9-6](#)
- [Configuring LOCAL Command Authorization, page 9-6](#)
- [Enabling LOCAL Command Authorization, page 9-7](#)
- [Viewing LOCAL Command Authorization Settings, page 9-7](#)
- [TACACS+ Command Authorization, page 9-8](#)

Overview

LOCAL and TACACS+ Command Authorization is supported in PIX Firewall Version 6.2 and higher. With the LOCAL command authorization feature, you can assign PIX Firewall commands to one of 16 levels.



Caution

When configuring the Command Authorization feature, *do not* save your configuration until you are sure it works the way you want. If you get locked out because of a mistake, you can usually recover access by simply restarting the PIX Firewall from the configuration that is saved in Flash memory. If you still get locked out, refer to the section “[Recovering from Lockout](#).”

Configuring LOCAL Command Authorization

In the default configuration, each PIX Firewall command is assigned to either privilege level 0 or privilege level 15. To reassign a specific command to a different privilege level, enter the following command:

```
[no] privilege [{show | clear | configure}] level level [mode {enable|configure}] command
command
```

Replace *level* with the privilege level and *command* with the command you want to assign to the specified level. You can use the **show**, **clear**, or **configure** parameter to optionally set the privilege level for the **show**, **clear**, or **configure** command modifiers of the specified command. Replace *command* with the command for which you wish to assign privileges. For the full syntax of this command, including additional options, refer to the *PIX Firewall Command Reference*.

For example, the following commands set the privilege of the different command modifiers of the **access-list** command:

```
privilege show level 10 command access-list
privilege configure level 12 command access-list
privilege clear level 11 command access-list
```

The first line sets the privilege of **show access-list** (**show** modifier of **cmd access-list**) to **10**. The second line sets the privilege level of the **configure** modifier to 12, and the last line sets the privilege level of the **clear** modifier to 11.

To set the privilege of all the modifiers of the **access-list** command to a single privilege level of 10, you would enter the following command:

```
privilege level 10 command access-list
```

For commands that are available in multiple modes, use the **mode** parameter to specify the mode in which the privilege level applies.

The following are examples of setting privilege levels for mode-specific commands:

```
privilege show level 15 mode configure command configure
privilege clear level 15 mode configure command configure
privilege configure level 15 mode configure command configure
privilege configure level 15 mode enable command configure
```

```
privilege configure level 0 mode enable command enable
privilege show level 15 mode configure command enable
privilege configure level 15 mode configure command enable
```

```
privilege configure level 15 mode configure command igmp
privilege show level 15 mode configure command igmp
privilege clear level 15 mode configure command igmp
```



```

privilege show level 15 mode configure command logging
privilege clear level 15 mode configure command logging
privilege configure level 15 mode configure command logging
privilege clear level 15 mode enable command logging
privilege configure level 15 mode enable command logging

```

**Note**

Do not use the **mode** parameter for commands that are not mode-specific.

By default, the following commands are assigned to privilege level 0:

```

privilege show level 0 command checksum
privilege show level 0 command curpriv
privilege configure level 0 command help
privilege show level 0 command history
privilege configure level 0 command login
privilege configure level 0 command logout
privilege show level 0 command pager
privilege clear level 0 command pager
privilege configure level 0 command pager
privilege configure level 0 command quit
privilege show level 0 command version

```

Enabling LOCAL Command Authorization

Once you have reassigned privileges to commands from the defaults, as necessary, enable the command authorization feature by entering the following command:

```
aaa authorization command LOCAL
```

By specifying LOCAL, the user's privilege level and the privilege settings that have been assigned to the different commands are used to make authorization decisions.

When users log in to the PIX Firewall, they can enter any command assigned to their privilege level or to lower privilege levels. For example, a user account with a privilege level of 15 can access every command because this is the highest privilege level. A user account with a privilege level of 0 can only access the commands assigned to level 0.

Viewing LOCAL Command Authorization Settings

To view the CLI command assignments for each privilege level, enter the following command:

```
show privilege all
```

The system displays the current assignment of each CLI command to a privilege level. The following example illustrates the first part of the display:

```

pix(config)# show privilege all
privilege show level 15 command aaa
privilege clear level 15 command aaa
privilege configure level 15 command aaa
privilege show level 15 command aaa-server
privilege clear level 15 command aaa-server
privilege configure level 15 command aaa-server
privilege show level 15 command access-group
privilege clear level 15 command access-group
privilege configure level 15 command access-group
privilege show level 15 command access-list

```

```

privilege clear level 15 command access-list
privilege configure level 15 command access-list
privilege show level 15 command activation-key
privilege configure level 15 command activation-key

```

To view the command assignments for a specific privilege level, enter the following command:

```
show privilege level level
```

Replace *level* with the privilege level for which you want to display the command assignments.

For example, the following command displays the command assignments for privilege Level 15:

```
show privilege level 15
```

To view the privilege level assignment of a specific command, enter the following command:

```
show privilege command command
```

Replace *command* with the command for which you want to display the assigned privilege level.

For example, the following command displays the command assignment for the **access-list** command:

```
show privilege command access-list
```

TACACS+ Command Authorization



Caution

Only enable this feature with TACACS+ if you are absolutely sure that you have fulfilled the following requirements.

1. You have created entries for **enable_1**, **enable_15**, and any other levels to which you have assigned commands.
2. If you are enabling authentication with usernames:
 - You have a user profile on the TACACS+ server with all the commands that the user is permitted to execute.
 - You have tested authentication with the TACACS+ server.
3. You are logged in as a user with the necessary privileges. You can see this by entering the **show curpriv** command.
4. Your TACACS+ system is completely stable and reliable. The necessary level of reliability typically requires that you have a fully redundant TACACS+ server system and fully redundant connectivity to the PIX Firewall.



Caution

When configuring the Command Authorization feature, *do not* save your configuration until you are sure it works the way you want. If you get locked out because of a mistake, you can usually recover access by simply restarting the PIX Firewall from the configuration that is saved in Flash memory. If you still get locked out, refer to the section “[Recovering from Lockout](#).”

After command authorization with a TACACS+ server is enabled, for each command entered, the PIX Firewall sends the username, command, and command arguments to the TACACS+ server for authorization.

To enable command authorization with a TACACS+ server, enter the following command:

```
aaa authorization command tacacs_server_tag
```

To create the *tacacs_server_tag*, use the **aaa-server** command, as follows:

```
aaa-server tacacs_server_tag [(if_name)] host ip_address [key] [timeout seconds]
```

Use the *tacacs_server_tag* parameter to identify the TACACS+ server and use the *if_name* parameter if you need to specifically identify the PIX Firewall interface connected to the TACACS+ server. Replace *ip_address* with the IP address of the TACACS+ server. Replace the optional *key* parameter with a keyword of up to 127 characters (including special characters but excluding spaces) to use for encrypting data exchanged with the TACACS+ server. This value must match the keyword used on the TACACS+ server. Replace *seconds* with a number up to 30 that determines how long the PIX Firewall waits before retrying the connection to the TACACS+ server. The default value is 5 seconds.

The PIX Firewall only expands the command and the command modifier (**show**, **clear**, **no**) when it sends these to the TACACS+ server. The command arguments are *not* expanded.

For effective operation, it is a good idea to permit the following basic commands on the AAA server:

- **show curpriv**
- **show version**
- **show aaa**
- **enable**
- **disable**
- **quit**
- **exit**
- **login**
- **logout**
- **help**

For Cisco PIX Device Manager (PDM) to work with Command Authorization using a TACACS+ Server, the AAA server administrator should authorize the user for the following commands:

- **write terminal** or **show running-config**
- **show pdm**
- **show version**
- **show curpriv**

Recovering from Lockout

If you get locked out because of a mistake in configuring Command Authorization, you can usually recover access by simply restarting the PIX Firewall from the configuration that is saved in Flash memory.

If you have already saved your configuration and you find that you configured authentication using the LOCAL database but did not configure any usernames, you have created a lockout problem. You can also encounter a lockout problem by configuring command authorization using a TACACS+ server if the TACACS+ server is unavailable, down or misconfigured.

If you cannot recover access to the PIX Firewall by restarting your PIX Firewall, use your web browser to access the following website:

<http://www.cisco.com/warp/customer/110/34.shtml>

This website provides a downloadable file with instructions for using it to remove the lines in the PIX Firewall configuration that enable authentication and cause the lockout problem.

You can encounter a different type of lockout problem if you use the **aaa authorization command** `tacacs_server_tag` command and you are not logged as the correct user. For every command you type, the PIX Firewall will display the following message:

```
Command Authorization failed
```

This occurs because the TACACS+ server does not have a user profile for the user account that you used for logging in. To prevent this problem, make sure that the TACACS+ server has all the users configured with the commands that they can execute. Also make sure that you are logged in as a user with the required profile on the TACACS+ server.

Configuring PIX Firewall Banners

PIX Firewall Version 6.3 introduces support for “Message-of-the-Day” (MOTD), EXEC, and login banners, similar to the same feature in Cisco IOS software. The size of banners is only limited by available system memory or Flash memory.

To configure a banner, enter the following command:

```
banner {exec|login|motd} text
```

Replace *text* with the string that you want the system to display. Spaces are allowed but tabs cannot be entered using the CLI. You can dynamically add the host name or domain name of the PIX Firewall by including the strings `$(hostname)` and `$(domain)` in the string.

Use the **exec** option to display a banner before the enable prompt is displayed. Use the **login** option to display the banner before the password login prompt when accessing the PIX Firewall using Telnet. Use the **motd** option to display a message-of-the-day banner.

To configure a banner including multiple lines, enter the **banner** command once for each line in the banner.

To display the current banner, enter the following command:

```
show banner {exec|login|motd}
```

To remove a specific banner, enter the following command:

```
no banner {exec|login|motd}
```

To clear all banners, enter the following command:

```
clear banner
```

Using Network Time Protocol

This section describes how to use the NTP client, introduced with PIX Firewall Version 6.2. It includes the following topics:

- [Overview, page 9-11](#)
- [Enabling NTP, page 9-11](#)
- [Viewing NTP Status and Configuration, page 9-12](#)

Overview

The Network Time Protocol (NTP) is used to implement a hierarchical system of servers that provide a source for precisely synchronized time among network systems. This kind of accuracy is required for time-sensitive operations such as validating a certificate revocation lists (CRL), which includes a precise time stamp.

PIX Firewall Version 6.2 and higher provides an NTP client that allows the PIX Firewall to obtain its system time from NTP version 3 servers, like those provided with Cisco IOS routers.

Enabling NTP

To enable the PIX Firewall NTP client, enter the following command:

```
[no] ntp server ip_address [key number] source if_name [prefer]
```

This command causes the PIX Firewall to synchronize with the time server identified by *ip_address*. The **key** option requires a authentication key when sending packets to this server. When using this option, replace *number* with the authentication key. The interface specified by *if_name* is used to send packets to the time server. If the **source** keyword is not specified, the routing table will be used to determine the interface. The **prefer** option makes the specified server the preferred server to provide synchronization, which reduces switching back and forth between servers.

To enable authentication for NTP messages, enter the following command:

```
[no] ntp authenticate  
[no] ntp authentication-key number md5 value  
[no] ntp trusted-key number
```

The **ntp authenticate** command enables NTP authentication. If you enter this command, the PIX Firewall will not synchronize to an NTP server unless the server is configured with one of the authentication keys specified using the **ntp trusted-key** command.

The **ntp authentication-key** command is used to define authentication keys for use with other NTP commands to provide a higher degree of security. The *number* parameter is the key number (1 to 4294967295). The *value* parameter is the key value (an arbitrary string of up to 32 characters). The key value will be replaced with '*****' when the configuration is viewed with either the **write terminal**, **show configuration**, or **show tech-support** commands.

Use the **ntp trusted-key** command to define one or more key numbers corresponding to the keys defined with the **ntp authentication-key** command. The PIX Firewall will require the NTP server to provide this key number in its NTP packets. This provides protection against synchronizing the PIX Firewall system clock with an NTP server that is not trusted.

To remove NTP configuration, enter the following command:

```
clear ntp
```

This command removes the NTP configuration, disables authentication, and removes all the authentication keys.

Viewing NTP Status and Configuration

This section describes the information available about NTP status and associations. To view information about NTP status and configuration, use any of the following commands:

- **show ntp associations**—displays information about the configured time servers.
- **show ntp associations detail**—provides detailed information.
- **show ntp status**—displays information about the NTP clock.

The following examples show sample output for each command and the following tables define the meaning of the values in each column of the output.

[Example 9-1](#) shows sample output from the **show ntp associations** command.

Example 9-1 Sample Output from show ntp association Command

```
PIX> show ntp associations
  address      ref clock    st when poll reach delay offset disp
~172.31.32.2  172.31.32.1  5  29 1024 377  4.2  -8.59  1.6
+~192.168.13.33 192.168.1.111 3  69 128 377  4.1  3.48  2.3
*~192.168.13.57 192.168.1.111 3  32 128 377  7.9 11.18 3.6
* master (synced), # master (unsynced), + selected, - candidate, ~ configured
```

The first characters in a display line can be one or more of the following characters:

- * —Synchronized to this peer
- # —Almost synchronized to this peer
- + —Peer selected for possible synchronization
- - —Peer is a candidate for selection
- ~ —Peer is statically configured

[Table 9-1](#) describes the meaning of the values in each column:

Table 9-1 Output Description from ntp association Command

Output Column Heading	Description
address	Address of peer.
ref clock	Address of reference clock of peer.
st	Stratum of peer.
when	Time since last NTP packet was received from peer.
poll	Polling interval (in seconds).
reach	Peer reachability (bit string, in octal).
delay	Round-trip delay to peer (in milliseconds).
offset	Relative time of peer clock to local clock (in milliseconds).
disp	Dispersion.

Example 9-2 provides sample output from the `show ntp association detail` command:

Example 9-2 Sample Output from ntp association detail Command

```

pix(config)# show ntp associations detail
172.23.56.249 configured, our_master, sane, valid, stratum 4
ref ID 172.23.56.225, time c0212639.2ecfc9e0 (20:19:05.182 UTC Fri Feb 22
2002)
our mode client, peer mode server, our poll intvl 128, peer poll intvl 128
root delay 38.04 msec, root disp 9.55, reach 177, sync dist 156.021
delay 4.47 msec, offset -0.2403 msec, dispersion 125.21
precision 2**19, version 3
org time c02128a9.731f127b (20:29:29.449 UTC Fri Feb 22 2002)
rcv time c02128a9.73c1954b (20:29:29.452 UTC Fri Feb 22 2002)
xmt time c02128a9.6b3f729e (20:29:29.418 UTC Fri Feb 22 2002)
filtdelay =      4.47      4.58      4.97      5.63      4.79      5.52      5.87
0.00
filtoffset =    -0.24     -0.36     -0.37      0.30     -0.17      0.57     -0.74
0.00
filtererror =      0.02      0.99      1.71      2.69      3.66      4.64      5.62
16000.0

```

Table 9-2 describes the meaning of the values in each column:

Table 9-2 Output Description from ntp association detail Command

Output Column Heading	Description
configured	Peer was statically configured.
dynamic	Peer was dynamically discovered.
our_master	Local machine is synchronized to this peer.
selected	Peer is selected for possible synchronization.
candidate	Peer is a candidate for selection.
sane	Peer passes basic sanity checks.
insane	Peer fails basic sanity checks.
valid	Peer time is believed to be valid.
invalid	Peer time is believed to be invalid.
leap_add	Peer is signalling that a leap second will be added.
leap-sub	Peer is signalling that a leap second will be subtracted.
unsynced	Peer is not synchronized to any other machine.
ref ID	Address of machine peer is synchronized to.
time	Last time stamp peer received from its master.
our mode	Our mode relative to peer (active/passive/client/server/bdcast/bdcast client).
peer mode	Peer's mode relative to us.
our poll intvl	Our poll interval to peer.

Table 9-2 Output Description from *ntp association detail* Command (continued)

Output Column Heading	Description
peer poll intvl	Peer's poll interval to us.
root delay	Delay along path to root (ultimate stratum 1 time source).
root disp	Dispersion of path to root.
reach	Peer reachability (bit string in octal).
sync dist	Peer synchronization distance.
delay	Round-trip delay to peer.
offset	Offset of peer clock relative to our clock.
dispersion	Dispersion of peer clock.
precision	Precision of peer clock in hertz.
version	NTP version number that peer is using.
org time	Originate time stamp.
rcv time	Receive time stamp.
xmt time	Transmit time stamp.
filtdelay	Round-trip delay (in milliseconds) of each sample.
filtoffset	Clock offset (in milliseconds) of each sample.
filtererror	Approximate error of each sample.

Example 9-3 provides sample output for the **show ntp status** command:

Example 9-3 Output of the *show ntp status* Command

```

pixfirewall(config)# show ntp status
Clock is synchronized, stratum 5, reference is 172.23.56.249
nominal freq is 99.9984 Hz, actual freq is 100.0266 Hz, precision is 2**6
reference time is c02128a9.73c1954b (20:29:29.452 UTC Fri Feb 22 2002)
clock offset is -0.2403 msec, root delay is 42.51 msec
root dispersion is 135.01 msec, peer dispersion is 125.21 msec

```

Table 9-3 describes the meaning of the values in each column:

Table 9-3 Output Description from *ntp status* Command

Output Column Heading	Description
synchronized	System is synchronized to an NTP peer.
unsynchronized	System is not synchronized to any NTP peer.
stratum	NTP stratum of this system.
reference	Address of peer to which the system is synchronized.
nominal freq	Nominal frequency of system hardware clock.
actual freq	Measured frequency of system hardware clock.
precision	Precision of the clock of this system (in hertz).
reference time	Reference time stamp.

Table 9-3 Output Description from *ntp status* Command (continued)

Output Column Heading	Description
clock offset	Offset of the system clock to synchronized peer.
root delay	Total delay along path to root clock.
root dispersion	Dispersion of root path.
peer dispersion	Dispersion of synchronized peer.

Managing the PIX Firewall Clock

This section describes how to manage the PIX Firewall system clock and includes the following topics:

- [Viewing System Time, page 9-15](#)
- [Setting the System Clock, page 9-15](#)
- [Setting Daylight Savings Time and Timezones, page 9-15](#)

Viewing System Time

To view the current system time, enter the following command:

```
show clock [detail]
```

This command displays the system time. The **detail** option displays the clock source and the current summer-time setting. PIX Firewall Version 6.2 and higher provides milliseconds, timezone, and day.

For example:

```
16:52:47.823 PST Wed Feb 21 2001
```

Setting the System Clock

To set the system time, enter the following command:

```
clock set hh:mm:ss month day year
```

Replace *hh:mm:ss* with the current hours (1-24), minutes, and seconds. Replace *month* with the first three characters of the current month. Replace *day* with the numeric date within the month (1-31), and replace *year* with the four-digit year (permitted range is 1993 to 2035).

Setting Daylight Savings Time and Timezones

PIX Firewall Version 6.2 and higher also provides enhancements to the **clock** command to support daylight savings (summer) time and time zones.

To configure daylight savings (summer) time, enter the following command:

```
clock summer-time zone recurring [week weekday month hh:mm week weekday month hh:mm [offset]]
```

The **summer-time** keyword automatically switches to summer time (for display purposes only).

The **recurring** keyword indicates that summer time should start and end on the days specified by the values that follow this keyword. If no values are specified, the summer time rules default to United States rules. The *week* option is the week of the month (1 to 5 or **last**). The *weekday* option is the day of the week (Sunday, Monday,...). The *month* parameter is the full name of the month (January, February,...). The *hh:mm* parameter is the time (24-hour military format) in hours and minutes. The *offset* option is the number of minutes to add during summer time (default is 60).

Use either of the following commands when the **recurring** keyword cannot be used:

```
clock summer-time zone date date month year hh:mm date month year hh:mm [offset]
clock summer-time zone date month date year hh:mm month date year hh:mm [offset]
```

The **date** keyword causes summer time to start on the first date listed in the command and to end on the second specific date in the command. Two forms of the command are included to enter dates either in the form *month date* (for example, January 31) or *date month* (for example, 31 January).

In both forms of the command, the first part of the command specifies when summer time begins, and the second part specifies when it ends. All times are relative to the local time zone.

If the starting month is after the ending month, the Southern Hemisphere is assumed.

The *zone* parameter is the name of the time zone (for example, PDT) to be displayed when summer time is in effect. The *week* option is the week of the month (1 to 5 or **last**). The *weekday* option is the day of the week (Sunday, Monday,...). The *date* parameter is the date of the month (1 to 31). The *month* parameter is the full name of the month (January, February,...). The *year* parameter is the four-digit year (1993 to 2035). The *hh:mm* parameter is the time (24-hour military format) in hours and minutes. The *offset* option is the number of minutes to add during summer time (default is 60).

To set the time zone for display purposes only, enter the following command:

```
clock timezone zone hours [minutes]
```

The **clock timezone** command sets the time zone for display purposes (internally, the time is kept in UTC). The **no** form of the command is used to set the time zone to Coordinated Universal Time (UTC). The *zone* parameter is the name of the time zone to be displayed when standard time is in effect. The *hours* parameter is the hours offset from UTC. The *minutes* option is the minutes offset from UTC.

The **clear clock** command will remove the summer time setting and set the time zone to UTC.

Using Telnet for Remote System Management



Note

SSH provides another option for remote management of the PIX Firewall when using a less secure interface. For further information, refer to “[Using SSH for Remote System Management](#).”

The serial console lets a single user configure the PIX Firewall, but often this is not convenient for a site with more than one administrator. PIX Firewall lets you access the console via Telnet from hosts on any internal interface. With IPSec configured, you can use Telnet to remotely administer the console of a PIX Firewall from lower security interfaces.

This section includes the following topics:

- [Configuring Telnet Console Access to the Inside Interface, page 9-17](#)
- [Allowing a Telnet Connection to the Outside Interface, page 9-18](#)
- [Using Telnet, page 9-20](#)
- [Trace Channel Feature, page 9-21](#)

Configuring Telnet Console Access to the Inside Interface



Note See the **telnet** command page within the *Cisco PIX Firewall Command Reference* for more information about this command.

Follow these steps to configure Telnet console access:

- Step 1** Enter the PIX Firewall **telnet** command.
- For example, to let a host on the internal interface with an address of 192.168.1.2 access the PIX Firewall, enter the following:
- ```
telnet 192.168.1.2 255.255.255.255 inside
```
- To Telnet to a lower security interface, refer to “[Allowing a Telnet Connection to the Outside Interface](#).”
- Step 2** If required, set the duration for how long a Telnet session can be idle before PIX Firewall disconnects the session.
- The default duration, 5 minutes, is too short in most cases and should be increased until all pre-production testing and troubleshooting has been completed. Set a longer idle time duration as shown in the following example.
- ```
telnet timeout 15
```
- Step 3** To protect access to the console with an authentication server, use the **aaa authentication telnet console** command.
- This requires that you have a username and password on the authentication server. When you access the console, PIX Firewall prompts you for these login credentials. If the authentication server is off line, you can still access the console by using the username **pix** and the password set with the **enable password** command.
- Step 4** Save the commands in the configuration using the **write memory** command.

[Example 9-4](#) shows commands for using Telnet to permit host access to the PIX Firewall console.

Example 9-4 Using Telnet

```
telnet 10.1.1.11 255.255.255.255
telnet 192.168.3.0 255.255.255.0
```

The first **telnet** command permits a single host, 10.1.1.11 to access the PIX Firewall console with Telnet. The 255 value in the last octet of the netmask means that only the specified host can access the console.

The second **telnet** command permits PIX Firewall console access from all hosts on the 192.168.3.0 network. The 0 value in the last octet of the netmask permits all hosts in that network access.



Note A maximum of five (5) active Telnet sessions are simultaneously allowed to the PIX Firewall console.

Allowing a Telnet Connection to the Outside Interface

This section tells you how to configure a Telnet connection to a lower security interface of the PIX Firewall. It includes the following topics:

- [Overview, page 9-18](#)
- [Using Telnet with an Easy VPN Remote Device, page 9-18](#)
- [Using Cisco Secure VPN Client Version 1.1, page 9-19](#)

Overview

This section also applies when using the Cisco Secure Policy Manager Version 2.0 or higher. It is assumed you are using the Cisco VPN Client version 3.x, Cisco Secure VPN Client version 1.1, or the Cisco VPN 3000 Client version 2.5, to initiate the Telnet connection.



Note

Use the **auth-prompt** command for changing the login prompt for Telnet sessions *through* the PIX Firewall. It does not change the login prompt for Telnet sessions to the PIX Firewall.

Once you have configured Telnet access, refer to “[Using Telnet](#)” for more information about using this command.



Note

You must have two security policies set up on your VPN client. One security policy is used to secure your Telnet connection and another is used to secure your connection to the inside network.

Using Telnet with an Easy VPN Remote Device

The following are the different types of Easy VPN Remote devices you can use with a PIX Firewall used as an Easy VPN Remote Server:

- Software clients—Connect directly to the Easy VPN Server but require prior installation and configuration of client software on each host computer. These include the following:
 - Cisco VPN Client Version 3.x (also known as Unity Client 3.x)
 - Cisco VPN 3000 Client Version 2.5 (also known as the Altiga VPN Client Version 2.5)
- Hardware clients—Allow multiple hosts on a remote network to access a network protected by an Easy VPN Server without any special configuration or software installation on the remote hosts. These include the following:
 - PIX 501 or PIX 506/506E
 - Cisco VPN 3002 Hardware Client
 - Cisco IOS-based Easy VPN Remote devices (for example, Cisco 800 series and 1700 series routers)

For more information about configuring a PIX Firewall as an Easy VPN Server or for configuring Easy VPN Remote devices to connect to the PIX Firewall, refer to [Chapter 8, “Managing VPN Remote Access.”](#)

To open a VPN tunnel for running a Telnet session to a PIX Firewall from an Easy VPN Remote device, follow these steps:

-
- Step 1** Set up IPsec by entering the following commands:
- ```
isakmp policy 10 authentication pre-share
isakmp policy 10 group 2
isakmp enable outside
crypto ipsec transform-set esp-des-md5 esp-des esp-md5-hmac
crypto dynamic-map dynmap 10 set transform-set esp-des-md5
crypto map mymap 10 ipsec-isakmp dynamic dynmap
crypto map mymap interface outside
```
- Step 2** Set up an IP pool for the Telnet session by entering the following commands:
- ```
ip local pool tnpool 1.1.1.1-1.1.1.1
```
- Step 3** Set up Telnet access by entering the following command:
- ```
telnet 1.1.1.1 255.255.255.255 outside
```
- Step 4** Set up the VPN group for the remote Telnet user by entering the following commands:
- ```
vpngroup telnet address-pool tnpool
vpngroup telnet password 12345678
```
- Step 5** Setup the VPN client authentication by entering the following commands:
- ```
group telnet
password 12345678
```
- 

## Using Cisco Secure VPN Client Version 1.1

This section applies if you are using a Cisco Secure VPN Client Version 1.1. In the example, the IP address of the PIX Firewall's outside interface is 168.20.1.5, and the Cisco Secure VPN Client's IP address, derived from the virtual pool of addresses, is 10.1.2.0.

To encrypt your Telnet connection to a PIX Firewall lower interface, perform the following steps as part of your PIX Firewall configuration:

- 
- Step 1** Create an **access-list** command statement to define the traffic to protect from the PIX Firewall to the VPN client using a destination address from the virtual local pool of addresses:
- ```
access-list 80 permit ip host 168.20.1.5 10.1.2.0 255.255.255.0
```
- Step 2** Specify which host can access the PIX Firewall console with Telnet:
- ```
telnet 10.1.2.0 255.255.255.0 outside
```
- Specify the VPN client's address from the local pool and the outside interface.
- Step 3** Within the VPN client, create a security policy that specifies the Remote Party Identity IP address and gateway IP address as the same IP address—the IP address of the PIX Firewall's outside interface. In this example, the IP address of the PIX Firewall's outside is 168.20.1.5.
- Step 4** Configure the rest of the security policy on the VPN client to match the PIX Firewall's security policy.
-

**Note**

To complete the configuration of the VPN client, refer to the **vpngroup** command in the *Cisco PIX Firewall Command Reference*.

## Using Telnet

Perform the following steps to test Telnet access:

- 
- Step 1** From the host, start a Telnet session to a PIX Firewall interface IP address.
- If you are using Windows 95 or Windows NT, click **Start>Run** to start a Telnet session. For example, if the inside interface IP address is 192.168.1.1, enter the following command.
- ```
telnet 192.168.1.1
```
- Step 2** The PIX Firewall prompts you with a password:
- ```
PIX passwd:
```
- Enter **cisco** and press the **Enter** key. You are then logged into the PIX Firewall.
- The default password is **cisco**, which you can change with the **passwd** command.
- You can enter any command on the Telnet console that you can set from the serial console, but if you reboot the PIX Firewall, you must log back into the PIX Firewall after it restarts.
- Some Telnet applications such as the Windows 95 or Windows NT Telnet sessions may not support access to the PIX Firewall's command history feature used with the arrow keys. However, you can access the last entered commands by pressing Ctrl-P.
- Step 3** Once you have Telnet access available, you may want to view ping information while debugging.
- You can view ping information from Telnet sessions with the **debug icmp trace** command. The Trace Channel feature also affects **debug** displays, which is explained in "[Trace Channel Feature](#)."
- Messages from a successful ping appear as follows:
- ```
Outbound ICMP echo request (len 32 id 1 seq 512) 209.165.201.2 > 209.165.201.1
Inbound ICMP echo reply (len 32 id 1 seq 256) 209.165.201.1 > 209.165.201.23
```
- Step 4** In addition, you can use the Telnet console session to view syslog messages:
- a. Display start messages with the **logging monitor 7** command. The "7" will cause all syslog message levels to display.

If you are using the PIX Firewall in production mode, you may wish to use the **logging buffered 7** command to store messages in a buffer that you can view with the **show logging** command, and clear the buffer for easier viewing with the **clear logging** command. To stop buffering messages, use the **no logging buffered** command.

You can also lower the number from **7** to a lesser value, such as **3**, to limit the number of messages that appear.
 - b. If you entered the **logging monitor** command, then enter the **terminal monitor** command to cause the messages to display in your Telnet session. To disable message displays, use the **terminal no monitor** command.
-

Trace Channel Feature

The **debug packet** command sends its output to the Trace Channel. All other **debug** commands do not. Use of Trace Channel changes the way you can view output on your screen during a PIX Firewall console or Telnet session.

If a **debug** command does not use Trace Channel, each session operates independently, which means any commands started in the session only appear in the session. By default, a session not using Trace Channel has output disabled by default.

The location of the Trace Channel depends on whether you have a simultaneous Telnet console session running at the same time as the console session, or if you are using only the PIX Firewall serial console:

- If you are only using the PIX Firewall serial console, all **debug** commands display on the serial console.
- If you have both a serial console session and a Telnet console session accessing the console, then no matter where you enter the **debug** commands, the output displays on the Telnet console session.
- If you have two or more Telnet console sessions, the first session is the Trace Channel. If that session closes, the serial console session becomes the Trace Channel. The next Telnet console session that accesses the console then becomes the Trace Channel.

The **debug** commands are shared between all Telnet and serial console sessions.



Note

The downside of the Trace Channel feature is that if one administrator is using the serial console and another administrator starts a Telnet console session, the output from the **debug** commands on the serial console will suddenly stop without warning. In addition, the administrator on the Telnet console session will suddenly be viewing **debug** command output, which may be unexpected. If you are using the serial console and **debug** command output is not appearing, use the **who** command to see if a Telnet console session is running.

Using SSH for Remote System Management

This section describes how to use Secure Shell (SSH) for remote access to the PIX Firewall console. It includes the following topics:

- [Overview, page 9-22](#)
- [Obtaining an SSH Client, page 9-22](#)
- [Identifying the Host Using an SSH Client, page 9-23](#)
- [Configuring Authentication for an SSH Client, page 9-24](#)
- [Connecting to the PIX Firewall with an SSH Client, page 9-24](#)
- [Viewing SSH Status, page 9-24](#)

Overview

SSH is an application running on top of a reliable transport layer, such as TCP/IP that provides strong authentication and encryption capabilities. The PIX Firewall supports the SSH remote shell functionality provided in SSH Version 1. SSH Version 1 also works with Cisco IOS software devices. Up to five SSH clients are allowed simultaneous access to the PIX Firewall console.

Note

Before trying to use SSH, generate an RSA key-pair for the PIX Firewall. To use SSH, your PIX Firewall requires a DES or 3DES activation key.

Another method of remotely configuring a PIX Firewall involves using a Telnet connection to the firewall to start a shell session and then entering configuration mode. This connection method can only provide as much security as Telnet provides, which is only provided as lower-layer encryption (for example, IPSec) and application security (username/password authentication at the remote host).

Note

The PIX Firewall SSH implementation provides a secure remote shell session without IPSec, and only functions as a server, which means that the PIX Firewall cannot initiate SSH connections.

Obtaining an SSH Client

Note

SSH v1.x and v2 are entirely different protocols and are not compatible. Make sure that you download a client that supports SSH v1.x.

You can download an SSH v1.x client from a number of different websites, including the following:

- Windows 3.1, Windows CE, Windows 95, and Windows NT 4.0—download the free Tera Term Pro SSH v1.x client from the following website:

<http://hp.vector.co.jp/authors/VA002416/teraterm.html>

The TTSSH security enhancement for Tera Term Pro is available at the following website:

<http://www.zip.com.au/~roca/ttssh.html>

Note

To use Tera Term Pro with SSH, download TTSSH. TTSSH provides a Zip file that you copy to your system. Extract the zipped files into the same folder that you installed Tera Term Pro.

- Linux, Solaris, OpenBSD, AIX, IRIX, HP/UX, FreeBSD, and NetBSD—download the SSH v1.x client from the following website:

<http://www.openssh.com>

- Macintosh—(except for Macintosh OSX, which includes an SSH client) download the Nifty Telnet 1.1 SSH client at the following website:

<http://www.lysator.liu.se/~jonasw/freeware/niftyssh/>

Identifying the Host Using an SSH Client

Identify each host authorized to access the PIX Firewall console using SSH by entering the following command:

```
[no] ssh ip_address [netmask] [interface_name]
```

To use this command:

- Replace *ip_address* with the IP address of the host or network authorized to initiate an SSH connection to the PIX Firewall.
- Replace *netmask* with the network mask for *ip_address*.



Note The **netmask** parameter is optional if you omit the interface name and if you use the default subnet mask (255.255.255.255). The **netmask** parameter is required if you specify the interface name or if you do not use the default subnet mask.

- Replace *interface_name* with the PIX Firewall interface name on which the host or network initiating the SSH connection resides.

To specify the duration, in minutes, that a session can be idle before being disconnected, enter the following command:

```
ssh timeout number
```

Replace *number* with a value from 1 to 60 (minutes). The default duration is 5 minutes.

To disconnect a specific session, enter the following command:

```
ssh disconnect session_id
```

Replace *session_id* with the identifier for the specific session that you want to disconnect. To display the identifiers for the active sessions, use the **show ssh sessions** command.

To remove all **ssh** command statements from the configuration, enter the following command:

```
clear ssh
```

Use the **no** keyword to remove selected **ssh** command statements from the configuration.

**Note**

To use SSH, your PIX Firewall must have a DES or 3DES activation key and you must generate an RSA key-pair for the PIX Firewall before clients can connect to the PIX Firewall console. Use the **ca generate rsa key 512** command to generate a key; change the modulus size from 512, as needed. After generating the RSA key, save the key using the **ca save all** command.

Configuring Authentication for an SSH Client

To configure local authentication for an SSH client accessing the PIX Firewall, enter the following command:

```
ssh -c 3des -l pix -v ipaddress
```

The password used to perform local authentication is the same as the one used for Telnet access. The default for this password is **cisco**. To change this password, enter the following command:

```
passwd string
```

SSH permits up to 100 characters for a username and up to 50 characters for the password.

To enable authentication using a AAA server, enter the following command:

```
aaa authenticate ssh console server_tag
```

Replace *server_tag* with the identifier for the AAA server.



Note

The firewall might ignore requests from SSH clients for certain advanced features, including X11 forwarding, Authentication Agent forwarding, port forwarding, and compression.

Connecting to the PIX Firewall with an SSH Client

To gain access to the PIX Firewall console using SSH, at the SSH client, enter the username **pix** and enter the Telnet password.

When starting an SSH session, a dot (.) displays on the PIX Firewall console before the SSH user authentication prompt appears, as follows:

```
pixfirewall(config)# .
```

The display of the dot does not affect the functionality of SSH. The dot appears at the console when generating a server key or decrypting a message using private keys during SSH key exchange before user authentication occurs. These tasks can take up to two minutes or longer. The dot is a progress indicator that verifies that the PIX Firewall is busy.

Viewing SSH Status

To view the status of SSH sessions, enter the following command:

```
show ssh [sessions [ip_address]]
```

The **show ssh sessions** command provides the following display:

Session ID	Client IP	Version	Encryption	State	Username
0	172.16.25.15	1.5	3DES	4	-
1	172.16.38.112	1.5	DES	6	pix
2	172.16.25.11	1.5	3DES	4	-

The Session ID is a unique number that identifies an SSH session. The Client IP is the IP address of the system running an SSH client. The Version lists the protocol version number that the SSH client supports. The Encryption column lists the type of encryption the SSH client is using. The State column

lists the progress the client is making as it interacts with the PIX Firewall. The Username column lists the login username that has been authenticated for the session. The “pix” username appears when non-AAA authentication is used.

Enabling Auto Update Support

Auto Update is a protocol specification introduced with PIX Firewall Version 6.2. This section describes how to enable support for this specification on a PIX Firewall and includes the following topics:

- [Overview, page 9-25](#)
- [Identifying the Auto Update Server, page 9-25](#)
- [Managing Auto Update Support, page 9-26](#)
- [Viewing the Auto Update Configuration, page 9-26](#)

Overview

Auto Update is a protocol specification supported by PIX Firewall Version 6.2 or higher. This specification lets the PIX Firewall download configurations, software images, and perform basic monitoring from an Auto Update Server (AUS) in a centralized location. The PIX Firewall can periodically poll the AUS for updates, and the AUS directs the PIX Firewall to send an immediate polling request at any time. Communication between the AUS and the PIX Firewall requires a communications path and local CLI configuration on each PIX Firewall.

Identifying the Auto Update Server

To specify the URL of the AUS, use the following command:

```
[no] auto-update server url [verify-certificate]
```

Only one server can be configured. Replace *url* with a URL using the following syntax:

```
[http[s]://][user:password@]location[:port]/pathname
```

SSL will be used when **https** is specified. The *user* and *password* segment is used for Basic Authentication when logging in to the server. The user and password are replaced with ‘*****’ when the configuration is viewed with either the **write terminal**, **show configuration** or **show tech-support** commands.

Replace *location* with the address of the server. The *port* segment specifies the port to contact on the server. The default is 80 for HTTP and 443 for HTTPS. The *pathname* segment is the name of the resource.

The **verify-certificate** option specifies that the certificate returned by the server should be verified.

The **no auto-update server** command disables polling for updates by terminating the Auto Update daemon running on the PIX Firewall.

Managing Auto Update Support

To enable the PIX Firewall for polling an AUS, use the following command:

```
[no] auto-update device-id hardware-serial | hostname | ipaddress [if-name] | mac-address
[if-name] | string text
```

The **auto-update device-id** command is used to identify the device ID to send when communicating with the AUS. The identifier used is determined by using one of the following parameters:

- **hardware-serial**—Use the PIX Firewall serial number.
- **hostname** option—Use the PIX Firewall host name.
- **ipaddress** option—Use the IP address of the interface with the name *if-name*. If the interface name is not specified, it will use the IP address of the interface used to communicate with the AUS.
- **mac-address** option—Use the MAC address of the interface with the name *if-name*. If the interface name is not specified, it will use the MAC address of the interface used to communicate with the AUS.
- **string**—Use the specified text identifier, which cannot contain white space or the characters ‘, “, , >, & and ?.

Use the **no auto-update device-id** command to reset the device ID to the default of host name.

To specify how often to poll the AUS for configuration or image updates, enter the following command:

```
[no] auto-update poll-period poll-period [retry-count [retry-period]]
```

The *poll-period* parameter specifies how often (in minutes) to check for an update. The default is 720 minutes (12 hours). The *retry-count* option specifies how many times to try re-connecting to the server if the first attempt fails. The default is 0. The *retry-period* option specifies how long to wait (in minutes) between retries. The default is 5.

Use the **no auto-update poll-period** command to reset the poll period to the default.

If the Auto Update Server has not been contacted for a certain period of time, the following command will cause it to cease sending packets:

```
[no] auto-update timeout period
```

Use this command to ensure that the PIX Firewall has the most recent image and configuration. This condition will be reported with the existing message%PIX-3-201008.

To remove the entire Auto Update configuration, enter the following command:

```
clear auto-update
```

Viewing the Auto Update Configuration

To display the AUS, poll time, timeout period, device ID, poll statistics and update statistics, enter the following command:

```
show auto-update
```

The following is sample output from the **show auto-update** command:

```
pix(config)# show auto-update
Server: https://\*\*\*\*\*@172.23.58.115:1742/management.cgi?1276
Certificate will be verified
Poll period: 720 minutes, retry count: 2, retry period: 5 minutes
```

```
Timeout: none
Device ID: host name [pix-pri]
Next poll in 4.93 minutes
Last poll: 11:36:46 PST Tue Nov 13 2001
Last PDM update: 23:36:46 PST Tue Nov 12 2001
```

Capturing Packets

This section describes the packet capture utility introduced with PIX Firewall Version 6.2. It includes the following topics:

- [Overview, page 9-27](#)
- [Configuration Procedure, page 9-27](#)
- [Packet Capture Output Formats, page 9-29](#)
- [Packet Capture Examples, page 9-30](#)

Overview

Capturing packets is sometimes useful when troubleshooting connectivity problems or monitoring suspicious activity. You can use the PIX Firewall packet capture utility to capture specific types of traffic on any PIX Firewall interface.

The packet capture utility provides the following features:

- Capture of packets to a linear buffer
- Capture of ARP and other Layer 2 packets
- Timestamp of captured packets based from the PIX Firewall clock (in milliseconds)
- Selective packet capture and display based on access lists
- Display of captured buffer on any console or using a web browser
- Brief and expanded view of capture data
- Export of captured packets in libpcap format

Configuration Procedure

To capture and display packets on a PIX Firewall interface, perform the following steps:

-
- Step 1** To define a packet capture and begin capturing packets on a specific interface, enter the following command:

```
capture capture-name [access-list acl_id] [buffer bytes] [ethernet-type type] [interface name] [packet-length bytes]
```

Replace *capture-name* with an alphanumeric identifier that you will use to display or copy the captured packets. The PIX Firewall captures packets on the interface specified by *name* until the packet capture buffer is full.

Replace *acl_id* with the name of any existing access list, which can limit the capture based on one or more of the following selection criteria:

- IP protocol type
- Source or destination addresses
- TCP or UDP port
- ICMP type

For information about configuring an access control list, refer to “Controlling Outbound Connectivity” in Chapter 3, “Controlling Network Access and Use.”

To use the **buffer** option, replace *bytes* with the number of bytes you want to assign to the packet capture buffer, subject to the memory available on the PIX Firewall. The default buffer size is 512 K. You can run multiple packet captures on different interfaces concurrently if the PIX Firewall has sufficient memory.

To use the **ethernet** option, replace *type* with one of the following packet types: ip, arp, rarp, vlan, 802.1Q, ipx, ip6, pppoe, pppoes, or any number in the range from 1 to 65536 (corresponding to the protocol type specified in the Ethernet packet). When using 802.1Q (VLAN), the 802.1Q tag is automatically skipped and the inner ethernet-type is used for matching. If you enter **ethernet-type 0**, all packet types are captured.

To use the **packet-length** option, replace *bytes* with the maximum number of bytes from each packet that you want copied to the capture buffer. By default, the limit is 68 bytes.

Step 2 To view the contents of the packet capture buffer, enter the following command:

```
show capture [capture-name][access-list acl_id][count count][detail] [dump]
```

Replace *capture-name* with the identifier you assigned to the packet capture. Replace *acl_id* with the name of an access control list to restrict the display of the captured packets. Replace *count* with the number of packets to display.

The fields included when you use the **detail** option are listed within square brackets ([]) in Table 9-4.

The **dump** option displays a hexadecimal display of the packet transported over the data link transport. Note that Media Access Control (MAC) information is not shown. A dump is also displayed if no protocol is available.

Use the **show capture** command without any parameters to display the current runtime configuration for packet captures.

Step 3 To view a packet capture using a web browser, enter the following command:

```
https://pix-host/capture/capture-name[/pcap]
```

Replace *pix-host* with the IP address or host name of the PIX Firewall where the packet capture occurred. Replace *capture-name* with the name of the packet capture you want to view.

The **pcap** option causes the packet capture to be downloaded to the web browser in libpcap format. After you save the packet capture from the browser, you can view a libpcap file with tcpdump or other applications.

Step 4 To copy the contents of the packet capture buffer to a TFTP server, enter the following command:

```
copy capture: capture-name tftp://location/path [pcap]
```

Replace *capture-name* with the name of the packet capture you want to view. Replace *location* and *path* with the host name, path name, and file name of the file where you want to store the captured packets. Some TFTP servers may require that the file already exists with write permission assigned to “world.” The **pcap** option causes the file to be created in libpcap format, which can be viewed with **tcpdump** or other applications.

Step 5 To clear the packet capture buffer, enter the following command:

```
clear capture capture-name
```

Step 6 To clear the packet capture definition and release the resources allocated for it, enter the following command:

```
no capture capture-name
```

Replace *capture-name* with the name of the packet capture you want to clear.

Step 7 To stop the packet capture and save the current contents of the packet capture buffer, enter the following command:

```
no capture capture-name [interface name]
```

Replace *capture-name* with the name of the packet capture you want to stop. When you use the **interface** option to identify a specific interface, replace *name* with the name assigned to the interface.

Step 8 To remove the access list from a running packet capture, enter the following command:

```
no capture capture-name access-list acl_id
```

Replace *capture-name* with the name of the packet capture and replace *acl_id* with the name of the access list.

Packet Capture Output Formats

Table 9-4 shows the output formats for packet captures of different protocol types. The decoded output of the packets is dependent on the protocol of the packet. The output in square brackets is displayed when you use the **capture** command with the **detail** option.

Table 9-4 Packet Capture Formats

Capture Type	Syntax
ICMP packet	HH:MM:SS.ms [ether-hdr] ip-source ip-destination: icmp: icmp-type icmp-code [checksum-failure]
UDP packet	HH:MM:SS.ms [ether-hdr] src-addr.src-port dest-addr.dst-port:[checksum-info] udp payload-len
TCP packet	HH:MM:SS.ms [ether-hdr] src-addr.src-port dest-addr.dst-port: tcp-flags [header-check] [checksum-info] sequence-number ack-number tcp-window urgent-info tcp-options

Table 9-4 Packet Capture Formats (continued)

Capture Type	Syntax
Other IP packets	HH:MM:SS.ms [ether-hdr] src-addr dest-addr: ip-protocol ip-length
ARP packets	HH:MM:SS.ms [ether-hdr] arp-type arp-info
Other packets	HH:MM:SS.ms ether-hdr: hex-dump

Packet Capture Examples

This section includes examples of different types of packet captures.

[Example 9-5](#) illustrates an HTTP packet capture.

Example 9-5 Capturing an HTTP Session

In the following example, traffic is captured from an outside client at 209.165.200.225 to an inside HTTP server:

```
access-list http permit tcp host 10.120.56.15 eq http host 209.165.200.225
access-list http permit tcp host 209.165.200.225 host 10.120.56.15 eq http
capture capweb access-list http packet-length 74 interface inside
```

[Example 9-6](#) illustrates how to display a packet capture using a web browser.

Example 9-6 Displaying a libpcap File with a Web Browser

The following command downloads a libpcap file to a local machine, using a web browser such as Internet Explorer or Netscape Communicator:

```
https://209.165.200.226/capture/http/pcap
```

[Example 9-7](#) copies an FTP trace to the file “ftp-dump” on the TFTP server 209.165.200.226.

Example 9-7 Saving to a Remote TFTP Server

```
pixfirewall# copy capture:ftp tftp://209.165.200.226/ftp-dump
Writing to file '/tftpboot/ftp-dump' at 209.165.200.226 on outside
```

[Example 9-8](#) illustrates a packet capture of ARP packets:

Example 9-8 ARP Packet Capture

```
pixfirewall# capture arp ethernet-type arp interface outside
pixfirewall# show capture arp
6 packets captured, 6 packets to be shown
10:46:25.452369 arp who-has 209.165.200.225 (ff:ff:ff:ff:ff:ff) |
tell 209.165.200.235
10:46:26.312850 arp who-has 209.165.201.2 tell 209.165.200.227
10:46:26.392283 arp who-has 209.165.200.225 (ff:ff:ff:ff:ff:ff)
tell 209.165.200.235
```



```

10:46:28.923368 arp who-has 209.165.200.226 (ff:ff:ff:ff:ff:ff)
      tell 209.165.200.235
10:46:29.255998 arp who-has 209.165.202.129
      tell 209.165.202.130 (0:2:b9:45:bf:7b)
10:46:29.256136 arp reply 209.165.202.129 is-at 0:a0:c9:86:8e:9c

```

[Example 9-9](#) illustrates a packet capture of PPPoE discovery packets:

Example 9-9 Capturing PPPoE Discovery

```

pixfirewall# capture pppoe ethernet-type pppoe interface outside
pixfirewall(config)# show capture pppoe
3 packets captured, 3 packets to be shown
02:13:21.844408 ffff.ffff.2ac5 ffff.ffff.ffff 0x8863 32:
      1109 0000 000c 0101 0000 0103 0004 386c
      f280
02:13:25.841738 ffff.ffff.3cc0 ffff.ffff.ffff 0x8863 32:
      1109 0000 000c 0101 0000 0103 0004 386c
      f280
02:13:33.841875 ffff.ffff.76c0 ffff.ffff.ffff 0x8863 32:
      1109 0000 000c 0101 0000 0103 0004 386c
      f280

```

[Example 9-10](#) illustrates a packet capture on multiple interfaces. The example captures an FTP session to an FTP server at host 209.165.202.129.

Example 9-10 Capturing On Multiple Interfaces

```

pixfirewall(config)# access-list ftp tcp any host 209.165.202.129 eq ftp
pixfirewall(config)# access-list ftp tcp host 209.165.202.129 eq ftp any
pixfirewall# capture ftp access-list ftp
pixfirewall# capture ftp interface inside interface outside
pixfirewall# show capture
pixfirewall# capture ftp access-list ftp interface outside interface inside
pixfirewall# show capture ftp
5 packets captured, 5 packets to be shown
11:21:17.705041 10.1.1.15.2158 > 10.1.1.15.2158:
      S 3027585165:3027585165(0) win 512 <mss 1460>
11:21:17.705133 209.165.202.130.2158 > 209.165.202.130.2158:
      S 4192390209:4192390209(0) win 512 <mss 1380>
11:21:17.705651 10.1.1.15.2158 > 10.1.1.15.2158:
      . ack 3463843411 win 32120
11:21:17.705667 209.165.202.130.2158 > 209.165.202.130.2158:
      . ack 3463843411 win 32120
11:21:20.784337 10.1.1.15.2158 > 10.1.1.15.2158:
      . ack 3463843521 win 32120

```

Saving Crash Information to Flash Memory

PIX Firewall Version 6.3 and higher, by default, saves information that is generated during a PIX Firewall system crash to Flash memory. With earlier versions, crash information was only displayed on the console.

To erase the current contents of the crash flash file, enter the following command:

```
clear crashinfo
```

To disable saving crash information to Flash memory, enter the following command:

```
crashinfo save disable
```

To save test crash information to Flash memory, enter the following command:

```
crashinfo test
```

This command can be used for reassurance and testing and does not actually crash the PIX Firewall. This command erases the current contents of the crash file in Flash memory, and saves information to Flash memory that is similar to what is saved during an actual system crash. This command simulates crash information and returns to the command prompt that was present before entering the command.

To view the current contents of the crash flash file, enter the following command:

```
show crashinfo
```

If the crash information stored in Flash memory is a test crash, the first string of the file will be “: Saved_Test_Crash” and the last one will be “: End_Test_Crash.” If the crash information stored in Flash memory is from a real crash, the first string of the file will be “: Saved_Crash” and the last one will be “: End_Crash.”

If you want to actually crash the PIX Firewall, enter the following command:

```
crashinfo force [page-fault|watchdog]
```



Caution

Only use this command with great caution. It actually crashes the PIX Firewall and then reboots it.

The crash is first dumped to Flash memory and then printed to the local console.

Use the **page-fault** option to cause a PIX Firewall crash as a result of a page fault. Use the **watchdog** option to crash the PIX Firewall as a result of the PIX Firewall watch dog feature.

After entering the **crashinfo force** command, the PIX Firewall displays the following warning prompt:

```
WARNING: This command will force the PIX to crash and
reboot. Do you wish to proceed? [confirm]:
```

Type **y** or press Enter to confirm the operation. The PIX Firewall will crash and reboot.

To display whether saving crash information to Flash memory is enabled or disabled, enter the following command:

```
show crashinfo save
```

Using Syslog

This section describes how to control how PIX Firewall works with syslog and includes the following topics:

- [Enabling Logging to Syslog Servers, page 9-33](#)
- [Changing Syslog Message Levels, page 9-33](#)
- [Disabling Syslog Messages, page 9-34](#)
- [Viewing Modified Message Levels, page 9-34](#)
- [Logging Access Control List Activity, page 9-35](#)
- [Managing IDS Syslog Messages, page 9-39](#)

Refer to the *Cisco PIX Firewall System Log Messages* for syslog message numbers and other detailed information.

Enabling Logging to Syslog Servers

This section describes how to enable logging messages to one or more syslog servers. For information about saving messages to a buffer, displaying them on the console, specifying the transport used for syslog messages, or various other options, refer to the **logging** command in the *Cisco PIX Firewall Command Reference*. Use the **logging** command to identify one or more syslog servers and to set the various options available. To enable or disable logging, enter the following commands:

```
logging on
no logging on
```

To view the current logging options, enter the following command:

```
show logging
```

To identify a syslog server that will receive the messages sent from the PIX Firewall, enter the following command:

```
logging host in_if_name ip_address [format {emblem}]
```

Replace *in_if_name* with the interface on which the syslog server resides. Replace *ip_address* with the syslog server's IP address. You can use multiple **logging host** commands to specify additional servers.

PIX Firewall Version 6.3 introduces support for EMBLEM format, which is required when using the CiscoWorks Resource Manager Essentials (RME) syslog analyzer. Use the option **format emblem** to send messages to the specified server in EMBLEM format. This option is available only for UDP syslog messages, used by the RME syslog analyzer.

PIX Firewall Version 6.2(3) introduced support for defining a unique device ID for log messages sent to a syslog server. To enable this option, use the following command.

```
logging device-id hostname | ipaddress if_name | string text
```

Use the **hostname** option to use the host name of the PIX Firewall as the device ID. Use the **ipaddress** option to use the IP address of a specific interface as the device ID. Replace *if_name* with the name assigned to the PIX Firewall interface with the **nameif** command. Use the **string** option to enter a text description. Replace *text* with a string of up to 16 characters, without spaces.

When this feature is enabled, the PIX Firewall will insert the specified device ID into all non-EMBLEM format syslog messages. This command does not affect the syslog message text in EMBLEM format or as it is displayed on the PIX Firewall console or log file.

To disable this feature, use the following command:

```
no logging device-id
```

Changing Syslog Message Levels

PIX Firewall Version 6.3 gives you the option to modify the level at which a specific syslog message is issued and to disable specific syslog messages. Previous versions of PIX Firewall only let you specify the message level or disable all messages to a specific syslog server.

To change the logging level for all syslog servers, enter the following command:

```
pix(config)# logging message level levelid
```

To change the level of a specific syslog message, enter the following command:

```
pix(config)# logging message syslogid level levelid
```

Replace *syslogid* with the numeric identifier assigned to the syslog message. Replace *levelid* with one of the following numeric or text identifiers for the syslog level:

- **0—emergencies**—System unusable messages
- **1—alerts**—Take immediate action
- **2—critical**—Critical condition
- **3—errors**—Error message
- **4—warnings**—Warning message
- **5—notifications**—Normal but significant condition
- **6—informational**—Information message
- **7—debugging**—Debug messages and log FTP commands and WWW URLs

For example, if you want to log the message “denied by ACL” (106023), but you do not want to increase the overall logging level, you can change the specific syslog level to Critical, as shown in the following command:

```
pix(config)# logging message 106023 level critical
```

To restore the default syslog level for a specific message, precede the command with **no**. To restore all of the currently changed syslog messages to their default levels, enter the following command:

```
pix(config)# clear logging level
```

By default, the emergencies level is not used for any PIX Firewall syslog messages, so you can use this level to restrict syslog messages to those in which you are interested. To do this, change the level of interesting messages to **emergencies**.

Disabling Syslog Messages

To disable a particular syslog message, enter the following command:

```
no logging message messageid
```

To reenable a specific message, enter the following command:

```
logging message messageid
```

To reenable all disabled messages, enter the following command:

```
clear logging disabled
```

Viewing Modified Message Levels

To view all messages with modified levels, enter the following command:

```
show logging level
```

To view the status of a particular message, enter the following command:

```
show logging message syslogid
```

To view disabled messages, enter the following command:

```
show logging disabled
```

To view all messages with modified levels, and all disabled messages, enter the following command:

```
show logging message
```

Logging Access Control List Activity

This section describes a logging option, introduced with PIX Firewall Version 6.3, that lets you log the number of permits or denies of a flow by an ACL entry during a specific period of time. It includes the following topics:

- [Overview, page 9-35](#)
- [Configuration, page 9-35](#)
- [Logging Behavior, page 9-37](#)
- [Syslog Message Format, page 9-38](#)

Overview

When logging is enabled for specific ACL activity, statistics are provided for each flow. A flow is defined by protocol, source IP address, source port, destination IP address, and destination port. The statistics include the number of permits or denies of the flow by an ACL entry during the specified time interval.

When a flow is permitted or denied, the system checks to see if the flow already exists in the system. If not, an initial syslog message with a hit-count of 1 for the flow is generated. The flow entry is then created and the hit-count for the flow is incremented every time the flow is permitted or denied.

For an existing flow, a syslog message is generated at the end of each configurable interval to report the non-zero hit-count for the flow in the current interval. After the syslog message is generated, the hit-count for the flow is reset to 0 for the next interval. If there is no hit recorded during the interval, the flow is deleted and no syslog message is generated.

There may exist a large number of flows concurrently at any point of time. To prevent unlimited consumption of memory and CPU resources, a limit is placed on the number of concurrent deny-flows. When the limit is reached, no new deny-flow will be created until the existing deny-flows expire.

If the new logging option is not configured on an ACL that is used in an **access-group** command, the older logging scheme (syslog 106023 for denied flows) remains in effect.

Configuration

Logging of specific ACL activity only applies to ACLs configured using the **access-group** command, so only traffic through the PIX Firewall is subject to logging. Also, ACLs used with selectors such as the **aaa authen match** command have no logging effect.



Caution

Exercise caution when enabling this option because a very large number of syslog messages may be generated in a short period of time in the event of a denial of service (DoS) attack.

To enable logging of the number of permits or denials of a flow by an ACL entry during a specific period of time, use the following command:

```
access-list acl_id [log [disable|default] | [level] [interval seconds]]
```

Use the **disable** option to completely disable the log option, including syslog message 106023. Use the **default** option to restore the default ACL logging behavior, which is to generate syslog message 106023 if a packet is denied.

Replace *level* with a numeric identifier that sets the severity level to assign to the ACL log messages. If no level is specified, the default level is 6 (informational).

Replace *seconds* with the time interval in seconds (1 - 600) after which the system generates an ACL logging message. This also serves as the timeout value for deleting an inactive flow. If no interval is specified, the default is 300 seconds.

For example, to apply the logging option to implicitly denied traffic, enter the following command:

```
access-list acl_id deny ip any any [log .... ]
```

If the same command is repeated but with different values for *level* or *interval*, the new values will be in effect for the subsequent new flows. Existing flows will not be affected, however.

To specify the maximum number of concurrent deny-flows that can be created, enter the following command:

```
access-list deny-flow-max num_of_flows
```

The **deny-flow-max** keyword specifies the maximum number of concurrent deny-flows that can be created. New values for this option go into effect immediately.

The default is set for the maximum number of flows allowed, which depends on the amount of memory available on the PIX Firewall, as follows:

- 64 MB or greater—Maximum value/default value is 4096
- 16 MB or greater—Maximum value/default value is 1024
- Less than 16 MB—Maximum value/default value is 256

When the maximum number of flows has been reached, a syslog message (106101) is generated. By default, this message is repeated once every 300 seconds. To change this interval, enter the following command:

```
access-list alert-interval secs
```

Replace *secs* with the number of seconds you want the system to wait before generating another message.

To disable the **log** option without having to remove the access control entry, use the **disable** keyword. For example:

```
access-list aclid deny ip any any log disable
```

When you use the **no access-list** command to remove an ACE with the log option enabled, it is not necessary to specify all the log options. Removing an ACE with the log option enabled does not remove any cached flows associated with the ACE. However, removing the ACL removes all cached flows associated with the ACL.

Use the **show access-list** command to display the total number of cached ACL log flows, the number of cached deny-flows, and the maximum number of allowed deny-flows. The **clear access-list** command removes all the cached flows.

Logging Behavior

There are some behavior differences among various types of IP traffic because access check is only applied to those packets which do not have an existing connection. This section summarizes the logging behavior for different types of traffic. It includes the following topics:

- [TCP Example, page 9-37](#)
- [Deny Example, page 9-38](#)
- [No Log Example, page 9-38](#)

The examples in this section are based on the behavior of a PIX Firewall configured with the following commands:

```
access-group outside-acl in interface outside
... output abridged ...
access-list outside-acl permit ip host 1.1.1.1 any log 7 interval 600
access-list outside-acl permit ip host 2.2.2.2 any
access-list outside-acl deny ip any any log 2
```

TCP Example

1. An inbound TCP SYN packet (1.1.1.1/12345 -> 192.168.1.1/1357) arrives on the outside interface.
2. The packet is permitted by the first ACE of the outside-acl access list that has the log option enabled.

The following syslog message is generated and the log flow is cached.

```
106100: access-list outside-acl permitted tcp outside/1.1.1.1(12345) ->
inside/192.168.1.1(1357) hit-cnt 1 (first hit)
```

At the same time, a connection (1.1.1.1, 12345, 192.168.1.1, 1357) is created, which can be shown by using a **show xlate** or **show conn** command.

3. 20 packets for this connection arrive on the outside interface. However, access checking is bypassed because the connection for these packets already exists. Therefore, the hit count for the cached flow is not incremented.
4. The TCP connection is terminated and deleted at the end of the first minute.
5. Steps 1 to 4 are repeated, but this time the log flow has been cached, so the hit count is incremented from 0 to 1. Each time the TCP connection is terminated, these steps are repeated, so the hit count reaches nine at the end of the tenth minute.
6. At the end of tenth minute after the log flow is cached, the following syslog message is generated, and the hit count for the log flow is reset to 0.

```
106100: access-list outside-acl permitted tcp outside/1.1.1.1(12345)->
inside/192.168.1.1(1357) hit-cnt 9 (300-second interval)
```

7. No matching packets arrive on the outside interface within the next ten minutes, so the hit count for the log flow remains at 0.
8. At the end of twentieth minute, the cached flow (TCP, 1.1.1.1, 12345, 192.168.1.1, 1357) is deleted because the hit count remains at 0.

Deny Example

1. An inbound TCP packet (3.3.3.3/12345 -> 192.168.1.1/1357) arrives on the outside interface.
2. The packet is permitted by the first ACE of the outside-acl access list, which has the log option enabled with log level 2.
3. The log flow (TCP, 3.3.3.3, 12345, 192.168.1.1, 1357) has not be cached, so the following syslog message is generated and the log flow is cached.

```
106100: access-list outside-acl denied tcp outside/3.3.3.3(12345) ->
inside/192.168.1.1(1357) hit-cnt 1 (first hit)
```

4. Twenty matching packets arrive on the outside interface within the next five minutes (300 seconds). Because the log flow has been cached, the hit count is incremented for each packet.
5. At the end of fifth minute, the following syslog message is generated and the hit count for the log flow is reset to 0.

```
106100: access-list outside-acl permitted tcp outside/3.3.3.3(12345)->
inside/192.168.1.1(1357) hit-cnt 20 (300-second interval)
```

6. No matching packets arrive on the outside interface within the next five minutes, so the hit count for the log flow remains at 0.
7. At the end of tenth minute, the cached flow (TCP, 3.3.3.3, 12345, 192.168.1.1, 1357) is deleted because the hit count remains at 0.

No Log Example

Packets arriving on the outside interface from 2.2.2.2 to 192.168.1.1 are permitted by the 2nd ACE of outside-acl but they do not trigger any logging because the log option is not enabled for the ACE.

Syslog Message Format

The following is the new syslog format used by messages generated for an ACL entry:

```
106100: access-list <acl_id> <grant> <prot> <intf/src_ip(src_port)> ->
<intf/dst_ip(dest_port)> hit-cnt <nnn> (first hit|n-second interval)
```

Table 9-5 describes the meaning of each field in this message format.

Table 9-5 Syslog Message Format for ACL Logging

Field	Description
<grant>	Displays if the flow is permitted or denied.
<prot>	Displays the protocol type: tcp, udp, icmp, or an IP protocol number.
<intf>	Displays the interface name (as configured by the nameif command) for the source or destination of the logged flow. This can include logical (VLAN) interfaces.
<src_ip>	Displays the source IP address of the logged flow.
<dst_ip>	Displays the destination IP address of the logged flow.
<src_port>	Displays the source port of the logged flow (tcp or udp). For ICMP, this field is 0.
<dst_port>	Displays the destination port of the logged flow (tcp or udp). For ICMP, this field is icmp-type.

Table 9-5 Syslog Message Format for ACL Logging

Field	Description
<nnn>	Displays the number of times this flow was permitted or denied by the ACL entry in the configured time interval. The value is 1 when the first syslog message is generated for the flow.
first hit	Displays the first message generated for this flow.
n-second interval	Displays the interval over which the hit count is accumulated.

Managing IDS Syslog Messages

PIX Firewall lists single-packet (*atomic*) Cisco Intrusion Detection System (IDS) signature messages via syslog. Refer to *Cisco PIX Firewall System Log Messages* for a list of the supported messages. You can view this document online at the following website:

http://www.cisco.com/univercd/cc/td/doc/product/iaabu/pix/pix_sw/v_63/63syslog/index.htm

All signature messages are not supported by PIX Firewall in this release. IDS syslog messages all start with **PIX-4-4000nn** and have the following format:

```
%PIX-4-4000nn IDS:sig_num sig_msg from ip_addr to ip_addr on interface int_name
```

For example:

```
%PIX-4-400013 IDS:2003 ICMP redirect from 10.4.1.2 to 10.2.1.1 on interface dmz
%PIX-4-400032 IDS:4051 UDP Snork attack from 10.1.1.1 to 192.168.1.1 on interface outside
```



Note

Cisco IDS signature number 1101 is not supported by PIX Firewall. When an unsupported signature number is entered, PIX Firewall returns an error message.

Table 9-6 lists the values and the meaning of each syslog output parameter.

Table 9-6 Syslog Output Values

Syslog Value	Meaning
sig_num	The signature number. Refer to the <i>Cisco Secure Intrusion Detection System Version 2.2.1 User Guide</i> for more information. You can view the “NSDB and Signatures” chapter from this guide at the following website: http://www.cisco.com/univercd/cc/td/doc/product/iaabu/csids/csids1/csidsug/sigs.htm
sig_msg	The signature message—approximately the same as the NetRanger signature message.
ip_addr	The local to remote address to which the signature applies.
int_name	The name of the interface on which the signature originated.

Table 9-7 summarizes the commands that you can use to determine the messages that are displayed.

Table 9-7 Commands to Control Syslog Messages

Command	Effect
<code>ip audit signature signature_number disable</code>	Attaches a global policy to a signature. Used to disable or exclude a signature from auditing.
<code>no ip audit signature signature_number</code>	Removes the policy from a signature. Used to reenable a signature.
<code>show ip audit signature [signature_number]</code>	Displays disabled signatures.
<code>ip audit info [action [alarm] [drop] [reset]]</code>	Specifies the default action to be taken for signatures classified as informational signatures. The alarm option indicates that when a signature match is detected in a packet, PIX Firewall reports the event to all configured syslog servers. The drop option drops the offending packet. The reset option drops the offending packet and closes the connection if it is part of an active connection. The default is alarm . To cancel event reactions, specify the ip audit info command without an action option.
<code>no ip audit info</code>	Sets the action to be taken for signatures classified as informational and reconnaissance to the default action.
<code>show ip audit info</code>	Displays the default informational actions.
<code>ip audit attack [action [alarm] [drop] [reset]]</code>	Specifies the default actions to be taken for attack signatures. The action options are as previously described.
<code>no ip audit attack</code>	Sets the action to be taken for attack signatures to the default action.
<code>show ip audit attack</code>	Displays the default attack actions. An audit policy (audit rule) defines the attributes for all signatures that can be applied to an interface along with a set of actions. Using an audit policy the user may limit the traffic that is audited or specify actions to be taken when the signature matches. Each audit policy is identified by a name and can be defined for informational or attack signatures. Each interface can have two policies; one for informational signatures and one for attack signatures. If a policy is defined without actions, then the configured default actions will take effect. Each policy requires a different name.
<code>ip audit name audit_name info [action [alarm] [drop] [reset]]</code>	All informational signatures except those disabled or excluded by the ip audit signature command are considered part of the policy. The actions are the same as described previously.
<code>no ip audit name audit_name [info]</code>	Remove the audit policy <i>audit_name</i> .

Table 9-7 Commands to Control Syslog Messages (continued)

Command	Effect
<code>ip audit name <i>audit_name</i> attack [action [alarm] [drop] [reset]]</code>	All attack signatures except those disabled or excluded by the <code>ip audit signature</code> command are considered part of the policy. The actions are the same as described previously.
<code>no ip audit name <i>audit_name</i> [attack]</code>	Removes the audit specification <i>audit_name</i> .
<code>show ip audit name [name [info attack]]</code>	Displays all audit policies or specific policies referenced by name and possibly type.
<code>ip audit interface <i>if_name</i> <i>audit_name</i></code>	Applies an audit specification or policy (via the <code>ip audit name</code> command) to an interface.
<code>no ip audit interface [<i>if_name</i>]</code>	Removes a policy from an interface.
<code>show ip audit interface</code>	Displays the interface configuration.

Using SNMP

This section describes how to enable SNMP for monitoring the PIX Firewall with a network management system (NMS). It includes the following topics:

- [Overview, page 9-41](#)
- [MIB Support, page 9-42](#)
- [SNMP CPU Utilization, page 9-42](#)
- [SNMP Usage Notes, page 9-43](#)
- [SNMP Traps, page 9-44](#)
- [Compiling Cisco Syslog MIB Files, page 9-45](#)
- [Using the Firewall and Memory Pool MIBs, page 9-46](#)

Overview

The `snmp-server` command causes the PIX Firewall to send SNMP traps so that the PIX Firewall can be monitored remotely. Use `snmp-server host` command to specify which systems receive the SNMP traps.

The PIX Firewall SNMP MIB-II groups available are System and Interfaces. The Cisco Firewall MIB and Cisco Memory Pool MIB are also available.

All SNMP values are read only (RO).

Using SNMP, you can monitor system events on the PIX Firewall. SNMP events can be read, but information on the PIX Firewall cannot be changed with SNMP.

The PIX Firewall SNMP traps available to an SNMP management station are as follows:

- Generic traps:
 - Link up and link down (cable connected to the interface or not; cable connected to an interface working or not working)
 - Cold start
 - Authentication failure (mismatched community string)
- Security-related events sent via the Cisco syslog MIB:
 - Global access denied
 - Failover syslog messages
 - Syslog messages

Use CiscoWorks for Windows or any other SNMP V1, MIB-II compliant browser to receive SNMP traps and browse an MIB. SNMP traps occur at UDP port 162.

MIB Support



Note

The PIX Firewall does not support browsing of the Cisco syslog MIB.

You can browse the System and Interface groups of MIB-II. Browsing an MIB is different from sending traps. Browsing means doing an **snmpget** or **snmpwalk** of the MIB tree from the management station to determine values.

PIX Firewall Version 6.3(2) and higher supports the following additional Interface objects of MIB-II:

- ifOutQLen
- ifInUnknownProtos

The Cisco Firewall MIB and Cisco Memory Pool MIB are available.

PIX Firewall does not support the following in the Cisco Firewall MIB:

- cfwSecurityNotification NOTIFICATION-TYPE
- cfwContentInspectNotification NOTIFICATION-TYPE
- cfwConnNotification NOTIFICATION-TYPE
- cfwAccessNotification NOTIFICATION-TYPE
- cfwAuthNotification NOTIFICATION-TYPE
- cfwGenericNotification NOTIFICATION-TYPE

SNMP CPU Utilization

PIX Firewall Version 6.2 and higher supports monitoring CPU utilization through SNMP. This feature allows network administrators to monitor PIX Firewall CPU usage using SNMP management software, (such as HP OpenView) for capacity planning.

This functionality is implemented through support for the `cpmCPUTotalTable` of the Cisco Process MIB (CISCO-PROCESS-MIB.my.) The other two tables in the MIB, `cpmProcessTable` and `cpmProcessExtTable` are not supported in this release.

Each row of the `cpmCPUTotalTable` consists of the following five elements:

- Index of each CPU



Note Because all current PIX Firewall hardware platforms support a single CPU, PIX Firewall returns only one row from `cpmCPUTotalTable` and the index is always 1.

- `entPhysicalIndex` of the physical entity for which the CPU statistics in this entry are maintained (the value of this object will be zero because the `entPhysicalTable` of Entity MIB is not supported on the PIX Firewall SNMP agent)
- Overall CPU busy percentage in the last five-second period
- Overall CPU busy percentage in the last one-minute period
- Overall CPU busy percentage in the last five-minute period

The values of the last three elements will be the same as the output from the `show cpu usage` command.

Table 9-8 CPU Utilization MIB Variables

MIB object name	Description
<code>cpmCPUTotalIndex</code>	The value of this object will be zero because the <code>entPhysicalTable</code> of Entity MIB is not supported on the PIX Firewall SNMP agent.
<code>cpmCPUTotalPhysicalIndex</code>	The value of this object will be zero because the <code>entPhysicalTable</code> of Entity MIB is not supported on the PIX Firewall SNMP agent.
<code>cpmCPUTotal5sec</code>	Overall CPU busy percentage in the last five-second period.
<code>cpmCPUTotal1min</code>	Overall CPU busy percentage in the last one-minute period.
<code>cpmCPUTotal5min</code>	Overall CPU busy percentage in the last five-minute period.

PIX Firewall does not support the following new MIB objects in the `cpmCPUTotalTable`:

- `cpmCPUTotal5secRev`
- `cpmCPUTotal1minRev`
- `cpmCPUTotal5minRev`

SNMP Usage Notes

- The MIB-II `ifEntry.ifAdminStatus` object returns a one (1) if the interface is up and two (2) if administratively down.
- The SNMP “`ifOutUcastPkts`” object now correctly returns the outbound packet count.
- Syslog messages generated by the SNMP module now specify the interface name instead of an interface number.

SNMP Traps

Traps are different than browsing; they are unsolicited “comments” from the managed device to the management station for certain events, such as link up, link down, and syslog event generated.

An SNMP object ID (OID) for PIX Firewall displays in SNMP event traps sent from the PIX Firewall. PIX Firewall provides system OID in SNMP event traps & SNMP mib-2.system.sysObjectID variable based on the hardware platform.

Table 9-9 lists the system OID in PIX Firewall platforms:

Table 9-9 System OID in PIX Firewall Platforms

PIX Firewall Platform	System OID
PIX 506	.1.3.6.1.4.1.9.1.389
PIX 506E	.1.3.6.1.4.1.9.1.450
PIX 515	.1.3.6.1.4.1.9.1.390
PIX 515E	.1.3.6.1.4.1.9.1.451
PIX 520	.1.3.6.1.4.1.9.1.391
PIX 525	.1.3.6.1.4.1.9.1.392
PIX 535	.1.3.6.1.4.1.9.1.393
others	.1.3.6.1.4.1.9.1.227 (original PIX Firewall OID)

The SNMP service running on the PIX Firewall performs two different functions:

- Replies to SNMP requests from management stations (also known as SNMP clients).
- Sends traps (event notifications) to management stations or other devices that are registered to receive them from the PIX Firewall. PIX Firewall supports two types of traps: generic traps and syslog traps.

Receiving Requests and Sending Syslog Traps

Follow these steps to receive requests and send traps from the PIX Firewall to an SNMP management station:

Step 1 Identify the IP address of the SNMP management station with the **snmp-server host** command.

Step 2 Set the **snmp-server** options for **location**, **contact**, and the **community** password as required.

If you only want to send the cold start, link up, and link down generic traps, no further configuration is required.

If you only want to receive SNMP requests, no further configuration is required.

Step 3 Add an **snmp-server enable traps** command statement.

Step 4 Set the logging level with the **logging history** command:

```
logging history debugging
```

We recommend that you use the **debugging** level during initial set up and during testing. Thereafter, set the level from **debugging** to a lower value for production use.

(The **logging history** command sets the severity level for SNMP syslog messages.)

- Step 5** Start sending syslog traps to the management station with the **logging on** command.
- Step 6** To disable sending syslog traps, use the **no logging on** command or the **no snmp-server enable traps** command.

The commands in [Example 9-11](#) specify that PIX Firewall can receive the SNMP requests from host 192.168.3.2 on the inside interface but does not send SNMP syslog traps to any host.

Example 9-11 Enabling SNMP

```
snmp-server host 192.168.3.2
snmp-server location building 42
snmp-server contact kim lee
snmp-server community ohwhatakeyisthee
```

The **location** and **contact** commands identify where the host is and who administers it. The **community** command specifies the password in use at the PIX Firewall SNMP agent and the SNMP management station for verifying network access between the two systems.

Compiling Cisco Syslog MIB Files

To receive security and failover SNMP traps from the PIX Firewall, compile the Cisco SMI MIB and the Cisco syslog MIB into your SNMP management application. If you do not compile the Cisco syslog MIB into your application, you only receive traps for link up or down, firewall cold start and authentication failure.

You can select Cisco MIB files for PIX Firewall and other Cisco products from the following website:

<http://www.cisco.com/public/sw-center/netmgmt/cmtk/mibs.shtml>

From this page, select **PIX Firewall** from the Cisco Secure & VPN selection list.

Follow these steps to compile Cisco syslog MIB files into your browser using CiscoWorks for Windows (SNMPc):

-
- Step 1** Get the Cisco syslog MIB files.
- Step 2** Start SNMPc.
- Step 3** Click **Config>Compile MIB**.
- Step 4** Scroll to the bottom of the list, and click the last entry.
- Step 5** Click **Add**.
- Step 6** Find the Cisco syslog MIB files.



Note With certain applications, only files with a .mib extension may show in the file selection window of the SNMPc. The Cisco syslog MIB files with the .my extension will not be shown. In this case, you should manually change the .my extension to a .mib extension.

- Step 7** Click CISCO-FIREWALL-MIB.my (CISCO-FIREWALL-MIB.mib) and click **OK**.
- Step 8** Scroll to the bottom of the list, and click the last entry.
- Step 9** Click **Add**.

- Step 10** Find the file CISCO-MEMORY-POOL-MIB.my (CISCO-MEMORY-POOL-MIB.mib) and click **OK**.
- Step 11** Scroll to the bottom of the list, and click the last entry.
- Step 12** Click **Add**.
- Step 13** Find the file CISCO-SMI.my (CISCO-SMI.mib) and click **OK**.
- Step 14** Scroll to the bottom of the list, and click the last entry.
- Step 15** Click **Add**.
- Step 16** Find the file CISCO-SYSLOG-MIB.my (CISCO-SYSLOG-MIB.mib) and click **OK**.
- Step 17** Click **Load All**.
- Step 18** If there are no errors, restart SNMPc.



Note These instructions are only for SNMPc (CiscoWorks for Windows).

Using the Firewall and Memory Pool MIBs

The Cisco Firewall and Memory Pool MIBs let you poll failover and system status.

This section contains the following topics:

- [ipAddrTable Notes, page 9-46](#)
- [Viewing Failover Status, page 9-47](#)
- [Verifying Memory Usage, page 9-48](#)
- [Viewing The Connection Count, page 9-49](#)
- [Viewing System Buffer Usage, page 9-50](#)

In the tables that follow in each section, the meaning of each returned value is shown in parentheses.

ipAddrTable Notes

Use of the SNMP ip.ipAddrTable entry requires that all interfaces have unique addresses. If interfaces have not been assigned IP addresses, by default, their IP addresses are all set to 127.0.0.1. Having duplicate IP addresses causes the SNMP management station to loop indefinitely. The workaround is to assign each interface a different address. For example, you can set one address to 127.0.0.1, another to 127.0.0.2, and so on.

SNMP uses a sequence of GetNext operations to traverse the MIB tree. Each GetNext request is based on the result of the previous request. Therefore, if two consecutive interfaces have the same IP 127.0.0.1 (table index), the GetNext function returns 127.0.0.1, which is correct; however, when SNMP generates the next GetNext request using the same result (127.0.0.1), the request is identical to the previous one, which causes the management station to loop infinitely.

For example:

```
GetNext(ip.ipAddrTable.ipAddrEntry.ipAdEntAddr.127.0.0.1)
```

In SNMP protocol, the MIB table index should be unique for the agent to identify a row from the MIB table. The table index for ip.ipAddrTable is the PIX Firewall interface IP address, so the IP address should be unique; otherwise, the SNMP agent will get confused and may return information of another interface (row), which has the same IP (index).

Viewing Failover Status

The Cisco Firewall MIB's cfwHardwareStatusTable lets you determine whether failover is enabled and which unit is active. The Cisco Firewall MIB indicates failover status by two rows in the cfwHardwareStatusTable object. From the PIX Firewall command line, you can view failover status with the **show failover** command. You can access the object table from the following path:

```
.iso.org.dod.internet.private.enterprises.cisco.ciscoMgmt.ciscoFirewallMIB.  
ciscoFirewallMIBObjects.cfwSystem.cfwStatus.cfwHardwareStatusTable
```

Table 9-10 lists which objects provide failover information.

Table 9-10 Failover Status Objects

Object	Object Type	Row 1: Returned if Failover is Disabled	Row 1: Returned if Failover is Enabled	Row 2: Returned if Failover is Enabled
cfwHardwareType (table index)	Hardware	6 (If primary unit)	6 (If primary unit)	7 (If secondary unit)
cfwHardwareInformation	SnmpAdminString	blank	blank	blank
cfwHardwareStatusValue	HardwareStatus	0 (Not used)	active or 9 (If active unit) or standby or 10 (If standby unit)	active or 9 (If active unit) or standby or 10 (If standby unit)
cfwHardwareStatusDetail	SnmpAdminString	Failover Off	blank	blank

In the HP OpenView Browse MIB application's "MIB values" window, if failover is disabled, a sample MIB query yields the following information:

```
cfwHardwareInformation.6 :  
cfwHardwareInformation.7 :  
cfwHardwareStatusValue.6 :0  
cfwHardwareStatusValue.7 :0  
cfwHardwareStatusDetail.6 :Failover Off  
cfwHardwareStatusDetail.7 :Failover Off
```

From this listing, the table index, cfwHardwareType, appears as either .6 or .7 appended to the end of each of the subsequent objects. The cfwHardwareInformation field is blank, the cfwHardwareStatusValue is 0, and the cfwHardwareStatusDetail contains **Failover Off**, which indicates the failover status.

When failover is enabled, a sample MIB query yields the following information:

```
cfwHardwareInformation.6 :  
cfwHardwareInformation.7 :  
cfwHardwareStatusValue.6 : active  
cfwHardwareStatusValue.7 : standby  
cfwHardwareStatusDetail.6 :  
cfwHardwareStatusDetail.7 :
```

In this listing, only the cfwHardwareStatusValue contains values, either **active** or **standby** to indicate the status of each unit.

Verifying Memory Usage

You can determine how much free memory is available with the Cisco Memory Pool MIB. From the PIX Firewall command line, memory usage is viewed with the **show memory** command. The following is sample output from the **show memory** command.

```
pix(config)# show memory
Free memory:      16751592 bytes
Used memory:     16802840 bytes
-----
Total memory:    33554432 bytes
```

You can access the MIB objects from the following path:

```
.iso.org.dod.internet.private.enterprises.cisco.ciscoMgmt.ciscoMemoryPoolMIB.
ciscoMemoryPoolObjects.ciscoMemoryPoolTable
```

[Table 9-11](#) lists which objects provide memory usage information.

Table 9-11 Memory Usage Objects

Object	Object Type	Returned Value
ciscoMemoryPoolType (table index)	CiscoMemoryPoolTypes	1 (Processor memory)
ciscoMemoryPoolName	DisplayString	PIX system memory
ciscoMemoryPoolAlternate	Integer32	0 (No alternate memory pool)
ciscoMemoryPoolValid	TruthValue	true (Means that the values of the remaining objects are valid)
ciscoMemoryPoolUsed	Gauge32	<i>integer</i> (Number of bytes currently in use)
ciscoMemoryPoolFree	Gauge32	<i>integer</i> (Number of bytes currently free)
ciscoMemoryPoolLargestFree	Gauge32	<i>integer</i> (Number of bytes currently largest free)

In the HP OpenView Browse MIB application's "MIB values" window a sample MIB query yields the following information:

```
ciscoMemoryPoolName.1 :PIX system memory
ciscoMemoryPoolAlternate.1 :0
ciscoMemoryPoolValid.1 :true
ciscoMemoryPoolUsed.1 :12312576
ciscoMemoryPoolFree.1 :54796288
ciscoMemoryPoolLargestFree.1 :0
```

From this listing, the table index, `ciscoMemoryPoolName`, appears as the `.1` value at the end of each subsequent object value. The `ciscoMemoryPoolUsed` object lists the number of bytes currently in use, **12312576**, and the `ciscoMemoryPoolFree` object lists the number of bytes currently free **54796288**. The other objects always list the values described in [Table 9-11](#).

Viewing The Connection Count

You can view the number of connections in use from the `cfwConnectionStatTable` in the Cisco Firewall MIB. From the PIX Firewall command line, you can view the connection count with the `show conn` command. The following is sample output from the `show conn` command to demonstrate where the information in `cfwConnectionStatTable` originates.

```
pix(config)# show conn
15 in use, 88 most used
```

The `cfwConnectionStatTable` object table can be accessed from the following path:

```
.iso.org.dod.internet.private.enterprises.cisco.ciscoMgmt.ciscoFirewallMIB.
ciscoFirewallMIBObjects.cfwSystem.cfwStatistics.cfwConnectionStatTable
```

Table 9-12 lists which objects provide connection count information.

Table 9-12 Connection Count Objects

Object	Object Type	Row 1: Returned Value	Row 2: Returned Value
<code>cfwConnectionStatService</code> (Table index)	Services	40 (IP protocol)	40 (IP protocol)
<code>cfwConnectionStatType</code> (Table index)	ConnectionStat	6 (Current connections in use)	7 (High)
<code>cfwConnectionStatDescription</code>	SnmpAdminString	number of connections currently in use by the entire firewall	highest number of connections in use at any one time since system startup
<code>cfwConnectionStatCount</code>	Counter32	0 (Not used)	0 (Not used)
<code>cfwConnectionStatValue</code>	Gauge32	<i>integer</i> (In use number)	<i>integer</i> (Most used number)

In the HP OpenView Browse MIB application's "MIB values" window, a sample MIB query yields the following information:

```
cfwConnectionStatDescription.40.6 :number of connections currently in use by the entire firewall
cfwConnectionStatDescription.40.7 :highest number of connections in use at any one time since system startup
cfwConnectionStatCount.40.6 :0
cfwConnectionStatCount.40.7 :0
cfwConnectionStatValue.40.6 :15
cfwConnectionStatValue.40.7 :88
```

From this listing, the table index, `cfwConnectionStatService`, appears as the **.40** appended to each subsequent object and the table index, `cfwConnectionStatType`, appears as either **.6** to indicate the number of connections in use or **.7** to indicate the most used number of connections. The `cfwConnectionStatValue` object then lists the connection count. The `cfwConnectionStatCount` object always returns **0** (zero).

Viewing System Buffer Usage

You can view the system buffer usage from the Cisco Firewall MIB in multiple rows of the `cfwBufferStatsTable`. The system buffer usage provides an early warning of the PIX Firewall reaching the limit of its capacity. On the command line, you can view this information with the **show blocks** command. The following is sample output from the **show blocks** command to demonstrate how `cfwBufferStatsTable` is populated.

```
show blocks
SIZE      MAX      LOW      CNT
   4      1600    1600    1600
   80      100     97      97
  256      80      79      79
 1550      780    402     404
65536      8       8       8
```

You can view `cfwBufferStatsTable` at the following path:

```
.iso.org.dod.internet.private.enterprises.cisco.ciscoMgmt.ciscoFirewallMIB.
ciscoFirewallMIBObjects.cfwSystem.cfwStatistics.cfwBufferStatsTable
```

Table 9-13 lists the objects required to view the system block usage.

Table 9-13 System Block Usage Objects

Object	Object Type	First Row: Returned Value	Next Row: Returned Value	Next Row: Returned Value
<code>cfwBufferStatSize</code> (Table index)	Unsigned32	<i>integer</i> (SIZE value; for example, 4 for a 4-byte block)	<i>integer</i> (SIZE value; for example, 4 for a 4-byte block)	<i>integer</i> (SIZE value; for example, 4 for a 4-byte block)
<code>cfwBufferStatType</code> (Table index)	ResourceStatistics	3 (MAX)	5 (LOW)	8 (CNT)
<code>cfwBufferStatInformation</code>	SnmpAdminString	maximum number of allocated <i>integer</i> byte blocks (<i>integer</i> is the number of bytes in a block)	fewest <i>integer</i> byte blocks available since system startup (<i>integer</i> is the number of bytes in a block)	current number of available <i>integer</i> byte blocks (<i>integer</i> is the number of bytes in a block)
<code>cfwBufferStatValue</code>	Gauge32	<i>integer</i> (MAX number)	<i>integer</i> (LOW number)	<i>integer</i> (CNT number)



Note

The three rows repeat for every block size listed in the output of the **show blocks** command.

In the HP OpenView Browse MIB application's "MIB values" window a sample MIB query yields the following information:

```
cfwBufferStatInformation.4.3 :maximum number of allocated 4 byte blocks
cfwBufferStatInformation.4.5 :fewest 4 byte blocks available since system startup
cfwBufferStatInformation.4.8 :current number of available 4 byte blocks
cfwBufferStatInformation.80.3 :maximum number of allocated 80 byte blocks
cfwBufferStatInformation.80.5 :fewest 80 byte blocks available since system startup
cfwBufferStatInformation.80.8 :current number of available 80 byte blocks
cfwBufferStatInformation.256.3 :maximum number of allocated 256 byte blocks
cfwBufferStatInformation.256.5 :fewest 256 byte blocks available since system startup
cfwBufferStatInformation.256.8 :current number of available 256 byte blocks
cfwBufferStatInformation.1550.3 :maximum number of allocated 1550 byte blocks
cfwBufferStatInformation.1550.5 :fewest 1550 byte blocks available since system startup
cfwBufferStatInformation.1550.8 :current number of available 1550 byte blocks
cfwBufferStatValue.4.3: 1600
cfwBufferStatValue.4.5: 1600
cfwBufferStatValue.4.8: 1600
cfwBufferStatValue.80.3: 400
cfwBufferStatValue.80.5: 396
cfwBufferStatValue.80.8: 400
cfwBufferStatValue.256.3: 1000
cfwBufferStatValue.256.5: 997
cfwBufferStatValue.256.8: 999
cfwBufferStatValue.1550.3: 1444
cfwBufferStatValue.1550.5: 928
cfwBufferStatValue.1550.8: 932
```

From this listing, the first table index, `cfwBufferStatSize`, appears as first number appended to the end of each object, such as `.4` or `.256`. The other table index, `cfwBufferStatType`, appears as `.3`, `.5`, or `.8` after the first index. For each block size, the `cfwBufferStatInformation` object identifies the type of value and the `cfwBufferStatValue` object identifies the number of bytes for each value.



Using PIX Firewall Failover

This chapter describes the PIX Firewall failover feature, which allows a secondary PIX Firewall to take over the functionality of a failed primary PIX Firewall. This chapter includes the following topics:

- [Failover System Requirements](#), page 10-2
- [Understanding Failover](#), page 10-3
- [Failover Configuration Prerequisites](#), page 10-8
- [Configuring Cable-Based Failover](#), page 10-9
- [Configuring LAN-Based Failover](#), page 10-11
- [Verifying the Failover Configuration](#), page 10-16
- [Forcing Failover](#), page 10-20
- [Disabling Failover](#), page 10-20
- [Monitoring Failover](#), page 10-20
- [Frequently Asked Failover Questions](#), page 10-21
- [Failover Configuration Examples](#), page 10-25



Note

For instructions about upgrading the failover feature from a previous version, see the [“Upgrading Failover Systems from a Previous Version”](#) section in [Chapter 11, “Changing Feature Licenses and System Software.”](#)

Failover System Requirements

Table 10-1 lists the system requirements for the failover feature.

Table 10-1 Failover System Requirements

Requirement	Description
Supported PIX Firewall models	<ul style="list-style-type: none"> • PIX 515 • PIX 515E • PIX 520 • PIX 525 • PIX 535 <p>Note The PIX 501 and PIX 506E models do not support failover.</p>
Identical PIX Firewall hardware and software versions	<p>The failover feature requires two units that are identical in the following respects:</p> <ul style="list-style-type: none"> • Model (a PIX 515E <i>cannot</i> be used with a PIX 515) • Same number and type of interfaces • Software version • Activation key type (DES or 3DES) • Flash memory • Amount of RAM <p>Note The PIX-4FE and PIX-4FE-66 cards are considered equivalent and interchangeable. You can install a PIX-4FE in the primary unit and a PIX-4FE-66 in the secondary unit, as long as you install them in the same slot number of each chassis. For example, if you install a PIX-4FE in Slot 1 of the primary unit, the PIX-4FE-66 must be installed in Slot 1 of the secondary unit.</p>
At least one unit with an Unrestricted (UR) license	<p>The other unit can have a Failover Only (FO) or another UR license. Units with a Restricted license cannot be used for failover, and two units with FO licenses cannot be used together as a failover pair.</p> <p>The PIX Firewall with the FO license is intended to be used solely for failover and not in standalone mode. If a failover unit is used in standalone mode, the unit will reboot at least once every 24 hours until the unit is returned to failover duty. When the unit reboots, the following message displays on the console:</p> <pre> =====NOTICE===== This machine is running in secondary mode without a connection to an active primary PIX. Please check your connection to the primary system. REBOOTING.... ===== </pre>

Understanding Failover

This section describes how failover works, and includes the following topics:

- [Overview, page 10-3](#)
- [Network Connections, page 10-3](#)
- [Failover and State Links, page 10-4](#)
- [Primary and Secondary Vs. Active and Standby, page 10-6](#)
- [Configuration Replication, page 10-6](#)
- [Failover Triggers, page 10-7](#)

Overview

The failover feature allows you to use a standby PIX Firewall to take over the functionality of a failed PIX Firewall. When the active unit fails, it changes to the standby state, while the standby unit changes to the active state. The unit that becomes active takes over the active unit's IP addresses and MAC addresses, and begins passing traffic. The unit that is now in standby state takes over the standby IP addresses and MAC addresses. Because network devices see no change in the MAC to IP address pairing, no ARP entries change or time out anywhere on the network. (See the [“Primary and Secondary Vs. Active and Standby”](#) section for more information about MAC addresses).

The PIX Firewall supports two types of failover:

- **Regular Failover**—When a failover occurs, all active connections are dropped and clients need to reestablish connections when the new active unit takes over.
- **Stateful Failover**—During normal operation, the active unit continually passes per-connection stateful information to the standby unit. After a failover occurs, the same connection information is available at the new active unit. Supported end-user applications are not required to reconnect to keep the same communication session.

The state information passed to the standby unit includes:

- NAT translation table
- TCP connection states
- H.323, SIP, and MGCP UDP media connections

Network Connections

Both units require the same access to the inside and outside networks. You must place them in parallel, as shown in [Figure 10-1](#). Because the standby unit does not pass traffic, only the active unit takes part in networking. The active and standby units must be on the same subnet, so there cannot be a router between the two units. However, you can place one or more switches between the two units.

Figure 10-1 Parallel Position in Network

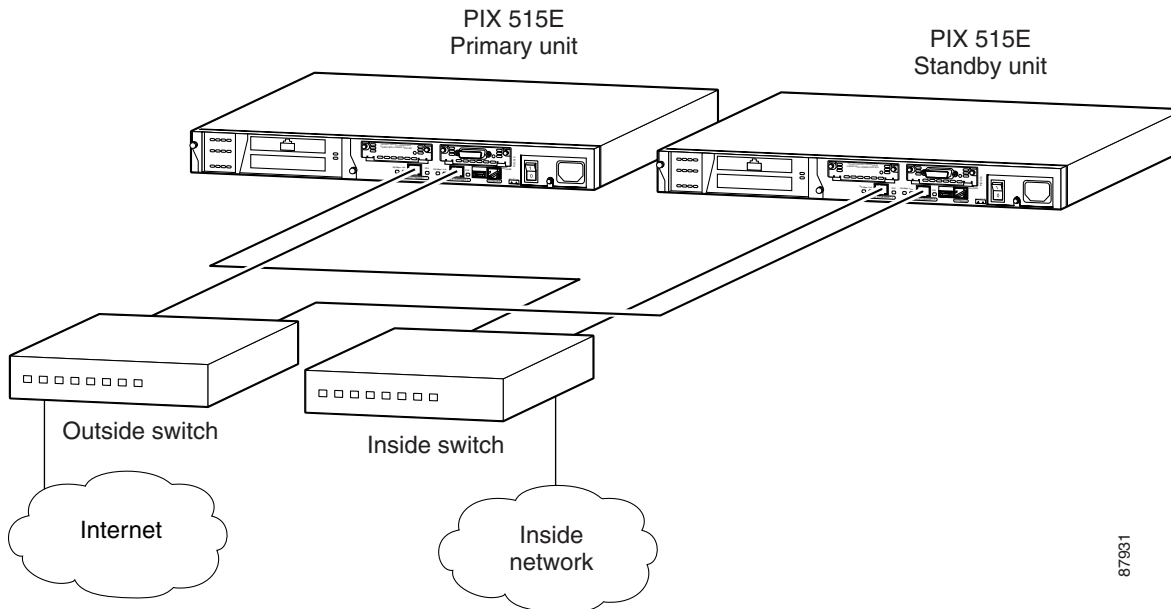

Failover and State Links

This section describes the failover link, and for Stateful Failover, the state link. This section includes the following topics:

- [Failover Link, page 10-4](#)
- [State Link, page 10-5](#)

Failover Link

The two units constantly communicate over a failover link to determine each unit's operating status. Communications over the failover link include:

- The unit state (active or standby)
- The power status (cable-based failover only)
- Hello messages (also sent on all other interfaces)
- Configuration synchronization between the two units (see the [“Configuration Replication”](#) section for more information).

The failover link can be one of the following connections:

- Serial failover cable (“cable-based failover”)—If the two units are within six feet of each other, then we recommend that you use the serial failover cable. Using this cable allows the firewall to sense a power loss of the peer unit, and to differentiate a power loss from an unplugged cable. The cable is a modified RS-232 serial link cable that transfers data at 117,760 bps (115 Kbps). One end is labeled “Primary” and attaches to the primary unit, while the other end is labeled “Secondary” and attaches to the secondary unit. If you purchased a PIX Firewall failover bundle, this cable is included. To order a spare, use part number PIX-FO.
- Ethernet connection (“LAN-based failover”)—You can use any unused Ethernet interface on the device. If the units are further than six feet apart, use this method. We recommend that you connect this link through a dedicated switch. You *cannot* use a crossover Ethernet cable to link the units directly.

The disadvantages of using LAN-based failover include:

- The PIX Firewall cannot immediately detect the loss of power of a peer, so the PIX Firewall takes longer to fail over in this case.
- You need to configure the failover link on the standby unit before it can communicate with the active unit.

In cable-based failover, the standby unit can communicate directly with the active unit, and can receive the entire configuration before enabling any interfaces or setting IP addresses.
- The switch between the two units can be another point of hardware failure.
- You have to dedicate an Ethernet interface (and switch ports) to the failover link, and the interface cannot be used for regular traffic.

The benefits include:

- Separation of the units by more than 6 feet.
- Faster configuration replication.

State Link

For Stateful Failover, you must use an Ethernet link to pass state information. The PIX Firewall supports the following Ethernet interface settings for the state link:

- Fast Ethernet (100BASE-T) full duplex
- Gigabit Ethernet (GE) (1000BASE-T) full duplex



Note

On a PIX 535 with GE interfaces, you must use a GE interface as the state link.

We recommend that you use a crossover cable to directly connect the units. You can also use a switch between the units. No hosts or routers should be on this link.

If the two units are more than six feet apart, you can use the same Ethernet state link as the failover link, but we recommend that you use a separate Ethernet link if available. If they are closer than 6 feet, we recommend that you use the serial failover cable as the failover link.



Note

If you use the same link for both state and failover, you *cannot* use a crossover cable.

Primary and Secondary Vs. Active and Standby

The main differences between the two units in a failover pair are related to which unit is active and which unit is standby, namely which IP addresses to use and which unit actively passes traffic.

However, a few differences exist between the units based on which unit is *primary* and which unit is *secondary*:

- The primary unit always becomes the active unit if both units start up at the same time (and are of equal operational health).
- The primary unit's MAC addresses are always coupled with the active IP addresses. The exception to this rule occurs when:
 - The secondary unit is active, and cannot obtain the primary's MAC addresses over the failover link.
 - If you hardcode them into the configuration (see the **failover mac address** command in the *Cisco PIX Firewall Command Reference* for more information about setting the MAC addresses).

In cable-based failover, the serial failover cable is marked with one end as "Primary" and the other as "Secondary." The cable itself determines which unit is primary. In LAN-based failover, you must set the primary and secondary identification in the configuration.

Configuration Replication

The two PIX Firewall units share the same configuration. The configuration can be the same because it includes both the *active* IP addresses and the *standby* IP addresses. When a unit is active, it uses the active IP addresses; when a unit is standby, it uses the standby IP addresses.



Note

Because the configuration is the same on both units, the host names, usernames, and passwords are also the same.

For LAN-based failover, the configuration on the two units differs slightly, because you must set up the Ethernet link in advance. You must also define each unit as a primary or secondary unit within the configuration (as opposed to cable-based failover, where the serial failover cable itself defines these roles).

The active unit sends the configuration in running memory to the standby unit. On the standby unit, the configuration exists only in running memory. You can optionally save the configuration to Flash memory using the **write memory** command. If you save the configuration to Flash memory, and you reboot the standby unit when the active unit is unavailable, the standby unit can become the active unit because it has a valid configuration.



Note

If you enter the **write memory** command on the active unit, the command is replicated to the standby unit, which proceeds to write its configuration to Flash memory.

Configuration replication from the active unit to the standby unit occurs in the following ways:

- When the standby unit completes its initial startup, it clears its running configuration using the **clear configure all** command (except for the LAN-based failover commands that are not replicated), and the active unit sends its entire configuration to the standby unit.
- As commands are entered on the active unit, they are sent across the failover link to the standby unit. You do not have to save the active configuration to Flash memory to replicate the commands.
- If you enter the **write standby** command on the active unit, the standby unit clears its running configuration using the **clear configure all** command (except for the LAN-based failover commands that are not replicated), and the active unit sends its entire configuration to the standby unit.

**Note**

Changes made on the standby unit are not replicated to the active unit.

When you use a serial failover cable, the replication can take a long time to complete with a large configuration.

When the replication starts, the PIX Firewall console displays the message “Sync Started,” and when complete, displays the message “Sync Completed.” During the replication, information cannot be entered on the PIX Firewall console.

Failover Triggers

If the active unit fails, the standby unit takes over. The following situations cause a failover to occur if they affect the active unit, but not the standby unit:

- Network failure
- PIX Firewall hardware failure
- Power loss or reload

For power loss or reload using cable-based failover, the standby unit learns almost immediately if the active unit loses power or is reset. The other conditions listed previously are sensed when a given interface does not receive hello packets for two consecutive poll intervals. The poll interval is user configurable. The interface is then tested to determine which unit is at fault.

Initially, the PIX Firewall runs the Link Up/Down test, which is a test of the Ethernet card. If an interface card is not plugged into an operational network, it is also considered to be failed (for example, the upstream switch failed, has a failed port, or a cable is unplugged).

If the Link Up/Down test indicates that the Ethernet card is operational, then the firewall performs network tests. The purpose of these tests is to generate network traffic to determine which (if either) unit has failed. At the start of each test, each unit clears its received packet count for its interfaces. At the conclusion of each test, each unit looks to see if it has received any traffic. If it has, the interface is considered operational. If one unit receives traffic for a test and the other unit does not, the unit that received no traffic is considered failed. If neither unit has received traffic, then the next test is used.

The PIX Firewall performs the following network tests:

1. Network Activity test—A received network activity test. The unit counts all received packets for up to 5 seconds. If any packets are received at any time during this interval, the interface is considered operational and testing stops. If no traffic is received, the ARP test begins.
2. ARP test—Reading the unit’s ARP cache for the 10 most recently acquired entries. One at a time, the unit sends ARP requests to these machines attempting to stimulate network traffic. After each request, the unit counts all received traffic for up to 5 seconds. If traffic is received, the interface is considered operational. If no traffic is received, an ARP request is sent to the next machine. If at the end of the list no traffic has been received, the ping test begins.

3. Broadcast Ping test—The ping test consists of sending out a broadcast ping request. The unit then counts all received packets for up to 5 seconds. If any packets are received at any time during this interval, the interface is considered operational and testing stops.

If all network tests fail, then the interface is considered to be failed. If the standby unit has more operational interfaces, then a failover occurs. If both units have similar failures (for example, neither unit can receive upstream traffic), then no failover occurs.

Failover Configuration Prerequisites

This section describes how to set up your network switches and your PIX Firewall to support failover. It includes the following topics:

- [Configuring Switches to Support Failover, page 10-8](#)
- [Preconfiguring the PIX Firewall for Failover, page 10-8](#)

Configuring Switches to Support Failover

Perform the following steps on any Cisco switch ports that connect directly to the Firewall Services Module:

-
- Step 1** Enable PortFast.
 - Step 2** Turn off trunking.
 - Step 3** Turn off channeling.
-



Note

In Cisco Catalyst operating system Version 5.4 and later, you can use the following command to perform steps 1 through 3:

```
set port host
```

The **set port host** command automatically executes the following commands:

```
spantree portfast enable
set trunk off
set port channel off
```

Preconfiguring the PIX Firewall for Failover

This section includes steps that are not directly related to enabling failover, but that are required for failover to work. Follow these steps on the *primary* unit. Steps related only to Stateful Failover are preceded by “(Stateful Failover).”

-
- Step 1** If you have not done so already, set the time.
See the “[Managing the PIX Firewall Clock](#)” section in [Chapter 9, “Accessing and Monitoring PIX Firewall,”](#) to set the time.

Step 2 If an interface is not going to be used, turn off the interface by entering:

```
primary(config)# interface hardware_id shutdown
```

Where *hardware_id* is **ethernetn** or **gb-ethernetn**.

This step prevents the firewall from expecting hello packets on the interface.

Step 3 Use the following Ethernet settings for your interfaces:

- **(Stateful Failover)** For the state link for Stateful Failover:

```
primary(config)# interface hardware_id {100full | 1000full}
```



Note The maximum transmission unit (MTU) size must be 1500 (the default) or larger on the state link. Use the **mtu** command if necessary.

- For all other Ethernet interfaces:

Any setting except the **auto** or the **1000auto** options. Auto detection is not always reliable, and PDM enforces this setting.

To view **interface** commands in your configuration, use the **write terminal** command. Reenter an interface with new information to correct a command you wish to change.

Step 4 Take note of the IP addresses you configured on your interfaces using the **ip address** command.

These IP addresses are used by the active unit, but you should take note of them, because the failover IP addresses used on the standby unit must be on the same subnet.

Configuring Cable-Based Failover

Follow these steps to configure failover using the serial failover cable as the failover link. The commands in this task apply to the *primary* unit. Steps related only to Stateful Failover are specified by “(Stateful Failover).”



Note At any time during the procedure, you can enter the **show failover** command to see the failover status. See the “[Using the Show Failover Command](#)” section for detailed information.

	Step/Command	Description
Step 1	Connect the failover cable to the PIX Firewall units.	Ensure that the end of the cable marked “Primary” attaches to the unit you want to use as the primary unit and that the end marked “Secondary” connects to the unit you want to use as the secondary unit.

	Step/Command	Description
Step 2	If you have not done so already, configure the Ethernet interface you are using for the Stateful Failover link:	(Stateful Failover)
a.	<pre>primary(config)# interface hardware_id hardware_speed</pre>	<p>Enables the interface.</p> <ul style="list-style-type: none"> • <i>hardware_id</i>—ethernetn or gb-ethernetn. • <i>hardware_speed</i>—The hardware speed and duplex for the Ethernet interface. The state link must be at least 100 Mbps, full duplex: <ul style="list-style-type: none"> – 100full—100 Mbps full duplex – 1000full—Auto negotiate, advertising 1000 Mbps full duplex – 1000full nonegotiate—Force link to 1000 Mbps full duplex <p>For example:</p> <pre>primary(config)# interface ethernet3 100full</pre>
b.	<pre>primary(config)# nameif hardware_id interface_name securitylevel</pre>	<p>Names the interface and sets the security level.</p> <p>Where:</p> <ul style="list-style-type: none"> • <i>hardware_id</i>—ethernetn or gb-ethernetn. • <i>interface_name</i>—A string describing the interface. • <i>securitylevel</i>—A number between 1 and 99. 0 and 100 are reserved for the inside and outside interfaces. Because this interface is a dedicated link, the security level can be any number. <p>For example:</p> <pre>primary(config)# nameif ethernet3 state security80</pre>
c.	<pre>primary(config)# ip address interface_name ip_address [netmask]</pre>	<p>Sets the IP address.</p> <p>For example:</p> <pre>primary(config)# ip address state 192.168.2.1 255.255.255.0</pre>

	Step/Command	Description
Step 3	<pre>primary(config)# failover ip address interface_name ip_address</pre>	<p>For each interface that has an IP address, this command identifies the failover IP address. This IP address is used on the standby unit.</p> <p>This IP address must be in the same subnet as the active IP address. You do not need to identify the subnet mask. To check the current IP address settings, enter the show ip address command.</p> <p>The following example sets the IP addresses for the active unit and for the standby unit:</p> <pre>primary(config)# ip address inside 10.1.1.1 255.255.255.0 primary(config)# failover ip address inside 10.1.1.2 primary(config)# ip address outside 192.168.1.1 255.255.255.0 primary(config)# failover ip address outside 192.168.1.2 primary(config)# ip address state 192.168.2.1 255.255.255.0 primary(config)# failover ip address state 192.168.2.2</pre>
Step 4	<pre>primary(config)# failover link interface_name</pre>	<p>(Stateful Failover) Specifies the state link interface.</p> <p>For example, to set the “state” interface as the state link, enter:</p> <pre>primary(config)# failover link state</pre>
Step 5	<pre>primary(config)# failover poll seconds</pre>	<p>(Optional) Sets a time shorter than 15 seconds for the units to exchange “hello” packets.</p> <p>Where <i>seconds</i> is an integer between 3 and 15. The default is 15 seconds.</p> <p>You might want to set a lower value for Stateful Failover, to make sure that the state information is up to date. With a faster poll time, the PIX Firewall can detect failure faster. However, faster detection may cause unnecessary switchovers when the network is temporarily congested or a network card starts slowly.</p>
Step 6	<pre>primary(config)# failover</pre>	Enables failover.
Step 7	If you have not already done so, power on the secondary unit.	The active unit sends the configuration in running memory to the standby unit. As the configuration synchronizes, the messages “Sync Started” and “Sync Completed” appear on the primary console.
Step 8	<pre>primary(config)# write memory</pre>	Saves the primary configuration to Flash memory. Because this command is replicated to the standby unit, the standby unit also saves its configuration to Flash memory.

Configuring LAN-Based Failover

This section describes how to configure failover using an Ethernet failover link. This section includes the following topics:

- [Configuring the Primary Unit, page 10-12](#)
- [Configuring the Secondary Unit, page 10-15](#)

**Note**

If you are changing from cable-based failover to LAN-based failover, complete all the steps in the following procedures that you did not already complete when you initially set up cable-based failover. For example, you might need to configure the **failover ip address** command for the failover link, but you do not need to reconfigure all the other failover IP addresses.

Configuring the Primary Unit

Follow these steps to configure the primary unit for LAN-based failover. Steps related only to Stateful Firewall are preceded by “(Stateful Failover).”

**Note**

At any time during the procedure, you can enter the **show failover** command to see the failover status. See the “[Using the Show Failover Command](#)” section for detailed information.

	Step/Command	Description
Step 1	If you have not done so already, configure the Ethernet interface you are using for the failover link:	Note these settings because you must use the same settings on the secondary unit.
a.	<pre>primary(config)# interface hardware_id hardware_speed</pre>	<p>Enables the interface.</p> <ul style="list-style-type: none"> • <i>hardware_id</i>—ethernetn or gb-ethernetn. • <i>hardware_speed</i>—The hardware speed and duplex for the Ethernet interface. Do not use auto or 1000auto. Auto detection is not always reliable, and PDM enforces this setting. <ul style="list-style-type: none"> – 10baseT—10 Mbps half duplex – 10full—10 Mbps full duplex – 100baseTX—100 Mbps half duplex – 100full—100 Mbps full duplex – 1000full—Auto negotiate, advertising 1000 Mbps full duplex – 1000full nonegotiate—Force link to 1000 Mbps full duplex <p>For example:</p> <pre>primary(config)# interface ethernet2 100full</pre>

	Step/Command	Description
b.	<pre>primary(config)# nameif hardware_id interface_name securitylevel</pre>	<p>Names the interface and sets the security level.</p> <p>Where:</p> <ul style="list-style-type: none"> <i>hardware_id</i>—ethernetn or gb-ethernetn. <i>interface_name</i>—A string describing the interface. securitylevel—A number between 1 and 99. 0 and 100 are reserved for the inside and outside interfaces. Because this interface is a dedicated link, the security level can be any number. <p>For example:</p> <pre>primary(config)# nameif ethernet2 faillink security90</pre>
c.	<pre>primary(config)# ip address interface_name ip_address [netmask]</pre>	<p>Sets the IP address. This address is used on the primary unit even when it changes to standby state.</p> <p>For example:</p> <pre>primary(config)# ip address faillink 192.168.2.1 255.255.255.0</pre>
Step 2	If you have not done so already, configure the Ethernet interface you are using for the Stateful Failover link:	(Stateful Failover)
a.	<pre>primary(config)# interface hardware_id hardware_speed</pre>	<p>Enables the interface.</p> <ul style="list-style-type: none"> <i>hardware_id</i>—ethernetn or gb-ethernetn. <i>hardware_speed</i>—The hardware speed and duplex for the Ethernet interface. The state link must be at least 100 Mbps, full duplex: <ul style="list-style-type: none"> 100full—100 Mbps full duplex 1000full—Auto negotiate, advertising 1000 Mbps full duplex 1000full nonegotiate—Force link to 1000 Mbps full duplex <p>For example:</p> <pre>primary(config)# interface ethernet3 100full</pre>
b.	<pre>primary(config)# nameif hardware_id interface_name securitylevel</pre>	<p>Names the interface and sets the security level.</p> <p>Where:</p> <ul style="list-style-type: none"> <i>hardware_id</i>—ethernetn or gb-ethernetn. <i>interface_name</i>—A string describing the interface. securitylevel—A number between 1 and 99. 0 and 100 are reserved for the inside and outside interfaces. Because this interface is a dedicated link, the security level can be any number. <p>For example:</p> <pre>primary(config)# nameif ethernet3 state security80</pre>

	Step/Command	Description
c.	<pre>primary(config)# ip address interface_name ip_address [netmask]</pre>	<p>Sets the IP address.</p> <p>For example:</p> <pre>primary(config)# ip address state 192.168.3.1 255.255.255.0</pre>
Step 3	<pre>primary(config)# failover ip address interface_name ip_address</pre>	<p>For each interface that has an IP address, this command identifies the failover IP address. This IP address is used on the standby unit.</p> <p>This IP address must be in the same subnet as the active IP address. You do not need to identify the subnet mask. To check the current IP address settings, enter the show ip address command.</p> <p>Note You must set the failover IP address for the failover link, even though the failover link IP address and MAC address <i>do not</i> change at failover. The active IP address always stays with the primary unit, while the failover IP address stays with the secondary unit.</p> <p>The following example sets the IP addresses for the active unit and for the standby unit:</p> <pre>primary(config)# ip address inside 10.1.1.1 255.255.255.0 primary(config)# failover ip address inside 10.1.1.2 primary(config)# ip address outside 192.168.1.1 255.255.255.0 primary(config)# failover ip address outside 192.168.1.2 primary(config)# ip address faillink 192.168.2.1 255.255.255.0 primary(config)# failover ip address faillink 192.168.2.2 primary(config)# ip address state 192.168.3.1 255.255.255.0 primary(config)# failover ip address state 192.168.3.2</pre>
Step 4	<pre>primary(config)# failover link interface_name</pre>	<p>(Stateful Failover) Specifies the state link interface.</p> <p>For example, to set the “state” interface as the state link, enter:</p> <pre>primary(config)# failover link state</pre>
Step 5	<pre>primary(config)# failover poll seconds</pre>	<p>(Optional) Sets a time shorter than 15 seconds for the units to exchange “hello” packets.</p> <p>Where <i>seconds</i> is an integer between 3 and 15. The default is 15 seconds.</p> <p>You might want to set a lower value for Stateful Failover, to make sure that the state information is up to date. With a faster poll time, the PIX Firewall can detect failure faster. However, faster detection may cause unnecessary switchovers when the network is temporarily congested or a network card starts slowly.</p>
Step 6	<pre>primary(config)# failover lan unit primary</pre>	<p>Sets this PIX Firewall as the primary unit.</p>
Step 7	<pre>primary(config)# failover lan interface interface_name</pre>	<p>Identifies the Ethernet interface for the failover link.</p> <p>For example, enter:</p> <pre>primary(config)# failover lan interface faillink</pre>

	Step/Command	Description
Step 8	<code>primary(config)# failover lan key <i>string</i></code>	(Optional) Encrypts the failover communications over the Ethernet link. If you do not enter this command, all failover communications are sent in clear text. Where <i>string</i> is a shared key.
Step 9	<code>primary(config)# failover lan enable</code>	Enables the LAN-based failover link, instead of the default serial failover cable link.
Step 10	<code>primary(config)# failover</code>	Enables failover.
Step 11	<code>primary(config)# write memory</code>	Saves the configuration to Flash memory.

Configuring the Secondary Unit

Follow these steps to configure the secondary unit for LAN-based failover. The only configuration required for the secondary unit is for the failover interface and for LAN failover parameters. The secondary unit requires these commands to initially communicate with the primary unit. After the primary unit sends its configuration to the secondary unit, the only permanent difference between the two configurations is the **failover lan unit** command, which identifies each unit as primary or secondary. Although all other **failover lan** commands are the same on both units, these commands are not replicated from the active unit to the standby unit and must be saved in Flash memory.



Note At any time during the procedure, you can enter the **show failover** command to see the failover status. See the “[Using the Show Failover Command](#)” section for detailed information.

	Step/Command	Description
Step 1	Configure the Ethernet interface you are using for the failover link:	Use the same settings as the primary unit. See “ Configuring the Primary Unit ” for details about the following commands.
a.	<code>secondary(config)# interface hardware_id hardware_speed</code>	Enables the interface. For example: <code>secondary(config)# interface ethernet2 100full</code>
b.	<code>secondary(config)# nameif hardware_id interface_name securitylevel</code>	Names the interface and sets the security level. For example: <code>secondary(config)# nameif ethernet2 faillink security90</code>
c.	<code>secondary(config)# ip address interface_name ip_address [netmask]</code>	Set the IP address to match the IP address on the primary unit. The secondary unit does not use this IP address, but instead uses the failover IP address you set in the next step. However, you must still set the primary IP address. For example: <code>secondary(config)# ip address faillink 192.168.2.1 255.255.255.0</code>

	Step/Command	Description
Step 2	<code>secondary(config)# failover ip address interface_name ip_address</code>	Set the failover IP address to match the failover IP address on the primary unit. You do not need to identify the subnet mask. This secondary unit always uses this IP address for the failover link. For example: <code>secondary(config)# failover ip address faillink 192.168.2.2</code>
Step 3	<code>secondary(config)# failover lan unit secondary</code>	(Optional) Sets this PIX Firewall as the secondary unit. If you do not enter this command, the default is secondary.
Step 4	<code>secondary(config)# failover lan interface interface_name</code>	Identifies the Ethernet interface for the failover link. For example, enter: <code>secondary(config)# failover lan interface faillink</code>
Step 5	<code>secondary(config)# failover lan key string</code>	(Optional) Encrypts the failover communications over the Ethernet link. Use the same key as the one you set for the primary unit. Where <i>string</i> is a shared key.
Step 6	<code>secondary(config)# failover lan enable</code>	Enables the LAN-based failover link.
Step 7	<code>secondary(config)# write memory</code>	Because the failover lan commands are not replicated from the active unit to the standby unit, you should save them in Flash memory.
Step 8	<code>secondary(config)# failover</code>	Enables failover. After you enable failover, the active unit sends the configuration in running memory to the standby unit. As the configuration synchronizes, the messages “Sync Started” and “Sync Completed” appear on the active unit’s console.
Step 9	<code>secondary(config)# write memory</code>	(Optional) After the “Sync Completed” message appears on the active unit, you can save the entire configuration on the standby unit to Flash memory (in addition to the failover lan commands you saved in Step 7).

Verifying the Failover Configuration

This section describes how to verify your failover configuration. This section includes the following topics:

- [Using the Show Failover Command, page 10-17](#)
- [Testing the Failover Functionality, page 10-19](#)

See the “[Monitoring Failover](#)” section for other troubleshooting tools.

Using the Show Failover Command

On each unit, you can verify the failover status by entering:

```
primary(config)# show failover
```

This command shows:

- Whether failover is on or off
- Which unit is active
- The IP addresses assigned for the active and standby units
- The serial cable status
- The LAN cable status
- Stateful Failover statistics



Note

The **show interface** display on the standby unit shows the active IP addresses associated with each interfaces, even though the unit is using the failover IP addresses. Use the **show failover** command to view the actual IP addresses being used.

See the following sample **show failover** command output. A description of each field follows.

```
pix(config)# show failover
Failover On
Serial Failover Cable status: My side not connected
Reconnect timeout 0:00:00
Poll frequency 15 seconds
Last Failover at: 18:32:16 UTC Mon Apr 7 2003
  This host: Primary - Active
    Active time: 510 (sec)
    Interface 4th (172.16.1.1): Normal
    Interface intf2 (192.168.2.1): Normal
    Interface outside (192.168.1.1): Normal
    Interface inside (10.1.1.1): Normal
  Other host: Secondary - Standby
    Active time: 0 (sec)
    Interface 4th (172.16.1.2): Normal
    Interface intf2 (192.168.2.2): Normal
    Interface outside (192.168.1.2): Normal
    Interface inside (10.1.1.2): Normal
Stateful Failover Logical Update Statistics
Link : 4th
Stateful Obj   xmit   xerr   rcv    rerr
General       0      0      0      0
sys cmd       0      0      0      0
up time       0      0      0      0
xlate         0      0      0      0
tcp conn      0      0      0      0
udp conn      0      0      0      0
ARP tbl       0      0      0      0
RIP Tbl       0      0      0      0

Logical Update Queue Information
          Cur    Max    Total
Recv Q:   0     0     0
Xmit Q:   0     0     0

Lan Based Failover is Active
  interface intf3 (192.168.3.1): Normal, peer (192.168.3.2) Normal
```

Table 10-2 Show Failover Display Description

Field	Options
Failover	<ul style="list-style-type: none"> • On • Off
Serial Failover Cable status:	<ul style="list-style-type: none"> • Normal—The cable is connected to both units, and they both have power. • My side not connected—The serial cable is not connected to this unit. It is unknown if the cable is connected to the other unit. • Other side is not connected—The serial cable is connected to this unit, but not to the other unit. • Other side powered off—The other unit is turned off.
Reconnect timeout	Not used.
Poll frequency	<p><i>n</i> seconds</p> <p>The number of seconds you set with the failover poll command. The default is 15 seconds.</p>
Last Failover at:	<p>The date and time of the last failover in the following form:</p> <p><i>hh:mm:ss UTC DayName Month Day yyyy</i></p> <p>UTC (Coordinated Universal Time) is equivalent to GMT (Greenwich Mean Time).</p>
This host: Other host:	For each host, the display shows the following information.
Primary or Secondary	<ul style="list-style-type: none"> • Active • Standby
Active time:	<p><i>n</i> (sec)</p> <p>The amount of time the unit has been active. This time is cumulative, so the standby unit, if it was active in the past, will also show a value.</p>
Interface <i>name (n.n.n.n)</i> :	<p>For each interface, the display shows the IP address currently being used on each unit, as well as one of the following conditions:</p> <ul style="list-style-type: none"> • Failed—The interface has failed. • Link Down—The interface line protocol is down. • Normal—The interface is working correctly. • Shutdown—The interface has been administratively shut down (interface <i>hardware_id</i> shutdown). • Unknown—The firewall cannot determine the status of the interface. • Waiting—Monitoring of the other unit's network interface has not yet started. <p>The LAN failover interface is not included in this list, but is shown at the bottom of the display.</p>

Table 10-2 Show Failover Display Description (continued)

Field	Options
Stateful Failover Logical Update Statistics	The following fields relate to the Stateful Failover feature. If the Link field shows an interface name, the Stateful Failover statistics are shown.
Link	<ul style="list-style-type: none"> <i>interface_name</i>—The interface used for the Stateful Failover link. Unconfigured—You are not using Stateful Failover.
Stateful Obj	For each field type, the following statistics are used: <ul style="list-style-type: none"> xmit—Number of transmitted packets to the other unit xerr—Number of errors that occurred while transmitting packets to the other unit rcv—Number of received packets rerr—Number of errors that occurred while receiving packets from the other unit
General	Sum of all stateful objects.
sys cmd	Logical update system commands; for example, LOGIN and Stay Alive.
up time	Up time, which the active unit passes to the standby unit.
xlate	Translation information.
tcp conn	TCP connection information.
udp conn	Dynamic UDP connection information.
ARP tbl	Dynamic ARP table information.
RIP Tbl	Dynamic router table information.
Logical Update Queue Information	For each field type, the following statistics are used: <ul style="list-style-type: none"> Cur—Current number of packets Max—Maximum number of packets Total—Total number of packets
Recv Q	The status of the receive queue.
Xmit Q	The status of the transmit queue.
Lan-based Failover is Active	This field appears only when LAN-based failover is enabled.
interface name (<i>n.n.n.n</i>): peer (<i>n.n.n.n</i>):	For the LAN failover link, the display shows the IP address currently being used on each unit, as well as the condition of the link. See the preceding interface description for a description of each condition.

Testing the Failover Functionality

Follow these steps to ensure failover works:

-
- Step 1** Power up the standby unit.

- Step 2** Test that your primary (active) unit is passing traffic as expected by using FTP (for example) to send a file between hosts on different interfaces.
- Step 3** Power up the standby unit, and wait for the configuration to sync.
- Step 4** Power down the active unit to force a failover to the standby unit.
- Step 5** Use FTP to send another file between the same two hosts.
- Step 6** If the network test was successful, power on the primary unit. If the test was not successful, enter the **show failover** command to check the failover status.
- Step 7** When you are finished, you can leave the secondary unit as active, or force the primary unit to be active again by entering:
- ```
primary(config)# failover active
```
- 

## Forcing Failover

To force the standby unit to become active, enter:

- On the active unit:  

```
primary(config)# no failover active
```
- On the standby unit:  

```
secondary(config)# failover active
```

## Disabling Failover

You can disable failover by entering the following command on the active unit:

```
primary(config)# no failover
```

This command is replicated to the standby unit, so that it also has failover disabled. To verify that failover is off, enter the **show failover** command:

```
primary(config)# show failover
Failover Off
...
```

To disable the LAN failover link, disable failover and then disable the LAN failover link:

```
primary(config)# no failover
primary(config)# no failover lan enable
```

When you enable failover again, the firewall uses the serial failover cable if connected.

## Monitoring Failover

When a failover occurs, both PIX Firewalls send out syslog messages, and the ACTIVE light on the front of the devices indicate the current state. This section includes the following topics:

- [Failover Syslog Messages, page 10-21](#)
- [SNMP, page 10-21](#)

- [Debugging Command](#), page 10-21
- [ACTIVE Light](#), page 10-21

## Failover Syslog Messages

The PIX Firewall issues a number of syslog messages related to failover at priority level 2, which indicates a critical condition. To view these messages, see the *Cisco PIX Firewall System Log Messages* to enable logging and to see descriptions of the syslog messages. If you search for “failover” on the following web page, you can easily find related messages:

[http://www.cisco.com/univercd/cc/td/doc/product/iaabu/pix/pix\\_sw/v\\_63/63syslog/pixemsgs.htm](http://www.cisco.com/univercd/cc/td/doc/product/iaabu/pix/pix_sw/v_63/63syslog/pixemsgs.htm)

## SNMP

To receive SNMP syslog traps for failover, configure the SNMP agent to send SNMP traps to SNMP management stations, define a syslog host, and compile the Cisco syslog MIB into your SNMP management station. See the **snmp-server** and **logging** command in the *Cisco PIX Firewall Command Reference* for more information.

## Debugging Command

To see debugging messages, enter the **debug fover** command. See the *Cisco PIX Firewall Command Reference* for more information, or see the following URL:

[http://www.cisco.com/univercd/cc/td/doc/product/iaabu/pix/pix\\_sw/v\\_63/cmdref/df.htm#94643](http://www.cisco.com/univercd/cc/td/doc/product/iaabu/pix/pix_sw/v_63/cmdref/df.htm#94643)

## ACTIVE Light

The ACTIVE light on the front of the firewall indicates the unit’s failover state, either active (light is on) or standby (light is off). If you do not enable failover, the ACTIVE light remains on.

## Frequently Asked Failover Questions

This section contains some frequently asked questions about the failover features and includes the following topics:

- [Configuration Replication Questions](#), page 10-22
- [Basic Failover Questions](#), page 10-22
- [Cable-Based Failover Questions](#), page 10-23
- [LAN-Based Failover Questions](#), page 10-24
- [Stateful Failover Questions](#), page 10-24

## Configuration Replication Questions

- Does configuration replication save the configuration to Flash memory on the standby unit?  
No, the configuration is only in running memory.
- How can both units be configured the same without manually entering the configuration twice?  
Commands entered on the active unit are automatically replicated to the standby unit.
- What happens if I enter commands on the standby unit?  
You will see an error message telling you that the configurations are out of sync.  
If you enter individual commands on the active unit that are replicated to the standby unit, your alterations are preserved.  
If you use the **write standby** command on the active unit, it will erase any new commands you entered on the standby unit.
- What happens if I enter the **write memory** command on the active unit?  
The **write memory** command is replicated to the standby unit, which proceeds to write its configuration to Flash memory.
- What happens if the configuration in Flash memory on the secondary unit differs from the configuration on the primary unit?  
After startup, the primary unit sends its configuration to the secondary unit, and erases the secondary unit's running configuration. However, the secondary unit's configuration remains unaltered in Flash memory.
- How can I view the running configuration and the Flash memory configuration?
  - **show running**—Shows the running configuration. You can also enter **write terminal**.
  - **show config**—Shows the configuration in Flash memory.

## Basic Failover Questions

- Which unit becomes active if you restart both units?  
The primary unit.
- What happens if the active unit has a power failure?
  - Cable-based—The standby unit learns immediately of the active power failure, and becomes active.
  - LAN-based—After hello packets are not acknowledged, the standby unit becomes active. There is a slight delay compared to cable-based failover.
- What happens when the formerly active unit comes online again?  
No failover occurs. It remains in standby mode.

- How long does it take to detect a failure?
  - Network errors are detected within two consecutive polling intervals (by default, 15 second intervals). The polling interval is user-configurable using the **failover poll** command.
  - (Cable-based only) Power failure and cable failure is detected immediately.
  - Failover communication errors are detected within two consecutive polling intervals.
- What maintenance is required?

Syslog messages are generated when any errors or switches occur. Evaluate the failed unit and fix or replace it.
- Can you put a router between the PIX Firewall units?

No, all interfaces of the two units must be on the same subnet.
- Is it possible to have both PIX Firewall units become active at the same time?

Yes, in the following rare circumstances:

  - Cable-based failover only
  - The failover link is unplugged at startup
  - Both units have configurations in Flash memory
  - Both units have failover enabled
  - Both units have the UR license

In LAN-based failover, if the failover link is down, the secondary unit uses other interfaces to detect if the primary unit is active, and does not become active itself.
- What prevents the standby unit from passing traffic?

The PIX Firewall failover feature ensures that only traffic aimed *to* the standby unit (hello packets, Telnet if enabled) is successful, while traffic aimed *through* the unit is dropped.

## Cable-Based Failover Questions

- What happens if the cable is disconnected at startup?

The primary unit becomes active. If the primary unit fails, the secondary unit does not become active until the cable is reconnected.

Note that both units can become active in the following rare circumstances:

  - Both units have configurations in Flash memory
  - Both units have failover enabled
  - Both units have the UR license
- What happens if the cable becomes unplugged after startup?

The firewall generates a syslog message but no switching occurs. No failover can occur until the cable is reconnected.

## LAN-Based Failover Questions

- What happens if the failover link is disconnected at startup?

The primary unit becomes active. The secondary unit uses other interfaces to detect if the primary unit is active, and does not become active itself. If the primary unit is not active, then the secondary unit waits a brief period before becoming active.

- What happens if the link goes down between the firewall and the switch after startup?
  - If the active unit's failover interface goes down, it will failover to the standby unit. No additional failovers can occur until the failover interface comes back up again.
  - If the standby unit's failover interface goes down, an error message displays, but no failover occurs. No failover can occur until the cable is reconnected.
- What happens if the failover link is not down, but does not pass traffic (for example, each PIX Firewall is connected to a separate switch and the link between the two switches is down)?

The PIX Firewalls use other interfaces to poll the peer status, but a failover is not triggered. If the units detect other failover triggers, and a failover occurs, no additional failovers can occur until the failover interface comes back up again.

- Can I use a crossover cable?

No, you must use a switch between the two units. We recommend that if your units are closer than 6 feet (which is when you would use a crossover cable), then you should use the serial failover cable. You can use a crossover cable for the state link for Stateful Failover.

## Stateful Failover Questions

- What information is *not* replicated to the standby PIX Firewall on Stateful Failover?
  - The user authentication (uauth) table.
  - The ISAKMP and IPSec SA table.
  - The ARP table.
  - Routing information.
  - Other UDP connections.
- What are Stateful Failover hardware requirements?
  - An Ethernet link dedicated to Stateful Failover.
  - Minimum 100 Mbps full duplex. On a PIX 535 with GE interfaces, you must use a GE interface for the state link.
  - A connection using a crossover cable or a switch.
- Can I share the state link Ethernet interface with the failover link?

Yes, if you are connecting to a switch, and not using a crossover cable. However, we recommend that you use a separate connection.

# Failover Configuration Examples

This section includes sample configurations and network diagrams, and includes the following topics:

- [Cable-Based Failover Example, page 10-25](#)
- [LAN-Based Failover Example, page 10-26](#)

## Cable-Based Failover Example

Figure 10-2 shows the network diagram for a failover configuration using a serial failover cable.

**Figure 10-2 Cable-Based Failover Configuration**

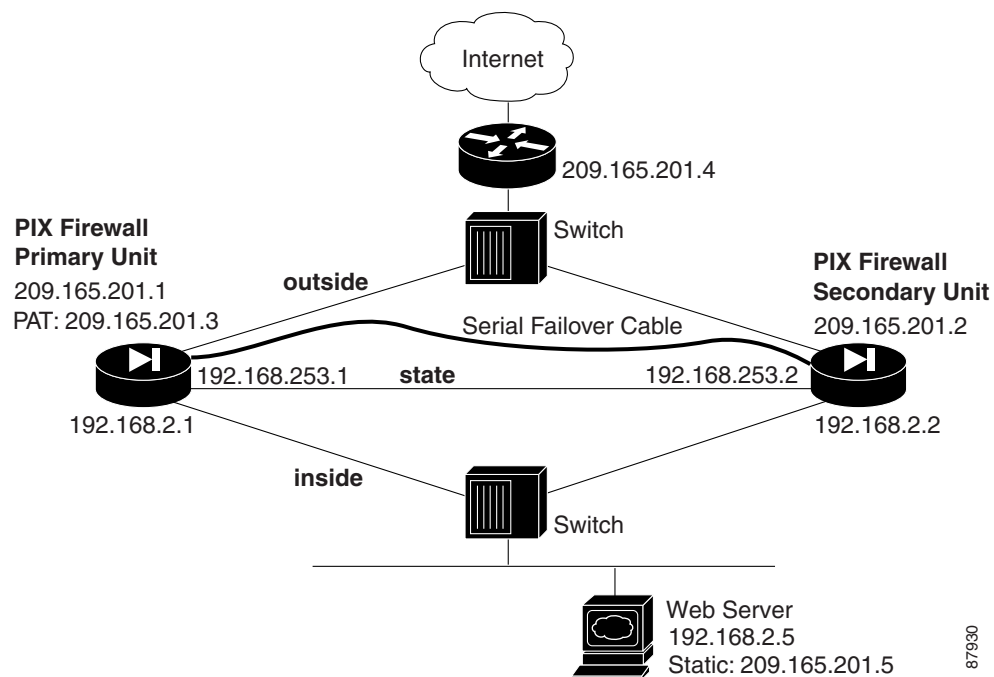

Example 10-1 lists the typical commands in a cable-based failover configuration.

**Example 10-1 Cable-Based Failover Configuration**

```
interface ethernet0 100full
interface ethernet1 100full
interface ethernet2 shutdown
interface ethernet3 100full
nameif ethernet0 outside security0
nameif ethernet1 inside security100
nameif ethernet3 state security20
enable password farscape encrypted
password crichton encrypted
telnet 192.168.2.45 255.255.255.255
hostname pixfirewall
ip address outside 209.165.201.1 255.255.255.224
ip address inside 192.168.2.1 255.255.255.0
ip address state 192.168.253.1 255.255.255.252
failover ip address outside 209.165.201.2
```

```

failover ip address inside 192.168.2.2
failover ip address state 192.168.253.2
failover link state
failover
global (outside) 1 209.165.201.3 netmask 255.255.255.224
nat (inside) 1 0.0.0.0 0.0.0.0 0 0
static (inside,outside) 209.165.201.5 192.168.2.5 netmask 255.255.255.255 0 0
access-list acl_out permit tcp any 209.165.201.5 eq 80
access-group acl_out in interface outside
route outside 0 0 209.165.201.4 1

```

## LAN-Based Failover Example

Figure 10-3 shows the network diagram for a failover configuration using an Ethernet failover link.

**Figure 10-3 LAN-Based Failover Configuration**

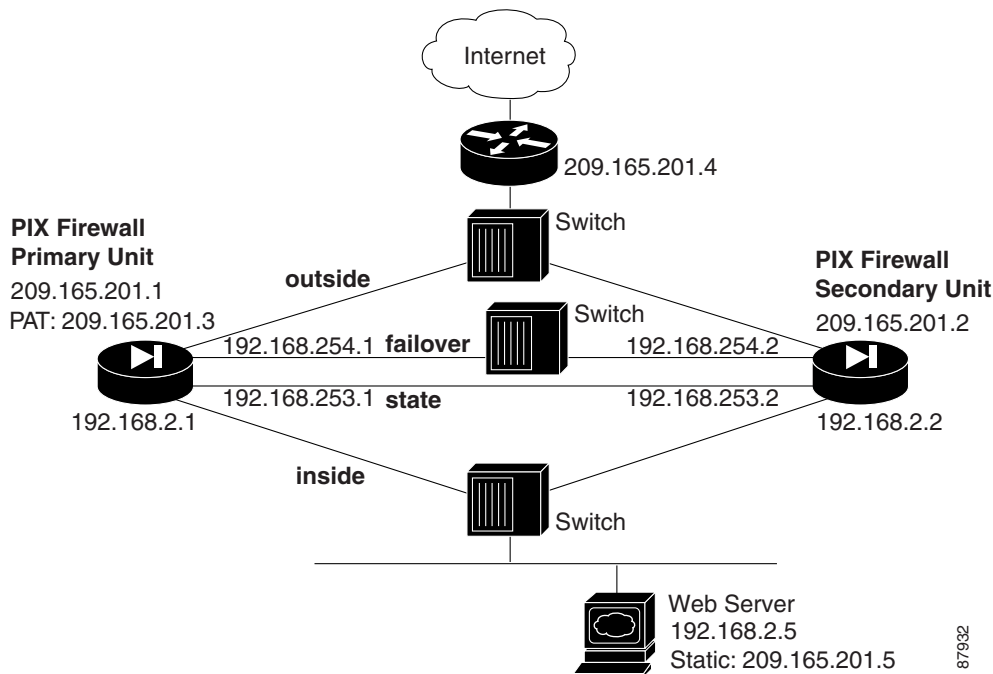

Example 10-2 (primary unit) and Example 10-3 (secondary unit) list the typical commands in a LAN-based failover configuration.

**Example 10-2 LAN-Based Failover Configuration: Primary Unit**

```

interface ethernet0 100full
interface ethernet1 100full
interface ethernet2 100full
interface ethernet3 100full
nameif ethernet0 outside security0
nameif ethernet1 inside security100
nameif ethernet2 failover security10
nameif ethernet3 state security20
enable password farscape encrypted
password crichton encrypted
telnet 192.168.2.45 255.255.255.255

```



```
hostname pixfirewall
ip address outside 209.165.201.1 255.255.255.224
ip address inside 192.168.2.1 255.255.255.0
ip address failover 192.168.254.1 255.255.255.0
ip address state 192.168.253.1 255.255.255.252
failover ip address outside 209.165.201.2
failover ip address inside 192.168.2.2
failover ip address failover 192.168.254.2
failover ip address state 192.168.253.2
failover link state
failover lan unit primary
failover lan interface failover
failover lan key 12345678
failover lan enable
failover
global (outside) 1 209.165.201.3 netmask 255.255.255.224
nat (inside) 1 0.0.0.0 0.0.0.0 0 0
static (inside,outside) 209.165.201.5 192.168.2.5 netmask 255.255.255.255 0 0
access-list acl_out permit tcp any host 209.165.201.5 eq 80
access-group acl_out in interface outside
route outside 0 0 209.165.201.4 1
```

[Example 10-3](#) shows the configuration for the secondary unit.

### **Example 10-3 LAN-Based Failover Configuration: Secondary Unit**

```
interface ethernet2 100full
nameif ethernet2 failover security10
ip address failover 192.168.254.1 255.255.255.0
failover ip address failover 192.168.254.2
failover lan unit secondary
failover lan interface failover
failover lan key 12345678
failover lan enable
failover
```



## Changing Feature Licenses and System Software

---

This chapter describes how to change (upgrade or downgrade) the feature license or software image on your Cisco PIX Firewall. It contains the following sections:

- [Upgrading Your License by Entering a New Activation Key](#)
- [Using HTTP to Copy Software and Configurations](#)
- [Downloading the Current Software](#)
- [Installing and Recovering PIX Firewall Software](#)
- [Downgrading to a Previous Software Version](#)
- [Upgrading Failover Systems from a Previous Version](#)
- [TFTP Download Error Codes](#)

PIX Firewall displays a warning message if the configuration file (stored in Flash memory) is newer than the PIX Firewall software version currently being loaded. This message warns you of the possibility of unrecognized commands in the configuration file. For example, if you install Version 6.0 software when the current version is 6.2, the following message appears at startup:

```
Configuration Compatibility Warning:
The config is from version 6.2(1).
but the image is version 6.0(1).
```

In the message, “config” is the version in Flash memory and “image” is the version you are installing.

**Caution**

---

Before upgrading from a previous version, save your configuration and write down your activation key.

---

# Upgrading Your License by Entering a New Activation Key

This section describes how to upgrade your PIX Firewall license and includes the following topics:

- [Obtaining an Activation Key, page 11-2](#)
- [Entering a New Activation Key, page 11-2](#)
- [Troubleshooting the License Upgrade, page 11-4](#)

## Obtaining an Activation Key

To obtain an activation key, you will need a Product Authorization Key, which you can purchase from your Cisco account representative. After obtaining the Product Authorization Key, register it on the Web to obtain an activation key by performing the following steps:

---

**Step 1** Connect a web browser to one of the following websites (the URLs are case-sensitive):

Use the following website if you are a registered user of Cisco Connection Online:

`http://www.cisco.com/cgi-bin/Software/FormManager/formgenerator.pl`

Use the following website if you are not a registered user of Cisco Connection Online:

`http://www.cisco.com/cgi-bin/Software/FormManager/formgenerator.pl`

**Step 2** Obtain the serial number for your PIX Firewall by entering the following command:

```
show version
```

**Step 3** Enter the following information, when prompted:

- Your Product Authorization Key
- The serial number for your PIX Firewall.
- Your email address.

The activation key will be automatically generated and sent to the email address that you provide.

---

## Entering a New Activation Key

PIX Firewall Version 6.2 or higher provides a method of upgrading or changing the license for your PIX Firewall remotely without entering monitor mode and without replacing the software image. With this feature, you can enter a new activation key for a different PIX Firewall license from the command-line interface (CLI).

Before entering the activation key, ensure that the image in Flash memory and the running image are the same. You can do this by rebooting the PIX Firewall before entering the new activation key.

**Note**

---

You must reboot the PIX Firewall after entering the new activation key for the change to take effect in the running image.

---

To enter an activation key, enter the following command:

```
activation-key activation-key-four-tuple
```

In this command, replace *activation-key-four-tuple* with the activation key you obtained with your new license.

For example:

```
activation-key 0x12345678 0xabcdef01 0x2345678ab 0xcdef01234
```

The leading “0x” hexadecimal indicator is optional. If it is omitted, the parameter is assumed to be a hexadecimal number, as in the following example.

```
activation-key 12345678 abcdef01 2345678ab cdef01234
```

After you enter the activation key, the system displays the following output when the activation key has been successfully changed:

```
pixfirewall(config)# activation-key 0x01234567 0x89abcdef01 0x23456789 0xabcdef01
Serial Number: 12345678 (0xbc614e)
```

```
Flash activation key: 0xyadayada 0xyadayada 0xyadayada 0xyadayada
```

```
Licensed Features:
```

```
Failover: yada
VPN-DES: yada
VPN-3DES: yada
Maximum Interfaces: yada
Cut-through Proxy: yada
Guards: yada
Websense: yada
Throughput: yada
ISAKMP peers: yada
```

```
The flash activation key has been modified.
```

```
The flash activation key is now DIFFERENT than the running key.
```

```
The flash activation key will be used when the unit is reloaded.
```

```
pixfirewall(config)#
```

```

```

As indicated by this message, after entering the new activation key, you must reboot the PIX Firewall to enable the new license.

If you are upgrading the image to a newer version and the activation key is also being changed, reboot the system twice, as shown in the following procedure:

1. Install the new image.
2. Reboot the system.

The newer image can use the old key because all license keys are backward compatible, so the reload should not fail because of a bad activation key.

3. Update the new activation key.
4. Reboot the system.

After the key update is complete, the system is reloaded a second time, so the updated licensing scheme can take effect in a running image.

If you are downgrading an image, you only need to reboot once, after installing the new image. In this situation, the old key is both verified and changed with the current image, then the image can be updated and finally the system is reloaded.

## Troubleshooting the License Upgrade

Table 11-1 lists the messages that the system displays when the activation key has not been changed:

**Table 11-1 Troubleshooting the License Upgrade**

| System Message Displayed                                       | Resolution                                                                                          |
|----------------------------------------------------------------|-----------------------------------------------------------------------------------------------------|
| The activation key you entered is the same as the Running key. | Either the activation key has already been upgraded or you need to enter a different key.           |
| The Flash image and the Running image differ.                  | Reboot the PIX Firewall and reenter the activation key.                                             |
| The activation key is not valid.                               | Either you made a mistake entering the activation key or you need to obtain a valid activation key. |

Problems may occur if an image is copied to Flash memory using the **copy tftp flash:image** command that is not compatible with the activation key in the Flash memory. You may need to use a different activation key and/or install from monitor mode or Boothelper to restore the unit if this happens.

To view your current activation key, enter the following command:

```
show activation-key
```

Example 11-1, Example 11-2, and Example 11-3 show the output from this command under different circumstances.

### Example 11-1 Show activation-key—Flash Key and Image Same as Running

```
pixfirewall(config)# show activation-key
Serial Number: 12345678 (0xbc614e)

Running activation key: 0xe02888da 0x4ba7bed6 0xf1c123ae 0xffd8624e
Licensed Features:
Failover: Enabled
VPN-DES: Enabled
VPN-3DES: Enabled
Maximum Interfaces: 6
Cut-through Proxy: Enabled
Guards: Enabled
Websense: Enabled
Throughput: Unlimited
ISAKMP peers: Unlimited
```

The flash activation key is the SAME as the running key.

### Example 11-2 Show activation-key—Flash Key Differs from Running Key

```
pixfirewall(config)# show activation-key
Serial Number: 12345678 (0xbc614e)
```

```

Running activation key: 0xe02888da 0x4ba7bed6 0xf1c123ae 0xffd8624e
Licensed Features:
Failover: Enabled
VPN-DES: Enabled
VPN-3DES: Enabled
Maximum Interfaces: 6
Cut-through Proxy: Enabled
Guards: Enabled
Websense: Enabled
Throughput: Unlimited
ISAKMP peers: Unlimited

```

```

Flash activation key: 0xyadayada 0xyadayada 0xyadayada 0xyadayada
Licensed Features:
Failover: yada
VPN-DES: yada
VPN-3DES: yada
Maximum Interfaces: yada
Cut-through Proxy: yada
Guards: yada
Websense: yada
Throughput: yada
ISAKMP peers: yada

```

The flash activation key is DIFFERENT than the running key.  
The flash activation key takes effect after the next reload.

### **Example 11-3 Show activation-key—Flash Image Differs from Running Image**

```

pixfirewall(config)# show activation-key
Serial Number: 12345678 (0xbc614e)

Running activation key: 0xe02888da 0x4ba7bed6 0xf1c123ae 0xffd8624e
Licensed Features:
Failover: Enabled
VPN-DES: Enabled
VPN-3DES: Enabled
Maximum Interfaces: 6
Cut-through Proxy: Enabled
Guards: Enabled
Websense: Enabled
Throughput: Unlimited
ISAKMP peers: Unlimited

```

The flash image is DIFFERENT than the running image.  
The two images must be the same in order to examine the flash activation key.

```

pixfirewall(config)#

```

## Using HTTP to Copy Software and Configurations

PIX Firewall Version 6.2 or higher includes an HTTP client that lets you use the **copy** command to retrieve PIX Firewall configurations, software images, or Cisco PIX Device Manager (PDM) software from any HTTP server. This section describes how to do this and includes the following topics:

- [Copying PIX Firewall Configurations, page 11-6](#)
- [Copying a PIX Firewall Image or PDM Software, page 11-6](#)

## Copying PIX Firewall Configurations

To retrieve a configuration from an HTTP server, enter the following command:

```
configure http[s]://[user:password@]location[:port]/pathname
```

SSL will be used when **https** is entered. The *user* and *password* options are used for basic authentication when logging in to the server. The *location* option is the IP address (or a name that resolves to the IP address) of the server. The *port* option specifies the port to contact on the server. It will default to 80 for HTTP and 443 for HTTPS. The *pathname* option is the name of the resource that contains the configuration to retrieve.

## Copying a PIX Firewall Image or PDM Software

To copy a PIX Firewall software image or PDM software from an HTTP server, enter the following command:

```
copy http[s]://[user:password@]location[:port]/pathname flash[:[image | pdm]]
```

SSL will be used when **https** is entered. The *user* and *password* options are used for basic authentication when logging in to the server. The *location* option is the IP address (or a name that resolves to the IP address) of the server. The *port* option specifies the port to contact on the server. It will default to 80 for HTTP and 443 for HTTPS. The *pathname* option is the name of the resource that contains the image or PDM file to copy.

The output of this command is the same as that from the **copy tftp** command. For an image, the success and failure responses, respectively, are as follows:

- Image installed
- Image not installed

## Downloading the Current Software

This section includes the following topics:

- [Getting a TFTP Server, page 11-7](#)
- [Downloading Software from the Web, page 11-7](#)
- [Downloading Software with FTP, page 11-8](#)

If you have a Cisco.com account, you can obtain software from the following website:

<http://www.cisco.com/cgi-bin/tablebuild.pl/pix>

The software available at this website includes the following items (replace *nn* with the latest version available):

- **bhnn.bin**—Lets you create a “Boothelper” installation diskette required to download PIX Firewall software from a TFTP server.



- **pix6nn.bin**—The latest software image. Place this image in the TFTP directory so it can be downloaded to the PIX Firewall unit.
- **pfss512.exe**—Contains the PIX Firewall Syslog Server (PFSS), supported on Windows NT, 2000, or XP. After installation, this receives syslog messages from the PIX Firewall and store them in daily log files. The PIX Firewall sends messages to the PFSS via TCP or UDP and can receive syslog messages from up to 10 PIX Firewall units.
- **rawrite.exe**—A program you use to create a Boothelper diskette for the PIX Firewall.

## Getting a TFTP Server

**Note**

If you are using a PIX Firewall unit that contains a diskette drive, use a “Boothelper” diskette to download the PIX Firewall image with TFTP. If your site has a Cisco router, the use of TFTP is similar to the way you download Cisco IOS software to your router.

You should have a TFTP server to install the PIX Firewall software.

**Note**

If the PIX Firewall hangs during a TFTP file transfer, press **Esc** to abort the TFTP session and return to the command prompt.

Cisco.com account, you can download a TFTP server from Cisco from the Web or by FTP.

You can download the server software from the following website:

<http://www.cisco.com/cgi-bin/tablebuild.pl/tftp>

Follow these steps to download the server by FTP:

- Step 1** Start your FTP client and connect to `ftp.cisco.com`. Use your Cisco.com username and password.
- Step 2** Enter the command `cd /cisco/web/tftp` and use the `ls` command to view the directory contents.
- Step 3** Use the `get` command to copy the TFTP executable file to your directory.

## Downloading Software from the Web

You can obtain PIX Firewall software by downloading it from Cisco’s website or FTP site. If you are using FTP, refer to “[Downloading Software with FTP](#).”

Before downloading software, you need to have a Cisco.com username and password. If you do not have these, register at the following website:

<http://tools.cisco.com/RPF/register/register.do>

Follow these steps to install the latest PIX Firewall software:

- 
- Step 1** Use a network browser, such as Netscape Navigator to access <http://www.cisco.com>.
  - Step 2** If you are a registered Cisco.com user, click **LOGIN** in the upper area of the page. If you have not registered, click **REGISTER** and follow the steps to register.
  - Step 3** After you click **LOGIN**, a dialog box appears requesting your username and password. Enter these and click **OK**.
  - Step 4** Access Cisco.com at <http://www.cisco.com> and log in. Then access the PIX Firewall software downloads at the following website:  
<http://www.cisco.com/cgi-bin/tablebuild.pl/pix>
  - Step 5** Obtain the software you need. If you have a PIX Firewall unit with a diskette drive, obtain the Boothelper binary image file bh512.bin so you can store a PIX Firewall image on a diskette. If you have a PIX 501, PIX 506E, PIX 515E, PIX 525, or PIX 535, you can skip the discussion of the Boothelper diskette.
- 

## Downloading Software with FTP

Before using FTP, you need to have a Cisco.com username and password. If you do not have these, register now at the following website:

<http://tools.cisco.com/RPF/register/register.do>

Once you have registered, set your FTP client for passive mode. If you are not running in passive mode, you can log in and view the Cisco presentation messages, but entering commands will cause your client to appear to suspend execution.

The Windows 95 and Windows NT command line FTP programs do not support passive mode.

Follow these steps to get the most current software with FTP:

- 
- Step 1** Start your FTP client and connect to **ftp.cisco.com**. Use your Cisco.com username and password.
  - Step 2** You can view the files in the main directory by entering the **ls** command.
  - Step 3** Enter the **cd /cisco/ciscosecure/pix** command and then use the **ls** command to view the directory contents.
  - Step 4** Use the **get** command to copy the proper file to your workstation as described at the start of the current section.
  - Step 5** Enter the **cd /cisco/web/tftp** command. Then use the **get** command to copy the TFTP executable file to your directory.
-

# Installing and Recovering PIX Firewall Software

This section contains the following topics:

- [Installing Image Software from the Command Line](#)
- [Using Monitor Mode to Recover the PIX Firewall Image](#)
- [Using Boothelper](#)
- [Downloading an Image with Boothelper](#)

## Installing Image Software from the Command Line

To use TFTP to install a software image from the PIX Firewall command line, enter the following command:

```
copy tftp flash
```

You can use this command with any PIX Firewall running Version 5.1 or higher. When you enter this command, the PIX Firewall prompts for the specific values required to complete the operation. You can also use a colon (:) to take the parameters from the **tftp-command** settings, or you can explicitly specify each parameter. For details, refer to the **copy tftp flash** command in the *Cisco PIX Firewall Command Reference*.



### Caution

Never download a PIX Firewall image earlier than Version 4.4 with TFTP. Doing so will corrupt the PIX Firewall Flash memory unit.

## Using Monitor Mode to Recover the PIX Firewall Image

You can use monitor mode to recover the PIX Firewall image when it has been lost or corrupted and you do not have access to the PIX Firewall command line.



### Note

You must use a 1FE or 4FE card installed in a 32-bit slot for installing image software with monitor mode. You cannot use monitor mode to connect to a TFTP server through a Gigabit Ethernet card, a 4FE-66 card, or a Fast Ethernet card installed in a 64-bit slot.

Perform the following steps to download an image over TFTP using monitor mode:

- Step 1** Immediately after you power on the PIX Firewall and the startup messages appear, send a BREAK character or press the **Esc** (Escape) key.  
The monitor> prompt appears.
- Step 2** If desired, enter a question mark (?) to list the available commands.
- Step 3** Use the **address** command to specify the IP address of the PIX Firewall unit's interface on which the TFTP server resides.
- Step 4** Use the **server** command to specify the IP address of the host running the TFTP server.
- Step 5** Use the **file** command to specify the filename of the PIX Firewall image. In UNIX, the file needs to be world readable for the TFTP server to access it.

- Step 6** If needed, enter the **gateway** command to specify the IP address of a router gateway through which the server is accessible.
- Step 7** If needed, use the **ping** command to verify accessibility. Use the **interface** command to specify which interface the ping traffic should use. If the PIX Firewall has only two interfaces, the monitor mode defaults to the inside interface. If this command fails, fix access to the server before continuing.
- Step 8** Use the **tftp** command to start the download.

An example follows:

```
Rebooting...
PIX BIOS (4.0) #47: Sat May 8 10:09:47 PDT 2001
Platform PIX-525
Flash=AT29C040A @ 0x300

Use BREAK or ESC to interrupt flash boot.
Use SPACE to begin flash boot immediately.
Flash boot interrupted.
0: i8255X @ PCI(bus:0 dev:13 irq:11)
1: i8255X @ PCI(bus:0 dev:14 irq:10)

Using 1: i82558 @ PCI(bus:0 dev:14 irq:10), MAC: 0090.2722.f0b1
Use ? for help.
monitor> addr 192.168.1.1
address 192.168.1.1
monitor> serv 192.168.1.2
server 192.168.1.2
monitor> file pix601.bin
file cdisk
monitor> ping 192.168.1.2
Sending 5, 100-byte 0x5b8d ICMP Echoes to 192.168.1.2, timeout is 4 seconds:
!!!!
Success rate is 100 percent (5/5)
monitor> tftp
tftp pix601.bin@192.168.1.2.....
Received 626688 bytes

PIX admin loader (3.0) #0: Mon Aug 7 10:43:02 PDT 1999
Flash=AT29C040A @ 0x300
Flash version 6.0.1, Install version 6.0.1

Installing to flash
...

```

## Using Boothelper

If your PIX Firewall unit has a diskette drive, you need to obtain the Boothelper binary image file and create a diskette.

This section contains the following topics:

- [Get the Boothelper Binary Image](#)
- [Preparing a Boothelper Diskette with UNIX, Solaris, or LINUX](#)
- [Preparing a Boothelper Diskette on a Windows System](#)

## Get the Boothelper Binary Image

Use the following steps to download the Boothelper binary image:

- 
- Step 1** Log in to Cisco.com and continue to the PIX Firewall software directory, as described in the previous section, “[Downloading Software from the Web](#)” or “[Downloading Software with FTP](#).”
  - Step 2** Download the latest Boothelper image (bh5nn.bin; where nn is the latest version available) from Cisco.com and prepare a diskette as described in the sections that follow.



**Note** The Boothelper installation only supports PIX Firewall Version 5.1, 5.2, 5.3, 6.0, and later. After Boothelper downloads the PIX Firewall image via TFTP, it verifies the checksum of the image. If it is not Version 5.1 or later, it displays the message “Checksum verification on flash image failed” and reboots the PIX Firewall.

---

- Step 3** Download the PIX Firewall software binary image file pix6nn.bin (where nn is the latest version available) from Cisco.com and store this file in a directory accessible by your TFTP server.
- 

## Preparing a Boothelper Diskette with UNIX, Solaris, or LINUX

Follow these steps to prepare a Boothelper diskette:

- 
- Step 1** To prepare a UNIX, Solaris, or LINUX TFTP server to provide an image to the PIX Firewall, edit the inetd.conf file to remove the # (comment character) from the start of the “tftp” statement.
  - Step 2** Determine the process ID of the current inetd process.
  - Step 3** Use the **kill -HUP process\_id** command to kill the process. The process will restart automatically.
  - Step 4** Use the **dd** command to create the Boothelper diskette for the PIX Firewall unit. For example, if the diskette device name is rd0, use the following command.

```
dd bs=18b if=./bh510.bin of=/dev/rd0
```

This command copies the binary file to the output device file with a block size of 18 blocks.



**Note** The diskette may have a name other than rd0 on some UNIX systems.

---

- Step 5** Eject the diskette, insert it in the PIX Firewall diskette drive, and power cycle the unit. Alternately, if available, use your unit’s Reset switch, or enter the reload command from the PIX Firewall console. The PIX Firewall then boots from the new diskette.
-

## Preparing a Boothelper Diskette on a Windows System

Follow these steps to create the Boothelper diskette from a Windows system:

---

**Step 1** Locate an IBM formatted diskette that does not contain useful files. Do not use the PIX Firewall boot diskette that came with your original PIX Firewall purchase—you will need this diskette for system recovery should you need to downgrade versions.

**Step 2** Enter **rawrite** at the MS-DOS command prompt and you are prompted for the name of the .bin binary file, the output device (**a:** or **b:** for a 3.5-inch diskette), and to insert a formatted diskette. A sample **rawrite** session follows.

```
C:\pix> rawrite
RaWrite 1.2 - Write disk file to raw floppy diskette

Enter source file name: bh512.bin
Enter destination drive: a:
Please insert a formatted diskette into drive A: and press -ENTER- :
Number of sectors per track for this disk is 18
Writing image to drive A:. Press ^C to abort.
Track: 78 Head: 1 Sector: 16
Done.
C:\pix>
```

Ensure that the binary filename is in the “8.3” character format (8 characters before the dot; 3 characters after the dot).

**Step 3** When you are done, eject the diskette, insert it in the PIX Firewall diskette drive, and power cycle the unit. Alternately, if available, use your unit’s Reset switch, or enter the reload command from the PIX Firewall console. The PIX Firewall then boots from the new diskette.

---

## Downloading an Image with Boothelper

Follow these steps to use the Boothelper diskette to download an image from a TFTP server:

---

**Step 1** Download a PIX Firewall image from Cisco.com and store it on the host running the TFTP server.

**Step 2** Start the TFTP server on the remote host and point the TFTP server to the directory containing the PIX Firewall image. On the Cisco TFTP Server, access the **View>Options** menu and enter the name of the directory containing the image in the **TFTP server root directory** box.

**Step 3** Connect a console to the PIX Firewall and ensure that it is ready.

**Step 4** Put the Boothelper diskette you prepared in the PIX Firewall and reboot it. When the PIX Firewall starts, the `pixboothelper>` prompt appears.

- Step 5** You can now enter commands to download the binary image from the TFTP server. In most cases, you need only specify the **address**, **server**, and **file** commands, and then enter the **tftp** command to start the download. The commands are as follows:
- If needed, use a question mark (?) or enter the **help** command to list the available commands.
  - Use the **address** command to specify the IP address of the network interface on which the TFTP server resides.
  - Use the **server** command to specify the IP address of the host running the TFTP server.
  - Use the **file** command to specify the filename of the PIX Firewall image.
  - If needed, use the **gateway** command to specify the IP address of a router gateway through which the server is accessible.
  - If needed, use the **ping** command to verify accessibility. If this command fails, fix access to the server before continuing. You can use the **interface** command to specify which interface the ping traffic should use. The Boothelper defaults to the interface 1 (one).
  - Use the **tftp** command to start the download.
- Step 6** After the image downloads, you are prompted to install the new image. Enter **y**.
- Step 7** When you are prompted, enter your activation key.
- Step 8** After you enter your activation key, PIX Firewall prompts you to remove the Boothelper diskette. You have 30 seconds to remove the diskette. During this time you have three options:
- Remove the diskette and reboot the unit with the reboot switch.
  - Use the **reload** command while the diskette is in the unit.
  - After the interval, the PIX Firewall will automatically boot from the Boothelper diskette.

After Boothelper downloads the PIX Firewall image via TFTP, it verifies the checksum of the image. If it is not Version 5.1 or later, it displays the message “Checksum verification on flash image failed” and reboots the PIX Firewall.

Keep the Boothelper diskette available for future upgrades. You will need to repeat these steps whenever you download an image to your PIX Firewall unit. Alternatively, you can use the **copy tftp flash** command to download an image directly from the PIX Firewall command line.

## Downgrading to a Previous Software Version

This section describes how to change the PIX Firewall to an earlier version of the software than the version currently running on your PIX Firewall unit. You can only downgrade the PIX Firewall software if your platform supports the earlier version.



### Note

Always use the most recent version of the PIX Firewall software to take advantage of the latest security features and functionality. Earlier versions of the PIX Firewall will not support the configuration of features introduced in a later version.

To downgrade to an earlier version, enter the following command:

```
flash downgrade version
```

Replace *version* with one of the following values:

- 4.2
- 5.0
- 5.1

You do not need to use the **flash downgrade** command when downgrading to Versions 5.2 or 5.3 from Version 6.1.

## Upgrading Failover Systems from a Previous Version

This section describes how to upgrade PIX Firewall units configured for the failover feature. It includes the following topics:

- [Upgrading Failover Systems Using Monitor Mode, page 11-14](#)
- [Upgrading Failover Systems Using Boothelper, page 11-15](#)
- [Upgrading Failover Systems from the CLI, page 11-14](#)

## Upgrading Failover Systems from the CLI

Complete the following steps to upgrade a PIX Firewall failover set from the CLI:

- 
- Step 1** To copy the new PIX Firewall image to be installed to the flash of the primary PIX Firewall, enter the following command from the CLI of the primary unit:
- ```
copy tftp flash
```
- Step 2** To copy the new PIX Firewall image to be installed to the flash of the secondary PIX Firewall, enter the following command from the CLI of the secondary unit:
- ```
copy tftp flash
```
- Step 3** Once both units have the new image in their flash, power cycle the primary unit, and then in close succession, power cycle the secondary unit.



**Note**

The secondary must be power cycled before the primary begins running the new image. Otherwise, the two units could be running different versions, and this could cause problems.

---

## Upgrading Failover Systems Using Monitor Mode

Complete the following steps for a PIX Firewall without a floppy diskette drive, using TFTP from the monitor mode:

- 
- Step 1** Connect a separate console to the primary unit and one to the secondary unit.
- Step 2** Reload both PIX Firewall units, and bring them to monitor mode.



- Step 3** On the primary unit, use monitor mode TFTP to load the new PIX Firewall image. You will want to save the image to Flash memory and let it boot up. Enter a **show failover** command to ensure everything looks fine.
- Step 4** Repeat Step 3 on the secondary unit.
- Step 5** Once the standby (secondary) unit completes booting and is up, the active (primary) unit will start to synchronize the configuration from the primary unit to the secondary. Wait until the configuration replication is finished, then use the **show failover** command on both PIX Firewall units to ensure the failover is running correctly.

## Upgrading Failover Systems Using Boothelper

Complete the following steps for a PIX Firewall with a floppy diskette drive:

- Step 1** Connect a separate console to the primary unit and one to the secondary unit.
- Step 2** Place the boothelper diskette in the diskette drive of the primary unit and reboot the system. When the PIX Firewall starts, the `pixboothelper>` prompt appears.
- Step 3** As the primary unit reboots, PIX Firewall prompts you to write the image to Flash memory. Before entering a reply, read the next three substeps and be ready to move quickly to complete them. When ready, enter `y` for yes at the prompt.
- Immediately remove the diskette from the primary unit and insert it into the standby unit. Locate the reset button on the front of the standby unit.
  - When the PIX Firewall Cisco banner appears on the primary unit's console, press the reset button on the standby unit to load the new image.
  - On the primary unit, enter the **show failover** command to make sure the primary unit is active and the secondary unit is in standby mode after the upgrade of the primary unit.
- Step 4** Wait for the standby unit to finish booting. Once the standby unit is up, the two units synchronize during which time the primary unit's console does not accept input. On the standby unit, use the **show failover** command to monitor progress. When both PIX Firewall units report Normal, the replication is done.

## TFTP Download Error Codes



### Note

If the PIX Firewall hangs during a TFTP file transfer, press **Esc** to abort the TFTP session and return to the command prompt.

During a TFTP download, if tracing is on, non-fatal errors appear in the midst of dots that display as the software downloads. The error code appears inside angle brackets. [Table 11-2](#) lists the error code values.

For example, random bad blocks appear as follows:

```
....<11>..<11>.<11>.....<11>...
```

Also, tracing will show “A” and “T” for ARP and timeouts, respectively. Receipt of non-IP packets causes the protocol number to display inside parentheses.

**Table 11-2 Error Code Numeric Values**

| <b>Error Code</b> | <b>Description</b>                                                                                                                                                                                           |
|-------------------|--------------------------------------------------------------------------------------------------------------------------------------------------------------------------------------------------------------|
| -1                | Timeout between the PIX Firewall and TFTP server.                                                                                                                                                            |
| 2                 | The packet length as received from the Ethernet device was not big enough to be a valid TFTP packet.                                                                                                         |
| 3                 | The received packet was not from the server specified in the <b>server</b> command.                                                                                                                          |
| 4                 | The IP header length was not big enough to be a valid TFTP packet.                                                                                                                                           |
| 5                 | The IP protocol type on the received packet was not UDP, which is the underlying protocol used by TFTP.                                                                                                      |
| 6                 | The received IP packet's destination address did not match the address specified by the <b>address</b> command.                                                                                              |
| 7                 | The UDP ports on either side of the connection did not match the expected values. This means either the local port was not the previously selected port, or the foreign port was not the TFTP port, or both. |
| 8                 | The UDP checksum calculation on the packet failed.                                                                                                                                                           |
| 9                 | An unexpected TFTP code occurred.                                                                                                                                                                            |
| 10                | A TFTP transfer error occurred.                                                                                                                                                                              |
| -10               | The image filename you specified cannot be found. Check the spelling of the filename and that permissions permit the TFTP server to access the file. In UNIX, the file needs to be world readable.           |
| 11                | A TFTP packet was received out of sequence.                                                                                                                                                                  |

Error codes 9 and 10 cause the download to stop.

## Acronyms and Abbreviations

This appendix lists the acronyms and abbreviations used in this document. Refer to the *Cisco PIX Firewall Command Reference* for information on the commands described in this section.

For more information on acronyms used in this guide, refer to the *Internetworking Terms and Acronyms* guide, which can be viewed online at the following website:

<http://www.cisco.com/univercd/cc/td/doc/cisintwk/ita/index.htm>

**Table A-1 Acronyms and Abbreviations**

| Acronym | Description                                                                                                                                                                                                                                                                                                |
|---------|------------------------------------------------------------------------------------------------------------------------------------------------------------------------------------------------------------------------------------------------------------------------------------------------------------|
| AAA     | authentication, authorization, and accounting.                                                                                                                                                                                                                                                             |
| ABR     | Area Border Router.                                                                                                                                                                                                                                                                                        |
| ACE     | Access Control Entry.                                                                                                                                                                                                                                                                                      |
| ACL     | access control list.                                                                                                                                                                                                                                                                                       |
| AH      | Authentication Header.                                                                                                                                                                                                                                                                                     |
| ARP     | Address Resolution Protocol—A low-level TCP/IP protocol that maps a node's hardware address (called a "MAC" address) to its IP address. Defined in RFC 826. An example hardware address is 00:00:a6:00:01:ba. (The first three groups specify the manufacturer, the rest identify the host's motherboard.) |
| ASBR    | Autonomous System Boundary Router.                                                                                                                                                                                                                                                                         |
| BGP     | Border Gateway Protocol—While PIX Firewall does not support use of this protocol, you can set the routers on either side of the PIX Firewall to use RIP between them and then run BGP on the rest of the network before the routers.                                                                       |
| BOOTP   | Bootstrap Protocol—Lets diskless workstations boot over the network and is described in RFC 951 and RFC 1542.                                                                                                                                                                                              |
| CA      | certification authority.                                                                                                                                                                                                                                                                                   |
| CHAP    | Challenge Handshake Authentication Protocol. Security feature supported on lines using PPP encapsulation that prevents unauthorized access.                                                                                                                                                                |
| CPP     | Combinet Proprietary Protocol.                                                                                                                                                                                                                                                                             |
| chargen | Character Generation—Via TCP, a service that sends a continual stream of characters until stopped by the client. Via UDP, the server sends a random number of characters each time the client sends a datagram. Defined in RFC 864.                                                                        |
| conn    | Connection slot in PIX Firewall—Refer to the <b>xlata</b> command page in the <i>Cisco PIX Firewall Command Reference</i> for more information.                                                                                                                                                            |

Table A-1 Acronyms and Abbreviations (continued)

| Acronym | Description                                                                                                                                                                                                                                                                                                                                                                                                                              |
|---------|------------------------------------------------------------------------------------------------------------------------------------------------------------------------------------------------------------------------------------------------------------------------------------------------------------------------------------------------------------------------------------------------------------------------------------------|
| CPU     | Central Processing Unit.                                                                                                                                                                                                                                                                                                                                                                                                                 |
| CRL     | certificate revocation list.                                                                                                                                                                                                                                                                                                                                                                                                             |
| CTI     | Computer Telephony Integration.                                                                                                                                                                                                                                                                                                                                                                                                          |
| CTIQBE  | Computer Telephony Interface Quick Buffer Encoding.                                                                                                                                                                                                                                                                                                                                                                                      |
| DES     | Data Encryption Standard.                                                                                                                                                                                                                                                                                                                                                                                                                |
| DH      | Diffie-Hellman.                                                                                                                                                                                                                                                                                                                                                                                                                          |
| DHCP    | Dynamic Host Configuration Protocol.                                                                                                                                                                                                                                                                                                                                                                                                     |
| DNS     | Domain Name System—Operates over UDP unless zone file access over TCP is required.                                                                                                                                                                                                                                                                                                                                                       |
| DoS     | Denial of service.                                                                                                                                                                                                                                                                                                                                                                                                                       |
| ECMP    | Equal Cost Multi-Path.                                                                                                                                                                                                                                                                                                                                                                                                                   |
| EEPROM  | Electrically Erasable Programmable Read-Only Memory.                                                                                                                                                                                                                                                                                                                                                                                     |
| EGP     | Exterior Gateway Protocol—While PIX Firewall does not support use of this protocol, you can set the routers on either side of the PIX Firewall to use RIP between them and then run EGP on the rest of the network before the routers.                                                                                                                                                                                                   |
| EIGRP   | Enhanced Interior Gateway Routing Protocol—While PIX Firewall does not support use of this protocol, you can set the routers on either side of the PIX Firewall to use RIP between them and then run EIGRP on the rest of the network before the routers.                                                                                                                                                                                |
| ESP     | Encapsulating Security Payload. Refer to RFC 1827 for more information.                                                                                                                                                                                                                                                                                                                                                                  |
| FDDI    | Fiber Distributed Data Interface—Fiber optic interface.                                                                                                                                                                                                                                                                                                                                                                                  |
| FTP     | File Transfer Protocol.                                                                                                                                                                                                                                                                                                                                                                                                                  |
| gaddr   | Global address—An address set with the <b>global</b> and <b>static</b> commands.                                                                                                                                                                                                                                                                                                                                                         |
| GRE     | Generic routing encapsulation protocol—Commonly used with Microsoft's implementation of PPTP.                                                                                                                                                                                                                                                                                                                                            |
| H.323   | A collection of protocols that allow the transmission of voice data over TCP/IP networks.                                                                                                                                                                                                                                                                                                                                                |
| HSRP    | Hot-Standby Routing Protocol.                                                                                                                                                                                                                                                                                                                                                                                                            |
| HTTP    | Hypertext Transfer Protocol—The service that handles access to the World Wide Web.                                                                                                                                                                                                                                                                                                                                                       |
| HTTPS   | HTTP over SSL.                                                                                                                                                                                                                                                                                                                                                                                                                           |
| IANA    | Internet Assigned Number Authority—Assigns all port and protocol numbers for use on the Internet. You can view port numbers at the following site:<br><a href="http://www.iana.org/assignments/port-numbers">http://www.iana.org/assignments/port-numbers</a><br>You can view protocol numbers at the following site:<br><a href="http://www.iana.org/assignments/protocol-numbers">http://www.iana.org/assignments/protocol-numbers</a> |
| ICMP    | Internet Control Message Protocol—This protocol is commonly used with the <b>ping</b> command. You can view ICMP traces through the PIX Firewall with the <b>debug trace on</b> command. Refer to RFC 792 for more information.                                                                                                                                                                                                          |

**Table A-1 Acronyms and Abbreviations (continued)**

| <b>Acronym</b> | <b>Description</b>                                                                                                                                                                                                                                                                                                     |
|----------------|------------------------------------------------------------------------------------------------------------------------------------------------------------------------------------------------------------------------------------------------------------------------------------------------------------------------|
| IFP            | Internet Filtering Protocol.                                                                                                                                                                                                                                                                                           |
| IGMP           | Internet Group Management Protocol.                                                                                                                                                                                                                                                                                    |
| IGRP           | Interior Gateway Routing Protocol.                                                                                                                                                                                                                                                                                     |
| IKE            | Internet Key Exchange.                                                                                                                                                                                                                                                                                                 |
| IKMP           | Internet Key Management Protocol.                                                                                                                                                                                                                                                                                      |
| IP             | Internet Protocol.                                                                                                                                                                                                                                                                                                     |
| IPCP           | IP Control Protocol. Protocol that establishes and configures IP over PPP.                                                                                                                                                                                                                                             |
| IPinIP         | IP-in-IP encapsulation protocol.                                                                                                                                                                                                                                                                                       |
| IPSec          | IP Security Protocol efforts in the IETF (Internet Engineering Task Force).                                                                                                                                                                                                                                            |
| IRC            | Internet Relay Chat protocol—The protocol that lets users access chat rooms.                                                                                                                                                                                                                                           |
| ISAKMP         | Internet Security Association and Key Management Protocol.                                                                                                                                                                                                                                                             |
| ITU            | International Telecommunication Union.                                                                                                                                                                                                                                                                                 |
| IUA            | Individual User Authentication.                                                                                                                                                                                                                                                                                        |
| JTAPI          | Java TAPI.                                                                                                                                                                                                                                                                                                             |
| KDC            | Key Distribution Center.                                                                                                                                                                                                                                                                                               |
| LSA            | link-state advertisement.                                                                                                                                                                                                                                                                                              |
| L2TP           | Layer Two Tunneling Protocol.                                                                                                                                                                                                                                                                                          |
| laddr          | Local address—The address of a host on a protected interface.                                                                                                                                                                                                                                                          |
| MGCP           | Media Gateway Control Protocol.                                                                                                                                                                                                                                                                                        |
| MD5            | Message Digest 5—An encryption standard for encrypting VPN packets. This same encryption is used with the <b>aaa authentication console</b> command to encrypt Telnet sessions to the console.                                                                                                                         |
| MIB            | Management Information Base—Used with SNMP.                                                                                                                                                                                                                                                                            |
| MPPE           | Microsoft Point-To-Point Encryption.                                                                                                                                                                                                                                                                                   |
| MS-CHAP        | Microsoft CHAP (Challenge Handshake Authentication Protocol). See “CHAP” for more information.                                                                                                                                                                                                                         |
| MSRPC          | Microsoft Remote Procedure Call.                                                                                                                                                                                                                                                                                       |
| MTU            | maximum transmission unit—The maximum number of bytes in a packet that can flow efficiently across the network with best response time. For Ethernet, the default MTU is 1500 bytes, but each network can have different values, with serial connections having the smallest values. The MTU is described in RFC 1191. |
| NAT            | Network Address Translation.                                                                                                                                                                                                                                                                                           |
| NBMA           | nonbroadcast multiaccess.                                                                                                                                                                                                                                                                                              |
| NetBIOS        | Network Basic Input Output System—An application programming interface (API) that provides special functions for PCs in local-area networks (LANs).                                                                                                                                                                    |
| NIC            | Network Information Center.                                                                                                                                                                                                                                                                                            |
| NNTP           | Network News Transfer Protocol—News reader service.                                                                                                                                                                                                                                                                    |
| NOS            | Network Operating System.                                                                                                                                                                                                                                                                                              |

**Table A-1 Acronyms and Abbreviations (continued)**

| <b>Acronym</b> | <b>Description</b>                                                                                                                                                                                    |
|----------------|-------------------------------------------------------------------------------------------------------------------------------------------------------------------------------------------------------|
| NSSA           | not so stubby area.                                                                                                                                                                                   |
| NTP            | Network Time Protocol—Set system clocks via the network.                                                                                                                                              |
| NVT            | Network virtual terminal.                                                                                                                                                                             |
| OSPF           | Open Shortest Path First protocol.                                                                                                                                                                    |
| PAP            | Password Authentication Protocol. Authentication protocol that lets PPP peers authenticate one another.                                                                                               |
| PAT            | Port Address Translation.                                                                                                                                                                             |
| PDM            | PIX Device Manager.                                                                                                                                                                                   |
| PFS            | perfect forward secrecy.                                                                                                                                                                              |
| PFSS           | PIX Firewall Syslog Server.                                                                                                                                                                           |
| PIM            | Protocol Independent Multicast.                                                                                                                                                                       |
| PIM-SM         | PIM sparse mode.                                                                                                                                                                                      |
| PIX            | Private Internet Exchange.                                                                                                                                                                            |
| PKI            | Public Key Infrastructure.                                                                                                                                                                            |
| POP            | Post Office Protocol.                                                                                                                                                                                 |
| PPPoE          | Point-to-Point Protocol over Ethernet.                                                                                                                                                                |
| PPP            | Point-to-Point Protocol. Provides PIX Firewall-to-router and host-to-network connections over synchronous and asynchronous circuits.                                                                  |
| PPTP           | Point-to-Point Tunneling Protocol. RFC 2637 describes the PPTP protocol.                                                                                                                              |
| RA             | registration authority.                                                                                                                                                                               |
| RADIUS         | Remote Authentication Dial-In User Service—User authentication server specified with the <b>aaa-server</b> command.                                                                                   |
| RAS            | The registration, admission, and status protocol. Provided with H.323 support.                                                                                                                        |
| RC4            | RC4 is stream cipher designed by Rivest for RSA Data Security, Inc. It is a variable key-size stream cipher with byte-oriented operations. The algorithm is based on the use of a random permutation. |
| RFC            | Request For Comment—RFCs are the defacto standards of networking protocols.                                                                                                                           |
| RIP            | Routing Information Protocol.                                                                                                                                                                         |
| RPC            | Remote Procedure Call.                                                                                                                                                                                |
| RSA            | Rivest, Shamir, and Adelman. RSA is the trade name for RSA Data Security, Inc.                                                                                                                        |
| RTP            | Real-Time Transport Protocol.                                                                                                                                                                         |
| RTCP           | RTP Control Protocol.                                                                                                                                                                                 |
| RTSP           | Real Time Streaming Protocol.                                                                                                                                                                         |
| SA             | security association.                                                                                                                                                                                 |
| SCCP           | Simple (Skinny) Client Control Protocol.                                                                                                                                                              |
| SDP            | Session Description Protocol.                                                                                                                                                                         |
| SIP            | Session Initiation Protocol.                                                                                                                                                                          |

**Table A-1 Acronyms and Abbreviations (continued)**

| <b>Acronym</b> | <b>Description</b>                                                                                                                                                                                                                  |
|----------------|-------------------------------------------------------------------------------------------------------------------------------------------------------------------------------------------------------------------------------------|
| SSH            | Secure Shell.                                                                                                                                                                                                                       |
| SMR            | Stub Multicast Routing.                                                                                                                                                                                                             |
| SMTP           | Simple Mail Transfer Protocol—Mail service. The <b>fixup protocol smtp</b> command enables the Mail Guard feature. The PIX Firewall Mail Guard feature is compliant with both the RFC 1651 EHLO and RFC 821 section 4.5.1 commands. |
| SNMP           | Simple Network Management Protocol—Set attributes with the <b>snmp-server</b> command.                                                                                                                                              |
| SPC            | Shared Profile Component.                                                                                                                                                                                                           |
| SPI            | Security Parameter Index—A number which, together with a destination IP address and security protocol, uniquely identifies a particular security association.                                                                       |
| SQL*Net        | SQL*Net is a protocol Oracle uses to communicate between client and server processes. (SQL stands for Structured Query Language.)                                                                                                   |
| SUA            | Secure Unit Authentication.                                                                                                                                                                                                         |
| SYN            | Synchronize sequence numbers flag in the TCP header.                                                                                                                                                                                |
| TACACS+        | Terminal Access Controller Access Control System Plus.                                                                                                                                                                              |
| TAPI           | Telephony Application Programming Interface.                                                                                                                                                                                        |
| TSP            | TAPI Service Provider.                                                                                                                                                                                                              |
| TCP            | Transmission Control Protocol. Refer to RFC 793 for more information.                                                                                                                                                               |
| TurboACL       | Turbo Access Control List—A feature introduced with PIX Firewall version 6.2 that improves the performance of large ACLs.                                                                                                           |
| TFTP           | Trivial File Transfer Protocol.                                                                                                                                                                                                     |
| Triple DES     | Triple Data Encryption Standard. Also known as 3DES.                                                                                                                                                                                |
| uauth          | User authentication.                                                                                                                                                                                                                |
| UDP            | User Datagram Protocol.                                                                                                                                                                                                             |
| URL            | Universal Resource Locator.                                                                                                                                                                                                         |
| UUIE           | user-user information element.                                                                                                                                                                                                      |
| VLAN           | virtual LAN.                                                                                                                                                                                                                        |
| VoIP           | Voice over IP.                                                                                                                                                                                                                      |
| VPDN           | virtual private dial-up network.                                                                                                                                                                                                    |
| VPN            | Virtual Private Network.                                                                                                                                                                                                            |
| VTP            | VLAN Trunking Protocol.                                                                                                                                                                                                             |
| WWW            | World Wide Web.                                                                                                                                                                                                                     |
| Xauth          | extended authentication.                                                                                                                                                                                                            |
| XDMCP          | X Display Manager Control Protocol.                                                                                                                                                                                                 |
| xlate          | Translation slot in PIX Firewall.                                                                                                                                                                                                   |





## Configuration Examples for Other Remote Access Clients

---

This appendix describes different scenarios and examples of using PIX Firewall with different remote access clients and configuration options. It includes the following sections:

- [Xauth with RSA Ace/Server and RSA SecurID, page B-1](#)
- [L2TP with IPsec in Transport Mode, page B-8](#)
- [Windows 2000 Client with IPsec and L2TP, page B-11](#)
- [Using Cisco VPN Client Version 1.1, page B-16](#)

### Xauth with RSA Ace/Server and RSA SecurID

This section contains the following topics:

- [Terminology, page B-1](#)
- [Introduction, page B-2](#)
- [PIX Firewall Configuration, page B-3](#)
- [SecurID with Cisco VPN Client Version 3.x, page B-4](#)
- [SecurID with Cisco VPN 3000 Client Version 2.5, page B-5](#)
- [SecurID with Cisco Secure VPN Client Version 1.1 \(3DES\), page B-7](#)

### Terminology

**ACE/Server:** AAA server from RSA security.

**ACE/Agent:** A software program that makes it possible for workstations and third-party devices such as communication servers and firewalls to be clients of an ACE/Server.

**RSA SecurID:** Provides strong, two-factor authentication using tokens in conjunction with the RSA ACE/Server.

**Token:** Usually refers to a handheld device, such as an RSA SecurID Standard Card, Key Fob, or Pinpad Card that display a value called tokencode. User password, RSA SecurID Smart Cards, and Software Tokens are token types with individual characteristics. The token is one of the factors in the RSA SecurID authentication system. The other factor is the user's PIN.

**Tokencode:** The code displayed by the token. The tokencode along with the PIN make up the RSA SecurID authentication system.

**PIN:** The user's personal identification number.

**Two-Factor authentication:** The authentication method used by the RSA ACE/Server system in which the user enters a secret PIN (personal identification number) and the current code generated by the user's assigned SecurID token.

**PASSCODE:** The PIN and the tokencode make up the PASSCODE.

**Token Mode:** The state the token is in. The token can be Enabled, Disabled, or be in the New PIN Mode, Next Tokencode Mode.

**New PIN mode:** When the server puts a token in this mode, the user is required to receive or create a new PIN to gain access to an RSA SecurID-protected system.

**Next Tokencode mode:** When the user attempts authentication with a series of incorrect PASSCODEs, the server puts the token in this mode so that the user, after finally entering the correct code, is prompted for another tokencode before being allowed access.

**Pinpads:** A SecurID hardware token that allows entering the PIN via a Pinpad and displays the tokencode in an LCD display.

**Key Fobs:** Another form of SecurID hardware token, that displays the current tokencode.

**Software Token:** A software token is similar to the Pinpad, which can be installed on the user's machine.

## Introduction

The RSA Ace/Server and RSA SecurID combination can be used to provide authentication for the Cisco VPN Client Version 3.x, the Cisco VPN 3000 Client Version 2.5, and the Cisco Secure VPN Client Version 1.1, which are supported by PIX Firewall. SecurID provides a token-based authentication method in the form of Software Tokens, Pinpads, or Key Fobs. The user is assigned a token and uses that value from the token, called the tokencode, for authentication. A PIN is used along with the tokencode to obtain the Passcode.

The different modes that a token can use are:

- Enabled.
- Next Tokencode mode.
- New PIN mode.

The PIN length and type are as defined in the system parameters of the ACE/Server, and some parameters can also be set on a per-user basis. When a token is assigned, it is enabled and is in a New PIN mode. The PIN could be pre-assigned, or the RSA ACE/Server configuration can decide who can create that PIN. The options for PINs are as follows:

- User-created PINs allowed
- User-created PINs required

These options can also be decided on a per-user basis by selecting the appropriate check box on the **Edit User** panel provided by the ACE/Server master database administration tool.

The "User-created PINs allowed" option provides a choice between the system generating the PIN, and then providing it to the user, or the user selecting the PIN.

The "User-created PINs required" option requires the user to select the PIN.

## PIX Firewall Configuration

Following is a sample configuration that is necessary for using token-based Xauth by the PIX Firewall for the VPN clients using RSA ACE/Server and RSA SecurID as the AAA server to establish a secure connection.

**Step 1** Create a pool of IP addresses for your clients to use:

```
ip local pool mypool 3.3.48.100-3.3.48.200
```

**Step 2** Create the RADIUS servers:

```
aaa-server partner-auth protocol radius
aaa-server partner-auth (inside) host 10.100.48.43 MYSECRET timeout 20
```



**Note** The word “partner-auth” in the **aaa-server** command in Step 2 is a keyword that needs to match the keyword in the following **crypto map** command.

**Step 3** Create an ISAKMP policy and define the hash algorithm:

```
crypto ipsec transform-set myset esp-des esp-sha-hmac
crypto dynamic-map mydynmap 10 set transform-set myset
crypto map newmap 10 ipsec-isakmp dynamic mydynmap
crypto map newmap client configuration address initiate
crypto map newmap client configuration address respond
crypto map newmap client token authentication partner-auth
```



**Note** The word “token” in the **crypto map newmap client token authentication partner-auth** command is optional for the Cisco VPN Client Version 3.x, and the Cisco Secure VPN Client Version 1.1.

```
crypto map newmap interface outside
isakmp enable outside
isakmp key mysecretkey address 0.0.0.0 netmask 0.0.0.0
isakmp identity hostname
isakmp client configuration address-pool local mypool outside
isakmp policy 10 authentication pre-share
isakmp policy 10 encryption des
isakmp policy 10 hash sha
isakmp policy 10 group 1
isakmp policy 10 lifetime 86400
```

**Step 4** For the Cisco VPN Client Version 3.x, you may need to change the existing IKE/ISAKMP policy or add another policy depending on the requirements, using the following command:

```
isakmp policy policy number vpngroup 2
```

**Step 5** For the Cisco VPN 3000 Client Version 2.5 and the Cisco VPN Client Version 3.x, the **vpngroup** command configuration is also required:

```
vpngroup Cisco address-pool mypool
vpngroup Cisco dns-server 10.100.48.44
vpngroup Cisco wins-server 10.100.48.45
vpngroup Cisco default-domain Cisco.com
vpngroup Cisco split-tunnel myaccesslist
vpngroup Cisco password mysecretkey
```

## SecurID with Cisco VPN Client Version 3.x

This section describes how to use the Cisco VPN Client Version 3.x in the three token modes. It contains the following topics:

- [Token Enabled, page B-4](#)
- [Next Tokencode Mode, page B-4](#)
- [New PIN Mode, page B-5](#)

### Token Enabled

When a connection is being established to the PIX Firewall with the Cisco VPN Client Version 3.x, the user is prompted to enter the username and the password.

Enter the PIN in the **Software Token** dialog box or on the Pinpad, and enter the password in the box indicated for the password entry (see [Figure B-1](#)).

**Figure B-1 Software Token Dialog Box—Cisco VPN Client Version 3**



### Next Tokencode Mode

If the user enters an incorrect password, then the token status is changed to the Next Tokencode mode. In this case, when the user tries to connect the next time, and enters a correct password in the first **Software Token** dialog box, and then another **Software Token** dialog box appears, prompting the user to enter the next tokencode.

## New PIN Mode

This mode is seen when the user is first assigned a token and needs to connect before a PIN can be assigned or created by the user (Case 1), or if for some reason the administrator puts the token in the New PIN Mode (Case 2).

Case 1: User has no previous PIN or the PIN has been cleared.

In this case, enter the value that is currently being displayed on the token in the prompt that requests the username and password.

Case 2: User has an existing PIN and needs to change it.

In this case, enter the PIN in the **Software Token** dialog box or on the Pinpad, and use the value thus obtained as the password in the **User Authentication** dialog box that requests the username and password.

The next prompt, in either case, is for the New PIN. If the user is configured for user-created PIN allowed, enter **y** if the user wants the system to generate the PIN. In this case, the system sends the PIN in the next prompt to the client. If **n** is entered, the user is prompted to select the PIN. If the user is configured for user-created PIN required, then the prompt requests that the user select the PIN.

The next prompt requires the user to enter the password using the new PIN. Enter the newly created PIN in the **Software Token** dialog box or Pinpad and use the value thus obtained.

For a system generated PIN:

A **y** should be entered at this point. The server then sends a PIN message to the user. Enter the next tokencode using the new PIN.

The user creates the PIN, or the user is required to create the PIN if the user enters **n** in the prompt that asks whether the system should generate the PIN or when the user is required to create the PIN.

After the PIN is entered, and is accepted by the server, another **Software Token** dialog box appears.

Enter the next tokencode, using the new PIN, in the **Software Token** dialog box.

## SecurID with Cisco VPN 3000 Client Version 2.5

This section describes how to use the Cisco VPN 3000 Client Version 2.5 in the three token modes. It includes the following topics:

- [Token Enabled, page B-6](#)
- [Next Tokencode Mode, page B-6](#)
- [New PIN Mode, page B-6](#)

## Token Enabled

When a connection is being established to the PIX Firewall, the user is prompted to enter the username and passcode. The client can recognize that a Software Token has been installed on Windows NT systems (provided the Token Software is installed), such that if the PIN is entered, then the passcode is automatically obtained by the client Software Token, and is sent to the AAA server through the PIX Firewall. With a Pinpad, or on operating systems other than Windows NT, the prompt requests a username and passcode. Enter the PIN on the Pinpad or in the **Software Token** dialog box and use the passcode displayed on the token (See [Figure B-2](#)).

**Figure B-2 Software Token Dialog Box—Cisco VPN 3000 Client Version 2.5**



## Next Tokencode Mode

If the user enters an incorrect passcode or PIN, the token status is changed to the Next Tokencode mode. In this case, when the user tries to connect the next time, and enters a correct passcode in the first prompt, another prompt requests the user to enter the next tokencode.

## New PIN Mode

This mode is seen when the user is first assigned a token and needs to connect before a PIN can be assigned or created by the user (Case 1), or if, for some reason, the administrator puts the token in the New PIN Mode (Case 2).

Case 1: User has no PIN's previously assigned or the PIN has been cleared.

In this case, enter the value that is currently being displayed in the **SecurID** message box.

Case 2: User has an existing PIN and needs to change it.

In this case, enter the PIN in the **Software Token** dialog box or on the Pinpad and use the value thus obtained as the passcode when prompted for username and passcode. On a Windows NT operating system, enter the username and PIN instead of passcode.

The next prompt, in either case, is for the new PIN. If the user is configured for user-created PIN required, the prompt requests that the user select the PIN.

The prompt following thereafter requires the user to enter the passcode using the new PIN. Use the newly created PIN on the **Software Token** dialog box or on the Pinpad and use the value thus obtained. On a Windows NT operating system, enter the new PIN in the **SecurID New Pin Mode** dialog box.



#### Note

Only the user-created PIN required option works on the Cisco VPN 3000 Client.

The next prompt requests that the user enter the next tokencode using the new PIN.

## SecurID with Cisco Secure VPN Client Version 1.1 (3DES)

This section provides a reference for using the Cisco Secure VPN Client Version 1.1 in the three token modes. It includes the following topics:

- [Token Enabled, page B-7](#)
- [Next Tokencode Mode, page B-8](#)
- [New PIN Mode, page B-8](#)

### Token Enabled

When a connection is being established to the PIX Firewall with the Cisco Secure VPN Client Version 1.1, the user is prompted to enter the username and the password. Enter the PIN in the **Software Token** dialog box or on the Pinpad, and enter the password in the box indicated for the password entry (see [Figure B-3](#)).

**Figure B-3 Software Token Dialog Box—Cisco Secure VPN Client Version 1.1**

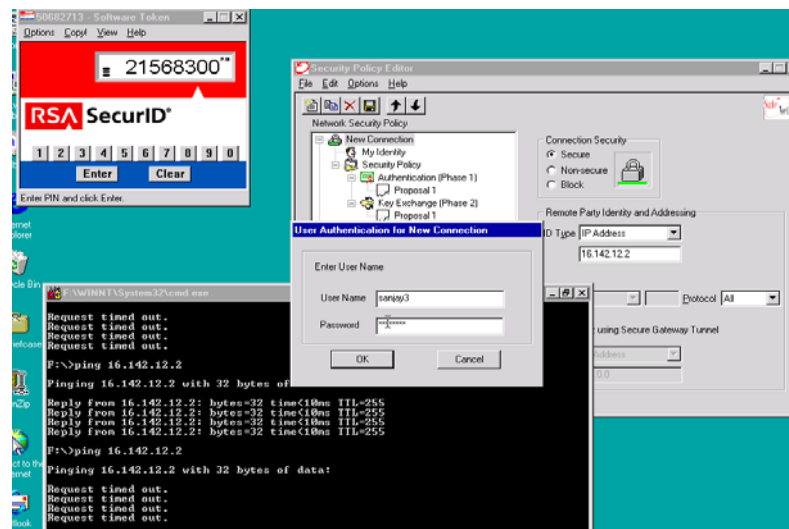

## Next Tokencode Mode

If the user enters an incorrect passcode, then the token status is changed to the Next Tokencode mode. In this case, when the user tries to connect the next time, and enters a correct password in the first **Software Token** dialog box, another **Software Token** dialog box appears, prompting the user to enter the next tokencode.

## New PIN Mode

This mode is seen when the user is first assigned a token and needs to connect before a PIN can be assigned or created by the user (Case 1), or if for some reason the administrator puts the token in the New PIN Mode (Case 2).

Case 1: User has no PINs previously assigned, or the PIN has been cleared.

In this case, enter the value that is currently being displayed in the **Software Token** dialog box that requests a username and password.

Case 2: User has an existing PIN and needs to change it.

In this case, enter the PIN in the **Software Token** dialog box or on the Pinpad, and use the value thus obtained as the password.

The next prompt, in either case, is for the new PIN. If the user is configured for user-created PIN allowed, enter **y** if the user wants the system to generate the PIN. The system sends the PIN in the next prompt to the client. If **n** is entered, the user is prompted to select the PIN. If the user is configured for user-created PIN required, then the prompt requests the user to select the PIN.

The next prompt requires the user to enter the password using the new PIN. Enter the newly created PIN in the **Software Token** dialog box or on the Pinpad, and use the value thus obtained.

1. For the system generated PIN:

When a **y** is entered, the system sends the PIN and requires the user to use the PIN to enter the next tokencode.

2. The user creates the PIN, or a user-created PIN is required. When **n** is entered in the **Generate PIN** dialog box, or if the user is required to generate the PIN, the **User Authentication for New Connection** dialog box appears.

Once the user enters the PIN and it is accepted by the server, the following **Software Token** dialog box appears. Enter the next tokencode using the new PIN.

## L2TP with IPSec in Transport Mode

This section describes how to use IPSec in transport mode to enable L2TP. It includes the following topics:

- [L2TP Overview, page B-9](#)
- [IPSec Transport and Tunnel Modes, page B-9](#)
- [Configuring L2TP with IPSec in Transport Mode, page B-10](#)

For an L2TP configuration example, see “[Xauth with RSA Ace/Server and RSA SecurID.](#)”



## L2TP Overview

Layer 2 Tunneling Protocol (L2TP) is a VPN tunneling protocol which allows remote clients to use the public IP network to securely communicate with private corporate network servers. L2TP uses PPP over UDP (port 1701) to tunnel the data. L2TP protocol is based on the client/server model. The function is divided between the L2TP Network Server (LNS), and the L2TP Access Concentrator (LAC). The LNS typically runs on a network gateway such as a router, while the LAC can be a dial-up Network Access Server (NAS), or a PC with a bundled L2TP client such as Microsoft Windows 2000.

PIX Firewall with L2TP/IPsec support provides the capability to deploy and administer an L2TP VPN solution alongside the IPsec VPN and PIX Firewall services in a single platform. To implement L2TP, perform the following steps:

1. Configure IPsec transport mode to enable IPsec with L2TP.
2. Configure L2TP with a virtual private dial-up network VPDN group.

The primary benefit of configuring L2TP with IPsec in a remote access scenario is that remote users can access a VPN over a public IP network without a gateway or a dedicated line, enabling remote access from virtually anywhere with POTS. An additional benefit is that the only client requirement for VPN access is the use of Windows 2000 with Microsoft Dial-Up Networking (DUN). No additional client software, such as Cisco VPN client software, is required.

The configuration of L2TP with IPsec supports certificates using the pre-shared keys or RSA signature methods, and the use of dynamic (as opposed to static) crypto maps. This summary of tasks assumes completion of IKE, as well as pre-shared keys or RSA signature configuration. See [“Xauth with RSA Ace/Server and RSA SecurID”](#) for the steps to configure pre-shared keys, RSA, and dynamic crypto maps.

**Note**

L2TP with IPsec, as introduced with PIX Firewall Version 6.0, allows the L2TP LNS to interoperate with the Windows 2000 L2TP client. Interoperability with LACs from Cisco and other vendors is currently not supported. Only L2TP with IPsec is supported, native L2TP itself is not supported on PIX Firewall.

If the PIX Firewall IPsec lifetime is set to less than 300 seconds, then the Windows 2000 client ignores it and replaces it with a 300 second lifetime because the minimum IPsec lifetime supported by the Windows 2000 client is 300 seconds.

## IPsec Transport and Tunnel Modes

IPsec can be configured in tunnel mode or transport mode. In IPsec tunnel mode, the entire original IP datagram is encrypted, and it becomes the payload in a new IP packet. This mode allows a network device, such as a router, to act as an IPsec proxy. That is, the router performs encryption on behalf of the hosts. The source router encrypts packets and forwards them along the IPsec tunnel. The destination router decrypts the original IP datagram and forwards it on to the destination system. The major advantage of tunnel mode is that the end systems do not need to be modified to receive the benefits of IPsec. Tunnel mode also protects against traffic analysis; with tunnel mode, an attacker can only determine the tunnel endpoints and not the true source and destination of the tunneled packets, even if they are the same as the tunnel endpoints.

In IPsec transport mode, only the IP payload is encrypted, and the original IP headers are left intact. (See [Figure B-4](#).) This mode has the advantage of adding only a few bytes to each packet. It also allows devices on the public network to see the final source and destination of the packet. With this capability, you can enable special processing (for example, QoS) on the intermediate network based on the

information in the IP header. However, the Layer 4 header will be encrypted, limiting the examination of the packet. Unfortunately, transmitting the IP header in clear text, transport mode allows an attacker to perform some traffic analysis.

**Figure B-4** IPSec in Tunnel and Transport Modes

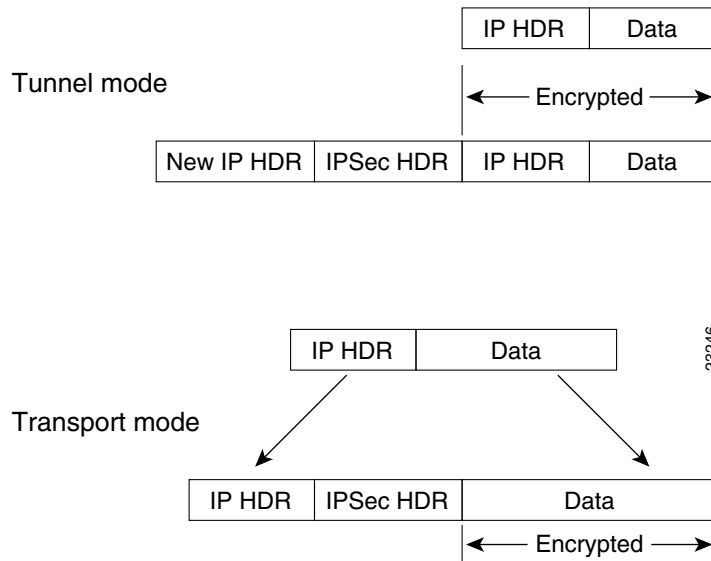

Windows 2000 uses IPsec transport mode when tunneling L2TP data. Transport mode should be configured on the PIX Firewall to receive the L2TP IPsec transport mode data from a Windows 2000 client.

## Configuring L2TP with IPsec in Transport Mode

To configure L2TP with IPsec in transport mode, perform the following steps:

- 
- Step 1** Specify IPsec to use transport mode rather than tunnel mode:  

```
crypto ipsec transform-set trans_name mode transport
```
  - Step 2** Allow L2TP traffic to bypass conduit/access list checking:  

```
sysopt connection permit-ipsec
sysopt connection permit-l2tp
```
  - Step 3** Instruct the PIX Firewall to accept L2TP dial-in requests:  

```
vpdn group group_name accept dial-in l2tp
```
  - Step 4** Specify PPP protocol and authentication protocol (PAP, CHAP, or MS-CHAP):  

```
vpdn group group_name ppp authentication pap/chap/mschap
```
  - Step 5** Specify the local address pool used to allocate the IP address to the client:  

```
vpdn group group_name client configuration address local address_pool_name
```
  - Step 6** (Optional) Instruct the PIX Firewall to send DNS server IP addresses to the client:  

```
vpdn group group_name client configuration dns dns_server_ip1 dns_server_ip2
```

**Step 7** (Optional) Instruct the PIX Firewall to send WINS server IP addresses to the client:

```
vpdn group group_name client configuration wins wins_server_ip1 wins_server_ip2
```

**Step 8** Specify authentication using the PIX Firewall local username/password database. If set to aaa, authenticate using the AAA server.

```
vpdn group group_name client authentication aaa aaa_server_tag
or
vpdn group group_name client authentication local
```

**Step 9** (Optional) Generate a AAA accounting start and stop record for an L2TP (and PPTP) session:

```
vpdn group group_name client accounting aaa_server_tag
```

**Step 10** If local authentication is used, the following command specifies username/password entries:

```
vpdn username username password password
```

**Step 11** (Optional) Specify the L2TP keep-alive/hello timeout value:

```
vpdn group_name l2tp tunnel hello hello timeout
```

The default timeout value is 60, and the lower and upper limits are 10 and 300, respectively.

**Step 12** Enable **vpdn** function on a PIX Firewall interface:

```
vpdn enable ifname
```

---

## Windows 2000 Client with IPSec and L2TP

This section provides an example of how to configure the PIX Firewall for interoperability with a Windows 2000 client. It includes the following topics:

- [Overview, page B-12](#)
- [Configuring the PIX Firewall, page B-12](#)
- [Enabling IPSec Debug, page B-15](#)
- [Getting Additional Information, page B-15](#)



### Note

The PIX Firewall will not establish an L2TP/IPSec tunnel with a Windows 2000 client if either the Cisco VPN Client or the Cisco VPN 3000 Client Version 2.5 is installed. To work around this problem, disable the “Cisco Systems, Inc.VPN Service” from the Services panel in Windows 2000. To open the Services panel, click **Start>Programs>Administrative Tools>Services**. Then restart the “IPSec Policy Agent Service” from the Services panel, and reboot the machine.

---

## Overview

The example shows the use of IPSec with L2TP, which requires that IPSec be configured in transport mode. For detailed command reference information, refer to the *Cisco PIX Firewall Command Reference*.



### Note

For information on configuring the PIX Firewall for RSA signatures or pre-shared keys as the authentication method, refer to the **isakmp** command in page within the *Cisco PIX Firewall Command Reference*. For information on obtaining certificates for RSA signature authentication from a CA, refer to “[Using Certification Authorities](#)” in [Chapter 6, “Configuring IPSec and Certification Authorities.”](#)”

## Configuring the PIX Firewall

In this example, PIX Firewall uses PAP and AAA authentication. No conduits/access lists are included, because the **sysopt connection permit-l2tp** option, which permits L2TP traffic, is set in Step 23.

Follow these steps to configure the PIX Firewall to interoperate with the Windows 2000 client:

**Step 1** Define AAA related parameters:

```
aaa-server radius protocol radius
aaa-server partnerauth protocol radius
aaa-server partnerauth (dmz) host 192.168.101.2 abcdef timeout 5
```



### Note

Steps 2-10 use RSA signatures as the authentication method for ISAKMP negotiation. If you want to use pre-shared keys as the authentication method, skip Steps 2-10 and configure the following: **isakmp my secretkey address 0.0.0.0 netmask 0.0.0.0** and **isakmp policy 1 authentication pre-share**.

**Step 2** Define a host name:

```
hostname SanJose
```

**Step 3** Define the domain name:

```
domain-name example.com
```

**Step 4** Generate the PIX Firewall RSA key pair:

```
ca generate rsa key 512
```

This command is entered at the command line and does not get stored in the configuration.

**Step 5** Declare a CA:

```
ca identity abcd 209.165.200.228 209.165.200.228
```

The second address is configured if LDAP is used by that CA server. This command is stored in the configuration.

**Step 6** Configure the parameters of communication between the PIX Firewall and the CA:

```
ca configure abcd ra 1 20 crloptional
```

This command is stored in the configuration. **1** is the retry period, **20** is the retry count, and the **crloptional** option disables CRL checking.

**Step 7** Authenticate the CA by obtaining its public key and its certificate:

```
ca authenticate abcd
```

This command is entered at the command line and does not get stored in the configuration.

**Step 8** Request signed certificates from your CA for your PIX Firewall's RSA key pair:

```
ca enroll abcd cisco
```

Before entering this command, contact your CA administrator because they must authenticate your PIX Firewall manually before granting its certificate(s).

“cisco” is a challenge password. This can be anything. This command is entered at the command line and does not get stored in the configuration.

**Step 9** Verify that the enrollment process was successful using the **show ca certificate** command:

```
show ca certificate
```

**Step 10** Save keys and certificates, and the CA commands (except those indicated) in Flash memory:

```
ca save all
write memory
```



---

**Note** Use the **ca save all** command any time you add, change, or delete **ca** commands in the configuration. This command is not stored in the configuration.

---

**Step 11** Configure the IKE policy:

```
isakmp policy 1 authentication rsa-sig
isakmp policy 1 encryption des
isakmp policy 1 hash sha
isakmp policy 1 group 1
isakmp policy 1 lifetime 86400
```



---

**Note** Always configure the IKE lifetime on PIX Firewall for the same or more time than the IKE lifetime configured on the Windows 2000 L2TP/IPSec client, or the IKE negotiation will fail (CSCdt 48570).

---

**Step 12** Configure ISAKMP identity:

```
isakmp identity hostname
```

**Step 13** Enable ISAKMP on the outside interface:

```
isakmp enable outside
```

**Step 14** Create an access list that defines the PIX Firewall network(s) requiring IPSec protection:

```
access-list 90 permit ip 10.0.0.0 255.255.255.0 10.1.1.0 255.255.255.0
```

**Step 15** Bind the access list to NAT 0:

```
nat (inside) 0 access-list 90
```

**Step 16** Configure a transform set that defines how the traffic will be protected:

```
crypto ipsec transform-set basic esp-des esp-md5-hmac
crypto ipsec transform-set basic mode transport
```



**Note** The Windows 2000 L2TP/IPSec client uses IPSec transport mode, so transport mode should be selected on the transform set.

**Step 17** Create a dynamic crypto map, and specify which transform sets are allowed for this dynamic crypto map entry:

```
crypto dynamic-map cisco 4 set transform-set basic
```



**Note** Specify which transform sets are allowed for this dynamic crypto map entry.

**Step 18** Add the dynamic crypto map into a static crypto map:

```
crypto map partner-map 20 ipsec-isakmp dynamic cisco
```

**Step 19** Apply the crypto map to the outside interface:

```
crypto map partner-map interface outside
```

**Step 20** Configure the IP local pool:

```
ip local pool dealer 10.1.1.1-10.1.1.254
```

**Step 21** Configure the VPDN group for L2TP:

```
vpdn group 1 accept dialin l2tp
vpdn group 1 ppp authentication pap
vpdn group 1 client configuration address local dealer
vpdn group 1 client configuration dns 10.0.0.15
vpdn group 1 client configuration wins 10.0.0.16
vpdn group 1 client authentication aaa partnerauth
```



**Note** The AAA server used for accounting does not need to be the same server as the AAA authentication server.

```
vpdn group 1 l2tp tunnel hello
```

**Step 22** Enable the VPDN function on the outside interface of the PIX Firewall:

```
vpdn enable outside
```

**Step 23** Configure the PIX Firewall to implicitly permit L2TP traffic and bypass conduit/access list checking:

```
sysopt connection permit-l2tp
```

**Step 24** (Optional) If AAA authentication is not required, local authentication can be used by configuring the username and password on the PIX Firewall:

```
vpdn username user1 password test1
```

**Step 25** The following debug commands (some of which can only be used from the console) can be used for troubleshooting:

```
debug cry isa
debug cry ipsec
debug cry ca
debug vpdn packet
debug vpdn event
debug vpdn error
debug ppp error
debug ppp negotiation
```

**Step 26** Verify/display tunnel configuration:

```
show vpdn tunnel
```

**Note**

The PIX Firewall does not establish an L2TP/IPSec tunnel with Windows 2000 if either the Cisco VPN Client Version 3.x or the Cisco VPN 3000 Client Version 2.5 is installed. Disable the *Cisco VPN Service* for the Cisco VPN Client Version 3.x, or the *ANetIKE Service* for the Cisco VPN 3000 Client Version 2.5 from the Services panel in Windows 2000 (click **Start>Programs>Administrative Tools>Services**). Then restart the IPSec Policy Agent Service from the **Services** panel, and reboot the machine.

## Enabling IPSec Debug

IPSec debug information can be added to a Windows 2000 client by adding the following registry:

**Step 1** Run the Windows 2000 registry editor: REGEDIT.

**Step 2** Locate the following registry entry:

```
MyComputer\HKEY_LOCAL_MACHINE\CurrentControlSet\Services\PolicyAgent
```

**Step 3** Create the key by entering **oakley**.

**Step 4** Create the DWORD by entering **EnableLogging**.

**Step 5** Set the “EnableLogging” value to “1”.

**Step 6** Stop and Start the IPSec Policy Agent (click **Start>Programs>Administrative Tools>Services**). The debug file will be found at “%windir%\debug\oakley.log”.

## Getting Additional Information

Additional information on various topics can be found at [www.microsoft.com](http://www.microsoft.com):

<http://support.microsoft.com/support/kb/articles/Q240/2/62.ASP>

How to Configure an L2TP/IPSec Connection Using Pre-Shared Keys Authentication:

<http://support.microsoft.com/support/kb/articles/Q253/4/98.ASP>

How to Install a Certificate for Use with IP Security (IPSec):

[http://www.microsoft.com/windows2000/en/server/help/default.asp?url=/WINDOWS2000/en/server/help/sag\\_VPN\\_us26.htm](http://www.microsoft.com/windows2000/en/server/help/default.asp?url=/WINDOWS2000/en/server/help/sag_VPN_us26.htm)

How to use a Windows 2000 Machine Certificate for L2TP over IPSec VPN Connections:

<http://www.microsoft.com/windows2000/techinfo/planning/security/ipsecsteps.asp#heading3>

How to Create a Custom MMC Console and Enabling Audit Policy for Your Computer:

<http://support.microsoft.com/support/kb/articles/Q259/3/35.ASP>

## Using Cisco VPN Client Version 1.1

The example in this section shows use of Extended Authentication (Xauth), IKE Mode Config and a wildcard, pre-shared key for IKE authentication between a PIX Firewall and a Cisco Secure VPN Client, Version 1.1.

This section includes the following topics:

- [Configuring the PIX Firewall, page B-17](#)
- [Configuring the Cisco Secure VPN Client Version 1.1, page B-19](#)

Figure B-5 illustrates the example network.

**Figure B-5 VPN Client Access**

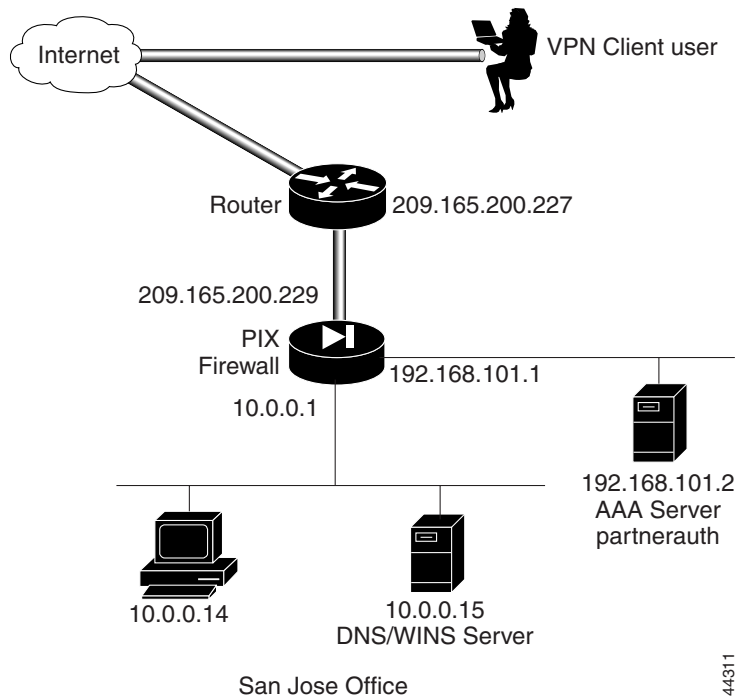

44311



## Configuring the PIX Firewall

Follow these steps to configure the PIX Firewall to interoperate with the Cisco Secure VPN Client:

**Step 1** Define AAA related parameters:

```
aaa-server TACACS+ protocol tacacs+
aaa-server partnerauth protocol tacacs+
aaa-server partnerauth (dmz) host 192.168.101.2 abcdef timeout 5
```

**Step 2** Configure the IKE policy:

```
isakmp enable outside
isakmp policy 8 encr 3des
isakmp policy 8 hash md5
isakmp policy 8 authentication pre-share
```

**Step 3** Configure a wildcard, pre-shared key:

```
isakmp key cisco1234 address 0.0.0.0 netmask 0.0.0.0
```

**Step 4** Create access lists that define the virtual IP addresses for VPN clients:

```
access-list 80 permit ip host 10.0.0.14 host 192.168.15.1
access-list 80 permit ip host 10.0.0.14 host 192.168.15.2
access-list 80 permit ip host 10.0.0.14 host 192.168.15.3
access-list 80 permit ip host 10.0.0.14 host 192.168.15.4
access-list 80 permit ip host 10.0.0.14 host 192.168.15.5
```

**Step 5** Configure NAT 0:

```
nat 0 access-list 80
```

**Step 6** Configure a transform set that defines how the traffic will be protected:

```
crypto ipsec transform-set strong-des esp-3des esp-sha-hmac
```

**Step 7** Create a dynamic crypto map. Specify which transform sets are allowed for this dynamic crypto map entry:

```
crypto dynamic-map cisco 4 set transform-set strong-des
```

**Step 8** Add the dynamic crypto map into a static crypto map:

```
crypto map partner-map 20 ipsec-isakmp dynamic cisco
```

**Step 9** Apply the crypto map to the outside interface:

```
crypto map partner-map interface outside
```

**Step 10** Enable Xauth:

```
crypto map partner-map client authentication partnerauth
```

**Step 11** Configure IKE Mode Config related parameters:

```
ip local pool dealer 192.168.15.1-192.168.15.5
isakmp client configuration address-pool local dealer outside
crypto map partner-map client configuration address initiate
```

**Step 12** Tell PIX Firewall to implicitly permit IPsec traffic:

```
sysopt connection permit-ipsec
```

---

[Example B-1](#) provides the complete PIX Firewall configuration.

**Example B-1 PIX Firewall with VPN Client and Manual IP Address**

```
nameif ethernet0 outside security0
nameif ethernet1 inside security100
nameif ethernet2 dmz security10
enable password 8Ry2YjIyt7RRXU24 encrypted
passwd 2KFQnbNIdI.2KYOU encrypted
hostname SanJose
domain-name example.com
fixup protocol ftp 21
fixup protocol http 80
fixup protocol smtp 25
fixup protocol h323 1720
fixup protocol rsh 514
fixup protocol sqlnet 1521
names
pager lines 24
no logging on
interface ethernet0 auto
interface ethernet1 auto
interface ethernet2 auto
mtu outside 1500
mtu inside 1500
mtu dmz 1500
ip address outside 209.165.200.229 255.255.255.224
ip address inside 10.0.0.1 255.255.255.0
ip address dmz 192.168.101.1 255.255.255.0
no failover
failover ip address outside 0.0.0.0
failover ip address inside 0.0.0.0
failover ip address dmz 0.0.0.0
arp timeout 14400
nat (inside) 1 0.0.0.0 0.0.0.0 0 0
access-list 80 permit ip host 10.0.0.14 host 192.168.15.1
access-list 80 permit ip host 10.0.0.14 host 192.168.15.2
access-list 80 permit ip host 10.0.0.14 host 192.168.15.3
access-list 80 permit ip host 10.0.0.14 host 192.168.15.4
access-list 80 permit ip host 10.0.0.14 host 192.168.15.5
nat 0 access-list 80
global (outside) 1 209.165.200.45-209.165.200.50 netmask 255.255.255.224
route outside 0.0.0.0 0.0.0.0 209.165.200.227 1
timeout xlate 3:00:00 conn 1:00:00 half-closed 0:10:00 udp 0:02:00
timeout rpc 0:10:00 h323 0:05:00
timeout uauth 0:05:00 absolute
ip local pool dealer 192.168.15.1-192.168.15.5
aaa-server TACACS+ protocol tacacs+
aaa-server RADIUS protocol radius
aaa-server partnerauth protocol tacacs+
aaa-server partnerauth (dmz) host 192.168.101.2 abcdef timeout 5
no snmp-server location
no snmp-server contact
snmp-server community public
no snmp-server enable traps
crypto map partner-map client configuration address initiate
isakmp client configuration address-pool local dealer outside
```

```

crypto ipsec transform-set strong-des esp-3des esp-sha-hmac
crypto dynamic-map cisco 4 set transform-set strong-des
crypto map partner-map 20 ipsec-isakmp dynamic cisco
crypto map partner-map client authentication partnerauth
crypto map partner-map interface outside
isakmp key cisco1234 address 0.0.0.0 netmask 0.0.0.0
isakmp enable outside
isakmp policy 8 authentication pre-share
isakmp policy 8 encryption 3des
isakmp policy 8 hash md5
sysopt connection permit-ipsec
telnet timeout 5
terminal width 80

```

## Configuring the Cisco Secure VPN Client Version 1.1

This section describes how to configure the Cisco Secure VPN Client for use with the PIX Firewall. Refer to the *Release Notes for the Cisco Secure VPN Client Version 1.1* or higher for the most current information. Before performing the information in this section, install the VPN client as described in the Cisco Secure VPN Client release notes. You can find the Cisco Secure VPN Client release notes online at the following website:

<http://www.cisco.com/univercd/cc/td/doc/product/iaabu/csvpnc/index.htm>

Follow these steps to configure the Cisco Secure VPN Client Version 1.1:

- 
- Step 1** Click **Start>Programs>Cisco Secure VPN Client>Security Policy Editor**.
  - Step 2** Click **Options>Secure>Specified Connections**.
  - Step 3** In the Network Security Policy window, click **Other Connection** and then click **Non-Secure** in the panel on the right.
  - Step 4** Click **File>New Connection**. Rename New Connection. For example, **ToSanJose**.
  - Step 5** Under **Connection Security**, click **Secure**.
  - Step 6** Under **Remote Party Identity and Addressing**, set the following preferences in the panel on the right:
    - a. ID Type—Click **IP address**.
    - b. Enter the IP address of the internal host within the PIX Firewall unit's internal network to which the VPN client will have access. Enter **10.0.0.14**.
    - c. Click **Connect using Secure Gateway Tunnel**.
    - d. ID Type—Click **IP address**.
    - e. Enter the IP address of the outside interface of the PIX Firewall. Enter **209.165.200.229**.
  - Step 7** In the Network Security Policy window, click the plus sign beside the ToSanJose entry to expand the selection, and click **My Identity**. Set the following preferences in the panel on the right:
    - a. Select Certificate—Click **None**.
    - b. ID Type—Click **IP address**.
    - c. Port—Click **All**.
    - d. Local Network Interface—Click **Any**.
    - e. Click **Pre-Shared Key**. When the Pre-Shared Key dialog box appears, click **Enter Key** to make the key box editable. Enter **cisco1234** and click **OK**.

- Step 8** In the Network Security Policy window, expand Security Policy and set the following preferences in the panel on the right:
- Under **Select Phase 1 Negotiation Mode**, click **Main Mode**.
  - Select the **Enable Replay Detection** check box.
- Leave any other values as they were in the panel.
- Step 9** Click **Security Policy>Authentication (Phase 1)>Proposal 1** and set the following preferences in the panel on the right:
- Authentication Method—Click **Pre-shared Key**.
  - Encrypt Alg—Click **Triple DES**.
  - Hash Alg—Click **MD5**.
  - SA Life—Click **Unspecified** to accept the default values.
  - Key Group—Click **Diffie-Hellman Group 1**.
- Step 10** Click **Security Policy>Key Exchange (Phase 2)>Proposal 1** and select the following values in the panel on the right:
- Select the **Encapsulation Protocol (ESP)** check box.
  - Encryption Alg—Click **Triple DES**.
  - Hash Alg—Click **SHA-1**.
  - Encapsulation—Click **Tunnel**.
- Step 11** Click **File>Save Changes**.
- The VPN client is now activated.
- 

You can view connection process by right-clicking the SafeNet/Soft-PK icon on the Windows taskbar. Unless the taskbar is changed, this icon appears in lower right of the screen. Click **Log Viewer** to display the View Log feature.

[Example B-2](#) shows a typical View Log session.

#### **Example B-2 View Log Session**

```
time_stamp ToSanJose - Deleting IKE SA
time_stamp ToSanJose - SENDING>>>>ISAKMP OAK QM *(HASH, SA, NON, ID, ID)
time_stamp ToSanJose - RECEIVED<<<<ISAKMP OAK TRANS *(HASH, ATTR)
time_stamp ToSanJose - Received Private IP Address = 192.168.15.3
time_stamp ToSanJose - SENDING>>>>ISAKMP OAK TRANS *(HASH, ATTR)
time_stamp ToSanJose - RECEIVED<<<<ISAKMP OAK QM *(HASH, SA, NON, ID, ID,
NOTIFY:STATUS_RESP_LIFETIME)
time_stamp ToSanJose - SENDING>>>> ISAKMP OAK QM *(HASH)
time_stamp ToSanJose - Loading IPsec SA keys...
time_stamp
```

## Making an Exception to Xauth for a Site-to-Site VPN Peer

If you have both a site-to-site VPN peer and VPN client peers terminating on the same interface, and have the Xauth feature configured, configure the PIX Firewall to make an exception to this feature for the site-to-site VPN peer. With this exception, the PIX Firewall will not challenge the site-to-site peer for a username and password. The command that you employ to make an exception to the Xauth feature depends on the authentication method you are using within your IKE policies.

Table B-1 summarizes the guidelines to follow.

**Table B-1** Configuring no-xauth

| IKE Authentication Method | no-xauth Related Command to Use                                                                                                                                                                                                                             |
|---------------------------|-------------------------------------------------------------------------------------------------------------------------------------------------------------------------------------------------------------------------------------------------------------|
| pre-shared key            | <b>isakmp key</b> <i>keystring</i> <b>address</b> <i>ip-address</i> [ <i>netmask</i> ] [ <b>no-xauth</b> ] [ <b>no-config-mode</b> ]<br><br>See the <b>isakmp</b> command page within the <i>Cisco PIX Firewall Command Reference</i> for more information. |
| rsa signatures            | <b>isakmp peer fqdn</b> <i>fqdn</i> [ <b>no-xauth</b> ] [ <b>no-config-mode</b> ]<br><br>See the <b>isakmp</b> command page within the <i>Cisco PIX Firewall Command Reference</i> for more information.                                                    |

## Making an Exception to IKE Mode Config for Site-to-Site VPN Peers

If you have both a site-to-site VPN peer and VPN clients terminating on the same interface, and have the IKE Mode Config feature configured, configure the PIX Firewall to make an exception to this feature for the site-to-site VPN peer. With this exception, the PIX Firewall will not attempt to download an IP address to the peer for dynamic IP address assignment. The command that you employ to bypass the IKE Mode Config feature depends on the authentication method you are using within your IKE policies. See Table B-2 for the guidelines to follow.

**Table B-2** Configuring no-config-mode

| IKE Authentication Method | no-config-mode Related Command to Use                                                                                                                                                                                                                   |
|---------------------------|---------------------------------------------------------------------------------------------------------------------------------------------------------------------------------------------------------------------------------------------------------|
| pre-shared key            | <b>isakmp key</b> <i>keystring</i> <b>address</b> <i>ip-address</i> [ <i>netmask</i> ] [ <b>no-xauth</b> ] [ <b>no-config-mode</b> ]<br><br>See the <b>isakmp</b> command page in the <i>Cisco PIX Firewall Command Reference</i> for more information. |
| rsa signatures            | <b>isakmp peer fqdn</b> <i>fqdn</i> [ <b>no-xauth</b> ] [ <b>no-config-mode</b> ]<br><br>See the <b>isakmp</b> command page in the <i>Cisco PIX Firewall Command Reference</i> for more information.                                                    |



## MS-Exchange Firewall Configuration

---

This appendix explains how you can configure the PIX Firewall to support Microsoft Exchange by creating **access-list** command statements for NetBIOS and TCP. The example that follows will work for two Windows NT Servers; one on the inside network of the PIX Firewall, and the other on the external network from where you want to send and receive mail. Once Microsoft Exchange is functioning across the PIX Firewall, users can send and receive mail with mail clients on platforms other than Windows NT.

Before starting, complete the following:

- Determine the PIX Firewall's global address you will use in the **static** command statement.
- Have previously installed Microsoft Exchange on both Windows NT systems.
- Select the Windows NT system from the Administrator login.
- Determine the IP address, computer name, and domain name of each Windows NT system. Click **Start>Settings>Control Panel>Network** and click the entry for the Ethernet adapter. Then click **Properties**. The information you need appears on the IP Address tab and DNS Configuration tab.

This appendix includes the following sections:

- [Configuring the Microsoft Exchange Servers, page C-1](#)
- [Configuring the PIX Firewall, page C-2](#)
- [Configuring the Outside Server, page C-3](#)
- [Configuring the Inside Server, page C-3](#)
- [Configuring Both Systems After Rebooting, page C-4](#)

## Configuring the Microsoft Exchange Servers

The information that follows describes the configuration required for two Windows NT systems to pass mail across the PIX Firewall.



### Note

To use the procedure that follows, you should be completely familiar with Microsoft Exchange and the administrative functionality of your Windows NT Server.

To help understand the procedure discussed in this appendix, [Table C-1](#) lists the host names, their IP addresses, and the domains.

**Table C-1** Names and Addresses

| System                         | Name      | IP Address    | Domain |
|--------------------------------|-----------|---------------|--------|
| Outside Windows NT Server      | outserver | 209.165.201.2 | pixout |
| Inside Windows NT Server       | inserver  | 192.168.42.2  | pixin  |
| PIX Firewall outside interface | None      | 209.165.201.1 | None   |
| PIX Firewall inside interface  | None      | 192.168.42.1  | None   |

The PIX Firewall **static** command statement uses 209.165.201.5 as its global address. An administrative domain is created with the Microsoft Exchange Administrator application named **CISCO** in this example. This domain includes both servers.

The sections that follow show how to configure the Microsoft Exchange servers and the PIX Firewall. Complete each section before moving to the next.

## Configuring the PIX Firewall

Follow these steps to configure the PIX Firewall:

- Step 1** Create **static** and **access-list** commands to permit the outside server access to the inside server via the global address in the PIX Firewall.

For example:

```
static (inside,outside) 209.165.201.5 192.168.42.2 0 0
access-list acl_out permit tcp host 209.165.201.2 host 209.165.201.5 eq 139
access-list acl_out permit udp host 209.165.201.2 host 209.165.201.5 eq 137
access-list acl_out permit udp host 209.165.201.2 host 209.165.201.5 eq 138
access-list acl_out permit tcp host 209.165.201.2 host 209.165.201.5 eq 135
access-group acl_out in interface outside
```

The **static** command statement permits the inside server, 192.168.42.2 to be accessible from the outside at global address 209.165.201.5. The **access-list** commands give the outside server, 209.165.201.2, access to the inside server's global address, 209.165.201.5. Port 139 gives access to NetBIOS over TCP. Access to UDP ports 137 and 138 is also required.

The last **access-list** command statement for TCP port 135 permits the outside server to come in via MSRPC (Microsoft Remote Procedure Call), which uses TCP.

The **access-group** command statement binds the **access-list** command statements to the outside interface.

- Step 2** The **static** command statement in Step 1 also allows outbound initiation, but requires an **established** command statement to allow back connections:

```
established tcp 135 permitto tcp 1024-65535
```

This command statement allows the RPC back connections from the outside host on all high ports (1024 through 65535) to deliver mail.

- Step 3** Enter the **syslog console** command statement so that you can watch for messages after you configure the two servers.



## Configuring the Outside Server

Follow these steps to configure the outside Microsoft Exchange server:

- 
- Step 1** On the outside Microsoft Exchange server, click the **Network** entry in the **Start>Settings>Control Panel**. In the Ethernet adapter **Properties** section, set the primary WINS (Windows Internet Name System) address to the IP address of the outside system, in this case, 209.165.201.2. Set the secondary WINS address to the global address from the **static** command statement, 209.165.201.5.
- Step 2** Also in the **Network** entry, click **Services>Computer Browser**. Ensure that the outside server is the master browser for the server's outside domain, which in this case, is **pixout**.
- Step 3** Click **Start>Programs>WINS Manager**. Click **Mappings>Static Mappings**. Add a static mapping for the inside server's domain, **pixin**, with the global address from the **static** command statement, 209.165.201.5. Also add a unique mapping for the inside server's name, **inserver**, and set it as well to the global address from the **static** command statement. Then save the new information and exit the WINS Manager.
- Step 4** Next, establish a trusted, trusting relationship between the outside server's domain, **pixout** and the inside server's domain, **pixin**.
- Click **Start>Programs>Administrative Tools>User Manager for Domains**.
  - Click **Policies>Trust Relationship** and then click **Trusting Domain**.
  - Add a trusting domain for the inside server's domain and assign a password to it.
  - Establish a trusted domain for **pixin** by clicking **Trusted Domain**.
- Step 5** Exit the application and reboot the Windows NT system.
- 

## Configuring the Inside Server

Follow these steps to configure the inside Microsoft Exchange server:

- 
- Step 1** On the inside server, click **Settings>Control Panel>Network**, set the primary WINS address to the address of that system, 192.168.42.2, and set the secondary WINS address to the inside address of the PIX Firewall, 192.168.41.1.
- In the **Network** entry, click **Services>Computer Browser**. Ensure that the inside server is the master browser for the domain, which in this case, is **pixin**.
- In the **Network** entry, click **Protocols>TCP/IP Protocol>WINS Configuration**. Set the primary and secondary WINS address to that of the inside server, in this case, 192.168.42.2. On the **Default Gateway** tab, set the address to the inside address of the PIX Firewall, in this case, 192.168.42.1.
- Step 2** Click **Start>Programs>WINS Manager**, and specify a static mapping for the outside server's domain, **pixout**, and a unique mapping for the outside server, **outserv**. Set both to the address of the outside server, 209.165.201.2.
- On the **Server** menu, click **Replication Partners** and add a **Pull Partner** for the outside server, in this case, 209.165.201.2. This permits pulling the outside server's database to the inside server's local database. This incorporates the two server's databases so that user information is shared across the firewall. Use the default options in the remainder of this dialog box.
- You can view the information you entered by clicking **Mappings>Show Database**.

- Step 3** Establish a trusted, trusting relationship between the inside server's domain, **pixin** and the outside server's domain, **pixout**.
- Click **Start>Programs>Administrative Tools>User Manager for Domains**.
  - Click **Policies>Trust Relationship**, and click **Trusting Domain**.
  - Add a trusting domain for the outside server's domain and assign a password to it.
  - Establish a trusted domain for **pixout** by clicking **Trusted Domain**.
- Step 4** Exit the application and reboot the Windows NT system.
- 

## Configuring Both Systems After Rebooting

After rebooting, follow these steps to configure both the inside and outside servers:

- 
- Step 1** After the systems are usable, on the inside server, click **Start>Find>Computer** and look up the outside server, in this case, by entering `\\outserver`. Then go to the outside server and find **inserver**.
- Step 2** On each server, configure Microsoft Exchange by clicking **Start>Programs>Microsoft Exchange Administrator** to connect to the other server. Declare a network name, in this case, **CISCO** on both servers. On each server, declare the site name to be the respective server's domain name. In this case, on the inside server, the site name is **pixin**. On the outside server, it is **pixout**.
- Click **File>Connect to Server** to connect to the other server.
- Step 3** From the Administrator application, configure the site connector. Double-click your site name in the **Configure/Connections** field and the Connections list appears. Ensure you have a site connector installed. If you followed the defaults when you installed Microsoft Exchange, this should be present. If not, add the site connector for the server's respective domains, just as you did in Step 2. For the **cost**, use the default. For the **Messaging Bridge Head**, use the name of that server. For the **Target Server**, use the name of the other server. You can ignore the **Address Space** field.
- Step 4** Once both sites are connected, the Administrator application should show the other site available for access. Ensure that at least one username is specified on each server that you can use as a test login.
- Step 5** Then test email from a mail client with the username. The global address list in the address book should list the other server and users on either side. Send the email message.
- 

On the PIX Firewall, you should now be able to see syslog messages indicating an MSRPC connection. If you are sending mail from the inside network to the outside network, you should see an MSRPC connection going from the inside server to the outside server on port 135. Then you should see another high-port connection being built between the outside server and the inside server. Your email should flow through almost immediately.

## TCP/IP Reference Information

---

This appendix includes the following sections:

- [IP Addresses, page D-1](#)
- [Ports, page D-2](#)
- [Protocols and Applications, page D-5](#)
- [Using Subnet Masks, page D-7](#)

### IP Addresses

- IP address classes are defined as follows:
  - Class A—If the first octet is between 1 and 127 (inclusive), the address is a Class A address. In a Class A address, the first octet is the one-byte net address and the last three octets are the host address. The network mask for Class A addresses is 255.0.0.0.
  - Class B—If the first octet is between 128 and 191 (inclusive), the address is a Class B address. In a Class B address, the first two octets are the net address and the last two octets are the host address. The network mask for Class B addresses is 255.255.0.0.
  - Class C—If the first octet is 192 or higher, the address is a Class C address. In a Class C address, the first three octets are the net address and the last octet is the host address. The network mask for Class C addresses is 255.255.255.0.
  - Class D—These addresses are used for multicast transmissions and within the range from 224.0.0.0 to 239.255.255.255. Some of these addresses are assigned to multicasts used by specific TCP/IP protocols. Other Class D addresses are assigned to applications, such as streaming video, that send data to many recipients simultaneously. For information about enabling the PIX Firewall to transmit multicast traffic, refer to “[Enabling Stub Multicast Routing](#)” in [Chapter 2, “Establishing Connectivity.”](#)
- We recommend that you use RFC 1918 IP addresses for inside and perimeter addresses. These addresses follow:
  - Class A: 10.0.0.0 to 10.255.255.255
  - Class B: 172.16.0.0 to 172.31.255.255
  - Class C: 192.168.0.0 to 192.168.255.255
  - Class D: 224.0.0.0 to 239.255.255.255
- PIX Firewall requires that IP addresses in the **ip address, static, global, failover, and virtual** commands be unique. These IP addresses cannot be the same as your router IP addresses.

- In this guide, the use of “address” and “IP address” are synonymous.
- IP addresses are primarily one of these values:
  - *local\_ip*—An untranslated IP address on the internal, protected network. In an outbound connection originated from *local\_ip*, the *local\_ip* is translated to the *global\_ip*. On the return path, the *global\_ip* is translated to the *local\_ip*. The *local\_ip* to *global\_ip* translation can be disabled with the **nat 0 0 0** command. In syslog messages, this address is referenced as *laddr*.
  - *global\_ip*—A translated global IP address in the pool or those addresses declared with the **global** or **static** commands. In syslog messages, this address is referenced as *gaddr*.
  - *foreign\_ip*—An untranslated IP address on an external network. *foreign\_ip* is an address for hosts on the external network. If the **alias** command is in use, an inbound message originating for the *foreign\_ip* source address is translated to *dnat\_ip* by PIX Firewall.
  - *dnat\_ip*—(dual NAT) A translated (by the **alias** command) IP address on an external network. In an outbound connection destined to *dnat\_ip*, it will be untranslated to *foreign\_ip*. In syslog messages, this address is referenced as *faddr*.
  - *virtual\_ip*—(used with the **virtual** command) A fictitious public or private IP address that is not the address of a real web server on the interface you are accessing. We recommend that you use an RFC 1918 address or one you make up.

## Ports

Literal names can be used instead of a numerical port value in **access-list** commands.

PIX Firewall uses port 1521 for SQL\*Net. This is the default port used by Oracle for SQL\*Net. This value, however, does not agree with IANA port assignments.

PIX Firewall listens for RADIUS on ports 1645 and 1646. If your RADIUS server uses ports 1812 and 1813, you will need to reconfigure it to listen on ports 1645 and 1646.



### Note

To assign a port for DNS access, use **domain**, not **dns**. The **dns** keyword translates into the port value for **dnsix**.

Port numbers can be viewed online at the IANA website:

<http://www.iana.org/assignments/port-numbers>

Table D-1 lists the literal values.

**Table D-1 Port Literal Values**

| Literal | TCP or UDP? | Value | Description                                                   |
|---------|-------------|-------|---------------------------------------------------------------|
| aol     | TCP         | 5190  | America On-line                                               |
| bgp     | TCP         | 179   | Border Gateway Protocol, RFC 1163                             |
| biff    | UDP         | 512   | Used by mail system to notify users that new mail is received |
| bootpc  | UDP         | 68    | Bootstrap Protocol Client                                     |
| bootps  | UDP         | 67    | Bootstrap Protocol Server                                     |
| chargen | TCP         | 19    | Character Generator                                           |

Table D-1 Port Literal Values (continued)

| Literal     | TCP or UDP? | Value | Description                                                                |
|-------------|-------------|-------|----------------------------------------------------------------------------|
| citrix-ica  | TCP         | 1494  | Citrix Independent Computing Architecture (ICA) protocol                   |
| cmd         | TCP         | 514   | Similar to <b>exec</b> except that <b>cmd</b> has automatic authentication |
| ctiqbe      | TCP         | 2748  | Computer Telephony Interface Quick Buffer Encoding                         |
| daytime     | TCP         | 13    | Day time, RFC 867                                                          |
| discard     | TCP, UDP    | 9     | Discard                                                                    |
| domain      | TCP, UDP    | 53    | DNS (Domain Name System)                                                   |
| dnsix       | UDP         | 195   | DNSIX Session Management Module Audit Redirector                           |
| echo        | TCP, UDP    | 7     | Echo                                                                       |
| exec        | TCP         | 512   | Remote process execution                                                   |
| finger      | TCP         | 79    | Finger                                                                     |
| ftp         | TCP         | 21    | File Transfer Protocol (control port)                                      |
| ftp-data    | TCP         | 20    | File Transfer Protocol (data port)                                         |
| gopher      | TCP         | 70    | Gopher                                                                     |
| https       | TCP         | 443   | Hyper Text Transfer Protocol (SSL)                                         |
| h323        | TCP         | 1720  | H.323 call signalling                                                      |
| hostname    | TCP         | 101   | NIC Host Name Server                                                       |
| ident       | TCP         | 113   | Ident authentication service                                               |
| imap4       | TCP         | 143   | Internet Message Access Protocol, version 4                                |
| irc         | TCP         | 194   | Internet Relay Chat protocol                                               |
| isakmp      | UDP         | 500   | Internet Security Association and Key Management Protocol                  |
| kerberos    | TCP, UDP    | 750   | Kerberos                                                                   |
| klogin      | TCP         | 543   | KLOGIN                                                                     |
| kshell      | TCP         | 544   | Korn Shell                                                                 |
| ldap        | TCP         | 389   | Lightweight Directory Access Protocol                                      |
| ldaps       | TCP         | 636   | Lightweight Directory Access Protocol (SSL)                                |
| lpd         | TCP         | 515   | Line Printer Daemon - printer spooler                                      |
| login       | TCP         | 513   | Remote login                                                               |
| lotusnotes  | TCP         | 1352  | IBM Lotus Notes                                                            |
| mobile-ip   | UDP         | 434   | MobileIP-Agent                                                             |
| nameserver  | UDP         | 42    | Host Name Server                                                           |
| netbios-ns  | UDP         | 137   | NetBIOS Name Service                                                       |
| netbios-dgm | UDP         | 138   | NetBIOS Datagram Service                                                   |

**Table D-1 Port Literal Values (continued)**

| <b>Literal</b>    | <b>TCP or UDP?</b> | <b>Value</b> | <b>Description</b>                                                |
|-------------------|--------------------|--------------|-------------------------------------------------------------------|
| netbios-ssn       | TCP                | 139          | NetBIOS Session Service                                           |
| nntp              | TCP                | 119          | Network News Transfer Protocol                                    |
| ntp               | UDP                | 123          | Network Time Protocol                                             |
| pcanywhere-status | UDP                | 5632         | pcAnywhere status                                                 |
| pcanywhere-data   | TCP                | 5631         | pcAnywhere data                                                   |
| pim-auto-rp       | TCP, UDP           | 496          | Protocol Independent Multicast, reverse path flooding, dense mode |
| pop2              | TCP                | 109          | Post Office Protocol - Version 2                                  |
| pop3              | TCP                | 110          | Post Office Protocol - Version 3                                  |
| pptp              | TCP                | 1723         | Point-to-Point Tunneling Protocol                                 |
| radius            | UDP                | 1645         | Remote Authentication Dial-In User Service                        |
| radius-acct       | UDP                | 1646         | Remote Authentication Dial-In User Service (accounting)           |
| rip               | UDP                | 520          | Routing Information Protocol                                      |
| secureid-udp      | UDP                | 5510         | SecureID over UDP                                                 |
| smtp              | TCP                | 25           | Simple Mail Transport Protocol                                    |
| snmp              | UDP                | 161          | Simple Network Management Protocol                                |
| snmptrap          | UDP                | 162          | Simple Network Management Protocol - Trap                         |
| sqlnet            | TCP                | 1521         | Structured Query Language Network                                 |
| ssh               | TCP                | 22           | Secure Shell                                                      |
| sunrpc (rpc)      | TCP, UDP           | 111          | Sun Remote Procedure Call                                         |
| syslog            | UDP                | 514          | System Log                                                        |
| tacacs            | TCP, UDP           | 49           | Terminal Access Controller Access Control System Plus             |
| talk              | TCP, UDP           | 517          | Talk                                                              |
| telnet            | TCP                | 23           | RFC 854 Telnet                                                    |
| tftp              | UDP                | 69           | Trivial File Transfer Protocol                                    |
| time              | UDP                | 37           | Time                                                              |
| uucp              | TCP                | 540          | UNIX-to-UNIX Copy Program                                         |
| who               | UDP                | 513          | Who                                                               |
| whois             | TCP                | 43           | Who Is                                                            |
| www               | TCP                | 80           | World Wide Web                                                    |
| xdmcp             | UDP                | 177          | X Display Manager Control Protocol                                |

# Protocols and Applications

This section provides information about the protocols and applications with which you may need to work when configuring PIX Firewall. It includes the following topics:

- [Supported Multimedia Applications](#)
- [Supported Protocols and Applications](#)

Possible literal values are **ahp**, **eigrp**, **esp**, **gre**, **icmp**, **igmp**, **igrp**, **ip**, **ipinip**, **ipsec**, **nos**, **ospf**, **pcp**, **snp**, **tcp**, and **udp**. You can also specify any protocol by number. The **esp** and **ah** protocols only work in conjunction with Private Link.



## Note

PIX Firewall does not pass multicast packets. Many routing protocols use multicast packets to transmit their data. If you need to send routing protocols across the PIX Firewall, configure the routers with the Cisco IOS software **neighbor** command. We consider it inherently dangerous to send routing protocols across the PIX Firewall. If the routes on the unprotected interface are corrupted, the routes transmitted to the protected side of the firewall will pollute routers there as well.

Table D-2 lists the numeric values for the protocol literals.

**Table D-2 Protocol Literal Values**

| Literal | Value | Description                                         |
|---------|-------|-----------------------------------------------------|
| ah      | 51    | Authentication Header for IPv6, RFC 1826            |
| eigrp   | 88    | Enhanced Interior Gateway Routing Protocol          |
| esp     | 50    | Encapsulated Security Payload for IPv6, RFC 1827    |
| gre     | 47    | generic routing encapsulation                       |
| icmp    | 1     | Internet Control Message Protocol, RFC 792          |
| igmp    | 2     | Internet Group Management Protocol, RFC 1112        |
| igrp    | 9     | Interior Gateway Routing Protocol                   |
| ip      | 0     | Internet Protocol                                   |
| ipinip  | 4     | IP-in-IP encapsulation                              |
| nos     | 94    | Network Operating System (Novell's NetWare)         |
| ospf    | 89    | Open Shortest Path First routing protocol, RFC 1247 |
| pcp     | 108   | Payload Compression Protocol                        |
| snp     | 109   | Sitara Networks Protocol                            |
| tcp     | 6     | Transmission Control Protocol, RFC 793              |
| udp     | 17    | User Datagram Protocol, RFC 768                     |

Protocol numbers can be viewed online at the IANA website:

<http://www.iana.org/assignments/protocol-numbers>

## Supported Multimedia Applications

PIX Firewall supports the following multimedia and video conferencing applications:

- CUseeMe Networks CU-SeeMe
- CUseeMe Networks CU-SeeMe Pro
- CUseeMe Networks MeetingPoint
- Intel Internet Video Phone
- Microsoft NetMeeting
- Microsoft NetShow
- NetMeeting
- RealNetworks RealAudio and RealVideo
- Point-to-Point Protocol over Ethernet (PPPoE)
- VDOnet VDOLive
- VocalTec Internet Phone
- VXtreme WebTheater
- Xing StreamWorks

## Supported Protocols and Applications

PIX Firewall supports the following TCP/IP protocols and applications:

- Address Resolution Protocol (ARP)
- Archie
- Berkeley Standard Distribution (BSD)-rcmds
- Bootstrap Protocol (BOOTP)
- Domain Name System (DNS)
- File Transfer Protocol (FTP)
- generic routing encapsulation (GRE)
- Gopher
- HyperText Transport Protocol (HTTP)
- Internet Control Message Protocol (ICMP)
- Internet Protocol (IP)
- NetBIOS over IP (Microsoft Networking)
- Point-to-Point Tunneling Protocol (PPTP)
- Simple Network Management Protocol (SNMP)
- Sitara Networks Protocol (SNP)
- SQL\*Net (Oracle client/server protocol)
- Sun Remote Procedure Call (RPC) services, including Network File System (NFS)
- Telnet



- Transmission Control Protocol (TCP)
- Trivial File Transfer Protocol (TFTP)
- User Datagram Protocol (UDP)
- RFC 1700

## Using Subnet Masks

This section lists information by subnet mask and identifies which masks are for networks, hosts, and broadcast addresses.



### Note

In some networks, broadcasts are also sent on the network address.

This section includes the following topics:

- [Masks, page D-7](#)
- [Uses for Subnet Information, page D-9](#)
- [Using Limited IP Addresses, page D-9](#)
- [Addresses in the .128 Mask, page D-9](#)
- [Addresses in the .192 Mask, page D-10](#)
- [Addresses in the .224 Mask, page D-10](#)
- [Addresses in the .240 Mask, page D-10](#)
- [Addresses in the .248 Mask, page D-11](#)
- [Addresses in the .252 Mask, page D-12](#)

## Masks

For the PIX Firewall commands that accept network masks, specify the correct mask for a network address. For hosts, use 255.255.255.255. However, for the **ip address** command, use a network mask, and for the **global** command, use a network address for both Port Address Translation (PAT) addresses and when specifying a pool of global addresses.

For **access-list** commands, precede host addresses with the **host** parameter and without specifying a mask.

The following are examples of commands in which a mask can be specified:

```
ip address inside 10.1.1.1 255.255.255.0
ip address outside 209.165.201.1 255.255.255.224
nat (inside) 1 10.1.1.0 255.255.255.0
global (outside) 1 209.165.201.2 netmask 255.255.255.224
static (inside,outside) 209.165.201.3 10.1.1.3 netmask 255.255.255.255
access-list acl_out permit tcp any host 209.165.201.3 eq www
aaa authentication include http outside 209.165.201.3 255.255.255.255 0 0 TACACS+
route outside 0 0 209.165.201.4 1
telnet 10.1.1.2 255.255.255.255
```

In these examples, the **ip address** commands specify addresses for the inside and outside network interfaces. The **ip address** command only uses network masks. The inside interface is a Class A address, but only the last octet is used in the example network and therefore has a Class C mask. The outside interface is part of a subnet so the mask reflects the .224 subnet value.

The **nat** command lets users start connections from the inside network. Because a network address is specified, the class mask specified by the **ip address inside** command is used.

The **global** command provides a PAT address to handle the translated connections from the inside. The global address is also part of the subnet and contains the same mask specified in the **ip address outside** command.

The **static** command maps an inside host to a global address for access by outside users. Host masks are always specified as 255.255.255.255.

The **access-list** command permits any outside host to access the global address specified by the **static** command. The **host** parameter is the same as if you specified 209.165.201.3 255.255.255.255.

The **aaa** command indicates that any users wishing to access the global address must be authenticated. Because authentication only occurs when users access the specified global which is mapped to a host, the mask is for a host. The “0 0” entry indicates any host and its respective mask.

The **route** statement specifies the address of the default router. The “0 0” entry indicates any host and its respective mask.

The **telnet** command specifies a host that can access the PIX Firewall unit’s console using Telnet. Because it is a single host, a host mask is used.

If you are using subnet masks, refer to “[Using Subnet Masks](#),” to be sure that each IP address you choose for global or static addresses is in the correct subnet.

The subnet masks are also identified by the number of bits in the mask. [Table D-3](#) lists subnet masks by the number of bits in the network ID.

**Table D-3 Masks Listed by Number of Bit**

| Network ID Bits | Host ID Bits | Subnet | Example Notation | # of Subnets | # of Hosts on Each Subnet |
|-----------------|--------------|--------|------------------|--------------|---------------------------|
| 24              | 8            | .0     | 192.168.1.1/24   | 1            | 254                       |
| 25              | 7            | .128   | 192.168.1.1/25   | 2            | 126                       |
| 26              | 6            | .192   | 192.168.1.1/26   | 4            | 62                        |
| 27              | 5            | .224   | 192.168.1.1/27   | 8            | 30                        |
| 28              | 4            | .240   | 192.168.1.1/28   | 16           | 14                        |
| 29              | 3            | .248   | 192.168.1.1/29   | 32           | 6                         |
| 30              | 2            | .252   | 192.168.1.1/30   | 64           | 2                         |

The .255 mask indicates a single host in a network.

## Uses for Subnet Information

Use subnet information to ensure that your host addresses are in the same subnet and that you are not accidentally using a network or broadcast address for a host.

The network address provides a way to reference all the addresses in a subnet, which you can use in the **global**, **outbound**, and **static** commands. For example, you can use the following net **static** command statement to map global addresses 192.168.1.65 through 192.168.1.126 to local addresses 192.168.2.65 through 192.168.2.126:

```
static (dmz1,dmz2) 192.168.1.64 192.168.2.64 netmask 255.255.255.192.
```

Subnet mask information is especially valuable when you have disabled Network Address Translation (NAT) using the **nat 0** command. PIX Firewall requires that IP addresses on each interface be in different subnets.

However all the hosts on a PIX Firewall interface between the PIX Firewall and the router must be in the same subnet as well. For example, if you have an address such as 192.168.17.0 and you are not using NAT, you could use the 255.255.255.192 subnet mask for all three interfaces and use addresses 192.168.17.1 through 192.168.17.62 for the outside interface, 192.168.17.65 through 192.168.17.126 for the perimeter interface, and 192.168.17.129 through 192.168.17.190 for the inside interface.

## Using Limited IP Addresses

Another use for subnet mask information is for network planning when an Internet service provider (ISP) gives you a limited number of IP addresses and requires you to use a specific subnet mask. Use the information in this appendix to ensure that the outside addresses you choose are in the subnet for the appropriate subnet mask.

For example, if your ISP assigns you 192.168.17.176 with a subnet mask of .240, you can see in [Table D-7](#), subnet number 12 for the .240 mask, that hosts can have IP addresses of 192.168.17.177 through 192.168.17.190. Because this only yields 14 hosts, you will probably use one for your router, another for the outside interface of the PIX Firewall, one for a static for a web server, if you have it, one for a static for your mail server, and the remaining 10 for global addresses. One of these addresses should be a PAT address so that you do not run out of global addresses.

## Addresses in the .128 Mask

[Table D-4](#) lists valid addresses for the .128 subnet mask. This mask permits up to 2 subnets with enough host addresses for 126 hosts per subnet.

**Table D-4** .128 Network Mask Addresses

| Subnet Number | Network Address | Starting Host Address | Ending Host Address | Broadcast Address |
|---------------|-----------------|-----------------------|---------------------|-------------------|
| 1             | .0              | .1                    | .126                | .127              |
| 2             | .128            | .129                  | .254                | .255              |

## Addresses in the .192 Mask

Table D-5 lists valid addresses for the .192 subnet mask. This mask permits up to 4 subnets with enough host addresses for 62 hosts per subnet.

**Table D-5 .192 Network Mask Addresses**

| Subnet Number | Network Address | Starting Host Address | Ending Host Address | Broadcast Address |
|---------------|-----------------|-----------------------|---------------------|-------------------|
| 1             | .0              | .1                    | .62                 | .63               |
| 2             | .64             | .65                   | .126                | .127              |
| 3             | .128            | .129                  | .190                | .191              |
| 4             | .192            | .193                  | .254                | .255              |

## Addresses in the .224 Mask

Table D-6 lists valid addresses for the .224 subnet mask. This mask permits up to 8 subnets with enough host addresses for 30 hosts per subnet.

**Table D-6 .224 Network Mask Addresses**

| Subnet Number | Network Address | Starting Host Address | Ending Host Address | Broadcast Address |
|---------------|-----------------|-----------------------|---------------------|-------------------|
| 1             | .0              | .1                    | .30                 | .31               |
| 2             | .32             | .33                   | .62                 | .63               |
| 3             | .64             | .65                   | .94                 | .95               |
| 4             | .96             | .97                   | .126                | .127              |
| 5             | .128            | .129                  | .158                | .159              |
| 6             | .160            | .161                  | .190                | .191              |
| 7             | .192            | .193                  | .222                | .223              |
| 8             | .224            | .225                  | .254                | .255              |

## Addresses in the .240 Mask

Table D-7 lists valid addresses for the .240 subnet mask. This mask permits up to 16 subnets with enough host addresses for 14 hosts per subnet.

**Table D-7 .240 Network Mask Addresses**

| Subnet Number | Network Address | Starting Host Address | Ending Host Address | Broadcast Address |
|---------------|-----------------|-----------------------|---------------------|-------------------|
| 1             | .0              | .1                    | .14                 | .15               |
| 2             | .16             | .17                   | .30                 | .31               |
| 3             | .32             | .33                   | .46                 | .47               |

**Table D-7 .240 Network Mask Addresses (continued)**

| Subnet Number | Network Address | Starting Host Address | Ending Host Address | Broadcast Address |
|---------------|-----------------|-----------------------|---------------------|-------------------|
| 4             | .48             | .49                   | .62                 | .63               |
| 5             | .64             | .65                   | .78                 | .79               |
| 6             | .80             | .81                   | .94                 | .95               |
| 7             | .96             | .97                   | .110                | .111              |
| 8             | .112            | .113                  | .126                | .127              |
| 9             | .128            | .129                  | .142                | .143              |
| 10            | .144            | .145                  | .158                | .159              |
| 11            | .160            | .161                  | .174                | .175              |
| 12            | .176            | .177                  | .190                | .191              |
| 13            | .192            | .193                  | .206                | .207              |
| 14            | .208            | .209                  | .222                | .223              |
| 15            | .224            | .225                  | .238                | .239              |
| 16            | .240            | .241                  | .254                | .255              |

## Addresses in the .248 Mask

Table D-8 lists valid addresses for the .248 subnet mask. This mask permits up to 32 subnets with enough host addresses for 6 hosts per subnet.

**Table D-8 .248 Network Mask Addresses**

| Subnet Number | Network Address | Starting Host Address | Ending Host Address | Broadcast Address |
|---------------|-----------------|-----------------------|---------------------|-------------------|
| 1             | .0              | .1                    | .6                  | .7                |
| 2             | .8              | .9                    | .14                 | .15               |
| 3             | .16             | .17                   | .22                 | .23               |
| 4             | .24             | .25                   | .30                 | .31               |
| 5             | .32             | .33                   | .38                 | .39               |
| 6             | .40             | .41                   | .46                 | .47               |
| 7             | .48             | .49                   | .54                 | .55               |
| 8             | .56             | .57                   | .62                 | .63               |
| 9             | .64             | .65                   | .70                 | .71               |
| 10            | .72             | .73                   | .78                 | .79               |
| 11            | .80             | .81                   | .86                 | .87               |
| 12            | .88             | .89                   | .94                 | .95               |
| 13            | .96             | .97                   | .102                | .103              |
| 14            | .104            | .105                  | .110                | .111              |

**Table D-8 .248 Network Mask Addresses (continued)**

| Subnet Number | Network Address | Starting Host Address | Ending Host Address | Broadcast Address |
|---------------|-----------------|-----------------------|---------------------|-------------------|
| 15            | .112            | .113                  | .118                | .119              |
| 16            | .120            | .121                  | .126                | .127              |
| 17            | .128            | .129                  | .134                | .135              |
| 18            | .136            | .137                  | .142                | .143              |
| 19            | .144            | .145                  | .150                | .151              |
| 20            | .152            | .153                  | .158                | .159              |
| 21            | .160            | .161                  | .166                | .167              |
| 22            | .168            | .169                  | .174                | .175              |
| 23            | .176            | .177                  | .182                | .183              |
| 24            | .184            | .185                  | .190                | .191              |
| 25            | .192            | .193                  | .198                | .199              |
| 26            | .200            | .201                  | .206                | .207              |
| 27            | .208            | .209                  | .214                | .215              |
| 28            | .216            | .217                  | .222                | .223              |
| 29            | .224            | .225                  | .230                | .231              |
| 30            | .232            | .233                  | .238                | .239              |
| 31            | .240            | .241                  | .246                | .247              |
| 32            | .248            | .249                  | .254                | .255              |

## Addresses in the .252 Mask

Table D-9 lists valid addresses for the .252 subnet mask. This mask permits up to 64 subnets with enough host addresses for 2 hosts per subnet.

**Table D-9 .252 Network Mask Addresses**

| Subnet Number | Network Address | Starting Host Address | Ending Host Address | Broadcast Address |
|---------------|-----------------|-----------------------|---------------------|-------------------|
| 1             | .0              | .1                    | .2                  | .3                |
| 2             | .4              | .5                    | .6                  | .7                |
| 3             | .8              | .9                    | .10                 | .11               |
| 4             | .12             | .13                   | .14                 | .15               |
| 5             | .16             | .17                   | .18                 | .19               |
| 6             | .20             | .21                   | .22                 | .23               |
| 7             | .24             | .25                   | .26                 | .27               |
| 8             | .28             | .29                   | .30                 | .31               |
| 9             | .32             | .33                   | .34                 | .35               |

**Table D-9 .252 Network Mask Addresses (continued)**

| Subnet Number | Network Address | Starting Host Address | Ending Host Address | Broadcast Address |
|---------------|-----------------|-----------------------|---------------------|-------------------|
| 10            | .36             | .37                   | .38                 | .39               |
| 11            | .40             | .41                   | .42                 | .43               |
| 12            | .44             | .45                   | .46                 | .47               |
| 13            | .48             | .49                   | .50                 | .51               |
| 14            | .52             | .53                   | .54                 | .55               |
| 15            | .56             | .57                   | .58                 | .59               |
| 16            | .60             | .61                   | .62                 | .63               |
| 17            | .64             | .65                   | .66                 | .67               |
| 18            | .68             | .69                   | .70                 | .71               |
| 19            | .72             | .73                   | .74                 | .75               |
| 20            | .76             | .77                   | .78                 | .79               |
| 21            | .80             | .81                   | .82                 | .83               |
| 22            | .84             | .85                   | .86                 | .87               |
| 23            | .88             | .89                   | .90                 | .91               |
| 24            | .92             | .93                   | .94                 | .95               |
| 25            | .96             | .97                   | .98                 | .99               |
| 26            | .100            | .101                  | .102                | .103              |
| 27            | .104            | .105                  | .106                | .107              |
| 28            | .108            | .109                  | .110                | .111              |
| 29            | .112            | .113                  | .114                | .115              |
| 30            | .116            | .117                  | .118                | .119              |
| 31            | .120            | .121                  | .122                | .123              |
| 32            | .124            | .125                  | .126                | .127              |
| 33            | .128            | .129                  | .130                | .131              |
| 34            | .132            | .133                  | .134                | .135              |
| 35            | .136            | .137                  | .138                | .139              |
| 36            | .140            | .141                  | .142                | .143              |
| 37            | .144            | .145                  | .146                | .147              |
| 38            | .148            | .149                  | .150                | .151              |
| 39            | .152            | .153                  | .154                | .155              |
| 40            | .156            | .157                  | .158                | .159              |
| 41            | .160            | .161                  | .162                | .163              |
| 42            | .164            | .165                  | .166                | .167              |
| 43            | .168            | .169                  | .170                | .171              |
| 44            | .172            | .173                  | .174                | .175              |

**Table D-9 .252 Network Mask Addresses (continued)**

| <b>Subnet Number</b> | <b>Network Address</b> | <b>Starting Host Address</b> | <b>Ending Host Address</b> | <b>Broadcast Address</b> |
|----------------------|------------------------|------------------------------|----------------------------|--------------------------|
| 45                   | .176                   | .177                         | .178                       | .179                     |
| 46                   | .180                   | .181                         | .182                       | .183                     |
| 47                   | .184                   | .185                         | .186                       | .187                     |
| 48                   | .188                   | .189                         | .190                       | .191                     |
| 49                   | .192                   | .193                         | .194                       | .195                     |
| 50                   | .196                   | .197                         | .198                       | .199                     |
| 51                   | .200                   | .201                         | .202                       | .203                     |
| 52                   | .204                   | .205                         | .206                       | .207                     |
| 53                   | .208                   | .209                         | .210                       | .211                     |
| 54                   | .212                   | .213                         | .214                       | .215                     |
| 55                   | .216                   | .217                         | .218                       | .219                     |
| 56                   | .220                   | .221                         | .222                       | .223                     |
| 57                   | .224                   | .225                         | .226                       | .227                     |
| 58                   | .228                   | .229                         | .230                       | .231                     |
| 59                   | .232                   | .233                         | .234                       | .235                     |
| 60                   | .236                   | .237                         | .238                       | .239                     |
| 61                   | .240                   | .241                         | .242                       | .243                     |
| 62                   | .244                   | .245                         | .246                       | .247                     |
| 63                   | .248                   | .249                         | .250                       | .251                     |
| 64                   | .252                   | .253                         | .254                       | .255                     |



## Supported VPN Standards and Security Proposals

---

This appendix lists the VPN standards supported by PIX Firewall. It contains the following sections:

- [IPSec, page E-1](#)
- [Internet Key Exchange \(IKE\), page E-2](#)
- [Certification Authorities \(CA\), page E-3](#)
- [Supported Easy VPN Proposals, page E-3](#)

### IPSec

- **IPSec—IP Security Protocol.** IPSec is a framework of open standards that provides data confidentiality, data integrity, and data authentication between participating peers. IPSec provides these security services at the IP layer; it uses IKE to handle negotiation of protocols and algorithms based on local policy and to generate the encryption and authentication keys to be used by IPSec. IPSec can be used to protect one or more data flows between a pair of hosts, between a pair of security gateways, or between a security gateway and a host.

IPSec is documented in a series of Internet RFCs, all available at the following website:

<http://www.ietf.org/html.charters/ipsec-charter.html>

The overall IPSec implementation is guided by “Security Architecture for the Internet Protocol,” RFC 2401.

- **Internet Key Exchange (IKE)—**A hybrid protocol that implements Oakley and SKEME key exchanges inside the Internet Security Association and Key Management Protocol (ISAKMP) framework. While IKE can be used with other protocols, its initial implementation is with the IPSec protocol. IKE provides authentication of the IPSec peers, negotiates IPSec security associations, and establishes IPSec keys.

IPSec as implemented in PIX Firewall supports the following additional standards:

- **AH—Authentication Header.** A security protocol that provides data authentication and optional anti-replay services. AH is embedded in the data to be protected (a full IP datagram).

The AH protocol (RFC 2402) allows for the use of various authentication algorithms; PIX Firewall has implemented the mandatory MD5-HMAC (RFC 2403) and SHA-HMAC (RFC 2404) authentication algorithms.

- ESP—Encapsulating Security Payload. A security protocol that provides data privacy services and optional data authentication, and anti-replay services. ESP encapsulates the data to be protected. The ESP protocol (RFC 2406) allows for the use of various cipher algorithms and (optionally) various authentication algorithms. The PIX Firewall implements the mandatory 56-bit DES-CBC with Explicit IV (RFC 2405); as the encryption algorithm, and MD5-HMAC (RFC 2403) or SHA-HMAC (RFC 2404) as the authentication.

## Internet Key Exchange (IKE)

IKE is implemented per “The Internet Key Exchange” (RFC 2409).

ISAKMP—The Internet Security Association and Key Management Protocol. A protocol framework that defines payload formats, the mechanics of implementing a key exchange protocol, and the negotiation of a security association.

ISAKMP is implemented per “Internet Security Association and Key Management Protocol (ISAKMP)” (RFC 2408).

Oakley—A key exchange protocol that defines how to derive authenticated keying material.

Skeme—A key exchange protocol that defines how to derive authenticated keying material, with rapid key refreshment.

The component technologies implemented for use by IKE include:

- DES—Data Encryption Standard (DES) is used to encrypt packet data. IKE implements the 56-bit DES-CBC with Explicit IV standard. See “CBC.”
- Triple DES (3DES)—A variant of DES, which iterates three times with three separate keys, effectively tripling the strength of DES.
- CBC—Cipher Block Chaining (CBC) requires an initialization vector (IV) to start encryption. The IV is explicitly given in the IPsec packet.
- Diffie-Hellman—A public-key cryptography protocol which allows two parties to establish a shared secret over an unsecure communications channel. Diffie-Hellman is used within IKE to establish session keys. 768-bit, 1024-bit, and 1536-bit Diffie-Hellman groups are supported.
- MD5 (HMAC variant)—Message Digest 5 (MD5) is a hash algorithm used to authenticate packet data. HMAC is a variant which provides an additional level of hashing.
- SHA (HMAC variant)—Secure Hash Algorithm (SHA) is a hash algorithm used to authenticate packet data. HMAC is a variant which provides an additional level of hashing.
- RSA signatures—RSA is the public key cryptographic system developed by Ron Rivest, Adi Shamir, and Leonard Adleman. RSA signatures provide non-repudiation.

IKE Extended Authentication (Xauth) is implemented per the IETF draft-ietf-ipsec-isakmp-xauth-04.txt (“extended authentication” draft). This provides this capability of authenticating a user within IKE using TACACS+ or RADIUS.

IKE Mode Configuration (IKE Mode Config) is implemented per the IETF draft-ietf-ipsec-isakmp-mode-cfg-04.txt. IKE Mode Configuration provides a method for a security gateway to download an IP address (and other network level configuration) to the VPN client as part of an IKE negotiation.

## Certification Authorities (CA)

IKE interoperates with the following standard:

X.509v3 certificates—Used with the IKE protocol when authentication requires public keys. Certificate support that allows the IPSec-protected network to scale by providing the equivalent of a digital ID card to each device. When two peers wish to communicate, they exchange digital certificates to prove their identities (thus removing the need to manually exchange public keys with each peer or to manually specify a shared key at each peer). These certificates are obtained from a certification authority (CA). X.509 is part of the X.500 standard by the ITU.

CA supports the following standards:

- X.509v3 certificates.
- Public-Key Cryptography Standard #7 (PKCS #7)—A standard from RSA Data Security, Inc. used to encrypt and sign certificate enrollment messages.
- Public-Key Cryptography Standard #10 (PKCS #10)—A standard syntax from RSA Data Security, Inc. for certificate requests.
- RSA Keys—RSA is the public key cryptographic system developed by Ron Rivest, Adi Shamir, and Leonard Adleman. RSA keys come in pairs: one public key and one private key.

## Supported Easy VPN Proposals

Table E-1 lists the IKE (Phase 1) security proposals supported by Cisco PIX Firewall when used with Easy VPN clients.

**Table E-1 Easy VPN Client IKE (Phase 1) Proposals**

| Proposal Name             | Authentication Mode    | Authentication Algorithm | Encryption Algorithm | Diffie- Hellman Group |
|---------------------------|------------------------|--------------------------|----------------------|-----------------------|
| CiscoVPNClient-3DES-MD5   | Preshared Keys (XAUTH) | MD5/HMAC-128             | 3DES-168             | Group 2 (1024 bits)   |
| CiscoVPNClient-3DES-SHA   | Preshared Keys (XAUTH) | SHA/HMAC-160             | 3DES-168             | Group 2 (1024 bits)   |
| CiscoVPNClient-DES-MD5    | Preshared Keys (XAUTH) | MD5/HMAC-128             | DES-56               | Group 2 (1024 bits)   |
| CiscoVPNClient-AES128-MD5 | Preshared Keys (XAUTH) | MD5/HMAC-128             | AES-128              | Group 2 (1024 bits)   |
| CiscoVPNClient-AES128-SHA | Preshared Keys (XAUTH) | SHA/HMAC-160             | AES-128              | Group 2 (1024 bits)   |
| CiscoVPNClient-AES192-MD5 | Preshared Keys (XAUTH) | MD5/HMAC-128             | AES-192              | Group 2 (1024 bits)   |
| CiscoVPNClient-AES192-SHA | Preshared Keys (XAUTH) | SHA/HMAC-160             | AES-192              | Group 2 (1024 bits)   |
| CiscoVPNClient-AES256-MD5 | Preshared Keys (XAUTH) | MD5/HMAC-128             | AES-256              | Group 2 (1024 bits)   |
| CiscoVPNClient-AES256-SHA | Preshared Keys (XAUTH) | SHA/HMAC-160             | AES-256              | Group 2 (1024 bits)   |
| IKE-3DES-MD5              | Preshared Keys         | MD5/HMAC-128             | 3DES-168             | Group 2 (1024 bits)   |
| IKE-3DES-SHA              | Preshared Keys         | SHA/HMAC-160             | 3DES-168             | Group 2 (1024 bits)   |
| IKE-DES-MD5               | Preshared Keys         | MD5/HMAC-128             | DES-56               | Group 2 (1024 bits)   |
| IKE-AES128-MD5            | Preshared Keys         | MD5/HMAC-128             | AES-128              | Group 2 (1024 bits)   |
| IKE-AES128-SHA            | Preshared Keys         | SHA/HMAC-160             | AES-128              | Group 2 (1024 bits)   |
| IKE-AES192-MD5            | Preshared Keys         | MD5/HMAC-128             | AES-192              | Group 2 (1024 bits)   |

Table E-1 Easy VPN Client IKE (Phase 1) Proposals (continued)

| Proposal Name                     | Authentication Mode             | Authentication Algorithm | Encryption Algorithm | Diffie- Hellman Group |
|-----------------------------------|---------------------------------|--------------------------|----------------------|-----------------------|
| IKE-AES192-SHA                    | Preshared Keys                  | SHA/HMAC-160             | AES-192              | Group 2 (1024 bits)   |
| IKE-AES256-MD5                    | Preshared Keys                  | MD5/HMAC-128             | AES-256              | Group 2 (1024 bits)   |
| IKE-AES256-SHA                    | Preshared Keys                  | SHA/HMAC-160             | AES-256              | Group 2 (1024 bits)   |
| CiscoVPNClient-3DES-MD5-RSA       | RSA Digital Certificate (XAUTH) | MD5/HMAC-128             | 3DES-168             | Group 2 (1024 bits)   |
| CiscoVPNClient-3DES-SHA-RSA       | RSA Digital Certificate (XAUTH) | SHA/HMAC-160             | 3DES-168             | Group 2 (1024 bits)   |
| CiscoVPNClient-DES-MD5-RSA-DH1    | RSA Digital Certificate (XAUTH) | MD5/HMAC-128             | DES-56               | Group 1 (768 bits)    |
| CiscoVPNClient-AES128-MD5-RSA     | RSA Digital Certificate (XAUTH) | MD5/HMAC-128             | AES-128              | Group 2 (1024 bits)   |
| CiscoVPNClient-AES128-SHA-RSA     | RSA Digital Certificate (XAUTH) | SHA/HMAC-160             | AES-128              | Group 2 (1024 bits)   |
| CiscoVPNClient-AES256-MD5-RSA     | RSA Digital Certificate (XAUTH) | MD5/HMAC-128             | AES-256              | Group 2 (1024 bits)   |
| CiscoVPNClient-AES256-SHA-RSA     | RSA Digital Certificate (XAUTH) | SHA/HMAC-160             | AES-256              | Group 2 (1024 bits)   |
| CiscoVPNClient-3DES-MD5-RSA-DH5   | RSA Digital Certificate (XAUTH) | MD5/HMAC-128             | 3DES-168             | Group 5 (1536 bits)   |
| CiscoVPNClient-3DES-SHA-RSA-DH5   | RSA Digital Certificate (XAUTH) | SHA/HMAC-160             | 3DES-168             | Group 5 (1536 bits)   |
| CiscoVPNClient-AES128-MD5-RSA-DH5 | RSA Digital Certificate (XAUTH) | MD5/HMAC-128             | AES-128              | Group 5 (1536 bits)   |
| CiscoVPNClient-AES128-SHA-RSA-DH5 | RSA Digital Certificate (XAUTH) | SHA/HMAC-160             | AES-128              | Group 5 (1536 bits)   |
| CiscoVPNClient-AES192-MD5-RSA-DH5 | RSA Digital Certificate (XAUTH) | MD5/HMAC-128             | AES-192              | Group 5 (1536 bits)   |
| CiscoVPNClient-AES192-SHA-RSA-DH5 | RSA Digital Certificate (XAUTH) | SHA/HMAC-160             | AES-192              | Group 5 (1536 bits)   |
| CiscoVPNClient-AES256-MD5-RSA-DH5 | RSA Digital Certificate (XAUTH) | MD5/HMAC-128             | AES-256              | Group 5 (1536 bits)   |
| CiscoVPNClient-AES256-SHA-RSA-DH5 | RSA Digital Certificate (XAUTH) | SHA/HMAC-160             | AES-256              | Group 5 (1536 bits)   |
| IKE-3DES-MD5-RSA                  | RSA Digital Certificate         | MD5/HMAC-128             | 3DES-168             | Group 2 (1024 bits)   |
| IKE-3DES-SHA-RSA                  | RSA Digital Certificate         | SHA/HMAC-160             | 3DES-168             | Group 2 (1024 bits)   |
| IKE-AES128-MD5-RSA                | RSA Digital Certificate         | MD5/HMAC-128             | AES-128              | Group 2 (1024 bits)   |
| IKE-AES128-SHA-RSA                | RSA Digital Certificate         | SHA/HMAC-160             | AES-128              | Group 2 (1024 bits)   |
| IKE-AES256-MD5-RSA                | RSA Digital Certificate         | MD5/HMAC-128             | AES-256              | Group 2 (1024 bits)   |
| IKE-AES256-SHA-RSA                | RSA Digital Certificate         | SHA/HMAC-160             | AES-256              | Group 2 (1024 bits)   |

**Table E-1 Easy VPN Client IKE (Phase 1) Proposals (continued)**

| Proposal Name          | Authentication Mode     | Authentication Algorithm | Encryption Algorithm | Diffie- Hellman Group |
|------------------------|-------------------------|--------------------------|----------------------|-----------------------|
| IKE-DES-MD5-RSA-DH1    | RSA Digital Certificate | MD5/HMAC-128             | DES-56               | Group 1 (768 bits)    |
| IKE-3DES-MD5-RSA-DH5   | RSA Digital Certificate | MD5/HMAC-128             | 3DES-168             | Group 5 (1536 bits)   |
| IKE-3DES-SHA-RSA-DH5   | RSA Digital Certificate | SHA/HMAC-160             | 3DES-168             | Group 5 (1536 bits)   |
| IKE-AES128-MD5-RSA-DH5 | RSA Digital Certificate | MD5/HMAC-128             | AES-128              | Group 5 (1536 bits)   |
| IKE-AES128-SHA-RSA-DH5 | RSA Digital Certificate | SHA/HMAC-160             | AES-128              | Group 5 (1536 bits)   |
| IKE-AES192-MD5-RSA-DH5 | RSA Digital Certificate | MD5/HMAC-128             | AES-192              | Group 5 (1536 bits)   |
| IKE-AES192-SHA-RSA-DH5 | RSA Digital Certificate | SHA/HMAC-160             | AES-192              | Group 5 (1536 bits)   |
| IKE-AES256-MD5-RSA-DH5 | RSA Digital Certificate | MD5/HMAC-128             | AES-256              | Group 5 (1536 bits)   |
| IKE-AES256-SHA-RSA-DH5 | RSA Digital Certificate | SHA/HMAC-160             | AES-256              | Group 5 (1536 bits)   |

Table E-2 lists the Phase 2 security proposals supported by Easy VPN clients.

**Table E-2 Easy VPN Client Phase 2 Proposals**

| AES256 | MD5 <sup>1</sup> |
|--------|------------------|
| AES256 | SHA              |
| AES128 | MD5              |
| AES128 | SHA              |
| AES256 | MD5              |
| AES256 | SHA              |
| AES128 | MD5              |
| AES128 | SHA              |
| 3DES   | MD5              |
| 3DES   | SHA              |
| 3DES   | MD5              |
| 3DES   | SHA              |
| DES    | MD5              |
| DES    | MD5              |
| NULL   | MD5              |
| NULL   | SHA              |

1. PIX Firewall does not support IP compression.





---

## A

### AAA

- configuring [3-8](#)
- exemption for MAC addresses [3-13](#)
- support for [1-6](#)
- with web clients [3-10](#)

### abbreviating commands [1-27](#)

### access control

- example [3-14](#)
- features [1-6](#)
- services [3-16](#)

### access control lists

See ACLs

### access modes [1-25](#)

### ACLs

- applying to object groups [3-27](#)
- comments [3-18](#)
- conversion tool [1-7](#)
- downloading [3-20](#)
- ICMP [2-22](#)
- instead of conduits and outbounds [1-7](#)
- IPSec [6-17](#)
- named [3-21](#)
- TurboACL
  - configuring [3-18](#)
  - description [1-7](#)

### active state, failover [10-3](#)

### ActiveX controls

- blocking [1-10](#)

### ACT light [10-21](#)

### Adaptive Security Algorithm

See ASA

### addresses

- global [2-11](#)
- IP [2-5](#)
- IP classes [2-5](#)

### Address Resolution Protocol

See ARP

### address translation

- See NAT
- See PAT

### AES [1-15, 6-3](#)

### AH

- configuring [6-27](#)
- standard [E-1](#)

### application inspection

- configuring [5-1 to 5-35](#)
- feature [1-11](#)

### ARP

- clearing [2-4](#)
- packet capture, example [9-30](#)

### ARP test [10-7](#)

### ASA [1-3, 5-1](#)

### attacks

- protection from [1-8](#)
- authenticating web clients [3-10](#)

### authentication, accounting, and authorization

See AAA

### Authentication Header

See AH

### Auto-Update

- configuring [9-25 to 9-27](#)
- description [1-22](#)

**B**

- backing up configurations [1-27](#)
- Baltimore Technologies
  - CA server support [6-9](#)
- blocking
  - ActiveX controls [1-10](#)
  - Java applets [1-10](#)
- boot diskette
  - creating [11-12](#)
- Broadcast Ping test [10-8](#)
- broadcasts
  - See multicasts
- buffer usage
  - SNMP [9-42](#)

**C**

- CA
  - configuring in-house [7-13](#)
  - configuring VeriSign [7-7](#)
  - CRs, and [6-9](#)
  - defined [1-16](#)
  - public key cryptography [6-8](#)
  - revoked certificates [6-9](#)
  - supported servers [6-9](#)
  - validating signature [6-8](#)
- cable-based failover
  - See failover
- capturing packets
  - feature [1-22](#)
  - procedure [9-27](#)
- CBC [E-2](#)
- certificate enrollment protocol [6-9](#)
- Certificate Revocation Lists
  - See CRLs
- certification authority
  - See CA
- CHAP [8-20](#)

- Cipher Block Chaining
  - See CBC
- Cisco Catalyst 6500 VPN Service Module [7-25](#)
- Cisco Intrusion Detection System
  - See IDS
- Cisco IOS CLI [1-25](#)
- Cisco IP Phones
  - AAA exemption [3-13](#)
  - application inspection [5-21](#)
  - with DHCP [4-19](#)
- Cisco Secure Intrusion Detection System
  - See IDS
- Cisco Secure VPN Client
  - configuring [B-16 to B-20](#)
  - using with Telnet [9-19](#)
- Cisco VPN 3000 Client
  - configuring [8-19](#)
  - downloading network parameters to [8-8](#)
- Cisco Works for Windows [9-45](#)
- CLI
  - abbreviating commands [1-27](#)
  - configuration mode [1-26](#)
  - editing with [1-27](#)
  - paging [1-29](#)
  - using PIX Firewall [1-25](#)
- client mode
  - configuring [4-4](#)
  - description [4-3](#)
- clients
  - Cisco Secure VPN Client [B-19](#)
  - Cisco VPN 3000 Client [8-19](#)
  - Easy VPN Remote device [4-1](#)
  - Windows 2000 [B-11](#)
- clock, system [9-15](#)
- Command Authorization [9-5 to 9-7](#)
  - caution when using [9-6](#)
  - description [1-21](#)
  - recovering from lockout [9-9](#)
- command line interface



- See CLI
  - commands
    - command line editing [1-28](#)
    - command output paging [1-29](#)
    - configuring privilege levels [9-2 to 9-3](#)
    - creating comments [1-29](#)
    - displaying [1-29](#)
  - commenting
    - ACLs [3-18](#)
  - compiling MIBs [9-45](#)
  - Computer Telephony Interface Quick Buffer Encoding
    - See CTIQBE
  - conduits
    - converting to ACLs [1-8](#)
    - defined [1-8](#)
    - using ACLs instead [1-8](#)
  - Configurable Proxy Pinging
    - description [1-10](#)
  - configuration examples
    - See examples
  - configuration file, failover
    - See failover
  - configuration mode [1-26](#)
  - configurations [1-29](#)
    - backing up [1-27](#)
    - comments [1-29](#)
    - copying with HTTP [11-5](#)
    - maximum size [1-29](#)
    - saving [2-3, 2-24](#)
  - connection states [1-4](#)
  - connectivity
    - inbound [3-2](#)
    - outbound [3-4](#)
    - testing [2-22](#)
  - conversion tool
    - conduits to ACLs [1-7](#)
  - copying
    - configurations [11-5](#)
    - software [11-5](#)
  - CPU utilization
    - SNMP [9-42](#)
  - CRLs
    - time restrictions [6-9](#)
  - crypto maps
    - applying to interfaces [6-17](#)
    - entries [6-15](#)
    - load sharing [6-28](#)
    - See also dynamic crypto maps
  - CTIQBE [1-12, 5-14](#)
  - CU-SeeMe application inspection [5-15](#)
  - cut-through proxy [1-6](#)
- 
- D**
- database application inspection [5-30](#)
  - Data Encryption Standard
    - See DES
  - debug fover command [10-21](#)
  - debugging
    - IPSec [B-15](#)
    - SMR [2-48](#)
  - default configurations [1-30](#)
  - default routes [2-3](#)
  - demilitarized zone
    - See DMZ
  - denial of service attacks
    - protection from [1-9](#)
  - DES
    - description [E-2](#)
    - IKE policy keywords (table) [6-3](#)
  - DHCP clients
    - configuration [4-21 to 4-22](#)
    - default route [4-21](#)
    - described [1-20](#)
    - PAT global address [4-21](#)
  - DHCP leases
    - renewing [4-22](#)
    - viewing [4-22](#)

- DHCP Relay [1-20, 4-20](#)
  - DHCP servers [1-19, 4-15](#)
    - configuring [4-17](#)
    - with Cisco IP Phones [4-19](#)
  - Diffie-Hellman
    - defined [E-2](#)
    - groups supported [6-3](#)
  - directory application inspection [5-30](#)
  - DMZ
    - configuration example [2-29](#)
  - DNS
    - application inspection [5-6](#)
    - inbound access [3-4](#)
    - protection from attacks [1-9](#)
  - downgrading software [11-13](#)
  - downloading
    - ACLs [3-20](#)
    - IP addresses to VPN Clients [8-7](#)
    - network parameters to Cisco VPN 3000 Client [8-8](#)
  - dynamic crypto maps
    - adding to crypto maps [6-23](#)
    - entries [6-23](#)
    - referencing [6-23](#)
    - See also crypto maps [6-24](#)
    - sets [6-23](#)
  - Dynamic Host Configuration Protocol
    - See DHCP clients
    - See DHCP leases
    - See DHCP servers
  - dynamic NAT [2-8](#)
  - dynamic PAT [2-8](#)
- 
- E**
- Easy VPN Remote device
    - configuring [4-1 to 4-5](#)
    - described [1-18](#)
  - Easy VPN Server [8-1 to 8-6](#)
    - described [1-18](#)
  - identifying [4-4](#)
  - load balancing [1-18](#)
  - using PIX Firewall with [4-2, 8-3](#)
  - editing command lines [1-28](#)
  - EIGRP
    - not supported [B-2](#)
  - Encapsulating Security Payload
    - See ESP
  - Enhanced Interior Gateway Routing Protocol
    - See EIGRP
  - Entrust VPN Connector CA [7-14](#)
  - ESP
    - configuring [6-28](#)
    - standard [E-2](#)
  - examples
    - access control [3-14](#)
    - Cisco Catalyst 6500 VPN Service Module [7-25](#)
    - crypto maps [6-18](#)
    - IKE Mode Config [B-16](#)
    - IPSec with manual keys [7-35](#)
    - OSPF [2-17](#)
    - outside NAT [2-38](#)
    - outside NAT with overlapping networks [2-39](#)
    - packet capture [9-30](#)
    - port redirection [3-6](#)
    - pre-shared keys [7-2](#)
    - RADIUS authorization [8-8](#)
    - three interfaces with NAT and PAT [2-31](#)
    - three interfaces without NAT [2-29](#)
    - two interfaces with NAT and PAT [2-27](#)
    - two interfaces without NAT [2-25](#)
    - VeriSign CA [7-7](#)
    - VLANs [2-35](#)
    - VPN with manual keys [7-35](#)
    - wildcard pre-shared key [B-16](#)
    - Windows 2000 VPN client [B-12](#)
    - Xauth [B-16](#)
  - Extended Authentication
    - see Xauth

## F

- factory defaults
  - See default configurations [1-30](#)
- failover
  - active state [10-3](#)
  - cable-based [10-9](#)
  - changing from cable to LAN-based [10-12](#)
  - changing from LAN to cable-based [10-20](#)
  - configuration file
    - console messages [10-7](#)
    - Flash memory [10-6](#)
    - LAN-based differences [10-6](#)
    - replication [10-6](#)
    - running memory [10-6](#)
  - debugging [10-21](#)
  - disabling [10-20](#)
  - display [10-17](#)
  - enabling [10-11](#)
  - encrypting communications [10-15](#)
  - Ethernet failover cable [10-5](#)
  - Ethernet interface settings [10-9](#)
  - examples [10-25](#)
  - FAQs [10-21](#)
  - forcing [10-20](#)
  - interface tests [10-7](#)
  - IP addresses [10-3](#)
  - LAN-based [10-11](#)
  - link communications [10-4](#)
  - MAC addresses [10-6](#)
  - models, supported [10-2](#)
  - models supporting [1-24](#)
  - network connections [10-3](#)
  - network tests [10-7](#)
  - power loss [10-7](#)
  - prerequisites [10-8](#)
  - primary unit [10-6](#)
  - secondary unit [10-6](#)
  - serial cable [10-5](#)
  - software versions [10-2](#)
  - standby state [10-3](#)
  - Stateful Failover [10-3](#)
    - identifying the link [10-11](#)
    - overview [10-3](#)
    - state information [10-3](#)
    - state link requirements [10-5](#)
    - statistics [10-19](#)
  - switch configuration [10-8](#)
  - syslog messages [10-21](#)
  - syslog messages, SNMP [9-42](#)
  - system requirements [10-2](#)
  - testing [10-19](#)
  - triggers [10-7](#)
  - verifying [10-17](#)
- File Transfer Protocol
  - See FTP
- filtering
  - ActiveX controls [1-10](#)
  - FTP [3-34](#)
  - HTTPS [3-34](#)
  - Java applets [1-10](#)
  - servers supported [1-10](#)
  - show command output [1-28](#)
  - URLs [1-10](#)
- fixup
  - See application inspection
- Flood Guard [1-9](#)
- FO license [10-2](#)
- FragGuard [1-9](#)
- FTP
  - application inspection [5-7](#)
  - downloading software using [11-8](#)
  - filtering [3-34](#)
  - logging [1-23](#)
  - packet capture, example [9-30](#)
  - redirecting [3-7](#)
  - secondary ports [1-11](#)
- full duplex [2-6](#)

**G**

- gateway addresses [2-12](#)
- generating RSA keys [6-10](#)
- global addresses
  - specifying [2-11](#)
- global lifetimes
  - changing [6-19](#)
- Group 5
  - Diffie Hellman [6-3](#)

**H**

- H.245 tunneling [5-16](#)
- H.323 [5-10, 5-16](#)
  - changing default port assignments [5-7](#)
- hardware clients
  - See Easy VPN Remote device
  - using in SOHO networks [4-3](#)
- hardware speed
  - requirements for Stateful Failover [2-6](#)
- help, command line [1-30](#)
- home offices
  - See SOHO networks
- HTTP
  - application inspection [5-9](#)
  - copying configurations [11-5](#)
  - copying software [11-5](#)
  - filtering [1-10, 3-34](#)
  - filtering HTTPS [3-34](#)
  - packet capture, example [9-30](#)
  - redirecting [3-7](#)
  - server access [3-1](#)
- Hypertext Translation Protocol
  - See HTTP

**I**

- IANA URL [D-5](#)

**ICMP**

- application inspection [5-9, 5-34](#)
- Configurable Proxy Pinging [1-10](#)
- configuring object groups [3-29](#)
- message reassembly [1-9](#)
- testing connectivity [2-21](#)
- testing default routes [2-24](#)

**ICMP-type object groups**

- configuring [3-29](#)

**IDS**

- support for [1-23](#)
- using [9-39 to 9-41](#)

**IGMP**

- support for [1-14](#)

**IKE**

- benefits [6-2](#)
- creating policies [6-4](#)
- description [1-16](#)
- disabling [6-6](#)
- policy parameters [6-3](#)
- policy priority numbers [6-4](#)
- using with pre-shared keys [6-6](#)
- Xauth [8-5, 8-6, 8-17, B-17](#)

**IKE Mode Config**

- exceptions for security gateways [B-21](#)
- standard [E-2](#)

**IKE Mode Configuration**

- See IKE Mode Config

**ILS**

- application inspection [5-31](#)
- feature [1-14](#)

**IM** [5-26](#)**images, software**

- See also software images
- upgrading [1-24, 11-5 to 11-16](#)

**inbound connectivity** [3-2](#)**Individual user authentication**

- See IUA

**in-house CA, configuring** [7-13](#)

## Instant Messaging

See IM

## interfaces

assigning names [2-5](#)

changing names [2-6](#)

configuring [2-4](#)

global address [2-11](#)

logical [2-34](#)

perimeter [2-10](#)

security levels and [1-4](#)

speed [2-6](#)

## Internet Group Management Protocol

See IGMP

## Internet Key Exchange

See IKE

## Internet Locator Service

See ILS

## Internet Security Association and Key Management Protocol

See ISAKMP

## Intrusion Detection System

See IDS

## IOS

See Cisco IOS CLI

## IP

datagrams [B-9](#)

viewing configuration [2-5](#)

## IP addresses

configuring

address, IP addresses [2-5](#)

## IP Phones

See Cisco IP Phones

## IPSec

ACLs [6-17](#)

clearing SAs [6-29](#)

configuring [6-13](#)

crypto map entries [6-15](#)

crypto map load sharing [6-28](#)

defined [1-15](#)

enabling debug [B-15](#)

manual [6-19](#)

manual SAs using pre-shared keys [6-15](#)

modes [B-9](#)

proxies [B-9](#)

viewing configuration [6-29](#)

viewing information [6-29](#)

## IP Security Protocol

See IPSec

## IP spoofing

protection from [1-9](#)

ISAKMP [E-2](#)

## IUA

described [1-18](#)

Easy VPN Remote device [4-8](#)

enabled on Easy VPN Server [8-4](#)

---

**J**

## Java applets

filtering [1-10, 3-31](#)

---

**L**

## L2TP

configuring [B-10](#)

configuring Windows 2000 client [B-11, B-14](#)

description [B-9](#)

transport mode [B-10](#)

## LAN-based failover

See failover

## LAN-to-LAN VPNs

See site-to-site VPNs

## Layer 2 Tunneling Protocol

See L2TP [B-9](#)

## LDAP

application inspection [5-31](#)

ILS [1-14](#)

lease

- releasing DHCP [4-22](#)
- renewing DHCP [4-22](#)

licenses, software

- See also UR licenses
- upgrading [1-24, 11-2 to 11-5](#)

Link Up/Down test [10-7](#)

link up and link down, SNMP [9-42](#)

load sharing with crypto maps [6-28](#)

LOCAL database

- Command Authorization with [9-6](#)
- user authentication to the PIX Firewall with [9-3](#)

lockout

- recovering from [9-9](#)

logging

- ACL activity [9-35](#)
- FTP [1-23](#)
- Syslog [9-33](#)
- URLs [1-23](#)

logical interfaces [2-34](#)

---

## M

MAC addresses, failover [10-6](#)

MAC-based AAA exemption [3-13](#)

manual configuration of SAs [6-26](#)

MD5 [6-3](#)

- description [E-1, E-2](#)
- IKE policy keywords (table) [6-3](#)

Message Digest 5

- See MD5

MIBs [9-41](#)

- MIB II groups [9-41](#)
- updating file [9-45](#)

Microsoft Challenge Handshake Authentication Protocol

- See MS-CHAP

Microsoft Exchange

- configuring [C - 1](#)

Microsoft Remote Procedure Call

- See MSRPC

Microsoft Windows 2000 CA

- supported [6-9, 7-14](#)

modes

- See access modes

monitor mode

- description [1-26](#)
- using [11-9](#)

More prompt [1-29](#)

MS-CHAP [8-20](#)

MSRPC

- See also RPC

multicasts

- forwarding [2-46](#)
- receiving [2-44](#)
- support for [1-14](#)

multimedia applications

- supported [1-13, D - 6](#)

multiple interfaces

- configuring, example of [2-29](#)
- security levels with [1-4](#)

---

## N

N2H2 filtering server

- identifying [3-32](#)
- supported [1-10](#)
- URL for website [1-10](#)

named ACLs

- downloading [3-21](#)

NAT

- application inspection [1-11](#)
- configuring [2-9](#)
- description [1-5](#)
- dynamic [2-8](#)
- function [2-7](#)
- outside [2-37, 2-38](#)
- overlapping networks [2-39](#)
- policy [2-40](#)

- RCP not supported with [5-32](#)
- RTSP not supported with [1-13](#)
- server access [3-1](#)
- static [2-8](#)
- three interfaces [2-31](#)
- two interfaces (figure) [2-27](#)
- NAT Traversal [6-25](#)
- nesting object groups [3-29](#)
- NetBIOS
  - support for [1-14](#)
- netmask
  - See subnet mask
- Netshow
  - application inspection [5-27](#)
- Network Activity test [10-7](#)
- Network Address Translation
  - See NAT
- network extension mode
  - configuring [4-4](#)
  - description [4-3](#)
- Network File System
  - See NFS
- network object groups
  - configuring [3-28](#)
- Network Time Protocol
  - See NTP
- NFS
  - access [5-32](#)
  - application inspection [5-32](#)
  - testing with showmount [5-32](#)
- NT
  - See Windows NT
- NTP
  - configuring [9-11 to 9-15](#)
  - feature [1-22](#)

---

## O

- Oakley key exchange protocol [E-2](#)

- object groups
  - applying ACLs to [3-27](#)
  - configuring [3-24 to 3-30](#)
  - feature [1-8](#)
  - ICMP-type [3-29](#)
  - nesting [3-29](#)
  - network [3-28](#)
  - port [3-28](#)
  - protocols [3-28](#)
  - removing [3-30](#)
  - service [3-28](#)
  - subcommand mode [3-25](#)
  - verifying [3-27](#)
- OSPF [2-14 to 2-21](#)
- outbound connectivity [3-4](#)
- outside NAT
  - configuring [2-37 to 2-40](#)
  - example [2-38](#)
- overlapping networks
  - configuring [2-39](#)
  - example [2-39](#)

---

## P

- packet capture
  - configuring [9-27 to 9-31](#)
  - feature [1-22](#)
  - formats (table) [9-29](#)
  - viewing buffer [9-28](#)
- paging screen displays [1-29](#)
- PAP
  - supported [8-20](#)
- Password Authentication Protocol
  - See PAP
- PAT
  - addresses [2-11](#)
  - application inspection [1-11](#)
  - configuring [2-9](#)
  - DHCP clients and [4-21](#)

- dynamic [2-8](#)
- function [2-3, 2-7](#)
- RTSP [5-29](#)
- server access [3-1](#)
- static [2-8](#)
- three interfaces [2-31](#)
- two interfaces [2-27](#)
- PCNFSD, tracking activity [5-32](#)
- perimeter interfaces [2-10](#)
- perimeter networks
  - See DMZ
- per-user access lists [1-7](#)
- PFSS
  - executable file [11-7](#)
- phases, of IPsec [1-16](#)
- ping
  - See ICMP
- PIX 501
  - DHCP client configuration [4-21](#)
  - DHCP client feature support [1-20](#)
  - failover not supported [1-24](#)
  - using as Easy VPN Remote device [4-2, 8-3](#)
- PIX 506/506E
  - DHCP client configuration [4-21](#)
  - DHCP client feature support [1-20](#)
  - failover not supported [1-24](#)
  - using as Easy VPN Remote device [4-2, 8-3](#)
- PIX 520
  - backing up configuration [1-27](#)
- PIX Firewall Syslog Server
  - See PFSS
- PIX Firewall VPN Client [4-3](#)
  - See Easy VPN Remote device
- PKCS [E-3](#)
- PKI protocol [6-9](#)
- Point-to-Point Tunneling Protocol
  - See PPTP
- policy NAT [2-40](#)
- Port Address Translation
  - See PAT [1-32, 2-11](#)
- PORT command, FTP [5-7](#)
- port redirection [3-5](#)
- ports
  - object groups [3-28](#)
- PPPoE
  - configuring [4-11 to 4-15](#)
  - description [1-19](#)
  - packet capture, example [9-31](#)
- PPTP
  - inbound access [3-4](#)
  - VPNs [8-20](#)
- pre-shared keys
  - configuring [7-1](#)
  - description [1-16](#)
  - example [7-2](#)
  - using with IKE [6-6](#)
- primary Easy VPN Server [4-4](#)
- primary unit, failover [10-6](#)
- Private Certificate Services (PCS) [7-14](#)
- privilege levels
  - configuring [9-2 to 9-3](#)
  - description [1-21](#)
  - viewing [9-5](#)
- protocols
  - object groups [3-28](#)
  - packet capture formats (table) [9-29](#)
  - port numbers [D - 5](#)
  - supported [1-11](#)
- proxy servers
  - SIP and [5-24](#)
- public key cryptography [6-8](#)
- Public-Key Cryptography Standard
  - See PKCS
- Public Key Infrastructure Protocol
  - See PKI protocol



**R****RADIUS**

- configuring [3-9](#)
- support for [1-6](#)
- viewing user accounts for Command Authorization [9-5](#)
- VPN example [8-8](#)
- Xauth [8-5](#)

**RAS**

- support for [1-12](#)

**Real Time Streaming Protocol**

- See RTSP

**recovering from lockout** [9-9](#)**redirecting service requests** [3-5](#)**redundancy**

- See failover

**Registration, Admission, and Status**

- See RAS

**Registration Authority**

- description [6-9](#)

**releasing DHCP lease** [4-22](#)**remote access VPN**

- configuring [8-1 to 8-21](#)
- description [1-18](#)

**Remote Authentication Dial-In User Server**

- See RADIUS

**Remote Procedure Call**

- See RPC

**renewing DHCP lease** [4-22](#)**reverse route lookup**

- See Unicast RPF

**revoked certificates** [6-9](#)**RFC 2637** [8-20](#)**RIP**

- PIX Firewall listening [2-12](#)
- support for [1-6](#)

**routing**

- default routes [2-3](#)
- enabling SMR [2-43](#)

simplifying with outside NAT [2-38](#)static routes [2-12](#)**Routing Information Protocol**

- See RIP

**RPC**application inspection [5-32](#)Sun [5-32](#)testing with rpcinfo [5-32](#)

- See also MSRPC

**RS-232 cable**

- See failover [10-5](#)

**RSA keys**

- described [E-3](#)
- generating [6-10](#)

**RSA signatures**

- IKE authentication method [6-8, E-2](#)

**RTSP**changing default port assignments [5-29](#)restrictions [5-29](#)support for [1-13](#)**S****SAs**clearing IPsec [6-29](#)description [1-15](#)establishing manual with pre-shared keys [6-15](#)lifetimes [6-19](#)saving configurations [2-3, 2-24](#)Command Authorization (caution) [9-6](#)upgrading versions (caution) [11-1](#)**SCCP**support for [1-12](#)secondary Easy VPN Server [4-4](#)secondary unit, failover [10-6](#)**Secure Hash Algorithm**

- See SHA

**Secure Shell**

- See SSH

- Secure unit authentication
  - See SUA
- security associations
  - See SAs
- security gateways
  - exceptions to IKE Mode Config [B-21](#)
  - exception to Xauth [B-21](#)
- security levels [1-4](#)
  - interfaces [2-6](#)
  - values [2-7](#)
- serial cable
  - See failover
- server access [3-1](#)
- services
  - access control [3-16](#)
  - object groups [3-28](#)
- Session Initiation Protocol
  - See SIP
- SHA
  - IKE policy keywords (table) [6-3](#)
- show command
  - filtering output [1-28](#)
- show commands [6-29](#)
- show failover command [10-17](#)
- showmount command
  - application inspection with [5-32](#)
- Simple Client Control Protocol
  - See SCCP
- Simple Mail Transfer Protocol
  - See SMTP
- Simple Network Management Protocol
  - See SNMP
- SIP [1-13, 5-23](#)
  - application inspection [5-23](#)
- site-to-site VPNs
  - description [1-17](#)
  - examples [7-1 to 7-38](#)
  - exception to IKE Mode Config [B-21](#)
  - exception to Xauth [B-21](#)
- redundancy [6-25](#)
  - See also VPNs
- Skeme key exchange protocol [E-2](#)
- Skinnny Client Control Protocol
  - See SCCP
- small office, home office networks
  - See SOHO networks
- SMR
  - description [1-14](#)
  - enabling [2-43](#)
- SMTP
  - application inspection [5-11](#)
  - protection from attacks [1-9](#)
- sniffing packets
  - See packet capture
- SNMP
  - Cisco syslog MIB [9-45](#)
  - read-only (RO) values [9-41](#)
  - SNMPc (Cisco Works for Windows) [9-45](#)
  - support for [1-22](#)
  - traps [9-41](#)
  - using [9-41 to 9-51](#)
- software
  - copying with HTTP [11-5](#)
  - downgrading [11-13](#)
  - downloading [11-6](#)
  - downloading with FTP [11-8](#)
  - downloading with HTTP [11-7](#)
  - upgrading system [1-24](#)
- SOHO networks
  - configuring [4-1 to 4-22](#)
  - features [1-19](#)
- SSH [9-21 to 9-25](#)
- standby state, failover [10-3](#)
- Stateful Failover [1-3](#)
  - See failover
- state information [1-4, 10-3](#)
- state link [10-5](#)
- static

- NAT for server access [3-1](#)
- translation [1-5](#)
- static NAT
  - description [2-8](#)
- static PAT
  - description [2-8](#)
- static routes
  - configuring [2-13](#)
- stub multicast routing
  - See SMR
- SUA
  - described [1-18](#)
  - Easy VPN Remote device [4-6](#)
- subcommand mode [1-26](#)
- subnet masks [D-8](#)
  - configuring [2-5](#)
- subnets [2-11](#)
- Sun RPC [5-32](#)
- switch configuration, failover [10-8](#)
- syslog
  - Cisco MIB [9-45](#)
  - MIB files [9-45](#)
  - SNMP [9-42](#)
  - SNMP traps [9-44](#)
  - support for [1-23](#)
- system clock [9-15](#)
- system recovery [11-12](#)

---

## T

- TACACS+
  - caution when using with Command Authorization [9-8](#)
  - inbound access [3-4](#)
  - using with Command Authorization [9-8](#)
  - viewing user accounts for Command Authorization [9-5](#)
  - Xauth [8-5](#)
- Telephony API
  - See CTIQBE
- Telnet

- configuring [9-16 to 9-21](#)
- interfaces [1-22](#)
- outside interfaces [9-18](#)
- redirecting [3-7](#)
- Terminal Access Controller Access Control System Plus
  - See TACACS+
- testing connectivity [2-3, 2-22](#)
- TFTP servers
  - downloading with HTTP [11-7](#)
  - using to download software [1-24](#)
- time, setting system [9-15](#)
- tools
  - conversion for conduits to ACLs [1-8](#)
- Trace Channel
  - description [9-21](#)
  - disadvantages (note) [9-21](#)
- transform sets
  - configuring [6-26](#)
  - description [6-15](#)
- transport mode
  - description [B-9](#)
- traps, SNMP [9-41](#)
- Triple DES
  - description [E-2](#)
  - IKE policy keyword (table) [6-3](#)
- Trivial File Transfer Protocol servers
  - See TFTP servers
- troubleshooting
  - connectivity [2-3, 2-22](#)
  - license upgrades [11-4](#)
  - See also packet capture
- tunnel mode [B-9](#)
- TurboACL [1-7, 3-18](#)
  - configuring [3-18 to 3-20](#)
  - viewing configuration [3-20](#)

---

## U

- UDP

- connection state information [1-4](#)
- Unicast Reverse Path Forwarding
  - See Unicast RPF
- Unicast RPF [1-9](#)
- UniCERT Certificate Management System
  - configuring, example [7-14](#)
  - supported [6-9](#)
- Universal Resource Locators
  - See URLs
- unprivileged mode [1-25](#)
- upgrading
  - feature licenses [1-24](#)
  - image [11-6 to 11-16](#)
  - images [1-24](#)
- UR license [10-2](#)
- URLs
  - filtering [1-10](#)
  - filtering, configuration [3-39](#)
  - logging [1-23](#)
- user authentication
  - See also Xauth
  - to the PIX Firewall [9-3](#)
- User Datagram Protocol
  - See UDP
- privilege levels [9-5](#)
- RMS [9-26](#)
- SMR configuration [2-48](#)
- SSH [9-24](#)
  - user accounts for Command Authorization [9-5](#)
- Virtual Private Networks
  - See VPNs
- Virtual Re-assembly [1-9](#)
- VLANs
  - configuration [2-33 to 2-37](#)
  - defined [1-8](#)
- Voice over IP
  - See VoIP
- VOIP
  - SCCP [1-12](#)
- VoIP
  - application inspection [5-14, 5-24](#)
  - gateways and gatekeepers [5-16](#)
  - proxy servers [5-24](#)
  - SIP
    - description [1-13](#)
- VPN clients
  - Easy VPN Remote device [4-1](#)
  - modes [4-3](#)
  - SOHO networks and [4-1](#)

---

## V

- validating CAs [6-8](#)
- VDO LIVE [5-30](#)
- VeriSign
  - CA [7-7](#)
  - CA example [7-7](#)
  - configuring CAs, example [6-9](#)
- video conferencing applications, supported [D - 6](#)
- viewing
  - Command Authorization settings [9-7](#)
  - default configurations [1-30](#)
  - IPSec configuration [6-29](#)
  - NTP [9-12](#)
- configuration examples [7-35](#)
- Easy VPN Remote device in [4-1](#)
- overview [1-15 to 1-18](#)
- peer identity [6-7](#)
- PPTP [8-20](#)
- remote access [8-1 to 8-21](#)
- site-to-site [1-17, 7-1 to 7-38](#)
- split tunnel [8-7, 8-9](#)
- Windows 2000 client [B-11](#)
- VPN Service Module [7-25](#)

---

**W**

web clients

secure authentication [3-10](#)

Websense filtering server [1-10](#)

web server access [3-1](#)

Windows 2000 VPN client

configuring [B-11](#)

write standby command [10-7](#)

---

**X**

X.509v3 certificates [E-3](#)

Xauth

configuring [8-5, 8-6](#)

configuring Cisco VPN client, example [B-17](#)

enabling [8-17](#)

exception for security gateways [B-21](#)

IKE [8-5, E-2](#)

X Display Manager Control Protocol

See XDMCP

XDMCP

application inspection [5-34](#)

support for [1-23](#)

