

PROGRAMMABLE CMOS SINGLE OPERATIONAL AMPLIFIERS

- OFFSET NULL CAPABILITY (by external compensation)
- DYNAMIC CHARACTERISTICS ADJUSTABLE BY I_{SET}
- CONSUMPTION CURRENT AND DYNAMIC PARAMETERS ARE STABLE REGARDING THE VOLTAGE POWER SUPPLY VARIATIONS
- OUTPUT VOLTAGE CAN SWING TO GROUND
- VERY LARGE I_{SET} RANGE
- STABLE AND LOW OFFSET VOLTAGE
- THREE INPUT OFFSET VOLTAGE SELECTIONS

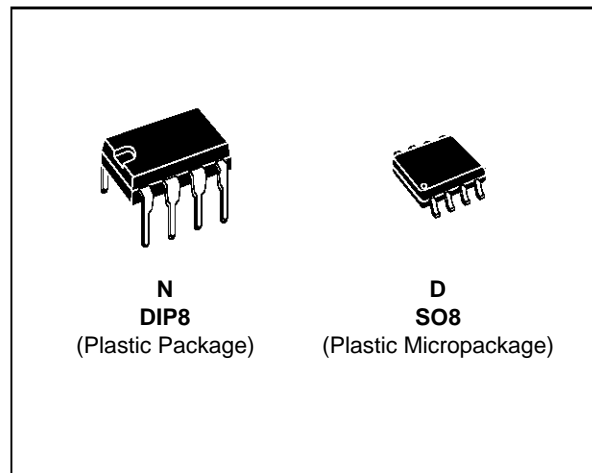

DESCRIPTION

The TS271 is a low cost, low power single operational amplifier designed to operate with single or

dual supplies. This operational amplifier uses the SGS-THOMSON silicon gate CMOS process giving it an excellent consumption-speed ratio. This amplifier is ideally suited for low consumption applications.

The power supply is externally programmable with a resistor connected between pins 8 and 4. It allows to choose the best consumption-speed ratio and supply current can be minimized according to the required speed. This device is specified for the following I_{SET} current values : 1.5 μ A, 25 μ A, 130 μ A.

This CMOS amplifier offers very high input impedance and extremely low input currents. The major advantage versus JFET devices is the very low input currents drift with temperature (see figure 3).

ORDER CODES

Part Number	Temperature Range	Package	
		N	D
TS271C/AC/BC	0°C, +70°C	●	●
TS271I/AI/BI	-40°C, +125°C	●	●
TS271M/AM/BM	-55°C, +125°C	●	●

Example : TS271ACN

PIN CONNECTIONS (top view)

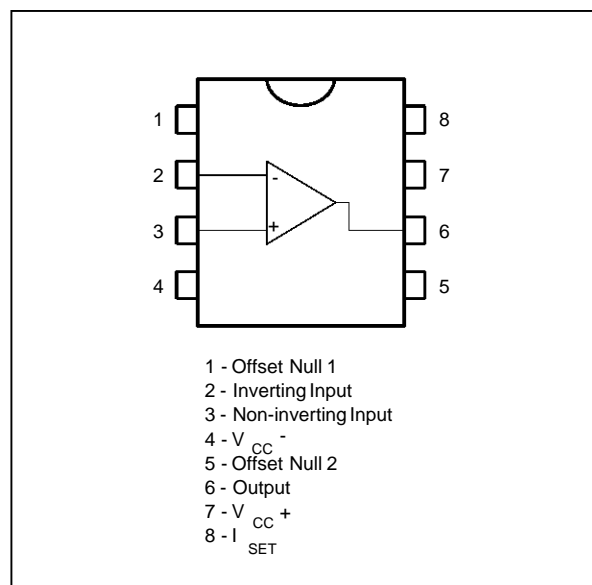

BLOCK DIAGRAM

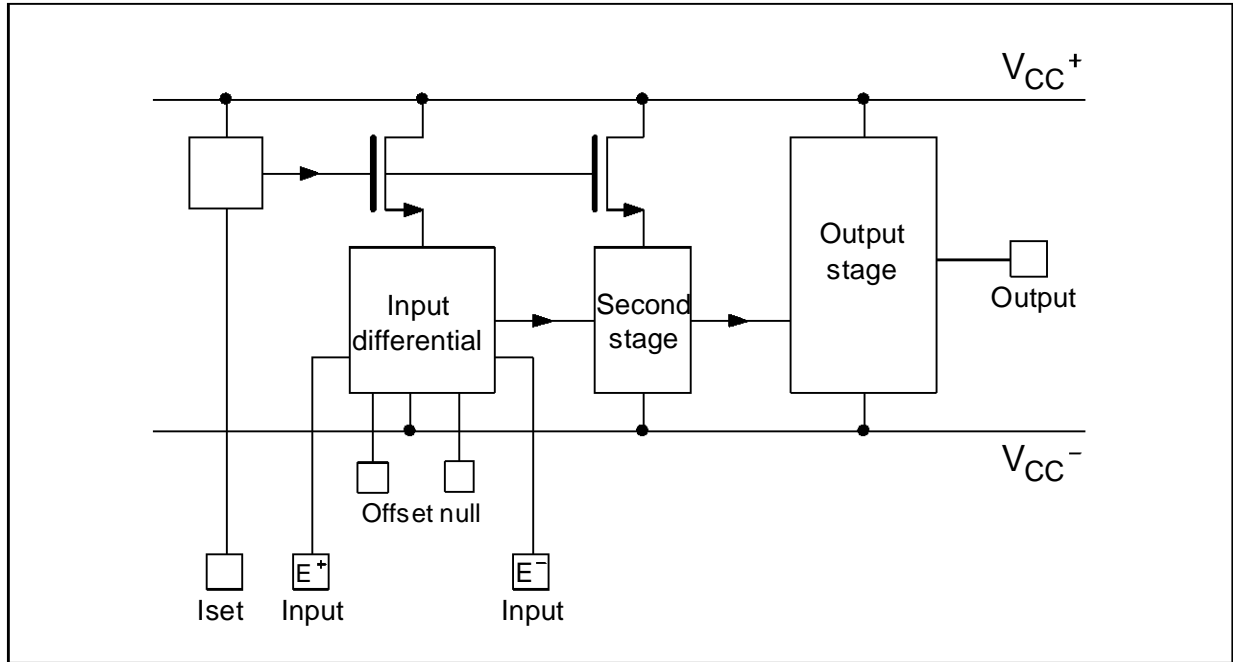

MAXIMUM RATINGS

Symbol	Parameter	Value	Unit
V_{CC}^+	Supply Voltage - (note 1)	18	V
V_{id}	Differential Input Voltage - (note 2)	± 18	V
V_i	Input Voltage - (note 3)	-0.3 to 18	V
I_o	Output Current for $V_{CC}^+ \geq 15V$	± 30	mA
I_{in}	Input Current	± 5	mA
T_{oper}	Operating Free-Air Temperature Range	TS271C/AC/BC TS271I/AI/BI TS271M/AM/BM 0 to +70 -40 to +125 -55 to +125	$^{\circ}C$
T_{stg}	Storage Temperature Range	-65 to +150	$^{\circ}C$

Notes : 1. All voltage values, except differential voltage, are with respect to network ground terminal.
 2. Differential voltages are the non-inverting input terminal with respect to the inverting input terminal.
 3. The magnitude of the input and the output voltages must never exceed the magnitude of the positive supply voltage.

OPERATING CONDITIONS

Symbol	Parameter	Value	Unit
V_{CC}^+	Supply Voltage	3 to 16	V
V_{icm}	Common Mode Input Voltage Range	0 to $V_{CC}^+ - 1.5$	V

SCHEMATIC DIAGRAM

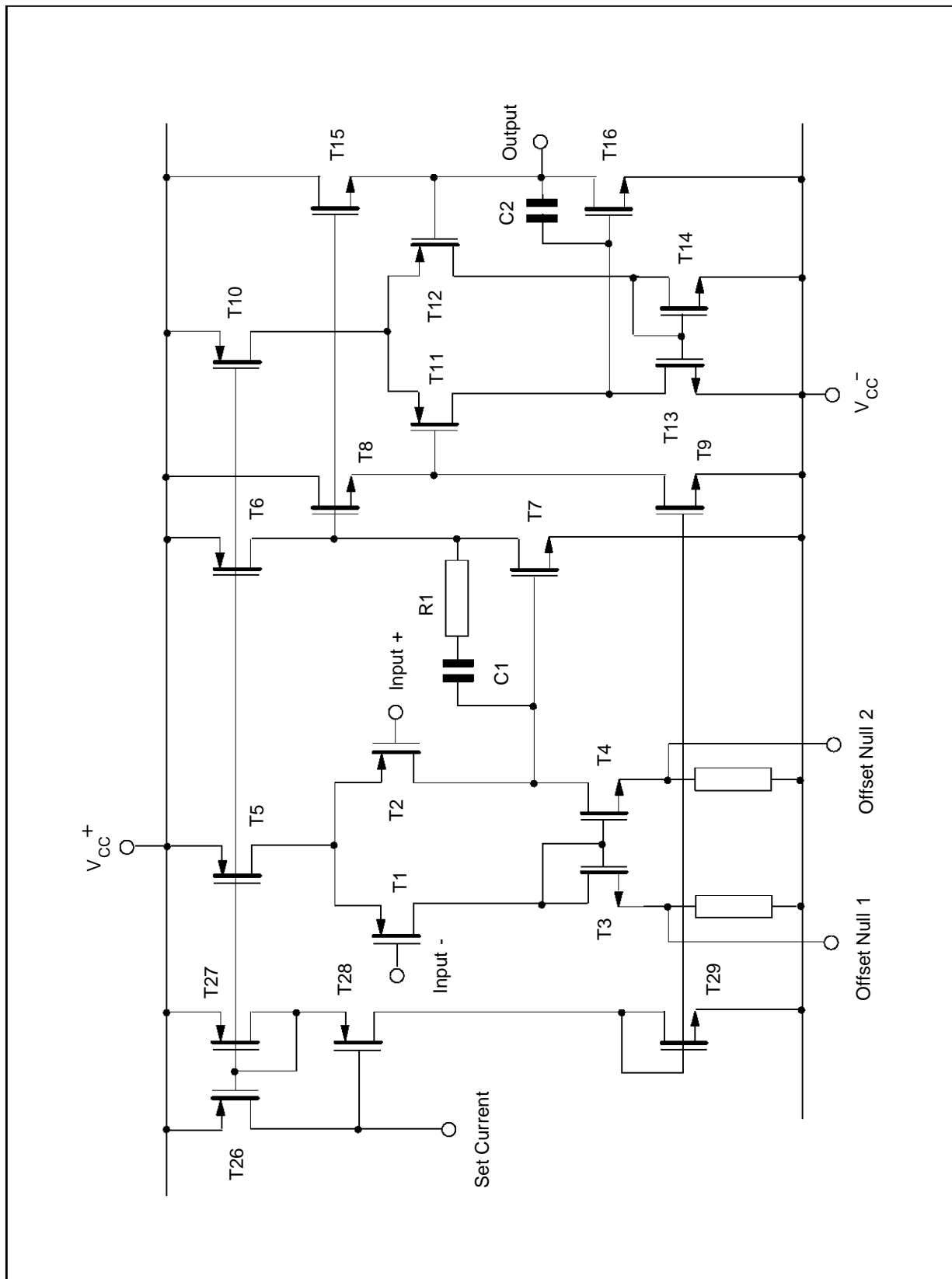

OFFSET VOLTAGE NULL CIRCUIT

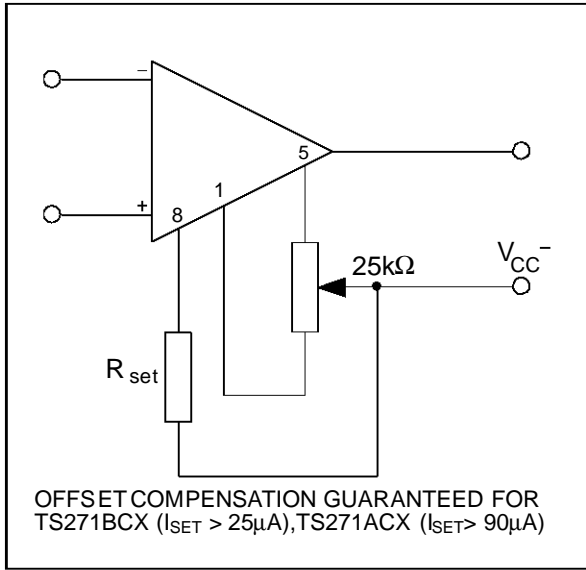

RESISTOR BIASING

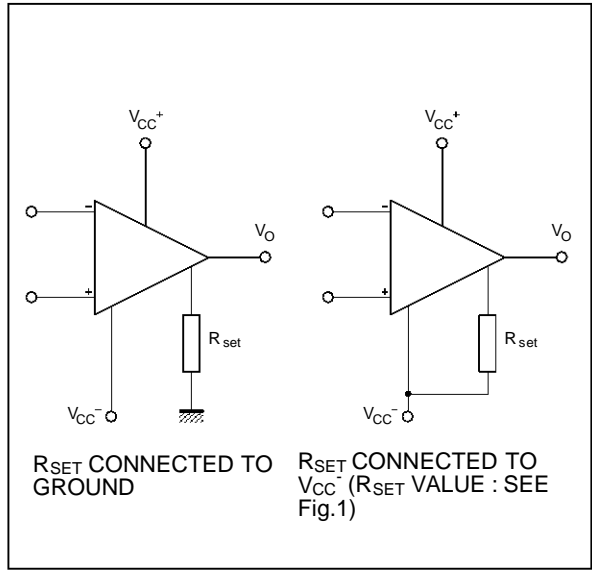
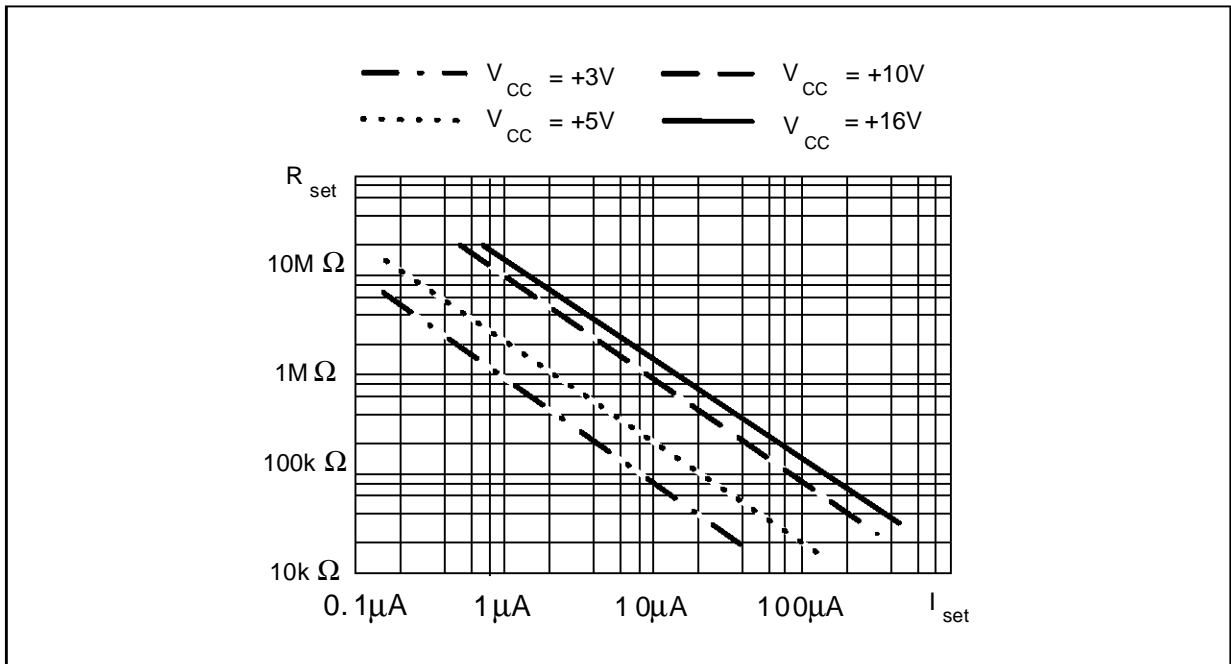

Figure 1 : R_{SET} Connected to V_{CC-} .



ELECTRICAL CHARACTERISTICS FOR I_{SET} = 1.5μA
 $V_{CC}^+ = +10V, V_{CC}^- = 0V, T_{amb} = 25^{\circ}C$ (unless otherwise specified)

Symbol	Parameter	TS271C/AC/BC			TS271I/AI/BI TS271M/AM/BM			Unit
		Min.	Typ.	Max.	Min.	Typ.	Max.	
V _{io}	Input Offset Voltage V _O = 1.4V, V _{ic} = 0V TS271C/I/M TS271AC/AI/AM TS271BC/BI/BM T _{min.} ≤ T _{amb} ≤ T _{max.} TS271C/I/M TS271AC/AI/AM TS271BC/BI/BM		1.1 0.9 0.25	10 5 2		1.1 0.9 0.25	10 5 2	mV
DV _{io}	Input Offset Voltage Drift		0.7			0.7		μV/°C
I _{io}	Input Offset Current - (note 1) V _{ic} = 5V, V _o = 5V T _{min.} ≤ T _{amb} ≤ T _{max.}		1	100		1	200	pA
I _{ib}	Input Bias Current - (note 1) V _{ic} = 5V, V _o = 5V T _{min.} ≤ T _{amb} ≤ T _{max.}		1	150		1	300	pA
V _{OH}	High Level Output Voltage V _{id} = 100mV, R _L = 1MΩ T _{min.} ≤ T _{amb} ≤ T _{max.}	8.8 8.7	9		8.8 8.6	9		V
V _{OL}	Low Level Output Voltage (V _{id} = -100mV)			50			50	mV
A _{vd}	Large Signal Voltage Gain V _o = 1V to 6V, R _L = 1MΩ, V _{ic} = 5V T _{min.} ≤ T _{amb} ≤ T _{max.}	30 20	100		30 20	100		V/mV
GBP	Gain Bandwidth Product (A _v = 40dB, R _L = 1MΩ, C _L = 100pF, f _{in} = 10kHz)		0.1			0.1		MHz
CMR	Common Mode Rejection Ratio V _o = 1.4V, V _{ic} = 1V to 7.4V	60	80		60	80		dB
SVR	Supply Voltage Rejection Ratio V _{CC} ⁺ = 5V to 10V, V _o = 1.4V	60	80		60	80		dB
I _{cc}	Supply Current A _v = 1, no load, V _o = 5V T _{min.} ≤ T _{amb} ≤ T _{max.}		10	15 17		10	15 18	μA
I _o	Output Short Circuit Current V _{id} = 100mV, V _o = 0V		60			60		mA
I _{sink}	Output Sink Current V _{id} = -100mV, V _o = V _{CC}		45			45		mA
SR	Slew-Rate at Unity Gain R _L = 1MΩ, C _L = 100pF, V _i = 3 to 7V		0.04			0.04		V/μs
∅ _m	Phase Margin at Unity Gain A _v = 40dB, R _L = 1MΩ C _L = 10pF C _L = 100pF		35 10			35 10		Degrees
K _{ov}	Overshoot Factor C _L = 10pF C _L = 100pF		40 70			40 70		%
e _n	Equivalent Input Noise Voltage f = 1kHz, R _S = 100Ω		68			68		$\frac{nV}{\sqrt{Hz}}$

Note : 1. Maximum values including unavoidable inaccuracies of the industrial test.

TYPICAL CHARACTERISTICS FOR $I_{SET} = 1.5\mu A$

Figure 2 : Supply Current versus Supply Voltage

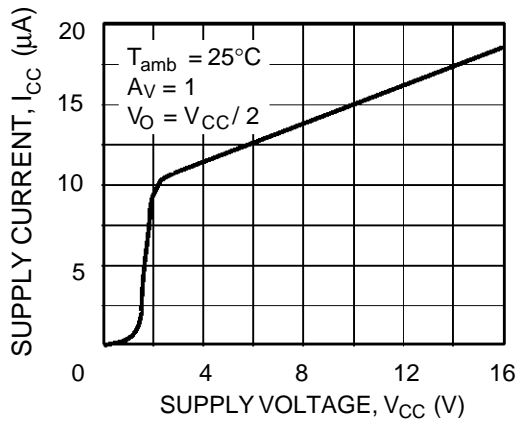

Figure 3 : Input Bias Current versus Free Air Temperature

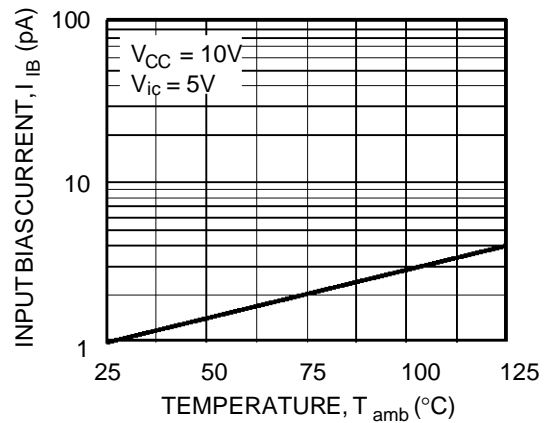

Figure 4a : High Level Output Voltage versus High Level Output Current

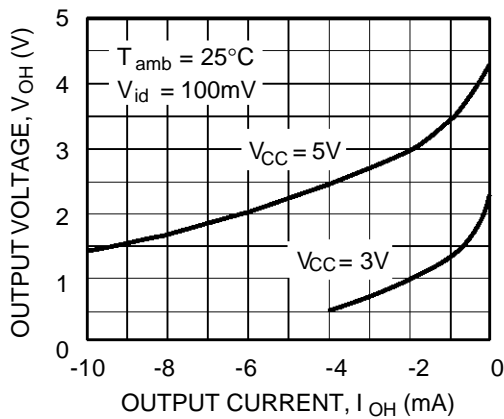

Figure 4b : High Level Output Voltage versus High Level Output Current

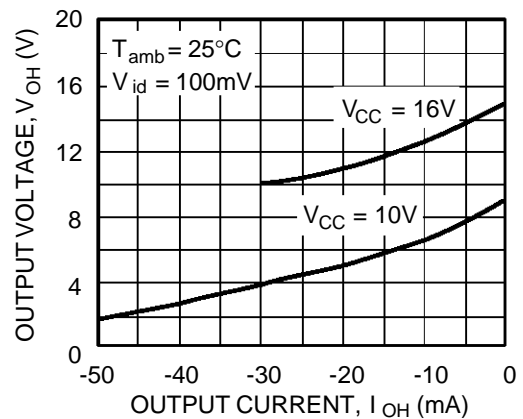

Figure 5a : Low Level Output Voltage versus Low Level Output Current

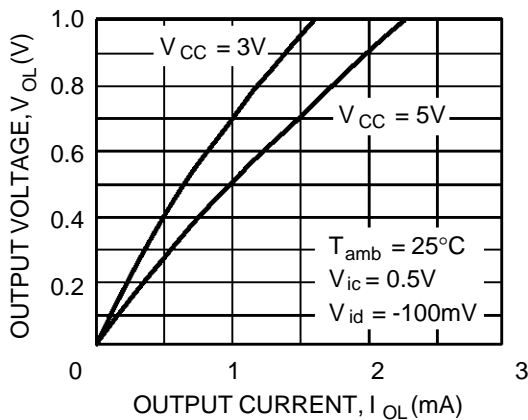
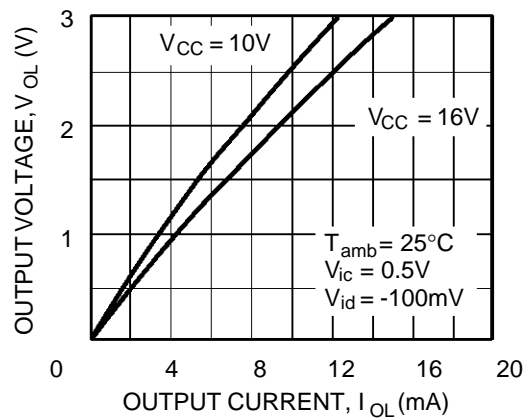

Figure 5b : Low Level Output Voltage versus Low Level Output Current



TYPICAL CHARACTERISTICS FOR $I_{SET} = 1.5\mu A$ (continued)

Figure 6 : Open Loop Frequency Response and Phase Shift

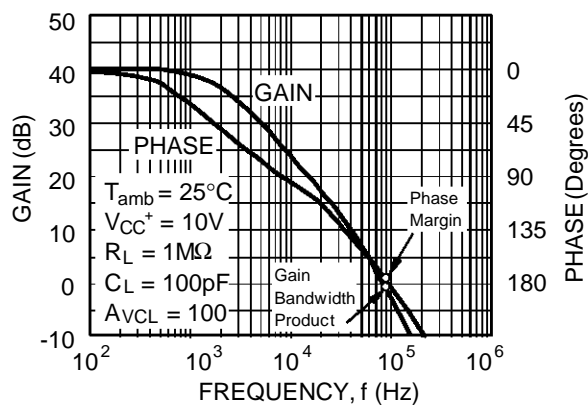

Figure 7 : Gain Bandwidth Product versus Supply voltage

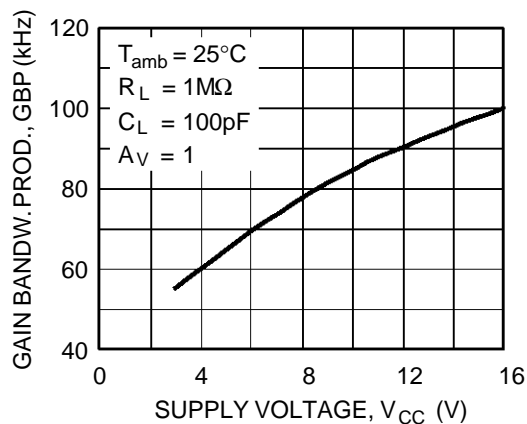

Figure 8 : Phase Margin versus Supply Voltage

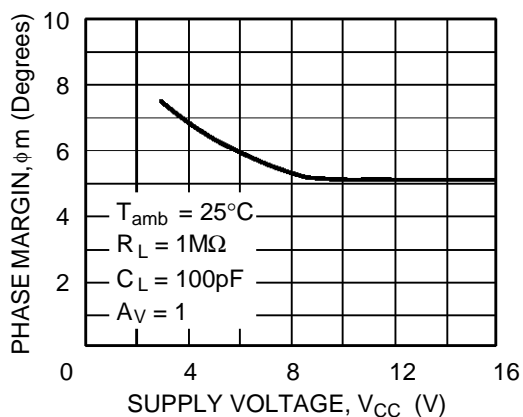

Figure 9 : Phase Margin versus Capacitive Load

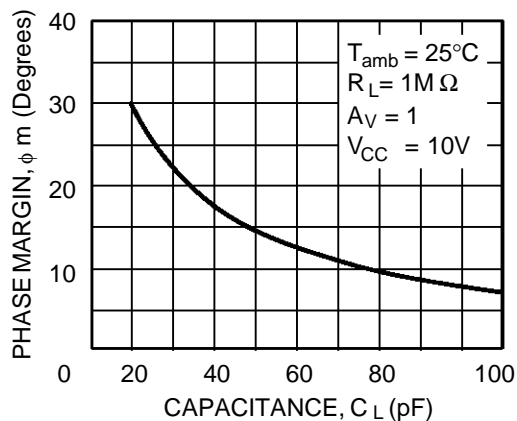
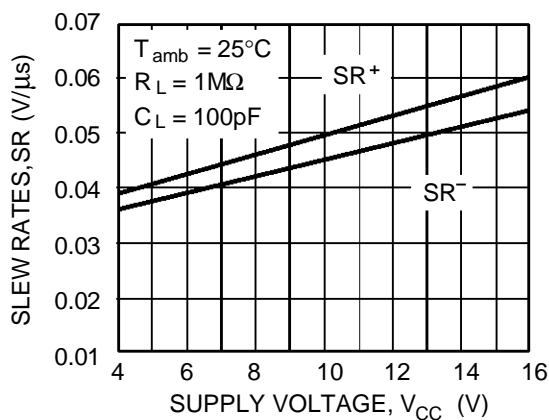

Figure 10 : Slew Rates versus Supply Voltage



TS271C,I,M

ELECTRICAL CHARACTERISTICS FOR $I_{SET} = 25\mu A$

$V_{CC}^+ = +10V$, $V_{CC}^- = 0V$, $T_{amb} = 25^\circ C$ (unless otherwise specified)

Symbol	Parameter	TS271C/AC/BC			TS271I/AI/BI TS271M/AM/BM			Unit
		Min.	Typ.	Max.	Min.	Typ.	Max.	
V_{io}	Input Offset Voltage $V_O = 1.4V$, $V_{ic} = 0V$ TS271C/I/M TS271AC/AI/AM TS271BC/BI/BM $T_{min.} \leq T_{amb} \leq T_{max.}$ TS271C/I/M TS271AC/AI/AM TS271BC/BI/BM		1.1 0.9 0.25	10 5 2		1.1 0.9 0.25	10 5 2	mV
DV_{io}	Input Offset Voltage Drift		2			2		$\mu V/^\circ C$
I_{io}	Input Offset Current - (note 1) $V_{ic} = 5V$, $V_o = 5V$ $T_{min.} \leq T_{amb} \leq T_{max.}$		1	100		1	200	pA
I_{ib}	Input Bias Current - (note 1) $V_{ic} = 5V$, $V_o = 5V$ $T_{min.} \leq T_{amb} \leq T_{max.}$		1	150		1	300	pA
V_{OH}	High Level Output Voltage $V_{id} = 100mV$, $R_L = 100k\Omega$ $T_{min.} \leq T_{amb} \leq T_{max.}$	8.7 8.6	8.9		8.7 8.5	8.9		V
V_{OL}	Low Level Output Voltage ($V_{id} = -100mV$)			50			50	mV
A_{vd}	Large Signal Voltage Gain $V_o = 1V$ to $6V$, $R_L = 100k\Omega$, $V_{ic} = 5V$ $T_{min.} \leq T_{amb} \leq T_{max.}$	30 20	50		30 10	50		V/mV
GBP	Gain Bandwidth Product ($A_v = 40dB$, $R_L = 100k\Omega$, $C_L = 100pF$, $f_{in} = 100kHz$)		0.7			0.7		MHz
CMR	Common Mode Rejection Ratio $V_o = 1.4V$, $V_{ic} = 1V$ to $7.4V$	60	80		60	80		dB
SVR	Supply Voltage Rejection Ratio $V_{CC}^+ = 5V$ to $10V$, $V_o = 1.4V$	60	80		60	80		dB
I_{cc}	Supply Current $A_v = 1$, no load, $V_o = 5V$ $T_{min.} \leq T_{amb} \leq T_{max.}$		150	200 250		150	200 300	μA
I_o	Output Short Circuit Current $V_{id} = 100mV$, $V_o = 0V$		60			60		mA
I_{sink}	Output Sink Current $V_{id} = -100mV$, $V_o = V_{CC}$		45			45		mA
SR	Slew-Rate at Unity Gain $R_L = 100k\Omega$, $C_L = 100pF$, $V_i = 3$ to $7V$		0.6			0.6		V/ μs
ϕ_m	Phase Margin at Unity Gain $A_v = 40dB$, $R_L = 100k\Omega$ $C_L = 10pF$ $C_L = 100pF$		50 30			50 30		degrees
K_{ov}	Overshoot Factor $C_L = 10pF$ $C_L = 100pF$		30 50			30 50		%
e_n	Equivalent Input Noise Voltage $f = 1kHz$, $R_S = 100\Omega$		38			38		$\frac{nV}{\sqrt{Hz}}$

Note : 1. Maximum values including unavoidable inaccuracies of the industrial test.

TYPICAL CHARACTERISTICS FOR $I_{SET} = 25\mu A$

Figure 11 : Supply Current versus Supply Voltage

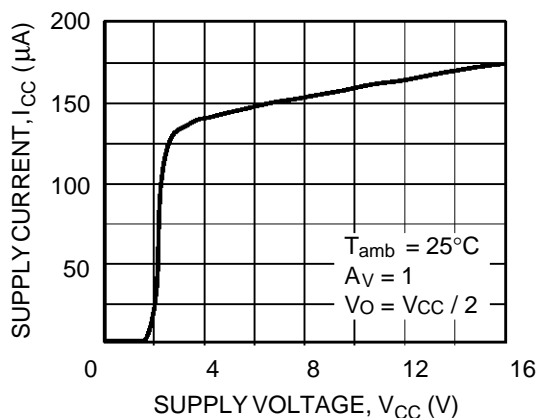

Figure 12 : Input Bias Current versus Free Air Temperature

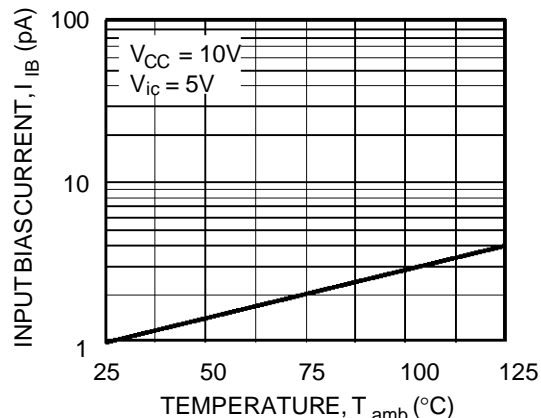

Figure 13a : High Level Output Voltage versus High Level Output Current

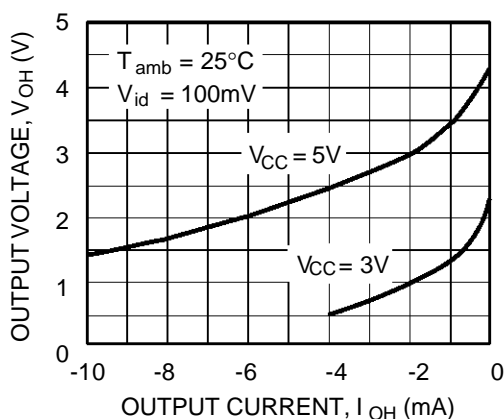

Figure 13b : High Level Output Voltage versus High Level Output Current

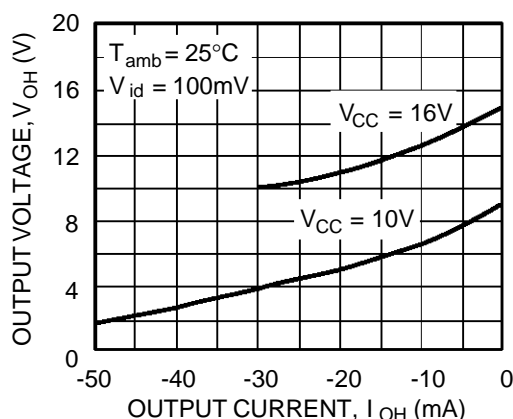

Figure 14a : Low Level Output Voltage versus Low Level Output Current

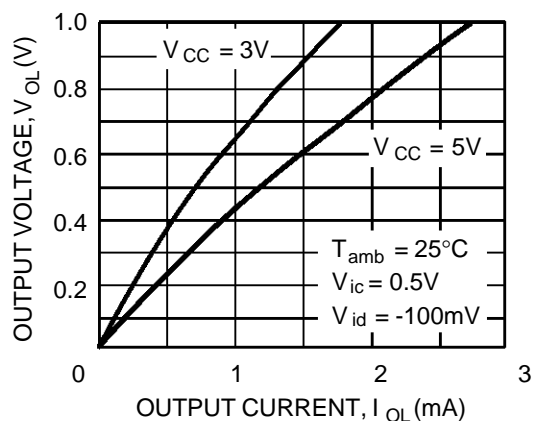
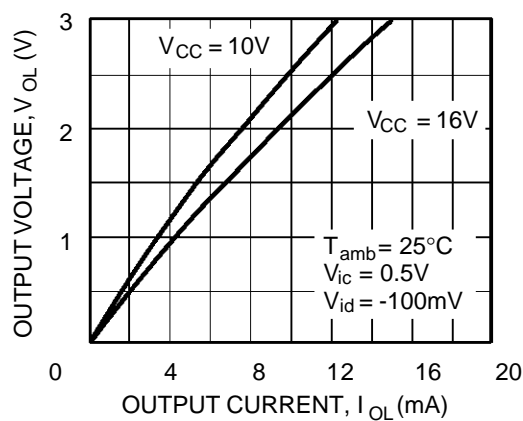

Figure 14b : Low Level Output Voltage versus Low Level Output Current



TYPICAL CHARACTERISTICS FOR $I_{SET} = 25\mu A$ (continued)

Figure 15 : Open Loop Frequency Response and Phase Shift

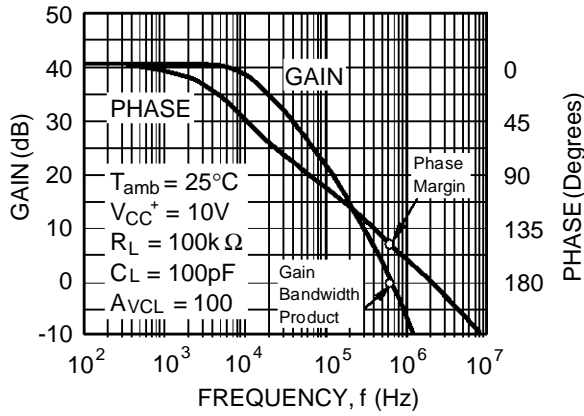

Figure 16 : Gain Bandwidth Product versus Supply voltage

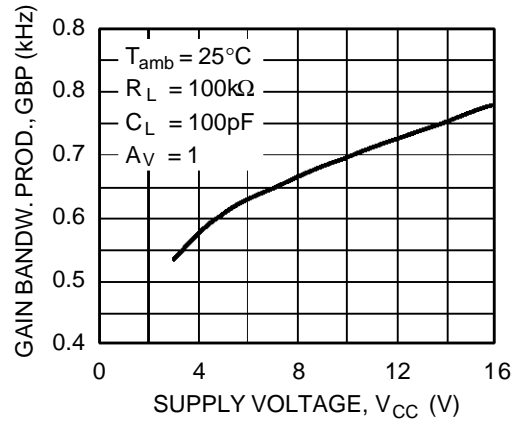

Figure 17 : Phase Margin versus Supply Voltage

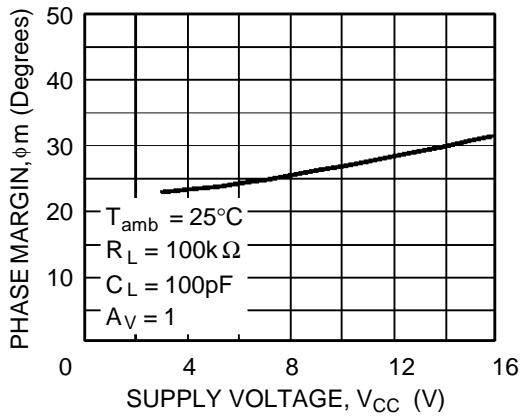

Figure 18 : Phase Margin versus Capacitive Load

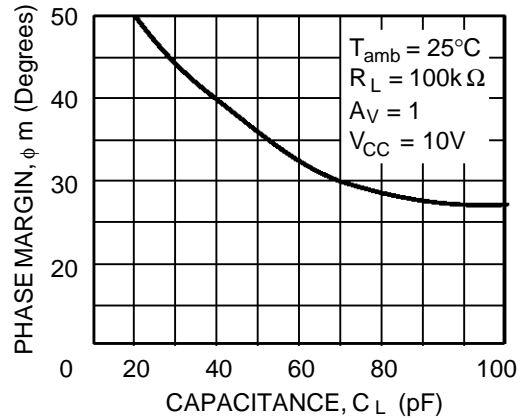
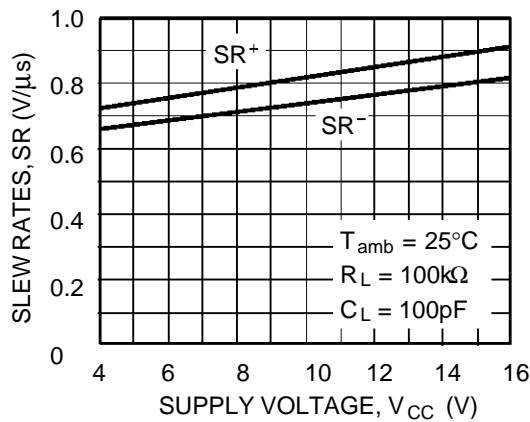

Figure 19 : Slew Rates versus Supply Voltage



ELECTRICAL CHARACTERISTICS FOR I_{SET} = 130μA
 $V_{CC}^+ = +10V, V_{CC}^- = 0V, T_{amb} = 25^{\circ}C$ (unless otherwise specified)

Symbol	Parameter	TS271C/AC/BC			TS271I/AI/BI TS271M/AM/BM			Unit
		Min.	Typ.	Max.	Min.	Typ.	Max.	
V_{io}	Input Offset Voltage $V_O = 1.4V, V_{ic} = 0V$ TS271C/I/M TS271AC/AI/AM TS271BC/BI/BM $T_{min.} \leq T_{amb} \leq T_{max.}$ TS271C/I/M TS271AC/AI/AM TS271BC/BI/BM		1.1 0.9 0.25	10 5 2		1.1 0.9 0.25	10 5 2	mV
DV_{io}	Input Offset Voltage Drift		2			2		$\mu V/^{\circ}C$
I_{io}	Input Offset Current - (note 1) $V_{ic} = 5V, V_o = 5V$ $T_{min.} \leq T_{amb} \leq T_{max.}$		1	100		1	200	pA
I_{ib}	Input Bias Current - (note 1) $V_{ic} = 5V, V_o = 5V$ $T_{min.} \leq T_{amb} \leq T_{max.}$		1	150		1	300	pA
V_{OH}	High Level Output Voltage $V_{id} = 100mV, R_L = 10k\Omega$ $T_{min.} \leq T_{amb} \leq T_{max.}$	8.2 8.1	8.4		8.2 8	8.4		V
V_{OL}	Low Level Output Voltage ($V_{id} = -100mV$)			50			50	mV
A_{vd}	Large Signal Voltage Gain $V_o = 1V$ to $6V, R_L = 10k\Omega, V_{ic} = 5V$ $T_{min.} \leq T_{amb} \leq T_{max.}$	10 7	15		10 6	15		V/mV
GBP	Gain Bandwidth Product ($A_v = 40dB,$ $R_L = 10k\Omega, C_L = 100pF, f_{in} = 100kHz$)		2.3			2.3		MHz
CMR	Common Mode Rejection Ratio $V_o = 1.4V, V_{ic} = 1V$ to $7.4V$	60	80		60	80		dB
SVR	Supply Voltage Rejection Ratio $V_{CC}^+ = 5V$ to $10V, V_o = 1.4V$	60	70		60	70		dB
I_{cc}	Supply Current $A_v = 1, \text{no load}, V_o = 5V$ $T_{min.} \leq T_{amb} \leq T_{max.}$		800	1300 1400		800	1300 1500	μA
I_o	Output Short Circuit Current $V_{id} = 100mV, V_o = 0V$		60			60		mA
I_{sink}	Output Sink Current $V_{id} = -100mV, V_o = V_{CC}$		45			45		mA
SR	Slew-Rate at Unity Gain $R_L = 10k\Omega, C_L = 100pF, V_i = 3$ to $7V$		4.5			4.5		V/ μs
ϕ_m	Phase Margin at Unity Gain $A_v = 40dB, R_L = 10k\Omega$ $C_L = 10pF$ $C_L = 100pF$		65 50			65 50		degrees
K_{ov}	Overshoot Factor $C_L = 10pF$ $C_L = 100pF$		30 30			30 30		%
e_n	Equivalent Input Noise Voltage $f = 1kHz, R_S = 100\Omega$		30			30		$\frac{nV}{\sqrt{Hz}}$

Note : 1. Maximum values including unavoidable inaccuracies of the industrial test.

TYPICAL CHARACTERISTICS FOR $I_{SET} = 130\mu A$

Figure 20 : Supply Current (each amplifier) versus Supply Voltage

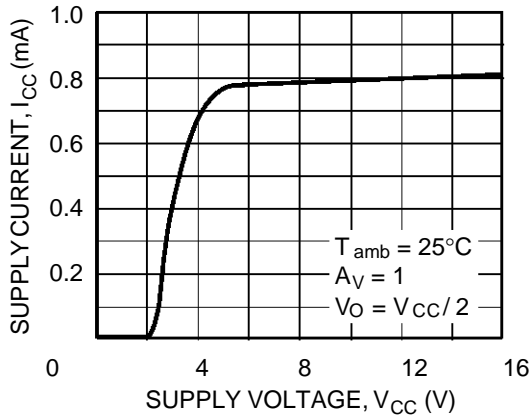

Figure 21 : Input Bias Current versus Free Air Temperature

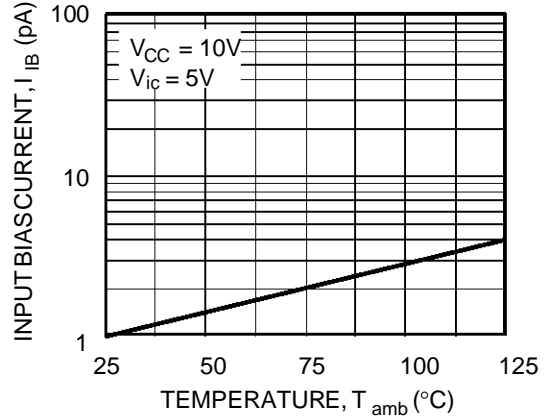

Figure 22a : High Level Output Voltage versus High Level Output Current

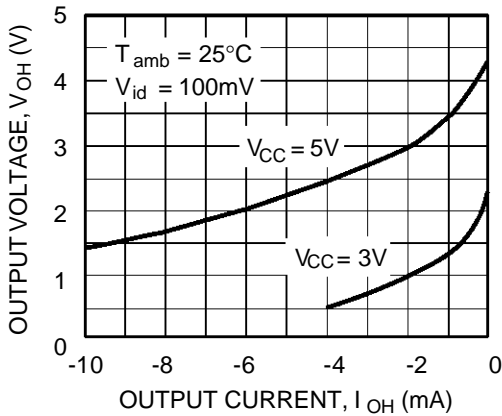

Figure 22b : High Level Output Voltage versus High Level Output Current

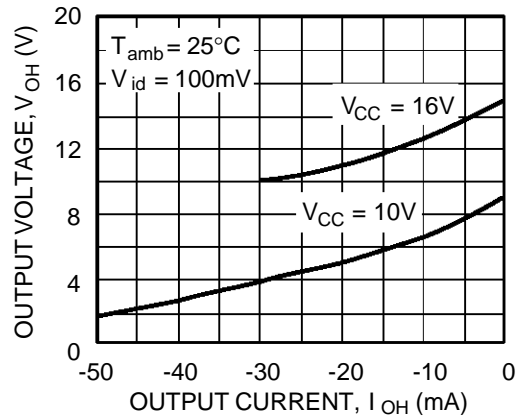

Figure 23a : Low Level Output Voltage versus Low Level Output Current

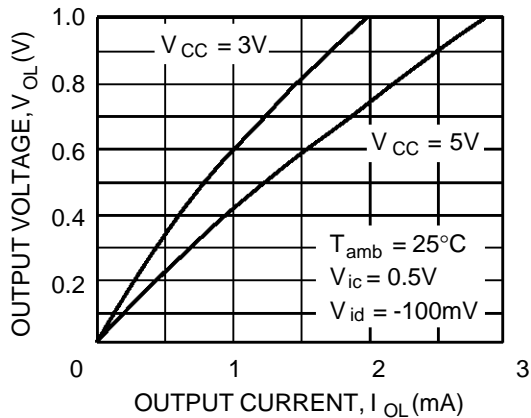
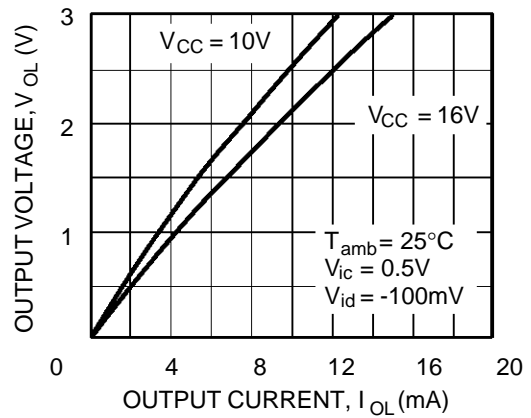

Figure 23b : Low Level Output Voltage versus Low Level Output Current



TYPICAL CHARACTERISTICS FOR $I_{SET} = 130\mu A$ (continued)

Figure 24 : Open Loop Frequency Response and Phase Shift

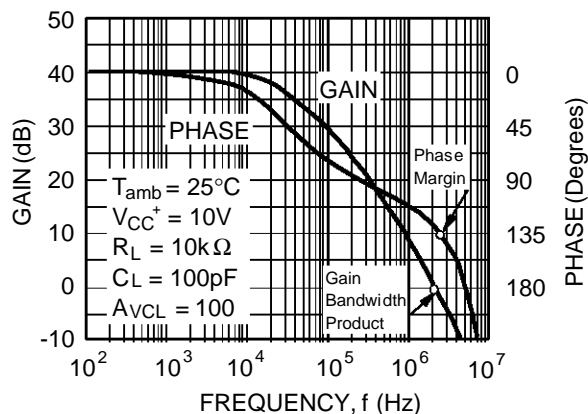

Figure 25 : Gain Bandwidth Product versus Supply voltage

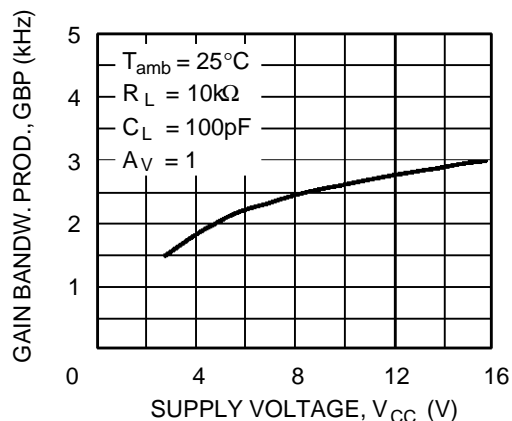

Figure 26 : Phase Margin versus Supply Voltage

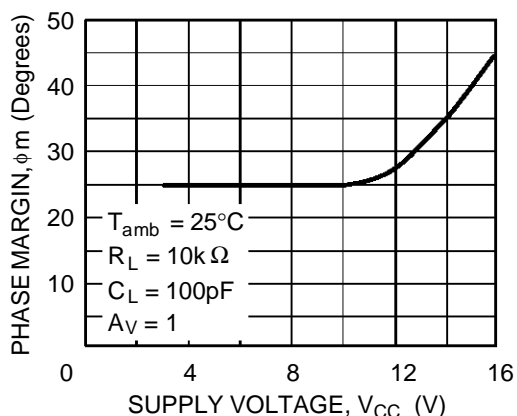

Figure 27 : Phase Margin versus Capacitive Load

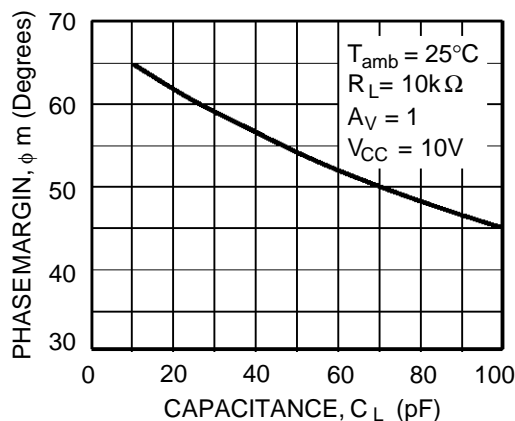
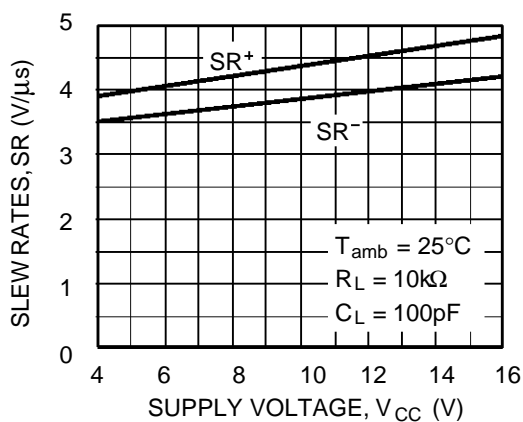
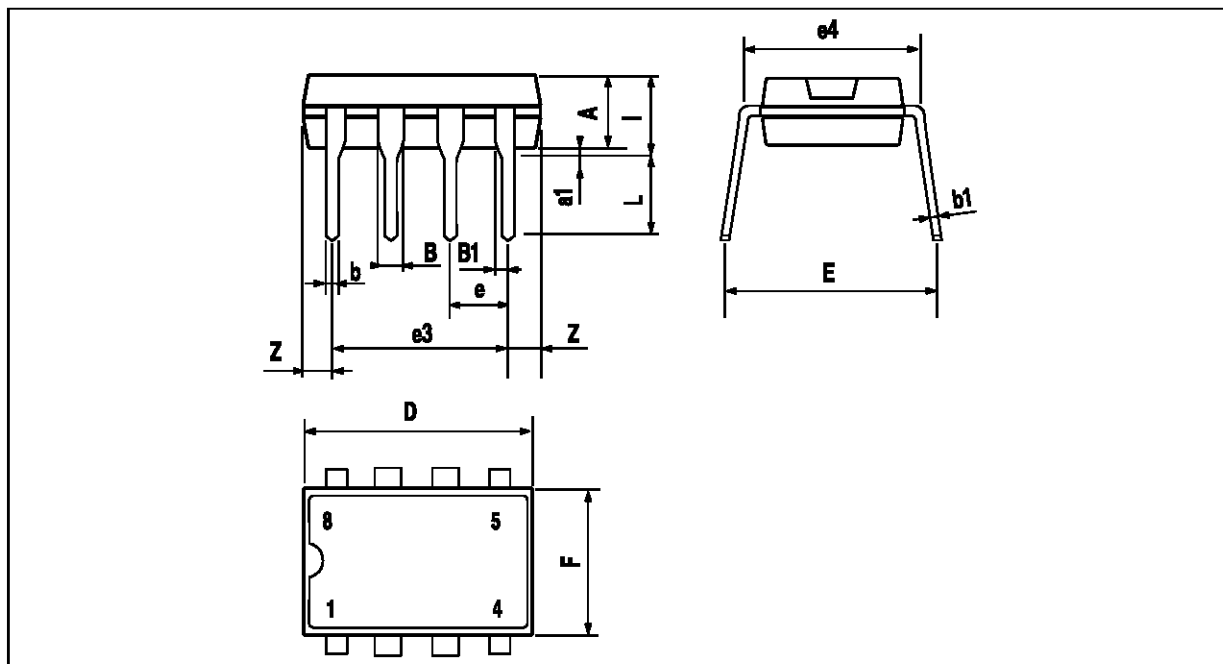

Figure 28 : Slew Rates versus Supply Voltage



TS271C,I,M

PACKAGE MECHANICAL DATA 8 PINS - PLASTIC DIP



PM-DIP8.EPS

Dimensions	Millimeters			Inches		
	Min.	Typ.	Max.	Min.	Typ.	Max.
A		3.32			0.131	
a1	0.51			0.020		
B	1.15		1.65	0.045		0.065
b	0.356		0.55	0.014		0.022
b1	0.204		0.304	0.008		0.012
D			10.92			0.430
E	7.95		9.75	0.313		0.384
e		2.54			0.100	
e3		7.62			0.300	
e4		7.62			0.300	
F			6.6			0.260
i			5.08			0.200
L	3.18		3.81	0.125		0.150
Z			1.52			0.060

271-07.TBL

PACKAGE MECHANICAL DATA
8 PINS - PLASTIC MICROPACKAGE (SO)

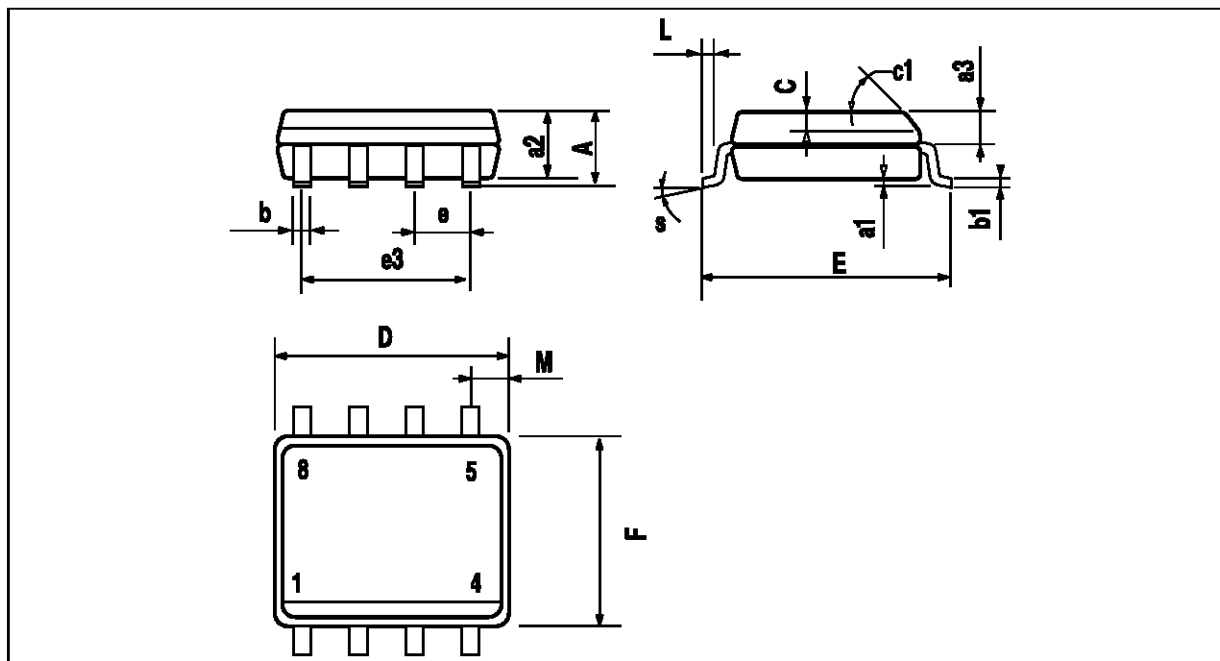

PM-S08.EPS

Dimensions	Millimeters			Inches		
	Min.	Typ.	Max.	Min.	Typ.	Max.
A			1.75			0.069
a1	0.1		0.25	0.004		0.010
a2			1.65			0.065
a3	0.65		0.85	0.026		0.033
b	0.35		0.48	0.014		0.019
b1	0.19		0.25	0.007		0.010
C	0.25		0.5	0.010		0.020
c1	45° (typ.)					
D	4.8		5.0	0.189		0.197
E	5.8		6.2	0.228		0.244
e		1.27			0.050	
e3		3.81			0.150	
F	3.8		4.0	0.150		0.157
L	0.4		1.27	0.016		0.050
M			0.6			0.024
S	8° (max.)					

SO8.TBL

Information furnished is believed to be accurate and reliable. However, SGS-THOMSON Microelectronics assumes no responsibility for the consequences of use of such information nor for any infringement of patents or other rights of third parties which may result from its use. No license is granted by implication or otherwise under any patent or patent rights of SGS-THOMSON Microelectronics. Specification mentioned in this publication are subject to change without notice. This publication supersedes and replaces all information previously supplied. SGS-THOMSON Microelectronics products are not authorized for use as critical components in life support devices or systems without express written approval of SGS-THOMSON Microelectronics.

© 1997 SGS-THOMSON Microelectronics – Printed in Italy – All Rights Reserved

SGS-THOMSON Microelectronics GROUP OF COMPANIES
Australia - Brazil - Canada - China - France - Germany - Hong Kong - Italy - Japan - Korea - Malaysia - Malta - Morocco
The Netherlands - Singapore - Spain - Sweden - Switzerland - Taiwan - Thailand - United Kingdom - U.S.A.

ORDER CODE :