

FIBER OPTIC RECEIVING MODULE
TORX176

FIBER OPTIC RECEIVING MODULE FOR DIGITAL AUDIO EQUIPMENTS

Unit in mm

- Conform to EIAJ Standard CP-1201 (For Digital Audio Interfaces including Fiber Optic inter-connections).
- TTL Interface
- ATC (Automatic Threshold Control) Circuit is used for stabilized output at a wide range of optical power level.
- A self-tapping hole for easy attachment to the panel of Audio Equipments.

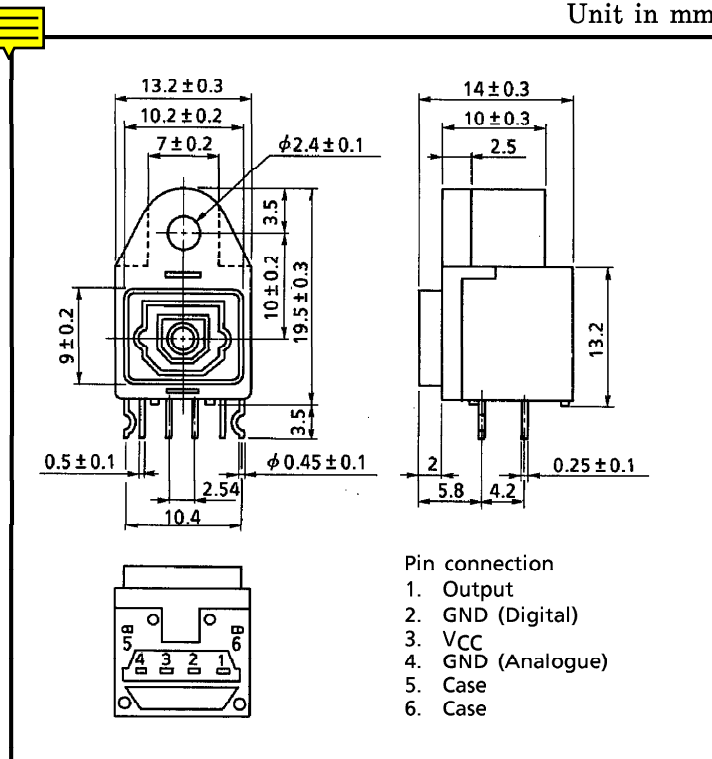

- Pin connection
1. Output
 2. GND (Digital)
 3. VCC
 4. GND (Analogue)
 5. Case
 6. Case

1. Maximum Ratings (Ta = 25°C)

ITEM	SYMBOL	RATING	UNIT
Storage Temperature	T _{stg}	-40 to 70	°C
Operating Temperature	T _{opr}	-20 to 70	°C
Supply Voltage	V _{CC}	-0.5 to 7	V
Low Level Output Current	I _{OL}	20	mA
High Level Output Current	I _{OH}	-1	mA
Soldering Temperature	T _{sol}	260 ⁽¹⁾	°C

Note ⁽¹⁾ Soldering time ≤ 10 seconds (More than 1mm apart from package).

961001EAA2

- TOSHIBA is continually working to improve the quality and the reliability of its products. Nevertheless, semiconductor devices in general can malfunction or fail due to their inherent electrical sensitivity and vulnerability to physical stress. It is the responsibility of the buyer, when utilizing TOSHIBA products, to observe standards of safety, and to avoid situations in which a malfunction or failure of a TOSHIBA product could cause loss of human life, bodily injury or damage to property. In developing your designs, please ensure that TOSHIBA products are used within specified operating ranges as set forth in the most recent products specifications. Also, please keep in mind the precautions and conditions set forth in the TOSHIBA Semiconductor Reliability Handbook.
- The information contained herein is presented only as a guide for the applications of our products. No responsibility is assumed by TOSHIBA CORPORATION for any infringements of intellectual property or other rights of the third parties which may result from its use. No license is granted by implication or otherwise under any intellectual property or other rights of TOSHIBA CORPORATION or others.
- The information contained herein is subject to change without notice.

2. Recommended Operating Conditions

ITEM	SYMBOL	MIN.	TYP.	MAX.	UNIT
Supply Voltage	V _{CC}	4.75	5.0	5.25	V
High Level Output Current	I _{OH}	—	—	-150	μA
Low Level Output Current	I _{OL}	—	—	1.6	mA

3. Electrical and Optical Characteristics (T_a = 25°C, V_{CC} = 5V)

ITEM	SYMBOL	CONDITION	MIN.	TYP.	MAX.	UNIT
Data Rate		NRZ code ⁽²⁾	DC	—	6	Mb/s
Transmission Distance		TOTX173, TOTX176 Using APF ⁽³⁾	0.2	—	10	m
Pulse Width Distortion ⁽⁴⁾	Δtw	Pulse width 165ns Pulse cycle 330ns, C _L = 10pF Using TOTX173, TOTX176	-20	—	20	ns
		Pulse width 165ns Pulse cycle 330ns Using TOTX178 C _L = 10pF	-25	—	25	ns
Maximum Receivable Power ⁽⁵⁾	P _{MAX}	6Mb/s, Using APF	-14.5	—	—	dBm
Minimum Receivable Power ⁽⁵⁾	P _{MIN}	6Mb/s, Using APF	—	—	-27	dBm
Rise Time	t _r	C _L = 10pF	—	10	30	ns
Fall Time	t _f	C _L = 10pF	—	5	30	ns
Current Consumption	I _{CC}		—	22	40	mA
High Level Output Voltage	V _{OH}	V _{CC} = 4.75V, I _{OH} = -0.15mA	2.7	—	—	V
Low Level Output Voltage	V _{OL}	V _{CC} = 4.75V, I _{OL} = 1.6mA	—	—	0.4	V

⁽²⁾ For data rate > 3Mb/s, the duty factor must be such as kept 25 to 75%. High level output when optical flux is received. Low level output when optical flux is not received.

⁽³⁾ All Plastic Fiber (970 / 1000 μm).

⁽⁴⁾ Between input of a fiber optic transmitting module and output of TORX176.

⁽⁵⁾ BER ≤ 10⁻⁹, rated by peak value.

4. Example of Typical Characteristics (6)

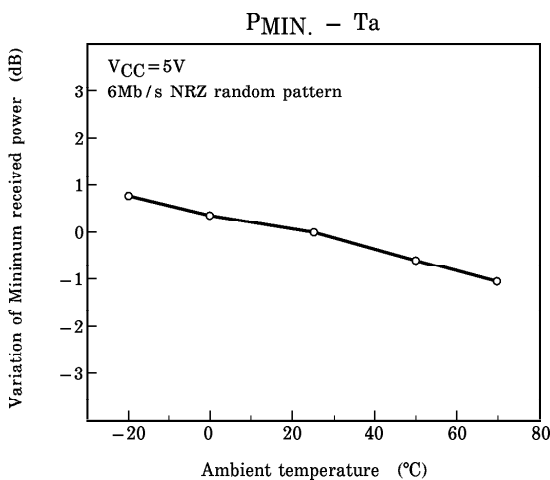
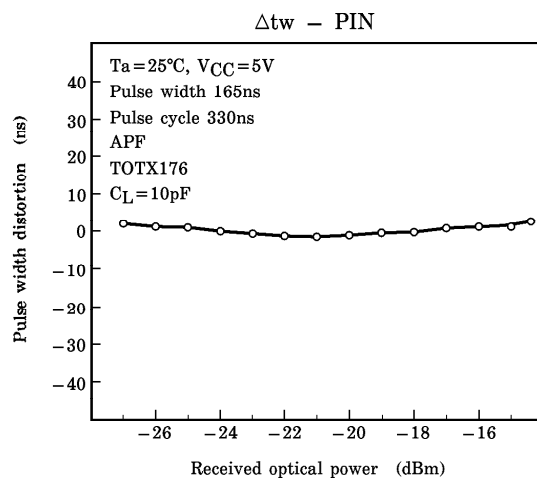
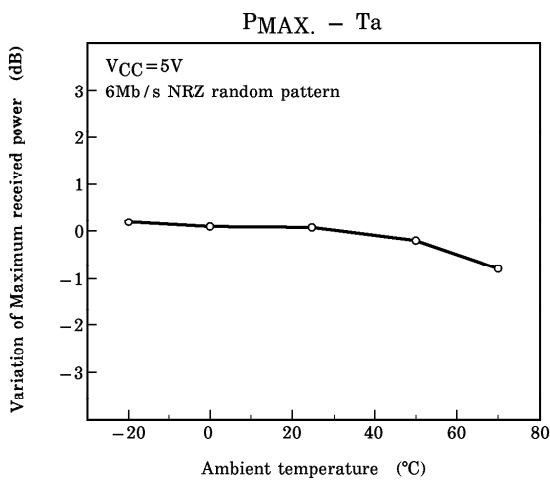
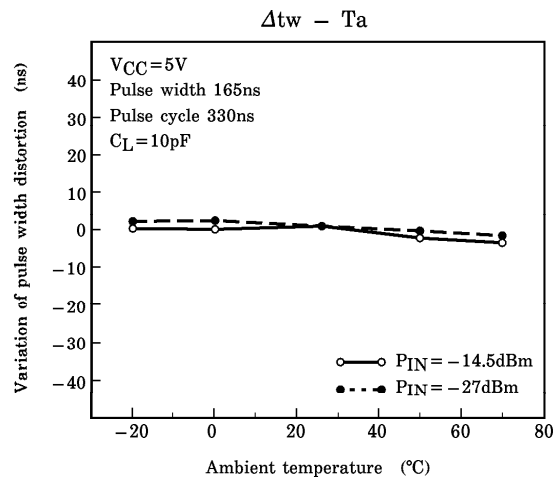
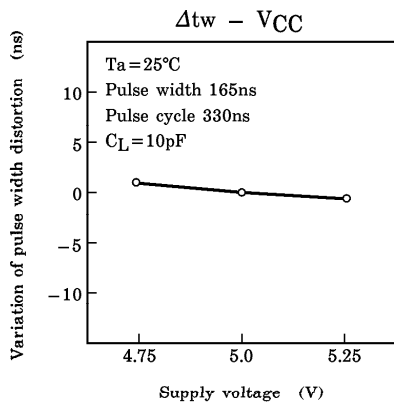

(6) There give characteristic examples, and its values are not guaranteed.

5. Connection Method

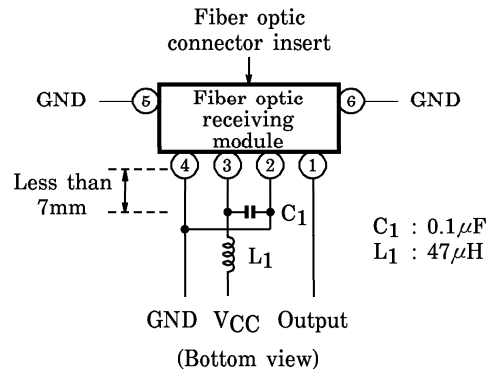

6. Applicable optical fiber with fiber optic connectors.

TOCP172-□□B

7. Precaution on Use

(1) Maximum Rating

The maximum ratings are the limit values which must not be exceeded when using the device. Any one of the rating must not be exceeded. If The maximum rating is exceeded, the characteristics may not be recovered. In some extreme cases, the device may be permanently damage.

(2) Soldering

Optical modules use semiconductor devices internally. However, in principle, optical modules are optical components. At soldering, take care that flux dose not contact the emitting surface or detecting surface. Also take care at flux removal after soldering.

Some optical modules come with protective cap. The protective cap is used to avoid malfunction when the optical module is not in use. Not that it is not dust or waterproof.

As mentioned before, optical modules are optical component. Thus, in principle, soldering where there may be flux residue or flux removal after soldering is not recommended. Toshiba recommends that soldering be performed without the optical module mounted on the board. Then, after the board is cleaned, solder the optical module manually. Do not perform any further cleaning.

If the optical module cannot be soldered manually, use non-halogen (chlorine-free) flux and make sure, without cleaning, there is no residue such as chlorine. This is one of the ways to eliminate the effects of flux. In such a case, check the reliability.

(3) Noise Resistance

Where the fiber optic receiving module case uses conductive resin, shield by connecting the reinforcing pin at a front end of the module to GND. When using this optical module, connect the pin to SIGNAL-GND.

Where the fiber optic receiving module case has a resistance of several tens of ohms, take care that the case does not contact power line of other circuits.

It is believed that the use of optical transfer devices improve the noise resistance. In principle, optical fiber is not affected by noise. However, especially receiving module which handle signals whose level is extremely small, are comparatively more susceptible to noise.

TOSLINK improves noise resistance using a conductive case. However, the current of the signal output from the photodiode of the optic receiving module is extremely small. Thus, depending on the usage environment, shielding the case is not sufficient for noise resistance. When using TOSLINK, Toshiba recommends that you test using the actual device and check the noise resistance.

Use a simple noise filter on the TOSLINK fiber optic receiving module power line. If the ripple in power supply used is high, further reinforce the filter.

When locating the optical module in an area susceptible to radiated noise, increase shielding by covering the optical module and the power line filter using a metallic cover.

(4) Vibration and Shock

This module is resin-molded construction with wire fixed by resin. This structure is relatively sound against vibration or shock, In actual equipment, there are some cases where vibration, shock, and stress is applied to soldered parts or connected parts, resulting in line cut. Attention must be paid to the design of the mechanism for applications which are subject to large amounts of vibration.

(5) Fixing Fiber Optical Receiving Module

Solder the fixed pin (pins 5 and 6) of fiber optic receiving module TORX176 to the printed circuit board to fix the module to the board.

(6) Panel Attachment

TORX176 provides hole for panel attachment. Please be sure to attach it to panel.

(7) Shielding and Wiring Pattern of Fiber Optic Receiving Modules

To shield, connect the fixed pins (pins 5 and 6) of fiber optic transceiving module TORX176 to the GND.

Where the fiber optic receiving module uses conductive resin, be careful that the case does not touch wiring (including land).

To improve noise resistance, shield the optical module and the power line filter using a metallic cover.

(8) Solvent

When using solvent for flux removal, do not use a high acid or high alkali solvent. Be careful not to pour solvent in the optical connector ports. If solvent is inadvertently poured there, clean with cotton tips.

(9) Protective Cap

When the fiber optic receiving module TORX176 is not in use, use the protective cap.

(10) Supply Voltage

Use the supply voltage within the Typ. operating condition ($V_{CC}=5\pm 0.25V$). Make sure that supply voltage does not exceed the maximum rating value of 7V, even instantaneously.

(11) Interface

TORX176 has a TTL interface. It can be interfaced with C-MOS IC that has compatibility with TTL level.

(12) Output

When the receiver output is at low level and connected to the power supply, or when the output is at high level and connected to GND, the internal IC may be destroyed.

(13) Soldering Condition

Solder at 260°C or less within three seconds.

(14) Precaution on Waste

When discarding devices and packing materials, follow procedures stipulated by local regulations in order to protect the environment against contamination.

(15) Precaution on Use

Toshiba is continually working to improve the quality and the reliability of its products. Nevertheless, semiconductor devices in general can malfunction or fail due to their inherent electrical sensitivity and vulnerability to physical stress. It is the responsibility of the buyer, when utilizing Toshiba products, to observe standards of safety, and to avoid situations in which a malfunction or failure of a Toshiba product could cause loss of human life, bodily injury or damage to property.

In developing your designs, please ensure that Toshiba products are used within specified operating ranges as set forth in the most recent product specifications. Also, please keep in mind the precautions and conditions set forth in the Toshiba Semiconductor Reliability Handbook.