

**10 + 10W STEREO AMPLIFIER FOR CAR RADIO**

Its main features are :

**Low distortion.**

**Low noise.**

**High reliability** of the chip and of the package with additional safety during operation thanks to protections against :

- OUTPUT AC SHORT CIRCUIT TO GROUND
- VERY INDUCTIVE LOADS
- OVERRATING CHIP TEMPERATURE
- LOAD DUMP VOLTAGE SURGE
- FORTUITOUS OPEN GROUND

**Space and cost saving** : very low number of external components, very simple mounting system with no electrical isolation between the package and the heatsink.

**DESCRIPTION**

The TDA2004A is a class B dual audio power amplifier in MULTIWATT® package specifically desi-

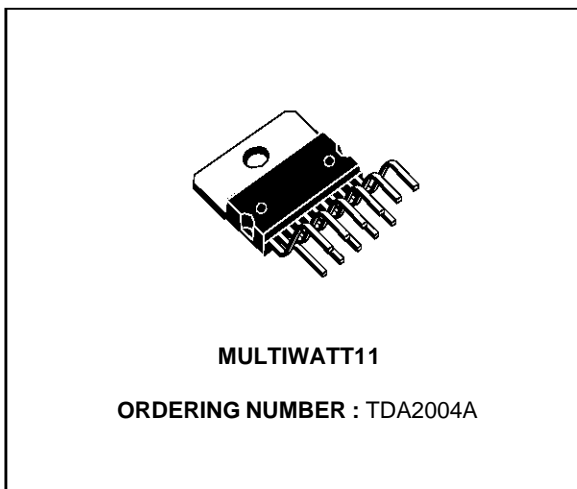

gned for car radio applications ; stereo amplifiers are easily designed using this device that provides a high current capability (up to 3.5 A) and that can drive very low impedance loads (down to 1.6Ω ).

**PIN CONNECTION** (top view)

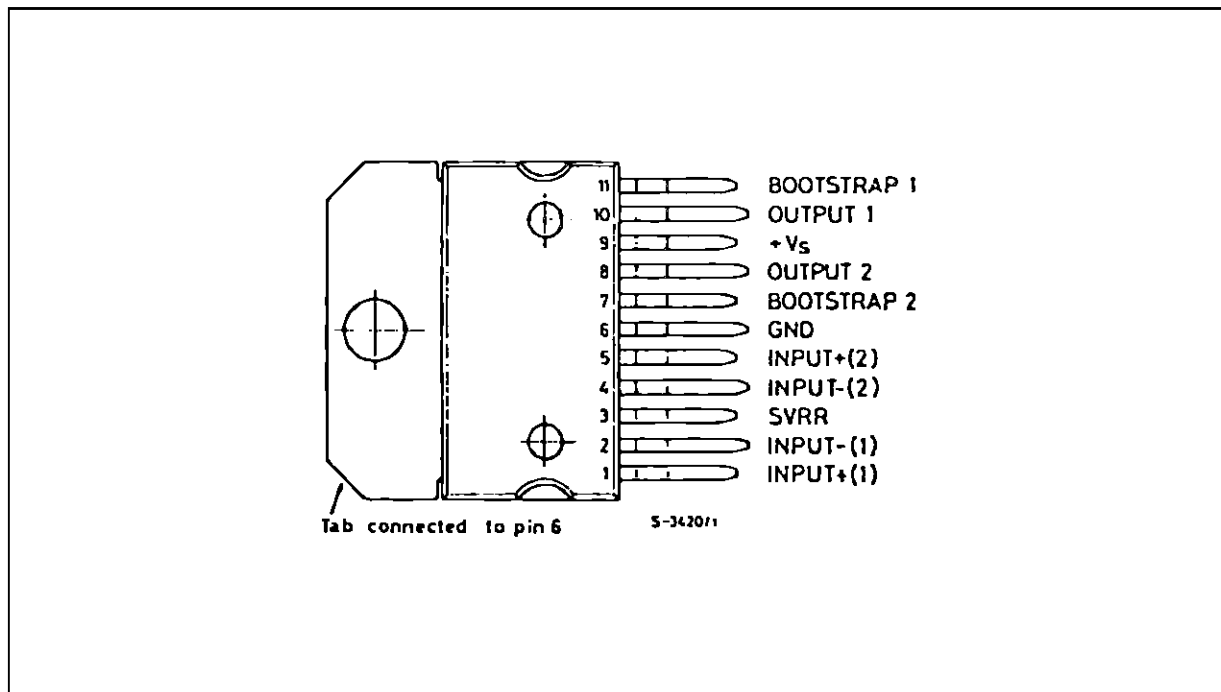

# TDA2004A

## ABSOLUTE MAXIMUM RATINGS

Symbol	Parameter	Value	Unit
V <sub>S</sub>	Operating Supply Voltage	18	V
V <sub>S</sub>	DC Supply Voltage	28	V
V <sub>S</sub>	Peak Supply Voltage (for 50ms)	40	V
I <sub>O</sub> (*)	Output Peak Current (non repetitive t = 0.1ms)	4.5	A
I <sub>O</sub> (*)	Output Peak Current (repetitive f ≥ 10Hz)	3.5	A
P <sub>tot</sub>	Power Dissipation at T <sub>case</sub> = 60°C	30	W
T <sub>j</sub> , T <sub>stg</sub>	Storage and Junction Temperature	-40 to 150	°C

(\*) The max. output current is internally limited.

## THERMAL DATA

Symbol	Parameter	Value	Unit
R <sub>th j-case</sub>	Thermal Resistance Junction-case	Max. 3	°C/W

**ELECTRICAL CHARACTERISTICS** (Refer to the test circuit, T<sub>amb</sub> = 25°C, G<sub>v</sub> = 50dB, R<sub>th</sub> (heatsink) = 4°C/W, unless otherwise specified)

Symbol	Parameter	Test Condition	Min.	Typ.	Max.	Unit
V <sub>S</sub>	Supply Voltage		8		18	V
V <sub>O</sub>	Quiescent Output Voltage	V <sub>S</sub> = 14.4V	6.6	7.2	7.8	V
		V <sub>S</sub> = 13.2V	6.0	6.6	7.2	V
I <sub>d</sub>	Total Quiescent Drain Current	V <sub>S</sub> = 14.4V		65	120	mA
		V <sub>S</sub> = 13.2V		62	120	mA
I <sub>SB</sub>	Stand-by Current	Pin 3 grounded		5		mA
P <sub>O</sub>	Output Power (each channel)	f = 1KHz, d = 10%				
		V <sub>S</sub> = 14.4V				
		R <sub>L</sub> = 4Ω	6	6.5		W
		R <sub>L</sub> = 3.2Ω	7	8		W
		R <sub>L</sub> = 2Ω	9	10(*)		W
		R <sub>L</sub> = 1.6Ω	10	11		W
		V <sub>S</sub> = 13.2V				
		R <sub>L</sub> = 3.2Ω	6	6.5		w
		R <sub>L</sub> = 1.6Ω	9	10		w
		V <sub>S</sub> = 16V; R <sub>L</sub> = 2Ω		12		w
d	Distortion (each channel)	f = 1KHz				
		V <sub>S</sub> = 14.4V; R <sub>L</sub> = 4Ω		0.2	1	%
		P <sub>O</sub> = 50mW to 4W				
		V <sub>S</sub> = 14.4V; R <sub>L</sub> = 2Ω		0.3	1	%
		P <sub>O</sub> = 50mW to 6W				
		V <sub>S</sub> = 13.2V; R <sub>L</sub> = 3.2Ω		0.2	1	%
		P <sub>O</sub> = 50mW to 3W				
		V <sub>S</sub> = 13.2V; R <sub>L</sub> = 1.6Ω		0.3	1	%
		P <sub>O</sub> = 50mW to 6W				
CT	Cross Talk	V <sub>S</sub> = 14.4V				
		V <sub>O</sub> = 4Vrms R <sub>L</sub> = 4Ω				
		f = 1KHz	50	60		dB
		f = 10KHz R <sub>g</sub> = 5KΩ	40	45		dB
V <sub>i</sub>	Input Saturation Voltage		300			mV

**ELECTRICAL CHARACTERISTICS** (continued)

Symbol	Parameter	Test Condition	Min.	Typ.	Max.	Unit
R <sub>i</sub>	Input Resistance (non inverting input)	f = 1KHz	70	200		KΩ
f <sub>L</sub>	Low Frequency Roll off (-3dB)	R <sub>L</sub> = 4Ω R <sub>L</sub> = 2Ω R <sub>L</sub> = 3.2Ω R <sub>L</sub> = 1.6Ω			35 50 40 55	Hz
f <sub>H</sub>	High Frequency Roll off (-3dB)	R <sub>L</sub> = 1.6Ω to 4Ω	15			KHz
G <sub>v</sub>	Voltage gain (open loop)	f = 1KHz		90		dB
	Voltage gain (closed loop)	f = 1KHz	48	50	51	dB
	closed loop gain matching			0.5		dB
e <sub>N</sub>	Total Input noise Voltage	R <sub>g</sub> = 10KΩ (**)		1.5	5	μV
SVR	Supply Voltage Rejection	f <sub>ripple</sub> = 100Hz; R <sub>g</sub> = 10KΩ C3 = 10μF V <sub>ripple</sub> = 0.5Vrms	35	45		dB
η	Efficiency	V <sub>S</sub> = 14.4V f = 1KHz R <sub>L</sub> = 4Ω P <sub>O</sub> = 6.5W		70		%
		R <sub>L</sub> = 2Ω P <sub>O</sub> = 10W		60		%
		V <sub>S</sub> = 13.2V f = 1KHz R <sub>L</sub> = 3.2Ω P <sub>O</sub> = 6.5W		70		%
		R <sub>L</sub> = 1.6Ω P <sub>O</sub> = 10W		60		%
T <sub>J</sub>	Thermal Shutdown Junction Temperature			145		°C

Notes : (\*) 9.3W without Bootstrap  
 (\*\*) Bandwith Filter : 22Hz to 22KHz.

**Figure 1** : Test and Application Circuit.

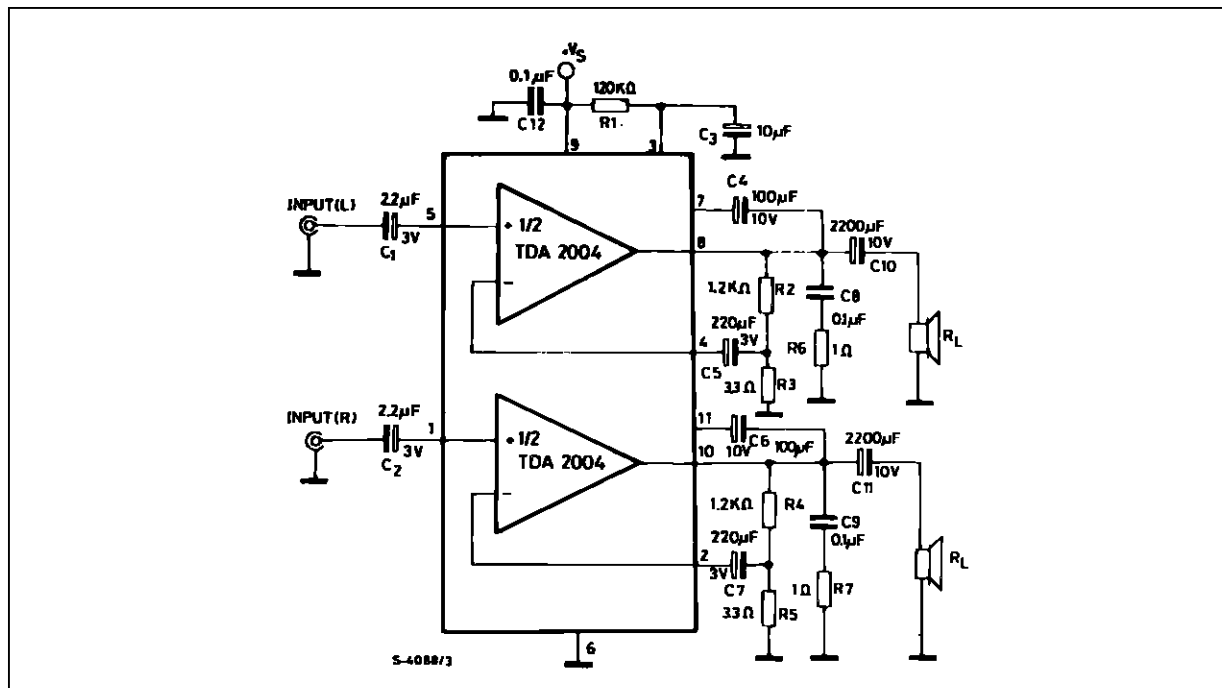

# TDA2004A

Figure 2 : P.C. Board and Component layout of the fig. 1 (scale 1 : 1).

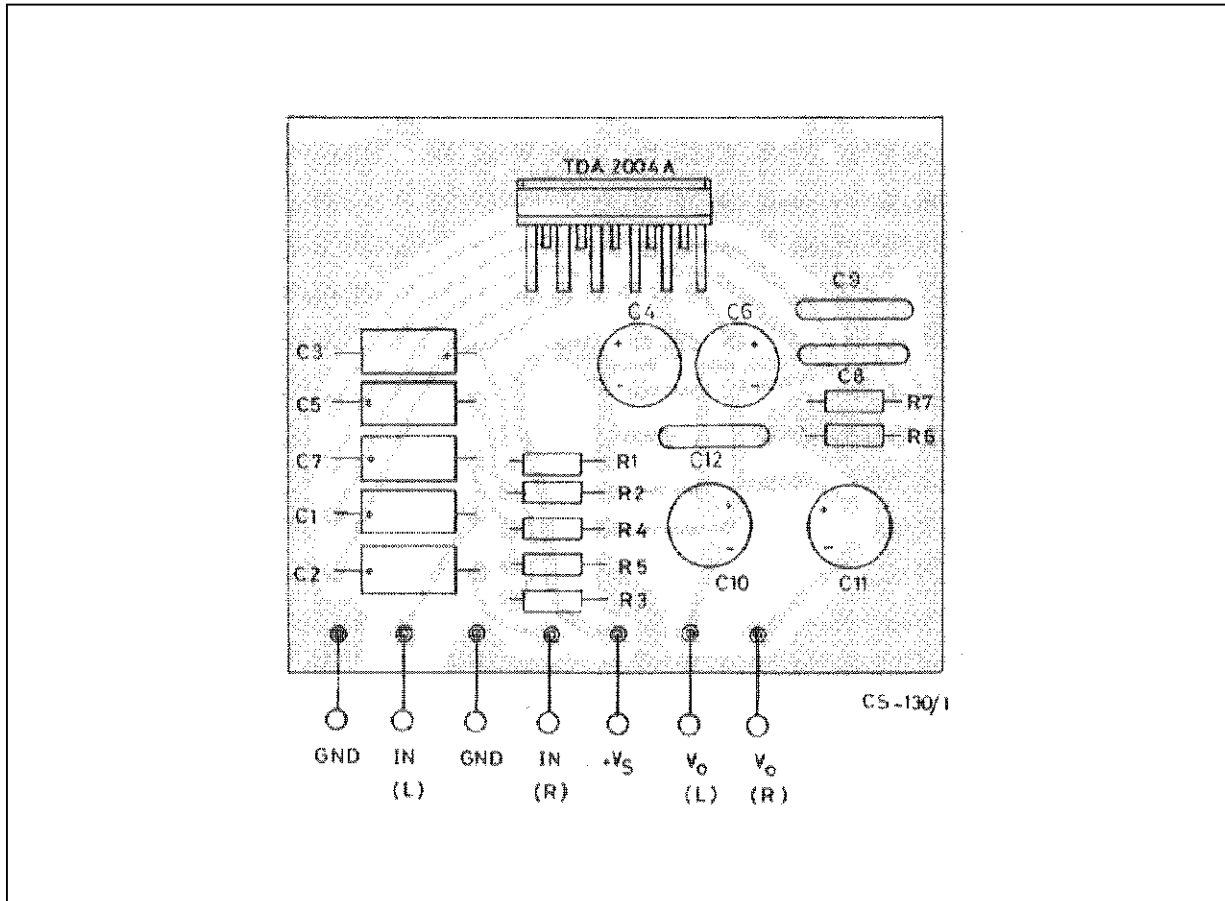

Figure 3 : Quiescent Output Voltage vs. Supply Voltage.

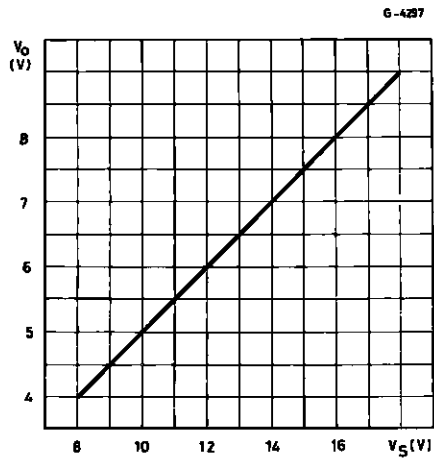

Figure 4 : Quiescent Drain Current vs. Supply Voltage.

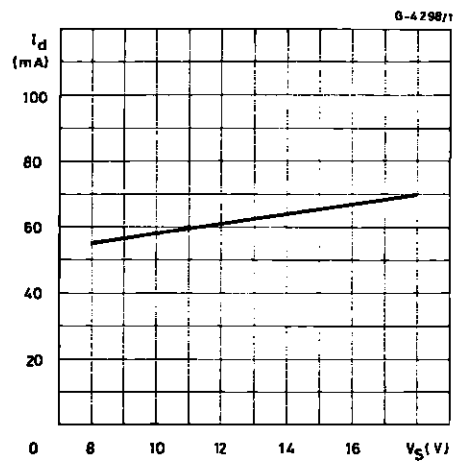

Figure 5 : Distortion vs. Output Power.

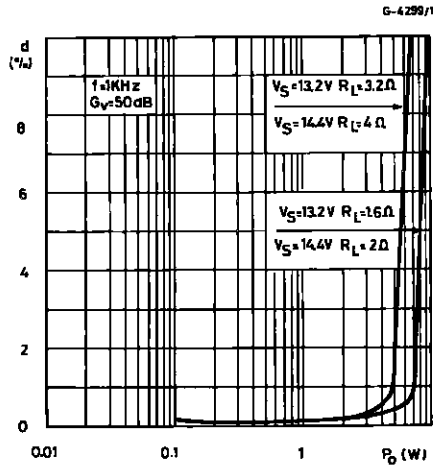

Figure 6 : Output Power vs. Supply Voltage.

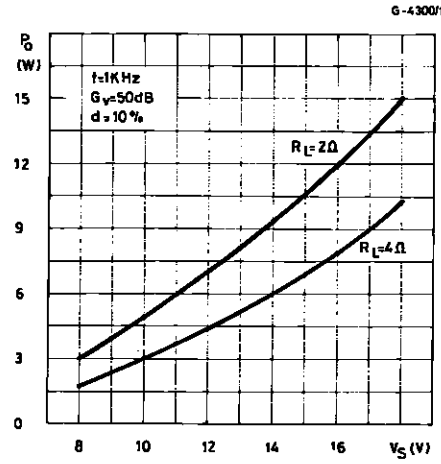

Figure 7 : Output Power vs. Supply Voltage.

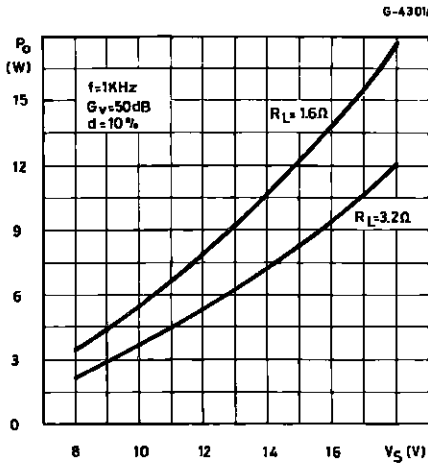

Figure 8 : Distortion vs. Frequency.

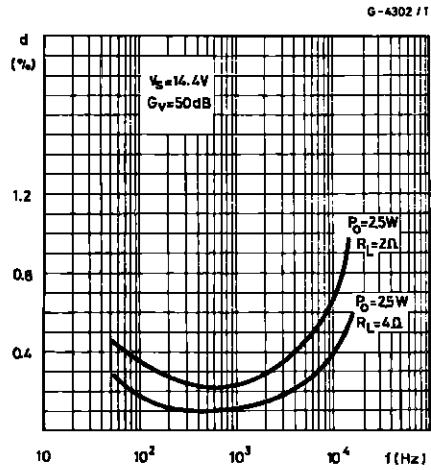

Figure 9 : Distortion vs. Frequency.

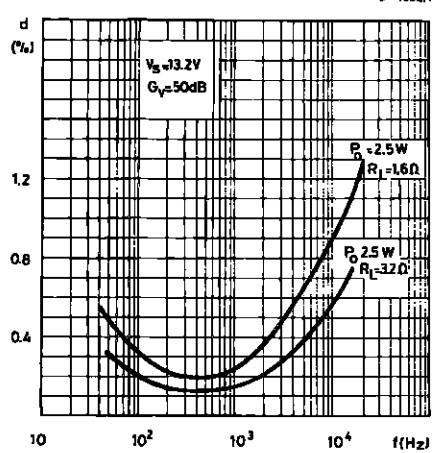

Figure 10 : Supply Voltage Rejection vs. C3.

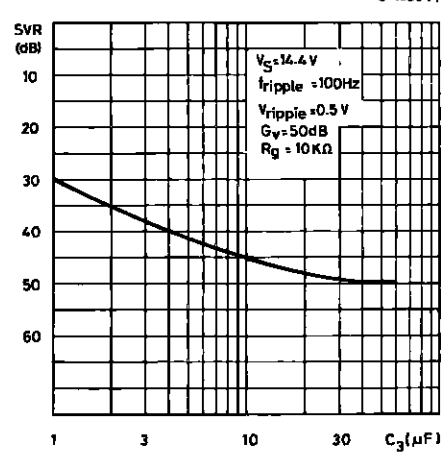

Figure 11 : Supply Voltage Rejection vs. Frequency.

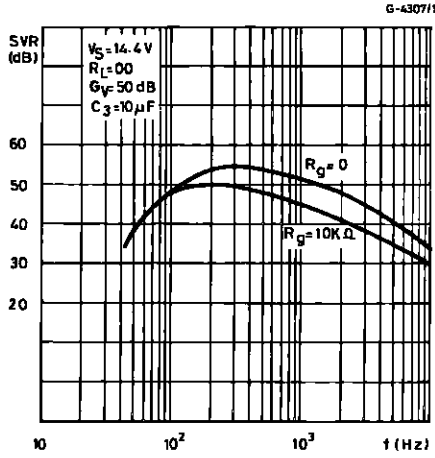

Figure 12 : Supply Voltage Rejection vs. Values of Capacitors C<sub>2</sub> and C<sub>3</sub>.

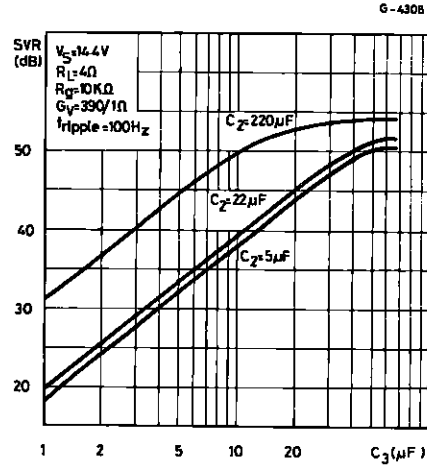

Figure 13 : Supply Voltage Rejection vs. Values of Capacitors C<sub>2</sub> and C<sub>3</sub>.

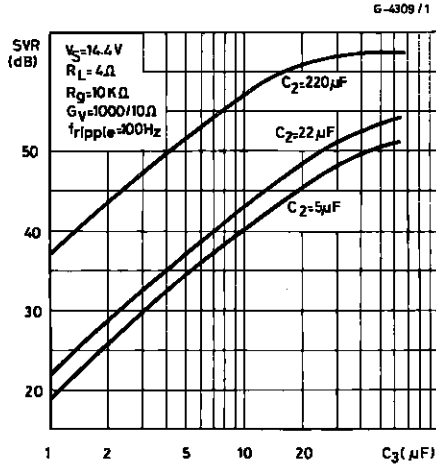

Figure 14 : Gain vs. Input Sensitivity.

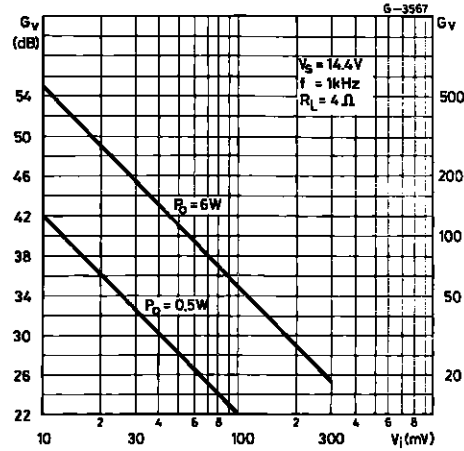

Figure 15 : Maximum Allowable Power Dissipation vs. Ambient Temperature.

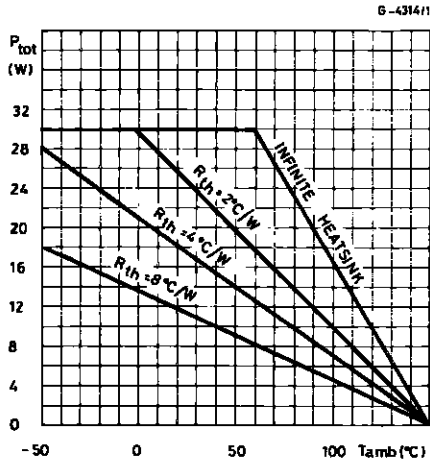
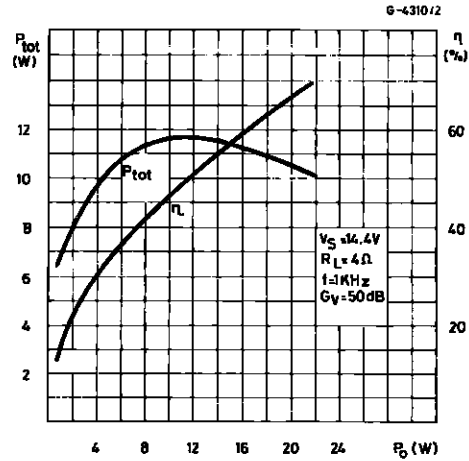
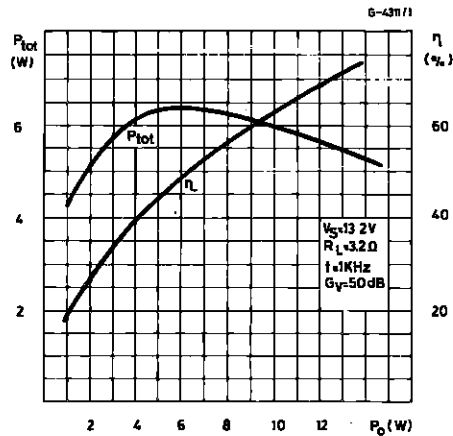

Figure 16 : Total Power Dissipation and Efficiency vs. Output Power.



**Figure 17 : Total Power Dissipation and Efficiency vs. Output Power .**



### APPLICATION SUGGESTION

The recommended values of the components are those shown on application circuit of fig.1. Different values can be used ; the following table can help the designer.

Component	Recomm. Value	Purpose	Larger Than	Smaller Than
R1	120K $\Omega$	Optimization of the output signal symmetry	Smaller P <sub>O</sub> max.	Smaller P <sub>O</sub> max.
R2, R4	1K $\Omega$	Close loop gain setting (*)	Increase of gain	Decrease of gain
R3, R5	3.3 $\Omega$		Decrease of gain	Increase of gain
R6, R7	1 $\Omega$	Frequency stability	Danger of oscillation at high frequency with inductive load	
C1, C2	2.2 $\mu$ F	Input DC decoupling	High turn-on delay	High turn-on pop Higher low frequency cutoff. Increase of noise
C3	10 $\mu$ F	Ripple Rejection	Increase of SVR. Increase of the switch-on time.	Degradation of SVR.
C4, C6	100 $\mu$ F	Boostrapping		Increase of distortion at low frequency
C5, C7	100 $\mu$ F	Feedback Input DC decoupling.		
C8, C9	0.1 $\mu$ F	Frequency Stability		Danger of oscillation.
C10, C11	1000 $\mu$ F to 2200 $\mu$ F	Output DC decoupling.		Higher low-frequency cut-off.

(\*) The closed-loop gain must be higher than 26dB.

## BUILT-IN PROTECTION SYSTEMS

### LOAD DUMP VOLTAGE SURGE

The TDA2004A has a circuit which enables it to withstand a voltage pulse train, on pin 9, of the type shown in Fig. 19.

If the supply voltage peaks to more than 40 V, then an LC filter must be inserted between the supply and pin 9, in order to assure that the pulses at pin 9 will be held within the limits shown.

A suggested LC network is shown in Fig. 18. With this network, a train of pulse with amplitude up to 120 V and with of 2 ms can be applied to point A. This type of protection is ON when the supply voltage (pulse or DC) exceeds 18 V. For this reason the maximum operating supply voltage is 18 V.

**Figure 18.**

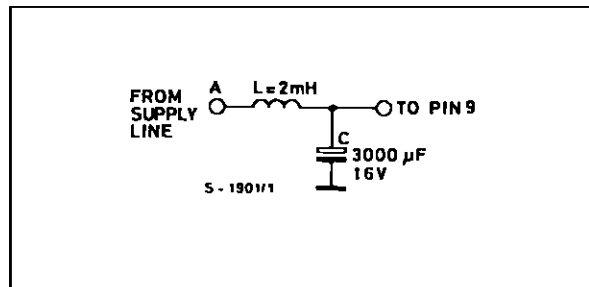

**Figure 19.**

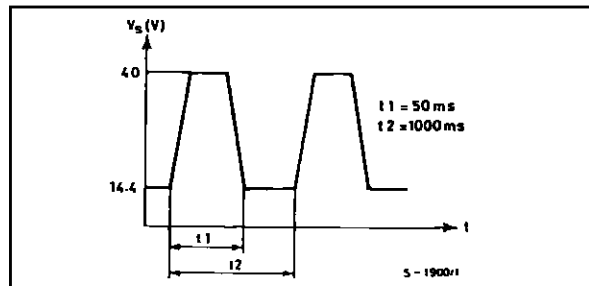

### SHORT CIRCUIT (AC conditions)

The TDA2004A can withstand an accidental short-circuit from the output to ground caused by a wrong connection during normal working.

### POLARITY INVERSION

High current (up to 10 A) can be handled by the device with no damage for a longer period than the blow-out time of a quick 2 A fuse (normally connected in series with the supply). This feature is added to avoid destruction, if during fitting to the car, a mistake on the connection of the supply is made.

### OPEN GROUND

When the ratio is the ON condition and the ground is accidentally opened, a standard audio amplifier will be damaged. On the TDA2004A protection diodes are included to avoid any damage.

### INDUCTIVE LOAD

A protection diode is provided to allow use of the TDA2004A with inductive loads.

### DC VOLTAGE

The maximum operating DC voltage on the TDA2004A is 18 V.

However the device can withstand a DC voltage up to 28 V with no damage. This could occur during winter if two batteries are series connected to crank the engine.

### THERMAL SHUT-DOWN

The presence of a thermal limiting circuit offers the following advantages :

- 1) an overload on the output (even if it is permanent), or an excessive ambient temperature can be easily withstood.
- 2) the heatsink can have a smaller factor of safety compared with that of a conventional circuit. There is no device damage in the case of excessive junction temperature ; all that happens is the  $P_O$  (and therefore  $P_{tot}$ ) and  $I_d$  are reduced.

The maximum allowable power dissipation depends upon the size of the external heatsink (i.e. its thermal resistance) ; fig. 15 shown this dissipable power as a function of ambient temperature for different thermal resistance.



## MULTIWATT11 PACKAGE MECHANICAL DATA

DIM.	mm			inch		
	MIN.	TYP.	MAX.	MIN.	TYP.	MAX.
A			5			0.197
B			2.65			0.104
C			1.6			0.063
D		1			0.039	
E	0.49		0.55	0.019		0.022
F	0.88		0.95	0.035		0.037
G	1.45	1.7	1.95	0.057	0.067	0.077
G1	16.75	17	17.25	0.659	0.669	0.679
H1	19.6			0.772		
H2			20.2			0.795
L	21.9	22.2	22.5	0.862	0.874	0.886
L1	21.7	22.1	22.5	0.854	0.87	0.886
L2	17.4		18.1	0.685		0.713
L3	17.25	17.5	17.75	0.679	0.689	0.699
L4	10.3	10.7	10.9	0.406	0.421	0.429
L7	2.65		2.9	0.104		0.114
M	4.25	4.55	4.85	0.167	0.179	0.191
M1	4.73	5.08	5.43	0.186	0.200	0.214
S	1.9		2.6	0.075		0.102
S1	1.9		2.6	0.075		0.102
Dia1	3.65		3.85	0.144		0.152

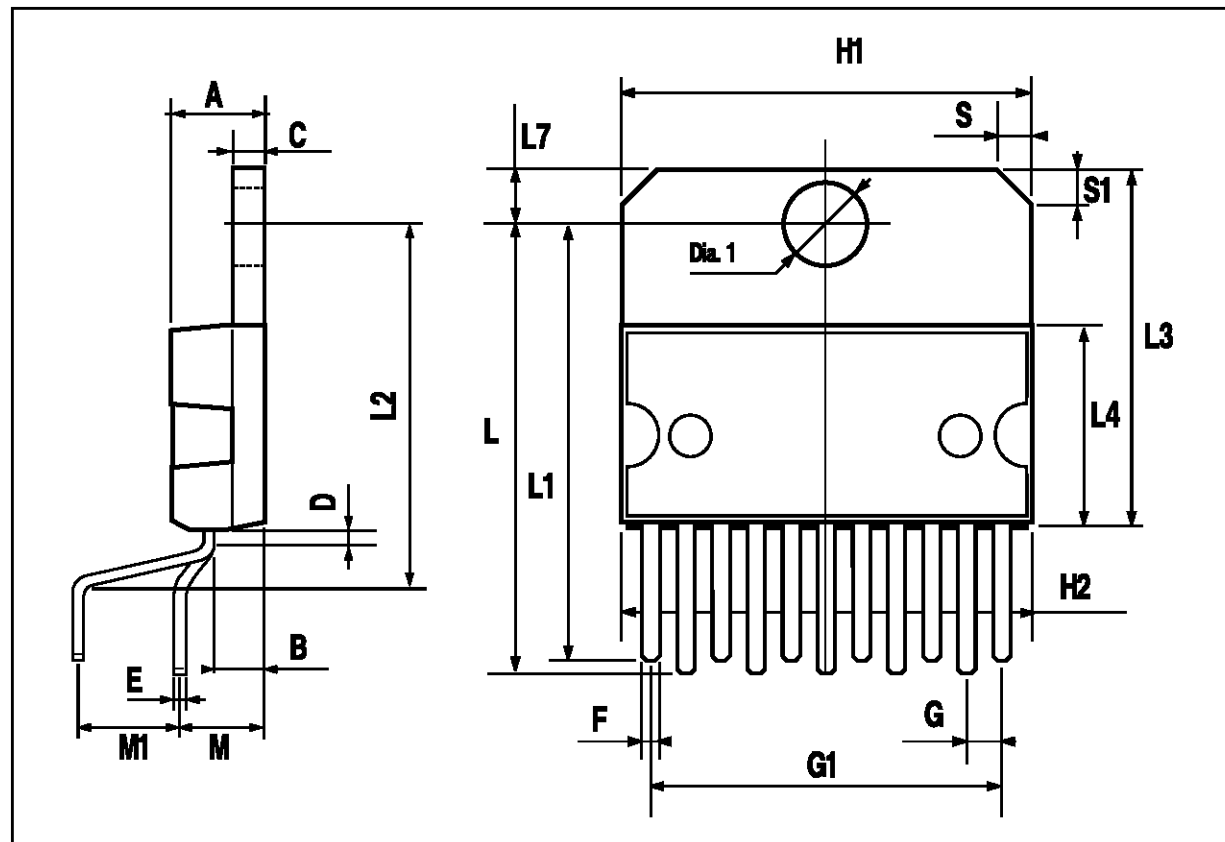

Information furnished is believed to be accurate and reliable. However, SGS-THOMSON Microelectronics assumes no responsibility for the consequences of use of such information nor for any infringement of patents or other rights of third parties which may result from its use. No license is granted by implication or otherwise under any patent or patent rights of SGS-THOMSON Microelectronics. Specifications mentioned in this publication are subject to change without notice. This publication supersedes and replaces all information previously supplied. SGS-THOMSON Microelectronics products are not authorized for use as critical components in life support devices or systems without express written approval of SGS-THOMSON Microelectronics.

© 1995 SGS-THOMSON Microelectronics - All Rights Reserved  
MULTIWATT® is a Registered Trademark of SGS-THOMSON Microelectronics

SGS-THOMSON Microelectronics GROUP OF COMPANIES  
Australia - Brazil - France - Germany - Hong Kong - Italy - Japan - Korea - Malaysia - Malta - Morocco - The Netherlands - Singapore -  
Spain - Sweden - Switzerland - Taiwan - Thailand - United Kingdom - U.S.A.