

**WIDE BANDWIDTH  
 SINGLE J-FET OPERATIONAL AMPLIFIERS**

- HIGH INPUT IMPEDANCE J-FET INPUT STAGE
- HIGH SPEED J-FET OP-AMPS : up to 20MHz, 50V/μs
- OFFSET VOLTAGE ADJUSTMENT DOES NOT DEGRADE DRIFT OR COMMON-MODE REJECTION AS IN MOST OF MONOLITHIC AMPLIFIERS
- INTERNAL COMPENSATION AND LARGE DIFFERENTIAL INPUT VOLTAGE CAPABILITY (UP TO  $V_{CC}^+$ )

**TYPICAL APPLICATIONS**

- PRECISION HIGH SPEED INTEGRATORS
- FAST D/A AND CONVERTERS
- HIGH IMPEDANCE BUFFERS
- WIDEBAND, LOW NOISE, LOW DRIFT AMPLIFIERS
- LOGARITHMIC AMPLIFIERS
- PHOTOCCELL AMPLIFIERS
- SAMPLE AND HOLD CIRCUITS

**DESCRIPTION**

These circuits are monolithic J-FET input operational amplifiers incorporating well matched, high voltage J-FET on the same chip with standard bipolar transistors.

This amplifiers feature low input bias and offset currents, low input offset voltage and input offset voltage drift, coupled with offset adjust which does not degrade drift or common-mode rejection.

The devices are also designed for high slew rate, wide bandwidth, extremely fast settling time, low voltage and current noise and a low 1/f noise level.

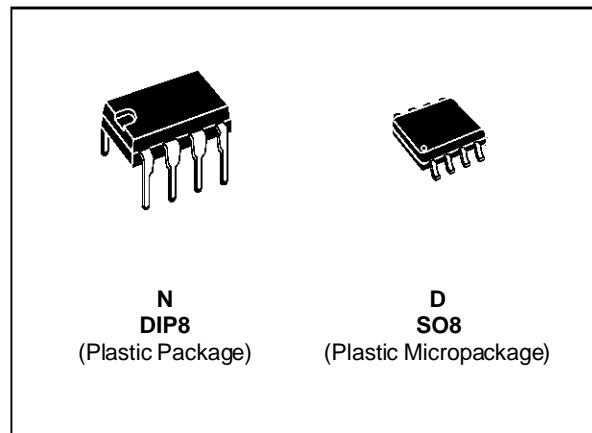

**ORDER CODES**

Part Number	Temperature Range	Package	
		N	D
LF355, LF356, LF357	0°C, +70°C	•	•
LF255, LF256, LF257	-40°C, +105°C	•	•
LF155, LF156, LF157	-55°C, +125°C	•	•

**Example** : LF355N

**PIN CONNECTIONS (top view)**

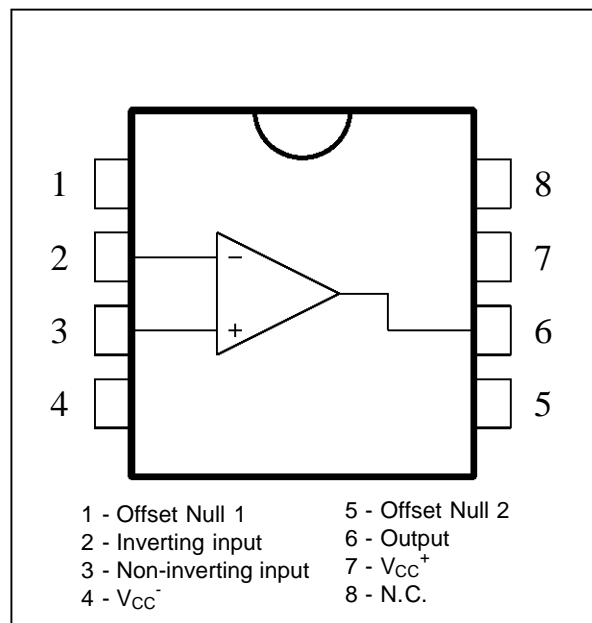

**SCHEMATIC DIAGRAM**

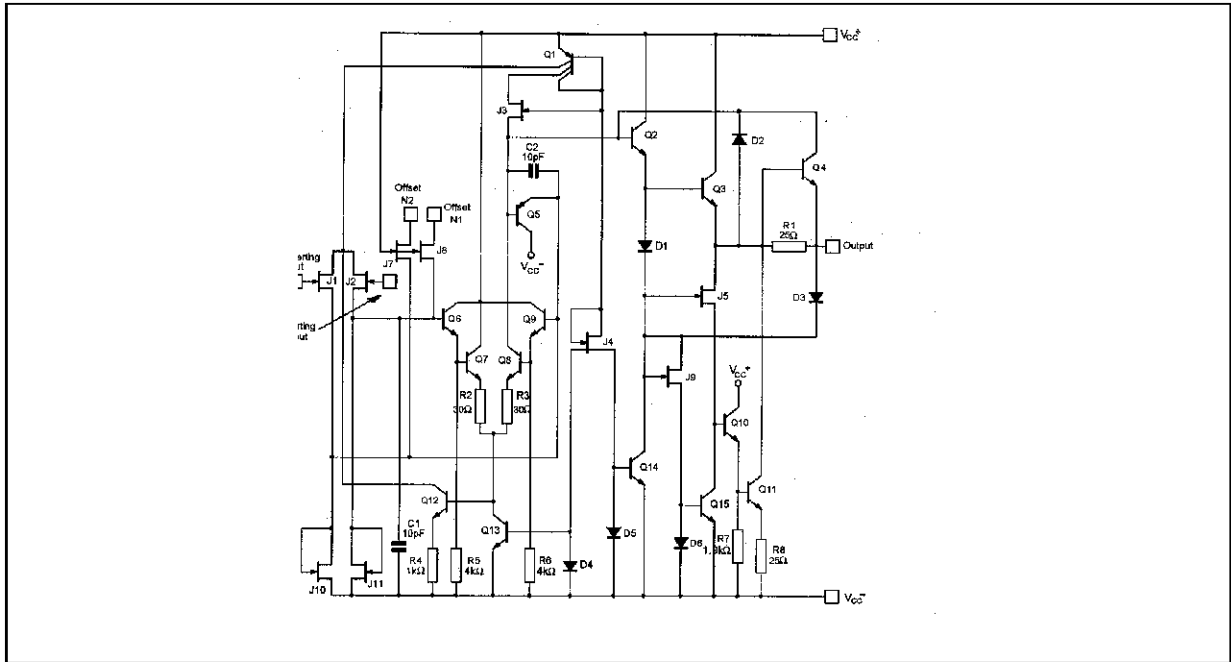

**V<sub>io</sub> ADJUSTMENT**

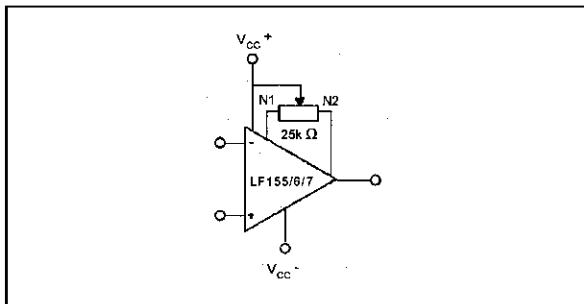

**ABSOLUTE MAXIMUM RATINGS**

Symbol	Parameter	Value	Unit	
V <sub>CC</sub>	Supply Voltage	±2	V	
V <sub>i</sub>	Input Voltage - (note 1)	±20	V	
V <sub>id</sub>	Differential Input Voltage	±40	V	
P <sub>tot</sub>	Power Dissipation	570	mW	
	Output Short-circuit Duration	Infinite		
T <sub>oper</sub>	Operating Free Air Temperature Range	LF155-LF156-LF157 LF255-LF256-LF257 LF355-LF356-LF357	-55 to +125 -40 to +105 0 to 70	°C
T <sub>stg</sub>	Storage Temperature Range		-65 to 150	°C

**ELECTRICAL CHARACTERISTICS**

**LF155, LF156, LF157**  $-55^{\circ}\text{C} \leq T_{\text{amb}} \leq +125^{\circ}\text{C}$   $\pm 5\text{V} \leq V_{\text{CC}} \leq \pm 20\text{V}$   
**LF255, LF256, LF257**  $-40^{\circ}\text{C} \leq T_{\text{amb}} \leq +105^{\circ}\text{C}$   $\pm 5\text{V} \leq V_{\text{CC}} \leq \pm 20\text{V}$   
(unless otherwise specified)

Symbol	Parameter	LF155 - LF156 - LF157 LF255 - LF256 - LF257			Unit
		Min.	Typ.	Max.	
$V_{io}$	Input Offset Voltage ( $R_S = 50\Omega$ ) $T_{\text{amb}} = 25^{\circ}\text{C}$ $T_{\text{min.}} \leq T_{\text{amb}} \leq T_{\text{max.}}$		3	5 7 6.2	mV
$I_{io}$	Input Offset Current - (note 3) $T_{\text{amb}} = 25^{\circ}\text{C}$ $T_{\text{min.}} \leq T_{\text{amb}} \leq T_{\text{max.}}$		3	20 20 1	pA nA nA
$I_{ib}$	Input Bias Current - (note 3) $T_{\text{amb}} = 25^{\circ}\text{C}$ $T_{\text{min.}} \leq T_{\text{amb}} \leq T_{\text{max.}}$		20	100 50 5	pA nA nA
$A_{vd}$	Large Signal Voltage Gain ( $R_L = 2k\Omega$ , $V_O = \pm 10\text{V}$ , $V_{\text{CC}} = \pm 15\text{V}$ ) $T_{\text{amb}} = 25^{\circ}\text{C}$ $T_{\text{min.}} \leq T_{\text{amb}} \leq T_{\text{max.}}$	50 25	200		V/mV
SVR	Supply Voltage Rejection Ratio - (note 4)	85	100		dB
$I_{\text{CC}}$	Supply Current ( $V_{\text{CC}} = \pm 15\text{V}$ , no load) $T_{\text{amb}} = 25^{\circ}\text{C}$		2 5 5	4 7 7	mA
$DV_{io}$	Input Offset Voltage Drift ( $R_S = 50\Omega$ )		5		$\mu\text{V}/^{\circ}\text{C}$
$DV_{io}/V_{io}$	Change in Average Temperature Coefficient with $V_{io}$ adjust ( $R_S = 50\Omega$ ) - (note 2)		0.5		$\mu\text{V}/^{\circ}\text{C}$
$V_{\text{icm}}$	Input Common Mode Voltage Range ( $V_{\text{CC}} = \pm 15\text{V}$ , $T_{\text{amb}} = 25^{\circ}\text{C}$ )	$\pm 11$	+15.1 -12		V
CMR	Common Mode Rejection Ratio	85	100		dB
$\pm V_{\text{OPP}}$	Output Voltage Swing ( $V_{\text{CC}} = \pm 15\text{V}$ ) $R_L = 10k\Omega$ $R_L = 2k\Omega$	$\pm 12$ $\pm 10$	$\pm 13$ $\pm 12$		V
GBP	Gain Bandwidth Product ( $V_{\text{CC}} = \pm 15\text{V}$ , $T_{\text{amb}} = 25^{\circ}\text{C}$ ) LF155, LF255 LF156, LF256 LF157, LF257		2.5 5 20		MHz
SR	Slew Rate ( $V_{\text{CC}} = \pm 15\text{V}$ , $T_{\text{amb}} = 25^{\circ}\text{C}$ ) $A_V = 1$ $A_V = 5$	7.5 30	5 12 50		V/ $\mu\text{s}$
$R_i$	Input Resistance ( $T_{\text{amb}} = 25^{\circ}\text{C}$ )		$10^{12}$		$\Omega$
$C_i$	Input Capacitance ( $V_{\text{CC}} = \pm 15\text{V}$ , $T_{\text{amb}} = 25^{\circ}\text{C}$ )		3		pF
$e_n$	Equivalent Input Noise Voltage ( $V_{\text{CC}} = \pm 15\text{V}$ , $T_{\text{amb}} = 25^{\circ}\text{C}$ , $R_S = 100\Omega$ ) $f = 1000\text{Hz}$  $f = 100\text{Hz}$		20 12 12 25 15 15		$\frac{\text{nV}}{\sqrt{\text{Hz}}}$
$i_n$	Equivalent Input Noise Current ( $V_{\text{CC}} = \pm 15\text{V}$ , $T_{\text{amb}} = 25^{\circ}\text{C}$ , $f = 100\text{Hz}$ or $f = 1000\text{Hz}$ )		0.01		$\frac{\text{pA}}{\sqrt{\text{Hz}}}$
$t_s$	Settling Time ( $V_{\text{CC}} = \pm 15\text{V}$ , $T_{\text{amb}} = 25^{\circ}\text{C}$ ) - (note 5) LF155, LF255 LF156, LF256 LF157, LF257		4 1.5 1.5		$\mu\text{s}$

# LF155 - LF156 - LF157

## ELECTRICAL CHARACTERISTICS

LF355, LF356, LF357

$0^{\circ}\text{C} \leq T_{\text{amb}} \leq +70^{\circ}\text{C}$

$V_{\text{CC}} = \pm 15\text{V}$ , (unless otherwise specified)

Symbol	Parameter	LF355 - LF356 - LF357			Unit
		Min.	Typ.	Max.	
$V_{\text{io}}$	Input Offset Voltage ( $R_{\text{S}} = 50\Omega$ ) $T_{\text{amb}} = 25^{\circ}\text{C}$ $T_{\text{min.}} \leq T_{\text{amb}} \leq T_{\text{max.}}$		3	10 13	mV
$I_{\text{io}}$	Input Offset Current - (note 3) $T_{\text{amb}} = 25^{\circ}\text{C}$ $T_{\text{min.}} \leq T_{\text{amb}} \leq T_{\text{max.}}$		3	50 2	pA nA
$I_{\text{ib}}$	Input Bias Current - (note 3) $T_{\text{amb}} = 25^{\circ}\text{C}$ $T_{\text{min.}} \leq T_{\text{amb}} \leq T_{\text{max.}}$		20	200 8	pA nA
$A_{\text{vd}}$	Large Signal Voltage Gain ( $R_{\text{L}} = 2\text{k}\Omega$ , $V_{\text{O}} = \pm 10\text{V}$ ) $T_{\text{amb}} = 25^{\circ}\text{C}$ $T_{\text{min.}} \leq T_{\text{amb}} \leq T_{\text{max.}}$	25 15	200		V/mV
SVR	Supply Voltage Rejection Ratio - (note 4)	80	100		dB
$I_{\text{CC}}$	Supply Current (no load) $T_{\text{amb}} = 25^{\circ}\text{C}$				mA
				LF355 2 LF356, LF357 5 4 10	
$DV_{\text{io}}$	Input Offset Voltage Drift ( $R_{\text{S}} = 50\Omega$ ) - (note 2)		5		$\mu\text{V}/^{\circ}\text{C}$
$DV_{\text{io}}/V_{\text{io}}$	Change in Average Temperature Coefficient with $V_{\text{io}}$ adjust ( $R_{\text{S}} = 50\Omega$ )		0.5		$\mu\text{V}/^{\circ}\text{C}$ per mV
$V_{\text{icm}}$	Input Common Mode Voltage Range ( $T_{\text{amb}} = 25^{\circ}\text{C}$ )	$\pm 10$	+15.1 -12		V
CMR	Common Mode Rejection Ratio	80	100		dB
$\pm V_{\text{OPP}}$	Output Voltage Swing				V
		$R_{\text{L}} = 10\text{k}\Omega$ $R_{\text{L}} = 2\text{k}\Omega$	$\pm 12$ $\pm 10$	$\pm 13$ $\pm 12$	
GBP	Gain Bandwidth Product ( $T_{\text{amb}} = 25^{\circ}\text{C}$ )				MHz
		LF355 LF356 LF357		2.5 5 20	
SR	Slew Rate ( $T_{\text{amb}} = 25^{\circ}\text{C}$ ) $A_{\text{V}} = 1$ $A_{\text{V}} = 5$				V/ $\mu\text{s}$
		LF355 LF356 LF357		5 12 50	
$R_{\text{i}}$	Input Resistance ( $T_{\text{amb}} = 25^{\circ}\text{C}$ )		$10^{12}$		$\Omega$
$C_{\text{i}}$	Input Capacitance ( $T_{\text{amb}} = 25^{\circ}\text{C}$ )		3		pF
$e_{\text{n}}$	Equivalent Input Noise Voltage ( $T_{\text{amb}} = 25^{\circ}\text{C}$ , $R_{\text{S}} = 100\Omega$ ) $f = 1000\text{Hz}$ $f = 100\text{Hz}$				$\frac{\text{nV}}{\sqrt{\text{Hz}}}$
		LF355 LF356, LF357 LF355 LF356, LF357		20 12 25 15	
$i_{\text{n}}$	Equivalent Input Noise Current ( $T_{\text{amb}} = 25^{\circ}\text{C}$ , $f = 100\text{Hz}$ or $f = 1000\text{Hz}$ )		0.01		$\frac{\text{pA}}{\sqrt{\text{Hz}}}$
$t_{\text{s}}$	Settling Time ( $T_{\text{amb}} = 25^{\circ}\text{C}$ ) - (note 5)				$\mu\text{s}$
		LF355 LF356, LF357		4 1.5	

- Notes:**
1. Unless otherwise specified the absolute maximum negative input voltage is equal to the negative power supply voltage.
  2. The temperature coefficient of the adjusted input offset voltage changes only a small amount ( $0.5\mu\text{V}/^{\circ}\text{C}$  typically) for each mV of adjustment from its original unadjusted value. Common-mode rejection and open loop voltage gain are also unaffected by offset adjustment.
  3. The input bias currents are junction leakage currents which approximately double for every  $10^{\circ}\text{C}$  increase in the junction temperature  $T_{\text{amb}}$ . Due to limited production test time, the input bias current measured is correlated to junction temperature. In a normal operation the junction temperature rises above the ambient temperature as a result of internal power dissipation,  $P_{\text{tot}} T_{\text{amb}} = T_{\text{amb}} + R_{\text{th(j-a)}} \times P_{\text{tot}}$  where  $R_{\text{th(j-a)}}$  is the thermal resistance from junction to ambient. Use of a heatsink is recommended if input currents are to be kept to a minimum.
  4. Supply voltage rejection is measured for both supply magnitudes increasing or decreasing simultaneously, in accordance with common practise.
  5. Settling time is defined here, for a unity gain inverter connection using  $2\text{k}\Omega$  resistors for the LF155, LF156 series. It is the time required for the error voltage (the voltage at the inverting input pin on the amplifier) to settle to within 0.01% of its final value from the time a 10V step input is applied to the inverter. For the LF157 series  $A_{\text{V}} = -5$ , the feedback resistor from output to input is  $2\text{k}\Omega$  and the output step is 10V.

## APPLICATION HINTS

The LF155, LF156, LF157 series are op amps with J-FET input transistors. These JFETs have large reverse breakdown voltages from gate to source or drain eliminating the need of clamps across the inputs. Therefore large differential input voltages can easily be accommodated without a large increase of input currents. The maximum differential input voltage is independent of the supply voltage. However, neither of the negative input voltages should be allowed to exceed the negative supply as this will cause large currents to flow which can result in a destroyed unit. Exceeding the negative common-mode limit on either input will cause a reversal of the phase to the output and force the amplifier output to the corresponding high or low state. Exceeding the negative common-mode limit on both inputs will force the amplifier output to a high state. In neither case does a latch occur since raising the input back within the common-mode range again puts the input stage and thus the amplifier in a normal operating mode. Exceeding the positive common-mode limit on a single input will not change the phase of the output however, if both inputs exceed the limit, the output of the amplifier will be forced to a high state. These amplifiers will operate with the common-mode input voltage equal to the positive supply. In fact, the common-mode voltage can exceed the positive supply by approximately 100 mV independent of supply voltage and over the full operating temperature range. The positive supply can therefore be used as a reference on an input as, for example, in a supply current monitor and/or limiter. Precautions should be taken to ensure that the power supply for the integrated circuit never becomes reversed in polarity or that the unit is not inadvertently installed backwards

in a socket as an unlimited current surge through the resulting forward diode within the IC could cause fusing of the internal conductors and result in a destroyed unit. Because these amplifiers are JFET rather than MOSFET input op amps they do not require special handling.

All of the bias currents in these amplifiers are set by FET current sources. The drain currents for the amplifiers are therefore essentially independent of supply voltages.

As with most amplifiers, care should be taken with lead dress, components placement and supply decoupling in order to ensure stability. For example, resistors from the output to an input should be placed with the body close to the input to minimize "pickup" and maximize the frequency of the feedback pole by minimizing the capacitance from the input to ground.

A feedback pole is created when the feedback around any amplifier is resistive. The parallel resistance and capacitance from the input of the device (usually the inverting input) to a ground set the frequency of the pole. In many instances the frequency of this pole is much greater than the expected 3 dB frequency of the closed loop gain and consequently there is negligible effect on stability margin. However, if the feedback pole is less than approximately six times the expected 3 dB frequency a lead capacitor should be placed from the output to the input of the op amp. The value of that added capacitor should be such that the RC time constant of this capacitor and the resistance it parallels is greater than or equal to the original feedback pole time constant.

TYPICAL CIRCUITS

LARGE POWER BW AMPLIFIER

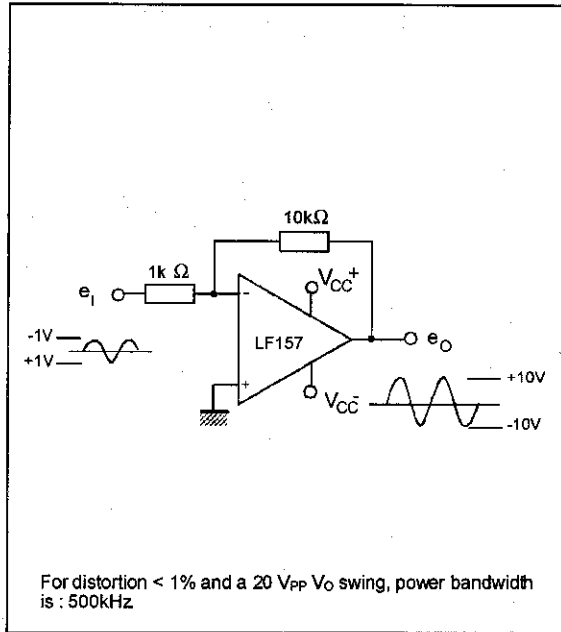

SETTLING TIME TEST CIRCUIT

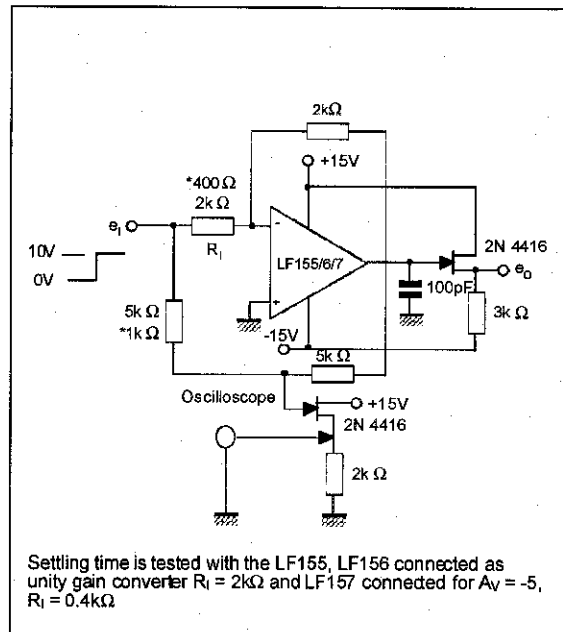

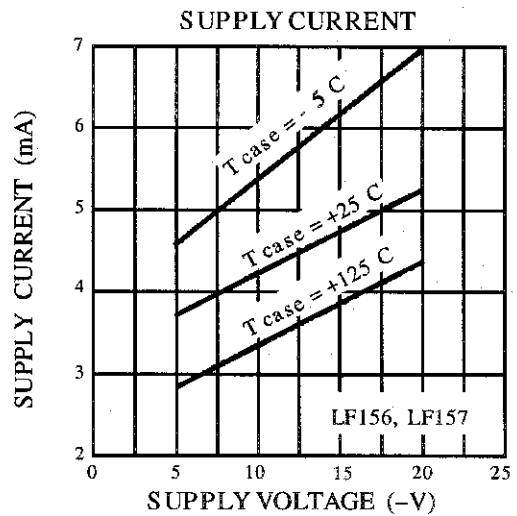
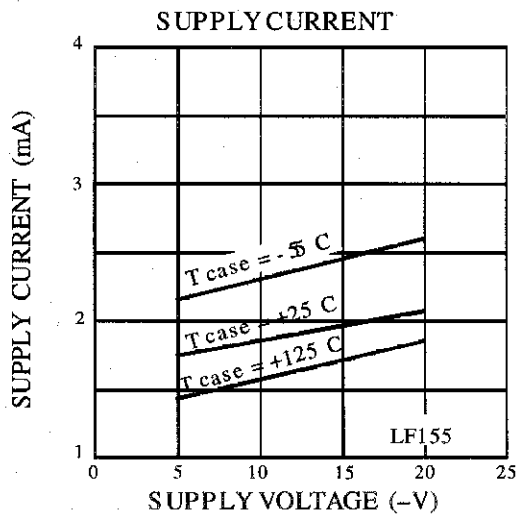
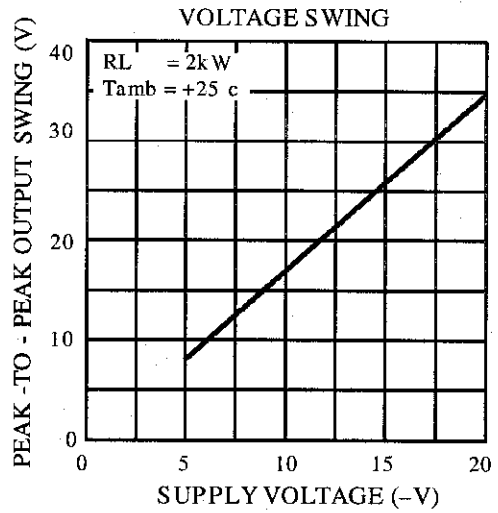
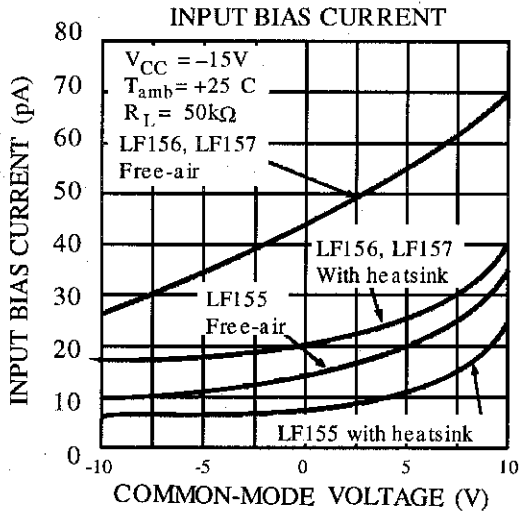
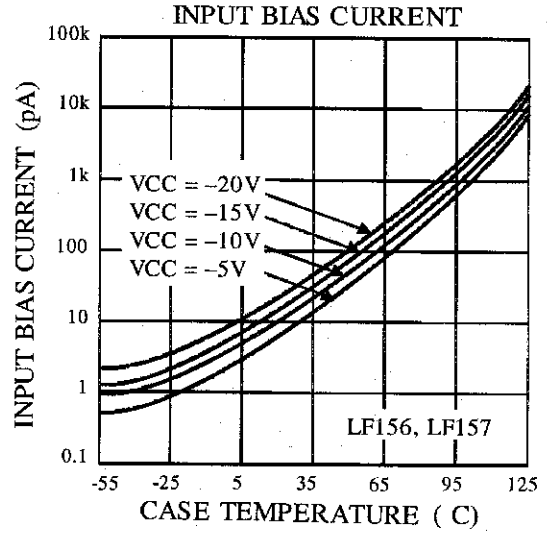
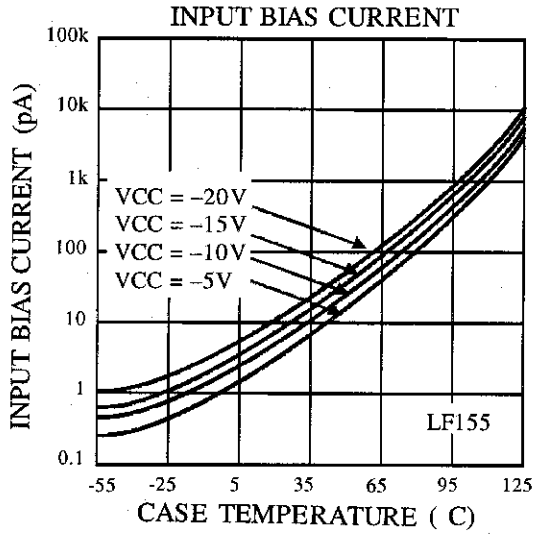

SMALL SIGNAL PULSE RESPONSE

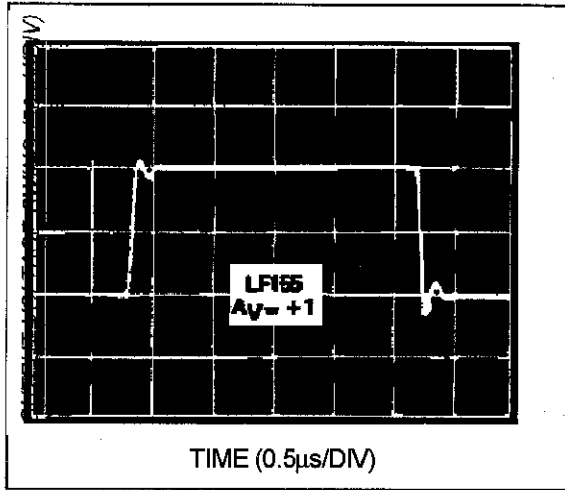

SMALL SIGNAL PULSE RESPONSE

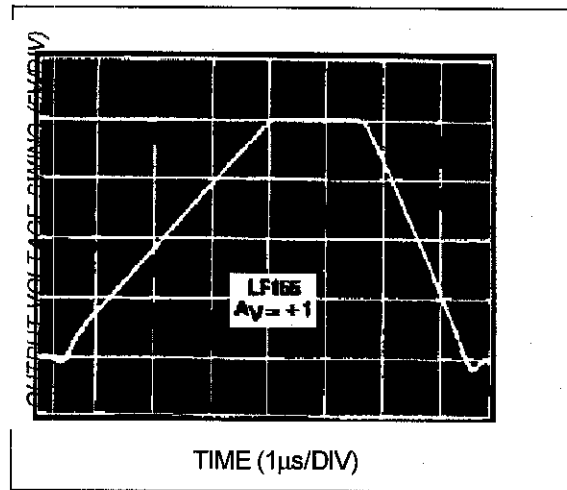

SMALL SIGNAL PULSE RESPONSE

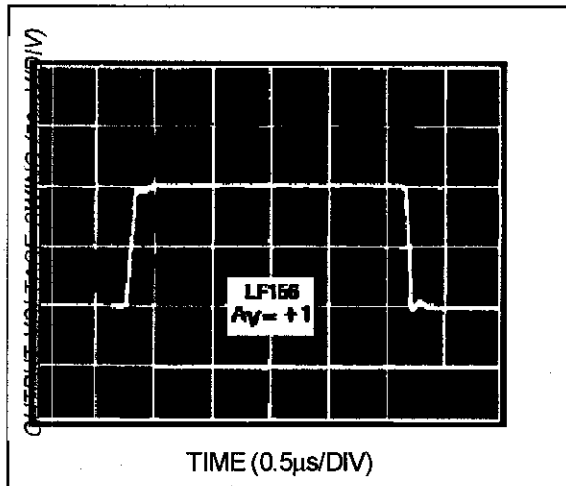

SMALL SIGNAL PULSE RESPONSE

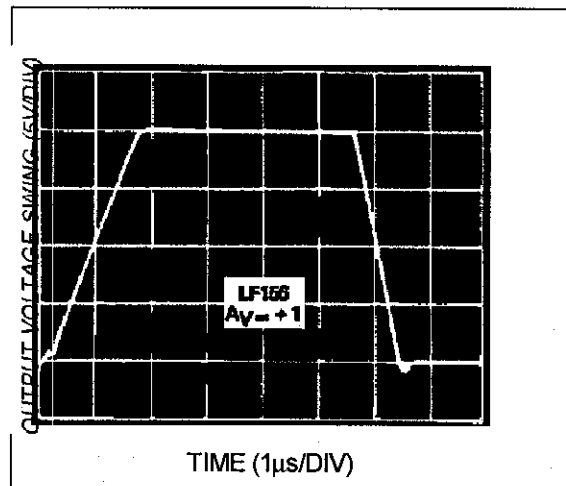

SMALL SIGNAL PULSE RESPONSE

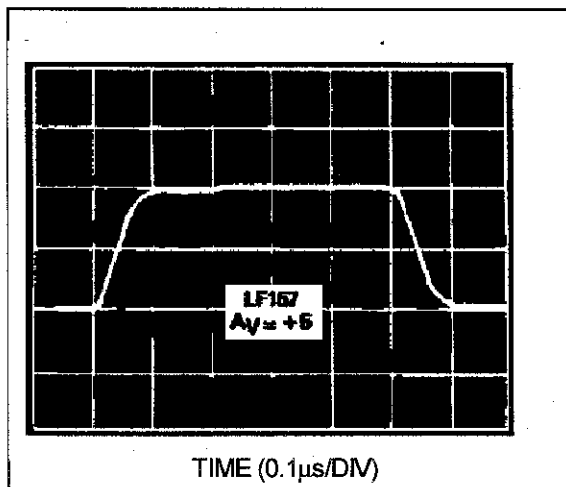

SMALL SIGNAL PULSE RESPONSE

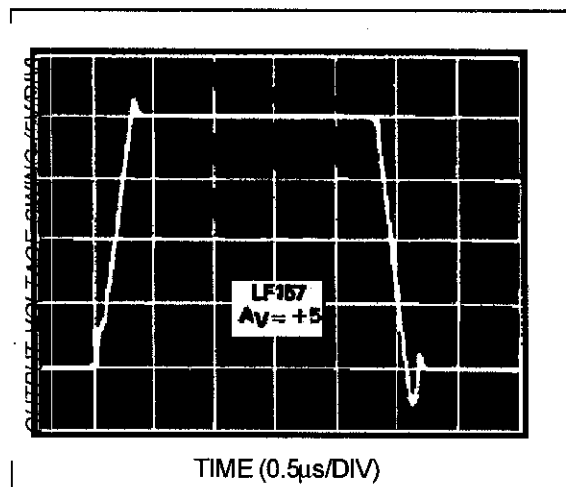



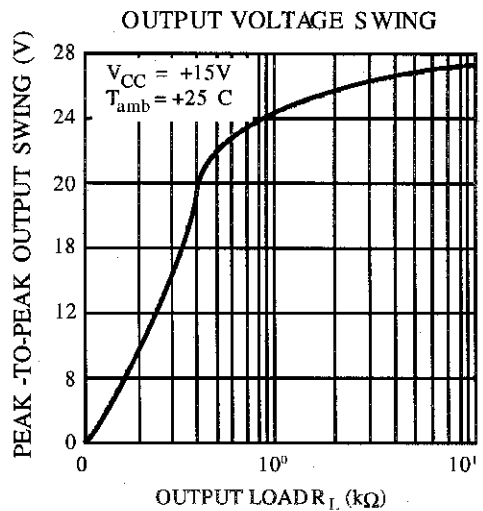
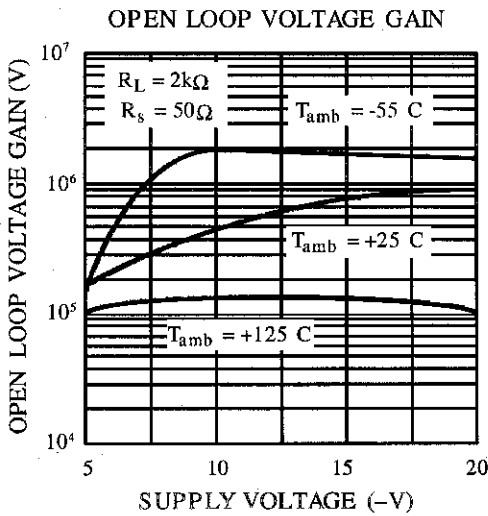
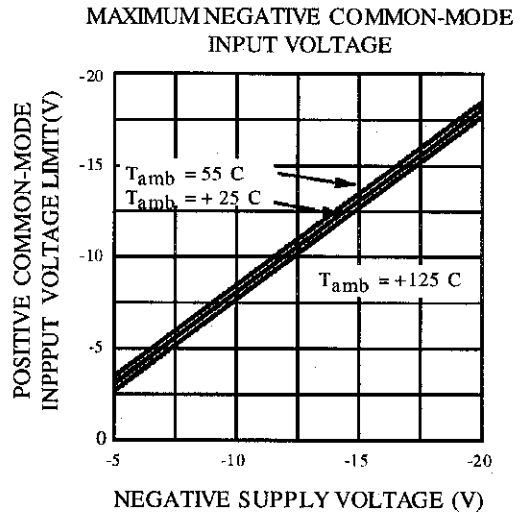
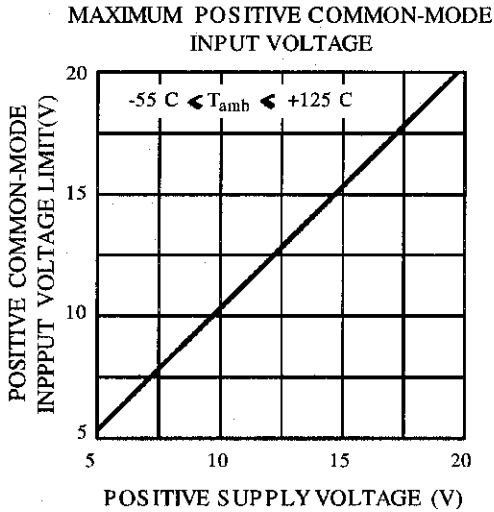
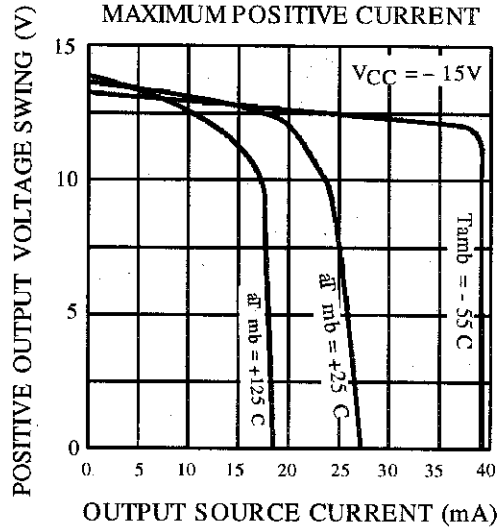
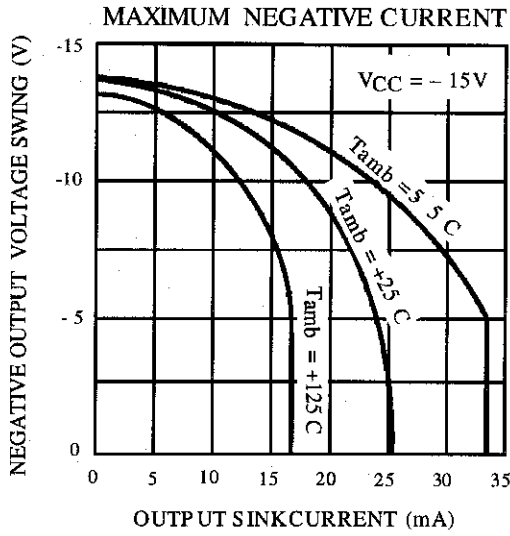

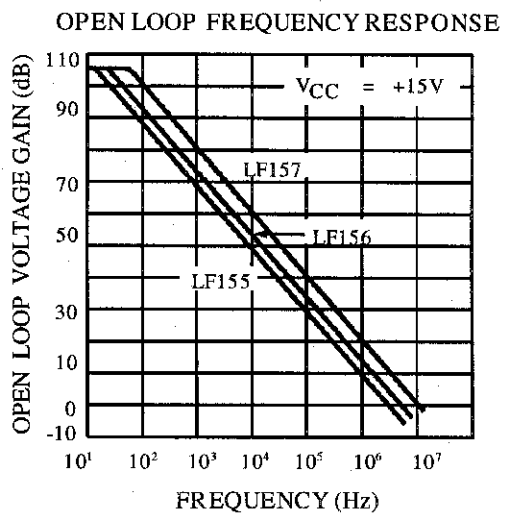
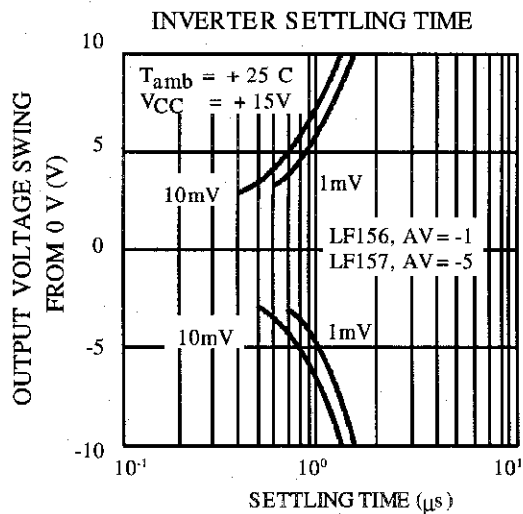
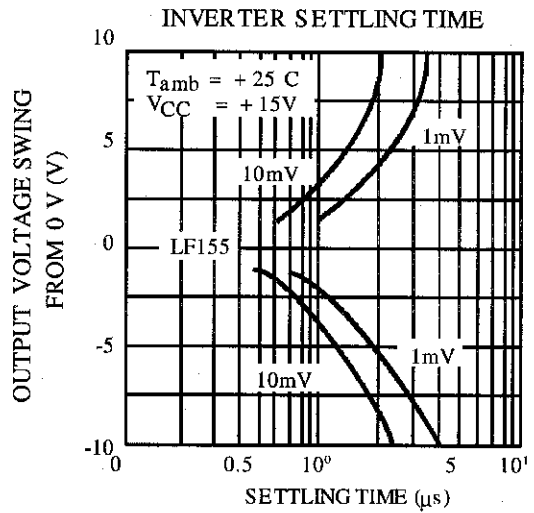
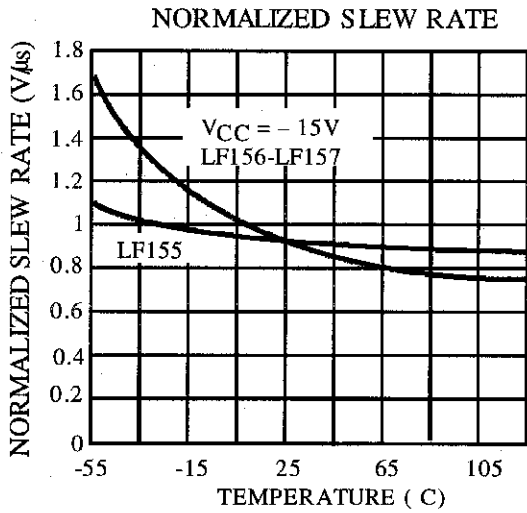
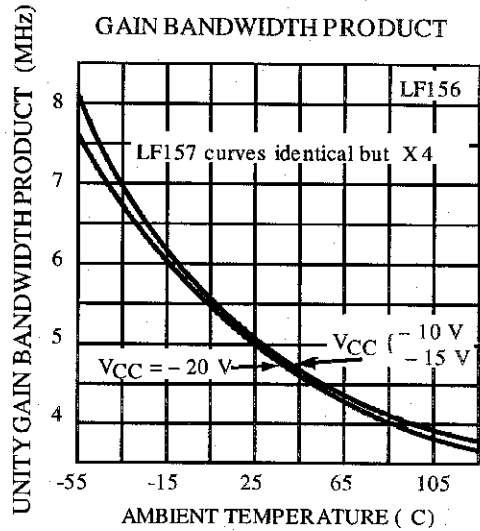
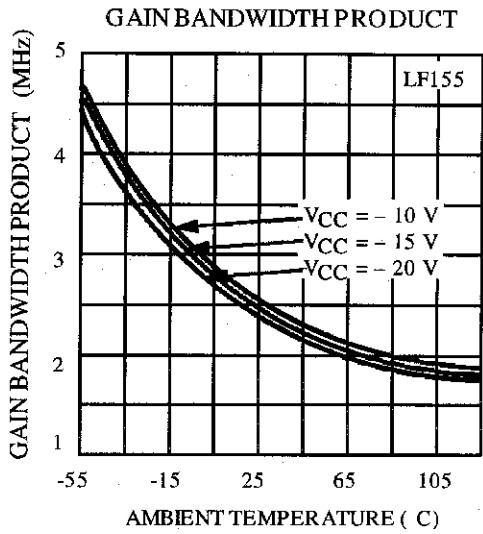

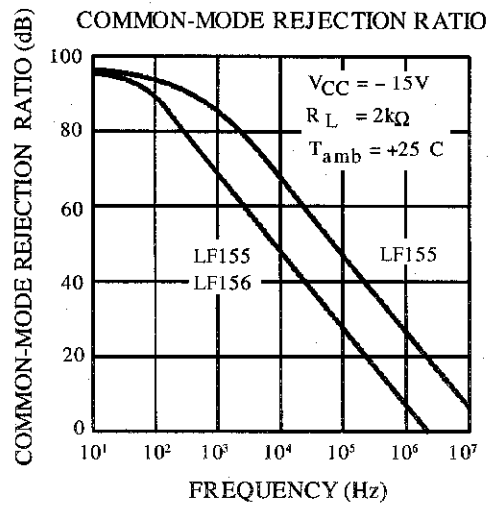
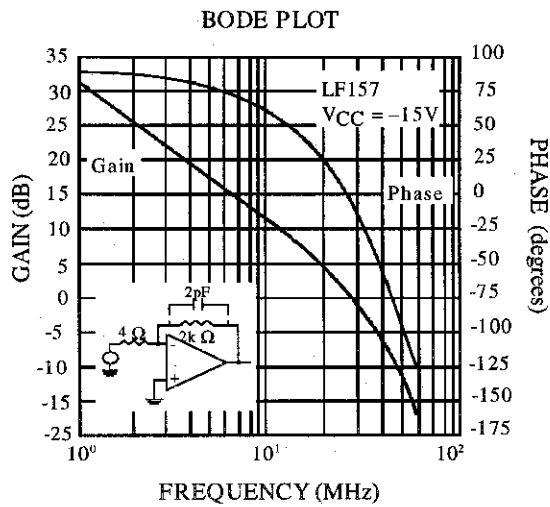
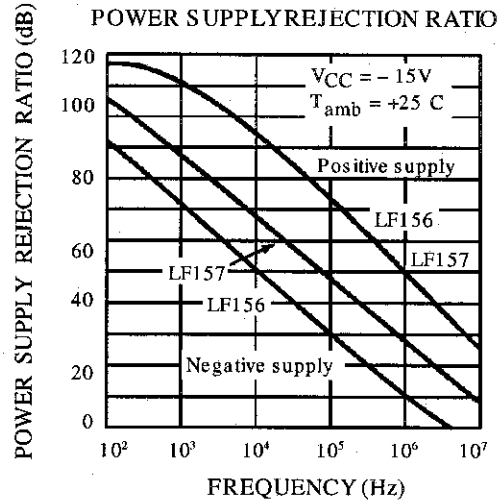
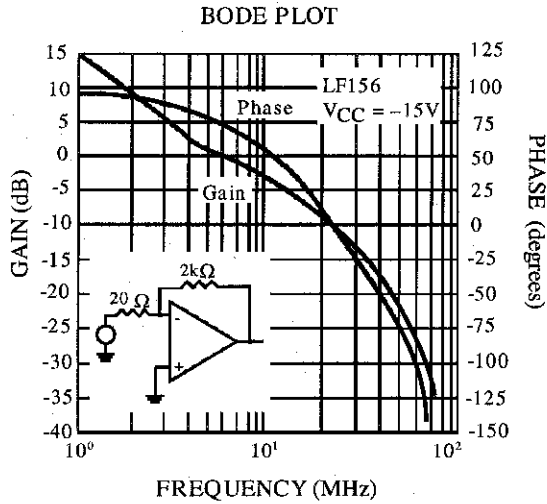
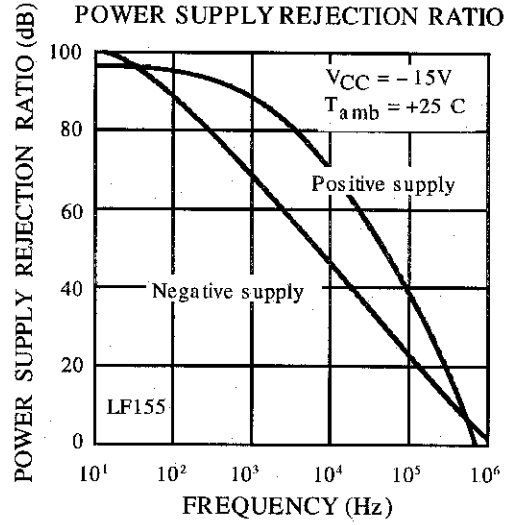
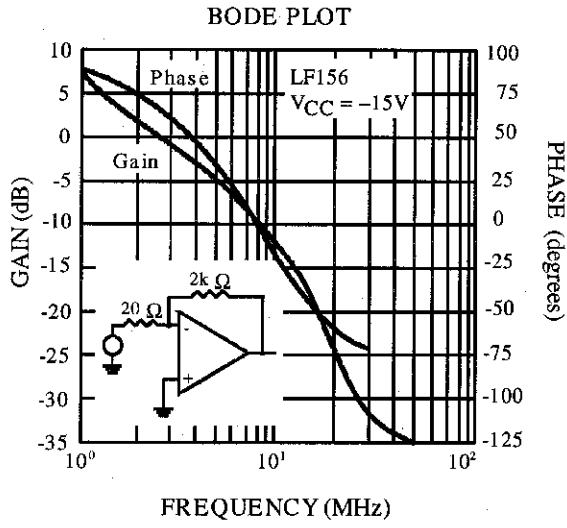

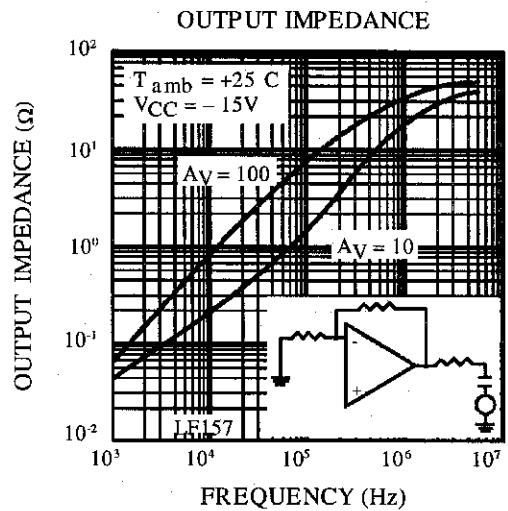
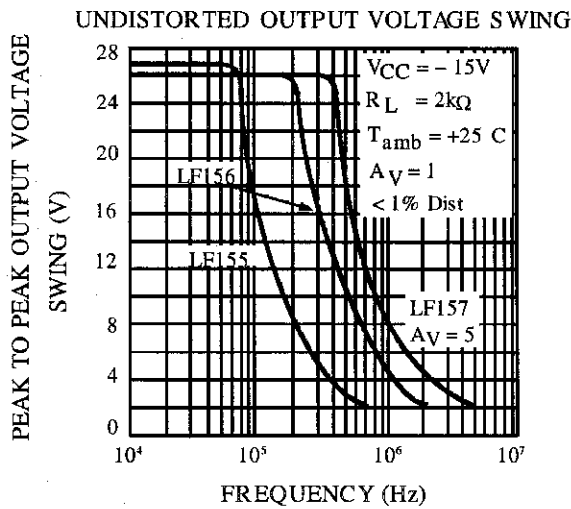
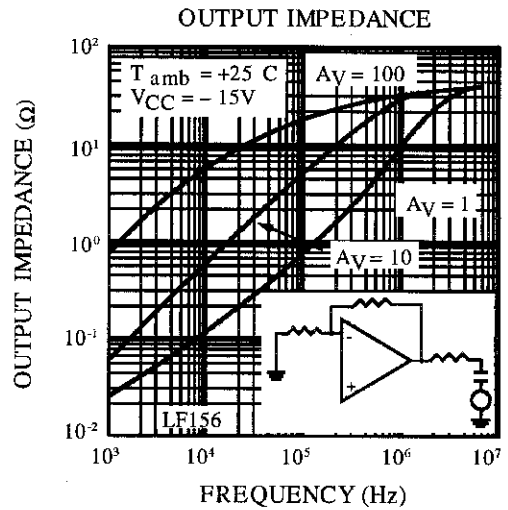
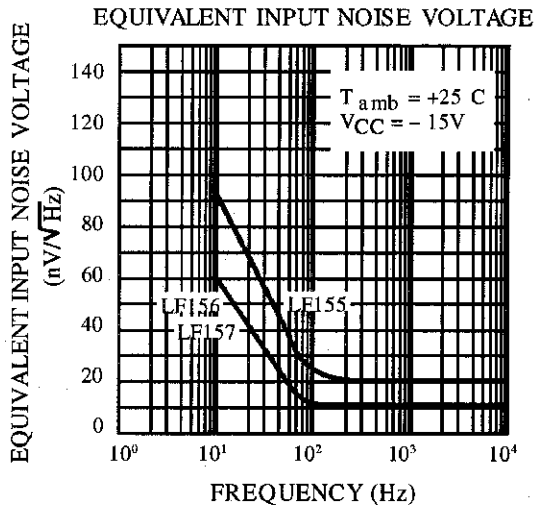
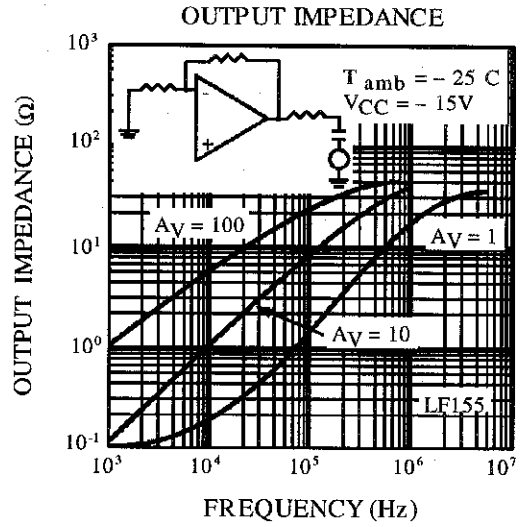
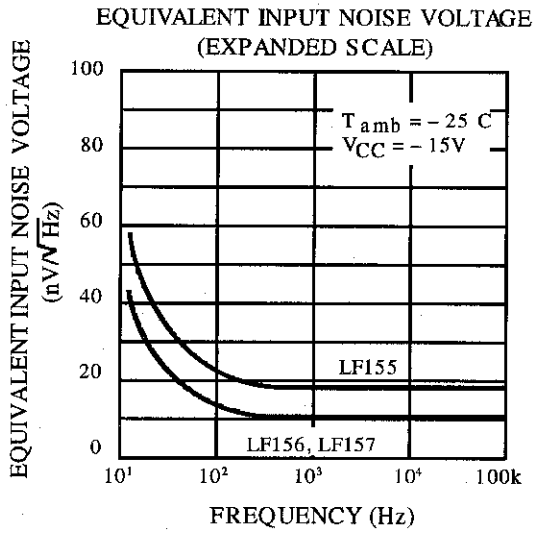

**PACKAGE MECHANICAL DATA**  
8 PINS - PLASTIC DIP

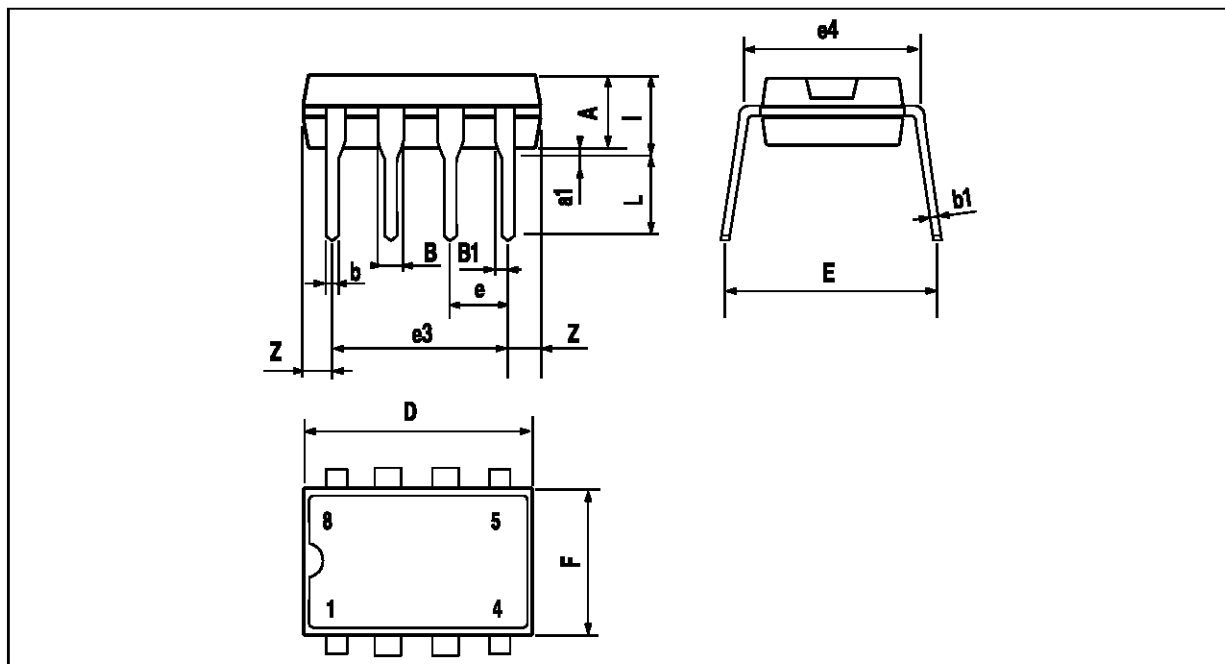

PM-DIP8.EPS

Dimensions	Millimeters			Inches		
	Min.	Typ.	Max.	Min.	Typ.	Max.
A		3.32			0.131	
a1	0.51			0.020		
B	1.15		1.65	0.045		0.065
b	0.356		0.55	0.014		0.022
b1	0.204		0.304	0.008		0.012
D			10.92			0.430
E	7.95		9.75	0.313		0.384
e		2.54			0.100	
e3		7.62			0.300	
e4		7.62			0.300	
F			6.6			0.260
i			5.08			0.200
L	3.18		3.81	0.125		0.150
Z			1.52			0.060

DIP8.TBL

**PACKAGE MECHANICAL DATA**  
8 PINS - PLASTIC MICROPACKAGE (SO)

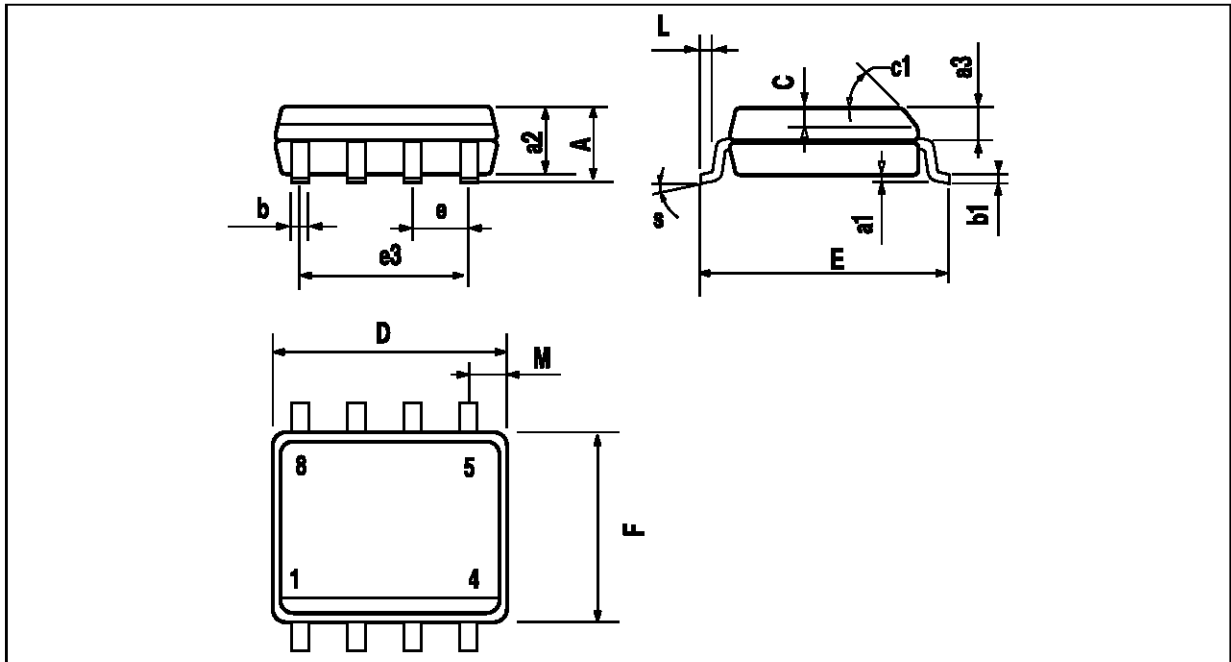

PM-S08.EPS

Dimensions	Millimeters			Inches		
	Min.	Typ.	Max.	Min.	Typ.	Max.
A			1.75			0.069
a1	0.1		0.25	0.004		0.010
a2			1.65			0.065
a3	0.65		0.85	0.026		0.033
b	0.35		0.48	0.014		0.019
b1	0.19		0.25	0.007		0.010
C	0.25		0.5	0.010		0.020
c1	45° (typ.)					
D	4.8		5.0	0.189		0.197
E	5.8		6.2	0.228		0.244
e		1.27			0.050	
e3		3.81			0.150	
F	3.8		4.0	0.150		0.157
L	0.4		1.27	0.016		0.050
M			0.6			0.024
S	8° (max.)					

S08.TBL

Information furnished is believed to be accurate and reliable. However, SGS-THOMSON Microelectronics assumes no responsibility for the consequences of use of such information nor for any infringement of patents or other rights of third parties which may result from its use. No license is granted by implication or otherwise under any patent or patent rights of SGS-THOMSON Microelectronics. Specifications mentioned in this publication are subject to change without notice. This publication supersedes and replaces all information previously supplied. SGS-THOMSON Microelectronics products are not authorized for use as critical components in life support devices or systems without express written approval of SGS-THOMSON Microelectronics.

© 1997 SGS-THOMSON Microelectronics – Printed in Italy – All Rights Reserved

SGS-THOMSON Microelectronics GROUP OF COMPANIES  
Australia - Brazil - Canada - China - France - Germany - Hong Kong - Italy - Japan - Korea - Malaysia - Malta - Morocco  
The Netherlands - Singapore - Spain - Sweden - Switzerland - Taiwan - Thailand - United Kingdom - U.S.A.

ORDER CODE :